



**Protocol and Liaison Service - DGACM**

**BRIEFING**

**Thursday, 24 August 2023 (3 pm)**

**High-level events during  
the seventy-eighth session of the General Assembly**



# Registration of Official Delegations

- ❖ All registration requests must be made via the online system “**eRegistration**” that is available through the e-deleGATE Portal at <https://edelegate.un.int>.

The screenshot displays the e-deleGATE portal interface. At the top, there is a navigation bar with the following items: 'What's New', 'General Assembly', 'Security Council', 'ECOSOC', 'Conference', 'Protocol', 'Resources', and 'Secretariat'. Below this is a 'Personal Profile' section with four tabs: 'MY CONTACT INFO', 'MY PREFERENCES', 'MY MODULES', and 'MY ACCESS ADMINISTRATORS'. A dropdown menu is open under the 'Protocol' tab, showing the following options: 'Protocol and Liaison Service', 'e-Mission registration of personnel', 'Registration to meetings and conferences' (highlighted with a red arrow), and 'Reservation for courtesy tickets for the general debate'.

- ❖ There is no need to register diplomats/staff of the missions/offices in New York, who are already in possession of a UN grounds pass.
- ❖ One registration for all high-level meetings/events including the general debate between **18-26 September 2023**.
- ❖ The deadline for submission of registration is **Friday, 8 September 2023**.



## Registration of Official Delegations (cont'd)

- ❖ Guidelines on how to submit requests online and a set of “Frequently Asked Questions” can be found on the Protocol website at <https://www.un.org/dgacm/en/content/protocol>.

The screenshot shows the website interface for the United Nations Department for General Assembly and Conference Management. The URL in the browser is <https://www.un.org/dgacm/en/content/protocol#>. The page features the United Nations logo and the text 'United Nations | Department for General Assembly and Conference Management'. A search bar is located on the right. The main navigation menu includes 'Home', 'Who we are', 'What we do', 'Language careers', and 'News and media'. Under 'News and media', the 'Protocol and Liaison Service' link is highlighted with a red arrow. Other links in the menu include 'Accessibility', 'Committee on Conferences', 'Documents management', 'Gender equality', 'Innovation', 'Intergovernmental services', 'Language services', 'Meetings management', 'Monitoring and evaluation', and 'Partnerships'.

- ❖ It is not necessary to register delegates as virtual participants in order to follow the general debate and other high-level meetings online, which are available at [webtv.un.org](http://webtv.un.org).
- ❖ Missions/Offices are strongly encouraged to submit **photographs** of delegations along with their online registration requests in order to avoid long queues at the Pass and I.D. office.



## Registration of Official Delegations (cont'd)

- ❖ All registration requests require **at least 2 to 3 business days** for processing. **Again, the deadline for online registration is Friday, 8 September 2023.**
- ❖ **VVIP and VIP Passes** are issued by UN Protocol and may be collected at the same time as the distribution of the access cards on 14 September 2023, and thereafter, in the Protocol Office in Room S-0200 during office hours.
- ❖ **VVIP Passes** (without photo) will be issued to Heads of State/Government, Vice-Presidents and Crown Princes/Princesses, and their spouses.
- ❖ **VIP Passes** (with photo) will be issued to Deputy Prime Ministers, Cabinet Ministers and Speakers of Parliaments, and their spouses.



**VVIP Pass without photo**







**VIP Pass with photo**



# Secondary access passes & floaters

- ❖ For access to restricted areas, everyone needs **a secondary access card OR a meeting-specific ticket** in addition to **a valid UN grounds pass.**
- ❖ There will be different types of color-coded access cards and special tickets as follows:

## Types of secondary access cards

	<b>Gold</b> Access to all areas (Including GA hall)
	<b>Blue floater</b> Access to the third, second, ground floor and the first basement
	<b>Orange floater</b> Access to parts of the third floor and parts of the first basement
	<b>Special ticket</b> Access to conference room (event and date specific)



For access to all areas, including GA hall



For access to 3<sup>rd</sup>, 2<sup>nd</sup>, ground floor & 1<sup>st</sup> basement of the GA & Conference Buildings



For access to parts of the 3<sup>rd</sup> floor and the 1<sup>st</sup> basement of the GA & Conference Buildings



## Secondary access passes & floaters (cont'd)

- ▶ Bearing in mind space constraints, as well as security considerations, passes will be issued as follows:

### GENERAL DEBATE (19-26 Sept 2023)

- ▶ Access to the General Assembly Hall and “all restricted areas” on the third floor, second floor, ground floor and first basement of the GA and Conference Buildings for the general debate from 19 to 26 September 2023

For each member state:

- 6 gold cards, 4 blue floaters and 2 orange floaters

For each GA-accredited IGO:

- 2 gold cards, 2 blue floaters and 2 orange floaters

For each specialized agency and related organization:

- 1 gold card, 2 blue floaters and 2 orange floaters



For access to all areas, including GA hall



For access to 3<sup>rd</sup>, 2<sup>nd</sup>, ground floor & 1<sup>st</sup> basement of the GA & Conference Buildings



For access to parts of the 3<sup>rd</sup> floor and the 1<sup>st</sup> basement of the GA & Conference Buildings



# Meeting-specific tickets

## SDG SUMMIT (18-19 Sept 2023)

- ▶ Access to the General Assembly Hall and other conference rooms for the SDG Summit on 18 and 19 September 2023

### For each member state:

- **6 tickets** for the opening meeting in the **GA Hall** and all areas of the **GA and Conference Buildings** for **18 September**
- **2 tickets** for the Leaders Dialogues in the **Trusteeship Council Chamber** for **18 September (after 10:30 am)**
- **2 tickets** for the Leaders Dialogues and the closing meeting in the **Trusteeship Council Chamber** for **19 September (afternoon)**

### For each IGO:

- **2 tickets** for the opening meeting in the **GA Hall** and all areas of the **GA and Conference Buildings** for **18 September**
- **1 ticket** for the Leaders Dialogues in the **Trusteeship Council Chamber** for **18 September (after 10:30 am)**
- **1 ticket** for the Leaders Dialogues and the closing meeting in the **Trusteeship Council Chamber** for **19 September (afternoon)**

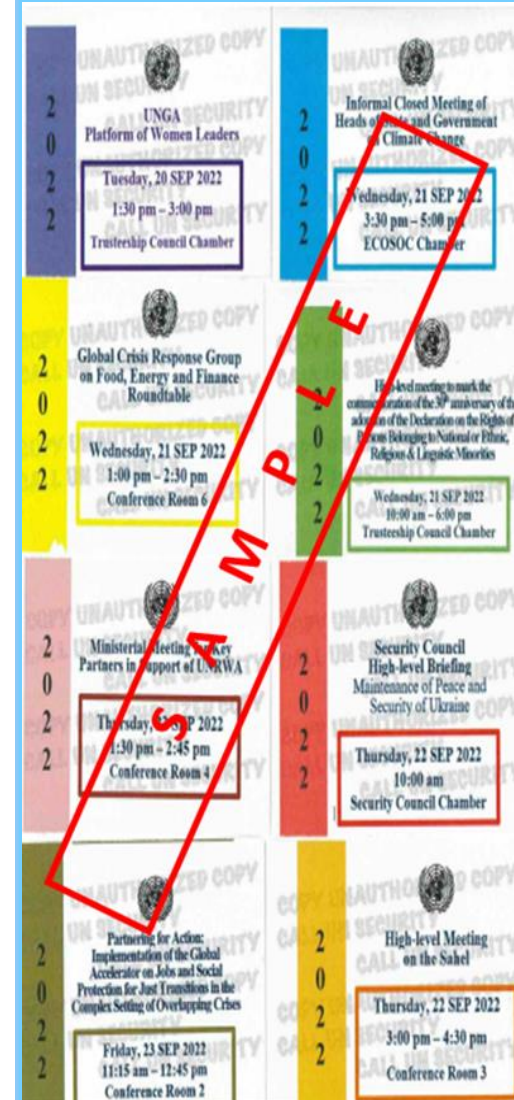

Meeting specific tickets



## Meeting-specific tickets (cont'd)

### For each specialized agency and related organization:

- **1 ticket** for the opening meeting in the **GA Hall** and all areas of the **GA and Conference Buildings** for **18 September**
- **1 ticket** for the Leaders Dialogues in the **Trusteeship Council Chamber** for **18 September (after 10:30 am)**
- **1 ticket** for the Leaders Dialogues and the closing meeting in the **Trusteeship Council Chamber** for **19 September (afternoon)**

❖ For **most high-level meetings** taking place from 18 to 26 September 2023, **meeting-specific tickets** for access to various conference rooms will be issued to representatives of Member and Observer States, GA-accredited IGOs, specialized agencies and related organizations participating in these meetings. **These tickets will allow access to the conference room on the date and time stated on the ticket for the specific meetings.** The meeting room can be accessed via the restricted areas of the General Assembly and Conference Buildings on the date and time of the respective meeting. Additional details will be made available in due course.

❖ **Secondary access cards and meeting-specific tickets** will be distributed by the Protocol Office on **Thursday, 14 September 2023 between 2:00 pm to 6:00 pm in Conference Room “A” in the 1<sup>st</sup> basement.** Thereafter, access cards may be collected in the Protocol Office in Room S-0200 during office hours.





## Reservation for guests of delegations

- ❖ During the address of the heads of delegations at the plenary meeting of the general debate, seats will be reserved in a **VIP Section B** for spouses of the Heads of State or Government, Vice-Presidents and Crown Princes or Princesses.
- ❖ In addition, a maximum of **8 seats** (on a rotation basis) may be reserved for guests of delegations in **VIP Section A**.





## Reservation for guests of delegations (cont'd)

- ❖ A limited number of seats in the Balcony on the 4<sup>th</sup> floor of the GA Hall will also be available for reservation for guests of delegations. Special courtesy tickets for these areas are required. Missions may submit their reservations by using an **online SG.40 form** (Reservation for courtesy tickets) under the “**Protocol**” dropdown menu (**4th tab – Reservation for courtesy tickets for the general debate**) in the eDelegate portal (<https://edelegate.un.int/portal/protocol/tickets>). Reservation will open on **5 September 2023**.



The screenshot shows the e-deleGATE portal interface. At the top, there is a navigation bar with dropdown menus for 'What's New', 'General Assembly', 'Security Council', 'ECOSOC', 'Conference', 'Protocol', 'Resources', and 'Secretari'. Below this is a 'Personal Profile' section with tabs for 'MY CONTACT INFO', 'MY PREFERENCES', 'MY MODULES', and 'MY ACCESS ADMINISTRATORS'. The 'Name' field is filled with 'Wai-Tak' and 'Chua'. A red arrow points to the 'Protocol' dropdown menu, which is open and shows several options: 'Protocol and Liaison Service', 'e-Mission registration of personnel', 'Registration to meetings and conferences', and 'Reservation for courtesy tickets for the general debate'. The last option is highlighted.



# Welcome by the Secretary-General

- ◆ Heads of State or Government, Vice-Presidents and Crown Princes or Princesses participating in the seventy-eighth session of the General Assembly will be welcomed by the Secretary-General, **from 8 a.m. to 8.30 a.m. on Tuesday, 19 September 2023**, in the **ECOSOC Chamber** on the second floor of the General Assembly Building. Light refreshments will be served in the **North Delegates' Lounge**.

## Flow of Movement:

- 1- HoD is welcomed by Protocol
- 2- Protocol *only* escorts HoD to ECOSOC Chamber
- 3- Rest of delegation waits in GA or in area in front of GA
- 4- HoD is welcomed by SG, DSG and CdC
- 5- HoD leaves ECOSOC Chamber to North Delegates Lounge for the reception of HoDs
- 6- HoDs proceed to GA Hall before the start of the meeting

## Layout of the General Assembly and ECOSOC Chamber and flow of movement for the reception of Heads of Delegation

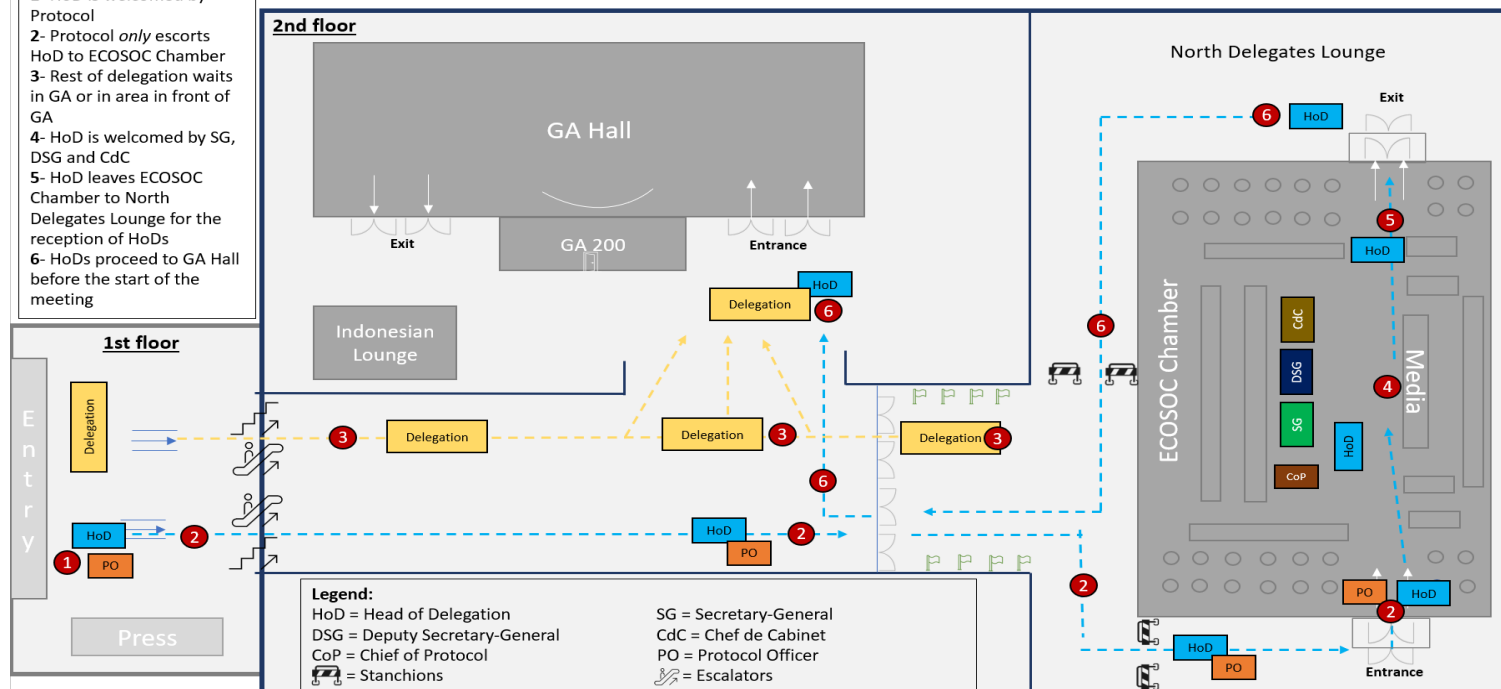



# Escort from GA-200 to Rostrum

During the general debate, there will be no ceremonial chair on the stage and no handshakes after the address.



Layout of the General Assembly and Flow of Movement for Speakers at the Rostrum

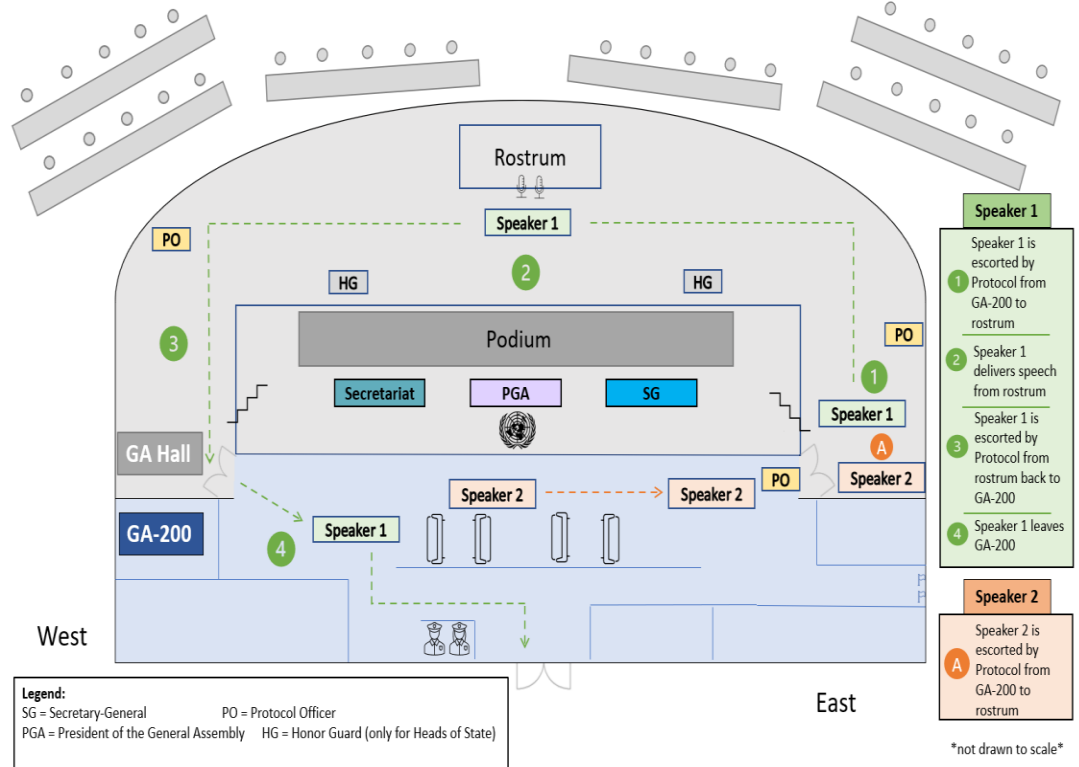



## State Luncheon

- ❖ There will be no state luncheon hosted by the Secretary-General during the general debate of the 78<sup>th</sup> session of the General Assembly.





## Additional Information

- ❖ All information material on the seventy-eighth session of the General Assembly issued by the Protocol and Liaison Service may be accessed at its website (<https://www.un.org/dgacm/en/content/protocol>).
- ❖ A **walk-through package** has been shared with the registration focal points of the missions/offices on 17 August 2023.
- ❖ The **Protocol Office, UN Security, MALU and GAEAD** will host an “**OPEN HOUSE – Q&A session**” on **Tuesday, 29 August 2023 from 2 pm to 4 pm in Conference Room F**. The Open House will mainly focus on issues relating to **registration and access/access passes**, as well as **other issues relating to the High-level meetings**. There is no need to make a reservation, just walk in.



## Additional Information (cont'd)

### ➤ **Bilateral booths will be in 3 locations**

- ❑ The total number of bilateral booths is **28**
  - ❑ 2 booths on the 2nd Floor Balcony
  - ❑ 4 booths on the 3rd Floor Balcony
  - ❑ 22 booths in the General Assembly Lobby
- ❑ Reservations should be made through **gMeets** by accessing **<https://conferences.unite.un.org/gMeets>** starting 1 September 2022



**Thank you**