

# ARISTA

## Quick Start Guide

**7100 Series 1 RU (Gen 3)  
Data Center Switches**

**Arista Networks**

[www.arista.com](http://www.arista.com)

PDOC-00143-01

<b>Headquarters</b>	<b>Support</b>	<b>Sales</b>
5453 Great America Parkway Santa Clara, CA 95054 USA		
+1 408 547-5500	+1 408 547-5502 +1 866 476-0000	+1 408 547-5501 +1 866 497-0000
<a href="http://www.arista.com">www.arista.com</a>	<a href="mailto:support@arista.com">support@arista.com</a>	<a href="mailto:sales@arista.com">sales@arista.com</a>

© Copyright 2018 Arista Networks, Inc. The information contained herein is subject to change without notice. Arista Networks and the Arista logo are trademarks of Arista Networks, Inc in the United States and other countries. Other product or service names may be trademarks or service marks of others.

# Table of Contents

<b>Chapter 1 Overview</b>	<b>1</b>
1.1 Scope	1
1.2 Receiving and Inspecting the Equipment	1
1.3 Installation Process	1
1.4 Safety Information	2
1.5 Obtaining Technical Assistance	2
1.6 Specifications	3
<b>Chapter 2 Preparation</b>	<b>5</b>
2.1 Site Selection	5
2.2 Tools and Parts Required for Installation	6
2.3 Electrostatic Discharge (ESD) Precautions	7
<b>Chapter 3 Rack Mounting the Switch</b>	<b>9</b>
3.1 Two-Post Rack Mount	9
3.1.1 Attaching Mounting Brackets to the Chassis	10
3.1.2 Inserting the Switch into the Rack	11
3.2 Four-Post Rack Mount	12
3.2.1 Attaching Mounting Brackets to the Chassis	13
3.2.2 Assembling the Rails onto the Equipment Rack	14
3.2.3 Attaching the Switch to the Rack	16
<b>Chapter 4 Cabling the Switch</b>	<b>17</b>
4.1 Grounding the Switch	17
4.2 Connecting Power Cables	18
4.2.1 AC Power Supplies	18
4.2.2 DC Power Supplies	19
4.2.3 PWR-1900-DC Power Supply	20
4.2.4 PWR-500-DC Power Supply	21
4.3 Connecting Serial and Management Cables	23
<b>Chapter 5 Configuring the Switch</b>	<b>25</b>
<b>Appendix A Status Indicators</b>	<b>27</b>
A.1 Front Indicators	27
A.1.1 Switch Indicators	27

A.1.2	Port Indicators .....	28
A.2	Rear Status Indicators .....	29
<b>Appendix B</b>	<b>Parts List.....</b>	<b>31</b>
B.1	Rack Mount Parts .....	31
B.1.1	Four-Post Rack Mount Parts.....	31
B.1.2	Two-Post Rack Mount Parts .....	31
B.2	Cables.....	32
<b>Appendix C</b>	<b>Front Panel .....</b>	<b>33</b>
<b>Appendix D</b>	<b>Rear Panel .....</b>	<b>35</b>
<b>Appendix E</b>	<b>Maintenance and Field Replacement .....</b>	<b>37</b>
E.1	Considerations .....	37
E.2	Power Supplies .....	37
E.2.1	Removing a Power Supply.....	37
E.2.2	Installing a Power Supply.....	38
E.3	Fan Modules .....	39
E.3.1	Removing a Fan Module.....	39
E.3.2	Installing a Fan Module.....	40
<b>Appendix F</b>	<b>Regulatory Model Numbers .....</b>	<b>43</b>
<b>Appendix G</b>	<b>Taiwan RoHS Information .....</b>	<b>45</b>

## Overview

---

### 1.1 Scope

This guide is intended for properly trained service personnel and technicians who need to install the following Arista Networks Data Center Switches:

DCS-7160-32CQ      DCS-7160-48YC6      DCS-7160-48TC6      DCS-7170-32C  
DCS-7170-32CD

---

**Important!** Only qualified personnel should install, service, or replace this equipment.

Seul le personnel qualifié doit installer, service, ou remplacer cet équipement.

---

### 1.2 Receiving and Inspecting the Equipment

Upon receiving the switch, inspect the shipping boxes and record any external damage. Retain packing materials if you suspect that part of the shipment is damaged; the carrier may need to inspect them.

If the boxes were not damaged in transit, unpack them carefully. Ensure that you do not discard any accessories that may be packaged in the same box as the main unit.

Inspect the packing list and confirm that you received all listed items. Compare the packing list with your purchase order. [Appendix B](#) provides a list of components included with the switch.

### 1.3 Installation Process

The following tasks are required to install and use the switch:

**Step 1** Select and prepare the installation site ([Section 2.1](#)).

**Step 2** Assemble the installation tools listed in [Section 2.2](#).

**Step 3** Attach the mounting brackets and install the switch in an equipment rack ([Chapter 3](#)).

**Step 4** Connect the switch to the power source and network devices ([Chapter 4](#)).

**Step 5** Configure the switch ([Chapter 5](#)).

---

**Important!** Class 1 Laser Product: This product has provisions to install Class 1 laser transceivers which provide optical coupling to the communication network. Once a Class 1 laser product is installed, the equipment is a Class 1 Laser Product (Appareil à Laser de Classe 1). The customer is responsible for selecting and installing the Class 1 laser transceiver and for insuring that the Class 1 AEL (Allowable Emission Limit) per EN/IEC 60825, CSA E60825-1, and Code of Federal Regulations 21 CFR 1040 is not exceeded after the laser transceiver have been installed. Do not install laser products whose class rating is greater than 1. Refer to all safety instructions that accompanied the transceiver prior to installation. Only Class 1 laser devices, certified for use in the country of installation by the cognizant agency are to be utilized in this product.

Produit Laser de classe 1: Ce produit a des dispositions pour installer des émetteurs-récepteurs de laser de classe 1 qui offre de couplage au réseau de communication optique. Une fois un produit laser de classe 1 est installé, l'équipement est un produit Laser de classe 1 (Appareil à Laser de Classe 1). Le client est responsable pour sélectionner et installer l'émetteur/récepteur de laser de classe 1 et pour assurer que la classe 1 AEL (limite d'émission admissible) par EN/IEC 6-825, CSA E60825-1, et Code des règlements fédéraux 21 CFR 1040 ne soit pas dépassée après avoir installé l'émetteur/récepteur de laser. Ne pas installer des appareils à laser dont la cote de classe est supérieure à 1. Voir toutes les consignes de sécurité qui ont accompagné l'émetteur-récepteur avant l'installation. Seuls appareils laser de classe 1 certifiés pour une utilisation dans le pays d'installation par l'organisme compétent doivent être utilisées dans ce produit. Ultimate disposal of this product should be in accordance with all applicable laws and regulations.

---

**Important!** Ultimate disposal of this product should be handled in accordance with all national laws and regulations.

Aucune pièce réparable par l'utilisateur à l'intérieur. Confiez toute réparation à un technicien qualifié.

---

## 1.4 Safety Information

Refer to the Arista Networks document Safety Information and Translated Safety Warnings available at:

[www.arista.com/support/docs/eos](http://www.arista.com/support/docs/eos)

## 1.5 Obtaining Technical Assistance

Any customer, partner, reseller or distributor holding a valid Arista Service Contract can obtain technical support in any of the following ways:

- **Email:** support@arista.com. This is the easiest way to create a new service request. Include a detailed description of the problem and the output of “show tech-support”.
- **Web:** [www.arista.com/support](http://www.arista.com/support).  
A support case may be created through the support portal on our website. You may also download the most current software and documentation, as well as view FAQs, Knowledge Base articles, Security Advisories, and Field Notices.
- **Phone:** +1 866-476-0000 or +1 408-547-5502.

---

**Important!** No user serviceable parts inside. Refer all servicing to qualified service personnel.

Aucune pièce réparable par l'utilisateur à l'intérieur. Confiez toute réparation à un technicien qualifié.

---

## 1.6 Specifications

**Table 1-1 Switch Specifications (Dimensions and Weights)**

Switch	Size (W x H x D)	Weight
DCS-7160-32CQ	48.3 x 4.4 x 40.6 cm (19 x 1.75 x 16 inches)	8.7 kg (19.2 lbs.)
DCS-7160-48YC6	48.3 x 4.4 x 40.6 cm (19 x 1.75 x 16 inches)	8.7 kg (19.2 lbs.)
DCS-7160-48TC6	48.3 x 4.4 x 40.6 cm (19 x 1.75 x 16 inches)	9.3 kg (20.4 lbs.)
DCS-7170-32C	48.3 x 4.4 x 40.6 cm (19 x 1.75 x 16 inches)	10.0 kg (22.0 lbs.)
DCS-7170-32CD	48.3 x 4.4 x 40.6 cm (19 x 1.75 x 16 inches)	10.0 kg (22.0 lbs.)

**Table 1-2 Switch Specifications (Operational and Storage)**

Switch	Operating Temperature	Storage Temperature	Operating Altitude	Relative Humidity
All	0° to 40°C (32° to 104°F)	-25° to 70°C (-13° to 158° F)	0 to 3,000 meters (0 to 10,000 feet)	5 to 90% (non-condensing)

**Table 1-3 Switch Specifications (Power Input)**

Power Source	PSU Models	Ratings
Power Input (AC Power)	PWR-500-AC PWR-747-AC	100 - 240 VAC, 6.5 to 3.0 A, 50/60 Hz 100 - 240 VAC, 10.0 to 5.0 A, 50/60 Hz
Power Input (DC Power)	PWR-500-DC PWR-1900-DC	-48 to -60 VDC, 15 A -48 to -60 VDC, 32 A

**Note**

All PSU models are not supported by all switches. Some switches described in this guide could use power supplies that may no longer be available. Contact your local Arista representative for more information.

**Table 1-4 Switch Specifications (Power Draw)**

Switch	Power Draw (Typical / Maximum)	Supported Power Supply
DCS-7160-32CQ	311 W / 466 W	PWR-500-AC, PWR-500-DC
DCS-7160-48YC6	168 W / 382 W	PWR-500-AC, PWR-500-DC
DCS-7160-48TC6	400 W / 500 W	PWR-500-AC, PWR-500-DC
DCS-7170-32C	221 W / 490 W	PWR-747-AC, PWR-1900-DC
DCS-7170-32CD	221 W / 415 W	PWR-747-AC, PWR-1900-DC

**Note**

RJ-45 to DB-9 connections: Models with management ports on the rear panel short RJ-45 pin 1 (RTS) to RJ-45 pin 8 (CTS). RJ-45 pins 2 (DTR) and RJ-45 pin 7 (DSR) are not electrically connected to anything.

---



## Preparation

---

### 2.1 Site Selection

The following criteria should be considered when selecting a site to install the switch:

- **Temperature and Ventilation:** For proper ventilation, install the switch where there is ample airflow to the front and back of the switch. The ambient temperature should not go below 0° or exceed 40°C.

---

**Important!** To prevent the switch from overheating, do not operate it in an area where the ambient temperature exceeds 40°C (104°F).

Pour empêcher l'interrupteur de surchauffe, ne pas utiliser il dans une zone où la température ambiante est supérieure à 40°C (104°F).

---

- **Airflow Orientation:** Determine airflow direction of the four fan modules and two power supply modules on the rear panel. Fan and power supply module handles indicate airflow direction:
  - **Blue Handle:** Air Inlet module (port-side exhaust).
  - **Red Handle:** Air Exit module (port-side intake).

Figure 2-1 on page 6 displays fan and power supply module locations on the rear panel. Their red handles indicate that they are air exit modules. Verify that each module has the same airflow direction. Base the switch orientation on the airflow direction of the modules to assure the air inlet is always oriented toward the cool aisle:

- **Air Exit modules:** orient the rear panel toward the hot aisle.
- **Air Inlet modules:** orient the rear panel toward the cool aisle.

If the airflow direction is not compatible with the installation site, contact your sales representative to obtain modules that circulate air in the opposite direction.

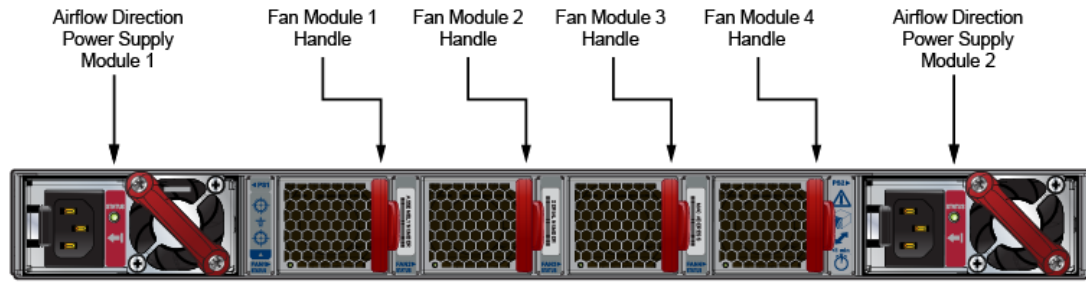
- **Rack Space:** Install the switch in a 19" rack or cabinet. The switch height is 1 RU. The accessory kit provides mounting brackets for two-post and four-post racks.

When mounting the switch in a partially filled rack, load the rack from bottom to top, with the heaviest equipment at the bottom. Load the switch at the bottom if it is the only item in the rack.

- **Power Requirements:** Power requirements vary by switch and power supply model. Refer to Table 1-3 on page 3 and Table 1-4 on page 3 for information regarding your specific system.

Two circuits provide redundancy protection. Section 4.1 describes power cable requirements.

Figure 2-1: Airflow Direction Labels



**Important!** The power input plug-socket combination must be accessible at all times; it provides the primary method of disconnecting power from the system.

La combinaison de la puissance-prise d'entrée doit être accessible en tout temps ; Il fournit le principal moyen de coupure d'alimentation du système.

- **Other Requirements:** Select a site where liquids or objects cannot fall onto the equipment and foreign objects are not drawn into the ventilation holes. Verify these guidelines are met:
  - Clearance areas to the front and rear panels allow for unrestricted cabling.
  - All front and rear panel indicators can be easily read.
  - Power cords can reach from the power outlet to the connector on the rear panel.

**Important!** All power connections must be removed to de-energize the unit.

Toutes les connexions d'alimentation doivent être enlevées pour hors tension l'appareil.

## 2.2 Tools and Parts Required for Installation

Each switch provides an accessory kit that contains parts that are required to install the switch. In addition to the accessory kit, the following tools and equipment are required to install the switch:

### Two-Post Rack

- Screws or rack mounting nuts and bolts.
- Screwdriver

### Four-Post Rack (Tool-less)

No additional equipment required.

### Four-Post Rack (Conventional)

- Screws or rack mounting nuts and bolts.
- Screwdriver

Accessory kit does not include screws for attaching the switch to the equipment rack. When installing the switch into an equipment rack with unthreaded post holes, nuts are also required to secure the switch to the rack posts.

## 2.3 Electrostatic Discharge (ESD) Precautions

Observe these guidelines to avoid ESD damage when installing or servicing the switch.

- Assemble or disassemble equipment only in a static-free work area.
- Use a conductive work surface (such as an anti-static mat) to dissipate static charge.
- Wear a conductive wrist strap to dissipate static charge accumulation.
- Minimize handling of assemblies and components.
- Keep replacement parts in their original static-free packaging.
- Remove all plastic, foam, vinyl, paper, and other static-generating materials from the work area.
- Use tools that do not create ESD.



## Rack Mounting the Switch

---

**Important!** The rack mounting procedure is identical for all switches covered by this guide. Illustrations in this chapter depict the mounting of a DCS-7050QX-32S switch.

Les procédure de montage du bâti est identique pour tous les commutateurs visés par ce guide. Illustrations dans ce chapitre montrent le montage d'un interrupteur de DCS-7050QX-32S.

---

- [Section 3.1](#) provides instructions for mounting the switch in a two-post rack.
- [Section 3.2](#) provides instructions for mounting the switch in a four-post rack.

After completing the instructions for your rack type, proceed to [Chapter 4](#).

### 3.1 Two-Post Rack Mount

To mount the switch onto a two-post rack, assemble the mounting brackets to the chassis, then attach the brackets to the rack posts. Two-post accessory kits include the following two-post mounting parts:

- 2 three-hole mounting brackets

Each chassis side has attachment pins that align with bracket holes. Pin orientation is symmetric and equidistant, supporting bracket placements where the flange is flush with the front switch panel, flush with the rear panel, or not flush with either panel. Each bracket hole includes a key-opening for placing the bracket flush with the chassis and then locking it into place.

---

**Important!** Attachment pins must engage all three upper bracket holes.

Goupilles de fixation doivent être bloquer tous les trois trous de la bride supérieure..

---

[Figure 3-1 on page 10](#) displays proper bracket mount configuration examples. [Figure 3-2 on page 10](#) displays improper bracket mount configuration examples.

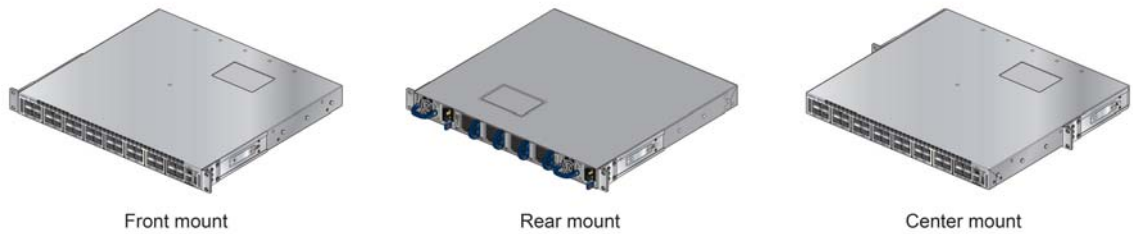
### 3.1.1 Attaching Mounting Brackets to the Chassis

This procedure attaches mounting brackets to the switch chassis (Figure 3-3).

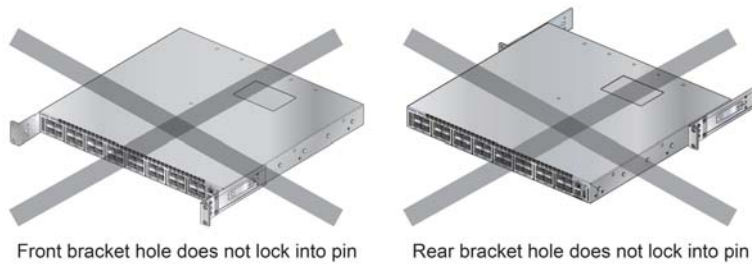
**Step 1** Align the mounting brackets with the attachment pins to obtain the desired mounting position.

**Step 2** Place the bracket flush on the chassis with attachment pins protruding through key-openings.

**Figure 3-1: Bracket Mount Examples for Two-Post Rack Mount**

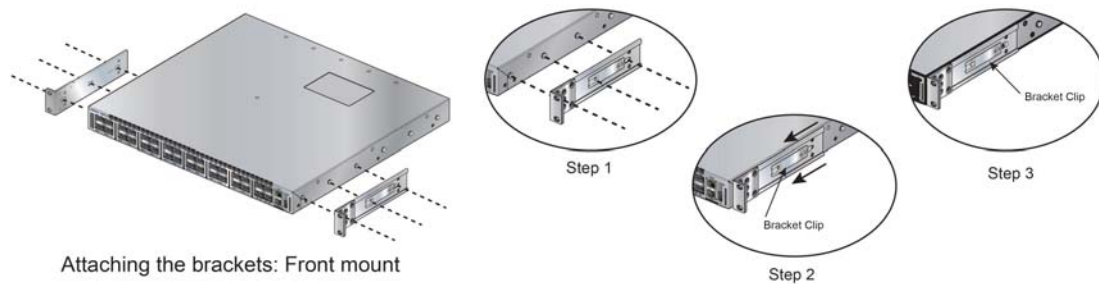


**Figure 3-2: Improper Bracket Mount Examples for Two-Post Rack Mount**



**Step 3** Slide the bracket toward the front flange until the bracket clip locks with an audible click.

**Figure 3-3: Attaching the Mounting Brackets to the Switch Chassis**



To remove the mounting bracket from the chassis, lift the front edge of the mounting bracket clip with a flathead screwdriver and slide the bracket away from the front flange (opposite from the installation direction).

### 3.1.2 Inserting the Switch into the Rack

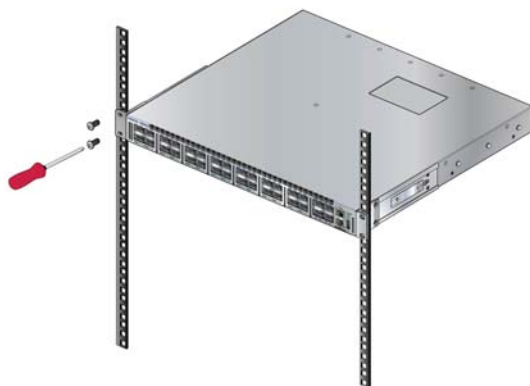
This procedure attaches the switch to the rack ([Figure 3-4](#)).

**Step 1** Lift the chassis into the rack. Position the flanges against the rack posts.

**Step 2** Select mounting screws that fit your equipment rack.

**Step 3** Attach the bracket flanges to the rack posts.

**Figure 3-4: Inserting the Switch into the Rack**



After completing the two-post rack mount, proceed to [Chapter 4](#).

## 3.2 Four-Post Rack Mount

The switch is mounted onto a four-post rack by assembling two rails onto the rear posts, sliding the switch onto the rails, then securing the switch to the front posts.

The installation kit provides the following four-post mounting parts:

- 2 six-hole mounting brackets
- 2 rail-rods
- 2 rail-slides

The rail-rods and rail-slides assemble into two identical slide-rails.

Each chassis side has attachment pins that align with bracket holes. Pin orientation is symmetric and equidistant, supporting bracket placements where the flange is flush with the front switch panel, flush with the rear panel, or not flush with either panel. Each bracket hole includes a key-opening for placing the bracket flush with the chassis and then locking it into place.

---

**Important!** Attachment pins must engage at least five of the six bracket holes.

Goupilles de fixation doivent être lock au moins cinq des trous du six support.

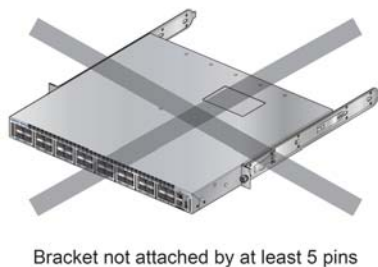
---

Figure 3-5 displays proper bracket mount configuration examples. Figure 3-6 displays an improper bracket mount configuration example.

**Figure 3-5: Bracket Mount Examples for Four-Post Rack Mount**



**Figure 3-6: Improper Bracket Mount Example for Four-Post Rack Mount**

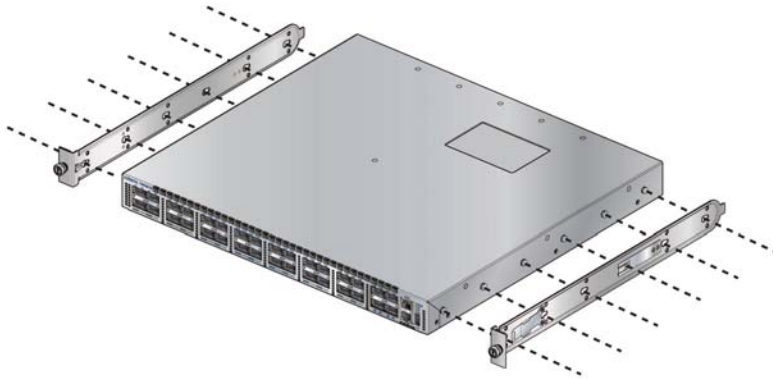




### 3.2.1 Attaching Mounting Brackets to the Chassis

Figure 3-7 displays the front bracket alignment for mounting the switch into a four-post rack.

Figure 3-7: Attaching the Mounting Brackets to the Switch Chassis



Attaching the brackets: Front mount

This procedure attaches mounting brackets to the switch chassis as depicted by Figure 3-7.

**Step 1** Align the mounting brackets with the attachment pins to obtain the desired mounting position.

**Step 2** Place the bracket flush on the chassis with attachment pins protruding through key-openings.

**Step 3** Slide the bracket toward the front flange until the bracket clip locks with an audible click.

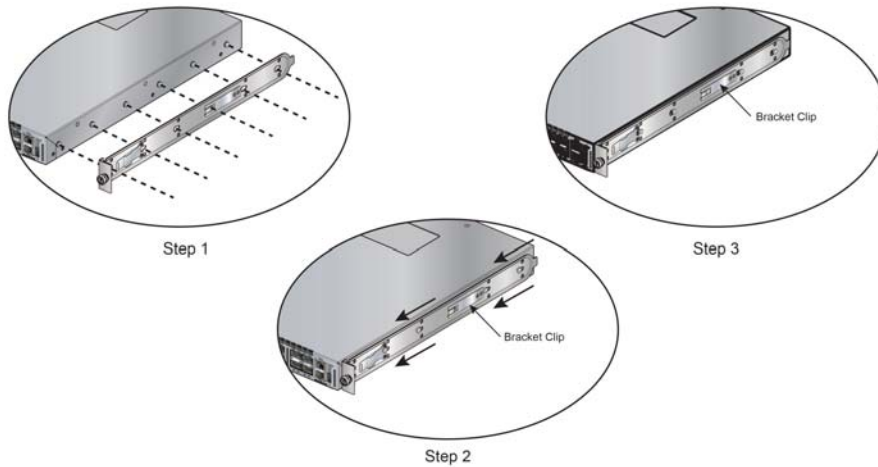
To remove the mounting bracket from the chassis, lift the front edge of the mounting bracket clip with a flathead screwdriver and slide the bracket away from the front flange (opposite from the installation direction).

### 3.2.2 Assembling the Rails onto the Equipment Rack

Rail-rods and rail-slides assemble into two identical rails. Each rail connects a front post to a rear post. When the rails are installed, the switch slides on the rails into the rack. Each bracket includes a screw that attaches the switch to the rail.

Each end of an assembled rail contains two rack plugs (Figure 3-8). The rails are installed into a rack by inserting the plugs into rack slots. When installing rails into posts with threaded or rounded holes, remove all plugs located on both sides of the assembled rails, then install the rails with bolts that fit the rack.

**Figure 3-8: Attaching the Mounting Brackets to the Switch Chassis**

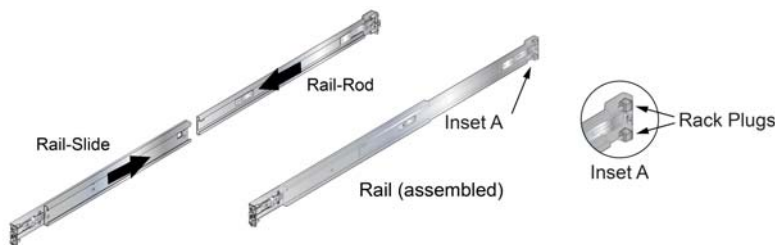


This procedure attaches the rails to a four post rack:

**Step 1** Slide a rail-rod into a rail-slide (Figure 3-9) until the rail clip makes an audible click.

The rail clip prevents the extension of the rail beyond the maximum supported distance between the front and rear rack posts.

**Figure 3-9: Assembling the Rails**



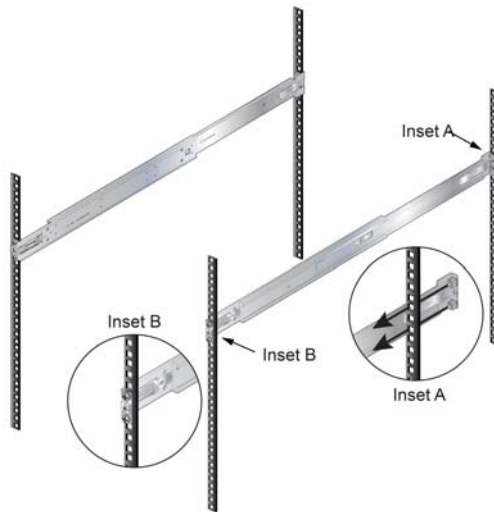
**Step 2** Attach rail to the right rear rack post by inserting rod-end rack plugs into post slots (Figure 3-10, Inset A). The slide assembly must be inside the right posts, relative to the left rack posts.

If the rack plugs were previously removed, use bolts to attach the rail to the rack.

**Step 3** Attach the slide end of the rail to the front post by extending the rail end past the post, then contracting the rail while guiding the rack plugs into the post (Figure 3-10, Inset B).

**Step 4** Repeat step 1 through step 3 for the left posts. Ensure the rails are on the same horizontal level.

**Figure 3-10: Attaching the Rails**

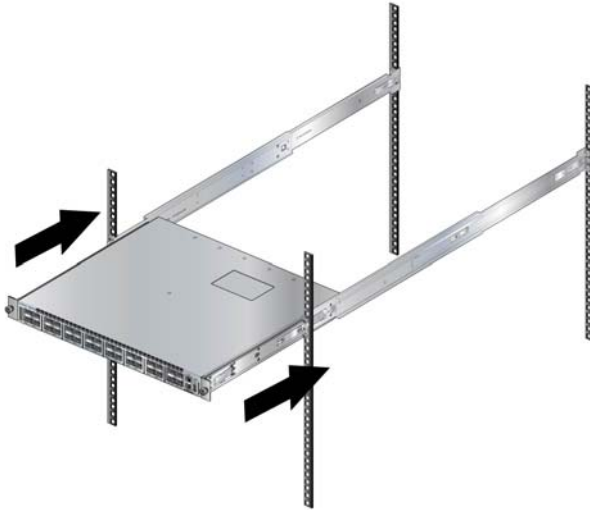


### 3.2.3 Attaching the Switch to the Rack

After the rails are installed, the switch slides on the rails into the rack. Each bracket includes a thumb screw that attaches the switch to the rail.

**Step 1** Lift the switch into the rack and insert the mounting brackets into the slide rails.

**Figure 3-11: Inserting the Switch onto the Rails**



**Step 2** Slide the switch on the rails, toward the rear posts, until the mounting bracket flanges are flush with the rail flanges attached to the rack posts.

**Step 3** Attach the bracket flanges to the rack post using the quick-release thumb screws supplied with the brackets ([Figure 3-12](#)).

**Figure 3-12: Attaching the Switch to the Rack Posts**



After completing the four-post rack mount, proceed to [Chapter 4](#).

## Cabling the Switch

### 4.1 Grounding the Switch

After mounting the switch into the rack, connect the switch to the data center ground. Figure 4-1 displays the location of the grounding pads located on the bottom corners of the rear panel for the models that have no management ports on the rear panel. Figure 4-2 displays the location of the grounding pads on the rear panel for models that have management ports on the rear panel. There are threaded holes under the sticker on the right (next to PS2) that warns about “1 min”.

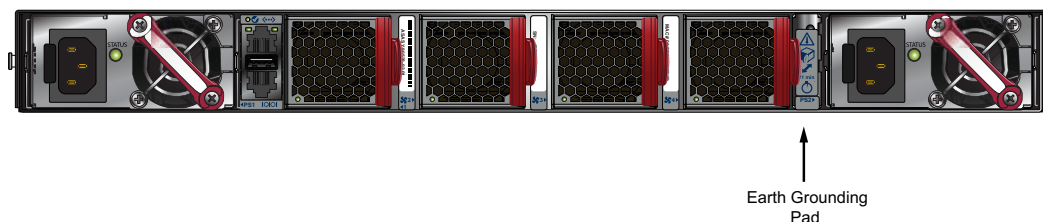
**Important!** Grounding wires and grounding lugs (M4 x 0.7) are not supplied. Wire size should meet local and national installation requirements. Commercially available 6 AWG wire is recommended for installations in the U.S

À la terre et de mise à la terre fils cosses (M4 x 0.7) ne sont pas fournis. Calibre des fils doit satisfaire des exigences de l’installation locale et nationale. Disponible dans le commerce 6 fils AWG est recommandé pour les installations aux États-Unis.

Figure 4-1: Earth Grounding Pad Sockets for Models without Management Ports on the Rear Panel



Figure 4-2: Earth Grounding Pad Sockets for Models with Management Ports on the Rear Panel



## 4.2 Connecting Power Cables

**Important!** Installation of this equipment must comply with local and national electrical codes. If necessary, consult with the appropriate regulatory agencies and inspection authorities to ensure compliance.

Installation de cet équipement doit être conformes aux codes électriques locaux et nationaux. Si nécessaire, consulter les organismes de réglementation appropriés et des autorités de contrôle pour assurer la conformité.

The switch operates with two installed power supplies. At least one power supply must connect to a power source. Two circuits provide redundancy protection. [Appendix D](#) displays the location of the power supplies on the rear panel of the switch.

**Important!** Read all installation instructions before connecting the system to the power source.

Lire toutes les instructions d'installation avant de brancher le système à la source d'alimentation.

- **Non-Redundant Configuration:** Connect power to either of the two power supplies.
- **Redundant Power Supply Configuration:** Connect power to both power supplies.
- **Power down the Switch:** Remove all power cords and wires from the power supplies.

**Important!** This equipment must be grounded. Never defeat the ground conductor.

Cet équipement doit être mis à la terre. Ne jamais modifier le conducteur de terre.

**Important!** This unit requires overcurrent protection.

Cet appareil requiert une protection contre les surintensités.

### 4.2.1 AC Power Supplies

The following AC power supplies are supported.

- PWR-500AC
- PWR-747AC

[Figure 4-3](#) displays an AC power supply, including the power socket on the left side of the module. The AC power supply connects to a circuit that provides the required power, as specified by [Table 1-4 on page 3](#).

**Figure 4-3: AC Power Supply**



The power supplies require power cables that comply with IEC-320 and have a C13 plug. The accessory kit provides two IEC-320 C13 to C14 power cables.

### 4.2.2 DC Power Supplies

The following two DC power supplies are supported.

- PWR-1900-DC
- PWR-500-DC

**Figure 4-4: Supported DC power supplies**




---

**Important!** A disconnect device must be provided as part of the installation .

Un dispositif de sectionnement doit être fourni dans le cadre de l'installation.

---

**Important!** Ensure power is removed from DC circuits before performing any installation actions. Locate the disconnect device, circuit breakers or fuses on DC power lines servicing the circuits. Turn off the power line circuits or remove the fuses.

Pouvoir assurer qu'il est retiré de circuits DC avant d'effectuer des actions d'installation . Localiser les disjoncteurs ou des fusibles sur les lignes de courant continu desservant les circuits. Coupez les circuits de lignes d'alimentation ou retirer les fusibles.

---

**Important!** Wire size must comply with local and national requirements and electrical codes. Use only copper wire.

Le calibre du fil doit être conforme aux exigences locales et nationales et les codes électriques. Utiliser du fil de cuivre.

---

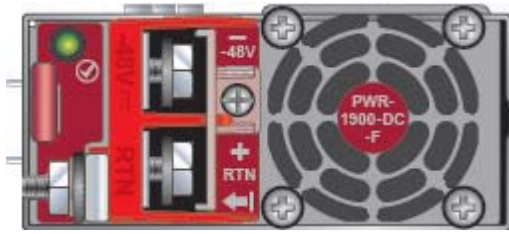
**Important!** Apply ground connection to the switch first during installation and remove last when removing power.

Appliquer connexion à la terre à l'interrupteur premier lors de l'installation et de supprimer la dernière alimentation lors du débranchement.

---

### 4.2.3 PWR-1900-DC Power Supply

Figure 4-5: PWR-1900-DC power supply



#### 4.2.3.1 Wire and Lug Preparation

Before performing any installation actions, ensure power is removed from DC circuits by turning off the power line servicing the circuits. Prepare the stranded wiring before you begin a DC power installation.

**Step 1** Attach an ESD grounding strap.

**Step 2** Stranded copper wiring is required.

- Commercially available 4 to 6 AWG wire is recommended for installations in the U.S.
- Wire size should meet local and national installation requirements.
- Grounding wires and grounding lugs are not supplied.
- Strip the wires to the appropriate length for the lugs.

The wires connecting the DC power supply to the power source must meet the following requirements:

- DC Input Wire Size: 4 – 6 AWG (21.2 mm<sup>2</sup> to 13.3 mm<sup>2</sup>).
- Primary Ground Wire Size: 4 – 6 AWG (21.2 mm<sup>2</sup> to 13.3 mm<sup>2</sup>) per power supply.
- The conductors are copper.

**Step 3** Use agency-approved compression (pressure) lugs for wiring terminations.

**Step 4** Slip on heat-shrink tubing on the wire ends before assembling the lugs on to the wire.

- The lugs must be crimped with the proper tool.
- The tubing should extend over the lugs barrel and the wire's insulator.
- Shrink the tubing with a heat gun.

#### 4.2.3.2 Connecting a DC Power Supply to Power Source

To connect a DC power supply to power source:

**Step 1** Prepare the stranded wiring, see [Section 4.2.3.1: Wire and Lug Preparation](#).

**Step 2** Attach the appropriate lugs to the source DC wires.



**Step 3** Connect the DC-input wires:

- Ground wire to the Protective Earth (PE  $\oplus$ ) terminal.
- Negative source DC cable to the negative (- / -48V) terminal.
- Positive (+) source DC cable to the positive (+ / Rtn) terminal.
- Tightening Torque: 2.7 N-m (24 in. lbs.)



#### 4.2.4 PWR-500-DC Power Supply

The PWR-500W-DC power supply connects to a circuit that provides -48V to -60V and 15A. [Figure 4-6](#) displays the DC power supply.

**Figure 4-6: PWR-500-DC Power Supply**



Ensure the wires connecting the DC power supply to the power source meet the following:

- DC Input Wire Size: AWG 14 (2.0 mm<sup>2</sup>) or larger as appropriate
- Safety Ground Wire Size: AWG 14 (2.0 mm<sup>2</sup>) or larger as appropriate
- Wire Terminal (Lug): ring or spade/fork, 14-16 AWG, #8 (4 mm) screw
- Over-current protection: 20 A.

**Important!** Ensure power is removed from DC circuits before performing any installation actions. Locate circuit breakers or fuses on DC power lines servicing the circuits. Turn off the power line circuits or remove the fuses.

Assurez-vous de pouvoir retirer des circuits en courant continu avant d'effectuer toute action d'installation. Localiser les disjoncteurs ou fusibles sur les lignes électriques DC entretien des circuits. Mettez hors tension le circuit ligne ou retirez les fusibles.

To connect a DC power supply to power source:

**Step 1** Remove the terminal cover to expose the connectors on the terminal block on the face.

**Step 2** Attach the appropriate lugs to the source DC wires.

Use DC cables with either insulated crimp-on spade lugs or insulated crimp-on ring connectors.

---

**Important!** Wire size must comply with local and national requirements and electrical codes. Use only copper wire.

Calibre doit respecter les exigences locales et nationales et les codes de l'électricité. Utiliser seulement du fil de cuivre.

---

**Step 3** Connect the DC-input wires to the terminal block in this order:

1. Ground cable to the ground connector on the face of the power supply.
2. Negative (–) source DC cable to the negative (–) connector on the terminal block.
3. Positive (+) source DC cable to the positive (+) connector on the terminal block.
4. Torque the screws to 1.0 N·m / 9 in·lb.

---

**Important!** Apply the ground connection first during installation and remove last when removing power.

Appliquer le motif connexion tout d'abord pendant l'installation et supprimer dernière lors du retrait de puissance.

---

5. Replace the terminal cover.

## 4.3 Connecting Serial and Management Cables

The accessory kit includes the following cables:

- RJ-45 to DB-9 serial adapter cable.
- RJ-45 Ethernet cable.

Table 4-1 lists the pin connections of the RJ-45 to DB-9 adapter cable.

**Table 4-1 RJ-45 to DB-9 Connections**

RJ-45		DB-9		RJ-45		DB-9	
RTS	1	8	CTS	GND	5	5	GND
DTR	2	6	DSR	RXD	6	3	TXD
TXD	3	2	RXD	DSR	7	4	DTR
GND	4	5	GND	CTS	8	7	RTS

### Note

RJ-45 to DB-9 connections: Models with management ports on the rear panel short RJ-45 pin 1 (RTS) to RJ-45 pin 8 (CTS). RJ-45 pins 2 (DTR) and RJ-45 pin 7 (DSR) are not electrically connected to anything.

For most models, the front panel contains the console, management, and USB ports. Figure 4-7 displays the ports on the front panel of the DCS-7050QX-32S switch. Figure 4-8 displays the ports on rear panel of the DCS-7280SR-48C6 switch. Appendix C and Appendix D display the front and rear panels of all switches covered by this guide.

**Figure 4-7: Front Panel Ports**

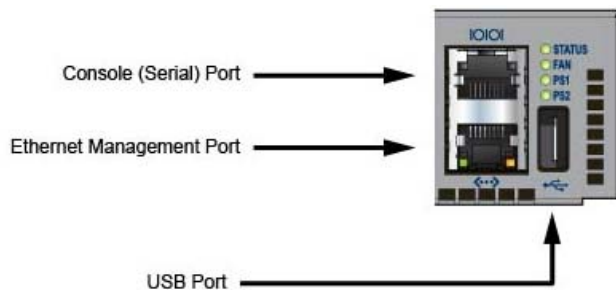
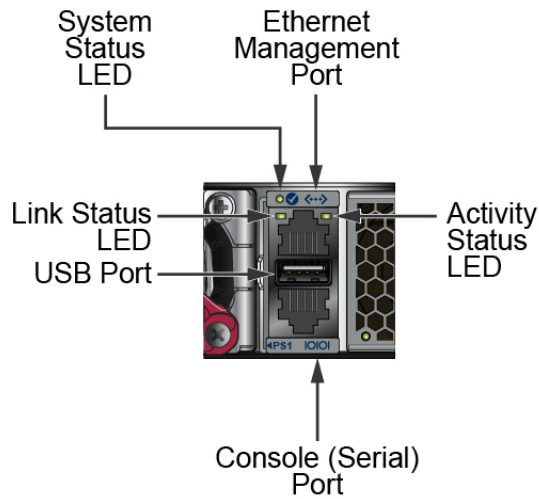


Figure 4-8: Rear Panel Ports



Connect the front or rear panel ports as follows:

- **Console (Serial) Port:** Connect to a PC with the RJ-45 to DB-9 serial adapter cable. The switch uses the following default settings:
  - 9600 baud
  - No flow control
  - 1 stop bit
  - No parity bits
  - 8 data bits
- **Ethernet Management Port:** Connect to 10/100/1000 management network with RJ-45 Ethernet cable.
- **USB Port:** The USB port may be used for software or configuration updates.

---

**Caution** Excessive bending can damage interface cables, especially optical cables.

Flexion excessive peut endommager les câbles d'interface, notamment des câbles optiques.

---

## Configuring the Switch

---

Arista switches ship from the factory in Zero Touch Provisioning (ZTP) mode. ZTP configures the switch without user intervention by downloading a startup configuration file or a boot script from a location specified by a DHCP server. To manually configure a switch, ZTP is bypassed. The initial configuration provides one username (**admin**) accessible only through the console port because it has no password.

When bypassing ZTP, initial switch access requires logging in as **admin**, with no password, through the console port. Then you can configure an **admin** password and other password protected usernames.

This manual configuration procedure cancels ZTP mode, logs into the switch, assigns a password to **admin**, assigns an IP address to the management port, and defines a default route to a network gateway.

**Step 1** Provide power to the switch (Section 4.1).

**Step 2** Connect the console port to a PC (Section 4.2).

As the switch boots without a **startup-config** file, it displays the following through the console:

```
The device is in Zero Touch Provisioning mode and is attempting to
download the startup-config from a remote system. The device will not
be fully functional until either a valid startup-config is downloaded
from a remote system or Zero Touch Provisioning is cancelled. To cancel
Zero Touch Provisioning, login as admin and type 'zerotouch cancel'
at the CLI.
```

```
localhost login:
```

**Step 3** Log into the switch by typing **admin** at the login prompt.

```
localhost login:admin
```

**Step 4** Cancel ZTP mode by typing **zerotouch cancel**. **IMPORTANT: This step initiates a switch reboot.**

```
localhost>zerotouch cancel
```

**Step 5** After the switch boots, log into the switch again by typing **admin** at the login prompt.

```
Arista EOS
localhost login:admin
Last login: Fri Mar 15 13:17:13 on console
```

**Step 6** Enter global configuration mode.

```
localhost>enable
localhost#config
```

**Step 7** Assign a password to the **admin** username with the **username secret** command.

```
localhost(config)#username admin secret pxq123
```

**Step 8** Configure a default route to the network gateway.

```
localhost(config)#ip route 0.0.0.0/0 192.0.2.1
```

**Step 9** Assign an IP address (**192.0.2.8/24** in this example) to an Ethernet management port.

```
localhost(config)#interface management 1
localhost(config-if-Ma1/1)#ip address 192.0.2.8/24
```

**Step 10** Save the configuration by typing **write memory** or **copy running-config startup-config**.

```
localhost#copy running-config startup-config
```

When the management port IP address is configured, use this command to access the switch from a host, using the address configured in step 9:

```
ssh admin@192.0.2.8
```

Refer to the **Arista Networks User Manual** for complete switch configuration information.

## Status Indicators

---

### A.1 Front Indicators

#### A.1.1 Switch Indicators

Front panel LEDs are located on the right side of the chassis and display system, fan, and power supply status. The front panel LEDs are labeled either as in [Figure A-1](#) or as in [Figure A-2](#). Check your device for the specific method utilized.

Figure A-1: System Status Indicator LEDs

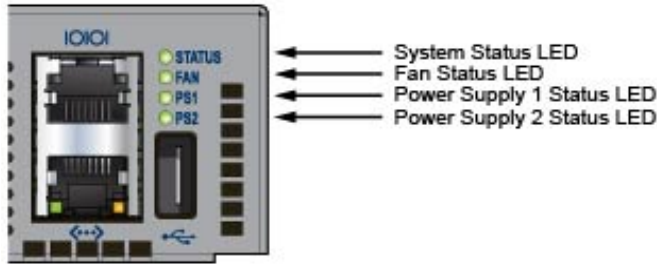
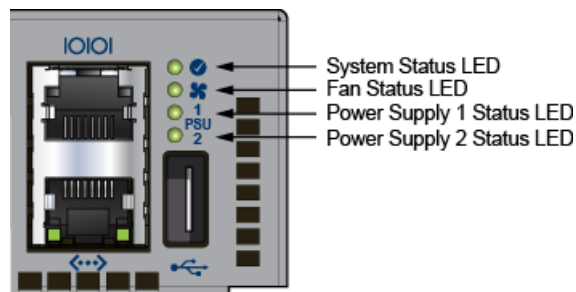


Figure A-2: System Status Indicator LEDs



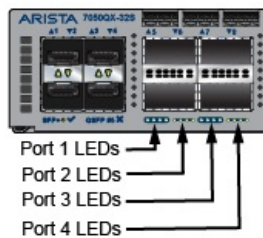
**Table A-1 Switch Indicators LED States (Front)**

LED Name	LED State	Device Status
System Status LED	Blinking Green	System is powering up.
	Green	Normal operations. Due to power supply and fan redundancy, this LED will remain green if a single fan or power supply is missing or in a failed state.
	Blue	The locator function is active.
	Amber	Two or more fans (any combination of fan modules or PSU fans) are disconnected or malfunctioning. The switch will automatically execute a “graceful shutdown” shortly.
Fan Status LED	Green	All fan and power modules are operating normally.
	Amber	Single fan module is removed or malfunctioning. It is also amber when a PSU is completely removed or has a stuck fan rotor.
	Red	Two or more fans (any combination of fan modules or PSU fans) are disconnected or malfunctioning. The switch will automatically execute a “graceful shutdown” shortly.
PSU [1:2] Status LED	Green	PSU is functioning and fully operational. AC is present, Aux output is ON, and Main output is ON.
	Off	PSU has been removed or is not operating properly due to AC cord being unplugged, its fan rotor being stuck, or an internal fault.

### A.1.2 Port Indicators

Port LEDs, located in the vicinity of their corresponding ports, provide link and operational status. [Figure A-3](#) displays the Port LED location on the DCS-7050QX-32S switch.

**Figure A-3: Port LEDs**



[Table A-2](#) provides status conditions that correspond to port LED states. Port LED behavior for QSFP+ and SFP+ ports is consistent.

**Table A-2 Port LED States (Front)**

LED State	Status
Off	Port link is down.
Green	Port link is up.



Table A-2 Port LED States (Front) (Continued)

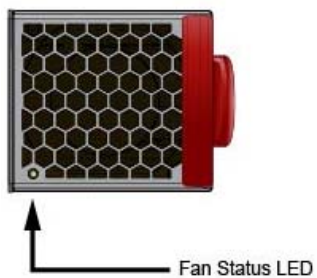
LED State	Status
Yellow	Port is software disabled.
Flashing Yellow	Port failed diagnostics.

## A.2 Rear Status Indicators

Fan and power supply modules are accessed from the rear panel. Each fan and power supply module contains an LED that reports the module status.

Fan Status LEDs are on the fan modules, as displayed in [Figure A-4](#).

Figure A-4: Fan Status LED



[Table A-3](#) provides status conditions that correspond to fan status LED states.

Table A-3 Fan Status LED States (Rear)

LED State	Status
Off	The fan module is not detected. If it is inserted, it may not be seated properly.
Green	The fan is operating normally. This LED state is exclusive to its fan module, and independent of the states of its neighboring fans and power supplies.
Red	The fan has failed.

The AC Power Supply Status LEDs are on the power supply modules, as displayed in [Figure A-5](#).

Figure A-5: AC Power Supply Status LED

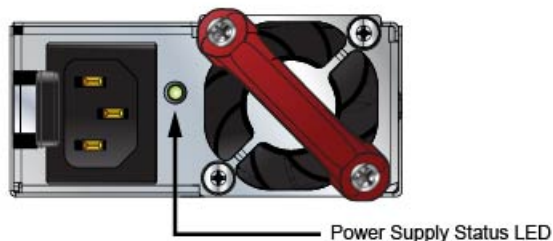


Table A-4 provides status conditions that correspond to the AC power supply status LED states.

Table A-4 AC Power Supply Status LED States (Rear)

Power Supply State	PWR-500AC-F PWR-500AC-R	PWR-745AC-F PWR-745AC-R	PWR-747AC-F PWR-747AC-R
Input power present Normal operation	Green	Green	Green
Input power present Power Supply fault	Yellow	Yellow	Yellow
No Input power Supply installed in chassis	Off	Off	Off
Input power present Supply not installed in chassis	Green	Green	Green

The DC Power Supply Status LEDs are on the power supply modules, as displayed in Figure A-6.

Figure A-6: DC Power Supply Status LED

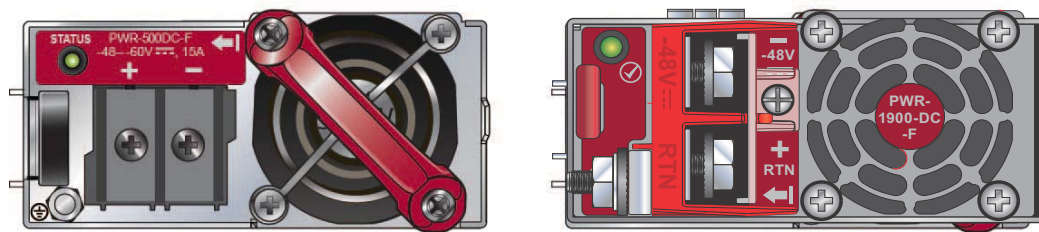


Table A-5 provides status conditions that correspond to the DC power supply status LED states.

Table A-5 DC Power Supply Status LED States (Rear)

Power Supply State	PWR-500DC-F PWR-500DC-R	PWR-1900DC
Input power present Normal operation	Green	Green
Input power present Power Supply fault	Blinking Yellow	Blinking Yellow
No Input power Supply installed in chassis	Off	Off
Input power present Supply not installed in chassis	Blinking Yellow	Blinking Yellow

**Note**

You can narrow down the error condition by logging in to the switch to view the specific device state. Refer to the **Arista User Manual's** *Switch Environment Control* chapter, under the topic *Viewing Environment Status*, for further information on the `show environment` commands.

## Parts List

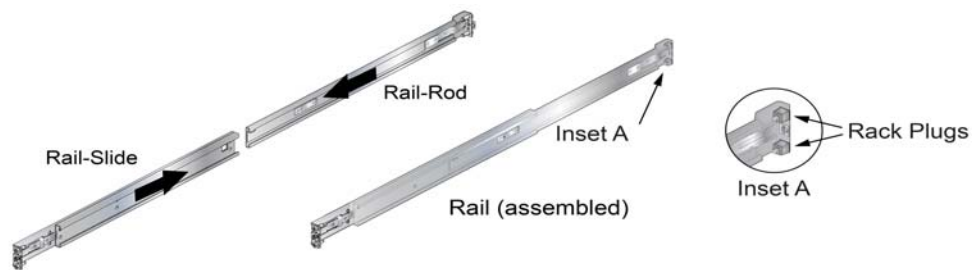
---

Each switch provides an accessory kit that contains parts that are required to install the switch. This appendix lists the installation parts contained in the switch accessory kit.

### B.1 Rack Mount Parts

#### B.1.1 Four-Post Rack Mount Parts

Figure B-1: Four-Post Rack Mount Parts



#### B.1.2 Two-Post Rack Mount Parts

Figure B-2: Two-Post Rack Mount Parts



## B.2 Cables

Quantity	Description
2	Power cables: IEC-320/C13-C14, 13 A, 250 V
1	RJ-45 Patch Panel Cable
1	RJ-45 to DB9 Adapter Cable

**Warning** All provided power cables are for use only with Arista products.

### 警告

すべての電源コードは提供する製品で使用するためだけを目的としている。

### 電源コードの他の製品での使用の禁止

Aristaが提供するすべての電源コードは、Aristaの製品でのみ使用してください。

# Appendix C

## Front Panel

This appendix displays the front panel of all switches covered by this guide.

Figure C-1: DCS-7160-32CQ

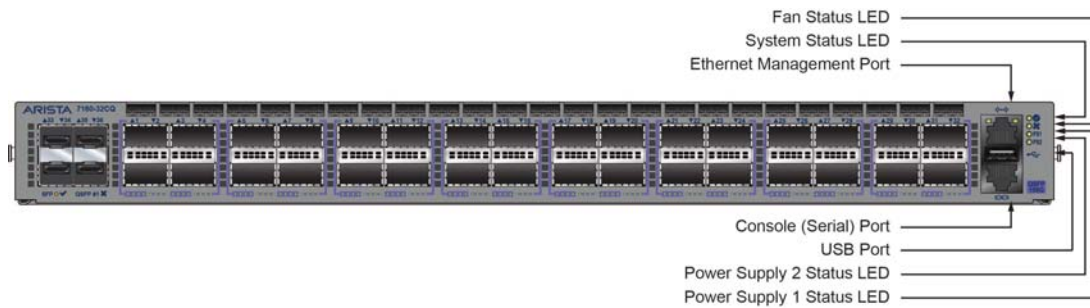


Figure C-2: DCS-7160-48YC6

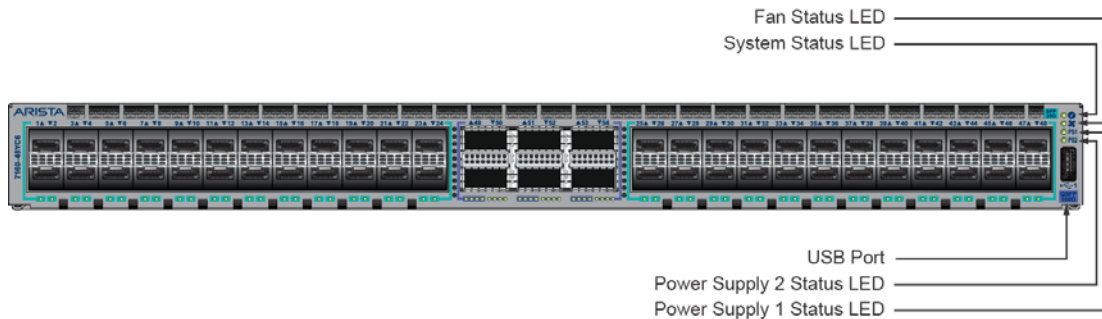


Figure C-3: DCS-7160-48TC6

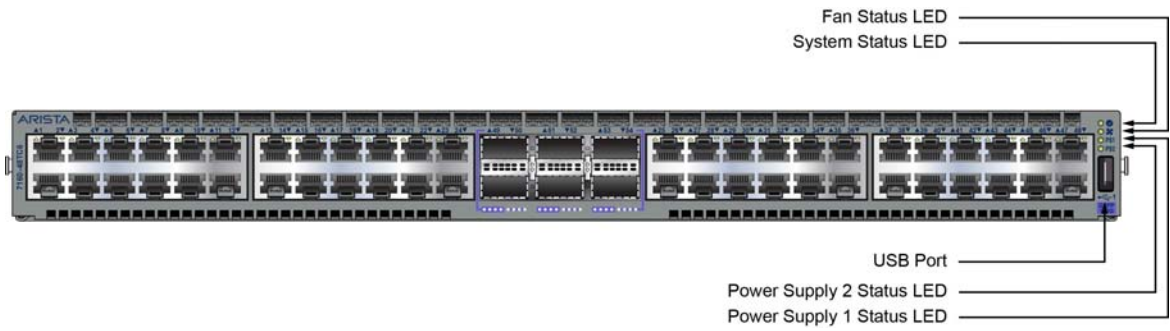


Figure C-4: DCS-7170-32C

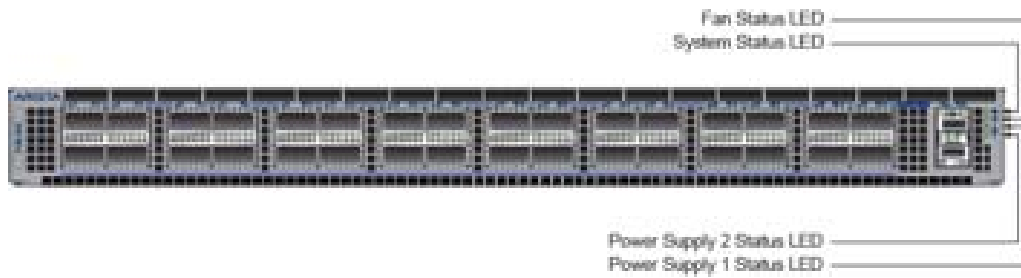
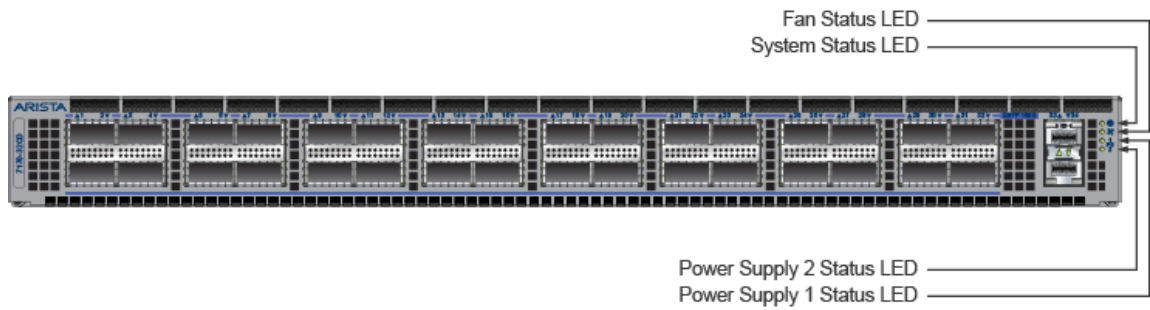


Figure C-5: DCS-7170-32CD



## Rear Panel

All switches covered by this guide use one of the two rear panels shown below. Depending on the installed power supply module, the appearance could be different from those shown.

Figure D-1: Rear Panel for Models with Management Ports in the Front

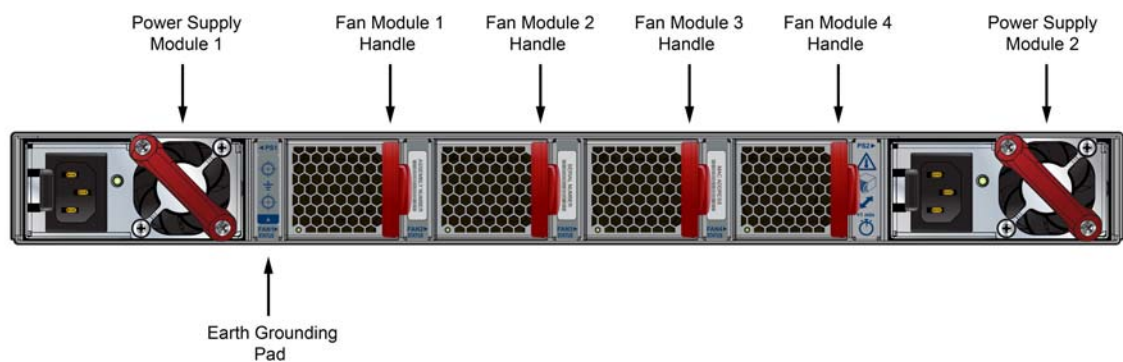
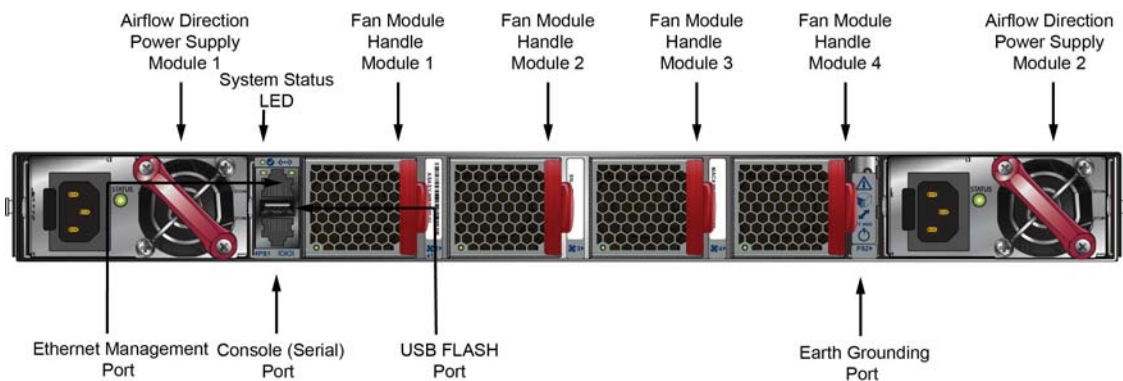


Figure D-2: Rear Panel for Models with Management Ports in the Rear







## Maintenance and Field Replacement

---

### E.1 Considerations

- All fans and power supplies are hot swappable.
- The switch can be running while a power supply is being installed or removed, but the power supply being replaced must not be connected to a power source.
- All slots must be filled or covered with a blank for operation (even though power supply or fans may not be functional).
- Before you begin, refer to the Arista Networks document *Safety Information and Translated Safety Warnings* available at: <http://www.arista.com/support/docs/eos>.

---

**Note**

Descriptions for the removal and replacement of power supplies and fans are for a representative power supply or fan. Locations of status indicator LEDs may differ. Refer to the front and rear panel illustrations of your device to locate the appropriate LED.

---

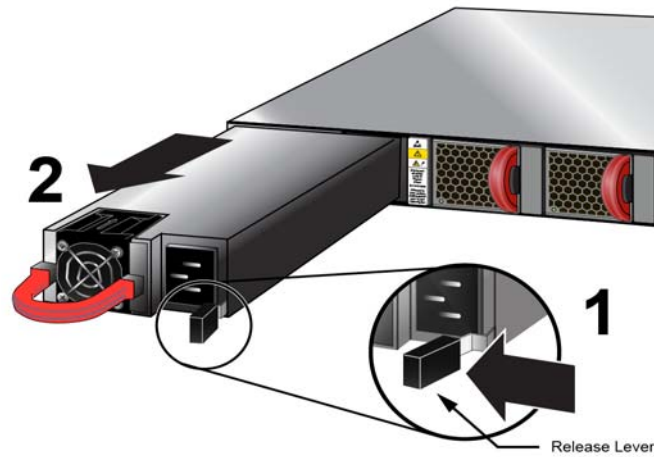
### E.2 Power Supplies

The following steps are required when removing power supplies from a switch.

#### E.2.1 Removing a Power Supply

- Step 1** Ground yourself with an ESD wrist strap.
- Step 2** Power down the power supply to be removed by disconnecting the AC power cable.
- Step 3** Push the power supply release lever and remove the power supply (Figure E-1 on page 38).

Figure E-1: Remove power supply



## E.2.2 Installing a Power Supply

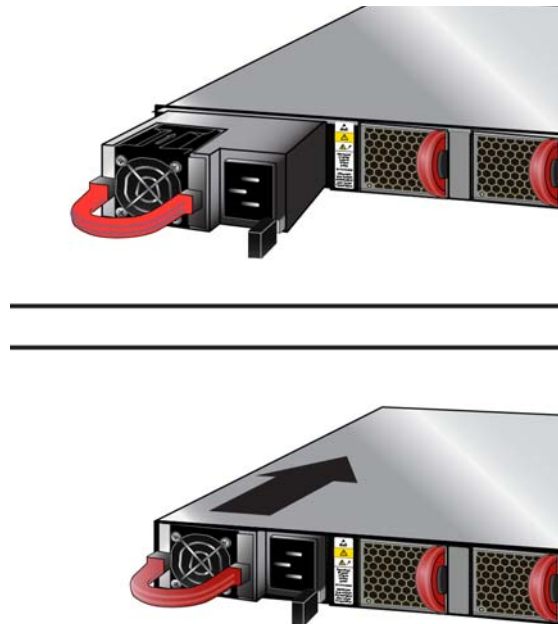
You must make space for installing the power supply by removing an existing one ([Section E.2.1](#)).

**Step 1** Remove the replacement power supply from its packaging.

**Step 2** Slide the new power supply into the empty slot.

**Step 3** Slide the new power supply into the switch until the power supply is fully seated and the release lever snaps into place ([Figure E-2](#)).

Figure E-2: Install power supply



**Step 4** Connect the power cord to the power supply.

**Step 5** Verify the LED(s) on the power supply.

**Note**

---

The Power Supply status LED should be a steady green for normal operation.

---

**Step 6** Verify the new power supply operation by issuing the **show environment power** command.

```
switch#show environment power
```

The output of the command will list the power supplies in operation and should include the one you replaced.

## E.3 Fan Modules

---

**Note**

Hot swap fans within 30 seconds to prevent the switch from overheating. Ensure that the module you are replacing matches those already installed in the switch.

---

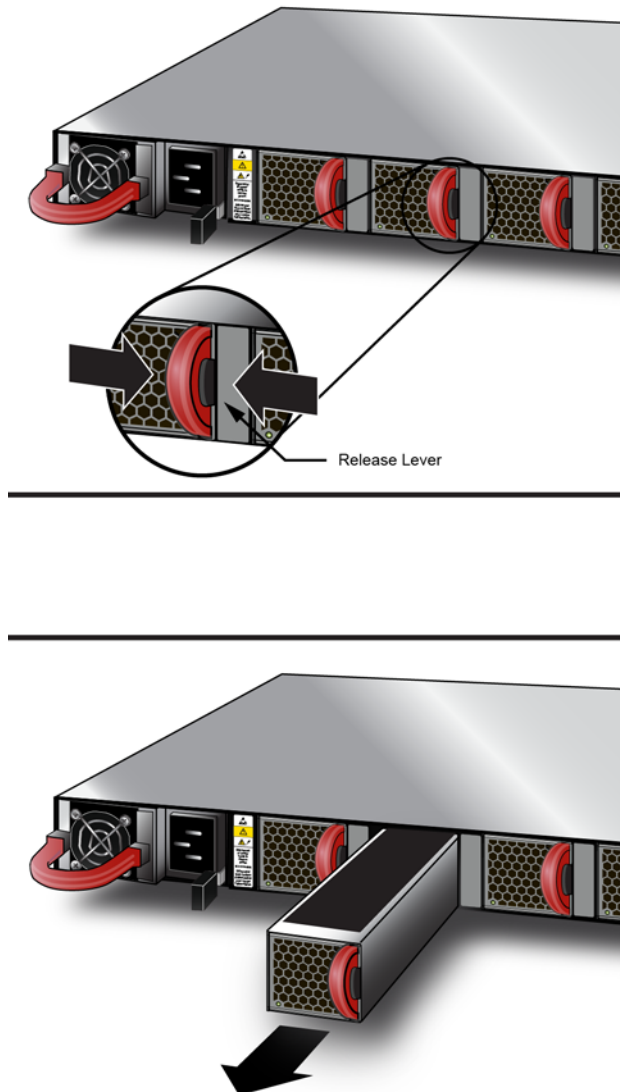
### E.3.1 Removing a Fan Module

The following steps are required when removing or replacing fans from a switch.

**Step 1** Ground yourself with an ESD wrist strap.

**Step 2** Push the fan module release lever and slide the fan module out of the switch ([Figure E-3 on page 40](#)).

Figure E-3: Removing fan module



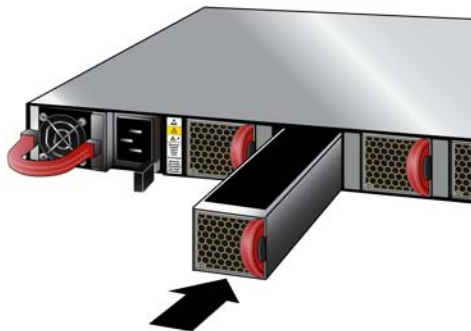
### E.3.2 Installing a Fan Module

You must make space for installing the fan module by removing an existing one ([Section E.3.1](#)).

**Step 1** Remove the replacement fan from its packaging.

**Step 2** Slide the new fan module into the switch until the module is fully seated and the release lever snaps into place ([Figure E-4 on page 41](#)).

Figure E-4: Inserting the fan module



**Step 3** Verify that the fan module is working normally.

---

**Note** The fan module status LED should be a steady green for normal operation.

---



# Appendix F

## Regulatory Model Numbers

---

This appendix lists the regulatory model numbers (RMNs), where applicable, for the product models for the switches described in this document.

**Table F-1 Regulatory Model Numbers and Product Numbers**

Regulatory Model Number (RMN)	Product Number(s)
AN1511	DCS-7160-32CQ
AN1611	DCS-7160-48TC6
AN1612	DCS-7160-48YC6
AN1707	DCS-7170-32C, DCS-7170-32CD





# Appendix G

## Taiwan RoHS Information

---

This appendix provides Taiwan RoHS information for switches covered by this guide.

For Taiwan BSMI RoHS Table, go to <https://www.arista.com/assets/data/pdf/AristaBSMIRoHS.pdf>.

