



# Unified Extensible Firmware Interface Specification

Version 2.7  
May 2017

# Acknowledgments

---

The material contained herein is not a license, either expressly or impliedly, to any intellectual property owned or controlled by any of the authors or developers of this material or to any contribution thereto. The material contained herein is provided on an "AS IS" basis and, to the maximum extent permitted by applicable law, this information is provided AS IS AND WITH ALL FAULTS, and the authors and developers of this material hereby disclaim all other warranties and conditions, either express, implied or statutory, including, but not limited to, any (if any) implied warranties, duties or conditions of merchantability, of fitness for a particular purpose, of accuracy or completeness of responses, of results, of workmanlike effort, of lack of viruses and of lack of negligence, all with regard to this material and any contribution thereto. Designers must not rely on the absence or characteristics of any features or instructions marked "reserved" or "undefined." The Unified EFI Forum, Inc. reserves any features or instructions so marked for future definition and shall have no responsibility whatsoever for conflicts or incompatibilities arising from future changes to them. ALSO, THERE IS NO WARRANTY OR CONDITION OF TITLE, QUIET ENJOYMENT, QUIET POSSESSION, CORRESPONDENCE TO DESCRIPTION OR NON-INFRINGEMENT WITH REGARD TO THE SPECIFICATION AND ANY CONTRIBUTION THERETO.

IN NO EVENT WILL ANY AUTHOR OR DEVELOPER OF THIS MATERIAL OR ANY CONTRIBUTION THERETO BE LIABLE TO ANY OTHER PARTY FOR THE COST OF PROCURING SUBSTITUTE GOODS OR SERVICES, LOST PROFITS, LOSS OF USE, LOSS OF DATA, OR ANY INCIDENTAL, CONSEQUENTIAL, DIRECT, INDIRECT, OR SPECIAL DAMAGES WHETHER UNDER CONTRACT, TORT, WARRANTY, OR OTHERWISE, ARISING IN ANY WAY OUT OF THIS OR ANY OTHER AGREEMENT RELATING TO THIS DOCUMENT, WHETHER OR NOT SUCH PARTY HAD ADVANCE NOTICE OF THE POSSIBILITY OF SUCH DAMAGES.

Copyright 2017 Unified EFI Forum, Inc. All Rights Reserved.

# Revision History

Revision	Mantis Number / Description	Date
2.7	1779 Adjusting UEFI version to UEFI 2.7	April 2017
2.7	1771 BluetoothLE minor fix	April 2017
2.7	1762 UEFI UFS DEVICECONFIG Protocol	April 2017
2.7	1751 Update DNS Device Path	April 2017
2.7	1750 Add new data type to EFI Suppliment Protocol	April 2017
2.7	1745 NVDIMM Label Protocol	April 2017
2.7	1744 NVDIMMBlock Translation Table (BTT) Protocol {NewChapter}	April 2017
2.7	1730 HII Popup Protocol	April 2017
2.7	1726 Host and I/O defense	April 2017
2.7	1720 Have Partition driver publish addition information for MBR/GPT partition types.	April 2017
2.7	1719 Add EFI HTTP Boot Callback Protocol	April 2017
2.7	1718 Allow SetData to clear configuration in Ip4Config2/Ip6Config Protocol	April 2017
2.7	1716 Add BluetoothLE ECR	April 2017
2.7	1711 Firmware Error Record Update	April 2017
2.7	1707 Clarification of Private Authenticated Variables	April 2017
2.7	1701 Add wildcard support to RegisterKeyNotify	April 2017
2.7	1690 Reset Notification Protocol Update	April 2017
2.7	1689 Secure Boot with Externally Managed Configuration	April 2017
2.7	1685 Key Management Services (KMS) Protocol Enhancement	April 2017
2.7	1672 UEFI Variable Enhancements	April 2017
2.7	1654 New AIP Information block for wireless NIC	April 2017
2.7	1652 Add DNS device path node	April 2017
2.7	1647 UEFI binding for RISC-V	April 2017
2.7	1641 Simplify SecureBoot Revocation and Usage of VerifySignature	April 2017
2.7	1641 Simplify Secure Boot Revocation and Usage of VerifySignature	April 2017
2.7	1627 Support ASCII RegEx Patterns in EFI_REGULAR_EXPRESSION_PROTOCOL	April 2017
2.7	1627 EFI regular expression syntax type definitions	April 2017
2.7	1623 New EFI_HTTP_STATUS_CODE enum for 308 Permanent Redirect	April 2017
2.7	1623 New EFI_HTTP_STATUS_CODE enum for 308 Permanent Redirect	April 2017
2.6B	1772 Clarify EFI_NOT_READY in Media State of AIP	April 2017
2.6B	1767 Incorrect structure definition for EFI_IFR_RESET_BUTTON_OP	April 2017
2.6B	1742 Clairfy PK enrolling in user mode	April 2017
2.6B	1741 The memory map returnedByBS->GetMemoryMap() mayContain impossible values.	April 2017
2.6B	1739 typos -Broken references link.	April 2017

## Unified Extensible Firmware Interface Specification

Revision	Mantis Number / Description	Date
2.6B	1729 Cleanup of ACPI 2.0 references in UEFI spec	April 2017
2.6B	1708 Typos in Imge Decode and Image Ex Protocols	April 2017
2.6B	1700 Align ACPI descriptor definitions in PCI I/O and PCI RootBridge I/O	April 2017
2.6B	1698 Update to Mantis 1613 - GetNextVariable	April 2017
2.6B	1691 Remove/Deprecate SMM Communication ACPI Table	April 2017
2.6B	1682 HII Protocol StatusCodes	April 2017
2.6B	1678 Simplify the ACPI Table GUID declarations	April 2017
2.6B	1675 section 30.5.1 typo	April 2017
2.6B	1668 Duplicate GUID issue - mustChange the Image Decoder Protocol GUID	April 2017
2.6B	1655 HTTP errata inConfigure()	April 2017
2.6B	1653 Incorrect errorCode value in MTFTP6	April 2017
2.6B	1634 Update to the EFI_SIMPLE_TEXT_INPUT_PROTOCOL TPL restriction	April 2017
2.6B	1629 Errata in GetVariable description	April 2017
2.6B	1625 Clarification of HTTPBoot wire protocol "HTTPClient" VendorClass Option	April 2017
2.6B	1624 Fix spelling typo in EFI_HTTP_STATUS_CODE	April 2017
2.6B	1613 GetNextVariableName Errata	April 2017
2.6B	1612 ResetSystem Errata	April 2017
2.6B	1609 UEFI Errata - Address Security problems in the Pkcs7Verify Protocol	April 2017
2.6B	1608 Enhance EFI_IFR_NUMERIC (Step)	April 2017
2.6B	1586 Errors in appendix N for ARM ProcessorContext Information	April 2017
2.6B	1584 WIFI errata	April 2017
2.6B	1580 Correct some typos	April 2017
2.6B	1559 Clarify return value for NULL pointer in LocateProtocol() API	April 2017
2.6B	1557 secureBoot and auth variable errata	April 2017
2.6B	1556 HTTPv6Boot DHCP Options Errata	April 2017
2.6B	1555 USB Function port protocol errata	April 2017
2.6B	1554 fix to ecr 1539	April 2017
2.6B	1553 os recoveryBoot option errata	April 2017
2.6B	1551 EFIBluetoothConfiguration Protocol Errata	April 2017
2.6B	1550 Replace FTP4 dataCallback pointer-to-function-pointer with regular function pointer	April 2017
2.6A	SameContent as version 2.6,But with the Adobe "accessibility" feature activated so text-to-speech will work.	December 2016
2.6	1548ClarifyBoot procedure when file name is absent2.	January, 2016
2.6	1547Clarify requirements for setting the PK variable.	January, 2016
2.6	1544 DNS lookup API spelling	January, 2016
2.6	1543 ip4/6Config policy errata/2.6 update	January, 2016
2.6	1542 UEFI 2.6 supplicant errata	January, 2016
2.6	1539 New EFI_HTTP_ERROR StatusCode	December, 2015



Revision	Mantis Number / Description	Date
2.6	1538 UEFI TLS errata	December, 2015
2.6	1536 UEFI 2.6 Errata : IMAGE EX Protocol and EFI HII Image Decoder protocol Errata	December, 2015
2.6	1534 EditorialComments against 2.6 Final Draft	December, 2015
2.6	1533Bugs in the HTTP usage example	December, 2015
2.6	1523Comments against 2.6 Draft	December, 2015
2.6	1522 AArch64Bindings AlignmentBit errata	December, 2015
2.6	1521Comment against UEFI.next draft - M1479	December, 2015
2.6	1519 Version for the next UEFI spec is...	December, 2015
2.6	1518Comments against 2.6 Draft	December, 2015
2.6	1516 EditorialComments against 2.6 Draft	December, 2015
2.6	1509 EFI_PLATFORM_TO_DRIVER_CONFIGURATION_PROTOCOL Response to unsupported ParameterTypeGuid	December, 2015
2.6	1508 Lack of flexibility and realism in exception levelChoice whenCalling runtime services	December, 2015
2.6	1507 Insufficient qualification of page attributes for AArch64	December, 2015
2.6	1502 PCI IO Define how to use the Address Translation Offset for systems that are not mapped 1:1	November, 2015
2.6	1501 Define the usage of the "Address Space Granularity" field is defined in the PCI Root IO	November, 2015
2.6	1496Bad table reference in 13.2 EFI_PCI_ROOT_BRIDGE_IO_PROTOCOL.Configuration()	November, 2015
2.6	1494 Errata against UEFI 2.5 Properties Table	November, 2015
2.6	1493 Updates to the SD_MMC_PASS_THRU interface	November, 2015
2.6	1492 wireless macConnection protocol II errata	November, 2015
2.6	1491 supplicant errata	November, 2015
2.6	1480 Refine Progress description in EFI_KEYWORD_HANDLER_PROTOCOL	November, 2015
2.6	1479 UEFI Properties TableClarification	November, 2015
2.6	1471 SD/eMMC PassThru Protocol update (follow up to mantis 1376)	November, 2015
2.6	1467 New API - EFI_WIRELESS_MAC_CONNECTION_II_PROTOCOL	November, 2015
2.6	1466 UEFI Ram disk protocol	November, 2015
2.6	1452 Minor edits to 0001409	November, 2015
2.6	1414 Generalisation ofCommunication method in Appendix O	November, 2015
2.6	1409 EFI HII ImageEX protocol and EFI HII Image Decoder protocols	November, 2015
2.6	1408 EFI HII Font EX protocol and EFI HII Font Glyph Generator protocols	November, 2015
2.6	1402 Add EFI_BROWSER_ACTION_SUBMITTED	November, 2015
2.6	1383 Adding an EraseBlocks() function to a new protocol	November, 2015
2.6	1376 SD/eMMC PassThru Protocol	November, 2015
2.6	1357 ARMCPER extensions	November, 2015
2.5A	1481 new networkConfig2 protocol data structure has a magic number	October 2015
2.5A	1477 AllowCloseEvent toBeCalled within the Notification Function	October 2015

## Unified Extensible Firmware Interface Specification

Revision	Mantis Number / Description	Date
2.5A	1476 Update to Indicate thatCloseEvent UnregistersCorresponding Protocol Notification Registrations	October 2015
2.5A	1472 ATA Pass Thru Errata	October 2015
2.5A	1469 UNDI Errata - add more statistics	October 2015
2.5A	1468 Errata on UEFI Supplicant protocol	October 2015
2.5A	1451 Memory MapConsistency	October 2015
2.5A	1441 UEFI2.5A – UNDI ProtocolClarification	October 2015
2.5A	1426 UEFI 2.5 typo	October 2015
2.5A	1424 Incorrect link in Section 22.1 FMP GetImageInfo()	October 2015
2.5A	1421 Misc HTTP API typos	October 2015
2.5A	1420 GetNextHighMonotonicCountClarification	October 2015
2.5A	1419 Supplicant protocol using same GUID as TLS protocol	October 2015
2.5A	1418 Inconsistent issues in DNS	October 2015
2.5A	1417 Add HttpMethodMax to EFI_HTTP_METHOD enum	October 2015
2.5A	1410Clarifications in appendix O	October 2015
2.5A	1407 Networking errata - EFI_HTTP_STATUS typos	October 2015
2.5A	1405 Errata in table 271 in Appendix O	October 2015
2.5A	1399Clarification for EFI_BROWSER_ACTION_REQUEST_RECONNECT	October 2015
2.5A	1398 Errata update to the runtime GetVariable operation documentation	October 2015
2.5A	1388 Missed memory type fixes	October 2015
2.5A	1381 Remove informativeContent in 12.6.1	October 2015
2.5A	1365 7.4 Virtual Memory Services lists Section 2.3.2 through Section 2.3.4. incorrectly	October 2015
2.5A	1363 Short form URI device path	October 2015
2.5A	1209 UEFI networking APIChapter 2.6 requirements errors	October 2015
2.5A		October 2015
2.5	1364 Extend supplicant data type for EAP	April, 2015
2.5	1362 HTTPBoot typos/bugs	April, 2015
2.5	1360 Vendor Range for UEFI memory Types	April, 2015
2.5	1358 v2.5 amendment and v2.4 errata (missed implementation of Mantis 1089)	April, 2015
2.5	1353 SATA Device Path Node Errata	April, 2015
2.5	1352 Errata for 1263 and 1227	
2.5	1350 Keyword Strings Errata	April, 2015
2.5	1348 ERRATA - Section 10.12 EFI_ADAPTER_INFORMATION_PROTOCOLCustom Types	April, 2015
2.5	1347Boot Manager Policy Errata	April, 2015
2.5	1346 Mantis 1288 Errata	April, 2015
2.5	1345 EFI_USB2_HC_PROTOCOL Errata	April, 2015
2.5	1342 DNS6 - friendly amendment for reviewBy USWG	April, 2015

Revision	Mantis Number / Description	Date
2.5	1341 DNS4 - friendly amendment toBe reviewedBy USWG	April, 2015
2.5	1339 Errata in section 7.2.3.2 Hardware Error Record Variables	April, 2015
2.5	1309 Disallow EFI_VARIABLE_AUTHENTICATION from SecureBoot Policy Variables	April, 2015
2.5	1308 Fix typo's found in the final/published UEFI 2.4 ErrataB spec	February, 2015
2.5	1304 Add IMAGE_UPDATABLE_VALID_WITH_VENDOR_CODE to FMPCheck image	February, 2015
2.5	1303 Update the UEFI version to reflect new revision	February, 2015
2.5	1288 The Macro definitionConflict in EFI_SIMPLE_TEXT_OUTPUT_PROTOCOL.SetAttribute() in UEFI 2.4B	February, 2015
2.5	1287 Errata: EFI Driver Supported EFI Version not matching the spec revision	February, 2015
2.5	1269Configuration Routing Protocol andConfiguration String Updates	February, 2015
2.5	1268 RAM Disk UEFI Device Path Node	February, 2015
2.5	1266 UEFI.Next Feature - IP_CONFIG2 Protocol	February, 2015
2.5	1263Customized Deployment of SecureBoot	February, 2015
2.5	1257Correct the typedef definitions for EFI_BOOT_SERVICES/EFI_RUNTIME_SERVICES--Reiterate	February, 2015
2.5	1255 UFS Device Path Node Length	February, 2015
2.5	1254 SD Device Path	February, 2015
2.5	1251 EFI_REGULAR_EXPRESSION_PROTOCOL and EFI_IFR_MATCH2 HII op-code	February, 2015
2.5	1244 sections of the spec mis-arranged	February, 2015
2.5	1234 UEFI.Next feature - SmartCard edge protocol	February, 2015
2.5	1227 UEFI.Next feature - Platform recovery	February, 2015
2.5	1224 UEFI.Next - Adding support for No executable data areas	February, 2015
2.5	1223 UEFI.Next networking features -Chapter 2.6 requirements	February, 2015
2.5	1222 UEFI.Next feature -BMC/Service Processor Device Path	February, 2015
2.5	1221 UEFI.Next feature - REST Protocol	February, 2015
2.5	1220 UEFI.Next feature -Bluetooth	February, 2015
2.5	1219 UEFI.Next Feature - UEFI TLS API	February, 2015
2.5	1218 UEFI.Next feature - EAP2 Protocol	February, 2015
2.5	1217 UEFI.Next feature - WIFI support	February, 2015
2.5	1216 UEFI.next feature - DNS version 6	February, 2015
2.5	1215 UEFI.Next feature - DNS version 4	February, 2015
2.5	1214 UEFI.Next feature - HTTPBoot	February, 2015
2.5	1213 UEFI.Next feature - HTTP helper API	February, 2015
2.5	1212 UEFI.Next feature - HTTP API	February, 2015
2.5	1204 new UEFI USB Function I/O Protocol addition to the UEFI spec	February, 2015
2.5	1201 Exposing Memory Redundancy to OSPM	February, 2015
2.5	1199 Add NVM Express Pass Thru Protocol	February, 2015

## Unified Extensible Firmware Interface Specification

Revision	Mantis Number / Description	Date
2.5	1191 Add new SMBIOS3_TABLE_GUID in EFI_CONFIGURATION_TABLE	February, 2015
2.5	1186 AArch64BindingClarifications and errata	February, 2015
2.5	1183 New Protocol with 2 Function for PKCS7 Signature Verification Services	February, 2015
2.5	1174 errata - Error in EFI_IFR_PASSWORD logic flowchart	February, 2015
2.5	1167 Persistent Memory Type support	February, 2015
2.5	1166 hash 2 protocol errata	February, 2015
2.5	1163 InlineCryptographic Interface Protocol proposal	February, 2015
2.5	1159 Proposal for System Prep Applications	February, 2015
2.5	1158 errata -Boot managerClarification	February, 2015
2.5	1147--REDACT	February, 2015
2.5	1121 IPV6 support from UNDI	February, 2015
2.5	1109 SmartCard Reader	February, 2015
2.5	1103 Longer term NewCPER Memory Section	February, 2015
2.5	1091Clarification of handle to host FMP	February, 2015
2.5	1090 ESRT: EFI System Resource Table andComponent firmware updates	February, 2015
2.5	1071 New EFI_HASH2_PROTOCOL	February, 2015
2.4C	1308 Fix typo's found in the final/published UEFI 2.4 ErrataB spec	January 2015
2.4C	1287 Errata: EFI Driver Supported EFI Version not matching the spec revision	January 2015
2.4C	1257Correct the typedef definitions for EFI_BOOT_SERVICES/ EFI_RUNTIME_SERVICES	January 2015
2.4C	1244 sections of the spec misarranged	January 2015
2.4C	1211 EFI_LOAD_OPTION Definition	January 2015
2.4C	1209 Errata - UEFI networking APIChapter 2.6 requirements	January 2015
2.4C	1205 Errata for Hii Set item	January 2015
2.4C	1200 Universal Flash Storage (UFS) Device Path	January 2015
2.4C	1198 EFI_ATA_PASS_THRU_PROTOCOLClarification	January 2015
2.4C	1194 Add EFI_IFR_FLAG_RECONNECT_REQUIRED	January 2015
2.4C	1192Cleanup GUID formatting issues	January 2015
2.4C	1186 AArch64BindingClarifications and errata	January 2015
2.4C	1185 errata - tcp api	January 2015
2.4C	1184 errata - snp modeClarification	January 2015
2.4C	1182 Errata - UEFI URI Device path issue	January 2015
2.4C	1174 errata - Error in EFI_IFR_PASSWORD logic flowchart	January 2015
2.4C	1173 EFI_IFR_NUMERIC Errata	July 11, 2014
2.4C	1172 EfiACPIMemoryNVS definition missing S4	July 11, 2014
2.4C	1170 Errata pxeBc apiClarification	July 11, 2014
2.4C	1169 Errata - volatile networking variableCleanup	July 11, 2014
2.4C	1168 MTFTP Errata	July 11, 2014
2.4C	1165 Option rom layout errata	July 11, 2014
2.4C	1162 Typo in ReinstallProtocolInterface() EFI 1.10 Extension section	July 11, 2014

Revision	Mantis Number / Description	Date
2.4C	1150 Missing LineBreakCharacter (HII Errata)	July 11, 2014
2.4C	1147 EFI_USB2_HC_PROTOCOL.AsyncInterruptTransfer() Errata	July 11, 2014
2.4C	1141 UEFI errata - ia32/x64 vector register management	July 11, 2014
2.4C	1140UEFI Errata - image execution info table	July 11, 2014
2.4C	1139 UEFI Errata on the storage securityCommand protocol	July 11, 2014
2.4C	1066 Errata--reference to missing table (90) removed	July 11, 2014
2.4C	1043 Ability to refresh the entire form [newContent]	July 11, 2014
2.4C	1042 AddBrowser Action Request "reconnect"	July 11, 2014
2.4B	1146 Typos andBroken links	April 17, 2014
2.4B	1137 Typographic errors in the 2.4 ErrataB draft	April 16, 2014
2.4B	1128 URI device path node redux--supersedes (defunct) 1119	April 4, 2014
2.4B	1127 USB Errata - unnecessary restriction on UEFI interrupt transfer types	March 27, 2014
2.4B	1124 Adding text description for NVMe device node	March 27, 2014
2.4B	1122Correct misleading language in the UEFI 2.4a specification about the EFI_ADAPTER_INFORMATION_PROTOCOL.EFI_ADAPTER_INFO_GET_SUPPOR TED_TYPES function	March 27, 2014
2.4B	1120 Make time stamp handlingConsistent around all of the networking API's	March 27, 2014
2.4B	1118 Network Performance EnhancementsConcerning Volatile Variables	March 27, 2014
2.4B	1115Clarification on the usage of XMM/FPU instructions from within a UEFI Runtime Service on an x64 processor	March 27, 2014
2.4B	1111 Errors in DisconnectController() returnCode descriptions	March 27, 2014
2.4B	1101 Errata – ReinstallProtocolInterface	March 27, 2014
2.4B	1092Clarification to PCI Option ROM Driver Loading Description	March 27, 2014
2.4B	1085 Error--added in missing text approved for 2.4A	April 17, 2014
2.4B	1014 HIIConfig Access Protocol Errata	April 3, 2014
2.4 A	1089 Short-termCPER Memory Section errata	Nov. 14, 2013
2.4 A	1088 Add revision #define to EFI_FILE_PROTOCOL	Nov. 6, 2013
2.4 A	1085 Issues with Interactive password	Nov.14, 2013
2.4 A	1082 Mistake in 2.3.5.1 / 2.3.6.2 Handoff State	Nov. 6, 2013
2.4 A	1081 Update Install Table protocol to deal with duplicate tables	Nov. 6, 2013
2.4 A	1079 UEFI 2.4: Remove repetitive "the" (typo)	Nov. 6, 2013
2.4 A	1078 Adjust some text for handling EFI_BROWSER_ACTION_CHANGING	Nov. 6, 2013
2.4 A	1077 Fix wording in EVT_SIGNAL_EXIT_BOOT_SERVICES	Nov. 6, 2013
2.4 A	1076 typo in UEFI v2.3.1d and v2.4	Nov. 6, 2013
2.4 A	1075Clarifications to Table 88. Device Node Table (Device Node to TextConversion)	Nov. 6, 2013
2.4 A	1074 AddClarifications on DMA requirements for PCI_IO	Nov. 6, 2013
2.4 A	1073 Add requirement for EFI_USB_IO_PROTOCOL	Nov. 6, 2013
2.4 A	1066 Errata - ISCSI IPV6 Root PathClarification	Nov. 6, 2013
2.4 A	1064 AIP Errata	Nov. 6, 2013

## Unified Extensible Firmware Interface Specification

Revision	Mantis Number / Description	Date
2.4 A	1063 Correction to GPT expression for SizeofPartitionEntry	Nov. 6, 2013
2.4 A	1062 EFI_CERT_X509_GUID does not specify theCertificate encoding	Nov. 6, 2013
2.4 A	1061 UEFI 2.4 section 2.6.2 and 2.6.3 don't use protocol hyperlinksConsistently	Nov. 6, 2013
2.4 A	1060 SlightClarification to FMP Authentication Requirments	Nov. 6, 2013
2.4 A	1059 Clarification of a return statusCode of HASH protocol	Nov. 6, 2013
2.4 A	1058 Correct mistake in the system table revision	Nov. 6, 2013
2.4 A	1056 text modification to definition of EFI_FIRMWARE_IMAGE_DESCRIPTOR_VERSION 2	Nov. 6, 2013
2.4 A	1055 Disk IO 2 errata	Nov. 6, 2013
2.4 A	1054 Deprecate 6 Hash Algorithms with inconsistent usage	Nov. 6, 2013
2.4 A	1053 Reduce Name space ofCapsule Result variable to increase performance	Nov. 6, 2013
2.4 A	1035 PCI Option ROM Errata (five figures)	Nov. 6, 2013
2.4	997 Driver Health Protocol errorCodes	April 25, 2013
2.4	993 (original ticket--supersededBy 1026)	
2.4	992 Adapter Information Protocol (AIP)	April 25, 2013
2.4	991 Greater than 256 NICs support on UNDI	April 25, 2013
2.4	968 Hii Forms op-code for displaying a warning message	April 25, 2013
2.4	966 Spec typos	April 25, 2013
2.4	964 Disk IO 2 Protocol to support Async IO	April 25, 2013
2.4	963 Add new device path node NVM Express devices	April 25, 2013
2.4	956 Require network drivers to return EFI_NO_MEDIA	April 25, 2013
2.4	946 ForbidCreation of non-spec variables in EFI_GLOBAL_VARIABLE namespace	April 25, 2013
2.4	920 Add a variable for indicating out ofBand key modification	April 25, 2013
2.4	905 Need more granularity in EFI_RESET_TYPE to support platform specific resets	April 25, 2013
2.4	1052 UEFI 2.4 Draft April 25th -Corrections to ARM sections	May 16, 2013
2.4	1050 2.4 Draft April 25 has missing text for ECR 1009	May 16, 2013
2.4	1049 2.4 Draft April 25 has missing text for ECR 1008	May 16, 2013
2.4	1048 Comment against UEFI 2.4 - NVMe related	May 16, 2013
2.4	1047 Comment on Feb 25th draft - fix alignment issue	May 16, 2013
2.4	1045 PCI OpROM Device ListChanges to section 14.2	June 28, 2013
2.4	1044 Corrections to Mantis 1015, Interruptible driver diagnostics	May 16, 2013
2.4	1037 Add 2.4 to the system table version	May 16, 2013
2.4	1036 Comments on April 25 Draft	May 16, 2013
2.4	1033 HiiConfigAccess->ExtractConfig StatusCodes Errata	May 16, 2013
2.4	1032 HiiConfigRouting->ExtractConfig StatusCodes Errata	May 16, 2013
2.4	1031 NVMe subtypeConflict errata	April 25, 2013

Revision	Mantis Number / Description	Date
2.4	1029 Method for delivery ofCapsule on disk; Method for reportingCapsule processing status	April 25, 2013
2.4	1026 (supersedes 993) Update to the AArch64 proposedBindingChange	April 25, 2013
2.4	1024Clarification to the NVMe Device Path text descriptions	April 25, 2013
2.4	1023 Definition ofCapsule format to deliver update image to firmware management protocol	April 25, 2013
2.4	1022 adapter information protocol for NIC iSCSI and FCoEBootCapabilities andCurrentBoot Mode.	April 25, 2013
2.4	1017 AIP Instance - FCOE SAN MAC Address	April 25, 2013
2.4	1016 AIP Instance - Image Update	April 25, 2013
2.4	1015 Interruptible driver diagnostics	April 25, 2013
2.4	1009 Enable hashes ofCertificates toBe used for revocation, and timestamp support	April 25, 2013
2.4	1008 New Random Number Generator / Entropy Protocol	April 25, 2013
2.4	1007Create a new Security Technologies section to avoidBlurring with SecureBoot	April 25, 2013
2.4	1002 Timestamp Protocol	April 25, 2013
2.3.1D	996 UEFI 2.0 version number still in the 2.3.1C spec	April 3, 2013
2.3.1D	995CSA linkChange	April 3, 2013
2.3.1D	994 Spec typos	April 3, 2013
2.3.1D	990 EFI_ATA_PASS_THRU need oneClarification if it supports ATAPI device	April 3, 2013
2.3.1D	989Clarify hot-remove responsibility of aBus Driver	April 3, 2013
2.3.1D	988 EFI_BLOCK_IO2_PROTOCOLBlocksChild from stopping while doing non-blocking I/O	April 3, 2013
2.3.1D	987 EFI_BLOCK_IO2_PROTOCOL has aCopy pasteBug describing the Token Parameter	April 3, 2013
2.3.1D	980 Errata on SNP Media detect	April 3, 2013
2.3.1D	978 Error Retun IndicatesCapsule requiresBoot Services	April 3, 2013
2.3.1D	977 missing statement	April 3, 2013
2.3.1D	976BrowserCallback text update to description	April 3, 2013
2.3.1D	975 UNDI errata to add missing memory type definitions	April 3, 2013
2.3.1D	974 UNDI IncorrectCPB function names ECR	April 3, 2013
2.3.1D	973 UNDI Mem_Map()Clarification	April 3, 2013
2.3.1D	972 ISCSI DHCP6Boot	April 3, 2013
2.3.1D	971 typo	April 3, 2013
2.3.1D	970 Typo section 28.3.8.3.41 EFI_IFR_MODAL_TAG	April 3, 2013
2.3.1D	965 File IO Async extenstion	April 3, 2013
2.3.1D	962 Remove 2.3 table revision number	April 3, 2013
2.3.1D	960 Typo in netboot6 description	April 3, 2013
2.3.1D	959 InstallAcpiTable() does not say what to do when an attempt is made to install a duplicate table	April 3, 2013

## Unified Extensible Firmware Interface Specification

Revision	Mantis Number / Description	Date
2.3.1D	955 Clearing The Platform Key Errata	April 3, 2013
2.3.1D	954 LoadImage Errata	April 3, 2013
2.3.1D	953 Need text definitions for Device Path Media Type Subtype 6/7	April 3, 2013
2.3.1D	952 Clarification of requirements to update timestamp associated with authenticated variable	April 3, 2013
2.3.1D	950 Indeterminate Behavior for attribute modifications may Cause security issues	April 3, 2013
2.3.1D	949 PCI IO.GetBarAttributes needs adjustment - - Address Space Granularity field	April 3, 2013
2.3.1D	944 Errata - Replace RFC reference	April 3, 2013
2.3.1D	943 Errata - Proposed updates to required interfaces in Chapter 2.6	April 3, 2013
2.3.1D	942 ExportConfig() description does not make sense	April 3, 2013
2.3.1D	941 Add OEM StatusCode ranges to EFI StatusCode Ranges Table	April 3, 2013
2.3.1D	938 InstallMultipleProtocolInterface() is missing StatusCode Returned values	April 3, 2013
2.3.1D	935 Clarify Chaining requirements with regards to the Platform Key	April 3, 2013
2.3.1D	934 Missing Figures and typos	April 3, 2013
2.3.1D	930 Clarify usage of EFI Variable Varstores in HII	April 3, 2013
2.3.1D	928 Best Matching Language algorithm	April 3, 2013
2.3.1D	926 UEFI Image Verification Clarification	April 3, 2013
2.3.1D	924 New ErrorCode to handle reporting of IPV4 duplicate address detection	April 3, 2013
2.3.1D	1021 ATA_PASS_THRU on ATAPI device handle.	April 3, 2013
2.3.1D	1020 Clarify HII variable store definitions.	April 3, 2013
2.3.1D	1019 Alignment Requirements Clarification	April 3, 2013
2.3.1D	1018 HII Font Errata	April 3, 2013
2.3.1D	1013 HII Errata	April 3, 2013
2.3.1D	1012 Touchup to text of GPT	April 3, 2013
2.3.1D	1011 Typo regarding Debug Port in UEFI Spec	April 3, 2013
2.3.1D	1003 Missing "(" in section 11.7	April 3, 2013
2.3.1D	1000 Clarification to the IFR_REF4 opcode	April 3, 2013
2.3.1C	921 Length of IPv6 Device Path is incorrect	June 13, 2012
2.3.1C	917 UNDI drive does not need to be initialized as runtime driver	June 13, 2012
2.3.1C	915 For x64, Change Floating Point Default Configuration to Double-Extended Precision	June 13, 2012
2.3.1C	914 Error Descriptor Reset Flag Clarification	June 13, 2012
2.3.1C	913 Enum definition does not match what our current compilers implement.	June 13, 2012
2.3.1C	912 UEFI 2.3.1 Type	June 13, 2012
2.3.1C	909 Update to return Codes for AllocatePool / AllocatePages	June 13, 2012
2.3.1C	907 iSCSI Device Path error	June 13, 2012
2.3.1C	882 Indications Variable - OS/FW feature & Capability Communication	June 13, 2012
2.3.1C	882 Indications Variable - OS/FW feature & Capability Communication	June 13, 2012



Revision	Mantis Number / Description	Date
2.3.1C	874 Provide a mechanism for providing keys in setup mode	June 13, 2012
2.3.1C	831 PXEBootCSA Type definitionCleanup	June 13, 2012
2.3.1B	896 StartImage andConnectController returnCodes	April 10, 2012
2.3.1B	893 SMMCommunication ACPI Table Update	April 10, 2012
2.3.1B	891Component Name Protocol References	April 10, 2012
2.3.1B	890 DriveConfiguration Protocol Phantom.	April 10, 2012
2.3.1B	888 typo in EFI_USB_HC Protocol	April 10, 2012
2.3.1B	887 union is declared twice in same section	April 10, 2012
2.3.1B	885 Errata in the GPT Table structureComment	April 10, 2012
2.3.1B	884 EFI_BOOT_KEY_DATA relies on implementation-definedBehavior	April 10, 2012
2.3.1B	881 netboot6 - multicast versus unicast	April 10, 2012
2.3.1B	880 netboot6Clarification/errata	April 10, 2012
2.3.1B	879 Reference to unsupported specification in SCSIChapter (14.1)	April 10, 2012
2.3.1B	878 Updated HII "Selected Form"Behaviors to Reflect NewCallback Results	April 10, 2012
2.3.1B	877 TableChecksum updateBy the ACPI_TABLE_PROTOCOL.InstallAcpiTable	April 10, 2012
2.3.1B	876 ToClarify EDID_OVERRIDE attribute definitions and expected operations	April 10, 2012
2.3.1B	873 Section 9.3.7 incorrectly assumes that all uses ofBBS device paths are non-UEFI	April 10, 2012
2.3.1B	872Change to SIMPLE_TEXT_INPUT_EX_PROTOCOL.RegisterKeyNotify/UnregisterKeyNotify	April 10, 2012
2.3.1B	871 Typo in InstallMultipleProtocolInterfaces	April 10, 2012
2.3.1B	870Clarify FrameBufferSize definition under EFI_GRAPHICS_OUTPUT_PROTOCOL_MODE struct	April 10, 2012
2.3.1B	869 Reference to FIPS 180 inChapter 27.3 is obsolete and incorrect	April 10, 2012
2.3.1B	867Clarify requirment for use of EFI_HASH_SERVICE_BINDING_PROTOCOL	April 10, 2012
2.3.1B	866 PK, KEK, db, dbx relationsClarification	April 10, 2012
2.3.1B	865 Modify Protective MBRBootIndicator definition	April 10, 2012
2.3.1B	864 Typo in Question-Level Validation section	April 10, 2012
2.3.1B	863 Attributes of the Globally Defined Variables	April 10, 2012
2.3.1B	862 User identity typo	April 10, 2012
2.3.1B	861 Globally Defined Variables Errata	April 10, 2012
2.3.1B	858 Superfluous and incorrect image hash description	April 10, 2012
2.3.1B	857 Absolute pointer typo	April 10, 2012
2.3.1B	855Clarification of UEFI driver signing/Code definitions	April 10, 2012
2.3.1B	853 The EFI_HASH_PROTOCOL.Hash() description needsClarification on padding responsibilities	April 10, 2012
2.3.1B	852 Various EFI_IFR_REFRESH_ID errata.	April 10, 2012
2.3.1B	851 For EFI_IFR_REFRESH opcode,Clarify RefreshInterval = 0 means no auto-refresh.	April 10, 2012
2.3.1B	850Clarification of responsibility for array allocation in EFI_HASH_PROTOCOL	April 10, 2012

## Unified Extensible Firmware Interface Specification

Revision	Mantis Number / Description	Date
2.3.1B	849 IFR EFI_IFR_MODAL_TAG_OP is also valid under EFI_IFR_FORM_MAP_OP	April 10, 2012
2.3.1B	848 Clarification of semantics of SecureBoot variable	April 10, 2012
2.3.1B	847 When enrolling a PK, the platform shall not require a reboot to leave SetupMode	April 10, 2012
2.3.1B	845 EFI_SCSI_PASS_THRU_PROTOCOL replacement	April 10, 2012
2.3.1B	842 Text to explain how the UEFI revision is referred	April 10, 2012
2.3.1B	836 Structure Comment for EFI_IFR_TYPE_VALUE references unknown value type.	April 10, 2012
2.3.1B	828 Network Driver Options	April 10, 2012
2.3.1B	826 Comments against Mantis 790	April 10, 2012
2.3.1B	825 DMTF SMCLP errata	April 10, 2012
2.3.1B	819 Mantis 715 was not fully implemented	April 10, 2012
2.3.1B	812 Errata – GUID-UUID usage	April 10, 2012
2.3.1B	809 Errata – Messaging Device Path Clarification	April 10, 2012
2.3.1B	808 Errata – Boot File URL	April 10, 2012
2.3.1B	807 Give specific TPL rules to Stall() Boot services	April 10, 2012
2.3.1B	771 SHA1 and MD5 references	April 10, 2012
2.3.1A	Minor Corrections in toes to tickets 772, 785, 794, 804, also formatting Correction for _WIN_CERTIFICATE_UEFI_GUID typedef's parameters	September 7, 2011
2.3.1A	820 Driver Health Needs to have Mantis 0000169 implemented	August 17, 2011
2.3.1A	819 ECR715 was not fully implemented	August 17, 2011
2.3.1A	806 Text update to Driver Health Description -Clarify role of user interaction	August 17, 2011
2.3.1A	805 Correct Wrong Palette Information in 28.3.7.2.3 example	August 17, 2011
2.3.1A	804 Clarify Constraints and alternatives when enrolling PK, KeK, db or dbx keys	August 17, 2011
2.3.1A	803 Fix AcpiExp device node text description.	August 17, 2011
2.3.1A	801 Clarify IFR Opcode Summary and Description #4	August 17, 2011
2.3.1A	800 Clarify IFR Opcode Summary and Description #3	August 17, 2011
2.3.1A	797 Clarify IFR Opcode Summary and Description #2	August 17, 2011
2.3.1A	796 Clarify IFR Opcode Summary and Description #1	August 17, 2011
2.3.1A	795 Typo in ReadKeyStrokeEx()	August 17, 2011
2.3.1A	794 Incomplete text describing Clearing of Platform Key	August 17, 2011
2.3.1A	793 Inconsistent wording about RemainingDevicePath	August 17, 2011
2.3.1A	790 Add warning to ReadKeyStrokeEx for partial key press	August 17, 2011
2.3.1A	789 Clarify HII opcode definition	August 17, 2011
2.3.1A	788 SasEx entry in Table 86-Device Node Table Contains optional Reserved entry that does not exist in device path	August 17, 2011
2.3.1A	786 PCI I/O Dual AddressCycle attribute Clarification	August 17, 2011
2.3.1A	785 Allowing more general use of UEFI 2.3.1 Variable time-based authentication	August 17, 2011
2.3.1A	780 Errata in returnCode descriptions	August 17, 2011

Revision	Mantis Number / Description	Date
2.3.1A	778 EFI_HII_CONFIG_ACCESS_PROTOCOL.Callback() Errata	August 17, 2011
2.3.1A	777 Specified signature sizes incorrect in Section 27.6.1	August 17, 2011
2.3.1A	776 Clarify computation of EFI_VARIABLE_AUTHENTICATION_2 hash value	August 17, 2011
2.3.1A	774 Define EFI_BLOCK_IO_PROTOCOL_REVISION3	August 17, 2011
2.3.1A	773 Clarify the value for opcode EFI_IFR_REFRESH_ID_OP	August 17, 2011
2.3.1A	772 Definition of EFI_IMAGE_SECURITY_DATABASE_GUID incorrect	August 17, 2011
2.3.1A	770 Remove references to UEFI 2.1 spec	August 17, 2011
2.3.1A	767 The ReadBlocks function for BlockIO and BlockIO2 need synchronization	August 17, 2011
2.3.1A	212 (revisit) final sentence section 28.2.15 missing final words.	April 21, 2011
2.3.1	765 ECR to limit the hash and encryption algorithms used with PKCS Certificates	April 5, 2011
2.3.1	762 DevicePath in the Image Execution Information Table.	April 5, 2011
2.3.1	761 Table 195. Information for Types of Storage	April 5, 2011
2.3.1	760 Suggested Changes to 2.3.1 final draft spec	April 5, 2011
2.3.1	759 UEFI Errata - wincerts for rest of hash algorithms	April 5, 2011
2.3.1	755 Errata in Legacy MBR table and Legacy MBR GUID	April 5, 2011
2.3.1	754 USB timeout parameter mismatch.	April 5, 2011
2.3.1	751 Fix USB HC2 erroneous references to IsSlowDevice	March 11, 2011
2.3.1	750 Fix section 27.2.5 "related definitions" re: RSA public key exponent	March 11, 2011
2.3.1	749 Fix Table 10 (Global Variables) With Correct Attributes	March 11, 2011
2.3.1	748 Clarify Standard GUID Text Representation	March 11, 2011
2.3.1	744 ProcessorContext information structure definition not Clear	March 11, 2011
2.3.1	741 Errata: Corrected text for section 7.2.1.4 step 7	March 11, 2011
2.3.1	740 Errata: signatureheadersize inconsistency Corrections	April 6, 2011
2.3.1	736 Insert SMM Communication ACPI Table and related data structures to the UEFI Specification	April 5, 2011
2.3.1	735 Clarification on Tape Header Format	March 11, 2011
2.3.1	734 SecureBoot variable	April 5, 2011
2.3.1	733 Errata: 27.6.1 signatureheadersize definition	March 11, 2011
2.3.1	732 Amendment to Mantis 711: section 7.2.1.6	March 11, 2011
2.3.1	729 Errata: Clarification of Microsoft references in appendix Q	March 11, 2011
2.3.1	728 Netboot 6 errata - DUID-UUID	March 11, 2011
2.3.1	727 Errata on returnCode for User Info Identity policy record	March 11, 2011
2.3.1	726 Errata/clean-up of EFI_DHCP4_TRANSMIT_RECEIVE_TOKEN definition	March 11, 2011
2.3.1	724 SetVariable Update 2	March 11, 2011
2.3.1	723 User Identification (UID) Errata – EFI User Manager Notify & Enroll Clarification	April 5, 2011
2.3.1	722 User Identification (UID) Errata – Credential Provider Enroll Clarification	April 5, 2011
2.3.1	721 User Identification (UID) Errata – SetInfo Clarification	March 11, 2011
2.3.1	720 User Identification (UID) Errata – Credential Provider Enroll Clarification	March 11, 2011

## Unified Extensible Firmware Interface Specification

Revision	Mantis Number / Description	Date
2.3.1	716 EFI_EXT_SCSI_PASS_THRU_PROTOCOL.GetNextTarget() IN OUT parameter Target input value shallBe 0xFFs	March 11, 2011
2.3.1	715 CPER Record and section field Clarification	March 11, 2011
2.3.1	713 Remove the errata revision from the EFI_IFR_VERSION format.	March 11, 2011
2.3.1	711 SetVariable Update	March 11, 2011
2.3.1	709 NewCallback() Action Requests Related To Individual Forms.	Feb. 3, 2011
2.3.1	708 Errata (non-blocking BLOCK IO)	April 5, 2011
2.3.1	707 Errata revision in the EFI_IFR_VERSION format	Feb. 3, 2011
2.3.1	705 REPC signature definition still Confusing	Feb. 3, 2011
2.3.1	704 Unload() definition is wrong	Feb. 3, 2011
2.3.1	702 Clarifications on Variable Storage for Questions	Feb. 3, 2011
2.3.1	696 Update System Table with this new #define for EFI_SYSTEM_TABLE_REVISION	Feb. 3, 2011
2.3.1	695 Add Port Ownership probing	Feb. 3, 2011
2.3.1	687 Update System Table with this new #define for 2.3.1	Jan. 17, 2011
2.3.1	686 HII - Clarify FormsBrowser 'standard' user interactions.	Feb. 3, 2011
2.3.1	685 HII - New op-code to enable event initiated refresh of BrowserContext data	Feb. 3, 2011
2.3.1	682 [UCST] Modal Form	Feb. 3, 2011
2.3.1	681 Typo: Pg. 56	Jan. 17, 2011
2.3.1	680 Netboot6 handle Clarification	Jan. 17, 2011
2.3.1	679 UEFI Authenticated Variable & Signature Database Updates	Jan. 17, 2011
2.3.1	678 Section 27.6.2: Imagehash reference needs toBe removed	Jan. 17, 2011
2.3.1	677 Section 27.2.5 & 27.6.1: Typo in X509 Signature Type	Jan. 17, 2011
2.3.1	674 Section 3.2: Missing variable type for SetupMode variable	Jan. 17, 2011
2.3.1	671 Errata: USB device path example is incorrect	Jan. 17, 2011
2.3.1	668 LUN implementations are not Consistent	Feb. 3, 2011
2.3.1	661 USB 3.0 Updates	Oct. 29, 2010
2.3.1	645 Non-blocking interface for BLOCK oriented devices (BLOCK_IO_EX transition to BLOCK_IO_2)	Oct. 29, 2010
2.3.1	634 FormsBrowser DefaultBehavior	Jan. 17, 2011
2.3.1	634 FormsBrowser DefaultBehavior	Oct. 29, 2010
2.3.1	616 Security Protocol Command to support encrypted HDD	Jan. 17, 2011
2.3.1	616 Security Protocol Command to support encrypted HDD	Oct. 29, 2010
2.3.1	612 UEFI system Partition FAT32 data Region Alignment	Oct. 29, 2010
2.3.1	484 Key Management Service Protocol	Oct. 28, 2010
2.3.1	484 Key Management Service (KMS) Protocol	Oct. 29, 2010
2.3.1	478 (REVISIT) Update to ALTCFG references	March 11, 2011
2.3 D	667 Clarification to the UEFI Configuration Table definition	Oct. 28, 2010

Revision	Mantis Number / Description	Date
2.3 D	664 Appendix update for IPV6 networkBoot	Oct. 28, 2010
2.3 D	663 Update ARM PlatformBinding to allow OS loader to assume unaligned access support is enabled	Nov. 10, 2010
2.3 D	662 ARM ABI errata	Oct. 28, 2010
2.3 D	659Clarify section length definition in the error record	Oct. 28, 2010
2.3 D	653 Errata to the Appendix N (Common Platform Error Record)	Oct. 28, 2010
2.3 D	652Clarification to the TimeZone value usage	Oct. 28, 2010
2.3 D	651 update to IPSec for tunnel mode support	Oct. 28, 2010
2.3 D	650 networking support errata	Oct. 28, 2010
2.3 D	638 Add facility for dynamic IFR dynamicCross-references	Oct. 28, 2010
2.3 D	538 IPV6 PXE	Oct. 28, 2010
2.3C	640 String ReferenceCleanup	July 14, 2010
2.3C	639Callback() does not describe FORM_OPEN/FORM_CLOSEBehavior	July 14, 2010
2.3C	637Clarification for Date/Time Question usage in IFR expressions.	July 14, 2010
2.3C	636 Mistaken Reference to "Date" inside ofBoolean question description	July 14, 2010
2.3C	635 Missing GUID label forConfig Access protocol	July 14, 2010
2.3C	633 Explicitly Specify ACPI Table Signature Format	July 14, 2010
2.3C	632ClarifyBlock IO ReadBlocks and WriteBlocks functions handling of media stateChange events	July 14, 2010
2.3C	625 Minor typo in surrogateCharacter description section	July 14, 2010
2.3C	622 Identify() function errata	July 14, 2010
2.3C	621 Typos in an EFI_HII_CONFIG_ACCESS_PROTOCOL.Callback() member	July 14, 2010
2.3C	620Carification of need for Path MTU support for IPV4 and IPV6	July 14, 2010
2.3C	613 PAUSE Key	July 14, 2010
2.3C	611 LanguageCorrection requested for InstallProtocolInterface() and InstallConfigurationTable(), Ref# 583	July 14, 2010
2.3C	610 RSA data structureClarification	July 14, 2010
2.3C	609 StartImage returnCode update	July 14, 2010
2.3C	583 How do we know an EFI_HANDLE is Valid/Invalid	July 14, 2010
2.3C	508 Update networking references, incl ipv6	July 14, 2010
2.3B	608 more media detectClean-up	Feb. 24, 2010
2.3B	605Clarify user identity Find API	Feb. 24, 2010
2.3B	601 UNDI update as part of media detectChanges	Feb. 24, 2010
2.3B	600 Update toConfigAccess/ConfigRouting	Feb. 24, 2010
2.3B	598 ARP is only an IPV4Concept.	Feb. 24, 2010
2.3B	590 Media detectClean-up	Feb. 24, 2010

## Unified Extensible Firmware Interface Specification

Revision	Mantis Number / Description	Date
2.3B	589 Device path representation of IPv4/v6 text	Feb. 24, 2010
2.3B	588 UEFI User Identity - ReturnCodes	Feb. 24, 2010
2.3B	587 UEFI User Identity - NamingConsistency	Feb. 24, 2010
2.3B	586 Clarification of PXE2.1 specification for IPV4 interoperability issues	Feb. 24, 2010
2.3B	585 Errata to EFI_IFR_SET op-code	Feb. 24, 2010
2.3B	584 EFI_PXE_BASE_CODE_DHCPV6_PACKET missing for pxeBc protocol	Feb. 24, 2010
2.3B	583 How do we know an EFI_HANDLE is Valid/Invalid	Feb. 24, 2010
2.3B	580 ACPI_SUPPORT_PROTOCOL Clarifications related to FADT and the DSDT/FACS	Dec. 15, 2009
2.3B	578 ATA Passthrough updates / questions	Dec. 15, 2009
2.3B	577 Clarifications on the user identity protocol	Dec. 15, 2009
2.3B	576 Clarifications in the Routing Protocol	Dec. 15, 2009
2.3B	575 Machine hand-off/MP state modification	Feb. 24, 2010
2.3B	574 Add an "OPTIONAL" tag to a parameter in NewPackageList	Dec. 15, 2009
2.3B	573 EFI_DESCRIPTION_STRING and EFI_DESCRIPTION_BUNDLE adjustments	Feb. 24, 2010
2.3B	572 EFI_IFR_SECURITY should be EFI_IFR_SECURITY_OP in Table 194	Dec. 15, 2009
2.3B	568 ATA_STATUS_BLOCK name errata	Dec. 15, 2009
2.3B	567 Various miscellaneous typos/updates	Feb. 24, 2010
2.3B	566 Minor update to HII->NewString function description	Dec. 15, 2009
2.3B	560 Correct erroneous example in ExtractConfig()	Dec. 15, 2009
2.3B	559 Extraneous "default" tag in EFI_IFR_SECURITY grammar	Dec. 15, 2009
2.3B	558 Clarify VLAN Config publication requirements	Dec. 15, 2009
2.3B	557 Corrected Image Execution Information omission & ambiguity	Dec. 15, 2009
2.3B	556 additional IPsec errata/issues	Dec. 15, 2009
2.3B	549 Binary prefix change	Dec. 15, 2009
2.3B	547 Clean-Up In HII Sections	Dec. 15, 2009
2.3B	546 typo in GOP definition	Dec. 15, 2009
2.3B	545 Action parameter of the EFI_HII_CONFIG_ACCESS_PROTOCOL.CallBack()	Dec. 15, 2009
2.3B	542 Device Path Description Changes	Dec. 15, 2009
2.3B	540 Register name usage	Dec. 15, 2009
2.3B	539 CHAP node fix for iSCSI	Dec. 15, 2009
2.3B	537 Add missing ACPI ADR Device Path Representation	Dec. 15, 2009
2.3B	536 IPsec errata	Dec. 15, 2009
2.3B	534 Size of Partition Entry restriction	Dec. 15, 2009
2.3B	533 GPT editorial cleanup	Dec. 15, 2009
2.3B	532 "Legacy BIOS Bootable" GPT attribute	Dec. 15, 2009
2.3B	531 Clarify HII Variable Storage	Dec. 15, 2009
2.3B	519 Add Console table (chapt 11) for EFI_SIMPLE_TEXT_INPUT_EX_PROTOCOL	Dec. 15, 2009

Revision	Mantis Number / Description	Date
2.3B	518 Typos in the UEFI2.3 specification	Feb. 24, 2010
2.3B	515 Authenticated Variables Clarification	Feb. 24, 2010
2.3B	514 HII Configuration String Syntax Clarification	Feb. 24, 2010
2.3B	507 Clarify ACPI Protocol's position on Checksums	Dec. 15, 2009
2.3B	479 TPM guideline added to section 2.6.2	Dec. 15, 2009
2.3B	476 Text adjustment to ConfigAccess & ConfigRouting	Dec. 15, 2009
2.3B	460 Section 2.6 language Change	Dec. 15, 2009
2.3B	454 Dynamic support of media detection - network stack	Dec. 15, 2009
2.3B	431 UEFI 2.3 Feb Draft: Section 30.4	Feb. 24, 2010
2.3B	301 Errata to the Authentication Protocol	Dec. 15, 2009
2.3B	215 previously added to Device Driver (wrong), now BusDriver (correct)	Dec. 15, 2009
2.3A	522 Bugs in EFI_CERT_BLOCK_RSA_2048_SHA256, iSCSI device path, CHAP device path	Sept 15, 2009
2.3A	518 typos	Sept 15, 2009
2.3A	517 IP stack related protocol update	Sept 15, 2009
2.3A	516 User Identity Protocol Bugs	Sept 15, 2009
2.3A	513 add support for gateways in ipv4 & ipv6 device path nodes	Sept 15, 2009
2.3A	506 TCP6/MTFTP6 StatusCode Definition	Sept 15, 2009
2.3A	505 TCP4/MTFTP4 statusCodeS	Sept 15, 2009
2.3A	490 Correction 28.2.5.6, Table 185. Information for Types of Storage	Sept 15, 2009
2.3A	478 Update to ALTCFG references	Sept 15, 2009
2.3A	477 Text adjustment to ConfigAccess/ConfigRouting	Sept 15, 2009
2.3	463 Update EFI_IP6_PROTOCOL.Neighbors() API	May 7, 2009
2.3	462 ExitBootServices timers deactivation	May 7, 2009
2.3	461 IP4 Mode Data definition update	May 7, 2009
2.3	460 Chapter 2.6 language update	May 7, 2009
2.3	457 Change KeyData.PackedValue to 0x40000200, page 63.	May 7, 2009
2.3	456 How to handle PXEBoot w/o NII Section 21.3	May 7, 2009
2.3	454 Dynamic support of media detection - network stack	May 7, 2009
2.3	453 Errata to support dynamic media detection - UNDI	May 7, 2009
2.3	452 Support to dynamically detect media errata - SNP	May 7, 2009
2.3	450 Missing opcode headers and formatting, section 28.3.8.3.x.	May 7, 2009
2.3	449 Add missing EFI_IFR_GET, EFI_IFR_SET and EFI_IFR_MAP to the syntax. Section 28.2.5.7.	May 7, 2009
2.3	448 Section 28.2.5.4 Questions, Syntax, Update question-option-tag; Add EFI_IFR_READ and EFI_IFR_WRITE in the question syntax.	May 7, 2009

## Unified Extensible Firmware Interface Specification

Revision	Mantis Number / Description	Date
2.3	447 Section 28.2.5.11.2 Moving Forms, Update line that starts with EFI_IFR_FORM to: EFI_IFR_FORM or EFI_IFR_FORM_MAP (and all references in EFI_IFR_REF)	May 7, 2009
2.3	446 Section 28.2.5.2 Forms, Syntax, Change 3rd line to: form := EFI_IFR_FORM form-tag-list   EFI_IFR_FORM_MAP form-tag-list	May 7, 2009
2.3	445 Table 194: EFI_IFR_FORM_MAP_OP, 2ndColumn shouldBe 0x5d (not 05xd)	May 7, 2009
2.3	444 Form Set Syntax: Section 28.2.5.1.1, section shouldBe subheading, not heading level 5; Section 28.2.5.1, Syntax, line 3, text after := is not aligned with other text on line 2, 4	May 7, 2009
2.3	443 Section 28.3.8.3.38, EFI_IFR_MAP, Prototype, line 4, outdent 2 spaces.	May 7, 2009
2.3	442 Section 28.3.8.3.64, EFI_IFR_SET, Prototype, lines 3-8, indentBy 2 spaces	May 7, 2009
2.3	440 Change the defined type of EFI_STATUs from INTN to UINTN	May 7, 2009
2.3	439 Incorrect definitions of UEFI_CONFIG_LANG and UEFI_CONFIG_LANG_2 in UEFI 2.3 Feb18 draft	Feb 25, 2009
2.3	438 UEFI 2.3 Feb 13 Draft: Chapter 28 Formatting Issues	Feb 18, 2009
2.3	437 Errata to 2.3 draft material from UEFI Spec 2_3_Draft_Jan29	Feb 18, 2009
2.3	436 UEFI 2.3 split Figure 88 into 3 figures	Feb. 12, 2009
2.3	435 Partition Signature Clarification	Feb. 12, 2009
2.3	434 UEFI 2.3 Feb Draft: 28.3.8.3.58	Feb. 12, 2009
2.3	432 UEFI 2.3 Feb Draft: Appendix M.	Feb. 12, 2009
2.3	431 UEFI 2.3 Feb Draft: Section 30.4	Feb. 12, 2009
2.3	418 Change Appendix O from "UEFI ACPI Table" to "UEFI ACPI Data"	Feb 18, 2009
2.3	413 Correct the definition of UEFI_CONFIG_LANG	Feb 18, 2009
2.3	410 UNDI Buffer usage	Feb 18, 2009
2.3	408 ARM Binding Corrections	Feb. 12, 2009
2.3	406 Missing EFI System Table Revision In UEFI 2.3 Draft	Feb. 12, 2009
2.3	395 New "Non-removable Media Boot Behavior" section	Feb. 12, 2009
2.3	394 Omission in EFI_USB2_HC_PROTOCOL	Feb. 12, 2009
2.3	388 Add HII Callback types (FORM_OPEN, FORM_CLOSE) when a form is opened or closed.	Feb. 12, 2009
2.3	376 Add ARM processor Binding to UEFI	Jan. 12, 2009
2.3	326 Add Firmware Management Protocol	Feb. 12, 2009
2.2A	429 EFI_HASH_SERVICE_BINDING_PROTOCOL GUID define misses _GUID	Feb. 12, 2009
2.2A	404 Remove Constraint form EFI_TIME.YearComment	Feb. 12, 2009
2.2A	400 FreePool() description error	Feb. 12, 2009
2.2A	393 UEFI 2.1/2.2 Boot Manager Behavior Clarification	Feb. 12, 2009
2.2A	392 MBR errata in UEFI 2.2	Feb. 12, 2009
2.2A	391 Polarity of INCONSISTENT_IF and NO_SUBMIT_IF IFR opcodes wrong	Feb. 12, 2009
2.2A	390 UEFI 2.2 Miscellaneous HII-related errata	Feb. 12, 2009



Revision	Mantis Number / Description	Date
2.2A	389 UEFI 2.2 HII-Related Formatting Issues	Feb. 12, 2009
2.2A	387 UEFI 2.1/UEFI 2.2A (ch. 12)	Feb. 12, 2009
2.2A	384 Fix HII package description omission.	Feb. 12, 2009
2.2A	379 UEFI 2.1/UEFI 2.2 HII-Related Errata	Feb. 12, 2009
2.2A	378 UEFI 2.1 & UEFI 2.2 HII Callback Clarifications	Feb. 12, 2009
2.2A	377 Missing BLT Buffer figure.	Feb. 12, 2009
2.2A	375 Extra periods errata in UEFI 2.2	Feb. 12, 2009
2.2A	374 UEFI 2.1 & UEFI 2.2A (10.7-10.10)	Feb. 12, 2009
2.2A	373 UEFI 2.2, Chs. 9.5 & 9.6.2 & 9.6.3 (Device Path) Errata	Feb. 12, 2009
2.2A	372 UEFI 2.2 remove "Draft for Review"	Feb. 12, 2009
2.2A	371 UEFI 2.1 & UEFI 2.2 Typos (ch. 10)	Feb. 12, 2009
2.2A	370 EFI_SYSTEM_TABLE Errata (UEFI 2.1/UEFI 2.2)	Feb. 12, 2009
2.2A	368 EFI_FONT_DISPLAY_INFO.FontInfo description incorrect	Feb. 12, 2009
2.2A	366 UEFI 2.x: Erroneous references to EFI_BOOT_SERVICES_TABLE, EFI_RUNTIME_SERVICES_TABLE	Feb. 12, 2009
2.2A	364 UEFI 2.2 Typos & Formatting Issues (ch. 9)	Feb. 12, 2009
2.2A	362 UEFI 2.2 Typos (Next)	Feb. 12, 2009
2.2A	361 UEFI 2.2 Typos & Formatting Issues	Feb. 12, 2009
2.2A	359 TPL Table	Feb. 12, 2009
2.2A	358 Missing signature for UEFI 2.2.	Feb. 12, 2009
2.2	398 Update to M348 to fix small typo	Jan. 11, 2009
2.2	397 PCICopyMem() misspelling	Jan. 11, 2009
2.2	394 Omission in EFI_USB2_HC_PROTOCOL	Jan. 11, 2009
2.2	357 Clarify EFI_IFR_DISABLE_IF Behavior with regard to dynamic values	Jan. 11, 2009
2.2	351 Fix an unaligned field in a device path	Jan. 11, 2009
2.2	350 EFI_HII_STRING_PROTOCOL Typos	Jan. 11, 2009
2.2	348 EFI_IFR_RESET_BUTTON is incorrectly listed as a question	Jan. 11, 2009
2.2	347 Replace first paragraph of the "Description" section for the ExitBootServices()	Sept. 25, 2008
2.2	346 Nest, Sections 10.11 & 10.12 Under 10.10	Sept. 25, 2008
2.2	344 Correct missing statusCodes returned section for Form() in EFI_USER_CREDENTIAL_PROTOCOL.	Sept. 25, 2008
2.2	343 Correct missing parameter for User() function in EFI_USER_CREDENTIAL_PROTOCOL	Sept. 25, 2008
2.2	340 UEFI 2.2 Editorial / Formatting Issues	Sept. 25, 2008
2.2	339 Update missing TPL restrictions	Sept. 25, 2008
2.2	337 Replace the EFI_CRYPT_HANDLE reference (in the IPSec API) with a self-contained, independent definition.	Sept. 25, 2008
2.2	335 User Authentication errata	Sept. 25, 2008
2.2	334 Standardized "Unicode" References	Jan. 11, 2009

## Unified Extensible Firmware Interface Specification

Revision	Mantis Number / Description	Date
2.2	333 Correct the incorrect ';' at the end of EFI_GUID #defines	Sept. 25, 2008
2.2	332 Correct SendForm description Type, PackageGuid and FormsetGuid parameters	Sept. 25, 2008
2.2	331 Definition for EFI_BROWSER_ACTION and the related #defines were not present--Insert.	Sept. 25, 2008
2.2	330 EFI_IFR_REF:ChangeCross reference to a question	Sept. 25, 2008
2.2	327 Clarify the support in DHCP4 protocol for "Inform" (DHCPINFORM) messages.	Sept. 25, 2008
2.2	325 MinorCorrection 28.3.8.3.20	July 25, 2008
2.2	324 ATA Pass-Thru ECR Update	July 25, 2008
2.2	323 VLAN modificationBecause of IPV6	July 25, 2008
2.2	322 Chapter 2 updates for IP6 net stack	July 25, 2008
2.2	321 Enable PCIe 2.0 andBeyond support in the UEFI error records	July 25, 2008
2.2	320 Clarification for WIN_CERTIFICATE types & relationship with signature database types	July 25, 2008
2.2	319 UEFI IPsec protocol	July 25, 2008
2.2	315 EFI TCP6 Protocol	July 25, 2008
2.2	314 EFI MTFTP6 Protocol	July 25, 2008
2.2	313 EFI IPv6Configuration Protocol	July 25, 2008
2.2	312 EFI IPv6 Protocol	July 25, 2008
2.2	311 EFI DHCPv6 Protocol	July 25, 2008
2.2	310 EFI UDPv6 Protocol	July 25, 2008
2.2	309 IPv6 Address display formatClarification	July 25, 2008
2.2	306 Some errata to the animation support	July 25, 2008
2.2	304 Errata to UpdateCapsule()	July 25, 2008
2.2	303 Add ability to have aCapsule that initiates a reset & doesn't return to theCaller	July 25, 2008
2.2	301 Errata to the Authentication Protocol	July 25, 2008
2.2	300 MTFTP errata	July 25, 2008
2.2	299 PIWG Firmware File/Firmware Volume Typo Errata	July 25, 2008
2.2	294 LocateDevicePath with multi-instance device path	July 25, 2008
2.2	291 HII Errata / Update	July 25, 2008
2.2	288 Additional wording fixes for GPT Entry AttributeBit 1	July 25, 2008
2.2	282 Updated Requirements Section For ATA Pass Through (M242)	July 25, 2008
2.2	279 Firmware/OS Trusted Key Exchange and Image Validation	July 25, 2008
2.2	242 UEFI ATA Pass-Through Protocol	July 25, 2008
2.2	237 UEFI User Identification Proposal (from USST)	July 25, 2008
2.2	215 new Start() RemainingDevicePath Syntax	July 25, 2008
2.2	212 UEFI HII Standards Mapping	July 25, 2008
2.2	211 UEFI Setup Question / Form Access Update	July 25, 2008

Revision	Mantis Number / Description	Date
2.2	210 UEFI HII Animation addition	July 25, 2008
2.2	202 EAP Management	July 25, 2008
2.2	201EAP	July 25, 2008
2.2	200 VLAN	July 25, 2008
2.2	199 FTP API	July 25, 2008
2.2	198 GUID Partition Entry AttributesClarification and Definition	July 25, 2008
2.2	169 EFI Driver Health Protocol	July 25, 2008
2.2	157 Floating-Point ABIChanges For X86, X64 & Itanium	July 25, 2008
2.1C	Re-format Revision History fromBulleted lists to one row per Mantis ticket/ EngineeringChange Request	June 5, 2008
2.1C	60 iSCSI Device Path Update	June 5, 2008
2.1C	59 Add returnCode to Diagnostics Protocol	June 5, 2008
2.1C	58 Language update for EfiReservedMemory type usage	June 5, 2008
2.1C	57Clarify text for Extended SCSI Pass Thru Protocol.GetNextTargetLun()	June 5, 2008
2.1C	56Clarification on ResetSystem	June 5, 2008
2.1C	55Clarification on UpdateCapsule	June 5, 2008
2.1C	54 ACPI Table Protocol GUID Update	June 5, 2008
2.1C	52 New GUID for Driver Diagnostics and DriverConfiguration Protocols with new GUID	June 5, 2008
2.1C	283 Minor update toClarify a typedef/returnCode in HII	June 5, 2008
2.1C	281 Runtime memory allocation	June 5, 2008
2.1C	280 Some minor errata to keyboard related topics	June 5, 2008
2.1C	278Change references to EFI_SIMPLE_INPUT_PROTOCOL into EFI_SIMPLE_TEXT_INPUT_PROTOCOL	June 5, 2008
2.1C	266 PKCS11.5 structure does notCorrectly specify the portion of theCited RFC that pertains to theCertificate struct/algorithm	June 5, 2008
2.1C	249 Latest update to UCST Errata list	June 5, 2008
2.1C	248Correction to text inChapter 8.2 of UEFI 2.1B	June 5, 2008
2.1C	246 New returnCode	June 5, 2008
2.1C	245 Remove extraneous text inChapter 29	June 5, 2008
2.1C	244 Replace references to EFI_FIRMWARE_VOLUME_INFO_PPI with EFI_PEI_FIRMWARE_VOLUME_INFO_PPI	June 5, 2008
2.1C	221ImageBlock Structure name typos in 27.3.7.2	June 5, 2008
2.1C	220 Replace references to RFC 3066 to RFC 4646	June 5, 2008
2.1C	219 IA-32 and x64 stack need toBe 16-byte aligned	June 5, 2008
2.1C	218 SATA update to section 9.3.5.6	June 5, 2008
2.1C	217 EFI_PLATFORM_TO_DRIVER_CONFIGURATION_PROTOCOL.Query() Update	June 5, 2008
2.1C	216 UEFI 2.1 textCorrections	June 5, 2008
2.1C	214 Device_IO + typos	June 5, 2008

## Unified Extensible Firmware Interface Specification

Revision	Mantis Number / Description	Date
2.1C	213 UEFI HII Errata	June 5, 2008
2.1C	209 ESP number/locationClarifications	June 5, 2008
2.1C	208 Driver Protocol Names and GUIDs	June 5, 2008
2.1C	207 Updated Wording for the File Path	June 5, 2008
2.1C	206Clarify return values for extended scsi passthru protocol	June 5, 2008
2.1C	203 Platform Error Record - x64 register state errata	June 5, 2008
2.1C	193 Loaded Image device paths for EFI Drivers loaded from PCI Option ROMs	June 5, 2008
2.1C	189 Graphics Output ProtocolClarification	June 5, 2008
2.1B	51 Long physicalBlocks updates	December 11, 2007
2.1B	205Change LoadImage() parameter name from FilePath to DevicePath; endsConfusion with EFI_LOADED_IMAGE_PROTOCOL	December 11, 2007
2.1B	197 EFI Loaded Image Device Path Protocol	December 11, 2007
2.1B	190 Extensive errata form UCST including OPCodesChanges ro resolveConflicts.	December 11, 2007
2.1B	187Clarify input protocols.	December 11, 2007
2.1B	186Change PCIR struct to match PCI FW Spec 3.0	December 11, 2007
2.1B	185Change EFI term to UEFI forConsistency	December 11, 2007
2.1B	184 SNIA/DDF Wording Update	December 11, 2007
2.1B	182Clarify EFI_MTFTP4_TOKEN	December 11, 2007
2.1B	181Correct MNP GUIDCollision	December 11, 2007
2.1B	177 remove ending paragraph (editing text) in section 9.6	December 11, 2007
2.1B	175 Update to SendForm API	December 11, 2007
2.1B	174 Error record addition for dma remapping units	December 11, 2007
2.1B	173 MinorChanges to the description of two of the fields in theCommon Platform Error Record, in Appendix N	December 11, 2007
2.1B	172 Typo for ResetSystem()	December 11, 2007
2.1B	170 (Addition of) Driver Family Override Protocol	December 11, 2007
2.1B	168 Remove LOAD_OPTION_GRAPHICS	December 11, 2007

Revision	Mantis Number / Description	Date
2.1B	165 Fix EFI_GRAPHICS_OUTPUT_PIXEL	December 11, 2007
2.1B	164 Update to USB2_HC_PROTOCOL Table	December 11, 2007
2.1B	162 UEFI PIWG Device Path Errata	December 11, 2007
2.1B	160 Clean up references to PCIR	December 11, 2007
2.1B	158 Errata to the UEFI 2.1 Configuration sections	December 11, 2007
2.1B	156 SendForm API Errata	December 11, 2007
2.1B	159 Adjust some of the #define names in the Simple Text Input Ex protocol	December 11, 2007
2.1A	UEFI 2.1 incorporating Errata through 4-27-07	April 27, 2007
2.1	Second release	January 23, 2007
2.0	First release of specification.	January 31, 2006

# Unified Extensible Firmware Interface Specification

# Table of Contents

---

Acknowledgments.....	ii
Revision History.....	iii
Table of Contents.....	xxvii
List of Figures.....	lxi
List of Tables.....	lxxv
<b>1 Introduction.....</b>	<b>1</b>
1.1 UEFI Driver Model Extensions.....	1
1.2 Organization.....	3
1.3 Organization.....	5
1.4 Goals.....	8
1.5 Target Audience.....	10
1.6 UEFI Design Overview.....	11
1.7 UEFI Driver Model.....	12
1.7.1 UEFI Driver Model Goals.....	13
1.7.2 Legacy Option ROM Issues.....	14
1.8 Migration Requirements.....	14
1.8.1 Legacy Operating System Support.....	14
1.8.2 Supporting the UEFI Specification on a Legacy Platform.....	14
1.9 Conventions Used in this Document.....	15
1.9.1 Data Structure Descriptions.....	15
1.9.2 Protocol Descriptions.....	15
1.9.3 Procedure Descriptions.....	15
1.9.4 Instruction Descriptions.....	16
1.9.5 Pseudo-Code Conventions.....	16
1.9.6 Typographic Conventions.....	16
1.9.7 Number formats.....	17
1.9.8 Binary prefixes.....	18
<b>2 Overview.....</b>	<b>19</b>
2.1 Boot Manager.....	19
2.1.1 UEFI Images.....	20
2.1.2 UEFI Applications.....	21
2.1.3 UEFI OS Loaders.....	21
2.1.4 UEFI Drivers.....	22
2.2 Firmware Core.....	22
2.2.1 UEFI Services.....	22
2.2.2 Runtime Services.....	23
2.3 Calling Conventions.....	24
2.3.1 Data Types.....	25
2.3.2 IA-32 Platforms.....	27
2.3.3 Intel® Itanium® -Based Platforms.....	30

2.3.4 x64 Platforms.....	33
2.3.5 AArch32 Platforms.....	37
2.3.6 AArch64 Platforms.....	41
2.3.7 RISC-V Platforms.....	46
2.4 Protocols.....	52
2.5 UEFI Driver Model.....	58
2.5.1 Legacy Option ROM Issues.....	60
2.5.2 Driver Initialization.....	62
2.5.3 Host Bus Controllers.....	63
2.5.4 Device Drivers.....	65
2.5.5 Bus Drivers.....	66
2.5.6 Platform Components.....	68
2.5.7 Hot-Plug Events.....	69
2.5.8 EFI Services Binding.....	69
2.6 Requirements.....	71
2.6.1 Required Elements.....	71
2.6.2 Platform-Specific Elements.....	72
2.6.3 Driver-Specific Elements.....	75
2.6.4 Extensions to this Specification published elsewhere.....	77
<b>3 Boot Manager.....</b>	<b>79</b>
3.1 Firmware Boot Manager.....	79
3.1.1 Boot Manager Programming.....	80
3.1.2 Load Option Processing.....	81
3.1.3 Load Options.....	83
3.1.4 Boot Manager Capabilities.....	85
3.1.5 Launching Boot#### Applications.....	85
3.1.6 Launching Boot#### Load Options Using Hot Keys.....	85
3.1.7 Required System Preparation Applications.....	88
3.2 Boot Manager Policy Protocol.....	88
EFI_BOOT_MANAGER_POLICY_PROTOCOL.....	88
EFI_BOOT_MANAGER_PROTOCOL.ConnectDevicePath().....	90
EFI_BOOT_MANAGER_PROTOCOL.ConnectDeviceClass().....	91
3.3 Globally Defined Variables.....	92
3.4 Boot Option Recovery.....	99
3.4.1 OS-Defined Boot Option Recovery.....	99
3.4.2 Platform-Defined Boot Option Recovery.....	100
3.4.3 Boot Option Variables Default Boot Behavior.....	100
3.5 Boot Mechanisms.....	100
3.5.1 Boot via the Simple File Protocol.....	100
3.5.2 Boot via the Load File Protocol.....	101
<b>4 EFI System Table.....</b>	<b>103</b>
4.1 UEFI Image Entry Point.....	103
EFI_IMAGE_ENTRY_POINT.....	103
4.2 EFI Table Header.....	104
EFI_TABLE_HEADER.....	105
4.3 EFI System Table.....	106



EFI_SYSTEM_TABLE .....	106
4.4 EFI Boot Services Table .....	108
EFI_BOOT_SERVICES .....	108
4.5 EFI Runtime Services Table .....	112
EFI_RUNTIME_SERVICES .....	112
4.6 EFI Configuration Table & Properties Table .....	114
EFI_CONFIGURATION_TABLE .....	115
EFI_PROPERTIES_TABLE .....	116
EFI_MEMORY_ATTRIBUTES_TABLE .....	117
4.7 Image Entry Point Examples .....	119
4.7.1 Image Entry Point Examples .....	119
4.7.2 UEFI Driver Model Example .....	121
4.7.3 UEFI Driver Model Example (Unloadable) .....	122
4.7.4 EFI Driver Model Example (Multiple Instances) .....	123
<b>5 GUID Partition Table (GPT) Disk Layout .....</b>	<b>125</b>
5.1 GPT and MBR disk layout comparison .....	125
5.2 LBA 0 Format .....	125
5.2.1 Legacy Master Boot Record (MBR) .....	125
5.2.2 OS Types .....	128
5.2.3 Protective MBR .....	128
5.2.4 Partition Information .....	130
5.3 GUID Partition Table (GPT) Disk Layout .....	131
5.3.1 GPT overview .....	131
5.3.2 GPT Header .....	134
5.3.3 GPT Partition Entry Array .....	137
<b>6 Block Translation Table (BTT) Layout .....</b>	<b>141</b>
6.1 Block Translation Table (BTT) Background .....	141
6.2 Block Translation Table (BTT) Data Structures .....	142
6.2.1 BTT Info Block .....	142
6.2.2 BTT Map Entry .....	145
6.2.3 BTT Flog .....	146
6.2.4 BTT Data Area .....	148
6.2.5 NVDIMM Label Protocol Address Abstraction Guid .....	148
6.3 BTT Theory of Operation .....	148
6.3.1 BTT Arenas .....	149
6.3.2 Atomicity of Data Blocks in an Arena .....	149
6.3.3 Atomicity of BTT Data Structures .....	150
6.3.4 Writing the Initial BTT layout .....	151
6.3.5 Validating BTT Arenas at start-up .....	152
6.3.6 Validating the Flog entries at start-up .....	153
6.3.7 Read Path .....	153
6.3.8 Write Path .....	155
<b>7 Services — Boot Services .....</b>	<b>157</b>
7.1 Event, Timer, and Task Priority Services .....	158
EFI_BOOT_SERVICES.CreateEvent() .....	163

EFI_BOOT_SERVICES.CreateEventEx()	167
EFI_BOOT_SERVICES.CloseEvent()	171
EFI_BOOT_SERVICES.SignalEvent()	172
EFI_BOOT_SERVICES.WaitForEvent()	173
EFI_BOOT_SERVICES.CheckEvent()	175
EFI_BOOT_SERVICES.SetTimer()	176
EFI_BOOT_SERVICES.RaiseTPL()	178
EFI_BOOT_SERVICES.RestoreTPL()	180
7.2 Memory Allocation Services	180
EFI_BOOT_SERVICES.AllocatePages()	184
EFI_BOOT_SERVICES.FreePages()	187
EFI_BOOT_SERVICES.GetMemoryMap()	188
EFI_BOOT_SERVICES.AllocatePool()	193
EFI_BOOT_SERVICES.FreePool()	194
7.3 Protocol Handler Services	194
EFI_BOOT_SERVICES.InstallProtocolInterface()	200
EFI_BOOT_SERVICES.UninstallProtocolInterface()	202
EFI_BOOT_SERVICES.ReinstallProtocolInterface()	204
EFI_BOOT_SERVICES.RegisterProtocolNotify()	206
EFI_BOOT_SERVICES.LocateHandle()	208
EFI_BOOT_SERVICES.HandleProtocol()	210
EFI_BOOT_SERVICES.LocateDevicePath()	212
EFI_BOOT_SERVICES.OpenProtocol()	214
EFI_BOOT_SERVICES.CloseProtocol()	221
EFI_BOOT_SERVICES.OpenProtocolInformation()	224
EFI_BOOT_SERVICES.ConnectController()	226
EFI_BOOT_SERVICES.DisconnectController()	231
EFI_BOOT_SERVICES.ProtocolsPerHandle()	234
EFI_BOOT_SERVICES.LocateHandleBuffer()	236
EFI_BOOT_SERVICES.LocateProtocol()	239
EFI_BOOT_SERVICES.InstallMultipleProtocolInterfaces()	240
EFI_BOOT_SERVICES.UninstallMultipleProtocolInterfaces()	242
7.4 Image Services	242
EFI_BOOT_SERVICES.LoadImage()	245
EFI_BOOT_SERVICES.StartImage()	248
EFI_BOOT_SERVICES.UnloadImage()	250
EFI_IMAGE_ENTRY_POINT	251
EFI_BOOT_SERVICES.Exit()	253
EFI_BOOT_SERVICES.ExitBootServices()	255
7.5 Miscellaneous Boot Services	256
EFI_BOOT_SERVICES.SetWatchdogTimer()	257
EFI_BOOT_SERVICES.Stall()	259
EFI_BOOT_SERVICES.CopyMem()	260
EFI_BOOT_SERVICES.SetMem()	261
EFI_BOOT_SERVICES.GetNextMonotonicCount()	262
EFI_BOOT_SERVICES.InstallConfigurationTable()	263
EFI_BOOT_SERVICES.CalculateCrc32()	265

<b>8 Services — Runtime Services .....</b>	<b>267</b>
8.1 Runtime Services Rules and Restrictions .....	268
8.1.1 Exception for Machine Check, INIT, and NMI .....	269
8.2 Variable Services.....	270
GetVariable() .....	271
GetNextVariableName() .....	275
SetVariable() .....	277
8.2.1 Using the EFI_VARIABLE_AUTHENTICATION_3 descriptor .....	283
8.2.2 Using the EFI_VARIABLE_AUTHENTICATION_2 descriptor .....	286
8.2.3 Using the EFI_VARIABLE_AUTHENTICATION descriptor .....	289
QueryVariableInfo() .....	292
8.2.4 Hardware Error Record Persistence .....	293
8.3 Time Services .....	294
GetTime().....	295
SetTime() .....	299
GetWakeupTime().....	300
SetWakeupTime() .....	301
8.4 Virtual Memory Services.....	302
SetVirtualAddressMap().....	303
ConvertPointer().....	305
8.5 Miscellaneous Runtime Services.....	306
8.5.1 Reset System .....	306
ResetSystem().....	307
8.5.2 Get Next High Monotonic Count .....	308
GetNextHighMonotonicCount().....	309
8.5.3 Update Capsule .....	310
UpdateCapsule().....	311
QueryCapsuleCapabilities() .....	318
8.5.4 Exchanging information between the OS and Firmware.....	319
8.5.5 Delivery of Capsules via file on Mass Storage device .....	321
8.5.6 UEFI variable reporting on the Success or any Errors encountered in processing of capsules after restart .....	322
<b>9 Protocols — EFI Loaded Image .....</b>	<b>327</b>
9.1 EFI Loaded Image Protocol .....	327
EFI_LOADED_IMAGE_PROTOCOL.....	327
EFI_LOADED_IMAGE_PROTOCOL.Unload() .....	329
9.2 EFI Loaded Image Device Path Protocol.....	329
EFI_LOADED_IMAGE_DEVICE_PATH_PROTOCOL .....	329
<b>10 Protocols — Device Path Protocol.....</b>	<b>331</b>
10.1 Device Path Overview .....	331
10.2 EFI Device Path Protocol .....	331
EFI_DEVICE_PATH_PROTOCOL.....	332
10.3 Device Path Nodes .....	332
10.3.1 Generic Device Path Structures .....	333
10.3.2 Hardware Device Path.....	334

10.3.3	ACPI Device Path.....	336
10.3.4	ACPI _ADR Device Path .....	339
10.3.5	Messaging Device Path.....	339
10.3.6	Media Device Path .....	375
10.3.7	BIOS Boot Specification Device Path .....	380
10.4	Device Path Generation Rules .....	381
10.4.1	Housekeeping Rules .....	381
10.4.2	Rules with ACPI _HID and _UID.....	382
10.4.3	Rules with ACPI _ADR .....	383
10.4.4	Hardware vs. Messaging Device Path Rules .....	383
10.4.5	Media Device Path Rules.....	383
10.4.6	Other Rules.....	384
10.5	Device Path Utilities Protocol .....	384
EFI_DEVICE_PATH_UTILITIES_PROTOCOL .....	384	
EFI_DEVICE_PATH_UTILITIES_PROTOCOL.GetDevicePathSize() .....	386	
EFI_DEVICE_PATH_UTILITIES_PROTOCOL.DuplicateDevicePath() .....	387	
EFI_DEVICE_PATH_UTILITIES_PROTOCOL.AppendDevicePath().....	388	
EFI_DEVICE_PATH_UTILITIES_PROTOCOL.AppendDeviceNode().....	389	
EFI_DEVICE_PATH_UTILITIES_PROTOCOL.AppendDevicePathInstance() .....	390	
EFI_DEVICE_PATH_UTILITIES_PROTOCOL.GetNextDevicePathInstance().....	391	
EFI_DEVICE_PATH_UTILITIES_PROTOCOL.CreateDeviceNode().....	392	
EFI_DEVICE_PATH_UTILITIES_PROTOCOL.IsDevicePathMultiInstance().....	393	
10.6	EFI Device Path Display Format Overview .....	393
10.6.1	Design Discussion.....	394
10.6.2	Device Path to Text Protocol .....	412
EFI_DEVICE_PATH_TO_TEXT_PROTOCOL.....	412	
EFI_DEVICE_PATH_TO_TEXT_PROTOCOL.ConvertDeviceNodeToText() .....	413	
EFI_DEVICE_PATH_TO_TEXT_PROTOCOL.ConvertDevicePathToText().....	414	
10.6.3	Device Path from Text Protocol .....	415
EFI_DEVICE_PATH_FROM_TEXT_PROTOCOL .....	415	
EFI_DEVICE_PATH_FROM_TEXT_PROTOCOL.ConvertTextToDeviceNode()....	416	
EFI_DEVICE_PATH_FROM_TEXT_PROTOCOL.ConvertTextToDevicePath() .....	417	
<b>11</b>	<b>Protocols — UEFI Driver Model.....</b>	<b>419</b>
11.1	EFI Driver Binding Protocol .....	419
EFI_DRIVER_BINDING_PROTOCOL.....	419	
EFI_DRIVER_BINDING_PROTOCOL.Supported().....	422	
EFI_DRIVER_BINDING_PROTOCOL.Start().....	428	
EFI_DRIVER_BINDING_PROTOCOL.Stop() .....	437	
11.2	EFI Platform Driver Override Protocol.....	441
EFI_PLATFORM_DRIVER_OVERRIDE_PROTOCOL.....	441	
EFI_PLATFORM_DRIVER_OVERRIDE_PROTOCOL.GetDriver() .....	443	
EFI_PLATFORM_DRIVER_OVERRIDE_PROTOCOL.GetDriverPath().....	445	
EFI_PLATFORM_DRIVER_OVERRIDE_PROTOCOL.DriverLoaded().....	447	
11.3	EFI Bus Specific Driver Override Protocol.....	448
EFI_BUS_SPECIFIC_DRIVER_OVERRIDE_PROTOCOL .....	448	
EFI_BUS_SPECIFIC_DRIVER_OVERRIDE_PROTOCOL.GetDriver().....	450	

11.4	EFI Driver Diagnostics Protocol .....	451
	EFI_DRIVER_DIAGNOSTICS2_PROTOCOL .....	451
	EFI_DRIVER_DIAGNOSTICS2_PROTOCOL.RunDiagnostics() .....	453
11.5	EFI Component Name Protocol .....	455
	EFI_COMPONENT_NAME2_PROTOCOL .....	456
	EFI_COMPONENT_NAME2_PROTOCOL.GetDriverName() .....	457
	EFI_COMPONENT_NAME2_PROTOCOL.GetControllerName() .....	459
11.6	EFI Service Binding Protocol .....	460
	EFI_SERVICE_BINDING_PROTOCOL .....	461
	EFI_SERVICE_BINDING_PROTOCOL.CreateChild() .....	462
	EFI_SERVICE_BINDING_PROTOCOL.DestroyChild() .....	467
11.7	EFI Platform to Driver Configuration Protocol .....	471
	EFI_PLATFORM_TO_DRIVER_CONFIGURATION_PROTOCOL .....	472
	EFI_PLATFORM_TO_DRIVER_CONFIGURATION_PROTOCOL.Query() .....	473
	EFI_PLATFORM_TO_DRIVER_CONFIGURATION_PROTOCOL.Response() .....	475
	11.7.1 DMTF SM CLP ParameterTypeGuid .....	477
11.8	EFI Driver Supported EFI Version Protocol .....	479
	EFI_DRIVER_SUPPORTED_EFI_VERSION_PROTOCOL .....	479
11.9	EFI Driver Family Override Protocol .....	480
	11.9.1 Overview .....	480
	EFI_DRIVER_FAMILY_OVERRIDE_PROTOCOL .....	480
	EFI_DRIVER_FAMILY_OVERRIDE_PROTOCOL.GetVersion () .....	482
11.10	EFI Driver Health Protocol .....	482
	EFI_DRIVER_HEALTH_PROTOCOL .....	482
	EFI_DRIVER_HEALTH_PROTOCOL.GetHealthStatus() .....	485
	EFI_DRIVER_HEALTH_PROTOCOL.Repair () .....	490
	11.10.1 UEFI Boot Manager Algorithms .....	491
	11.10.2 UEFI Driver Algorithms .....	496
11.11	EFI Adapter Information Protocol .....	497
	EFI_ADAPTER_INFORMATION_PROTOCOL .....	497
	EFI_ADAPTER_INFORMATION_PROTOCOL.EFI_ADAPTER_GET_INFO() .....	499
	EFI_ADAPTER_INFORMATION_PROTOCOL.EFI_ADAPTER_INFO_SET_INFO() .....	501
	EFI_ADAPTER_INFORMATION_PROTOCOL.EFI_ADAPTER_INFO_GET_SUPPORTED_TYPES() .....	503
11.12	EFI Adapter Information Protocol Information Types .....	504
	11.12.1 Network Media State .....	504
	11.12.2 Network Boot .....	505
	11.12.3 SAN MAC Address .....	506
	11.12.4 IPv6 Support from UEFI .....	506
	11.12.5 Network Media Type .....	507
<b>12</b>	<b>Protocols — Console Support .....</b>	<b>509</b>
12.1	Console I/O Protocol .....	509
	12.1.1 Overview .....	509
	12.1.2 ConsoleIn Definition .....	509
12.2	Simple Text Input Ex Protocol .....	511

EFI_SIMPLE_TEXT_INPUT_EX_PROTOCOL.....	512
EFI_SIMPLE_TEXT_INPUT_EX_PROTOCOL.Reset().....	513
EFI_SIMPLE_TEXT_INPUT_EX_PROTOCOL.ReadKeyStrokeEx().....	514
EFI_SIMPLE_TEXT_INPUT_EX_PROTOCOL.SetState().....	517
EFI_SIMPLE_TEXT_INPUT_EX_PROTOCOL.RegisterKeyNotify().....	518
EFI_SIMPLE_TEXT_INPUT_EX_PROTOCOL.UnregisterKeyNotify().....	520
12.3 Simple Text Input Protocol.....	520
EFI_SIMPLE_TEXT_INPUT_PROTOCOL.....	520
EFI_SIMPLE_TEXT_INPUT_PROTOCOL.Reset().....	522
EFI_SIMPLE_TEXT_INPUT_PROTOCOL.ReadKeyStroke().....	523
12.3.1 ConsoleOut or StandardError.....	523
12.4 Simple Text Output Protocol.....	524
EFI_SIMPLE_TEXT_OUTPUT_PROTOCOL.....	524
EFI_SIMPLE_TEXT_OUTPUT_PROTOCOL.Reset().....	527
EFI_SIMPLE_TEXT_OUTPUT_PROTOCOL.OutputString().....	528
EFI_SIMPLE_TEXT_OUTPUT_PROTOCOL.TestString().....	532
EFI_SIMPLE_TEXT_OUTPUT_PROTOCOL.QueryMode().....	533
EFI_SIMPLE_TEXT_OUTPUT_PROTOCOL.SetMode().....	534
EFI_SIMPLE_TEXT_OUTPUT_PROTOCOL.SetAttribute().....	535
EFI_SIMPLE_TEXT_OUTPUT_PROTOCOL.ClearScreen().....	538
EFI_SIMPLE_TEXT_OUTPUT_PROTOCOL.SetCursorPosition().....	539
EFI_SIMPLE_TEXT_OUTPUT_PROTOCOL.EnableCursor().....	540
12.5 Simple Pointer Protocol.....	540
EFI_SIMPLE_POINTER_PROTOCOL.....	540
EFI_SIMPLE_POINTER_PROTOCOL.Reset().....	543
EFI_SIMPLE_POINTER_PROTOCOL.GetState().....	544
12.6 EFI Simple Pointer Device Paths.....	545
12.7 Absolute Pointer Protocol.....	549
EFI_ABSOLUTE_POINTER_PROTOCOL.....	550
EFI_ABSOLUTE_POINTER_PROTOCOL.Reset().....	553
EFI_ABSOLUTE_POINTER_PROTOCOL.GetState().....	554
12.8 Serial I/O Protocol.....	555
EFI_SERIAL_IO_PROTOCOL.....	555
EFI_SERIAL_IO_PROTOCOL.Reset().....	559
EFI_SERIAL_IO_PROTOCOL.SetAttributes().....	560
EFI_SERIAL_IO_PROTOCOL.SetControl().....	562
EFI_SERIAL_IO_PROTOCOL.GetControl().....	564
EFI_SERIAL_IO_PROTOCOL.Write().....	565
EFI_SERIAL_IO_PROTOCOL.Read().....	566
12.9 Graphics Output Protocol.....	566
12.9.1 Bit Buffer.....	567
EFI_GRAPHICS_OUTPUT_PROTOCOL.....	568
EFI_GRAPHICS_OUTPUT_PROTOCOL.QueryMode().....	573
EFI_GRAPHICS_OUTPUT_PROTOCOL.SetMode().....	575
EFI_GRAPHICS_OUTPUT_PROTOCOL.Bit().....	576
EFI_EDID_DISCOVERED_PROTOCOL.....	578
EFI_EDID_ACTIVE_PROTOCOL.....	579

EFI_EDID_OVERRIDE_PROTOCOL .....	580
EFI_EDID_OVERRIDE_PROTOCOL.GetEdid() .....	582
12.10 Rules for PCI/AGP Devices .....	584
<b>13 Protocols — Media Access.....</b>	<b>587</b>
13.1 Load File Protocol.....	587
EFI_LOAD_FILE_PROTOCOL .....	587
EFI_LOAD_FILE_PROTOCOL.LoadFile() .....	588
13.2 Load File 2 Protocol.....	589
EFI_LOAD_FILE2_PROTOCOL.....	589
EFI_LOAD_FILE2_PROTOCOL.LoadFile() .....	591
13.3 File System Format .....	592
13.3.1 System Partition.....	592
13.3.2 Partition Discovery .....	595
13.3.3 Number and Location of System Partitions .....	596
13.3.4 Media Formats .....	597
13.4 Simple File System Protocol.....	598
EFI_SIMPLE_FILE_SYSTEM_PROTOCOL.....	598
EFI_SIMPLE_FILE_SYSTEM_PROTOCOL.OpenVolume().....	600
13.5 File Protocol .....	601
EFI_FILE_PROTOCOL.....	601
EFI_FILE_PROTOCOL.Open().....	604
EFI_FILE_PROTOCOL.Close().....	607
EFI_FILE_PROTOCOL.Delete().....	608
EFI_FILE_PROTOCOL.Read().....	609
EFI_FILE_PROTOCOL.Write().....	611
EFI_FILE_PROTOCOL.OpenEx().....	612
EFI_FILE_PROTOCOL.ReadEx().....	615
EFI_FILE_PROTOCOL.WriteEx().....	617
EFI_FILE_PROTOCOL.SetPosition() .....	621
EFI_FILE_PROTOCOL.GetPosition() .....	622
EFI_FILE_PROTOCOL.GetInfo().....	623
EFI_FILE_PROTOCOL.SetInfo() .....	625
EFI_FILE_PROTOCOL.Flush().....	627
EFI_FILE_INFO.....	627
EFI_FILE_SYSTEM_INFO.....	629
EFI_FILE_SYSTEM_VOLUME_LABEL .....	630
13.6 Tape Boot Support.....	630
13.6.1 Tape I/O Support .....	630
13.6.2 Tape I/O Protocol .....	631
EFI_TAPE_IO_PROTOCOL .....	631
EFI_TAPE_IO_PROTOCOL.TapeRead() .....	633
EFI_TAPE_IO_PROTOCOL.TapeWrite().....	635
EFI_TAPE_IO_PROTOCOL.TapeRewind() .....	637
EFI_TAPE_IO_PROTOCOL.TapeSpace().....	638
EFI_TAPE_IO_PROTOCOL.TapeWriteFM().....	640
EFI_TAPE_IO_PROTOCOL.TapeReset().....	641

13.6.3 Tape Header Format.....	641
13.7 Disk I/O Protocol.....	643
EFI_DISK_IO_PROTOCOL.....	643
EFI_DISK_IO_PROTOCOL.ReadDisk().....	645
EFI_DISK_IO_PROTOCOL.WriteDisk().....	646
13.8 Disk I/O 2 Protocol .....	647
EFI_DISK_IO2_PROTOCOL.....	647
EFI_DISK_IO2_PROTOCOL.Cancel() .....	649
EFI_DISK_IO2_PROTOCOL.ReadDiskEx() .....	650
EFI_DISK_IO2_PROTOCOL.WriteDiskEx() .....	652
EFI_DISK_IO2_PROTOCOL.FlushDiskEx() .....	654
13.9 Block I/O Protocol.....	655
EFI_BLOCK_IO_PROTOCOL.....	655
EFI_BLOCK_IO_PROTOCOL.Reset().....	660
EFI_BLOCK_IO_PROTOCOL.ReadBlocks() .....	661
EFI_BLOCK_IO_PROTOCOL.WriteBlocks() .....	663
EFI_BLOCK_IO_PROTOCOL.FlushBlocks() .....	665
13.10 Block I/O 2 Protocol.....	665
EFI_BLOCK_IO2_PROTOCOL .....	665
EFI_BLOCK_IO2_PROTOCOL.Reset() .....	667
EFI_BLOCK_IO2_PROTOCOL.ReadBlocksEx().....	668
EFI_BLOCK_IO2_PROTOCOL.WriteBlocksEx() .....	670
EFI_BLOCK_IO2_PROTOCOL.FlushBlocksEx().....	672
13.11 Inline Cryptographic Interface Protocol.....	673
EFI_BLOCK_IO_CRYPTO_PROTOCOL .....	673
EFI_BLOCK_IO_CRYPTO_PROTOCOL.Reset() .....	678
EFI_BLOCK_IO_CRYPTO_PROTOCOL.GetCapabilities() .....	679
EFI_BLOCK_IO_CRYPTO_PROTOCOL.SetConfiguration() .....	680
EFI_BLOCK_IO_CRYPTO_PROTOCOL.GetConfiguration().....	682
EFI_BLOCK_IO_CRYPTO_PROTOCOL.ReadExtended() .....	684
EFI_BLOCK_IO_CRYPTO_PROTOCOL.WriteExtended() .....	686
EFI_BLOCK_IO_CRYPTO_PROTOCOL.FlushBlocks() .....	688
13.12 Erase Block Protocol.....	689
EFI_ERASE_BLOCK_PROTOCOL .....	689
EFI_ERASE_BLOCK_PROTOCOL.EraseBlocks() .....	691
13.13 ATA Pass Thru Protocol .....	692
EFI_ATA_PASS_THRU_PROTOCOL.....	692
EFI_ATA_PASS_THRU_PROTOCOL.PassThru().....	697
EFI_ATA_PASS_THRU_PROTOCOL.GetNextPort().....	704
EFI_ATA_PASS_THRU_PROTOCOL.GetNextDevice().....	705
EFI_ATA_PASS_THRU_PROTOCOL.BuildDevicePath() .....	707
EFI_ATA_PASS_THRU_PROTOCOL.GetDevice() .....	709
EFI_ATA_PASS_THRU_PROTOCOL.ResetPort().....	711
EFI_ATA_PASS_THRU_PROTOCOL.ResetDevice().....	712
13.14 Storage Security Command Protocol .....	713
EFI_STORAGE_SECURITY_COMMAND_PROTOCOL.....	713
EFI_STORAGE_SECURITY_COMMAND_PROTOCOL.ReceiveData() .....	715



EFI_STORAGE_SECURITY_COMMAND_PROTOCOL.SendData()	718
13.15 NVM Express Pass Through Protocol	719
EFI_NVMM_EXPRESS_PASS_THRU_PROTOCOL	719
EFI_NVMM_EXPRESS_PASS_THRU_PROTOCOL.PassThru()	723
EFI_NVMM_EXPRESS_PASS_THRU_PROTOCOL.GetNextNamespace()	728
EFI_NVMM_EXPRESS_PASS_THRU_PROTOCOL.BuildDevicePath()	729
EFI_NVMM_EXPRESS_PASS_THRU_PROTOCOL.GetNamespace()	731
13.16 SD MMC Pass Thru Protocol	732
EFI_SD_MMC_PASS_THRU_PROTOCOL	732
EFI_SD_MMC_PASS_THRU_PROTOCOL.PassThru()	734
EFI_SD_MMC_PASS_THRU_PROTOCOL.GetNextSlot()	738
EFI_SD_MMC_PASS_THRU_PROTOCOL.BuildDevicePath()	739
EFI_SD_MMC_PASS_THRU_PROTOCOL.GetSlotNumber()	740
EFI_SD_MMC_PASS_THRU_PROTOCOL.ResetDevice()	741
13.17 RAM Disk Protocol	742
EFI_RAM_DISK_PROTOCOL	742
EFI_RAM_DISK_PROTOCOL.Register()	743
EFI_RAM_DISK_PROTOCOL.Unregister()	745
13.18 Partition Information Protocol	745
13.19 NVDIMM Label Protocol	747
EFI_NVDIMM_LABEL_PROTOCOL.LabelStorageInformation()	748
EFI_NVDIMM_LABEL_PROTOCOL.LabelStorageRead()	748
EFI_NVDIMM_LABEL_PROTOCOL.LabelStorageWrite()	749
13.20 EFI UFS Device Config Protocol	765
EFI_UFS_DEVICE_CONFIG_PROTOCOL	765
EFI_UFS_DEVICE_CONFIG_PROTOCOL.RwUfsDescriptor()	766
EFI_UFS_DEVICE_CONFIG_PROTOCOL.RwUfsFlag()	767
EFI_UFS_DEVICE_CONFIG_PROTOCOL.RwUfsAttribute()	768
<b>14 Protocols — PCI Bus Support</b>	<b>771</b>
14.1 PCI Root Bridge I/O Support	771
14.1.1 PCI Root Bridge I/O Overview	771
14.2 PCI Root Bridge I/O Protocol	777
EFI_PCI_ROOT_BRIDGE_IO_PROTOCOL	777
EFI_PCI_ROOT_BRIDGE_IO_PROTOCOL.PollMem()	786
EFI_PCI_ROOT_BRIDGE_IO_PROTOCOL.PollIo()	788
EFI_PCI_ROOT_BRIDGE_IO_PROTOCOL.Mem.Read()	
EFI_PCI_ROOT_BRIDGE_IO_PROTOCOL.Mem.Write()	790
EFI_PCI_ROOT_BRIDGE_IO_PROTOCOL.Io.Read()	
EFI_PCI_ROOT_BRIDGE_IO_PROTOCOL.Io.Write()	792
EFI_PCI_ROOT_BRIDGE_IO_PROTOCOL.Pci.Read()	
EFI_PCI_ROOT_BRIDGE_IO_PROTOCOL.Pci.Write()	794
EFI_PCI_ROOT_BRIDGE_IO_PROTOCOL.CopyMem()	796
EFI_PCI_ROOT_BRIDGE_IO_PROTOCOL.Map()	798
EFI_PCI_ROOT_BRIDGE_IO_PROTOCOL.Unmap()	800
EFI_PCI_ROOT_BRIDGE_IO_PROTOCOL.AllocateBuffer()	801
EFI_PCI_ROOT_BRIDGE_IO_PROTOCOL.FreeBuffer()	803

EFI_PCI_ROOT_BRIDGE_IO_PROTOCOL.Flush()	804
EFI_PCI_ROOT_BRIDGE_IO_PROTOCOL.GetAttributes()	805
EFI_PCI_ROOT_BRIDGE_IO_PROTOCOL.SetAttributes()	807
EFI_PCI_ROOT_BRIDGE_IO_PROTOCOL.Configuration()	809
14.2.1 PCI Root Bridge Device Paths	811
14.3 PCI Driver Model	814
14.3.1 PCI Driver Initialization	815
14.3.2 PCI Bus Drivers	817
14.3.3 PCI Device Drivers	822
14.4 EFI PCI I/O Protocol	823
EFI_PCI_IO_PROTOCOL	824
EFI_PCI_IO_PROTOCOL.PollMem()	834
EFI_PCI_IO_PROTOCOL.PollIo()	836
EFI_PCI_IO_PROTOCOL.Mem.Read()	
EFI_PCI_IO_PROTOCOL.Mem.Write()	838
EFI_PCI_IO_PROTOCOL.Io.Read()	
EFI_PCI_IO_PROTOCOL.Io.Write()	840
EFI_PCI_IO_PROTOCOL.Pci.Read()	
EFI_PCI_IO_PROTOCOL.Pci.Write()	842
EFI_PCI_IO_PROTOCOL.CopyMem()	844
EFI_PCI_IO_PROTOCOL.Map()	847
EFI_PCI_IO_PROTOCOL.Unmap()	849
EFI_PCI_IO_PROTOCOL.AllocateBuffer()	850
EFI_PCI_IO_PROTOCOL.FreeBuffer()	852
EFI_PCI_IO_PROTOCOL.Flush()	853
EFI_PCI_IO_PROTOCOL.GetLocation()	854
EFI_PCI_IO_PROTOCOL.Attributes()	855
EFI_PCI_IO_PROTOCOL.GetBarAttributes()	858
EFI_PCI_IO_PROTOCOL.SetBarAttributes()	861
14.4.1 PCI Device Paths	862
14.4.2 PCI Option ROMs	864
14.4.3 Nonvolatile Storage	876
14.4.4 PCI Hot-Plug Events	876
<b>15 Protocols — SCSI Driver Models and Bus Support</b>	<b>877</b>
15.1 SCSI Driver Model Overview	877
15.2 SCSI Bus Drivers	877
15.2.1 Driver Binding Protocol for SCSI Bus Drivers	878
15.2.2 SCSI Enumeration	879
15.3 SCSI Device Drivers	879
15.3.1 Driver Binding Protocol for SCSI Device Drivers	879
15.4 EFI SCSI I/O Protocol	880
EFI_SCSI_IO_PROTOCOL	880
EFI_SCSI_IO_PROTOCOL.GetDeviceType()	882
EFI_SCSI_IO_PROTOCOL.GetDeviceLocation()	884
EFI_SCSI_IO_PROTOCOL.ResetBus()	885
EFI_SCSI_IO_PROTOCOL.ResetDevice()	886

EFI_SCSI_IO_PROTOCOL.ExecuteScsiCommand() .....	887
15.5 SCSI Device Paths .....	891
15.5.1 SCSI Device Path Example .....	891
15.5.2 ATAPI Device Path Example .....	892
15.5.3 Fibre Channel Device Path Example .....	893
15.5.4 InfiniBand Device Path Example .....	894
15.6 SCSI Pass Thru Device Paths .....	895
15.7 Extended SCSI Pass Thru Protocol .....	898
EFI_EXT_SCSI_PASS_THRU_PROTOCOL .....	899
EFI_EXT_SCSI_PASS_THRU_PROTOCOL.PassThru() .....	902
EFI_EXT_SCSI_PASS_THRU_PROTOCOL.GetNextTargetLun() .....	908
EFI_EXT_SCSI_PASS_THRU_PROTOCOL.BuildDevicePath() .....	910
EFI_EXT_SCSI_PASS_THRU_PROTOCOL.GetTargetLun() .....	912
EFI_EXT_SCSI_PASS_THRU_PROTOCOL.ResetChannel() .....	914
EFI_EXT_SCSI_PASS_THRU_PROTOCOL.ResetTargetLun() .....	915
EFI_EXT_SCSI_PASS_THRU_PROTOCOL.GetNextTarget() .....	917
<b>16 Protocols — iSCSI Boot .....</b>	<b>919</b>
16.1 Overview .....	919
16.1.1 iSCSI UEFI Driver Layering .....	919
16.2 EFI iSCSI Initiator Name Protocol .....	919
EFI_ISCSI_INITIATOR_NAME_PROTOCOL .....	920
EFI_ISCSI_INITIATOR_NAME_PROTOCOL.Get() .....	921
EFI_ISCSI_INITIATOR_NAME_PROTOCOL.Set() .....	922
<b>17 Protocols — USB Support .....</b>	<b>923</b>
17.1 USB2 Host Controller Protocol .....	923
17.1.1 USB Host Controller Protocol Overview .....	923
EFI_USB2_HC_PROTOCOL .....	923
EFI_USB2_HC_PROTOCOL.GetCapability() .....	926
EFI_USB2_HC_PROTOCOL.Reset() .....	928
EFI_USB2_HC_PROTOCOL.GetState() .....	930
EFI_USB2_HC_PROTOCOL.SetState() .....	932
EFI_USB2_HC_PROTOCOL.ControlTransfer() .....	934
EFI_USB2_HC_PROTOCOL.BulkTransfer() .....	937
EFI_USB2_HC_PROTOCOL.AsyncInterruptTransfer() .....	940
EFI_USB2_HC_PROTOCOL.SyncInterruptTransfer() .....	943
EFI_USB2_HC_PROTOCOL.IsochronousTransfer() .....	946
EFI_USB2_HC_PROTOCOL.AsyncIsochronousTransfer() .....	949
EFI_USB2_HC_PROTOCOL.GetRootHubPortStatus() .....	952
EFI_USB2_HC_PROTOCOL.SetRootHubPortFeature() .....	956
EFI_USB2_HC_PROTOCOL.ClearRootHubPortFeature() .....	958
17.2 USB Driver Model .....	959
17.2.1 Scope .....	959
17.2.2 USB Bus Driver .....	960
17.2.3 USB Device Driver .....	961
17.2.4 USB I/O Protocol .....	962
EFI_USB_IO_PROTOCOL .....	963

EFI_USB_IO_PROTOCOL.UsbControlTransfer()	965
EFI_USB_IO_PROTOCOL.UsbBulkTransfer()	968
EFI_USB_IO_PROTOCOL.UsbAsyncInterruptTransfer()	970
EFI_USB_IO_PROTOCOL.UsbSyncInterruptTransfer()	975
EFI_USB_IO_PROTOCOL.UsbIsochronousTransfer()	977
EFI_USB_IO_PROTOCOL.UsbAsyncIsochronousTransfer()	979
EFI_USB_IO_PROTOCOL.UsbGetDeviceDescriptor()	981
EFI_USB_IO_PROTOCOL.UsbGetConfigDescriptor()	983
EFI_USB_IO_PROTOCOL.UsbGetInterfaceDescriptor()	985
EFI_USB_IO_PROTOCOL.UsbGetEndpointDescriptor()	987
EFI_USB_IO_PROTOCOL.UsbGetStringDescriptor()	989
EFI_USB_IO_PROTOCOL.UsbGetSupportedLanguages()	990
EFI_USB_IO_PROTOCOL.UsbPortReset()	991
17.3 USB Function Protocol	991
EFI_USBFN_IO_PROTOCOL	992
EFI_USBFN_IO_PROTOCOL.DetectPort()	996
EFI_USBFN_IO_PROTOCOL.ConfigureEnableEndpoints()	998
EFI_USBFN_IO_PROTOCOL.GetEndpointMaxPacketSize()	1000
EFI_USBFN_IO_PROTOCOL.GetDeviceInfo()	1002
EFI_USBFN_IO_PROTOCOL.GetVendorIdProductId()	1004
EFI_USBFN_IO_PROTOCOL.AbortTransfer()	1005
EFI_USBFN_IO_PROTOCOL.GetEndpointStallState()	1006
EFI_USBFN_IO_PROTOCOL.SetEndpointStallState()	1007
EFI_USBFN_IO_PROTOCOL.EventHandler()	1008
EFI_USBFN_IO_PROTOCOL.Transfer()	1012
EFI_USBFN_IO_PROTOCOL.GetMaxTransferSize()	1014
EFI_USBFN_IO_PROTOCOL.AllocateTransferBuffer()	1015
EFI_USBFN_IO_PROTOCOL.FreeTransferBuffer()	1016
EFI_USBFN_IO_PROTOCOL.StartController()	1017
EFI_USBFN_IO_PROTOCOL.StopController()	1018
EFI_USBFN_IO_PROTOCOL.SetEndpointPolicy()	1019
EFI_USBFN_IO_PROTOCOL.GetEndpointPolicy()	1022
<b>18 Protocols — Debugger Support</b>	<b>1025</b>
18.1 Overview	1025
18.2 EFI Debug Support Protocol	1026
18.2.1 EFI Debug Support Protocol Overview	1026
EFI_DEBUG_SUPPORT_PROTOCOL	1026
EFI_DEBUG_SUPPORT_PROTOCOL.GetMaximumProcessorIndex()	1029
EFI_DEBUG_SUPPORT_PROTOCOL.RegisterPeriodicCallback()	1030
EFI_DEBUG_SUPPORT_PROTOCOL.RegisterExceptionCallback()	1039
EFI_DEBUG_SUPPORT_PROTOCOL.InvalidateInstructionCache()	1045
18.3 EFI Debugport Protocol	1046
18.3.1 EFI Debugport Overview	1046
EFI_DEBUGPORT_PROTOCOL	1046
EFI_DEBUGPORT_PROTOCOL.Reset()	1048
EFI_DEBUGPORT_PROTOCOL.Write()	1049

EFI_DEBUGPORT_PROTOCOL.Read()	1050
EFI_DEBUGPORT_PROTOCOL.Poll()	1051
18.3.2 Debugport Device Path	1051
18.3.3 EFI Debugport Variable	1052
18.4 EFI Debug Support Table	1053
18.4.1 Overview	1053
18.4.2 EFI System Table Location	1054
18.4.3 EFI Image Info	1054
<b>19 Protocols — Compression Algorithm Specification</b>	<b>1057</b>
19.1 Algorithm Overview	1057
19.2 Data Format	1058
19.2.1 Bit Order	1058
19.2.2 Overall Structure	1059
19.2.3 Block Structure	1060
19.3 Compressor Design	1063
19.3.1 Overall Process	1063
19.3.2 String Info Log	1064
19.3.3 Huffman Code Generation	1067
19.4 Decompressor Design	1069
19.5 Decompress Protocol	1070
EFI_DECOMPRESS_PROTOCOL	1070
EFI_DECOMPRESS_PROTOCOL.GetInfo()	1072
EFI_DECOMPRESS_PROTOCOL.Decompress()	1074
<b>20 Protocols — ACPI Protocols</b>	<b>1077</b>
EFI_ACPI_TABLE_PROTOCOL	1077
EFI_ACPI_TABLE_PROTOCOL.InstallAcpiTable()	1078
EFI_ACPI_TABLE_PROTOCOL.UninstallAcpiTable()	1080
<b>21 Protocols — String Services</b>	<b>1081</b>
21.1 Unicode Collation Protocol	1081
EFI_UNICODE_COLLATION_PROTOCOL	1081
EFI_UNICODE_COLLATION_PROTOCOL.StriColl()	1083
EFI_UNICODE_COLLATION_PROTOCOL.MetaiMatch()	1084
EFI_UNICODE_COLLATION_PROTOCOL.StrLwr()	1086
EFI_UNICODE_COLLATION_PROTOCOL.StrUpr()	1087
EFI_UNICODE_COLLATION_PROTOCOL.FatToStr()	1088
EFI_UNICODE_COLLATION_PROTOCOL.StrToFat()	1089
21.2 Regular Expression Protocol	1089
EFI_REGULAR_EXPRESSION_PROTOCOL	1090
EFI_REGULAR_EXPRESSION_PROTOCOL.MatchString()	1091
EFI_REGULAR_EXPRESSION_PROTOCOL.GetInfo()	1093
21.2.1 EFI Regular Expression Syntax Type Definitions	1094
<b>22 EFI Byte Code Virtual Machine</b>	<b>1097</b>
22.1 Overview	1097
22.1.1 Processor Architecture Independence	1097

22.1.2 OS Independent .....	1098
22.1.3 EFI Compliant .....	1098
22.1.4 Coexistence of Legacy Option ROMs .....	1098
22.1.5 Relocatable Image .....	1098
22.1.6 Size Restrictions Based on Memory Available .....	1098
22.2 Memory Ordering.....	1099
22.3 Virtual Machine Registers.....	1099
22.4 Natural Indexing .....	1100
22.4.1 Sign Bit.....	1101
22.4.2 Bits Assigned to Natural Units.....	1101
22.4.3 Constant.....	1101
22.4.4 Natural Units .....	1102
22.5 EBC Instruction Operands.....	1102
22.5.1 Direct Operands .....	1102
22.5.2 Indirect Operands.....	1103
22.5.3 Indirect with Index Operands .....	1103
22.5.4 Immediate Operands .....	1103
22.6 EBC Instruction Syntax .....	1104
22.7 Instruction Encoding .....	1104
22.7.1 Instruction Opcode Byte Encoding .....	1104
22.7.2 Instruction Operands Byte Encoding .....	1105
22.7.3 Index/Immediate Data Encoding.....	1105
22.8 EBC Instruction Set .....	1106
ADD.....	1107
AND.....	1108
ASHR .....	1109
BREAK .....	1110
CALL .....	1112
CMP.....	1115
CMPI .....	1117
DIV.....	1119
DIVU .....	1120
EXTNDB .....	1121
EXTNDD .....	1122
EXTNDW .....	1123
JMP .....	1124
JMP8 .....	1127
LOADSP .....	1128
MOD.....	1129
MODU .....	1130
MOV.....	1131
MOVI.....	1133
MOVIn.....	1135
MOVn .....	1136
MOVREL.....	1137
MOVsn.....	1138
MUL.....	1140

MULU .....	1141
NEG .....	1142
NOT .....	1143
OR .....	1144
POP .....	1145
POPn .....	1146
PUSH .....	1147
PUSHn .....	1148
RET .....	1149
SHL .....	1150
SHR .....	1151
STORESP .....	1152
SUB .....	1153
XOR .....	1154
22.9 Runtime and Software Conventions .....	1155
22.9.1 Calling Outside VM .....	1155
22.9.2 Calling Inside VM .....	1155
22.9.3 Parameter Passing .....	1155
22.9.4 Return Values .....	1155
22.9.5 Binary Format .....	1155
22.10 Architectural Requirements .....	1155
22.10.1 EBC Image Requirements .....	1155
22.10.2 EBC Execution Interfacing Requirements .....	1156
22.10.3 Interfacing Function Parameters Requirements .....	1156
22.10.4 Function Return Requirements .....	1156
22.10.5 Function Return Values Requirements .....	1156
22.11 EBC Interpreter Protocol .....	1157
EFI_EBC_PROTOCOL .....	1157
EFI_EBC_PROTOCOL.CreateThunk() .....	1158
EFI_EBC_PROTOCOL.UnloadImage() .....	1159
EFI_EBC_PROTOCOL.RegisterICacheFlush() .....	1160
EFI_EBC_PROTOCOL.GetVersion() .....	1162
22.12 EBC Tools .....	1162
22.12.1 EBC C Compiler .....	1162
22.12.2 C Coding Convention .....	1162
22.12.3 EBC Interface Assembly Instructions .....	1163
22.12.4 Stack Maintenance and Argument Passing .....	1163
22.12.5 Native to EBC Arguments Calling Convention .....	1163
22.12.6 EBC to Native Arguments Calling Convention .....	1163
22.12.7 EBC to EBC Arguments Calling Convention .....	1164
22.12.8 Function Returns .....	1164
22.12.9 Function Return Values .....	1164
22.12.10 Thunking .....	1164
22.12.11 EBC Linker .....	1166
22.12.12 Image Loader .....	1167
22.12.13 Debug Support .....	1167
22.13 VM Exception Handling .....	1167

22.13.1 Divide By 0 Exception.....	1168
22.13.2 Debug Break Exception .....	1168
22.13.3 Invalid Opcode Exception .....	1168
22.13.4 Stack Fault Exception.....	1168
22.13.5 Alignment Exception .....	1168
22.13.6 Instruction Encoding Exception.....	1168
22.13.7 Bad Break Exception.....	1169
22.13.8 Undefined Exception.....	1169
22.14 Option ROM Formats.....	1169
22.14.1 EFI Drivers for PCI Add-in Cards.....	1169
22.14.2 Non-PCI Bus Support .....	1169
<b>23 Firmware Update and Reporting.....</b>	<b>1171</b>
23.1 Firmware Management Protocol.....	1171
EFI_FIRMWARE_MANAGEMENT_PROTOCOL.....	1171
EFI_FIRMWARE_MANAGEMENT_PROTOCOL.GetImageInfo() .....	1173
EFI_FIRMWARE_MANAGEMENT_PROTOCOL.GetImage() .....	1180
EFI_FIRMWARE_MANAGEMENT_PROTOCOL.SetImage().....	1182
EFI_FIRMWARE_MANAGEMENT_PROTOCOL.CheckImage().....	1185
EFI_FIRMWARE_MANAGEMENT_PROTOCOL.GetPackageInfo() .....	1187
EFI_FIRMWARE_MANAGEMENT_PROTOCOL.SetPackageInfo().....	1189
23.2 Delivering Capsules Containing Updates to Firmware Management Protocol .....	1190
23.2.1 EFI_FIRMWARE_MANAGEMENT_CAPSULE_ID_GUID.....	1190
23.2.2 DEFINED FIRMWARE MANAGEMENT PROTOCOL DATA CAPSULE STRUCTURE	1191
23.2.3 Firmware Processing of the Capsule Identified by	
EFI_FIRMWARE_MANAGEMENT_CAPSULE_ID_GUID .....	1195
23.3 EFI System Resource Table .....	1197
EFI_SYSTEM_RESOURCE_TABLE .....	1197
23.3.1 Adding and Removing Devices from the ESRT .....	1200
23.3.2 ESRT and Firmware Management Protocol .....	1200
23.3.3 Mapping Firmware Management Protocol Descriptors to ESRT Entries .....	1201
<b>24 Network Protocols — SNP, PXE, BIS and HTTP Boot.....</b>	<b>1203</b>
24.1 Simple Network Protocol .....	1203
EFI_SIMPLE_NETWORK_PROTOCOL .....	1203
EFI_SIMPLE_NETWORK.Start() .....	1208
EFI_SIMPLE_NETWORK.Stop().....	1209
EFI_SIMPLE_NETWORK.Initialize() .....	1210
EFI_SIMPLE_NETWORK.Reset().....	1211
EFI_SIMPLE_NETWORK.Shutdown() .....	1212
EFI_SIMPLE_NETWORK.ReceiveFilters().....	1213
EFI_SIMPLE_NETWORK.StationAddress() .....	1216
EFI_SIMPLE_NETWORK.Statistics().....	1217
EFI_SIMPLE_NETWORK.MCastIPtoMAC() .....	1221
EFI_SIMPLE_NETWORK.NvData() .....	1222
EFI_SIMPLE_NETWORK.GetStatus() .....	1224
EFI_SIMPLE_NETWORK.Transmit().....	1226



EFI_SIMPLE_NETWORK.Receive()	1228
24.2 Network Interface Identifier Protocol	1229
EFI_NETWORK_INTERFACE_IDENTIFIER_PROTOCOL	1229
24.3 PXE Base Code Protocol	1232
EFI_PXE_BASE_CODE_PROTOCOL	1232
EFI_PXE_BASE_CODE_PROTOCOL.Start()	1245
EFI_PXE_BASE_CODE_PROTOCOL.Stop()	1247
EFI_PXE_BASE_CODE_PROTOCOL.Dhcp()	1248
EFI_PXE_BASE_CODE_PROTOCOL.Discover()	1250
EFI_PXE_BASE_CODE_PROTOCOL.Mtftp()	1254
EFI_PXE_BASE_CODE_PROTOCOL.UdpWrite()	1258
EFI_PXE_BASE_CODE_PROTOCOL.UdpRead()	1260
EFI_PXE_BASE_CODE_PROTOCOL.SetIpFilter()	1264
EFI_PXE_BASE_CODE_PROTOCOL.Arp()	1266
EFI_PXE_BASE_CODE_PROTOCOL.SetParameters()	1268
EFI_PXE_BASE_CODE_PROTOCOL.SetStationIp()	1270
EFI_PXE_BASE_CODE_PROTOCOL.SetPackets()	1272
24.3.1 Netboot6	1273
24.4 PXE Base Code Callback Protocol	1279
EFI_PXE_BASE_CODE_CALLBACK_PROTOCOL	1280
EFI_PXE_BASE_CODE_CALLBACK.Callback()	1281
24.5 Boot Integrity Services Protocol	1282
EFI_BIS_PROTOCOL	1283
EFI_BIS_PROTOCOL.Initialize()	1286
EFI_BIS_PROTOCOL.Shutdown()	1290
EFI_BIS_PROTOCOL.Free()	1291
EFI_BIS_PROTOCOL.GetBootObjectAuthorizationCertificate()	1292
EFI_BIS_PROTOCOL.GetBootObjectAuthorizationCheckFlag()	1293
EFI_BIS_PROTOCOL.GetBootObjectAuthorizationUpdateToken()	1294
EFI_BIS_PROTOCOL.GetSignatureInfo()	1295
EFI_BIS_PROTOCOL.UpdateBootObjectAuthorization()	1300
EFI_BIS_PROTOCOL.VerifyBootObject()	1308
EFI_BIS_PROTOCOL.VerifyObjectWithCredential()	1316
24.6 DHCP options for iSCSI on IPV6	1323
24.7 HTTP Boot	1323
24.7.1 Boot from URL	1323
24.7.2 Concept configuration for a typical HTTP Boot scenario	1324
24.7.3 Protocol Layout for UEFI HTTP Boot Client concept configuration for a typical HTTP Boot scenario	1326
24.7.4 Concept of Message Exchange in a typical HTTP Boot scenario (IPv4 in Corporate Environment)	1329
24.7.5 Concept of Message Exchange in HTTP Boot scenario (IPv6)	1333
24.7.6 EFI HTTP Boot Callback Protocol	1336
EFI_HTTP_BOOT_CALLBACK_PROTOCOL	1336
EFI_HTTP_BOOT_CALLBACK_PROTOCOL.Callback()	1337

<b>25 Network Protocols — Managed Network</b> .....	<b>1339</b>
25.1 EFI Managed Network Protocol .....	1339
EFI_MANAGED_NETWORK_SERVICE_BINDING_PROTOCOL .....	1339
EFI_MANAGED_NETWORK_PROTOCOL .....	1340
EFI_MANAGED_NETWORK_PROTOCOL.GetModeData() .....	1342
EFI_MANAGED_NETWORK_PROTOCOL.Configure() .....	1345
EFI_MANAGED_NETWORK_PROTOCOL.McastIpToMac() .....	1347
EFI_MANAGED_NETWORK_PROTOCOL.Groups() .....	1349
EFI_MANAGED_NETWORK_PROTOCOL.Transmit() .....	1351
EFI_MANAGED_NETWORK_PROTOCOL.Receive() .....	1357
EFI_MANAGED_NETWORK_PROTOCOL.Cancel() .....	1359
EFI_MANAGED_NETWORK_PROTOCOL.Poll() .....	1360
<b>26 Network Protocols — VLAN, EAP, Wi-Fi and Supplicant</b> .....	<b>1361</b>
26.1 VLAN Configuration Protocol .....	1361
EFI_VLAN_CONFIG_PROTOCOL .....	1361
EFI_VLAN_CONFIG_PROTOCOL.Set () .....	1362
EFI_VLAN_CONFIG_PROTOCOL.Find() .....	1364
EFI_VLAN_CONFIG_PROTOCOL.Remove () .....	1366
26.2 EAP Protocol .....	1366
EFI_EAP_PROTOCOL .....	1366
EFI_EAP.SetDesiredAuthMethod() .....	1368
EFI_EAP.RegisterAuthMethod() .....	1369
26.2.1 EAPManagement Protocol .....	1371
EFI_EAP_MANAGEMENT_PROTOCOL .....	1371
EFI_EAP_MANAGEMENT.GetSystemConfiguration() .....	1373
EFI_EAP_MANAGEMENT.SetSystemConfiguration() .....	1375
EFI_EAP_MANAGEMENT.InitializePort() .....	1376
EFI_EAP_MANAGEMENT.UserLogon() .....	1377
EFI_EAP_MANAGEMENT.UserLogoff() .....	1378
EFI_EAP_MANAGEMENT.GetSupplicantStatus() .....	1379
EFI_EAP_MANAGEMENT.SetSupplicantConfiguration() .....	1382
EFI_EAP_MANAGEMENT.GetSupplicantStatistics() .....	1383
26.2.2 EFI EAP Management2 Protocol .....	1385
EFI_EAP_MANAGEMENT2_PROTOCOL .....	1385
EFI_EAP_MANAGEMENT2_PROTOCOL.GetKey() .....	1386
26.2.3 EFI EAP Configuration Protocol .....	1386
EFI_EAP_CONFIGURATION_PROTOCOL .....	1386
EFI_EAP_CONFIGURATION_PROTOCOL.SetData() .....	1388
EFI_EAP_CONFIGURATION_PROTOCOL.GetData() .....	1391
26.3 EFI Wireless MAC Connection Protocol .....	1392
EFI_WIRELESS_MAC_CONNECTION_PROTOCOL .....	1392
EFI_WIRELESS_MAC_CONNECTION_PROTOCOL.Scan() .....	1393
EFI_WIRELESS_MAC_CONNECTION_PROTOCOL.Associate() .....	1404
EFI_WIRELESS_MAC_CONNECTION_PROTOCOL.Disassociate() .....	1409
EFI_WIRELESS_MAC_CONNECTION_PROTOCOL.Authenticate() .....	1412
EFI_WIRELESS_MAC_CONNECTION_PROTOCOL.Deauthenticate() .....	1416

26.4	EFI Wireless MAC Connection II Protocol .....	1417
	EFI_WIRELESS_MAC_CONNECTION_II_PROTOCOL.....	1417
	EFI_WIRELESS_MAC_CONNECTION_II_PROTOCOL.GetNetworks() .....	1419
	EFI_WIRELESS_MAC_CONNECTION_II_PROTOCOL.ConnectNetwork() .....	1425
	EFI_WIRELESS_MAC_CONNECTION_II_PROTOCOL.DisconnectNetwork() ....	1429
26.5	EFI Supplicant Protocol.....	1430
26.5.1	Supplicant Service Binding Protocol.....	1430
	EFI_SUPPLICANT_SERVICE_BINDING_PROTOCOL.....	1430
26.5.2	Supplicant Protocol.....	1431
	EFI_SUPPLICANT_PROTOCOL .....	1431
	EFI_SUPPLICANT_PROTOCOL.BuildResponsePacket().....	1433
	EFI_SUPPLICANT_PROTOCOL.ProcessPacket().....	1435
	EFI_SUPPLICANT_PROTOCOL.SetData() .....	1437
	EFI_SUPPLICANT_PROTOCOL.GetData() .....	1444
<b>27</b>	<b>Network Protocols — Bluetooth .....</b>	<b>1445</b>
27.1	EFI Bluetooth Host Controller Protocol .....	1445
	EFI_BLUETOOTH_HC_PROTOCOL .....	1445
	BLUETOOTH_HC_PROTOCOL.SendCommand() .....	1447
	BLUETOOTH_HC_PROTOCOL.ReceiveEvent().....	1449
	BLUETOOTH_HC_PROTOCOL.AsyncReceiveEvent() .....	1450
	BLUETOOTH_HC_PROTOCOL.SendACLData().....	1452
	BLUETOOTH_HC_PROTOCOL.ReceiveACLData() .....	1454
	BLUETOOTH_HC_PROTOCOL.AsyncReceiveACLData().....	1455
	BLUETOOTH_HC_PROTOCOL.SendSCOData().....	1456
	BLUETOOTH_HC_PROTOCOL.ReceiveSCOData().....	1457
	BLUETOOTH_HC_PROTOCOL.AsyncReceiveSCOData() .....	1458
27.2	EFI Bluetooth Bus Protocol.....	1459
	EFI_BLUETOOTH_IO_SERVICE_BINDING_PROTOCOL.....	1459
	EFI_BLUETOOTH_IO_PROTOCOL.....	1459
	BLUETOOTH_IO_PROTOCOL.GetDeviceInfo .....	1462
	BLUETOOTH_IO_PROTOCOL.GetSdplInfo.....	1464
	BLUETOOTH_IO_PROTOCOL.L2CapRawSend.....	1465
	BLUETOOTH_IO_PROTOCOL.L2CapRawReceive .....	1466
	BLUETOOTH_IO_PROTOCOL.L2CapRawAsyncReceive .....	1467
	BLUETOOTH_IO_PROTOCOL.L2CapSend .....	1469
	BLUETOOTH_IO_PROTOCOL.L2CapReceive .....	1471
	BLUETOOTH_IO_PROTOCOL.L2CapAsyncReceive.....	1473
	BLUETOOTH_IO_PROTOCOL.L2CapConnect.....	1475
	BLUETOOTH_IO_PROTOCOL.L2CapDisconnect.....	1476
	BLUETOOTH_IO_PROTOCOL.L2CapRegisterService .....	1477
27.3	EFI Bluetooth Configuration Protocol.....	1477
	EFI_BLUETOOTH_CONFIG_PROTOCOL.....	1477
	BLUETOOTH_CONFIG_PROTOCOL.Init.....	1480
	BLUETOOTH_CONFIG_PROTOCOL.Scan .....	1481
	BLUETOOTH_CONFIG_PROTOCOL.Connect .....	1483
	BLUETOOTH_CONFIG_PROTOCOL.Disconnect .....	1484

BLUETOOTH_CONFIG_PROTOCOL.GetData.....	1485
BLUETOOTH_CONFIG_PROTOCOL.SetData.....	1488
BLUETOOTH_CONFIG_PROTOCOL.GetRemoteData.....	1489
BLUETOOTH_CONFIG_PROTOCOL.RegisterPinCallback.....	1490
BLUETOOTH_CONFIG_PROTOCOL.RegisterGetLinkKeyCallback.....	1492
BLUETOOTH_CONFIG_PROTOCOL.RegisterSetLinkKeyCallback.....	1494
BLUETOOTH_CONFIG_PROTOCOL.RegisterLinkConnectCompleteCallback.....	1496
27.4 EFI Bluetooth Attribute Protocol.....	1498
EFI_BLUETOOTH_ATTRIBUTE_PROTOCOL.....	1498
EFI_BLUETOOTH_ATTRIBUTE_SERVICE_BINDING_PROTOCOL.....	1509
27.5 EFI Bluetooth LE Configuration Protocol.....	1509
EFI_BLUETOOTH_LE_CONFIG_PROTOCOL.....	1509
BLUETOOTH_LE_CONFIG_PROTOCOL.Scan.....	1513
BLUETOOTH_LE_CONFIG_PROTOCOL.RegisterSmpSetDataCallback.....	1531
<b>28 Network Protocols —TCP, IP, IPsec, FTP, TLS and Configurations .....</b>	<b>1535</b>
28.1 EFI TCPv4 Protocol.....	1535
28.1.1 TCP4 Service Binding Protocol.....	1535
EFI_TCP4_SERVICE_BINDING_PROTOCOL.....	1535
28.1.2 TCP4 Protocol.....	1535
EFI_TCP4_PROTOCOL.....	1535
EFI_TCP4_PROTOCOL.GetModeData().....	1538
EFI_TCP4_PROTOCOL.Configure().....	1543
EFI_TCP4_PROTOCOL.Routes().....	1545
EFI_TCP4_PROTOCOL.Connect().....	1547
EFI_TCP4_PROTOCOL.Accept().....	1550
EFI_TCP4_PROTOCOL.Transmit().....	1552
EFI_TCP4_PROTOCOL.Receive().....	1557
EFI_TCP4_PROTOCOL.Close().....	1559
EFI_TCP4_PROTOCOL.Cancel().....	1561
EFI_TCP4_PROTOCOL.Poll().....	1562
28.2 EFI TCPv6 Protocol.....	1562
28.2.1 TCPv6 Service Binding Protocol.....	1563
EFI_TCP6_SERVICE_BINDING_PROTOCOL.....	1563
28.2.2 TCPv6 Protocol.....	1564
EFI_TCP6_PROTOCOL.....	1564
EFI_TCP6_PROTOCOL.GetModeData().....	1566
EFI_TCP6_PROTOCOL.Configure().....	1571
EFI_TCP6_PROTOCOL.Connect().....	1573
EFI_TCP6_PROTOCOL.Accept().....	1576
EFI_TCP6_PROTOCOL.Transmit().....	1578
EFI_TCP6_PROTOCOL.Receive().....	1583
EFI_TCP6_PROTOCOL.Close().....	1585
EFI_TCP6_PROTOCOL.Cancel().....	1587
EFI_TCP6_PROTOCOL.Poll().....	1588
28.3 EFI IPv4 Protocol.....	1588
28.3.1 IP4 Service Binding Protocol.....	1589

EFI_IP4_SERVICE_BINDING_PROTOCOL .....	1589
28.3.2 IP4 Protocol.....	1589
EFI_IP4_PROTOCOL .....	1589
EFI_IP4_PROTOCOL.GetModeData().....	1591
EFI_IP4_PROTOCOL.Configure().....	1596
EFI_IP4_PROTOCOL.Groups() .....	1598
EFI_IP4_PROTOCOL.Routes().....	1600
EFI_IP4_PROTOCOL.Transmit().....	1602
EFI_IP4_PROTOCOL.Receive() .....	1608
EFI_IP4_PROTOCOL.Cancel() .....	1610
EFI_IP4_PROTOCOL.Poll() .....	1611
28.4 EFI IPv4 Configuration Protocol .....	1611
EFI_IP4_CONFIG_PROTOCOL .....	1612
EFI_IP4_CONFIG_PROTOCOL.Start() .....	1614
EFI_IP4_CONFIG_PROTOCOL.Stop().....	1616
EFI_IP4_CONFIG_PROTOCOL.GetData().....	1617
Related Definitions.....	1618
28.5 EFI IPv4 Configuration II Protocol.....	1618
EFI_IP4_CONFIG2_PROTOCOL .....	1619
EFI_IP4_CONFIG2_PROTOCOL.SetData() .....	1621
EFI_IP4_CONFIG2_PROTOCOL.GetData().....	1626
EFI_IP4_CONFIG2_PROTOCOL.RegisterDataNotify () .....	1628
EFI_IP4_CONFIG2_PROTOCOL.UnregisterDataNotify ().....	1629
28.6 EFI IPv6 Protocol .....	1629
28.6.1 IPv6 Service Binding Protocol .....	1630
EFI_IP6_SERVICE_BINDING_PROTOCOL .....	1630
28.6.2 IPv6 Protocol .....	1630
EFI_IP6_PROTOCOL .....	1630
EFI_IP6_PROTOCOL.GetModeData().....	1633
EFI_IP6_PROTOCOL.Configure().....	1642
EFI_IP6_PROTOCOL.Groups() .....	1644
EFI_IP6_PROTOCOL.Routes().....	1646
EFI_IP6_PROTOCOL.Neighbors().....	1648
EFI_IP6_PROTOCOL.Transmit().....	1650
EFI_IP6_PROTOCOL.Receive() .....	1656
EFI_IP6_PROTOCOL.Cancel() .....	1658
EFI_IP6_PROTOCOL.Poll() .....	1659
28.7 EFI IPv6 Configuration Protocol .....	1659
EFI_IP6_CONFIG_PROTOCOL .....	1659
EFI_IP6_CONFIG_PROTOCOL.SetData() .....	1661
EFI_IP6_CONFIG_PROTOCOL.GetData().....	1667
EFI_IP6_CONFIG_PROTOCOL.RegisterDataNotify () .....	1669
EFI_IP6_CONFIG_PROTOCOL.UnregisterDataNotify () .....	1670
28.8 IPsec .....	1670
28.8.1 IPsec Overview.....	1670
28.8.2 EFI IPsec Configuration Protocol .....	1671
EFI_IPSEC_CONFIG_PROTOCOL .....	1671

EFI_IPSEC_CONFIG_PROTOCOL.SetData()	1673
EFI_IPSEC_CONFIG_PROTOCOL.GetData()	1686
EFI_IPSEC_CONFIG_PROTOCOL.GetNextSelector()	1688
EFI_IPSEC_CONFIG_PROTOCOL.RegisterDataNotify ()	1690
EFI_IPSEC_CONFIG_PROTOCOL.UnregisterDataNotify ()	1691
28.8.3 EFI IPsec Protocol	1691
EFI_IPSEC_PROTOCOL	1691
EFI_IPSEC_PROTOCOL.Process()	1693
28.8.4 EFI IPsec2 Protocol	1694
EFI_IPSEC2_PROTOCOL	1694
EFI_IPSEC2_PROTOCOL.ProcessExt()	1696
28.9 Network Protocol - EFI FTP Protocol	1698
EFI_FTP4_SERVICE_BINDING_PROTOCOL Summary	1699
EFI_FTP4_PROTOCOL	1700
EFI_FTP4_PROTOCOL.GetModeData()	1702
EFI_FTP4_PROTOCOL.Connect()	1703
EFI_FTP4_PROTOCOL.Close()	1705
EFI_FTP4_PROTOCOL.Configure()	1706
EFI_FTP4_PROTOCOL.ReadFile()	1709
EFI_FTP4_PROTOCOL.WriteFile()	1712
EFI_FTP4_PROTOCOL.ReadDirectory()	1714
EFI_FTP4_PROTOCOL.Poll()	1716
28.10 EFI TLS Protocols	1716
28.10.1 EFI TLS Service Binding Protocol	1716
EFI_TLS_SERVICE_BINDING_PROTOCOL	1716
28.10.2 EFI TLS Protocol	1717
EFI_TLS_PROTOCOL	1717
EFI_TLS_PROTOCOL.SetSessionData ()	1719
EFI_TLS_PROTOCOL.GetSessionData ()	1725
EFI_TLS_PROTOCOL.BuildResponsePacket ()	1726
EFI_TLS_PROTOCOL.ProcessPacket ()	1728
28.10.3 EFI TLS Configuration Protocol	1729
EFI_TLS_CONFIGURATION_PROTOCOL	1729
EFI_TLS_CONFIGURATION_PROTOCOL.SetData()	1731
EFI_TLS_CONFIGURATION_PROTOCOL.GetData()	1733
<b>29 Network Protocols — ARP, DHCP, DNS, HTTP and REST</b>	<b>1735</b>
29.1 ARP Protocol	1735
EFI_ARP_SERVICE_BINDING_PROTOCOL	1735
EFI_ARP_PROTOCOL	1736
EFI_ARP_PROTOCOL.Configure()	1738
EFI_ARP_PROTOCOL.Add()	1740
EFI_ARP_PROTOCOL.Find()	1742
Related Definitions	1743
EFI_ARP_PROTOCOL.Delete()	1744
EFI_ARP_PROTOCOL.Flush()	1745
EFI_ARP_PROTOCOL.Request()	1746

EFI_ARP_PROTOCOL.Cancel()	1748
29.2 EFI DHCPv4 Protocol	1749
EFI_DHCP4_SERVICE_BINDING_PROTOCOL	1749
EFI_DHCP4_PROTOCOL	1749
EFI_DHCP4_PROTOCOL.GetModeData()	1752
EFI_DHCP4_PROTOCOL.Configure()	1756
EFI_DHCP4_PROTOCOL.Start()	1763
EFI_DHCP4_PROTOCOL.RenewRebind()	1765
EFI_DHCP4_PROTOCOL.Release()	1767
EFI_DHCP4_PROTOCOL.Stop()	1768
EFI_DHCP4_PROTOCOL.Build()	1769
EFI_DHCP4_PROTOCOL.TransmitReceive()	1771
EFI_DHCP4_PROTOCOL.Parse()	1774
29.3 EFI DHCP6 Protocol	1775
29.3.1 DHCP6 Service Binding Protocol	1775
EFI_DHCP6_SERVICE_BINDING_PROTOCOL	1775
29.3.2 DHCP6 Protocol	1776
EFI_DHCP6_PROTOCOL	1776
EFI_DHCP6_PROTOCOL.GetModeData ()	1778
EFI_DHCP6_PROTOCOL.Configure ()	1784
EFI_DHCP6_PROTOCOL.Start ()	1791
EFI_DHCP6_PROTOCOL.InfoRequest ()	1793
EFI_DHCP6_PROTOCOL.RenewRebind ()	1796
EFI_DHCP6_PROTOCOL.Decline ()	1798
EFI_DHCP6_PROTOCOL.Release ()	1800
EFI_DHCP6_PROTOCOL.Stop ()	1802
EFI_DHCP6_PROTOCOL.Parse ()	1803
29.4 EFI DNSv4 Protocol	1804
EFI_DNS4_SERVICE_BINDING_PROTOCOL	1804
EFI_DNS4_PROTOCOL	1805
EFI_DNS4_PROTOCOL.GetModeData()	1806
EFI_DNS4_PROTOCOL.Configure()	1809
EFI_DNS4_PROTOCOL.HostNameToIp()	1810
EFI_DNS4_PROTOCOL.IpToHostName()	1814
EFI_DNS4_PROTOCOL.GeneralLookup()	1815
EFI_DNS4_PROTOCOL.UpdateDnsCache()	1817
EFI_DNS4_PROTOCOL.Poll()	1818
EFI_DNS4_PROTOCOL.Cancel()	1819
29.5 EFI DNSv6 Protocol	1820
29.5.1 DNS6 Service Binding Protocol	1820
EFI_DNS6_SERVICE_BINDING_PROTOCOL	1820
29.5.2 DNS6 Protocol	1821
EFI_DNS6_PROTOCOL	1821
EFI_DNS6_PROTOCOL.GetModeData()	1823
EFI_DNS6_PROTOCOL.Configure()	1826
EFI_DNS6_PROTOCOL.HostNameToIp()	1827
EFI_DNS6_PROTOCOL.IpToHostName()	1831

EFI_DNS6_PROTOCOL.GeneralLookUp()	1832
EFI_DNS6_PROTOCOL.UpdateDnsCache()	1834
EFI_DNS6_PROTOCOL.POLL()	1835
EFI_DNS6_PROTOCOL.Cancel()	1836
29.6 EFI HTTP Protocols	1836
29.6.1 HTTP Service Binding Protocol	1837
EFI_HTTP_SERVICE_BINDING_PROTOCOL	1837
29.6.2 EFI HTTP Protocol Specific Definitions	1838
EFI_HTTP_PROTOCOL	1838
EFI_HTTP_PROTOCOL.GetModeData()	1839
EFI_HTTP_PROTOCOL.Configure()	1842
EFI_HTTP_PROTOCOL.Request()	1844
EFI_HTTP_PROTOCOL.Cancel()	1850
EFI_HTTP_PROTOCOL.Response()	1851
EFI_HTTP_PROTOCOL.Poll()	1853
29.6.3 HTTP Utilities Protocol	1860
EFI_HTTP_UTILITIES_PROTOCOL	1861
EFI_HTTP_UTILITIES_PROTOCOL.Build()	1862
EFI_HTTP_UTILITIES_PROTOCOL.Parse()	1864
29.7 EFI REST Protocol	1864
29.7.1 EFI REST Protocol Definitions	1865
EFI_REST_PROTOCOL	1865
EFI_REST_PROTOCOL.SendReceive()	1866
EFI_REST_PROTOCOL.GetServiceTime()	1867
<b>30 Network Protocols — UDP and MTFTP</b>	<b>1869</b>
30.1 EFI UDP Protocol	1869
30.1.1 UDP4 Service Binding Protocol	1869
EFI_UDP4_SERVICE_BINDING_PROTOCOL	1869
30.1.2 UDP4 Protocol	1869
EFI_UDP4_PROTOCOL	1869
EFI_UDP4_PROTOCOL.GetModeData()	1872
EFI_UDP4_PROTOCOL.Configure()	1875
EFI_UDP4_PROTOCOL.Groups()	1877
EFI_UDP4_PROTOCOL.Routes()	1878
EFI_UDP4_PROTOCOL.Transmit()	1880
EFI_UDP4_PROTOCOL.Receive()	1886
EFI_UDP4_PROTOCOL.Cancel()	1888
EFI_UDP4_PROTOCOL.Poll()	1889
30.2 EFI UDPv6 Protocol	1889
30.2.1 UDP6 Service Binding Protocol	1890
EFI_UDP6_SERVICE_BINDING_PROTOCOL	1890
30.2.2 EFI UDP6 Protocol	1890
EFI_UDP6_PROTOCOL	1890
EFI_UDP6_PROTOCOL.GetModeData()	1892
EFI_UDP6_PROTOCOL.Configure()	1895
EFI_UDP6_PROTOCOL.Groups()	1897



EFI_UDP6_PROTOCOL.Transmit().....	1898
EFI_UDP6_PROTOCOL.Receive().....	1904
EFI_UDP6_PROTOCOL.Cancel().....	1906
EFI_UDP6_PROTOCOL.Poll().....	1907
30.3 EFI MTFTPv4 Protocol.....	1907
EFI_MTFTP4_SERVICE_BINDING_PROTOCOL.....	1907
EFI_MTFTP4_PROTOCOL.....	1908
EFI_MTFTP4_PROTOCOL.GetModeData().....	1910
EFI_MTFTP4_PROTOCOL.Configure().....	1913
EFI_MTFTP4_PROTOCOL.GetInfo().....	1915
EFI_MTFTP4_PROTOCOL.ParseOptions().....	1924
EFI_MTFTP4_PROTOCOL.ReadFile().....	1926
EFI_MTFTP4_PROTOCOL.WriteFile().....	1932
EFI_MTFTP4_PROTOCOL.ReadDirectory().....	1934
EFI_MTFTP4_PROTOCOL.POLL().....	1936
30.4 EFI MTFTPv6 Protocol.....	1936
30.4.1 MTFTP6 Service Binding Protocol.....	1937
EFI_MTFTP6_SERVICE_BINDING_PROTOCOL.....	1937
30.4.2 MTFTP6 Protocol.....	1937
EFI_MTFTP6_PROTOCOL.....	1937
EFI_MTFTP6_PROTOCOL.GetModeData().....	1939
EFI_MTFTP6_PROTOCOL.Configure().....	1941
EFI_MTFTP6_PROTOCOL.GetInfo().....	1943
EFI_MTFTP6_PROTOCOL.ParseOptions().....	1953
EFI_MTFTP6_PROTOCOL.ReadFile().....	1955
EFI_MTFTP6_PROTOCOL.WriteFile().....	1961
EFI_MTFTP6_PROTOCOL.ReadDirectory().....	1963
EFI_MTFTP6_PROTOCOL.Poll().....	1965
<b>31 Secure Boot and Driver Signing.....</b>	<b>1967</b>
31.1 Secure Boot.....	1967
EFI_AUTHENTICATION_INFO_PROTOCOL.....	1967
EFI_AUTHENTICATION_INFO_PROTOCOL.Get().....	1968
EFI_AUTHENTICATION_INFO_PROTOCOL.Set().....	1969
31.2 UEFI Driver Signing Overview.....	1973
31.2.1 Digital Signatures.....	1973
31.2.2 Embedded Signatures.....	1975
31.2.3 Creating Image Digests from Images.....	1976
31.2.4 Code Definitions.....	1976
WIN_CERTIFICATE.....	1977
WIN_CERTIFICATE_EFI_PKCS1_15.....	1978
WIN_CERTIFICATE_UEFI_GUID.....	1979
31.3 Firmware/OS Key Exchange: creating trust relationships.....	1980
31.3.1 Enrolling The Platform Key.....	1982
31.3.2 Clearing The Platform Key.....	1983
31.3.3 Transitioning to Audit Mode.....	1983
31.3.4 Transitioning to Deployed Mode.....	1983

31.3.5	Enrolling Key Exchange Keys.....	1983
31.3.6	Platform Firmware Key Storage Requirements .....	1984
31.4	Firmware/OS Key Exchange: passing public keys .....	1984
31.4.1	Signature Database .....	1985
EFI_SIGNATURE_DATA .....	1985	
31.4.2	Image Execution Information Table.....	1990
31.5	UEFI Image Validation.....	1993
31.5.1	Overview.....	1993
31.5.2	Authorized User.....	1994
31.5.3	Signature Database Update .....	1994
31.6	Code Definitions.....	2000
31.6.1	UEFI Image Variable GUID & Variable Name.....	2000
<b>32</b>	<b>Human Interface Infrastructure Overview .....</b>	<b>2001</b>
32.1	Goals.....	2001
32.2	Design Discussion.....	2002
32.2.1	Drivers And Applications.....	2003
32.2.2	Localization .....	2010
32.2.3	User Input.....	2010
32.2.4	Keyboard Layout .....	2011
32.2.5	Forms .....	2015
32.2.6	Strings.....	2044
32.2.7	Fonts.....	2049
32.2.8	Images .....	2056
32.2.9	HII Database.....	2057
32.2.10	Forms Browser .....	2057
32.2.11	Configuration Settings.....	2062
32.2.12	Form Callback Logic.....	2066
32.2.13	Driver Model Interaction .....	2069
32.2.14	Human Interface Component Interactions .....	2070
32.2.15	Standards Map Forms.....	2071
32.3	Code Definitions.....	2075
32.3.1	Package Lists and Package Headers.....	2076
EFI_HII_PACKAGE_HEADER.....	2076	
32.3.2	Simplified Font Package .....	2078
32.3.3	Font Package .....	2081
32.3.4	Device Path Package .....	2093
32.3.5	GUID Package .....	2094
32.3.6	String Package .....	2094
32.3.7	Image Package .....	2110
32.3.8	Forms Package.....	2128
32.3.9	Keyboard Package.....	2210
32.3.10	Animations Package.....	2210
<b>33</b>	<b>HII Protocols .....</b>	<b>2223</b>
33.1	Font Protocol.....	2223
EFI_HII_FONT_PROTOCOL.....	2223	
EFI_HII_FONT_PROTOCOL.StringToImage() .....	2224	

EFI_HII_FONT_PROTOCOL.StringIdToImage()	2228
EFI_HII_FONT_PROTOCOL.GetGlyph()	2231
EFI_HII_FONT_PROTOCOL.GetFontInfo()	2233
33.2 EFI HII Font Ex Protocol	2234
EFI_HII_FONT_EX_PROTOCOL	2234
EFI_HII_FONT_EX_PROTOCOL.StringToImageEx()	2235
EFI_HII_FONT_EX_PROTOCOL.StringIdToImageEx()	2236
EFI_HII_FONT_EX_PROTOCOL.GetGlyphEx()	2237
EFI_HII_FONT_EX_PROTOCOL.GetFontInfoEx()	2238
EFI_HII_FONT_EX_PROTOCOL.GetGlyphInfo()	2239
33.2.1 Code Definitions	2240
EFI_FONT_DISPLAY_INFO	2240
EFI_IMAGE_OUTPUT	2242
33.3 String Protocol	2243
EFI_HII_STRING_PROTOCOL	2243
EFI_HII_STRING_PROTOCOL.NewString()	2244
EFI_HII_STRING_PROTOCOL.GetString()	2246
EFI_HII_STRING_PROTOCOL.SetString()	2248
EFI_HII_STRING_PROTOCOL.GetLanguages()	2250
EFI_HII_STRING_PROTOCOL.GetSecondaryLanguages()	2251
33.4 Image Protocol	2252
EFI_HII_IMAGE_PROTOCOL	2252
EFI_HII_IMAGE_PROTOCOL.NewImage()	2253
EFI_HII_IMAGE_PROTOCOL.GetImage()	2255
EFI_HII_IMAGE_PROTOCOL.SetImage()	2256
EFI_HII_IMAGE_PROTOCOL.DrawImage()	2257
EFI_HII_IMAGE_PROTOCOL.DrawImageId()	2259
33.5 EFI HII Image Ex Protocol	2260
EFI_HII_IMAGE_EX_PROTOCOL	2260
EFI_HII_IMAGE_EX_PROTOCOL.NewImageEx()	2262
EFI_HII_IMAGE_EX_PROTOCOL.GetImageEx()	2263
EFI_HII_IMAGE_EX_PROTOCOL.SetImageEx()	2264
EFI_HII_IMAGE_EX_PROTOCOL.DrawImageEx()	2265
EFI_HII_IMAGE_EX_PROTOCOL.DrawImageIdEx()	2266
EFI_HII_IMAGE_EX_PROTOCOL.GetImageInfo()	2267
33.6 EFI HII Image Decoder Protocol	2267
EFI_HII_IMAGE_DECODER_PROTOCOL.DecodeImage()	2269
EFI_HII_IMAGE_DECODER_PROTOCOL.GetImageDecoderName()	2270
EFI_HII_IMAGE_DECODER_PROTOCOL.GetImageInfo()	2272
EFI_HII_IMAGE_DECODER_PROTOCOL.Decode()	2275
33.7 Font Glyph Generator Protocol	2276
EFI_HII_FONT_GLYPH_GENERATOR_PROTOCOL	2276
EFI_HII_FONT_GLYPH_GENERATOR_PROTOCOL.GenerateGlyph()	2277
EFI_HII_FONT_GLYPH_GENERATOR_PROTOCOL.GenerateGlyphImage()	2278
33.8 Database Protocol	2279
EFI_HII_DATABASE_PROTOCOL	2279
EFI_HII_DATABASE_PROTOCOL.NewPackageList()	2281

EFI_HII_DATABASE_PROTOCOL.RemovePackageList() .....	2283
EFI_HII_DATABASE_PROTOCOL.UpdatePackageList() .....	2284
EFI_HII_DATABASE_PROTOCOL.ListPackageLists() .....	2286
EFI_HII_DATABASE_PROTOCOL.ExportPackageLists() .....	2288
EFI_HII_DATABASE_PROTOCOL.RegisterPackageNotify() .....	2289
EFI_HII_DATABASE_PROTOCOL.UnregisterPackageNotify() .....	2291
EFI_HII_DATABASE_PROTOCOL.FindKeyboardLayouts() .....	2292
EFI_HII_DATABASE_PROTOCOL.GetKeyboardLayout() .....	2293
EFI_HII_DATABASE_PROTOCOL.SetKeyboardLayout() .....	2300
EFI_HII_DATABASE_PROTOCOL.GetPackageListHandle() .....	2301
33.8.1 Database Structures .....	2301
EFI_HII_DATABASE_NOTIFY .....	2301
EFI_HII_DATABASE_NOTIFY_TYPE .....	2303
<b>34 HII Configuration Processing and Browser Protocol .....</b>	<b>2305</b>
34.1 Introduction .....	2305
34.1.1 Common Configuration Data Format .....	2305
34.1.2 Data Flow .....	2305
34.2 Configuration Strings .....	2305
34.2.1 String Syntax .....	2305
34.2.2 String Types .....	2311
34.3 EFI Configuration Keyword Handler Protocol .....	2311
EFI_CONFIG_KEYWORD_HANDLER_PROTOCOL .....	2311
EFI_KEYWORD_HANDLER_PROTOCOL.SetData() .....	2313
EFI_KEYWORD_HANDLER_PROTOCOL.GetData() .....	2316
34.4 EFI HII Configuration Routing Protocol .....	2317
EFI_HII_CONFIG_ROUTING_PROTOCOL .....	2317
EFI_HII_CONFIG_ROUTING_PROTOCOL.ExtractConfig() .....	2319
EFI_HII_CONFIG_ROUTING_PROTOCOL.ExportConfig() .....	2321
EFI_HII_CONFIG_ROUTING_PROTOCOL.RouteConfig() .....	2322
EFI_HII_CONFIG_ROUTING_PROTOCOL.BlockToConfig() .....	2324
EFI_HII_CONFIG_ROUTING_PROTOCOL.ConfigToBlock() .....	2326
EFI_HII_CONFIG_ROUTING_PROTOCOL.GetAltCfg() .....	2328
34.5 EFI HII Configuration Access Protocol .....	2329
EFI_HII_CONFIG_ACCESS_PROTOCOL .....	2329
EFI_HII_CONFIG_ACCESS_PROTOCOL.ExtractConfig() .....	2332
EFI_HII_CONFIG_ACCESS_PROTOCOL.RouteConfig() .....	2335
EFI_HII_CONFIG_ACCESS_PROTOCOL.CallBack() .....	2337
34.6 Form Browser Protocol .....	2341
EFI_FORM_BROWSER2_PROTOCOL .....	2341
EFI_FORM_BROWSER2_PROTOCOL.SendForm() .....	2343
EFI_FORM_BROWSER2_PROTOCOL.BrowserCallback() .....	2346
34.7 HII Popup Protocol .....	2347
EFI_HII_POPUP_PROTOCOL .....	2347
EFI_HII_POPUP_PROTOCOL.CreatePopup() .....	2347
<b>35 User Identification .....</b>	<b>2351</b>
35.1 User Identification Overview .....	2351

35.1.1	User Identify.....	2351
35.1.2	User Profiles.....	2353
35.1.3	Credential Providers.....	2354
35.1.4	Security Considerations.....	2355
35.1.5	Deferred Execution .....	2357
35.2	User Identification Process.....	2357
35.2.1	User Identification Process.....	2357
35.2.2	Changing The Current User Profile .....	2358
35.2.3	Ready To Boot.....	2358
35.3	Code Definitions.....	2359
35.3.1	User Manager Protocol.....	2359
	EFI_USER_MANAGER_PROTOCOL .....	2359
	EFI_USER_MANAGER_PROTOCOL.Create() .....	2361
	EFI_USER_MANAGER_PROTOCOL.Delete() .....	2362
	EFI_USER_MANAGER_PROTOCOL.GetNext() .....	2363
	EFI_USER_MANAGER_PROTOCOL.Current() .....	2364
	EFI_USER_MANAGER_PROTOCOL.Identify().....	2365
	EFI_USER_MANAGER_PROTOCOL.Find().....	2366
	EFI_USER_MANAGER_PROTOCOL.Notify() .....	2368
	EFI_USER_MANAGER_PROTOCOL.GetInfo() .....	2369
	EFI_USER_MANAGER_PROTOCOL.SetInfo().....	2372
	EFI_USER_MANAGER_PROTOCOL.DeleteInfo() .....	2374
	EFI_USER_MANAGER_PROTOCOL.GetNextInfo().....	2375
35.3.2	Credential Provider Protocols.....	2375
	EFI_USER_CREDENTIAL2_PROTOCOL .....	2375
	EFI_USER_CREDENTIAL2_PROTOCOL.Enroll() .....	2379
	EFI_USER_CREDENTIAL2_PROTOCOL.Form().....	2380
	EFI_USER_CREDENTIAL2_PROTOCOL.Tile() .....	2381
	EFI_USER_CREDENTIAL2_PROTOCOL.Title() .....	2383
	EFI_USER_CREDENTIAL2_PROTOCOL.User() .....	2384
	EFI_USER_CREDENTIAL2_PROTOCOL.Select().....	2386
	EFI_USER_CREDENTIAL2_PROTOCOL.Deselect().....	2387
	EFI_USER_CREDENTIAL2_PROTOCOL.Default().....	2388
	EFI_USER_CREDENTIAL2_PROTOCOL.GetInfo() .....	2389
	EFI_USER_CREDENTIAL2_PROTOCOL.GetNextInfo().....	2390
	EFI_USER_CREDENTIAL2_PROTOCOL.Delete() .....	2391
35.3.3	Deferred Image Load Protocol.....	2391
	EFI_DEFERRED_IMAGE_LOAD_PROTOCOL.....	2391
	EFI_DEFERRED_IMAGE_LOAD_PROTOCOL.GetImageInfo().....	2393
35.4	User Information .....	2394
35.4.1	EFI_USER_INFO_ACCESS_POLICY_RECORD.....	2395
35.4.2	EFI_USER_INFO_CBEFF_RECORD .....	2401
35.4.3	EFI_USER_INFO_CREATE_DATE_RECORD .....	2401
35.4.4	EFI_USER_INFO_CREDENTIAL_PROVIDER_RECORD.....	2401
35.4.5	EFI_USER_INFO_CREDENTIAL_PROVIDER_NAME_RECORD .....	2401
35.4.6	EFI_USER_INFO_CREDENTIAL_TYPE_RECORD .....	2402
35.4.7	EFI_USER_INFO_CREDENTIAL_TYPE_NAME_RECORD .....	2402

35.4.8	EFI_USER_INFO_GUID_RECORD .....	2402
35.4.9	EFI_USER_INFO_FAR_RECORD .....	2403
35.4.10	EFI_USER_INFO_IDENTIFIER_RECORD .....	2403
35.4.11	EFI_USER_INFO_IDENTITY_POLICY_RECORD .....	2404
35.4.12	EFI_USER_INFO_NAME_RECORD .....	2405
35.4.13	EFI_USER_INFO_PKCS11_RECORD .....	2406
35.4.14	EFI_USER_INFO_RETRY_RECORD .....	2406
35.4.15	EFI_USER_INFO_USAGE_DATE_RECORD .....	2407
35.4.16	EFI_USER_INFO_USAGE_COUNT_RECORD .....	2407
35.5	User Information Table .....	2407

## **36 Secure Technologies..... 2409**

36.1	Hash Overview .....	2409
36.1.1	Hash References.....	2409
	EFI_HASH_SERVICE_BINDING_PROTOCOL.....	2409
	EFI_HASH_PROTOCOL.....	2410
	EFI_HASH_PROTOCOL.GetHashSize().....	2411
	EFI_HASH_PROTOCOL.Hash() .....	2412
36.1.2	Other Code Definitions.....	2413
	EFI_SHA1_HASH, EFI_SHA224_HASH, EFI_SHA256_HASH, EFI_SHA384_HASH, EFI_SHA512HASH, EFI_MD5_HASH .....	2413
36.2	Hash2 Protocols .....	2415
36.2.1	EFI Hash2 Service Binding Protocol .....	2415
	EFI_HASH2_SERVICE_BINDING_PROTOCOL .....	2415
36.2.2	EFI Hash2 Protocol.....	2416
	EFI_HASH2_PROTOCOL.....	2416
	EFI_HASH2_PROTOCOL.GetHashSize().....	2420
	EFI_HASH2_PROTOCOL.Hash().....	2421
	EFI_HASH2_PROTOCOL.HashInit() .....	2423
	EFI_HASH2_PROTOCOL.HashUpdate() .....	2424
	EFI_HASH2_PROTOCOL.HashFinal().....	2425
36.2.3	Other Code Definitions .....	2427
	EFI_HASH2_OUTPUT.....	2427
36.3	Key Management Service .....	2428
	EFI_KEY_MANAGEMENT_SERVICE_PROTOCOL .....	2428
	EFI_KMS_PROTOCOL.GetServiceStatus() .....	2442
	EFI_KMS_PROTOCOL.RegisterClient().....	2443
	EFI_KMS_PROTOCOL.CreateKey() .....	2445
	EFI_KMS_PROTOCOL.GetKey().....	2448
	EFI_KMS_PROTOCOL.AddKey() .....	2451
	EFI_KMS_PROTOCOL.DeleteKey() .....	2454
	EFI_KMS_PROTOCOL.GetKeyAttributes() .....	2457
	EFI_KMS_PROTOCOL.AddKeyAttributes().....	2460
	EFI_KMS_PROTOCOL.DeleteKeyAttributes().....	2463
	EFI_KMS_PROTOCOL.GetKeyByAttributes().....	2466
36.4	PKCS7 Verify Protocol .....	2469
	EFI_PKCS7_VERIFY_PROTOCOL .....	2469

EFI_PKCS7_VERIFY_PROTOCOL.VerifyBuffer()	2471
EFI_PKCS7_VERIFY_PROTOCOL.VerifySignature()	2475
36.5 Random Number Generator Protocol	2477
EFI_RNG_PROTOCOL	2478
EFI_RNG_PROTOCOL.GetInfo	2479
EFI_RNG_PROTOCOL.GetRNG	2481
36.5.1 EFI RNG Algorithm Definitions	2482
36.5.2 RNG References	2483
36.6	
Smart Card Reader and Smart Card Edge Protocols	2483
36.6.1 Smart Card Reader Protocol	2484
EFI_SMART_CARD_READER_PROTOCOL Summary	2484
EFI_SMART_CARD_READER_PROTOCOL.SCardConnect()	2486
EFI_SMART_CARD_READER_PROTOCOL.SCardDisconnect()	2488
EFI_SMART_CARD_READER_PROTOCOL.SCardStatus()	2489
EFI_SMART_CARD_READER_PROTOCOL.SCardTransmit()	2491
EFI_SMART_CARD_READER_PROTOCOL.SCardControl()	2493
EFI_SMART_CARD_READER_PROTOCOL.SCardGetAttrib()	2495
36.6.2 Smart Card Edge Protocol	2496
EFI_SMART_CARD_EDGE_PROTOCOL	2496
EFI_SMART_CARD_EDGE_PROTOCOL.GetContext()	2499
EFI_SMART_CARD_EDGE_PROTOCOL.Connect()	2501
EFI_SMART_CARD_EDGE_PROTOCOL.Disconnect()	2503
EFI_SMART_CARD_EDGE_PROTOCOL.GetCsn	2504
EFI_SMART_CARD_EDGE_PROTOCOL.GetReaderName	2505
EFI_SMART_CARD_EDGE_PROTOCOL.VerifyPin()	2506
EFI_SMART_CARD_EDGE_PROTOCOL.GetPinRemaining()	2508
EFI_SMART_CARD_EDGE_PROTOCOL.GetData()	2509
EFI_SMART_CARD_EDGE_PROTOCOL.GetCredentials()	2511
EFI_SMART_CARD_EDGE_PROTOCOL.SignData()	2514
EFI_SMART_CARD_EDGE_PROTOCOL.DecryptData()	2516
EFI_SMART_CARD_EDGE_PROTOCOL.BuildDHAgreement()	2519
<b>37 Miscellaneous Protocols</b>	<b>2521</b>
37.1 EFI Timestamp Protocol	2521
EFI_TIMESTAMP_PROTOCOL	2521
EFI_TIMESTAMP_PROTOCOL.GetTimestamp()	2521
EFI_TIMESTAMP_PROTOCOL.GetProperties()	2522
37.2 Reset Notification Protocol	2523
EFI_RESET_NOTIFICATION_PROTOCOL	2523
EFI_RESET_NOTIFICATION_PROTOCOL.RegisterResetNotify()	2523
EFI_RESET_NOTIFICATION_PROTOCOL.UnregisterResetNotify()	2525

<b>Appendix A GUID and Time Formats .....</b>	<b>2527</b>
<b>Appendix B Console.....</b>	<b>2529</b>
<b>Appendix C Device Path Examples.....</b>	<b>2533</b>
<b>Appendix D Status Codes .....</b>	<b>2541</b>
<b>Appendix E Universal Network Driver Interfaces.....</b>	<b>2545</b>
<b>Appendix F Using the Simple Pointer Protocol.....</b>	<b>2633</b>
<b>Appendix G</b>	
<b>Using the EFI Extended SCSI Pass Thru Protocol.....</b>	<b>2635</b>
<b>Appendix H Compression Source Code .....</b>	<b>2639</b>
<b>Appendix I Decompression Source Code .....</b>	<b>2667</b>
<b>Appendix J</b>	
<b>EFI Byte Code Virtual Machine Opcode List .....</b>	<b>2683</b>
<b>Appendix K Alphabetic Function Lists.....</b>	<b>2687</b>
<b>Appendix L</b>	
<b>EFI 1.10 Protocol Changes and Deprecation List .....</b>	<b>2689</b>
<b>Appendix M Formats —</b>	
<b>Language Codes and Language Code Arrays.....</b>	<b>2693</b>
<b>Appendix N Common Platform Error Record.....</b>	<b>2695</b>
<b>Appendix O UEFI ACPI Data Table.....</b>	<b>2751</b>
<b>Appendix P</b>	
<b>Hardware Error Record Persistence Usage .....</b>	<b>2755</b>
<b>Appendix Q References.....</b>	<b>2757</b>
<b>Appendix R Glossary.....</b>	<b>2765</b>
<b>Index.....</b>	<b>1</b>



# List of Figures

---

Figure 1. UEFI Conceptual Overview.....	12
Figure 2. Booting Sequence.....	19
Figure 3. Stack after <b>AddressOfEntryPoint</b> Called, IA- 32.....	30
Figure 4. Stack after <b>AddressOfEntryPoint</b> Called, Itanium-based Systems .....	32
Figure 5. Construction of a Protocol.....	53
Figure 6. Desktop System.....	59
Figure 7. Server System.....	59
Figure 8. Image Handle.....	62
Figure 9. Driver Image Handle .....	63
Figure 10. Host Bus Controllers.....	64
Figure 11. PCI Root Bridge Device Handle .....	64
Figure 12. Connecting Device Drivers .....	65
Figure 13. Connecting Bus Drivers.....	67
Figure 14. Child Device Handle with a Bus Specific Override .....	68
Figure 15. Software Service Relationships.....	70
Figure 16. MBRDisk Layout with legacy MBR example .....	127
Figure 17. GPT disk layout with protective MBR example.....	130
Figure 18. GPT disk layout with protective MBR on a disk with capacity exceeding LBA 0xFFFFFFFF example. ....	130
Figure 19. GUID Partition Table (GPT) example.....	132
Figure 20. The BTT Layout in a BTT Arena.....	141
Figure 21. A BTT With Multiple Arenas in a Large Namespace .....	142
Figure 22. Cyclic Sequence Numbers for Flog Entries .....	147
Figure 23. BTT Read Path Overview.....	154
Figure 24. BTT Write Path Overview.....	156
Figure 25. Device Handle to Protocol Handler Mapping.....	196
Figure 26. Handle Database.....	198
Figure 27. Scatter-Gather List of EFI_CAPSULE_BLOCK_DESCRIPTOR Structures .....	317
Figure 28. Text to Binary Conversion .....	394
Figure 29. Binary to Text Conversion .....	394
Figure 30. Device Path Text Representation .....	396
Figure 31. Text Device Node Names .....	396
Figure 32. Device Node Option Names.....	397
Figure 33. Driver Health Status States .....	484
Figure 34. Software BLT Buffer .....	568
Figure 35. Nesting of Legacy MBR Partition Records.....	595
Figure 36. Cyclic Sequence Numbers in Label Index Block .....	752
Figure 37. Host Bus Controllers.....	772
Figure 38. Device Handle for a PCI Root Bridge Controller.....	773
Figure 39. Desktop System with One PCI Root Bridge.....	774
Figure 40. Server System with Four PCI Root Bridges .....	775
Figure 41. Server System with Two PCI Segments.....	776
Figure 42. Server System with Two PCI Host Buses.....	777

Figure 43. Image Handle .....	815
Figure 44. PCI Driver Image Handle .....	816
Figure 45. PCI Host Bus Controller .....	817
Figure 46. Device Handle for a PCI Host Bus Controller .....	818
Figure 47. Physical PCI Bus Structure .....	819
Figure 48. Connecting a PCI Bus Driver .....	820
Figure 49. Child Handle Created by a PCI Bus Driver .....	820
Figure 50. Connecting a PCI Device Driver .....	823
Figure 51. Unsigned PCI Driver Image Layout .....	870
Figure 52. Signed and Compressed PCI Driver Image Flow.....	871
Figure 53. Signed and Compressed PCI Driver Image Layout .....	872
Figure 54. Signed but not Compressed PCI Driver Image Flow .....	873
Figure 55. Signed and Uncompressed PCI Driver Image Layout .....	874
Figure 56. Device Handle for a SCSI Bus Controller.....	878
Figure 57. Child Handle Created by a SCSI Bus Driver.....	879
Figure 58. Software Triggered State Transitions of a USB Host Controller.....	932
Figure 59. USB Bus Controller Handle .....	959
Figure 60. Sequence of Operations with Endpoint Policy Changes.....	1024
Figure 61. Debug Support Table Indirection and Pointer Usage .....	1054
Figure 62. Bit Sequence of Compressed Data .....	1059
Figure 63. Compressed Data Structure.....	1059
Figure 64. Block Structure.....	1060
Figure 65. Block Body.....	1063
Figure 66. String Info Log Search Tree .....	1065
Figure 67. Node Split .....	1067
Figure 68. Firmware Image with no Authentication Support .....	1178
Figure 69. Firmware Image with Authentication Support.....	1178
Figure 70. Optional Scatter-Gather Construction of Capsule Submitted to UpdateCapsule(). 1191	
Figure 71. Capsule Header and Firmware Management Capsule Header .....	1192
Figure 72. Firmware Management and Firmware Image Management headers.....	1193
Figure 73. IPv6-based PXE boot.....	1275
Figure 74. netboot6 (DHCP6 and ProxyDHCP6 reside on the same server) .....	1278
Figure 75. IPv6-based PXE boot (DHCP6 and ProxyDHCP6 reside on the different server)..... 1279	
Figure 76. HTTP Boot Network Topology Concept – Corporate Environment .....	1325
Figure 77. HTTP Boot Network Topology Concept2 – Home environments .....	1326
Figure 78. UEFI HTTP Boot Protocol Layout .....	1327
Figure 79. HTTP Boot overall flow .....	1330
Figure 80. Creating A Digital Signature.....	1974
Figure 81. Verifying a Digital Signature .....	1975
Figure 82. Embedded Digital Certificates .....	1976
Figure 83. Secure Boot Modes.....	1982
Figure 84. Signature lists.....	1986
Figure 85. Process for adding a new signature by the OS.....	1996
Figure 86. Platform Configuration Overview.....	2002
Figure 87. HII Resources In Drivers & Applications.....	2003

Figure 88. Creating UI Resources With Resource Files .....	2004
Figure 89. Creating UI Resources With Intermediate Source Representation.....	2005
Figure 90. The Platform and Standard User Interactions .....	2006
Figure 91. User and Platform Component Interaction.....	2006
Figure 92. User Interface Components.....	2007
Figure 93. Connected Forms Browser/Processor .....	2008
Figure 94. Disconnected Forms Browser/Processor.....	2008
Figure 95. O/S-Present Forms Browser/Processor .....	2009
Figure 96. Platform Data Storage.....	2009
Figure 97. Keyboard Layout.....	2012
Figure 98. Forms-based Interface Example.....	2015
Figure 99. Platform Configuration Overview.....	2016
Figure 100. Question Value Retrieval Process.....	2025
Figure 101. Question Value Change Process .....	2026
Figure 102. String Identifiers.....	2045
Figure 103. Fonts.....	2051
Figure 104. Font Description Terms .....	2052
Figure 105. 16 x 19 Font Parameters .....	2053
Figure 106. Font Structure Layout.....	2054
Figure 107. Proportional Font Parameters and Byte Padding.....	2055
Figure 108. Aligning Glyphs.....	2055
Figure 109. HII Database .....	2057
Figure 110. Setup Browser.....	2058
Figure 111. Storing Configuration Settings .....	2063
Figure 112. OS Runtime Utilization.....	2064
Figure 113. Standard Application Obtaining Setting Example.....	2065
Figure 114. Typical Forms Processor Decisions Necessitating a Callback (1) .....	2067
Figure 115. Typical Forms Processor Decisions Necessitating a Callback (2) .....	2068
Figure 116. Typical Forms Processor Decisions Necessitating a Callback (3) .....	2069
Figure 117. Driver Model Interactions.....	2070
Figure 118. Managing Human Interface Components .....	2071
Figure 119. EFI IFR Form set configuration.....	2072
Figure 120. EFI IFR Form Set question changes .....	2073
Figure 121. Glyph Information Encoded in Blocks .....	2082
Figure 122. Glyph Block Processing.....	2085
Figure 123. EFI_HII_GIBT_GLYPH_VARIABLITY Glyph Drawing Processing.....	2093
Figure 124. String Information Encoded in Blocks.....	2096
Figure 125. String Block Processing: Base Processing.....	2098
Figure 126. String Block Processing: SCSU Processing.....	2099
Figure 127. String Block Processing: UTF Processing.....	2100
Figure 128. Image Information Encoded in Blocks.....	2111
Figure 129. Palette Structure of a Black & White, One-Bit Image .....	2127
Figure 130. Palette Structure of a Four-Bit Image .....	2127
Figure 131. Palette Structure of a Four-Bit, Six-Color Image.....	2128
Figure 132. Simple Binary Object.....	2129
Figure 133. Password Flowchart (part one).....	2176
Figure 134. Password Flowchart (part two) .....	2177

Figure 135. Animation Information Encoded in Blocks .....	2211
Figure 136. Glyph Example .....	2239
Figure 137. How EFI_HII_IMAGE_EX_PROTOCOL uses EFI_HII_IMAGE_DECODER_PROTOCOL .....	2268
Figure 138. Keyboard Layout .....	2297
Figure 139. User Identity .....	2352
Figure 140. Hash workflow .....	2419
Figure 141. Example Computer System .....	2533
Figure 142. Partial ACPI Name Space for Example System .....	2534
Figure 143. EFI Device Path Displayed As a Name Space .....	2539
Figure 144. Network Stacks with Three Classes of Drivers .....	2550
Figure 145. !PXE Structures for H/W and S/W UNDI .....	2552
Figure 146. Issuing UNDI Commands .....	2556
Figure 147. UNDI Command Descriptor Block (CDB) .....	2557
Figure 148. Storage Types .....	2562
Figure 149. UNDI States, Transitions & Valid Commands .....	2583
Figure 150. Linked CDBs .....	2584
Figure 151. Queued CDBs .....	2585
Figure 152. Error Record Format .....	2695

# List of Tables

---

Table 1. SI prefixes .....	18
Table 2. Binary prefixes .....	18
Table 3. UEFI Image Memory Types.....	21
Table 4. UEFI Runtime Services .....	24
Table 5. Common UEFI Data Types.....	26
Table 6. Modifiers for Common UEFI Data Types.....	27
Table 7. Map: EFI memory types to AArch64 memory types.....	45
Table 8. UEFI Protocols .....	55
Table 9. Required UEFI Implementation Elements .....	72
Table 10. Global Variables .....	94
Table 11. UEFI Image Types .....	101
Table 12. Usage of Memory Attribute Definitions .....	119
Table 13. Legacy MBR .....	126
Table 14. Legacy MBR Partition Record .....	126
Table 15. Protective MBR .....	129
Table 16. Protective MBR Partition Record protecting the entire disk .....	129
Table 17. GPT Header .....	135
Table 18. GPT Partition Entry .....	137
Table 19. Defined GPT Partition Entry - Partition Type GUIDs .....	138
Table 20. Defined GPT Partition Entry - Attributes .....	139
Table 21. Event, Timer, and Task Priority Functions .....	158
Table 22. TPL Usage .....	159
Table 23. TPL Restrictions.....	159
Table 24. Memory Allocation Functions .....	181
Table 25. Memory Type Usage before <b>ExitBootServices()</b> .....	182
Table 26. Memory Type Usage after <b>ExitBootServices()</b> .....	182
Table 27. Protocol Interface Functions .....	195
Table 28. Image Type Differences Summary .....	243
Table 29. Image Functions .....	244
Table 30. Miscellaneous Boot Services Functions.....	256
Table 31. Rules for Reentry Into Runtime Services .....	269
Table 32. Functions that may be called after Machine Check ,INIT and NMI .....	270
Table 33. Variable Services Functions .....	270
Table 34. Hardware Error Record Persistence Variables .....	293
Table 35. Time Services Functions.....	294
Table 36. Virtual Memory Functions.....	302
Table 37. Miscellaneous Runtime Services.....	306
Table 38. Flag Firmware Behavior.....	314
Table 39. Variables Using EFI_CAPSULE_REPORT_GUID.....	323
Table 40. Generic Device Path Node Structure.....	333
Table 41. Device Path End Structure .....	334
Table 42. PCI Device Path.....	335
Table 43. PCCARD Device Path.....	335
Table 44. Memory Mapped Device Path .....	335
Table 45. Vendor-Defined Device Path .....	336
Table 46. Controller Device Path .....	336
Table 47. BMC Device Path .....	336
Table 48. ACPI Device Path.....	338
Table 49. Expanded ACPI Device Path.....	338
Table 50. ACPI _ADR Device Path .....	339

Table 51. ATAPI Device Path.....	340
Table 52. SCSI Device Path.....	340
Table 53. Fibre Channel Device Path.....	340
Table 54. Fibre Channel Ex Device Path.....	340
Table 55. Fibre Channel Ex Device Path Example.....	342
Table 56. 1394 Device Path.....	343
Table 57. USB Device Path.....	343
Table 58. USB Device Path Examples.....	344
Table 59. Another USB Device Path Example.....	345
Table 60. SATA Device Path.....	345
Table 61. USB WWID Device Path.....	346
Table 62. Device Logical Unit.....	347
Table 63. USB Class Device Path.....	348
Table 64. I2O Device Path.....	348
Table 65. MAC Address Device Path.....	348
Table 66. IPv4 Device Path.....	350
Table 67. IPv6 Device Path.....	350
Table 68. InfiniBand Device Path.....	352
Table 69. UART Device Path.....	352
Table 70. Vendor-Defined Messaging Device Path.....	353
Table 71. UART Flow Control Messaging Device Path.....	354
Table 72. Messaging Device Path Structure.....	355
Table 73. Messaging Device Path Structure.....	357
Table 74. iSCSI Device Path Node (Base Information).....	358
Table 75. IPv4 configuration.....	360
Table 76. IPv6 configuration.....	365
Table 77. NVM Express Namespace Device Path.....	370
Table 78. URI Device Path.....	371
Table 79. UFS Device Path.....	371
Table 80. SD Device Path.....	372
Table 81. Bluetooth Device Path.....	372
Table 82. Wi-Fi Device Path.....	372
Table 83. eMMC Device Path.....	372
Table 84. EFI BluetoothLE Device Path.....	374
Table 85. DNS Device Path.....	374
Table 86. Hard Drive Media Device Path.....	376
Table 87. CD-ROM Media Device Path.....	377
Table 88. Vendor-Defined Media Device Path.....	377
Table 89. File Path Media Device Path.....	377
Table 90. Media Protocol Media Device Path.....	378
Table 91. PIWG Firmware Volume Device Path.....	378
Table 92. PIWG Firmware Volume Device Path.....	379
Table 93. Relative Offset Range.....	379
Table 94. RAM Disk Device Path.....	379
Table 95. BIOS Boot Specification Device Path.....	381
Table 96. ACPI _CRS to EFI Device Path Mapping.....	382
Table 97. ACPI _ADR to EFI Device Path Mapping.....	383
Table 98. EFI Device Path Option Parameter Values.....	398
Table 99. Device Node Table.....	398
Table 100. Supported Unicode Control Characters.....	510
Table 101. EFI Scan Codes for EFI_SIMPLE_TEXT_INPUT_PROTOCOL.....	510
Table 102. EFI Scan Codes for <b>EFI_SIMPLE_TEXT_INPUT_EX_PROTOCOL</b> .....	511
Table 103. EFI Cursor Location/Advance Rules.....	531
Table 104. PS/2 Mouse Device Path.....	546
Table 105. Serial Mouse Device Path.....	548

Table 106. USB Mouse Device Path .....	549
Table 107. Bit Operation Table.....	578
Table 108. Attributes Definition Table .....	583
Table 109. Tape Header Formats.....	642
Table 110. PATA device mapping to ports and port multiplier ports.....	696
Table 111. Special programming considerations .....	702
Table 112. PCI Configuration Address.....	795
Table 113. QWORD Address Space Descriptor .....	810
Table 114. End Tag.....	810
Table 115. PCI Root Bridge Device Path for a Desktop System.....	811
Table 116. PCI Root Bridge Device Path for Bridge #0 in a Server System .....	813
Table 117. PCI Root Bridge Device Path for Bridge #1 in a Server System .....	813
Table 118. PCI Root Bridge Device Path for Bridge #2 in a Server System .....	813
Table 119. PCI Root Bridge Device Path for Bridge #3 in a Server System .....	814
Table 120. PCI Root Bridge Device Path Using Expanded ACPI Device Path.....	814
Table 121. QWORD Address Space Descriptor .....	859
Table 122. End Tag.....	859
Table 123. PCI Device 7, Function 0 on PCI Root Bridge 0 .....	863
Table 124. PCI Device 7, Function 0 behind PCI to PCI bridge .....	864
Table 125. Standard PCI Expansion ROM Header (Example from PCI Firmware Specification 3.0) .....	867
Table 126. PCI Expansion ROM Code Types (Example from PCI Firmware Specification 3.0). 867	867
Table 127. EFI PCI Expansion ROM Header .....	867
Table 128. Device Path for an EFI Driver loaded from PCI Option ROM.....	869
Table 129. Recommended PCI Device Driver Layout.....	875
Table 130. SCSI Device Path Examples .....	892
Table 131. ATAPI Device Path Examples.....	893
Table 132. Fibre Channel Device Path Examples.....	894
Table 133. InfiniBand Device Path Examples.....	895
Table 134. Single Channel PCI SCSI Controller .....	896
Table 135. Single Channel PCI SCSI Controller behind a PCI Bridge .....	897
Table 136. Channel #3 of a PCI SCSI Controller behind a PCI Bridge.....	898
Table 137. USB Hub Port Status Bitmap.....	954
Table 138. Hub Port Change Status Bitmap.....	955
Table 139. USB Port Features .....	957
Table 140. Payload-associated Messages and Descriptions.....	1009
Table 141. Debugport Messaging Device Path .....	1052
Table 142. Block Header Fields .....	1061
Table 143. General Purpose VM Registers.....	1099
Table 144. Dedicated VM Registers .....	1100
Table 145. VM Flags Register.....	1100
Table 146. Index Encoding.....	1101
Table 147. Index Size in Index Encoding .....	1101
Table 148. Opcode Byte Encoding .....	1105
Table 149. Operand Byte Encoding .....	1105
Table 150. ADD Instruction Encoding.....	1107
Table 151. AND Instruction Encoding .....	1108
Table 152. ASHR Instruction Encoding .....	1109
Table 153. VM Version Format.....	1110
Table 154. BREAK Instruction Encoding .....	1111
Table 155. CALL Instruction Encoding .....	1113
Table 156. CMP Instruction Encoding.....	1116
Table 157. CMPI Instruction Encoding .....	1118
Table 158. DIV Instruction Encoding .....	1119

Table 159. DIVU Instruction Encoding .....	1120
Table 160. EXTNDB Instruction Encoding .....	1121
Table 161. EXTNDD Instruction Encoding .....	1122
Table 162. EXTNDW Instruction Encoding .....	1123
Table 163. JMP Instruction Encoding .....	1125
Table 164. JMP8 Instruction Encoding .....	1127
Table 165. LOADSP Instruction Encoding.....	1128
Table 166. MOD Instruction Encoding.....	1129
Table 167. MODU Instruction Encoding.....	1130
Table 168. MOV Instruction Encoding.....	1132
Table 169. MOVI Instruction Encoding.....	1133
Table 170. MOVIn Instruction Encoding .....	1135
Table 171. MOVn Instruction Encoding .....	1136
Table 172. MOVREL Instruction Encoding .....	1137
Table 173. MOVsn Instruction Encoding .....	1138
Table 174. MUL Instruction Encoding.....	1140
Table 175. MULU Instruction Encoding.....	1141
Table 176. NEG Instruction Encoding .....	1142
Table 177. NOT Instruction Encoding .....	1143
Table 178. OR Instruction Encoding.....	1144
Table 179. POP Instruction Encoding .....	1145
Table 180. POPn Instruction Encoding .....	1146
Table 181. PUSH Instruction Encoding .....	1147
Table 182. PUSHn Instruction Encoding.....	1148
Table 183. RET Instruction Encoding .....	1149
Table 184. SHL Instruction Encoding.....	1150
Table 185. SHR Instruction Encoding.....	1151
Table 186. STORESP Instruction Encoding .....	1152
Table 187. SUB Instruction Encoding .....	1153
Table 188. XOR Instruction Encoding.....	1154
Table 189. ESRT and FMP Fields.....	1201
Table 190. PXE Tag Definitions for EFI.....	1243
Table 191. Destination IP Filter Operation .....	1262
Table 192. Destination UDP Port Filter Operation .....	1262
Table 193. Source IP Filter Operation.....	1262
Table 194. Source UDP Port Filter Operation.....	1262
Table 195. DHCP4 Enumerations.....	1754
Table 196. Field Descriptions .....	1781
Table 197. Callback Return Values.....	1787
Table 198. Descriptions of Parameters in MTFTPv4 Packet Structures .....	1919
Table 199. Descriptions of Parameters in MTFTPv6 Packet Structures .....	1947
Table 200. MTFTP Packet OpCode Descriptions .....	1950
Table 201. MTFTP ERROR Packet ErrorCode Descriptions .....	1950
Table 202. Generic Authentication Node Structure.....	1970
Table 203. CHAP Authentication Node Structure using RADIUS .....	1971
Table 204. CHAP Authentication Node Structure using Local Database.....	1972
Table 205. PE/COFF Certificates Types and UEFI Signature Database Certificate Types .....	1978
Table 206. Authorization process flow.....	1998
Table 207. Localization Issues.....	2010
Table 208. Information for Types of Storage.....	2035
Table 209. Common Control Codes for Font Display Information.....	2047
Table 210. Guidelines for UEFI System Fonts .....	2054
Table 211. Truth table: Mapping a single question to three configuration settings.....	2074
Table 212. Multiple configuration settings Example #2 .....	2075



Table 213. Values:	2075
Table 214. Package Types	2077
Table 215. Block Types	2112
Table 216. IFR Opcodes	2133
Table 217. VarStoreType Descriptions	2155
Table 218. Animation Block Types	2212
Table 219. Callback Behavior	2339
Table 220. Record values and descriptions	2395
Table 221. Standard values for access to configure the platform	2399
Table 222. EFI Hash Algorithms	2415
Table 223. Identical hash results	2418
Table 224. Algorithms that may be used with EFI_HASH2_PROTOCOL	2426
Table 225. Encryption algorithm properties	2437
Table 226. Details of Supported Signature Format	2470
Table 227. EFI GUID Format	2527
Table 228. Text representation relationships	2528
Table 229. EFI Scan Codes for EFI_SIMPLE_TEXT_INPUT_PROTOCOL	2530
Table 230. EFI Scan Codes for EFI_SIMPLE_TEXT_INPUT_EX_PROTOCOL	2530
Table 231. Control Sequences to Implement <b>EFI_SIMPLE_TEXT_INPUT_PROTOCOL</b>	2532
Table 232. Legacy Floppy Device Path	2535
Table 233. IDE Disk Device Path	2536
Table 234. Secondary Root PCI Bus with PCI to PCI Bridge Device Path	2538
Table 235. EFI_STATUS Code Ranges	2542
Table 236. EFI_STATUS Success Codes (High Bit Clear)	2542
Table 237. EFI_STATUS Error Codes (High Bit Set)	2542
Table 238. EFI_STATUS Warning Codes (High Bit Clear)	2544
Table 239. Definitions	2546
Table 240. Referenced Specifications	2548
Table 241. Driver Types: Pros and Cons	2551
Table 242. IPXE Structure Field Definitions	2553
Table 243. UNDI CDB Field Definitions	2558
Table 244. EBC Virtual Machine Opcode Summary	2684
Table 245. Protocol Name changes	2690
Table 246. Revision Identifier Name Changes	2691
Table 247. Alias codes supported in addition to RFC 4646	2693
Table 248. Error record header	2696
Table 249. Error Record Header Flags	2699
Table 250. Section Descriptor	2702
Table 251. Processor Generic Error Section	2706
Table 252. Processor Error Record	2708
Table 253. IA32/X64 Processor Error Information Structure	2709
Table 254. IA32/X64 Cache Check Structure	2710
Table 255. IA32/X64 TLB Check Structure	2711
Table 256. IA32/X64 Bus Check Structure	2713
Table 257. IA32/X64 MS Check Field Description	2715
Table 258. IA32/X64 Processor Context Information	2716
Table 259. IA32 Register State	2717
Table 260. X64 Register State	2718
Table 261. ARM Processor Error Section	2720
Table 262. ARM Processor Error Information Structure	2722
Table 263. ARM Cache Error Structure	2724
Table 264. ARM TLB Error Structure	2725
Table 265. ARM Bus Error Structure	2726
Table 266. ARM Processor Error Context Information Header Structure	2729
Table 267. ARMv8 AArch32 GPRs (Type 0)	2729

Table 268. ARM AArch32 EL1 Context System Registers (Type 1).....	2730
Table 269. ARM AArch32 EL2 Context System Registers (Type 2).....	2730
Table 270. ARM AArch32 secure Context System Registers (Type 3).....	2732
Table 271. ARMv8 AArch64 GPRs (Type 4) .....	2732
Table 272. ARM AArch64 EL1 Context System Registers (Type 5).....	2733
Table 273. ARM AArch64 EL2 Context System Registers (Type 6).....	2734
Table 274. ARM AArch64 EL3 Context System Registers (Type 7).....	2734
Table 275. ARM Misc. Context System Register (Type 8) – Single Register Entry.....	2735
Table 276. Memory Error Record.....	2736
Table 277. Memory Error Record 2.....	2739
Table 278. PCI Express Error Record.....	2741
Table 279. PCI/PCI-X Bus Error Section.....	2743
Table 280. PCI/PCI-X Component Error Section.....	2744
Table 281. Firmware Error Record Reference.....	2745
Table 282. DMAR Generic Errors .....	2746
Table 283. Intel® VT for Directed I/O specific DMAR Errors .....	2747
Table 284. IOMMU specific DMAR Errors .....	2748
Table 285. Error Status Fields .....	2749
Table 286. Error Types .....	2749
Table 287. UEFI Table Structure.....	2751
Table 288. SMM Communication ACPI Table.....	2752

# 1 Introduction

---

This *Unified Extensible Firmware Interface* (hereafter known as UEFI) *Specification* describes an interface between the operating system (OS) and the platform firmware. UEFI was preceded by the *Extensible Firmware Interface Specification 1.10* (EFI). As a result, some code and certain protocol names retain the EFI designation. Unless otherwise noted, EFI designations in this specification may be assumed to be part of UEFI.

The interface is in the form of data tables that contain platform-related information, and boot and runtime service calls that are available to the OS loader and the OS. Together, these provide a standard environment for booting an OS. This specification is designed as a pure interface specification. As such, the specification defines the set of interfaces and structures that platform firmware must implement. Similarly, the specification defines the set of interfaces and structures that the OS may use in booting. How either the firmware developer chooses to implement the required elements or the OS developer chooses to make use of those interfaces and structures is an implementation decision left for the developer.

The intent of this specification is to define a way for the OS and platform firmware to communicate only information necessary to support the OS boot process. This is accomplished through a formal and complete abstract specification of the software-visible interface presented to the OS by the platform and firmware.

Using this formal definition, a shrink-wrap OS intended to run on platforms compatible with supported processor specifications will be able to boot on a variety of system designs without further platform or OS customization. The definition will also allow for platform innovation to introduce new features and functionality that enhance platform capability without requiring new code to be written in the OS boot sequence.

Furthermore, an abstract specification opens a route to replace legacy devices and firmware code over time. New device types and associated code can provide equivalent functionality through the same defined abstract interface, again without impact on the OS boot support code.

The specification is applicable to a full range of hardware platforms from mobile systems to servers. The specification provides a core set of services along with a selection of protocol interfaces. The selection of protocol interfaces can evolve over time to be optimized for various platform market segments. At the same time, the specification allows maximum extensibility and customization abilities for OEMs to allow differentiation. In this, the purpose of UEFI is to define an evolutionary path from the traditional "PC-AT"-style boot world into a legacy-API free environment.

## 1.1 UEFI Driver Model Extensions

Access to boot devices is provided through a set of protocol interfaces. One purpose of the UEFI *Driver Model* is to provide a replacement for "PC-AT"-style option ROMs. It is important to point out that drivers written to the UEFI *Driver Model* are designed to

access boot devices in the preboot environment. They are not designed to replace the high-performance, OS-specific drivers.

The UEFI *Driver Model* is designed to support the execution of modular pieces of code, also known as drivers, that run in the preboot environment. These drivers may manage or control hardware buses and devices on the platform, or they may provide some software-derived, platform-specific service.

The UEFI *Driver Model* also contains information required by UEFI driver writers to design and implement any combination of bus drivers and device drivers that a platform might need to boot a UEFI-compliant OS.

The UEFI *Driver Model* is designed to be generic and can be adapted to any type of bus or device. The *UEFI Specification* describes how to write PCI bus drivers, PCI device drivers, USB bus drivers, USB device drivers, and SCSI drivers. Additional details are provided that allow UEFI drivers to be stored in PCI option ROMs, while maintaining compatibility with legacy option ROM images.

One of the design goals in the *UEFI Specification* is keeping the driver images as small as possible. However, if a driver is required to support multiple processor architectures, a driver object file would also be required to be shipped for each supported processor architecture. To address this space issue, this specification also defines the *EFI Byte Code Virtual Machine*. A UEFI driver can be compiled into a single EFI Byte Code object file. UEFI Specification-complaint firmware must contain an EFI Byte Code interpreter. This allows a single EFI Byte Code object file that supports multiple processor architectures to be shipped. Another space saving technique is the use of compression. This specification defines compression and decompression algorithms that may be used to reduce the size of UEFI Drivers, and thus reduce the overhead when UEFI Drivers are stored in ROM devices.

The information contained in the *UEFI Specification* can be used by OSVs, IHVs, OEMs, and firmware vendors to design and implement firmware conforming to this specification, drivers that produce standard protocol interfaces, and operating system loaders that can be used to boot UEFI-compliant operating systems.

## 1.2 Organization

The high-level organization of this specification is as follows:

Section(s)	Description
Introduction / Overview	Introduces the UEFI Specification, and describes the major components of UEFI.
Boot Manager	Manager used to load drivers and applications written to this specification.
EFI System Table and Partitions	Describes an EFI System Table that is passed to every compliant driver and application, and defines a GUID-based partitioning scheme.
Block Transition Table	A layout and set of rules for doing block I/O that provide powerfail write atomicity of a single block.
Boot Services	Contains the definitions of the fundamental services that are present in a UEFI-compliant system before an OS is booted.
Runtime Services	Contains definitions for the fundamental services that are present in a compliant system before and after an OS is booted.
Protocols	<ul style="list-style-type: none"> <li>The EFI Loaded Image Protocol describes a UEFI Image that has been loaded into memory.</li> <li>The Device Path Protocol provides the information needed to construct and manage device paths in the UEFI environment.</li> <li>The UEFI Driver Model describes a set of services and protocols that apply to every bus and device type.</li> <li>The Console Support Protocol defines I/O protocols that handle input and output of text-based information intended for the system user while executing in the boot services environment.</li> <li>The Media Access Protocol defines the Load File protocol, file system format and media formats for handling removable media.</li> <li>PCI Bus Support Protocols define PCI Bus Drivers, PCI Device Drivers, and PCI Option ROM layouts. The protocols described include the PCI Root Bridge I/O Protocol and the PCI I/O Protocol.</li> <li>SCSI Driver Models and Bus support defines the SCSI I/O Protocol and the Extended SCSI Pass Thru Protocol that is used to abstract access to a SCSI channel that is produced by a SCSI host controller.</li> <li>The iSCSI protocol defines a transport for SCSI data over TCP/IP.</li> <li>The USB Support Protocol defines USB Bus Drivers and USB Device Drivers.</li> <li>Debugger Support Protocols describe an optional set of protocols that provide the services required to implement a source-level debugger for the UEFI environment.</li> <li>The Compression Algorithm Specification describes the compression/decompression algorithm in detail, plus a standard EFI decompression interface for use at boot time.</li> <li>ACPI Protocols may be used to install or remove an ACPI table from a platform.</li> <li>String Services: the Unicode Collation protocol allows code running in the boot services environment to perform lexical comparison functions on Unicode strings for given languages; the Regular Expression Protocol is used to match Unicode strings against Regular Expression patterns.</li> </ul>
EFI Byte Code Virtual Machine	Defines the EFI Byte Code virtual processor and its instruction set. It also defines how EBC object files are loaded into memory, and the mechanism for transitioning from native code to EBC code and back to native code.
Firmware Update and Reporting	Provides an abstraction for devices to provide firmware management support.
Network Protocols	<ul style="list-style-type: none"> <li>SNP, PXE, BIS, and HTTP Boot protocols define the protocols that provide access to network devices while executing in the UEFI boot services environment.</li> <li>Managed Network protocols define the EFI Managed Network Protocol, which provides raw (unformatted) asynchronous network packet I/O services and Managed Network Service Binding Protocol, used to locate communication devices that are supported by an MNP driver.</li> <li>VLAN, EAP, Wi-Fi and Supplicant protocols define a protocol that is to provide a manageability interface for VLAN configurations.</li> <li>Bluetooth protocol definitions.</li> <li>TCP, IP, PIPsec, FTP, GTLS, and Configurations protocols define the EFI TCPv4 (Transmission Control Protocol version 4) Protocol and the EFI IPv4 (Internet Protocol version 4) Protocol.</li> <li>ARP, DHCP, DNS, HTTP, and REST protocols define the EFI Address Resolution Protocol (ARP) Protocol interface and the EFI DHCPv4 Protocol.</li> <li>UDP and MTFTP protocols define the EFI UDPv4 (User Datagram Protocol version 4) Protocol that interfaces over the EFI IPv4 Protocol and defines the EFI MTFTPv4 Protocol interface that is built on the EFI UDPv4 Protocol.</li> </ul>

Section(s)	Description
Secure Boot and Driver Signing	Describes Secure Boot and a means of generating a digital signature for UEFI.
Human Interface Infrastructure (HII)	<ul style="list-style-type: none"> <li>• Defines the core code and services that are required for an implementation of the Human Interface Infrastructure (HII), including basic mechanisms for managing user input and code definitions for related protocols.</li> <li>• Describes the data and APIs used to manage the system's configuration: the actual data that describes the knobs and settings.</li> </ul>
User Identification	Describes services that describe the current user of the platform.
Secure Technologies	Describes the protocols for utilizing security technologies, including cryptographic hashing and key management.
Miscellaneous Protocols	The Timestamp protocol provides a platform independent interface for retrieving a high resolution timestamp counter. The Reset Notification Protocol provides services to register for a notification when ResetSystem is called.
Appendices	<ul style="list-style-type: none"> <li>• GUID and Time Formats.</li> <li>• Console requirements for a basic text-based console required by EFI-conformant systems to provide communication capabilities.</li> <li>• Device Path examples of use of the data structures that define various hardware devices to the boot services.</li> <li>• Status Codes lists success, error, and warning codes returned by UEFI interfaces.</li> <li>• Universal Network Driver Interfaces defines the 32/64-bit hardware and software Universal Network Driver Interfaces (UNDIs).</li> <li>• Using the Simple Pointer Protocol.</li> <li>• Using the EFI Extended SCSI Pass-thru Protocol .</li> <li>• Compression Source Code for an implementation of the Compression Algorithm.</li> <li>• Decompression Source Code for an implementation of the EFI Decompression Algorithm.</li> <li>• The EFI Byte Code Virtual Machine Opcode List provides a summary of the corresponding instruction set.</li> <li>• Alphabetic Function Lists identify all UEFI interface functions alphabetically.</li> <li>• EFI 1.10 Protocol Changes and Depreciation List identifies the Protocol, GUID, and revision identifier name changes and the deprecated protocols compared to the <i>EFI Specification 1.10</i>.</li> <li>• Formats: Language Codes and Language Code Arrays list the formats for language codes and language code arrays.</li> <li>• The Common Platform Error Record describes the common platform error record format for representing platform hardware errors.</li> <li>• The UEFI ACPI Data Table defines the UEFI ACPI table format.</li> <li>• Hardware Error Record Persistence Usage.</li> <li>• References</li> <li>• Glossary</li> </ul>
Index	Provides an index to the key terms and concepts in the specification.

## 1.3 Organization

The high-level organization of this specification is as follows:

Section/Appendix	Description
<a href="#">1. Introduction</a>	Introduces the UEFI Specification and topics related to using the specification.
<a href="#">2. Overview</a>	Describes the major components of UEFI, including the boot manager, firmware core, calling conventions, protocols, and requirements.
<a href="#">3. Boot Manager</a>	Describes the boot manager, which is used to load drivers and applications written to this specification.
<a href="#">1. EFI System Table</a>	Describes the EFI System Table that is passed to every compliant driver and application.
<a href="#">5. GUID Partition Table (GPT) Disk Layout</a>	Defines a new partitioning scheme that must be supported by firmware conforming to this specification.
<a href="#">6. Block Translation Table (BTT) Layout</a>	A namespace defines a contiguously-addressed range of Non-Volatile Memory conceptually similar to a SCSI Logical Unit (LUN) or a NVM Express namespace. Any namespace being utilized for block storage may contain a Block Translation Table (BTT), which is a layout and set of rules for doing block I/O that provide powerfail write atomicity of a single block.
<a href="#">1. Services — Boot Services</a>	Contains the definitions of the fundamental services that are present in a UEFI-compliant system before an OS is booted.
<a href="#">1. Services — Runtime Services</a>	Contains definitions for the fundamental services that are present in a compliant system before and after an OS is booted.
<a href="#">1. Protocols — EFI Loaded Image</a>	Defines the EFI Loaded Image Protocol that describes a UEFI Image that has been loaded into memory.
<a href="#">1. Protocols — Device Path Protocol</a>	Defines the device path protocol and provides the information needed to construct and manage device paths in the UEFI environment.
<a href="#">11. Protocols — UEFI Driver Model</a>	Describes a generic driver model for UEFI. This includes the set of services and protocols that apply to every bus and device type, including the Driver Binding Protocol, the Platform Driver Override Protocol, the Bus Specific Driver Override Protocol, the Driver Diagnostics Protocol, the Driver Configuration Protocol, and the Component Name Protocol.
<a href="#">1. Protocols — Console Support</a>	Defines the Console I/O protocols, which handle input and output of text-based information intended for the system user while executing in the boot services environment. These protocols include the Simple Input Protocol, the Simple Text Output Protocol, the Graphics Output Protocol, the Simple Pointer Protocol, and the Serial I/O Protocol.
<a href="#">13. Protocols — Media Access</a>	Defines the Load File protocol, file system format and media formats for handling removable media.

Section/Appendix	Description
<a href="#">14. Protocols — PCI Bus Support</a>	Defines PCI Bus Drivers, PCI Device Drivers, and PCI Option ROM layouts. The protocols described include the PCI Root Bridge I/O Protocol and the PCI I/O Protocol.
<a href="#">15. Protocols — SCSI Driver Models and Bus Support</a>	Defines the SCSI I/O Protocol and the Extended SCSI Pass Thru Protocol that is used to abstract access to a SCSI channel that is produced by a SCSI host controller.
<a href="#">16. Protocols — iSCSI Boot</a>	The iSCSI protocol defines a transport for SCSI data over TCP/IP.
<a href="#">1. Protocols — USB Support</a>	Defines USB Bus Drivers and USB Device Drivers. The protocols described include the USB2 Host Controller Protocol and the USB I/O Protocol.
<a href="#">18. Protocols — Debugger Support</a>	An optional set of protocols that provide the services required to implement a source-level debugger for the UEFI environment. The EFI Debug Port Protocol provides services to communicate with a remote debug host. The Debug Support Protocol provides services to hook processor exceptions, save the processor context, and restore the processor context. These protocols can be used in the implementation of a debug agent on the target system that interacts with the remote debug host.
<a href="#">1. Protocols — Compression Algorithm Specification</a>	Describes in detail the compression/decompression algorithm, as well as the EFI Decompress Protocol. The EFI Decompress Protocol provides a standard decompression interface for use at boot time. The EFI Decompress Protocol is used by a PCI Bus Driver to decompress UEFI drivers stored in PCI Option ROMs.
<a href="#">20. Protocols — ACPI Protocols</a>	Defines a protocol that may be used to install or remove an ACPI table from a platform.
<a href="#">21. Protocols — String Services</a>	The Unicode Collation protocol allows code running in the boot services environment to perform lexical comparison functions on Unicode strings for given languages. The Regular Expression Protocol is used to match Unicode strings against Regular Expression patterns
<a href="#">22. EFI Byte Code Virtual Machine</a>	Defines the EFI Byte Code virtual processor and its instruction set. It also defines how EBC object files are loaded into memory, and the mechanism for transitioning from native code to EBC code and back to native code. The information in this document is sufficient to implement an EFI Byte Code interpreter, an EFI Byte Code compiler, and an EFI Byte Code linker.
<a href="#">1. Firmware Update and Reporting</a>	Provides an abstraction for devices to provide firmware management support.
<a href="#">1. Network Protocols — SNP, PXE, BIS and HTTP Boot</a>	Defines the protocols that provide access to network devices while executing in the UEFI boot services environment. These protocols include the Simple Network Protocol, the PXE Base Code Protocol, and the Boot Integrity services (BIS) Protocol.



Section/Appendix	Description
<a href="#">25. Network Protocols — Managed Network</a>	Defines the EFI Managed Network Protocol, which provides raw (unformatted) asynchronous network packet I/O services and Managed Network Service Binding Protocol, which is used to locate communication devices that are supported by an MNP driver.
<a href="#">26. Network Protocols — VLAN, EAP, Wi-Fi and Supplicant</a>	Defines a protocol is to provide a manageability interface for VLAN configurations.
<a href="#">27. Network Protocols — Bluetooth</a>	Bluetooth network protocol definitions.
<a href="#">28. Network Protocols — TCP, IP, IPsec, FTP, TLS and Configurations</a>	Defines the EFI TCPv4 (Transmission Control Protocol version 4) Protocol and the EFI IPv4 (Internet Protocol version 4) Protocol interface.
<a href="#">1. Network Protocols — ARP, DHCP, DNS, HTTP and REST</a>	Defines the EFI Address Resolution Protocol (ARP) Protocol interface and the EFI DHCPv4 Protocol.
<a href="#">1. Network Protocols — UDP and MTFTP</a>	Defines the EFI UDPv4 (User Datagram Protocol version 4) Protocol that interfaces over the EFI IPv4 Protocol and defines the EFI MTFTPv4 Protocol interface that is built on the EFI UDPv4 Protocol.
<a href="#">1. Secure Boot and Driver Signing</a>	Describes Secure Boot and a means of generating a digital signature for UEFI.
<a href="#">1. Human Interface Infrastructure Overview</a>	Defines the core code and services that are required for an implementation of the Human Interface Infrastructure (HII), including basic mechanisms for managing user input and code definitions for related protocols.
<a href="#">1. HII Protocols</a>	Provides code definitions for the HII-related protocols, functions, and type definitions, including management of font, strings, images and databases.
<a href="#">1. HII Configuration Processing and Browser Protocol</a>	Describes the data and APIs used to manage the system's configuration: the actual data that describes the knobs and settings.
<a href="#">1. User Identification</a>	Describes services which describe the current user of the platform.
<a href="#">1. Secure Technologies</a>	Describes the protocols for utilizing security technologies including cryptographic hashing and key management.
<a href="#">1. Miscellaneous Protocols</a>	The Timestamp protocol provides a platform independent interface for retrieving a high resolution timestamp counter. The Reset Notification Protocol provides services to register for a notification when ResetSystem is called.
<a href="#">Appendix A: GUID and Time Formats</a>	Explains the GUID (Guaranteed Unique Identifier) format.
<a href="#">Appendix B: Console</a>	Describes the requirements for a basic text-based console required by EFI-conformant systems to provide communication capabilities.
<a href="#">Appendix C: Device Path Examples</a>	Examples of use of the data structures that define various hardware devices to the boot services.
<a href="#">Appendix D: Status Codes</a>	Lists success, error, and warning codes returned by UEFI interfaces.

Section/Appendix	Description
<a href="#">Appendix E: Universal Network Driver Interfaces</a>	Defines the 32/64-bit hardware and software Universal Network Driver Interfaces (UNDIs).
<a href="#">Appendix F: Using the Simple Pointer Protocol</a>	Provides the suggested usage of the Simple Pointer Protocol.
<a href="#">Appendix G: Using the EFI Extended SCSI Pass Thru Protocol</a>	Provides an example of how the SCSI Pass Thru Protocol can be used.
<a href="#">Appendix H: Compression Source Code</a>	The C source code to an implementation of the Compression Algorithm.
<a href="#">Appendix I: Decompression Source Code</a>	The C source code to an implementation of the EFI Decompression Algorithm.
<a href="#">Appendix J: EFI Byte Code Virtual Machine Opcode List</a>	A summary of the opcodes in the instruction set of the EFI Byte Code Virtual Machine.
<a href="#">Appendix K: Alphabetic Function Lists</a>	Lists all UEFI interface functions alphabetically.
<a href="#">Appendix L: EFI 1.10 Protocol Changes and Deprecation List</a>	Lists the Protocol, GUID, and revision identifier name changes and the deprecated protocols compared to the <i>EFI Specification 1.10</i> .
<a href="#">Appendix M: Formats — Language Codes and Language Code Arrays</a>	Lists the formats for language codes and language code arrays.
<a href="#">Appendix N: Common Platform Error Record</a>	Describes the common platform error record format for representing platform hardware errors.
<a href="#">Appendix O: UEFI ACPI Data Table</a>	Defines the UEFI ACPI table format.
<a href="#">Appendix P: Hardware Error Record Persistence Usage</a>	Defines Hardware Error Record Persistence usage.
<a href="#">Appendix Q: References</a>	Lists all necessary or useful specifications, web sites, and other documentation that is referenced in this UEFI specification.
<a href="#">Appendix R: Glossary</a>	Briefly describes terms defined or referenced by this specification.
<a href="#">1. Index</a>	Provides an index to the key terms and concepts in the specification.

## 1.4 Goals

The “PC-AT” boot environment presents significant challenges to innovation within the industry. Each new platform capability or hardware innovation requires firmware developers to craft increasingly complex solutions, and often requires OS developers to make changes to their boot code before customers can benefit from the innovation. This can be a time-consuming process requiring a significant investment of resources.

The primary goal of the UEFI specification is to define an alternative boot environment that can alleviate some of these considerations. In this goal, the specification is similar to other existing boot specifications. The main properties of this specification can be summarized by these attributes:

- ***Coherent, scalable platform environment.*** The specification defines a complete solution for the firmware to describe all platform features and surface platform

capabilities to the OS during the boot process. The definitions are rich enough to cover a range of contemporary processor designs.

- ***Abstraction of the OS from the firmware.*** The specification defines interfaces to platform capabilities. Through the use of abstract interfaces, the specification allows the OS loader to be constructed with far less knowledge of the platform and firmware that underlie those interfaces. The interfaces represent a well-defined and stable boundary between the underlying platform and firmware implementation and the OS loader. Such a boundary allows the underlying firmware and the OS loader to change provided both limit their interactions to the defined interfaces.
- ***Reasonable device abstraction free of legacy interfaces.*** “PC-AT” BIOS interfaces require the OS loader to have specific knowledge of the workings of certain hardware devices. This specification provides OS loader developers with something different: abstract interfaces that make it possible to build code that works on a range of underlying hardware devices without having explicit knowledge of the specifics for each device in the range.
- ***Abstraction of Option ROMs from the firmware.*** This specification defines interfaces to platform capabilities including standard bus types such as PCI, USB, and SCSI. The list of supported bus types may grow over time, so a mechanism to extend to future bus types is included. These defined interfaces, and the ability to extend to future bus types, are components of the UEFI *Driver Model*. One purpose of the UEFI *Driver Model* is to solve a wide range of issues that are present in existing “PC-AT” option ROMs. Like OS loaders, drivers use the abstract interfaces so device drivers and bus drivers can be constructed with far less knowledge of the platform and firmware that underlie those interfaces.
- ***Architecturally shareable system partition.*** Initiatives to expand platform capabilities and add new devices often require software support. In many cases, when these platform innovations are activated before the OS takes control of the platform, they must be supported by code that is specific to the platform rather than to the customer’s choice of OS. The traditional approach to this problem has been to embed code in the platform during manufacturing (for example, in flash memory devices). Demand for such persistent storage is increasing at a rapid rate. This specification defines persistent store on large mass storage media types for use by platform support code extensions to supplement the traditional approach. The definition of how this works is made clear in the specification to ensure that firmware developers, OEMs, operating system vendors, and perhaps even third parties can share the space safely while adding to platform capability.

Defining a boot environment that delivers these attributes could be accomplished in many ways. Indeed, several alternatives, perhaps viable from an academic point of view, already existed at the time this specification was written. These alternatives, however, typically presented high barriers to entry given the current infrastructure capabilities surrounding supported processor platforms. This specification is intended to deliver the attributes listed above, while also recognizing the unique needs of an industry that has considerable investment in compatibility and a large installed base of systems that cannot be abandoned summarily. These needs drive the requirements for the additional attributes embodied in this specification:

- ***Evolutionary, not revolutionary.*** The interfaces and structures in the specification are designed to reduce the burden of an initial implementation as much as possible. While care has been taken to ensure that appropriate abstractions are maintained in the interfaces themselves, the design also ensures that reuse of BIOS code to implement the interfaces is possible with a minimum of additional coding effort. In other words, on PC-AT platforms the specification can be implemented initially as a thin interface layer over an underlying implementation based on existing code. At the same time, introduction of the abstract interfaces provides for migration away from legacy code in the future. Once the abstraction is established as the means for the firmware and OS loader to interact during boot, developers are free to replace legacy code underneath the abstract interfaces at leisure. A similar migration for hardware legacy is also possible. Since the abstractions hide the specifics of devices, it is possible to remove underlying hardware, and replace it with new hardware that provides improved functionality, reduced cost, or both. Clearly this requires that new platform firmware be written to support the device and present it to the OS loader via the abstract interfaces. However, without the interface abstraction, removal of the legacy device might not be possible at all.
- ***Compatibility by design.*** The design of the system partition structures also preserves all the structures that are currently used in the “PC-AT” boot environment. Thus, it is a simple matter to construct a single system that is capable of booting a legacy OS or an EFI-aware OS from the same disk.
- ***Simplifies addition of OS-neutral platform value-add.*** The specification defines an open, extensible interface that lends itself to the creation of platform “drivers.” These may be analogous to OS drivers, providing support for new device types during the boot process, or they may be used to implement enhanced platform capabilities, such as fault tolerance or security. Furthermore, this ability to extend platform capability is designed into the specification from the outset. This is intended to help developers avoid many of the frustrations inherent in trying to squeeze new code into the traditional BIOS environment. As a result of the inclusion of interfaces to add new protocols, OEMs or firmware developers have an infrastructure to add capability to the platform in a modular way. Such drivers may potentially be implemented using high-level coding languages because of the calling conventions and environment defined in the specification. This in turn may help to reduce the difficulty and cost of innovation. The option of a system partition provides an alternative to nonvolatile memory storage for such extensions.
- ***Built on existing investment.*** Where possible, the specification avoids redefining interfaces and structures in areas where existing industry specifications provide adequate coverage. For example, the ACPI specification provides the OS with all the information necessary to discover and configure platform resources. Again, this philosophical choice for the design of the specification is intended to keep barriers to its adoption as low as possible.

## 1.5 Target Audience

This document is intended for the following readers:

- IHVs and OEMs who will be implementing UEFI drivers.
- OEMs who will be creating supported processor platforms intended to boot shrink-wrap operating systems.
- BIOS developers, either those who create general-purpose BIOS and other firmware products or those who modify these products for use in supported processor-based products.
- Operating system developers who will be adapting their shrink-wrap operating system products to run on supported processor-based platforms.

## 1.6 UEFI Design Overview

The design of UEFI is based on the following fundamental elements:

- **Reuse of existing table-based interfaces.** In order to preserve investment in existing infrastructure support code, both in the OS and firmware, a number of existing specifications that are commonly implemented on platforms compatible with supported processor specifications must be implemented on platforms wishing to comply with the UEFI specification. (For additional information, see [Appendix O: References](#).)
- **System partition.** The System partition defines a partition and file system that are designed to allow safe sharing between multiple vendors, and for different purposes. The ability to include a separate, sharable system partition presents an opportunity to increase platform value-add without significantly growing the need for nonvolatile platform memory.
- **Boot services.** Boot services provide interfaces for devices and system functionality that can be used during boot time. Device access is abstracted through “handles” and “protocols.” This facilitates reuse of investment in existing BIOS code by keeping underlying implementation requirements out of the specification without burdening the consumer accessing the device.
- **Runtime services.** A minimal set of runtime services is presented to ensure appropriate abstraction of base platform hardware resources that may be needed by the OS during its normal operations.

[Figure 1](#) shows the principal components of UEFI and their relationship to platform hardware and OS software.

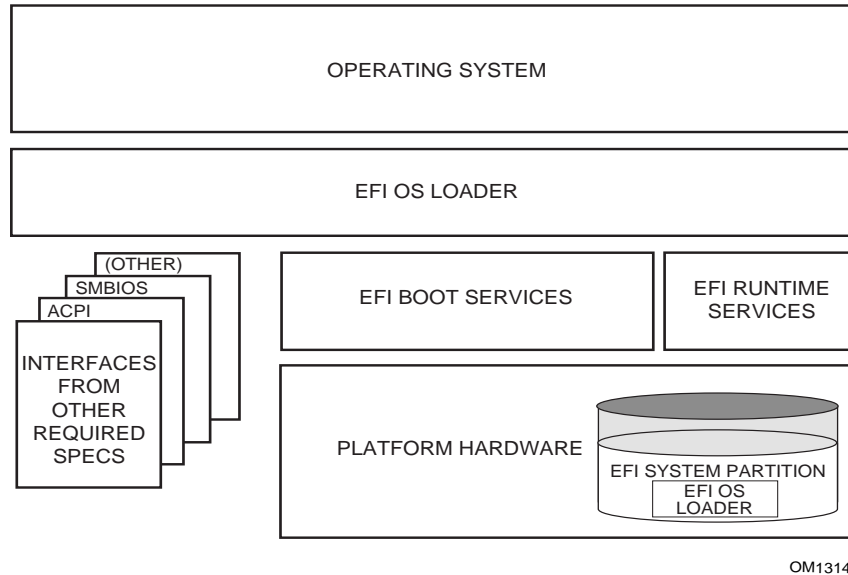

Figure 1. UEFI Conceptual Overview

[Figure 1](#) illustrates the interactions of the various components of an UEFI specification-compliant system that are used to accomplish platform and OS boot.

The platform firmware is able to retrieve the OS loader image from the System Partition. The specification provides for a variety of mass storage device types including disk, CD-ROM, and DVD as well as remote boot via a network. Through the extensible protocol interfaces, it is possible to add other boot media types, although these may require OS loader modifications if they require use of protocols other than those defined in this document.

Once started, the OS loader continues to boot the complete operating system. To do so, it may use the EFI boot services and interfaces defined by this or other required specifications to survey, comprehend, and initialize the various platform components and the OS software that manages them. EFI runtime services are also available to the OS loader during the boot phase.

## 1.7 UEFI Driver Model

This section describes the goals of a driver model for firmware conforming to this specification. The goal is for this driver model to provide a mechanism for implementing bus drivers and device drivers for all types of buses and devices. At the time of writing, supported bus types include PCI, USB, and so on.

As hardware architectures continue to evolve, the number and types of buses present in platforms are increasing. This trend is especially true in high-end servers. However, a more diverse set of bus types is being designed into desktop and mobile systems and even some embedded systems. This increasing complexity means that a simple method

for describing and managing all the buses and devices in a platform is required in the preboot environment. The UEFI *Driver Model* provides this simple method in the form of protocols services and boot services.

### 1.7.1 UEFI Driver Model Goals

The UEFI *Driver Model* has the following goals:

- **Compatible** – Drivers conforming to this specification must maintain compatibility with the *EFI 1.10 Specification* and the *UEFI Specification*. This means that the UEFI *Driver Model* takes advantage of the extensibility mechanisms in the *UEFI 2.0 Specification* to add the required functionality.
- **Simple** – Drivers that conform to this specification must be simple to implement and simple to maintain. The UEFI *Driver Model* must allow a driver writer to concentrate on the specific device for which the driver is being developed. A driver should not be concerned with platform policy or platform management issues. These considerations should be left to the system firmware.
- **Scalable** – The UEFI *Driver Model* must be able to adapt to all types of platforms. These platforms include embedded systems, mobile, and desktop systems, as well as workstations and servers.
- **Flexible** – The UEFI *Driver Model* must support the ability to enumerate all the devices, or to enumerate only those devices required to boot the required OS. The minimum device enumeration provides support for more rapid boot capability, and the full device enumeration provides the ability to perform OS installations, system maintenance, or system diagnostics on any boot device present in the system.
- **Extensible** – The UEFI *Driver Model* must be able to extend to future bus types as they are defined.
- **Portable** – Drivers written to the UEFI *Driver Model* must be portable between platforms and between supported processor architectures.
- **Interoperable** – Drivers must coexist with other drivers and system firmware and must do so without generating resource conflicts.
- **Describe complex bus hierarchies** – The UEFI *Driver Model* must be able to describe a variety of bus topologies from very simple single bus platforms to very complex platforms containing many buses of various types.
- **Small driver footprint** – The size of executables produced by the UEFI *Driver Model* must be minimized to reduce the overall platform cost. While flexibility and extensibility are goals, the additional overhead required to support these must be kept to a minimum to prevent the size of firmware components from becoming unmanageable.
- **Address legacy option rom issues** – The UEFI *Driver Model* must directly address and solve the constraints and limitations of legacy option ROMs. Specifically, it must be possible to build add-in cards that support both UEFI drivers and legacy option ROMs, where such cards can execute in both legacy BIOS systems and UEFI-conforming platforms, without modifications to the code carried on the card. The solution must

provide an evolutionary path to migrate from legacy option ROMs driver to UEFI drivers.

## 1.7.2 Legacy Option ROM Issues

This idea of supporting a driver model came from feedback on the *UEFI Specification* that provided a clear, market-driven requirement for an alternative to the legacy option ROM (sometimes also referred to as an expansion ROM). The perception is that the advent of the *UEFI Specification* represents a chance to escape the limitations implicit in the construction and operation of legacy option ROM images by replacing them with an alternative mechanism that works within the framework of the *UEFI Specification*.

## 1.8 Migration Requirements

Migration requirements cover the transition period from initial implementation of this specification to a future time when all platforms and operating systems implement to this specification. During this period, two major compatibility considerations are important:

- The ability to continue booting legacy operating systems;
- The ability to implement UEFI on existing platforms by reusing as much existing firmware code to keep development resource and time requirements to a minimum.

### 1.8.1 Legacy Operating System Support

The UEFI specification represents the preferred means for a shrink-wrap OS and firmware to communicate during the boot process. However, choosing to make a platform that complies with this specification in no way precludes a platform from also supporting existing legacy OS binaries that have no knowledge of the UEFI specification.

The UEFI specification does not restrict a platform designer who chooses to support both the UEFI specification and a more traditional "PC-AT" boot infrastructure. If such a legacy infrastructure is to be implemented, it should be developed in accordance with existing industry practice that is defined outside the scope of this specification. The choice of legacy operating systems that are supported on any given platform is left to the manufacturer of that platform.

### 1.8.2 Supporting the UEFI Specification on a Legacy Platform

The UEFI specification has been carefully designed to allow for existing systems to be extended to support it with a minimum of development effort. In particular, the abstract structures and services defined in the UEFI specification can all be supported on legacy platforms.

For example, to accomplish such support on an existing and supported 32-bit-based platform that uses traditional BIOS to support operating system boot, an additional layer of firmware code would need to be provided. This extra code would be required to translate existing interfaces for services and devices into support for the abstractions defined in this specification.



## 1.9 Conventions Used in this Document

This document uses typographic and illustrative conventions described below.

### 1.9.1 Data Structure Descriptions

Supported processors are “little endian” machines. This distinction means that the low-order byte of a multibyte data item in memory is at the lowest address, while the high-order byte is at the highest address. Some supported 64-bit processors may be configured for both “little endian” and “big endian” operation. All implementations designed to conform to this specification use “little endian” operation.

In some memory layout descriptions, certain fields are marked *reserved*. Software must initialize such fields to zero and ignore them when read. On an update operation, software must preserve any reserved field.

### 1.9.2 Protocol Descriptions

A protocol description generally has the following format:

**Protocol Name:**The formal name of the protocol interface.

**Summary:**A brief description of the protocol interface.

**GUID:**The 128-bit Globally Unique Identifier (GUID) for the protocol interface.

**Protocol Interface Structure:**

A “C-style” data structure definition containing the procedures and data fields produced by this protocol interface.

**Parameters:**A brief description of each field in the protocol interface structure.

**Description:**A description of the functionality provided by the interface, including any limitations and caveats of which the caller should be aware.

**Related Definitions:**The type declarations and constants that are used in the protocol interface structure or any of its procedures.

### 1.9.3 Procedure Descriptions

A procedure description generally has the following format:

**ProcedureName():**The formal name of the procedure.

**Summary:**A brief description of the procedure.

**Prototype:**A “C-style” procedure header defining the calling sequence.

**Parameters:**A brief description of each field in the procedure prototype.

**Description:**A description of the functionality provided by the interface, including any limitations and caveats of which the caller should be aware.

**Related Definitions:**The type declarations and constants that are used only by this procedure.

**Status Codes Returned:**A description of any codes returned by the interface. The procedure is required to implement any status codes listed in this table. Additional error codes may be returned, but they will not be tested by standard compliance tests, and any software that uses the procedure cannot depend on any of the extended error codes that an implementation may provide.

### 1.9.4 Instruction Descriptions

An instruction description for EBC instructions generally has the following format:

**InstructionName**The formal name of the instruction.

**Syntax:** A brief description of the instruction.

**Description:**A description of the functionality provided by the instruction accompanied by a table that details the instruction encoding.

**Operation:**Details the operations performed on operands.

**Behaviors and Restrictions:**

An item-by-item description of the behavior of each operand involved in the instruction and any restrictions that apply to the operands or the instruction.

### 1.9.5 Pseudo-Code Conventions

Pseudo code is presented to describe algorithms in a more concise form. None of the algorithms in this document are intended to be compiled directly. The code is presented at a level corresponding to the surrounding text.

In describing variables, a *list* is an unordered collection of homogeneous objects. A *queue* is an ordered list of homogeneous objects. Unless otherwise noted, the ordering is assumed to be FIFO.

Pseudo code is presented in a C-like format, using C conventions where appropriate. The coding style, particularly the indentation style, is used for readability and does not necessarily comply with an implementation of the *UEFI Specification*.

### 1.9.6 Typographic Conventions

This document uses the typographic and illustrative conventions described below:

Plain text

The normal text typeface is used for the vast majority of the descriptive text in a specification.

<u>Plain text (blue)</u>	Any <u>plain text</u> that is underlined and in blue indicates an active link to the cross-reference. Click on the word to follow the hyperlink.
<b>Bold</b>	In text, a <b>Bold</b> typeface identifies a processor register name. In other instances, a <b>Bold</b> typeface can be used as a running head within a paragraph.
<i>Italic</i>	In text, an <i>Italic</i> typeface can be used as emphasis to introduce a new term or to indicate a manual or specification name.
<b>BOLD Monospace</b>	Computer code, example code segments, and all prototype code segments use a <b>BOLD Monospace</b> typeface with a dark red color. These code listings normally appear in one or more separate paragraphs, though words or segments can also be embedded in a normal text paragraph.
<u>Bold Monospace</u>	Words in a <u>Bold Monospace</u> typeface that is underlined and in blue indicate an active hyperlink to the code definition for that function or type definition. Click on the word to follow the hyperlink.

**Note:** *Due to management and file size considerations, only the first occurrence of the reference on each page is an active link. Subsequent references on the same page will not be actively linked to the definition and will use the standard, nonunderlined **BOLD Monospace** typeface. Find the first instance of the name (in the underlined BOLD Monospace typeface) on the page and click on the word to jump to the function or type definition.*

<i>Italic Monospace</i>	In code or in text, words in <i>Italic Monospace</i> indicate placeholder names for variable information that must be supplied (i.e., arguments).
-------------------------	---

## 1.9.7 Number formats

A binary number is represented in this standard by any sequence of digits consisting of only the Western-Arabic numerals 0 and 1 immediately followed by a lower-case b (e.g., 0101b).

Underscores or spaces may be included between characters in binary number representations to increase readability or delineate field boundaries (e.g., 0 0101 1010b or 0\_0101\_1010b).

### 1.9.7.1 Hexadecimal

A hexadecimal number is represented in this standard by 0x preceding any sequence of digits consisting of only the Western-Arabic numerals 0 through 9 and/or the upper-case English letters A through F (e.g., 0xFA23).

Underscores or spaces may be included between characters in hexadecimal number representations to increase readability or delineate field boundaries (e.g., 0xB FD8C FA23 or 0xB\_FD8C\_FA23).

### 1.9.7.2 Decimal

A decimal number is represented in this standard by any sequence of digits consisting of only the Arabic numerals 0 through 9 not immediately followed by a lower-case b or lower-case h (e.g., 25).

This standard uses the following conventions for representing decimal numbers:

- the decimal separator (i.e., separating the integer and fractional portions of the number) is a period;
- the thousands separator (i.e., separating groups of three digits in a portion of the number) is a comma;
- the thousands separator is used in the integer portion and is not used in the fraction portion of a number.

### 1.9.8 Binary prefixes

This standard uses the prefixes defined in the International System of Units (SI) for values that are powers of ten. See “Links to UEFI-Related Documents” (<http://uefi.org/uefi>) under the heading “SI Binary Prefixes”.

**Table 1. SI prefixes**

$10^3$	1,000	kilo	K
$10^6$	1,000,000	mega	M
$10^9$	1,000,000,000	giga	G

This standard uses the binary prefixes defined in ISO/IEC 80000-13 *Quantities and units - Part 13: Information science and technology* and IEEE 1514 *Standard for Prefixes for Binary Multiples* for values that are powers of two.

**Table 2. Binary prefixes**

Factor	Factor	Name	Symbol
$2^{10}$	1,024	kibi	Ki
$2^{20}$	1,048,576	mebi	Mi
$2^{30}$	1,073,741,824	gibi	Gi

For example, 4 KB means 4,000 bytes and 4 KiB means 4,096 bytes.

## 2 Overview

UEFI allows the extension of platform firmware by loading UEFI driver and UEFI application images. When UEFI drivers and UEFI applications are loaded they have access to all UEFI-defined runtime and boot services. See [Figure 2](#).

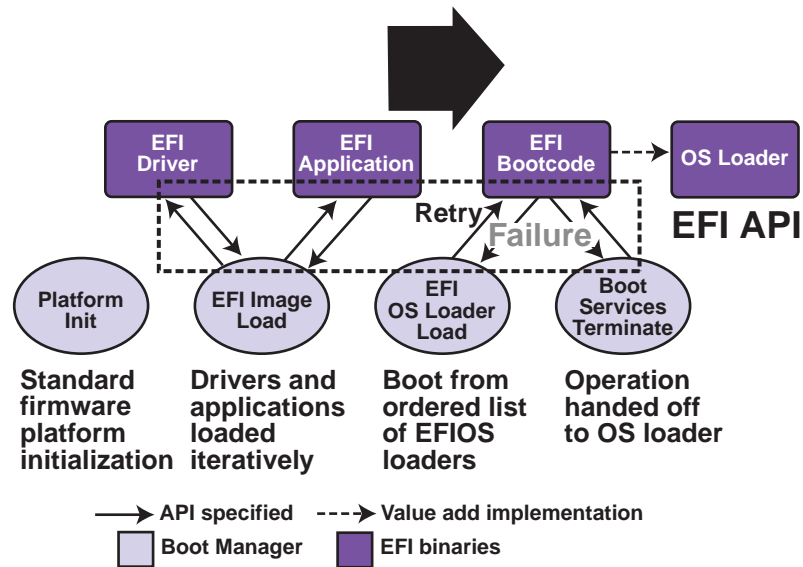

OM13144

Figure 2. Booting Sequence

UEFI allows the consolidation of boot menus from the OS loader and platform firmware into a single platform firmware menu. These platform firmware menus will allow the selection of any UEFI OS loader from any partition on any boot medium that is supported by UEFI boot services. An UEFI OS loader can support multiple options that can appear on the user interface. It is also possible to include legacy boot options, such as booting from the A: or C: drive in the platform firmware boot menu.

UEFI supports booting from media that contain an UEFI OS loader or an UEFI-defined System Partition. An UEFI-defined System Partition is required by UEFI to boot from a block device. UEFI does not require any change to the first sector of a partition, so it is possible to build media that will boot on both legacy architectures and UEFI platforms.

### 2.1 Boot Manager

UEFI contains a boot manager that allows the loading of applications written to this specification (including OS 1st stage loader) or UEFI drivers from any file on an UEFI-defined file system or through the use of an UEFI-defined image loading service. UEFI defines NVRAM variables that are used to point to the file to be loaded. These variables also contain application-specific data that are passed directly to the UEFI application. The

variables also contain a human readable string that can be displayed in a menu to the user.

The variables defined by UEFI allow the system firmware to contain a boot menu that can point to all of the operating systems, and even multiple versions of the same operating systems. The design goal of UEFI was to have one set of boot menus that could live in platform firmware. UEFI specifies only the NVRAM variables used in selecting boot options. UEFI leaves the implementation of the menu system as value added implementation space.

UEFI greatly extends the boot flexibility of a system over the current state of the art in the PC-AT-class system. The PC-AT-class systems today are restricted to boot from the first floppy, hard drive, CD-ROM, USB keys, or network card attached to the system. Booting from a common hard drive can cause many interoperability problems between operating systems, and different versions of operating systems from the same vendor.

### 2.1.1 UEFI Images

UEFI Images are a class of files defined by UEFI that contain executable code. The most distinguishing feature of UEFI Images is that the first set of bytes in the UEFI Image file contains an image header that defines the encoding of the executable image.

UEFI uses a subset of the PE32+ image format with a modified header signature. The modification to the signature value in the PE32+ image is done to distinguish UEFI images from normal PE32 executables. The "+" addition to PE32 provides the 64-bit relocation fix-up extensions to standard PE32 format.

For images with the UEFI image signature, the *Subsystem* values in the PE image header are defined below. The major differences between image types are the memory type that the firmware will load the image into, and the action taken when the image's entry point exits or returns. A UEFI application image is always unloaded when control is returned from the image's entry point. A UEFI driver image is only unloaded if control is passed back with a UEFI error code.

```
// PE32+ Subsystem type for EFI images
#define EFI_IMAGE_SUBSYSTEM_EFI_APPLICATION  10
#define EFI_IMAGE_SUBSYSTEM_EFI_BOOT_SERVICE_DRIVER 11
#define EFI_IMAGE_SUBSYSTEM_EFI_RUNTIME_DRIVER 12

// PE32+ Machine type for EFI images
#define EFI_IMAGE_MACHINE_IA32  0x014c
#define EFI_IMAGE_MACHINE_IA64  0x0200
#define EFI_IMAGE_MACHINE_EBC  0x0EBC
#define EFI_IMAGE_MACHINE_x64  0x8664
#define EFI_IMAGE_MACHINE_ARMTHUMB_MIXED 0x01C2
#define EFI_IMAGE_MACHINE_AARCH64  0xAA64
#define EFI_IMAGE_MACHINE_RISCV32  0x5032
#define EFI_IMAGE_MACHINE_RISCV64  0x5064
#define EFI_IMAGE_MACHINE_RISCV128 0x5128
```

**Note:** This image type is chosen to enable UEFI images to contain Thumb and Thumb2 instructions while defining the EFI interfaces themselves to be in ARM mode.

**Table 3. UEFI Image Memory Types**

Subsystem Type	Code Memory Type	Data Memory Type
EFI_IMAGE_SUBSYSTEM_EFI_APPLICATION	EfiLoaderCode	EfiLoaderData
EFI_IMAGE_SUBSYSTEM_EFI_BOOT_SERVICE_DRIVER	EfiBootServicesCode	EfiBootServicesData
EFI_IMAGE_SUBSYSTEM_EFI_RUNTIME_DRIVER	EfiRuntimeServicesCode	EfiRuntimeServicesData

The *Machine* value that is found in the PE image file header is used to indicate the machine code type of the image. The machine code types for images with the UEFI image signature are defined below. A given platform must implement the image type native to that platform and the image type for EFI Byte Code (EBC). Support for other machine code types is optional to the platform.

A UEFI image is loaded into memory through the [EFI\\_BOOT\\_SERVICES.LoadImage\(\)](#) Boot Service. This service loads an image with a PE32+ format into memory. This PE32+ loader is required to load all sections of the PE32+ image into memory. Once the image is loaded into memory, and the appropriate fix-ups have been performed, control is transferred to a loaded image at the *AddressOfEntryPoint* reference according to the normal indirect calling conventions of applications based on supported 32-bit, 64-bit, or 128-bit processors. All other linkage to and from a UEFI image is done programmatically.

## 2.1.2 UEFI Applications

Applications written to this specification are loaded by the Boot Manager or by other UEFI applications. To load a UEFI application the firmware allocates enough memory to hold the image, copies the sections within the UEFI application image to the allocated memory, and applies the relocation fix-ups needed. Once done, the allocated memory is set to be the proper type for code and data for the image. Control is then transferred to the UEFI application's entry point. When the application returns from its entry point, or when it calls the Boot Service [EFI\\_BOOT\\_SERVICES.Exit\(\)](#), the UEFI application is unloaded from memory and control is returned to the UEFI component that loaded the UEFI application.

When the Boot Manager loads a UEFI application, the image handle may be used to locate the "load options" for the UEFI application. The load options are stored in nonvolatile storage and are associated with the UEFI application being loaded and executed by the Boot Manager.

## 2.1.3 UEFI OS Loaders

A UEFI OS loader is a special type of UEFI application that normally takes over control of the system from firmware conforming to this specification. When loaded, the UEFI OS loader behaves like any other UEFI application in that it must only use memory it has allocated from the firmware and can only use UEFI services and protocols to access the devices that the firmware exposes. If the UEFI OS loader includes any boot service style

driver functions, it must use the proper UEFI interfaces to obtain access to the bus specific-resources. That is, I/O and memory-mapped device registers must be accessed through the proper bus specific I/O calls like those that a UEFI driver would perform.

If the UEFI OS loader experiences a problem and cannot load its operating system correctly, it can release all allocated resources and return control back to the firmware via the Boot Service **Exit()** call. The **Exit()** call allows both an error code and *ExitData* to be returned. The *ExitData* contains both a string and OS loader-specific data to be returned.

If the UEFI OS loader successfully loads its operating system, it can take control of the system by using the Boot Service [EFI\\_BOOT\\_SERVICES.ExitBootServices\(\)](#). After successfully calling **ExitBootServices()**, all boot services in the system are terminated, including memory management, and the UEFI OS loader is responsible for the continued operation of the system.

## 2.1.4 UEFI Drivers

UEFI drivers are loaded by the Boot Manager, firmware conforming to this specification, or by other UEFI applications. To load a UEFI driver the firmware allocates enough memory to hold the image, copies the sections within the UEFI driver image to the allocated memory and applies the relocation fix-ups needed. Once done, the allocated memory is set to be the proper type for code and data for the image. Control is then transferred to the UEFI driver's entry point. When the UEFI driver returns from its entry point, or when it calls the Boot Service [EFI\\_BOOT\\_SERVICES.Exit\(\)](#), the UEFI driver is optionally unloaded from memory and control is returned to the component that loaded the UEFI driver. A UEFI driver is not unloaded from memory if it returns a status code of **EFI\_SUCCESS**. If the UEFI driver's return code is an error status code, then the driver is unloaded from memory.

There are two types of UEFI drivers: boot service drivers and runtime drivers. The only difference between these two driver types is that UEFI runtime drivers are available after a UEFI OS loader has taken control of the platform with the Boot Service [EFI\\_BOOT\\_SERVICES.ExitBootServices\(\)](#).

UEFI boot service drivers are terminated when **ExitBootServices()** is called, and all the memory resources consumed by the UEFI boot service drivers are released for use in the operating system environment.

A runtime driver of type `EFI_IMAGE_SUBSYSTEM_EFI_RUNTIME_DRIVER` gets fixed up with virtual mappings when the OS calls [SetVirtualAddressMap\(\)](#).

## 2.2 Firmware Core

This section provides an overview of the services defined by UEFI. These include boot services and runtime services.

### 2.2.1 UEFI Services

The purpose of the UEFI interfaces is to define a common boot environment abstraction for use by loaded UEFI images, which include UEFI drivers, UEFI applications, and UEFI OS



loaders. The calls are defined with a full 64-bit interface, so that there is headroom for future growth. The goal of this set of abstracted platform calls is to allow the platform and OS to evolve and innovate independently of one another. Also, a standard set of primitive runtime services may be used by operating systems.

Platform interfaces defined in this section allow the use of standard Plug and Play Option ROMs as the underlying implementation methodology for the boot services. The interfaces have been designed in such a way as to map back into legacy interfaces. These interfaces have in no way been burdened with any restrictions inherent to legacy Option ROMs.

The UEFI platform interfaces are intended to provide an abstraction between the platform and the OS that is to boot on the platform. The UEFI specification also provides abstraction between diagnostics or utility programs and the platform; however, it does not attempt to implement a full diagnostic OS environment. It is envisioned that a small diagnostic OS-like environment can be easily built on top of an UEFI system. Such a diagnostic environment is not described by this specification.

Interfaces added by this specification are divided into the following categories and are detailed later in this document:

- Runtime services
- Boot services interfaces, with the following subcategories:
  - Global boot service interfaces
  - Device handle-based boot service interfaces
  - Device protocols
  - Protocol services

## 2.2.2 Runtime Services

This section describes UEFI runtime service functions. The primary purpose of the runtime services is to abstract minor parts of the hardware implementation of the platform from the OS. Runtime service functions are available during the boot process and also at runtime provided the OS switches into flat physical addressing mode to make the runtime call. However, if the OS loader or OS uses the Runtime Service [SetVirtualAddressMap\(\)](#) service, the OS will only be able to call runtime services in a virtual addressing mode. All runtime interfaces are non-blocking interfaces and can be called with interrupts disabled if desired. To ensure maximum compatibility with existing platforms it is recommended that all UEFI modules that comprise the Runtime Services be represented in the *MemoryMap* as a single **EFI\_MEMORY\_DESCRIPTOR** of Type **EfiRuntimeServicesCode**.

In all cases memory used by the runtime services must be reserved and not used by the OS. runtime services memory is always available to an UEFI function and will never be directly manipulated by the OS or its components. UEFI is responsible for defining the hardware resources used by runtime services, so the OS can synchronize with those resources when runtime service calls are made, or guarantee that the OS never uses those resources.

[Table 4](#) lists the Runtime Services functions.

Table 4. UEFI Runtime Services

Name	Description
<a href="#">GetTime()</a>	Returns the current time, time context, and time keeping capabilities.
<a href="#">SetTime()</a>	Sets the current time and time context.
<a href="#">GetWakeupTime()</a>	Returns the current wakeup alarm settings.
<a href="#">SetWakeupTime()</a>	Sets the current wakeup alarm settings.
<a href="#">GetVariable()</a>	Returns the value of a named variable.
<a href="#">GetNextVariableName()</a>	Enumerates variable names.
<a href="#">SetVariable()</a>	Sets, and if needed creates, a variable.
<a href="#">SetVirtualAddressMap()</a>	Switches all runtime functions from physical to virtual addressing.
<a href="#">ConvertPointer()</a>	Used to convert a pointer from physical to virtual addressing.
<a href="#">GetNextHighMonotonicCount()</a>	Subsumes the platform's monotonic counter functionality.
<a href="#">ResetSystem()</a>	Resets all processors and devices and reboots the system.
<a href="#">UpdateCapsule()</a>	Passes capsules to the firmware with both virtual and physical mapping.
<a href="#">QueryCapsuleCapabilities()</a>	Returns if the capsule can be supported via <b>UpdateCapsule()</b> .
<a href="#">QueryVariableInfo()</a>	Returns information about the EFI variable store.

## 2.3 Calling Conventions

Unless otherwise stated, all functions defined in the UEFI specification are called through pointers in common, architecturally defined, calling conventions found in C compilers. Pointers to the various global UEFI functions are found in the **EFI\_RUNTIME\_SERVICES** and **EFI\_BOOT\_SERVICES** tables that are located via the system table. Pointers to other functions defined in this specification are located dynamically through device handles. In all cases, all pointers to UEFI functions are cast with the word **EFI\_API**. This allows the compiler for each architecture to supply the proper compiler keywords to achieve the needed calling conventions. When passing pointer arguments to Boot Services, Runtime Services, and Protocol Interfaces, the caller has the following responsibilities:

- It is the caller's responsibility to pass pointer parameters that reference physical memory locations. If a pointer is passed that does not point to a physical memory location (i.e., a memory mapped I/O region), the results are unpredictable and the system may halt.
- It is the caller's responsibility to pass pointer parameters with correct alignment. If an unaligned pointer is passed to a function, the results are unpredictable and the system may halt.

- It is the caller's responsibility to not pass in a **NULL** parameter to a function unless it is explicitly allowed. If a **NULL** pointer is passed to a function, the results are unpredictable and the system may hang.
- Unless otherwise stated, a caller should not make any assumptions regarding the state of pointer parameters if the function returns with an error.
- A caller may not pass structures that are larger than native size by value and these structures must be passed by reference (via a pointer) by the caller. Passing a structure larger than native width (4 bytes on supported 32-bit processors; 8 bytes on supported 64-bit processor instructions) on the stack will produce undefined results.

Calling conventions for supported 32-bit and supported 64-bit applications are described in more detail below. Any function or protocol may return any valid return code.

All public interfaces of a UEFI module must follow the UEFI calling convention. Public interfaces include the image entry point, UEFI event handlers, and protocol member functions. The type `EFI_API` is used to indicate conformance to the calling conventions defined in this section. Non public interfaces, such as private functions and static library calls, are not required to follow the UEFI calling conventions and may be optimized by the compiler.

### 2.3.1 Data Types

[Table 5](#) lists the common data types that are used in the interface definitions, and [Table 6](#) lists their modifiers. Unless otherwise specified all data types are naturally aligned. Structures are aligned on boundaries equal to the largest internal datum of the structure and internal data are implicitly padded to achieve natural alignment.

The values of the pointers passed into or returned by the UEFI interfaces must provide natural alignment for the underlying types.

Table 5. Common UEFI Data Types

Mnemonic	Description
BOOLEAN	Logical Boolean. 1-byte value containing a 0 for <b>FALSE</b> or a 1 for <b>TRUE</b> . Other values are undefined.
INTN	Signed value of native width. (4 bytes on supported 32-bit processor instructions, 8 bytes on supported 64-bit processor instructions, 16 bytes on supported 128-bit processor instructions)
UINTN	Unsigned value of native width. (4 bytes on supported 32-bit processor instructions, 8 bytes on supported 64-bit processor instructions, 16 bytes on supported 128-bit processor instructions)
INT8	1-byte signed value.
UINT8	1-byte unsigned value.
INT16	2-byte signed value.
UINT16	2-byte unsigned value.
INT32	4-byte signed value.
UINT32	4-byte unsigned value.
INT64	8-byte signed value.
UINT64	8-byte unsigned value.
INT128	16-byte signed value.
UINT128	16-byte unsigned value.
CHAR8	1-byte character. Unless otherwise specified, all 1-byte or ASCII characters and strings are stored in 8-bit ASCII encoding format, using the ISO-Latin-1 character set.
CHAR16	2-byte Character. Unless otherwise specified all characters and strings are stored in the UCS-2 encoding format as defined by Unicode 2.1 and ISO/IEC 10646 standards.
VOID	Undeclared type.
EFI_GUID	128-bit buffer containing a unique identifier value. Unless otherwise specified, aligned on a 64-bit boundary.
EFI_STATUS	Status code. Type UINTN.
EFI_HANDLE	A collection of related interfaces. Type VOID *.
EFI_EVENT	Handle to an event structure. Type VOID *.
EFI_LBA	Logical block address. Type UINT64.
EFI_TPL	Task priority level. Type UINTN.
EFI_MAC_ADDRESS	32-byte buffer containing a network Media Access Control address.
EFI_IPv4_ADDRESS	4-byte buffer. An IPv4 internet protocol address.
EFI_IPv6_ADDRESS	16-byte buffer. An IPv6 internet protocol address.
EFI_IP_ADDRESS	16-byte buffer aligned on a 4-byte boundary. An IPv4 or IPv6 internet protocol address.
<Enumerated Type>	Element of a standard ANSI C <b>enum</b> type declaration. Type INT32.or UINT32. ANSI C does not define the size of sign of an enum so they should never be used in structures. ANSI C integer promotion rules make INT32 or UINT32 interchangeable when passed as an argument to a function.

Mnemonic	Description
sizeof (VOID *)	4 bytes on supported 32-bit processor instructions. 8 bytes on supported 64-bit processor instructions. 16 bytes on supported 128-bit processor.
Bitfields	Bitfields are ordered such that bit 0 is the least significant bit.

**Table 6. Modifiers for Common UEFI Data Types**

Mnemonic	Description
IN	Datum is passed to the function.
OUT	Datum is returned from the function.
OPTIONAL	Passing the datum to the function is optional, and a <b>NULL</b> may be passed if the value is not supplied.
CONST	Datum is read-only.
EFIAPI	Defines the calling convention for UEFI interfaces.

### 2.3.2 IA-32 Platforms

All functions are called with the C language calling convention. The general-purpose registers that are volatile across function calls are **eax**, **ecx**, and **edx**. All other general-purpose registers are nonvolatile and are preserved by the target function. In addition, unless otherwise specified by the function definition, all other registers are preserved.

Firmware boot services and runtime services run in the following processor execution mode prior to the OS calling `ExitBootServices()`:

- Uniprocessor, as described in chapter 8.4 of:
  - *Intel 64 and IA-32 Architectures Software Developer's Manual*
  - Volume 3, System Programming Guide, Part 1
  - Order Number: 253668-033US, December 2009
  - See "Links to UEFI-Related Documents" (<http://uefi.org/uefi>) under the heading "Intel Processor Manuals."
- Protected mode
- Paging mode may be enabled. If paging mode is enabled, PAE (Physical Address Extensions) mode is recommended. If paging mode is enabled, any memory space defined by the UEFI memory map is identity mapped (virtual address equals physical address). The mappings to other regions are undefined and may vary from implementation to implementation.
- Selectors are set to be flat and are otherwise not used
- Interrupts are enabled—though no interrupt services are supported other than the UEFI boot services timer functions (All loaded device drivers are serviced synchronously by "polling.")
- Direction flag in EFLAGS is clear
- Other general purpose flag registers are undefined
- 128 KiB, or more, of available stack space

- The stack must be 16-byte aligned. Stack may be marked as non-executable in identity mapped page tables.
- Floating-point control word must be initialized to 0x027F (all exceptions masked, double-precision, round-to-nearest)
- Multimedia-extensions control word (if supported) must be initialized to 0x1F80 (all exceptions masked, round-to-nearest, flush to zero for masked underflow).
- CR0.EM must be zero
- CR0.TS must be zero

An application written to this specification may alter the processor execution mode, but the UEFI image must ensure firmware boot services and runtime services are executed with the prescribed execution environment.

After an Operating System calls **ExitBootServices()**, firmware boot services are no longer available and it is illegal to call any boot service. After **ExitBootServices**, firmware runtime services are still available and may be called with paging enabled and virtual address pointers if **SetVirtualAddressMap()** has been called describing all virtual address ranges used by the firmware runtime service.

For an operating system to use any UEFI runtime services, it must:

- Preserve all memory in the memory map marked as runtime code and runtime data
- Call the runtime service functions, with the following conditions:
  - In protected mode
  - Paging may or may *not* be enabled, however if paging is enabled and **SetVirtualAddressMap()** has not been called, any memory space defined by the UEFI memory map is identity mapped (virtual address equals physical address), although the attributes of certain regions may not have all read, write, and execute attributes or be unmarked for purposes of platform protection. The mappings to other regions are undefined and may vary from implementation to implementation. See description of [SetVirtualAddressMap\(\)](#) for details of memory map after this function has been called.
  - Direction flag in EFLAGS clear
  - 4 KiB, or more, of available stack space
  - The stack must be 16-byte aligned
  - Floating-point control word must be initialized to 0x027F (all exceptions masked, double-precision, round-to-nearest)
  - Multimedia-extensions control word (if supported) must be initialized to 0x1F80 (all exceptions masked, round-to-nearest, flush to zero for masked underflow)
  - CR0.EM must be zero
  - CR0.TS must be zero
  - Interrupts disabled or enabled at the discretion of the caller
- ACPI Tables loaded at boot time can be contained in memory of type **EfiACPIReclaimMemory** (recommended) or **EfiACPIMemoryNVS**. ACPI FACS must be contained in memory of type **EfiACPIMemoryNVS**.
- The system firmware must not request a virtual mapping for any memory descriptor of type **EfiACPIReclaimMemory** or **EfiACPIMemoryNVS**.

- EFI memory descriptors of type **EfiACPIReclaimMemory** and **EfiACPIMemoryNVS** must be aligned on a 4 KiB boundary and must be a multiple of 4 KiB in size.
- Any UEFI memory descriptor that requests a virtual mapping via the **EFI\_MEMORY\_DESCRIPTOR** having the **EFI\_MEMORY\_RUNTIME** bit set must be aligned on a 4 KiB boundary and must be a multiple of 4 KiB in size.
- An ACPI Memory Op-region must inherit cacheability attributes from the UEFI memory map. If the system memory map does not contain cacheability attributes, the ACPI Memory Op-region must inherit its cacheability attributes from the ACPI name space. If no cacheability attributes exist in the system memory map or the ACPI name space, then the region must be assumed to be non-cacheable.
- ACPI tables loaded at runtime must be contained in memory of type **EfiACPIMemoryNVS**. The cacheability attributes for ACPI tables loaded at runtime should be defined in the UEFI memory map. If no information about the table location exists in the UEFI memory map, cacheability attributes may be obtained from ACPI memory descriptors. If no information about the table location exists in the UEFI memory map or ACPI memory descriptors, the table is assumed to be non-cached.
- In general, UEFI Configuration Tables loaded at boot time (e.g., SMBIOS table) can be contained in memory of type **EfiRuntimeServicesData** (recommended and the system firmware must not request a virtual mapping), **EfiBootServicesData**, **EfiACPIReclaimMemory** or **EfiACPIMemoryNVS**. Tables loaded at runtime must be contained in memory of type **EfiRuntimeServicesData** (recommended) or **EfiACPIMemoryNVS**.

**Note:** *Previous EFI specifications allowed ACPI tables loaded at runtime to be in the **EfiReservedMemoryType** and there was no guidance provided for other EFI Configuration Tables. **EfiReservedMemoryType** is not intended to be used for the storage of any EFI Configuration Tables. Also, only OSes conforming to the UEFI Specification are guaranteed to handle SMBIOS table in memory of type **EfiBootServicesData**.*

### 2.3.2.1 Handoff State

When a 32-bit UEFI OS is loaded, the system firmware hands off control to the OS in flat 32-bit mode. All descriptors are set to their 4GiB limits so that all of memory is accessible from all segments.

[Figure 3](#) shows the stack after *AddressOfEntryPoint* in the image's PE32+ header has been called on supported 32-bit systems. All UEFI image entry points take two parameters. These are the image handle of the UEFI image, and a pointer to the EFI System Table.

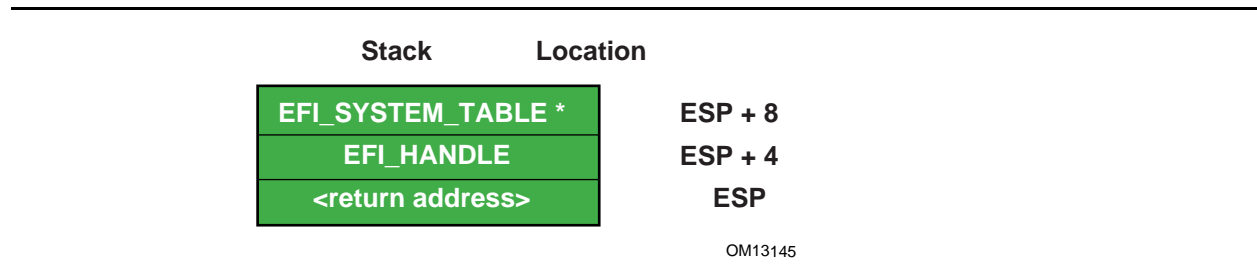

Figure 3. Stack after **AddressOfEntryPoint** Called, IA- 32

### 2.3.2.2 Calling Convention

All functions are called with the C language calling convention. The general-purpose registers that are volatile across function calls are **eax**, **ecx**, and **edx**. All other general-purpose registers are nonvolatile and are preserved by the target function.

In addition, unless otherwise specified by the function definition, all other CPU registers (including MMX and XMM) are preserved.

The floating point status register is not preserved by the target function. The floating point control register and MMX control register are saved by the target function.

If the return value is a float or a double, the value is returned in ST(0).

### 2.3.3 Intel® Itanium® -Based Platforms

UEFI executes as an extension to the SAL execution environment with the same rules as laid out by the SAL specification.

During boot services time the processor is in the following execution mode:

- Uniprocessor, as detailed in chapter 13.1.2 of:
  - *Intel Itanium Architecture Software Developer's Manual*
  - Volume 2: System Architecture
  - Revision 2.2
  - January 2006
  - See "Links to UEFI-Related Documents" (<http://uefi.org/uefi>) under the heading "Intel Itanium Documentation".
  - Document Number: 245318-005
- Physical mode
- 128 KiB, or more, of available stack space
- 16 KiB, or more, of available backing store space
  - FPSR.traps:Set to all 1's (all exceptions disabled)
  - FPSR.sf0:
    - .pc:Precision Control - 11b (extended precision)
    - .rc:Rounding Control - 0 (round to nearest)
    - .wre:Widest Range Exponent - 0 (IEEE mode)
    - .ftz:Flush-To-Zero mode - 0 (off)



- FPSR.sf1:
  - .td:Traps Disable = 1 (traps disabled)
  - .pc:Precision Control - 11b (extended precision)
  - .rc:Rounding Control - 0 (round to nearest)
  - wreWidest Range Exponent - 1 (full register exponent range)
  - ftzFlush-To-Zero mode - 0 (off)
- FPSR.sf2,3:
  - .tdTraps Disable = 1 (traps disabled)
  - pc:Precision Control - 11b (extended precision)
  - .rc:Rounding Control - 0 (round to nearest)
  - .wre:Widest Range Exponent - 0 (IEEE mode)
  - .ftz:Flush-To-Zero mode - 0 (off)

An application written to this specification may alter the processor execution mode, but the UEFI image must ensure firmware boot services and runtime services are executed with the prescribed execution environment.

After an Operating System calls `ExitBootServices()`, firmware boot services are no longer available and it is illegal to call any boot service. After `ExitBootServices`, firmware runtime services are still available. When calling runtime services, paging may or may not be enabled, however if paging is enabled and `SetVirtualAddressMap()` has not been called, any memory space defined by the UEFI memory map is identity mapped (virtual address equals physical address). The mappings to other regions are undefined and may vary from implementation to implementation. See description of [SetVirtualAddressMap\(\)](#) for details of memory map after this function has been called. After `ExitBootServices()`, runtime service functions may be called with interrupts disabled or enabled at the discretion of the caller.

- ACPI Tables loaded at boot time can be contained in memory of type **EfiACPIReclaimMemory** (recommended) or **EfiACPIMemoryNVS**. ACPI FACS must be contained in memory of type **EfiACPIMemoryNVS**.
- The system firmware must not request a virtual mapping for any memory descriptor of type **EfiACPIReclaimMemory** or **EfiACPIMemoryNVS**.
- EFI memory descriptors of type **EfiACPIReclaimMemory** and **EfiACPIMemoryNVS** must be aligned on an 8 KiB boundary and must be a multiple of 8 KiB in size.
- Any UEFI memory descriptor that requests a virtual mapping via the **EFI\_MEMORY\_DESCRIPTOR** having the **EFI\_MEMORY\_RUNTIME** bit set must be aligned on an 8 KiB boundary and must be a multiple of 8 KiB in size.
- An ACPI Memory Op-region must inherit cacheability attributes from the UEFI memory map. If the system memory map does not contain cacheability attributes the ACPI Memory Op-region must inherit its cacheability attributes from the ACPI name space. If no cacheability attributes exist in the system memory map or the ACPI name space, then the region must be assumed to be non-cacheable.
- ACPI tables loaded at runtime must be contained in memory of type **EfiACPIMemoryNVS**. The cacheability attributes for ACPI tables loaded at runtime

should be defined in the UEFI memory map. If no information about the table location exists in the UEFI memory map, cacheability attributes may be obtained from ACPI memory descriptors. If no information about the table location exists in the UEFI memory map or ACPI memory descriptors, the table is assumed to be non-cached.

- In general, Configuration Tables loaded at boot time (e.g., SMBIOS table) can be contained in memory of type **EfiRuntimeServicesData** (recommended and the system firmware must not request a virtual mapping), **EfiBootServicesData**, **EfiACPIReclaimMemory** or **EfiACPIMemoryNVS**. Tables loaded at runtime must be contained in memory of type **EfiRuntimeServicesData** (recommended) or **EfiACPIMemoryNVS**.

**Note:** Previous EFI specifications allowed ACPI tables loaded at runtime to be in the **EfiReservedMemoryType** and there was no guidance provided for other EFI Configuration Tables. **EfiReservedMemoryType** is not intended to be used by firmware. Also, only OSes conforming to the UEFI Specification are guaranteed to handle SMBIOS table in memory of type **EfiBootServicesData**.

Refer to the *IA-64 System Abstraction Layer Specification* (see [Appendix Q](#)) for details.

UEFI procedures are invoked using the P64 C calling conventions defined for Intel<sup>®</sup> Itanium<sup>®</sup>-based applications. Refer to the document *64 Bit Runtime Architecture and Software Conventions for IA-64* (see [Appendix Q](#)) for more information.

### 2.3.3.1 Handoff State

UEFI uses the standard P64 C calling conventions that are defined for Itanium-based operating systems. [Figure 4](#) shows the stack after **ImageEntryPoint** has been called on Itanium-based systems. The arguments are also stored in registers: **out0** contains **EFI\_HANDLE** and **out1** contains the address of the **EFI\_SYSTEM\_TABLE**. The **gp** for the UEFI Image will have been loaded from the *pLabel* pointed to by the *AddressOfEntryPoint* in the image's PE32+ header. All UEFI image entry points take two parameters. These are the image handle of the image, and a pointer to the System Table.

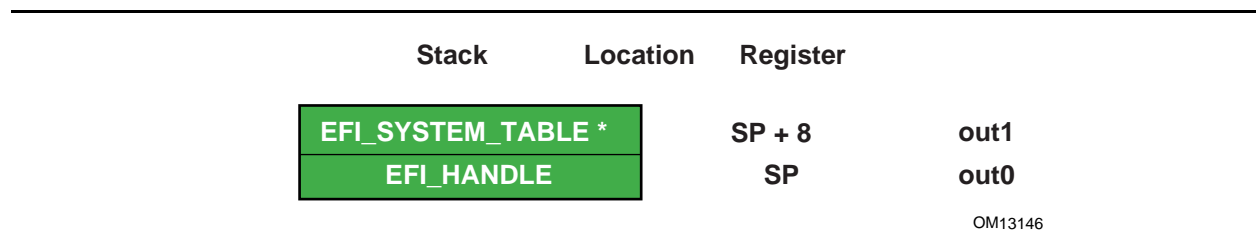

Figure 4. Stack after **AddressOfEntryPoint** Called, Itanium-based Systems

The SAL specification (see [Appendix Q](#)) defines the state of the system registers at boot handoff. The SAL specification also defines which system registers can only be used after UEFI boot services have been properly terminated.

### 2.3.3.2 Calling Convention

UEFI executes as an extension to the SAL execution environment with the same rules as laid out by

the SAL specification. UEFI procedures are invoked using the P64 C calling conventions defined for Intel® Itanium®-based applications. Refer to the document 64 Bit Runtime Architecture and Software Conventions for IA-64 (see [Glossary](#) for more information).

For floating point, functions may only use the lower 32 floating point registers. Return values appear in f8-f15 registers. Single, double, and extended values are all returned using the appropriate format. Registers f6-f7 are local registers and are not preserved for the caller. All other floating point registers are preserved. Note that, when compiling UEFI programs, a special switch will likely need to be specified to guarantee that the compiler does not use f32-f127, which are not normally preserved in the regular calling convention for Itanium. A procedure using one of the preserved floating point registers must save and restore the caller's original contents without generating a NaT consumption fault.

Floating point arguments are passed in f8-f15 registers when possible. Parameters beyond the registers appear in memory, as explained in Section 8.5 of the Itanium Software Conventions and Runtime Architecture Guide. Within the called function, these are local registers and are not preserved for the caller. Registers f6-f7 are local registers and are not preserved for the caller. All other floating point registers are preserved. Note that, when compiling UEFI programs, a special switch will likely need to be specified to guarantee that the compiler does not use f32-f127, which are not normally preserved in the regular calling convention for Itanium. A procedure using one of the preserved floating point registers must save and restore the caller's original contents without generating a NaT consumption fault.

The floating point status register must be preserved across calls to a target function. Flags fields in SF1,2,3 are not preserved for the caller. Flags fields in SF0 upon return will reflect the value passed in, and with bits set to 1 corresponding to any IEEE exceptions detected on non-speculative floating-point operations executed as part of the callee.

Floating-point operations executed by the callee may require software emulation. The caller must be prepared to handle FP Software Assist (FPSWA) interruptions. Callees should not raise IEEE traps by changing FPSR.traps bits to 0 and then executing floating-point operations that raise such traps.

### 2.3.4 x64 Platforms

All functions are called with the C language calling convention. See [Section 2.3.4.2](#) for more detail.

During boot services time the processor is in the following execution mode:

- Uniprocessor, as described in chapter 8.4 of:
  - *Intel 64 and IA-32 Architectures Software Developer's Manual*, Volume 3, System Programming Guide, Part 1, Order Number: 253668-033US, December 2009
  - See "Links to UEFI-Related Documents" (<http://uefi.org/uefi>) under the heading "Intel Processor Manuals".

- Long mode, in 64-bit mode
- Paging mode is enabled and any memory space defined by the UEFI memory map is identity mapped (virtual address equals physical address), although the attributes of certain regions may not have all read, write, and execute attributes or be unmarked for purposes of platform protection. The mappings to other regions are undefined and may vary from implementation to implementation.
- Selectors are set to be flat and are otherwise not used.
- Interrupts are enabled—though no interrupt services are supported other than the UEFI boot services timer functions (All loaded device drivers are serviced synchronously by “polling.”)
- Direction flag in EFLAGS is clear
- Other general purpose flag registers are undefined
- 128 KiB, or more, of available stack space
- The stack must be 16-byte aligned. Stack may be marked as non-executable in identity mapped page tables.
- Floating-point control word must be initialized to 0x037F (all exceptions masked, double-extended-precision, round-to-nearest)
- Multimedia-extensions control word (if supported) must be initialized to 0x1F80 (all exceptions masked, round-to-nearest, flush to zero for masked underflow).
- CR0.EM must be zero
- CR0.TS must be zero

For an operating system to use any UEFI runtime services, it must:

- Preserve all memory in the memory map marked as runtime code and runtime data
- Call the runtime service functions, with the following conditions:
  - In long mode, in 64-bit mode
  - Paging enabled
  - All selectors set to be flat with virtual = physical address. If the UEFI OS loader or OS used **SetVirtualAddressMap()** to relocate the runtime services in a virtual address space, then this condition does not have to be met. See description of [SetVirtualAddressMap\(\)](#) for details of memory map after this function has been called.
  - Direction flag in EFLAGS clear
  - 4 KiB, or more, of available stack space
  - The stack must be 16-byte aligned
  - Floating-point control word must be initialized to 0x037F (all exceptions masked, double-extended-precision, round-to-nearest)
  - Multimedia-extensions control word (if supported) must be initialized to 0x1F80 (all exceptions masked, round-to-nearest, flush to zero for masked underflow)
  - CR0.EM must be zero

- CRO.TS must be zero
- Interrupts may be disabled or enabled at the discretion of the caller.
- ACPI Tables loaded at boot time can be contained in memory of type **EfiACPIReclaimMemory** (recommended) or **EfiACPIMemoryNVS**. ACPI FACS must be contained in memory of type **EfiACPIMemoryNVS**.
- The system firmware must not request a virtual mapping for any memory descriptor of type **EfiACPIReclaimMemory** or **EfiACPIMemoryNVS**.
- EFI memory descriptors of type **EfiACPIReclaimMemory** and **EfiACPIMemoryNVS** must be aligned on a 4 KiB boundary and must be a multiple of 4 KiB in size.
- Any UEFI memory descriptor that requests a virtual mapping via the **EFI\_MEMORY\_DESCRIPTOR** having the **EFI\_MEMORY\_RUNTIME** bit set must be aligned on a 4 KiB boundary and must be a multiple of 4 KiB in size.
- An ACPI Memory Op-region must inherit cacheability attributes from the UEFI memory map. If the system memory map does not contain cacheability attributes, the ACPI Memory Op-region must inherit its cacheability attributes from the ACPI name space. If no cacheability attributes exist in the system memory map or the ACPI name space, then the region must be assumed to be non-cacheable.
- ACPI tables loaded at runtime must be contained in memory of type **EfiACPIMemoryNVS**. The cacheability attributes for ACPI tables loaded at runtime should be defined in the UEFI memory map. If no information about the table location exists in the UEFI memory map, cacheability attributes may be obtained from ACPI memory descriptors. If no information about the table location exists in the UEFI memory map or ACPI memory descriptors, the table is assumed to be non-cached.
- In general, UEFI Configuration Tables loaded at boot time (e.g., SMBIOS table) can be contained in memory of type **EfiRuntimeServicesData** (recommended and the system firmware must not request a virtual mapping), **EfiBootServicesData**, **EfiACPIReclaimMemory** or **EfiACPIMemoryNVS**. Tables loaded at runtime must be contained in memory of type **EfiRuntimeServicesData** (recommended) or **EfiACPIMemoryNVS**.

**Note:** *Previous EFI specifications allowed ACPI tables loaded at runtime to be in the **EfiReservedMemoryType** and there was no guidance provided for other EFI Configuration Tables. **EfiReservedMemoryType** is not intended to be used by firmware. Also, only OSes conforming to the UEFI Specification are guaranteed to handle SMBIOS table in memory of type **EfiBootServicesData**.*

#### 2.3.4.1 Handoff State

Rcx – EFI\_HANDLE

Rdx – EFI\_SYSTEM\_TABLE \*

RSP - <return address>

#### 2.3.4.2 Detailed Calling Conventions

The caller passes the first four integer arguments in registers. The integer values are passed from left to right in Rcx, Rdx, R8, and R9 registers. The caller passes arguments

five and above onto the stack. All arguments must be right-justified in the register in which they are passed. This ensures the callee can process only the bits in the register that are required.

The caller passes arrays and strings via a pointer to memory allocated by the caller. The caller passes structures and unions of size 8, 16, 32, or 64 bits as if they were integers of the same size. The caller is not allowed to pass structures and unions of other than these sizes and must pass these unions and structures via a pointer.

The callee must dump the register parameters into their shadow space if required. The most common requirement is to take the address of an argument.

If the parameters are passed through `varargs` then essentially the typical parameter passing applies, including spilling the fifth and subsequent arguments onto the stack. The callee must dump the arguments that have their address taken.

Return values that fit into 64-bits are returned in the `Rax` register. If the return value does not fit within 64-bits, then the caller must allocate and pass a pointer for the return value as the first argument, `Rcx`. Subsequent arguments are then shifted one argument to the right, so for example argument one would be passed in `Rdx`. User-defined types to be returned must be 1,2,4,8,16,32, or 64 bits in length.

The registers `Rax`, `Rcx`, `Rdx`, `R8`, `R9`, `R10`, `R11`, and `XMM0-XMM5` are volatile and are, therefore, destroyed on function calls.

The registers `RBX`, `RBP`, `RDI`, `RSI`, `R12`, `R13`, `R14`, `R15`, and `XMM6-XMM15` are considered nonvolatile and must be saved and restored by a function that uses them.

Function pointers are pointers to the label of the respective function and don't require special treatment.

A caller must always call with the stack 16-byte aligned.

For MMX, XMM and floating-point values, return values that can fit into 64-bits are returned through `RAX` (including MMX types). However, XMM 128-bit types, floats, and doubles are returned in `XMM0`. The floating point status register is not saved by the target function. Floating-point and double-precision arguments are passed in `XMM0 - XMM3` (up to 4) with the integer slot (`RCX`, `RDX`, `R8`, and `R9`) that would normally be used for that cardinal slot being ignored (see example) and vice versa. XMM types are never passed by immediate value but rather a pointer will be passed to memory allocated by the caller. MMX types will be passed as if they were integers of the same size. Callees must not unmask exceptions without providing correct exception handlers.

In addition, unless otherwise specified by the function definition, all other CPU registers (including MMX and XMM) are preserved.

### 2.3.4.3 Enabling Paging or Alternate Translations in an Application

Boot Services define an execution environment where paging is not enabled (supported 32-bit) or where translations are enabled but mapped virtual equal physical (x64) and this section will describe how to write an application with alternate translations or with paging enabled. Some Operating Systems require the OS Loader to be able to enable OS required translations at Boot Services time.

If a UEFI application uses its own page tables, GDT or IDT, the application must ensure that the firmware executes with each supplanted data structure. There are two ways that firmware conforming to this specification can execute when the application has paging enabled.

- Explicit firmware call
- Firmware preemption of application via timer event

An application with translations enabled can restore firmware required mapping before each UEFI call. However the possibility of preemption may require the translation enabled application to disable interrupts while alternate translations are enabled. It's legal for the translation enabled application to enable interrupts if the application catches the interrupt and restores the EFI firmware environment prior to calling the UEFI interrupt ISR. After the UEFI ISR context is executed it will return to the translation enabled application context and restore any mappings required by the application.

### 2.3.5 AArch32 Platforms

All functions are called with the C language calling convention specified in [Section 2.3.5.3](#). In addition, the invoking OSs can assume that unaligned access support is enabled if it is present in the processor.

During boot services time the processor is in the following execution mode:

- Unaligned access should be enabled if supported; Alignment faults are enabled otherwise.
- Uniprocessor.
- A privileged mode.
- The MMU is enabled (CP15 c1 System Control Register (SCTLR) SCTLR.M=1) and any RAM defined by the UEFI memory map is identity mapped (virtual address equals physical address). The mappings to other regions are undefined and may vary from implementation to implementation
- The core will be configured as follows (common across all processor architecture revisions):
  - MMU enabled
  - Instruction and Data caches enabled
  - Access flag disabled
  - Translation remap disabled
  - Little endian mode
  - Domain access control mechanism (if supported) will be configured to check access permission bits in the page descriptor
  - Fast Context Switch Extension (FCSE) must be disabled

This will be achieved by:

- Configuring the CP15 c1 System Control Register (SCTLR) as follows: I=1, C=1, B=0, TRE=0, AFE=0, M=1
- Configuring the CP15 c3 Domain Access Control Register (DACR) to 0x33333333.



- Configuring the CP15 c1 System Control Register (SCTLR), A=1 on ARMv4 and ARMv5, A=0, U=1 on ARMv6 and ARMv7.

The state of other system control register bits is not dictated by this specification.

- Implementations of boot services will enable architecturally manageable caches and TLBs i.e., those that can be managed directly using CP15 operations using mechanisms and procedures defined in the ARM Architecture Reference Manual. They should not enable caches requiring platform information to manage or invoke non-architectural cache/TLB lockdown mechanisms
- MMU configuration--Implementations must use only 4k pages and a single translation base register. On devices supporting multiple translation base registers, TTBR0 must be used solely. The binding does not mandate whether page tables are cached or uncached.
  - On processors implementing the ARMv4 through ARMv6K architecture definitions, the core is additionally configured to disable extended page tables support, if present.  
This will be achieved by configuring the CP15 c1 System Control Register (SCTLR) as follows: XP=0
  - On processors implementing the ARMv7 and later architecture definitions, the core will be configured to enable the extended page table format and disable the TEX remap mechanism.  
This will be achieved by configuring the CP15 c1 System Control Register (SCTLR) as follows: XP=1, TRE=0
- Interrupts are enabled--though no interrupt services are supported other than the UEFI boot services timer functions (All loaded device drivers are serviced synchronously by "polling.")
- 128 KiB or more of available stack space

For an operating system to use any runtime services, it must:

- Preserve all memory in the memory map marked as runtime code and runtime data
- Call the runtime service functions, with the following conditions:
  - In a privileged mode.
  - The system address regions described by all the entries in the EFI memory map that have the **EFI\_MEMORY\_RUNTIME** bit set must be identity mapped as they were for the EFI boot environment. If the OS Loader or OS used SetVirtualAddressMap() to relocate the runtime services in a virtual address space, then this condition does not have to be met. See description of SetVirtualAddressMap() for details of memory map after this function has been called.
  - The processor must be in a mode in which it has access to the system address regions specified in the EFI memory map with the **EFI\_MEMORY\_RUNTIME** bit set.
  - 4 KiB, or more, of available stack space
  - Interrupts may be disabled or enabled at the discretion of the caller



An application written to this specification may alter the processor execution mode, but the invoking OS must ensure firmware boot services and runtime services are executed with the prescribed execution environment.

If ACPI is supported :

- ACPI Tables loaded at boot time can be contained in memory of type **EfiACPIReclaimMemory** (recommended) or **EfiACPIMemoryNVS**. ACPI FACS must be contained in memory of type **EfiACPIMemoryNVS**
- The system firmware must not request a virtual mapping for any memory descriptor of type **EfiACPIReclaimMemory** or **EfiACPIMemoryNVS**.
- EFI memory descriptors of type **EfiACPIReclaimMemory** and **EfiACPIMemoryNVS** must be aligned on a 4 KiB boundary and must be a multiple of 4 KiB in size.
- Any UEFI memory descriptor that requests a virtual mapping via the **EFI\_MEMORY\_DESCRIPTOR** having the **EFI\_MEMORY\_RUNTIME** bit set must be aligned on a 4 KiB boundary and must be a multiple of 4 KiB in size.
- An ACPI Memory Op-region must inherit cacheability attributes from the UEFI memory map. If the system memory map does not contain cacheability attributes, the ACPI Memory Op-region must inherit its cacheability attributes from the ACPI name space. If no cacheability attributes exist in the system memory map or the ACPI name space, then the region must be assumed to be non-cacheable.
- ACPI tables loaded at runtime must be contained in memory of type **EfiACPIMemoryNVS**. The cacheability attributes for ACPI tables loaded at runtime should be defined in the UEFI memory map. If no information about the table location exists in the UEFI memory map, cacheability attributes may be obtained from ACPI memory descriptors. If no information about the table location exists in the UEFI memory map or ACPI memory descriptors, the table is assumed to be non-cached.
- In general, UEFI Configuration Tables loaded at boot time (e.g., SMBIOS table) can be contained in memory of type **EfiRuntimeServicesData** (recommended and the system firmware must not request a virtual mapping), **EfiBootServicesData**, **EfiACPIReclaimMemory** or **EfiACPIMemoryNVS**. Tables loaded at runtime must be contained in memory of type **EfiRuntimeServicesData** (recommended) or **EfiACPIMemoryNVS**.

**Note:** Previous EFI specifications allowed ACPI tables loaded at runtime to be in the **EfiReservedMemoryType** and there was no guidance provided for other EFI Configuration Tables. **EfiReservedMemoryType** is not intended to be used by firmware. Also, only OSes conforming to the UEFI Specification are guaranteed to handle SMBIOS table in memory of type **EfiBootServicesData**.

### 2.3.5.1 Handoff State

R0 – EFI\_HANDLE

R1 – EFI\_SYSTEM\_TABLE \*

R14 – Return Address

### 2.3.5.2 Enabling Paging or Alternate Translations in an Application

Boot Services define a specific execution environment. This section will describe how to write an application that creates an alternative execution environment. Some Operating Systems require the OS Loader to be able to enable OS required translations at Boot Services time, and make other changes to the UEFI defined execution environment.

If a UEFI application uses its own page tables, or other processor state, the application must ensure that the firmware executes with each supplanted functionality. There are two ways that firmware conforming to this specification can execute in this alternate execution environment:

- Explicit firmware call
- Firmware preemption of application via timer event

An application with an alternate execution environment can restore the firmware environment before each UEFI call. However the possibility of preemption may require the alternate execution-enabled application to disable interrupts while the alternate execution environment is active. It's legal for the alternate execution environment enabled application to enable interrupts if the application catches the interrupt and restores the EFI firmware environment prior to calling the UEFI interrupt ISR. After the UEFI ISR context is executed it will return to the alternate execution environment enabled application context.

An alternate execution environment created by a UEFI application must not change the semantics or behavior of the MMU configuration created by the UEFI firmware prior to invoking **ExitBootServices()**, including the bit layout of the page table entries.

After an OS loader calls **ExitBootServices()** it should immediately configure the exception vector to point to appropriate code.

### 2.3.5.3 Detailed Calling Convention

The base calling convention for the ARM binding is defined here:

*Procedure Call Standard for the ARM Architecture V2.06 (or later)*

See "Links to UEFI-Related Documents" (<http://uefi.org/uefi>) under the heading "Arm Architecture Base Calling Convention".

This binding further constrains the calling convention in these ways:

- Calls to UEFI defined interfaces must be done assuming that the target code requires the ARM instruction set state. Images are free to use other instruction set states except when invoking UEFI interfaces.
- Floating point, SIMD, vector operations and other instruction set extensions must not be used.
- Only little endian operation is supported.
- The stack will maintain 8 byte alignment as described in the AAPCS for public interfaces.
- Use of coprocessor registers for passing call arguments must not be used
- Structures (or other types larger than 64-bits) must be passed by reference and not by value

- The EFI ARM platform binding defines register r9 as an additional callee-saved variable register.

### 2.3.6 AArch64 Platforms

AArch64 UEFI will only execute 64-bit ARM code, as the ARMv8 architecture does not allow for the mixing of 32-bit and 64-bit code at the same privilege level.

All functions are called with the C language calling convention specified in Detailed calling Convention section below. During boot services only a single processor is used for execution. All secondary processors must be either powered off or held in a quiescent state.

The primary processor is in the following execution mode:

- Unaligned access must be enabled.
- Use the highest 64 bit non secure privilege level available; Non-secure EL2 (Hyp) or Non-secure EL1(Kernel).
- The MMU is enabled and any RAM defined by the UEFI memory map is identity mapped (virtual address equals physical address). The mappings to other regions are undefined and may vary from implementation to implementation
- The core will be configured as follows:
  - MMU enabled
  - Instruction and Data caches enabled
  - Little endian mode
  - Stack Alignment Enforced
  - NOT Top Byte Ignored
  - Valid Physical Address Space
  - 4K Translation Granule

This will be achieved by:

1. Configuring the System Control Register SCTLR\_EL2 or SCTLR\_EL1:
  - EE=0, I=1, SA=1, C=1, A=0, M=1
2. Configuring the appropriate Translation Control Register:
  - TCR\_EL2
    - TBI=0
    - PS must contain the valid Physical Address Space Size.
    - TGO=00
  - TCR\_EL1
    - TBI0=0
    - IPS must contain the valid Intermediate Physical Address Space Size.
    - TGO=00

**Note:** *The state of other system control register bits is not dictated by this specification.*

- All floating point traps and exceptions will be disabled at the relevant exception levels (FPCR=0, CPACR\_EL1.FPEN=11, CPTR\_EL2.TFP=0). This implies that the FP unit will be enabled by default.
- Implementations of boot services will enable architecturally manageable caches and TLBs i.e., those that can be managed directly using implementation independent registers using mechanisms and procedures defined in the ARM Architecture Reference Manual. They should not enable caches requiring platform information to manage or invoke non-architectural cache/TLB lockdown mechanisms.
- MMU configuration: Implementations must use only 4k pages and a single translation base register. On devices supporting multiple translation base registers, TTBR0 must be used solely. The binding does not mandate whether page tables are cached or uncached.
- Interrupts are enabled, though no interrupt services are supported other than the UEFI boot services timer functions (All loaded device drivers are serviced synchronously by “polling”). All UEFI interrupts must be routed to the IRQ vector only.
- The architecture generic timer must be initialized and enabled. The Counter Frequency register (CNTFRQ) must be programmed with the timer frequency. Timer access must be provided to non-secure EL1 and EL0 by setting bits EL1PCTEN and EL1PCEN in register CNTHCTL\_EL2.
- 128 KiB or more of available stack space
- The ARM architecture allows mapping pages at a variety of granularities, including 4KiB and 64KiB. If a 64KiB physical page contains any 4KiB page with any of the following types listed below, then all 4KiB pages in the 64KiB page must use identical ARM Memory Page Attributes (as described in [Table 7](#)):
  - EfiRuntimeServicesCode
  - EfiRuntimeServicesData
  - EfiReserved
  - EfiACPIMemoryNVS
 Mixed attribute mappings within a larger page are not allowed.

**Note:** *This constraint allows a 64K paged based Operating System to safely map runtime services memory.*

For an operating system to use any runtime services, Runtime services must:

- Support calls from either the EL1 or the EL2 exception levels.
- Once called, simultaneous or nested calls from EL1 and EL2 are not permitted.

**Note:** *Sequential, non-overlapping, calls from EL1 and EL2 are permitted.*

Runtime services are permitted to make synchronous SMC and HVC calls into higher exception levels.

**Note:** *These rules allow Boot Services to start at EL2, and Runtime services to be assigned to an EL1 Operating System. In this case a call to **SetVirtualAddressMap()** is expected to provided an EL1 appropriate set of mappings.*

For an operating system to use any runtime services, it must:

- Enable unaligned access support.
- Preserve all memory in the memory map marked as runtime code and runtime data
- Call the runtime service functions, with the following conditions:
  - From either EL1 or EL2 exception levels.
  - Consistently call runtime services from the same exception level. Sharing of runtime services between different exception levels is not permitted.
  - Runtime services must only be assigned to a single operating system or hypervisor. They must not be shared between multiple guest operating systems.
  - The system address regions described by all the entries in the EFI memory map that have the **EFI\_MEMORY\_RUNTIME** bit set must be identity mapped as they were for the EFI boot environment. If the OS Loader or OS used **SetVirtualAddressMap()** to relocate the runtime services in a virtual address space, then this condition does not have to be met. See description of **SetVirtualAddressMap()** for details of memory map after this function has been called.
  - The processor must be in a mode in which it has access to the system address regions specified in the EFI memory map with the **EFI\_MEMORY\_RUNTIME** bit set.
  - 8 KiB, or more, of available stack space.
  - The stack must be 16-byte aligned (128-bit).
  - Interrupts may be disabled or enabled at the discretion of the caller

An application written to this specification may alter the processor execution mode, but the invoking OS must ensure firmware boot services and runtime services are executed with the prescribed execution environment.

If ACPI is supported :

- ACPI Tables loaded at boot time can be contained in memory of type **EfiACPIReclaimMemory** (recommended) or **EfiACPIMemoryNVS**.
- ACPI FACS must be contained in memory of type **EfiACPIMemoryNVS**. The system firmware must not request a virtual mapping for any memory descriptor of type **EfiACPIReclaimMemory** or **EfiACPIMemoryNVS**.
- EFI memory descriptors of type **EfiACPIReclaimMemory** and **EfiACPIMemoryNVS** must be aligned on a 4 KiB boundary and must be a multiple of 4 KiB in size.
- Any UEFI memory descriptor that requests a virtual mapping via the **EFI\_MEMORY\_DESCRIPTOR** having the **EFI\_MEMORY\_RUNTIME** bit set must be aligned on a 4 KiB boundary and must be a multiple of 4 KiB in size.
- An ACPI Memory Op-region must inherit cacheability attributes from the UEFI memory map. If the system memory map does not contain cacheability attributes, the ACPI Memory Op-region must inherit its cacheability attributes from the ACPI name

space. If no cacheability attributes exist in the system memory map or the ACPI name space, then the region must be assumed to be non-cacheable.

- ACPI tables loaded at runtime must be contained in memory of type **EfiACPIMemoryNVS**. The cacheability attributes for ACPI tables loaded at runtime should be defined in the UEFI memory map. If no information about the table location exists in the UEFI memory map, cacheability attributes may be obtained from ACPI memory descriptors. If no information about the table location exists in the UEFI memory map or ACPI memory descriptors, the table is assumed to be non-cached.
- In general, UEFI Configuration Tables loaded at boot time (e.g., SMBIOS table) can be contained in memory of type **EfiRuntimeServicesData** (recommended and the system firmware must not request a virtual mapping), **EfiBootServicesdata**, **EfiACPIReclaimMemory** or **EfiACPIMemoryNVS**. Tables loaded at runtime must be contained in memory of type **EfiRuntimeServicesData** (recommended) or **EfiACPIMemoryNVS**.

**Note:** *Previous EFI specifications allowed ACPI tables loaded at runtime to be in the **EfiReservedMemoryType** and there was no guidance provided for other EFI Configuration Tables. **EfiReservedMemoryType** is not intended to be used by firmware. UEFI 2.0 clarified the*

situation moving forward. Also, only OSes conforming to UEFI Specification are guaranteed to handle SMBIOS table in memory of type **EfiBootServiceData**.

### 2.3.6.1 Memory types

Table 7. Map: EFI memory types to AArch64 memory types

EFI Memory Type	ARM Memory Type: MAIR attribute encoding Attr<n> [7:4] [3:0]	ARM Memory Type: Meaning
EFI_MEMORY_UC (Not cacheable)	0000 0000	Device-nGnRnE (Device non-Gathering, non-Reordering, no Early Write Acknowledgement)
EFI_MEMORY_WC (Write combine)	0100 0100	Normal Memory Outer non-cacheable Inner non-cacheable
EFI_MEMORY_WT (Write through)	1011 1011	Normal Memory Outer Write-through non-transient Inner Write-through non-transient
EFI_MEMORY_WB (Write back)	1111 1111	Normal Memory Outer Write-back non-transient Inner Write-back non-transient
EFI_MEMORY_XP, EFI_MEMORY_WP, EFI_MEMORY_RP, EFI_MEMORY_UCE		Not used or defined

### 2.3.6.2 Handoff State

X0 – EFI\_HANDLE

X1 – EFI\_SYSTEM\_TABLE \*

X30 – Return Address

### 2.3.6.3 Enabling Paging or Alternate Translations in an Application

Boot Services define a specific execution environment. This section will describe how to write an application that creates an alternative execution environment. Some Operating Systems require the OS Loader to be able to enable OS required translations at Boot Services time, and make other changes to the UEFI defined execution environment.

If a UEFI application uses its own page tables, or other processor state, the application must ensure that the firmware executes with each supplanted functionality. There are two ways that firmware conforming to this specification can execute in this alternate execution environment:

- Explicit firmware call
- Firmware preemption of application via timer event

An application with an alternate execution environment can restore the firmware environment before each UEFI call. However the possibility of preemption may require the alternate execution-enabled application to disable interrupts while the alternate execution environment is active. It's legal for the alternate execution environment enabled application to enable interrupts if the application catches the interrupt and restores the EFI firmware environment prior to calling the UEFI interrupt ISR. After the UEFI ISR context is executed it will return to the alternate execution environment enabled application context.

An alternate execution environment created by a UEFI application must not change the semantics or behavior of the MMU configuration created by the UEFI firmware prior to invoking **ExitBootServices()**, including the bit layout of the page table entries.

After an OS loader calls **ExitBootServices()** it should immediately configure the exception vector to point to appropriate code.

#### 2.3.6.4 Detailed Calling Convention

The base calling convention for the AArch64 binding is defined in the document *Procedure Call Standard for the ARM 64-bit Architecture Version A-0.06 (or later)*:

See "Links to UEFI-Related Documents" (<http://uefi.org/uefi>) under the heading "ARM 64-bit Base Calling Convention"

This binding further constrains the calling convention in these ways:

- The AArch64 execution state must not be modified by the callee.
- All code exits, normal and exceptional, must be from the A64 instruction set.
- Floating point and SIMD instructions may be used.
- Optional vector operations and other instruction set extensions may only be used:
  - After dynamically checking for their existence.
  - Saving and then later restoring any additional execution state context.
  - Additional feature enablement or control, such as power, must be explicitly managed.
- Only little endian operation is supported.
- The stack will maintain 16 byte alignment.
- Structures (or other types larger than 64-bits) must be passed by reference and not by value.
- The EFI AArch64 platform binding defines the platform register (r18) as "do not use". Avoiding use of r18 in firmware makes the code compatible with both a fixed role for r18 defined by the OS platform ABI and the use of r18 by the OS and its applications as a temporary register.

#### 2.3.7 RISC-V Platforms

All functions are called with the C language calling convention. See 2.3.7.3 for more detail.



On RISC-V platform, four privileged levels are introduced in RISC-V architecture. Beyond the User privilege, Supervisor, Hypervisor and Machine privileges cover all aspects of RISC-V system. The privileged instructions are also defined in each privilege level.

RISC-V UEFI will only execute in machine mode. The machine mode has the highest privilege and this mode is the only mandatory privilege level for RISC-V platform, all other privilege levels are optional. Machine mode is the first mode entered at the power-on reset. This level is used in UEFI for low-level access to a hardware platform.

The processor is in the following execution mode during boot service:

- Total 32 general-purpose registers x1-x31. Register x0 is hardwired to 0. Each register has its ABI (Application Binary Interface) name. See 2.3.7.3 for more detail.
- The width of the processor registers depends on the processor architecture. XLEN is a term which used to refer the current width of register in bits.
  - For the RV32I (Base Integer ISA), XLEN = 32
    - The registers are 32 bits wide to support 32-bit user address space.
  - For the RV64I, XLEN = 64
    - RV64I is built upon RV32 variant. It widens the integer registers and supported user address space to 64-bit.
  - For the RV128I, XLEN = 128
    - A variant of the RISC-V ISA which support flat 128-bit address space and 128-bit registers. RV128I builds upon RV64I in the same way RV64I builds upon RV32I.
- Processor reset vector is platform specified. In UEFI, it is configured to the highest processor addressing space, The value in mtvec (Machine Trap Vector Base Address) register is set to 0xF...FFE00H. The reset vector is at offset 100h of mtvec. The reset vector address is the first instruction which fetched by RISC-V processor when the power-on reset.
- The mstatus.PRV stores the current processor privilege mode. Upon the reset, the privilege mode is set to M (Machine mode).
  - mstatus.PRV = 11b for the machine mode.
- The mstatus.IE indicates the current processor interrupt activation in current mode.
  - mstatus.IE = 1b
- The machine mode interrupt is enabled during boot service in UEFI. Two kinds of interrupts are enabled, one is for timer interrupt and another is software interrupt.
  - mie.MSIE = 1

- mie.MTIE = 1
- The memory is in physical addressing mode. Page is disabled in RISC-V machine mode during UEFI boot service.
- I/O access is through memory map I/O.
- Only support Machine level Control and Status Registers (CSRs) in UEFI.
- Machine ISA (misa) register contains the information regarding to the capabilities of CPU implementation. The Base field encodes the native base integer ISA width.
  - misa.Base = 1 is 32
  - misa.Base = 2 is 64
  - misa.Base = 3 is 128
- RISC-V processor supports extensive customization and specialization instruction sets. RISC-V variations provide various purposes of processor implementations and the processor capability is reported in the extension bits in in misa register. UEFI drivers will need to know the capabilities of processor before executing the specified RISC-V extension instructions. The extensions fields encodes the presence of the standard extensions, with a single bit per letter of the alphabet. (Bit 0 encodes presence of extension "A", Bit 1 encodes presence of extension "B" and so on. Currently the single letter extension mnemonics are as below,
  - A** – Atomic extension
  - B** – Tentatively reserved for Bit operations extension
  - C** - Compressed extension
  - D** - Double-Precision Floating-Point extension
  - E** - Reduced Register Set Indicator RV32E (16 registers)
  - F** - Single-Precision Floating-Point extension
  - G** – Additional standard extensions present
  - H** – Hypervisor mode implemented
  - I** – RV32I/64I/128I base ISA
  - J** – Reserved
  - K** – Reserved
  - L** – Tentatively reserved for Decimal Floating-Point extension
  - M** - Integer Multiplication and Division extension
  - N** – User-level interrupts supported
  - O** – Reserved
  - P** - Tentatively reserved for Packed-SIMD extension
  - Q** - Quad-Precision Floating-Point extension
  - S** – Supervisor mode implemented

- T - Tentatively reserved for Transactional Memory extension
- U - User mode implemented
- V - Tentatively reserved for Vector extension
- W - Reserved
- X - Non-standard extension present
- Y - Reserved
- Z - Reserved

- Machine Vendor ID Register

This is the read-only register encoding the manufacture of the part. Value of 0 indicates this field is not implemented or this is a non-commercial implementation.

- Implementation ID Register

This provides a unique encoding of the source and version of processor implementation.

mimpid.Source is in 16-bit which describe the origin of the processor design,

For example, mimpid.Source = 0x0000 is UC Berkeley Rocket repo.

An application written to this specification may alter the processor execution mode, but the UEFI image must ensure firmware boot services and runtime services are executed with the prescribed execution environment.

After an Operating System calls [ExitBootServices \(\)](#), firmware boot services are no longer available and it is illegal to call any boot service. After [ExitBootServices](#), firmware runtime services are still available and may be called with paging enabled and virtual address pointers if [SetVirtualAddressMap \(\)](#) has been called describing all virtual address ranges used by the firmware runtime service.

If ACPI is supported:

- ACPI Tables loaded at boot time can be contained in memory of type [EfiACPIReclaimMemory](#) (recommended) or [EfiACPIMemoryNVS](#). ACPI FACS must be contained in memory of type [EfiACPIMemoryNVS](#)
- The system firmware must not request a virtual mapping for any memory descriptor of type [EfiACPIReclaimMemory](#) or [EfiACPIMemoryNVS](#).
- EFI memory descriptors of type [EfiACPIReclaimMemory](#) and [EfiACPIMemoryNVS](#) must be aligned on a 4 KiB boundary and must be a multiple of 4 KiB in size.
- Any UEFI memory descriptor that requests a virtual mapping via the

**EFI\_MEMORY\_DESCRIPTOR** having the **EFI\_MEMORY\_RUNTIME** bit set must be aligned on a 4 KiB boundary and must be a multiple of 4 KiB in size.

- An ACPI Memory Op-region must inherit cacheability attributes from the UEFI memory map. If the system memory map does not contain cacheability attributes, the ACPI Memory Op-region must inherit its cacheability attributes from the ACPI name space. If no cacheability attributes exist in the system memory map or the ACPI name space, then the region must be assumed to be non-cacheable.

- ACPI tables loaded at runtime must be contained in memory of type **EfiACPIMemoryNVS**.

The cacheability attributes for ACPI tables loaded at runtime should be defined in the UEFI memory map. If no information about the table location exists in the UEFI memory map, cacheability attributes may be obtained from ACPI memory descriptors. If no information about the table location exists in the UEFI memory map or ACPI memory descriptors, the table is assumed to be non-cached.

In general, UEFI Configuration Tables loaded at boot time (e.g., SMBIOS table) can be contained in memory of type **EfiRuntimeServicesData** (recommended and the system firmware must not request a virtual mapping), **EfiBootServicesData**, **EfiACPIReclaimMemory** or **EfiACPIMemoryNVS**. Tables loaded at runtime must be contained in memory of type **EfiRuntimeServicesData** (recommended) or **EfiACPIMemoryNVS**.

***Note:** Previous EFI specifications allowed ACPI tables loaded at runtime to be in the **EfiReservedMemoryType** and there was no guidance provided for other EFI Configuration Tables. **EfiReservedMemoryType** is not intended to be used by firmware. The UEFI Specification intends to clarify the situation moving forward. Also, only OSes conforming to the UEFI Specification are guaranteed to handle SMBIOS table in memory of type **EfiBootServicesData**.*

### 2.3.7.1 Handoff State

When UEFI firmware handoff control to OS, the RISC-V is operated in machine-mode privilege.

All UEFI image takes two parameters, these are UEFI image handle and the pointer to EFI System Table. According to the RISC-V calling convention, **EFI\_HANDLE** is passed through a0 register and **EFI\_SYSTEM\_TABLE** is passed through a1 register.

x10 –	<b>EFI_HANDLE</b> (ABI name: a0)
x11 –	<b>EFI_SYSTEM_TABLE</b> *(ABI name: a1)

x1 – Return Address (ABI name: ra)

### 2.3.7.2 Data alignment

In the RV32I and RV64I, the datatypes must be aligned at its natural size when stored in memory.

The following table describes the datatype and its alignment in RV32I and RV64I in UEFI.

Datatype	Description	Alignment
BOOLEAN	Logical Boolean	1
INTN	Signed value in native width.	4
UINTN	Unsigned value in native width.	4
INT8	1-byte signed value	1
UINT8	1-byte unsigned value	1
INT16	2-byte signed value	2
UINT16	2-byte unsigned value	2
INT32	4-byte signed value	4
UINT32	4-byte unsigned value	4
INT64	8-byte signed value	8
UINT64	8-byte unsigned value	8
CHAR8	1-byte character	1
CHAR16	2-byte character	2
VOID	Undeclared type	4

**RV32 datatype alignment**

Datatype	Description	Alignment
BOOLEAN	Logical Boolean	1
INTN	Signed value in native width.	8
UINTN	Unsigned value in native width.	8
INT8	1-byte signed value	1
UINT8	1-byte unsigned value	1
INT16	2-byte signed value	2
UINT16	2-byte unsigned value	2
INT32	4-byte signed value	4
UINT32	4-byte unsigned value	4
INT64	8-byte signed value	8
UINT64	8-byte unsigned value	8
CHAR8	1-byte character	1
CHAR16	2-byte character	2
VOID	Undeclared type	8

**RV64 datatype alignment**

### 2.3.7.3 Detailed Calling Convention

The RISC-V calling convention passes arguments in register when necessary. In RISC-V, total 32 general registers are declared, each register has its corresponding ABI name. Below table shows the register name and ABI name.

Register	ABI Name	Description
x0	zero	Hardwired to zero
x1	ra	Return address
x2	sp	Stack pointer
x3	gp	Global pointer
x4	tp	Thread pointer
x5-7	t0-2	Temporaries
x8	s0/fp	Saved register/frame pointer
x9	s1	Saved register
x10-11	a0-1	Function arguments/Return values
x12-17	a2-7	Function arguments
x18-27	s2-11	Saved registers
x28-31	t3-6	Temporaries

In RISC-V calling convention, up to eight integer registers are used for passing argument, a0-a7. a0-a7 are the ABI names and the corresponding registers are x10-x17. Values are returned from functions in integer registers a0 and a1, those are register x10 and x11. In the standard RISC-V calling convention, the stack grows downward and the stack point is always kept 16-byte aligned. Five integer register t0-t6 are temporary registers that are volatile across calls and must be saved by the caller if later used. Twelve integer registers s0-s11 are preserved across calls and must be saved by the callee if used.

## 2.4 Protocols

The protocols that a device handle supports are discovered through the [EFI\\_BOOT\\_SERVICES.HandleProtocol\(\)](#) Boot Service or the [EFI\\_BOOT\\_SERVICES.OpenProtocol\(\)](#) Boot Service. Each protocol has a specification that includes the following:

- The protocol's globally unique ID (GUID)
- The Protocol Interface structure
- The Protocol Services

Unless otherwise specified a protocol's interface structure is not allocated from runtime memory and the protocol member functions should not be called at runtime. If not explicitly specified a protocol member function can be called at a TPL level of less than or equal to **TPL\_NOTIFY** (see [Section 7.1](#)). Unless otherwise specified a protocol's member function is not reentrant or MP safe.

Any status codes defined by the protocol member function definition are required to be implemented, Additional error codes may be returned, but they will not be tested by

standard compliance tests, and any software that uses the procedure cannot depend on any of the extended error codes that an implementation may provide.

To determine if the handle supports any given protocol, the protocol's GUID is passed to **HandleProtocol()** or **OpenProtocol()**. If the device supports the requested protocol, a pointer to the defined Protocol Interface structure is returned. The Protocol Interface structure links the caller to the protocol-specific services to use for this device.

[Figure 5](#) shows the construction of a protocol. The UEFI driver contains functions specific to one or more protocol implementations, and registers them with the Boot Service [EFI\\_BOOT\\_SERVICES.InstallProtocolInterface\(\)](#). The firmware returns the Protocol Interface for the protocol that is then used to invoke the protocol specific services. The UEFI driver keeps private, device-specific context with protocol interfaces.

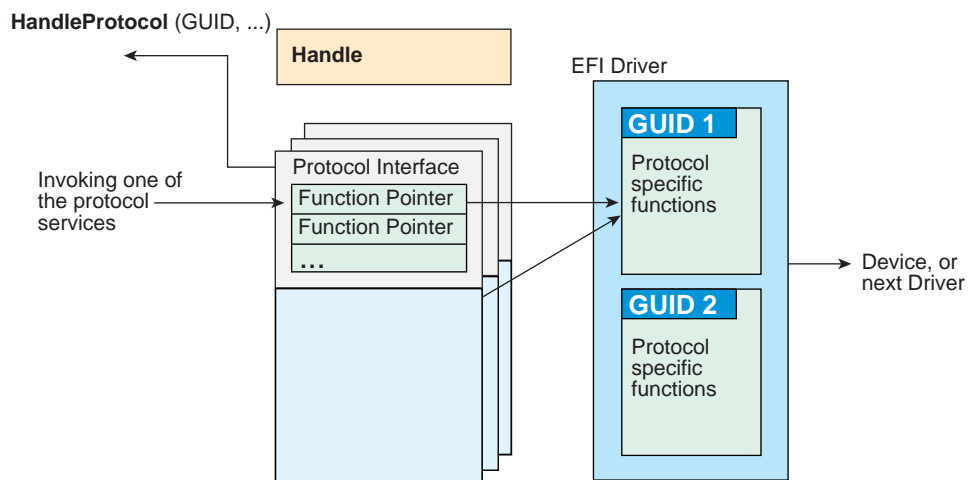

OM13147

**Figure 5. Construction of a Protocol**

The following C code fragment illustrates the use of protocols:

```
// There is a global "EffectsDevice" structure. This
// structure contains information pertinent to the device.

// Connect to the ILLUSTRATION_PROTOCOL on the EffectsDevice,
// by calling HandleProtocol with the device's EFI device handle
// and the ILLUSTRATION_PROTOCOL GUID.

EffectsDevice.Handle = DeviceHandle;
Status = HandleProtocol (
    EffectsDevice.EFIHandle,
    &IllustrationProtocolGuid,
    &EffectsDevice.IllustrationProtocol
);

// Use the EffectsDevice illustration protocol's "MakeEffects"
// service to make flashy and noisy effects.

Status = EffectsDevice.IllustrationProtocol->MakeEffects (
    EffectsDevice.IllustrationProtocol,
    TheFlashyAndNoisyEffect
);
```

[Table 8](#) lists the UEFI protocols defined by this specification.



Table 8. UEFI Protocols

Protocol	Description
<a href="#"><u>EFI_LOADED_IMAGE_PROTOCOL</u></a>	Provides information on the image.
<a href="#"><u>EFI_LOADED_IMAGE_DEVICE_PATH_PROTOCOL</u></a>	Specifies the device path that was used when a PE/COFF image was loaded through the EFI Boot Service LoadImage().
<a href="#"><u>EFI_DEVICE_PATH_PROTOCOL</u></a>	Provides the location of the device.
<a href="#"><u>EFI_DRIVER_BINDING_PROTOCOL</u></a>	Provides services to determine if an UEFI driver supports a given controller, and services to start and stop a given controller.
<a href="#"><u>EFI_DRIVER_FAMILY_OVERRIDE_PROTOCOL</u></a>	Provides a the Driver Family Override mechanism for selecting the best driver for a given controller.
<a href="#"><u>EFI_PLATFORM_DRIVER_OVERRIDE_PROTOCOL</u></a>	Provide a platform specific override mechanism for the selection of the best driver for a given controller.
<a href="#"><u>EFI_BUS_SPECIFIC_DRIVER_OVERRIDE_PROTOCOL</u></a>	Provides a bus specific override mechanism for the selection of the best driver for a given controller.
<a href="#"><u>EFI_DRIVER_DIAGNOSTICS2_PROTOCOL</u></a>	Provides diagnostics services for the controllers that UEFI drivers are managing.
<a href="#"><u>EFI_COMPONENT_NAME2_PROTOCOL</u></a>	Provides human readable names for UEFI Drivers and the controllers that the drivers are managing.
<a href="#"><u>EFI_SIMPLE_TEXT_INPUT_PROTOCOL</u></a>	Protocol interfaces for devices that support simple console style text input.
<a href="#"><u>EFI_SIMPLE_TEXT_OUTPUT_PROTOCOL</u></a>	Protocol interfaces for devices that support console style text displaying.
<a href="#"><u>EFI_SIMPLE_POINTER_PROTOCOL</u></a>	Protocol interfaces for devices such as mice and trackballs.
<a href="#"><u>EFI_SERIAL_IO_PROTOCOL</u></a>	Protocol interfaces for devices that support serial character transfer.
<a href="#"><u>EFI_LOAD_FILE_PROTOCOL</u></a>	Protocol interface for reading a file from an arbitrary device.
<a href="#"><u>EFI_LOAD_FILE2_PROTOCOL</u></a>	Protocol interface for reading a non-boot option file from an arbitrary device
<a href="#"><u>EFI_SIMPLE_FILE_SYSTEM_PROTOCOL</u></a>	Protocol interfaces for opening disk volume containing a UEFI file system.
<a href="#"><u>EFI_FILE_PROTOCOL</u></a>	Provides access to supported file systems.
<a href="#"><u>EFI_DISK_IO_PROTOCOL</u></a>	A protocol interface that layers onto any BLOCK_IO or BLOCK_IO_EX interface.
<a href="#"><u>EFI_BLOCK_IO_PROTOCOL</u></a>	Protocol interfaces for devices that support block I/O style accesses.
<a href="#"><u>EFI_BLOCK_IO2_PROTOCOL</u></a>	Protocol interfaces for devices that support block I/O style accesses. This interface is capable of non-blocking transactions.
<a href="#"><u>EFI_UNICODE_COLLATION_PROTOCOL</u></a>	Protocol interfaces for string comparison operations.

Protocol	Description
<a href="#"><u>EFI_PCI_ROOT_BRIDGE_IO_PROTOCOL</u></a>	Protocol interfaces to abstract memory, I/O, PCI configuration, and DMA accesses to a PCI root bridge controller.
<a href="#"><u>EFI_PCI_IO_PROTOCOL</u></a>	Protocol interfaces to abstract memory, I/O, PCI configuration, and DMA accesses to a PCI controller on a PCI bus.
<a href="#"><u>EFI_USB_IO_PROTOCOL</u></a>	Protocol interfaces to abstract access to a USB controller.
<a href="#"><u>EFI_SIMPLE_NETWORK_PROTOCOL</u></a>	Provides interface for devices that support packet based transfers.
<a href="#"><u>EFI_PXE_BASE_CODE_PROTOCOL</u></a>	Protocol interfaces for devices that support network booting.
<a href="#"><u>EFI_BIS_PROTOCOL</u></a>	Protocol interfaces to validate boot images before they are loaded and invoked.
<a href="#"><u>EFI_DEBUG_SUPPORT_PROTOCOL</u></a>	Protocol interfaces to save and restore processor context and hook processor exceptions.
<a href="#"><u>EFI_DEBUGPORT_PROTOCOL</u></a>	Protocol interface that abstracts a byte stream connection between a debug host and a debug target system.
<a href="#"><u>EFI_DECOMPRESS_PROTOCOL</u></a>	Protocol interfaces to decompress an image that was compressed using the EFI Compression Algorithm.
<a href="#"><u>EFI_EBC_PROTOCOL</u></a>	Protocols interfaces required to support an EFI Byte Code interpreter.
<a href="#"><u>EFI_GRAPHICS_OUTPUT_PROTOCOL</u></a>	Protocol interfaces for devices that support graphical output.
<a href="#"><u>EFI_NVM_EXPRESS_PASS_THRU_PROTOCOL</u></a>	Protocol interfaces that allow NVM Express commands to be issued to an NVM Express controller.
<a href="#"><u>EFI_EXT_SCSI_PASS_THRU_PROTOCOL</u></a>	Protocol interfaces for a SCSI channel that allows SCSI Request Packets to be sent to SCSI devices.
<a href="#"><u>EFI_USB2_HC_PROTOCOL</u></a>	Protocol interfaces to abstract access to a USB Host Controller.
<a href="#"><u>EFI_AUTHENTICATION_INFO_PROTOCOL</u></a>	Provides access for generic authentication information associated with specific device paths
<a href="#"><u>EFI_DEVICE_PATH_UTILITIES_PROTOCOL</u></a>	Aids in creating and manipulating device paths.
<a href="#"><u>EFI_DEVICE_PATH_TO_TEXT_PROTOCOL</u></a>	Converts device nodes and paths to text.
<a href="#"><u>EFI_DEVICE_PATH_FROM_TEXT_PROTOCOL</u></a>	Converts text to device paths and device nodes.
<a href="#"><u>EFI_EDID_DISCOVERED_PROTOCOL</u></a>	Contains the EDID information retrieved from a video output device.
<a href="#"><u>EFI_EDID_ACTIVE_PROTOCOL</u></a>	Contains the EDID information for an active video output device.
<a href="#"><u>EFI_EDID_OVERRIDE_PROTOCOL</u></a>	Produced by the platform to allow the platform to provide EDID information to the producer of the Graphics Output protocol
<a href="#"><u>EFI_ISCSI_INITIATOR_NAME_PROTOCOL</u></a>	Sets and obtains the iSCSI Initiator Name.
<a href="#"><u>EFI_TAPE_IO_PROTOCOL</u></a>	Provides services to control and access a tape drive.

Protocol	Description
<a href="#"><u>EFI MANAGED NETWORK PROTOCOL</u></a>	Used to locate communication devices that are supported by an MNP driver and create and destroy instances of the MNP child protocol driver that can use the underlying communications devices.
<a href="#"><u>EFI ARP SERVICE BINDING PROTOCOL</u></a>	Used to locate communications devices that are supported by an ARP driver and to create and destroy instances of the ARP child protocol driver.
<a href="#"><u>EFI ARP PROTOCOL</u></a>	Used to resolve local network protocol addresses into network hardware addresses.
<a href="#"><u>EFI DHCP4 SERVICE BINDING PROTOCOL</u></a>	Used to locate communication devices that are supported by an EFI DHCPv4 Protocol driver and to create and destroy EFI DHCPv4 Protocol child driver instances that can use the underlying communications devices.
<a href="#"><u>EFI DHCP4 PROTOCOL</u></a>	Used to collect configuration information for the EFI IPv4 Protocol drivers and to provide DHCPv4 server and PXE boot server discovery services.
<a href="#"><u>EFI TCP4 SERVICE BINDING PROTOCOL</u></a>	Used to locate EFI TCPv4Protocol drivers to create and destroy child of the driver to communicate with other host using TCP protocol.
<a href="#"><u>EFI TCP4 PROTOCOL</u></a>	Provides services to send and receive data stream.
<a href="#"><u>EFI IP4 SERVICE BINDING PROTOCOL</u></a>	Used to locate communication devices that are supported by an EFI IPv4 Protocol Driver and to create and destroy instances of the EFI IPv4 Protocol child protocol driver that can use the underlying communication device.
<a href="#"><u>EFI IP4 PROTOCOL</u></a>	Provides basic network IPv4 packet I/O services.
<a href="#"><u>EFI IP4 CONFIG PROTOCOL</u></a>	The EFI IPv4 Config Protocol driver performs platform- and policy-dependent configuration of the EFI IPv4 Protocol driver.
<a href="#"><u>EFI IP4 CONFIG2 PROTOCOL</u></a>	The EFI IPv4 Configuration II Protocol driver performs platform- and policy-dependent configuration of the EFI IPv4 Protocol driver.
<a href="#"><u>EFI UDP4 SERVICE BINDING PROTOCOL</u></a>	Used to locate communication devices that are supported by an EFI UDPv4 Protocol driver and to create and destroy instances of the EFI UDPv4 Protocol child protocol driver that can use the underlying communication device.
<a href="#"><u>EFI UDP4 PROTOCOL</u></a>	Provides simple packet-oriented services to transmit and receive UDP packets.
<a href="#"><u>EFI MTFTP4 SERVICE BINDING PROTOCOL</u></a>	Used to locate communication devices that are supported by an EFI MTFTPv4 Protocol driver and to create and destroy instances of the EFI MTFTPv4 Protocol child protocol driver that can use the underlying communication device.
<a href="#"><u>EFI MTFTP4 PROTOCOL</u></a>	Provides basic services for client-side unicast or multicast TFTP operations.
<a href="#"><u>EFI HASH PROTOCOL</u></a>	Allows creating a hash of an arbitrary message digest using one or more hash algorithms.

Protocol	Description
<a href="#">EFI HASH SERVICE BINDING PROTOCOL</a>	Used to locate hashing services support provided by a driver and create and destroy instances of the EFI Hash Protocol so that a multiple drivers can use the underlying hashing services.
<a href="#">EFI SD MMC PASS THRU PROTOCOL</a>	Protocol interface that allows SD/eMMC commands to be sent to an SD/eMMC controller.

## 2.5 UEFI Driver Model

The UEFI *Driver Model* is intended to simplify the design and implementation of device drivers, and produce small executable image sizes. As a result, some complexity has been moved into bus drivers and in a larger part into common firmware services.

A device driver is required to produce a Driver Binding Protocol on the same image handle on which the driver was loaded. It then waits for the system firmware to connect the driver to a controller. When that occurs, the device driver is responsible for producing a protocol on the controller's device handle that abstracts the I/O operations that the controller supports. A bus driver performs these exact same tasks. In addition, a bus driver is also responsible for discovering any child controllers on the bus, and creating a device handle for each child controller found.

One assumption is that the architecture of a system can be viewed as a set of one or more processors connected to one or more core chipsets. The core chipsets are responsible for producing one or more I/O buses. The *UEFI Driver Model* does not attempt to describe the processors or the core chipsets. Instead, the *UEFI Driver Model* describes the set of I/O buses produced by the core chipsets, and any children of these I/O buses. These children can either be devices or additional I/O buses. This can be viewed as a tree of buses and devices with the core chipsets at the root of that tree.

The leaf nodes in this tree structure are peripherals that perform some type of I/O. This could include keyboards, displays, disks, network, etc. The nonleaf nodes are the buses that move data between devices and buses, or between different bus types. [Figure 6](#) shows a sample desktop system with four buses and six devices.

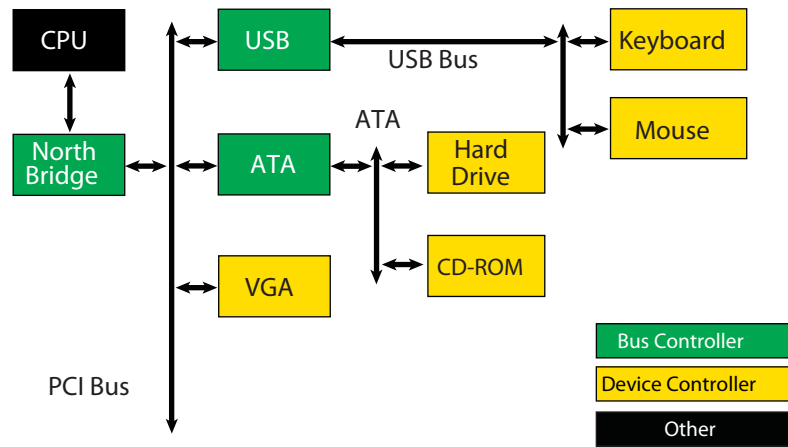

OM13142

Figure 6. Desktop System

Figure 7 is an example of a more complex server system. The idea is to make the UEFI *Driver Model* simple and extensible so more complex systems like the one below can be described and managed in the preboot environment. This system contains six buses and eight devices.

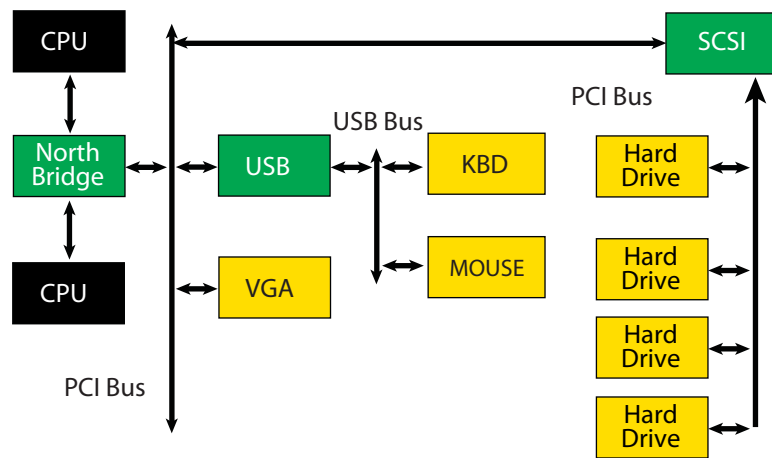

OM13143

Figure 7. Server System

The combination of firmware services, bus drivers, and device drivers in any given platform is likely to be produced by a wide variety of vendors including OEMs, IBVs, and IHVs. These different components from different vendors are required to work together to produce a protocol for an I/O device than can be used to boot a UEFI compliant operating system. As a result, the UEFI *Driver Model* is described in great detail in order to increase the interoperability of these components.

This remainder of this section is a brief overview of the UEFI *Driver Model*. It describes the legacy option ROM issues that the UEFI *Driver Model* is designed to address, the entry point of a driver, host bus controllers, properties of device drivers, properties of bus drivers, and how the UEFI *Driver Model* can accommodate hot-plug events.

## 2.5.1 Legacy Option ROM Issues

Legacy option ROMs have a number of constraints and limitations that restrict innovation on the part of platform designers and adapter vendors. At the time of writing, both ISA and PCI adapters use legacy option ROMs. For the purposes of this discussion, only PCI option ROMs will be considered; legacy ISA option ROMs are not supported as part of the *UEFI Specification*.

The following is a list of the major constraints and limitations of legacy option ROMs. For each issue, the design considerations that went into the design of the UEFI *Driver Model* are also listed. Thus, the design of the UEFI *Driver Model* directly addresses the requirements for a solution to overcome the limitations implicit to PC-AT-style legacy option ROMs.

### 2.5.1.1 32-bit/16-Bit Real Mode Binaries

Legacy option ROMs typically contain 16-bit real mode code for an IA-32 processor. This means that the legacy option ROM on a PCI card cannot be used in platforms that do not support the execution of IA-32 real mode binaries. Also, 16-bit real mode only allows the driver to access directly the lower 1 MiB of system memory. It is possible for the driver to switch the processor into modes other than real mode in order to access resources above 1 MiB, but this requires a lot of additional code, and causes interoperability issues with other option ROMs and the system BIOS. Also, option ROMs that switch the processor into alternate execution modes are not compatible with Itanium Processors.

UEFI *Driver Model* design considerations:

- Drivers need flat memory mode with full access to system components.
- Drivers need to be written in C so they are portable between processor architectures.
- Drivers may be compiled into a virtual machine executable, allowing a single binary driver to work on machines using different processor architectures.

### 2.5.1.2 Fixed Resources for Working with Option ROMs

Since legacy option ROMs can only directly address the lower 1 MiB of system memory, this means that the code from the legacy option ROM must exist below 1 MiB. In a PC-AT platform, memory from 0x00000-0x9FFFF is system memory. Memory from 0xA0000-0xBFFFF is VGA memory, and memory from 0xF0000-0xFFFFF is reserved for the system BIOS. Also, since system BIOS has become more complex over the years, many platforms also use 0xE0000-0xEFFFF for system BIOS. This leaves 128 KiB of memory from 0xC0000-0xDFFFF for legacy option ROMs. This limits how many legacy option ROMs can be run during BIOS POST.

Also, it is not easy for legacy option ROMs to allocate system memory. Their choices are to allocate memory from Extended BIOS Data Area (EBDA), allocate memory through a Post Memory Manager (PMM), or search for free memory based on a heuristic. Of these,

only EBDA is standard, and the others are not used consistently between adapters, or between BIOS vendors, which adds complexity and the potential for conflicts.

UEFI *Driver Model* design considerations:

- Drivers need flat memory mode with full access to system components.
- Drivers need to be capable of being relocated so that they can be loaded anywhere in memory (PE/COFF Images)
- Drivers should allocate memory through the boot services. These are well-specified interfaces, and can be guaranteed to function as expected across a wide variety of platform implementations.

### 2.5.1.3 Matching Option ROMs to their Devices

It is not clear which controller may be managed by a particular legacy option ROM. Some legacy option ROMs search the entire system for controllers to manage. This can be a lengthy process depending on the size and complexity of the platform. Also, due to limitation in BIOS design, all the legacy option ROMs must be executed, and they must scan for all the peripheral devices before an operating system can be booted. This can also be a lengthy process, especially if SCSI buses must be scanned for SCSI devices. This means that legacy option ROMs are making policy decision about how the platform is being initialized, and which controllers are managed by which legacy option ROMs. This makes it very difficult for a system designer to predict how legacy option ROMs will interact with each other. This can also cause issues with on-board controllers, because a legacy option ROM may incorrectly choose to manage the on-board controller.

UEFI *Driver Model* design considerations:

- Driver to controller matching must be deterministic
- Give OEMs more control through Platform Driver Override Protocol and Driver Configuration Protocol
- It must be possible to start only the drivers and controllers required to boot an operating system.

### 2.5.1.4 Ties to PC-AT System Design

Legacy option ROMs assume a PC-AT-like system architecture. Many of them include code that directly touches hardware registers. This can make them incompatible on legacy-free and headless platforms. Legacy option ROMs may also contain setup programs that assume a PC-AT-like system architecture to interact with a keyboard or video display. This makes the setup application incompatible on legacy-free and headless platforms.

UEFI *Driver Model* design considerations:

- Drivers should use well-defined protocols to interact with system hardware, system input devices, and system output devices.

### 2.5.1.5 Ambiguities in Specification and Workarounds Born of Experience

Many legacy option ROMs and BIOS code contain workarounds because of incompatibilities between legacy option ROMs and system BIOS. These incompatibilities

exist in part because there are no clear specifications on how to write a legacy option ROM or write a system BIOS.

Also, interrupt chaining and boot device selection is very complex in legacy option ROMs. It is not always clear which device will be the boot device for the OS.

UEFI *Driver Model* design considerations:

- Drivers and firmware are written to follow this specification. Since both components have a clearly defined specification, compliance tests can be developed to prove that drivers and system firmware are compliant. This should eliminate the need to build workarounds into either drivers or system firmware (other than those that might be required to address specific hardware issues).
- Give OEMs more control through Platform Driver Override Protocol and Driver Configuration Protocol and other OEM value-add components to manage the boot device selection process.

## 2.5.2 Driver Initialization

The file for a driver image must be loaded from some type of media. This could include ROM, FLASH, hard drives, floppy drives, CD-ROM, or even a network connection. Once a driver image has been found, it can be loaded into system memory with the boot service [EFI\\_BOOT\\_SERVICES.LoadImage\(\)](#). `LoadImage()` loads a PE/COFF formatted image into system memory. A handle is created for the driver, and a Loaded Image Protocol instance is placed on that handle. A handle that contains a Loaded Image Protocol instance is called an *Image Handle*. At this point, the driver has not been started. It is just sitting in memory waiting to be started. [Figure 8](#) shows the state of an image handle for a driver after `LoadImage()` has been called.

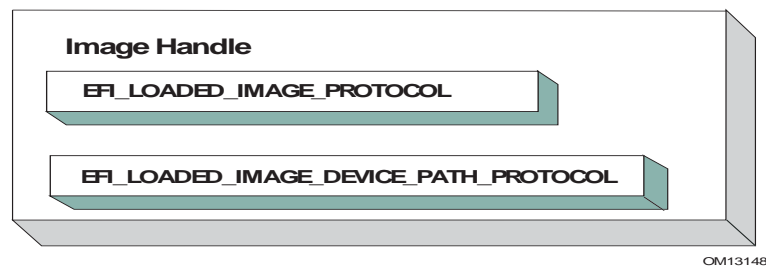

Figure 8. Image Handle

After a driver has been loaded with the boot service `LoadImage()`, it must be started with the boot service [EFI\\_BOOT\\_SERVICES.StartImage\(\)](#). This is true of all types of UEFI Applications and UEFI Drivers that can be loaded and started on an UEFI-compliant system. The entry point for a driver that follows the UEFI *Driver Model* must follow some strict rules. First, it is not allowed to touch any hardware. Instead, the driver is only allowed to install protocol instances onto its own *Image Handle*. A driver that follows the UEFI *Driver Model* is *required* to install an instance of the Driver Binding Protocol onto its own *Image Handle*. It may optionally install the Driver Configuration Protocol, the Driver Diagnostics Protocol, or the Component Name Protocol. In addition, if a driver wishes to



be unloadable it may optionally update the Loaded Image Protocol (see [Section 9](#)) to provide its own `Unload()` function. Finally, if a driver needs to perform any special operations when the boot service `EFI_BOOT_SERVICES.ExitBootServices()` is called, it may optionally create an event with a notification function that is triggered when the boot service `ExitBootServices()` is called. An *Image Handle* that contains a Driver Binding Protocol instance is known as a *Driver Image Handle*. [Figure 9](#) shows a possible configuration for the *Image Handle* from [Figure 8](#) after the boot service `StartImage()` has been called.

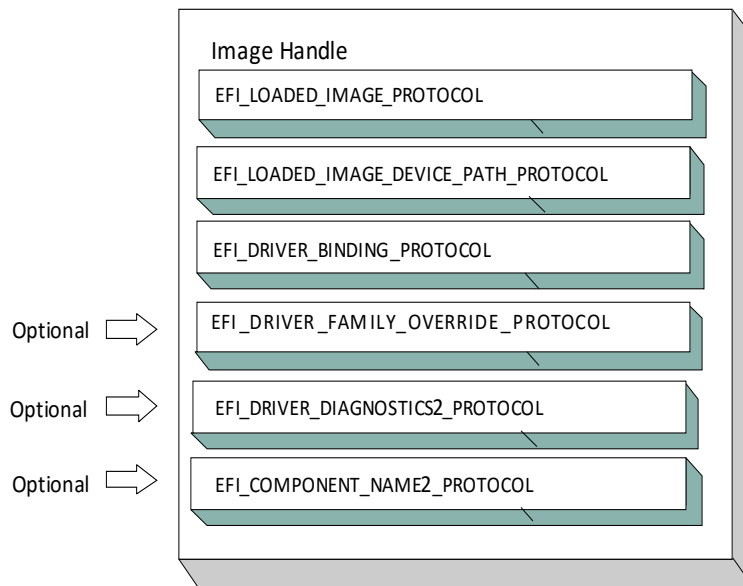
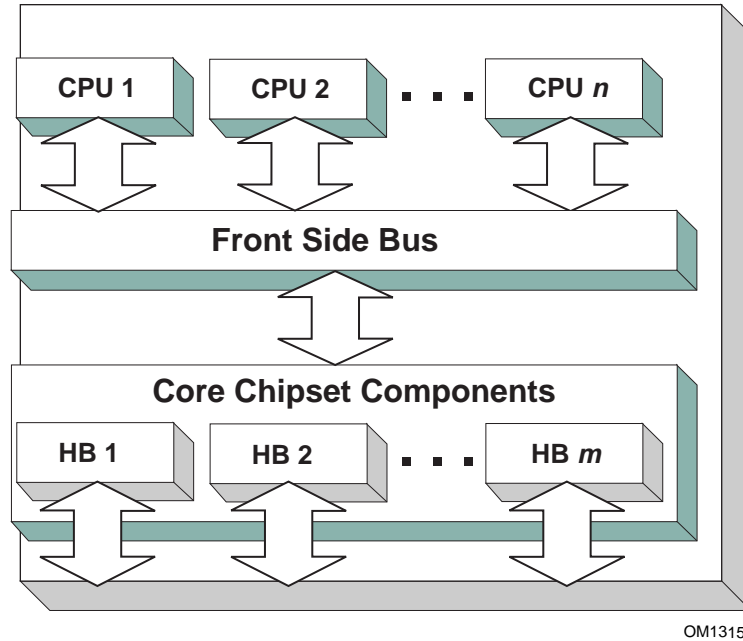

Figure 9. Driver Image Handle

### 2.5.3 Host Bus Controllers

Drivers are not allowed to touch any hardware in the driver's entry point. As a result, drivers will be loaded and started, but they will all be waiting to be told to manage one or more controllers in the system. A platform component, like the Boot Manager, is responsible for managing the connection of drivers to controllers. However, before even the first connection can be made, there has to be some initial collection of controllers for the drivers to manage. This initial collection of controllers is known as the *Host Bus Controllers*. The I/O abstractions that the *Host Bus Controllers* provide are produced by firmware components that are outside the scope of the UEFI *Driver Model*. The device handles for the *Host Bus Controllers* and the I/O abstraction for each one must be produced by the core firmware on the platform, or a driver that may not follow the UEFI *Driver Model*. See the *PCI Root Bridge I/O Protocol Specification* for an example of an I/O abstraction for PCI buses.

A platform can be viewed as a set of processors and a set of core chipset components that may produce one or more host buses. [Figure 10](#) shows a platform with  $n$  processors (CPUs), and a set of core chipset components that produce  $m$  host bridges.



OM13150

Figure 10. Host Bus Controllers

Each host bridge is represented in UEFI as a device handle that contains a Device Path Protocol instance, and a protocol instance that abstracts the I/O operations that the host bus can perform. For example, a PCI Host Bus Controller supports one or more PCI Root Bridges that are abstracted by the PCI Root Bridge I/O Protocol. [Figure 11](#) shows an example device handle for a PCI Root Bridge.

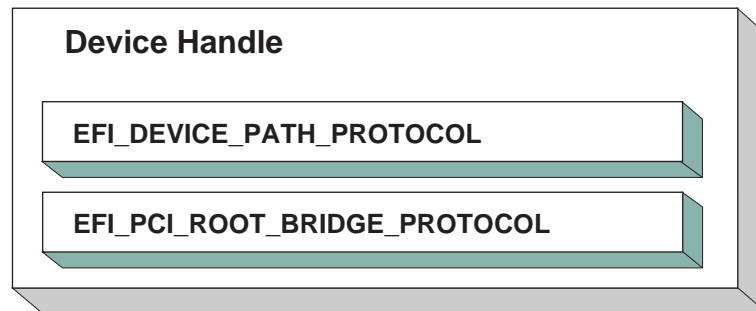

OM13151

Figure 11. PCI Root Bridge Device Handle

A PCI Bus Driver could connect to this PCI Root Bridge, and create child handles for each of the PCI devices in the system. PCI Device Drivers should then be connected to these child handles, and produce I/O abstractions that may be used to boot a UEFI compliant OS. The following section describes the different types of drivers that can be implemented within the UEFI *Driver Model*. The UEFI *Driver Model* is very flexible, so all

the possible types of drivers will not be discussed here. Instead, the major types will be covered that can be used as a starting point for designing and implementing additional driver types.

## 2.5.4 Device Drivers

A device driver is not allowed to create any new device handles. Instead, it installs additional protocol interfaces on an existing device handle. The most common type of device driver will attach an I/O abstraction to a device handle that was created by a bus driver. This I/O abstraction may be used to boot a UEFI compliant OS. Some example I/O abstractions would include Simple Text Output, Simple Input, Block I/O, and Simple Network Protocol. [Figure 12](#) shows a device handle before and after a device driver is connected to it. In this example, the device handle is a child of the XYZ Bus, so it contains an XYZ I/O Protocol for the I/O services that the XYZ bus supports. It also contains a Device Path Protocol that was placed there by the XYZ Bus Driver. The Device Path Protocol is not required for all device handles. It is only required for device handles that represent physical devices in the system. Handles for virtual devices will not contain a Device Path Protocol.

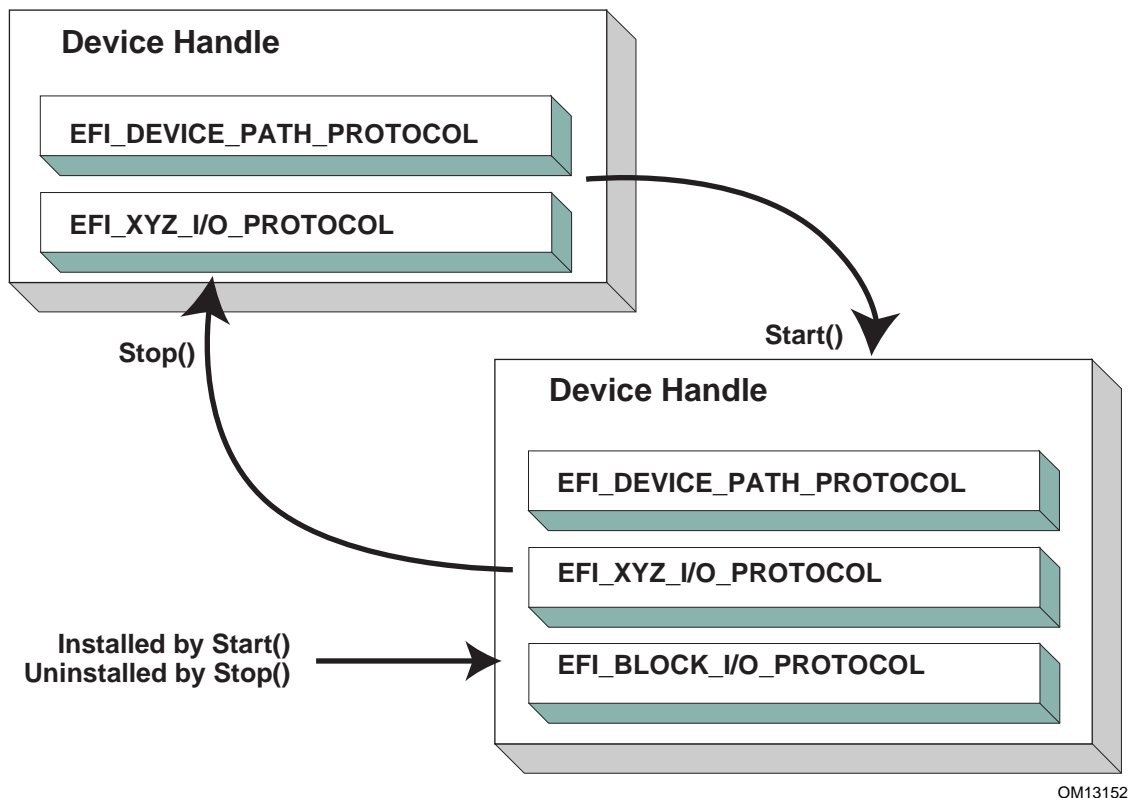

Figure 12. Connecting Device Drivers

The device driver that connects to the device handle in [Figure 12](#) must have installed a Driver Binding Protocol on its own image handle. The Driver Binding Protocol (see

[Section 11.1](#)) contains three functions called [Supported\(\)](#), [Start\(\)](#), and [Stop\(\)](#). The [Supported\(\)](#) function tests to see if the driver supports a given controller. In this example, the driver will check to see if the device handle supports the Device Path Protocol and the XYZ I/O Protocol. If a driver's [Supported\(\)](#) function passes, then the driver can be connected to the controller by calling the driver's [Start\(\)](#) function. The [Start\(\)](#) function is what actually adds the additional I/O protocols to a device handle. In this example, the Block I/O Protocol is being installed. To provide symmetry, the Driver Binding Protocol also has a [Stop\(\)](#) function that forces the driver to stop managing a device handle. This will cause the device driver to uninstall any protocol interfaces that were installed in [Start\(\)](#).

The [Supported\(\)](#), [Start\(\)](#), and [Stop\(\)](#) functions of the EFI Driver Binding Protocol are required to make use of the boot service [EFI\\_BOOT\\_SERVICES.OpenProtocol\(\)](#) to get a protocol interface and the boot service [EFI\\_BOOT\\_SERVICES.CloseProtocol\(\)](#) to release a protocol interface. [OpenProtocol\(\)](#) and [CloseProtocol\(\)](#) update the handle database maintained by the system firmware to track which drivers are consuming protocol interfaces. The information in the handle database can be used to retrieve information about both drivers and controllers. The new boot service [EFI\\_BOOT\\_SERVICES.OpenProtocolInformation\(\)](#) can be used to get the list of components that are currently consuming a specific protocol interface.

## 2.5.5 Bus Drivers

Bus drivers and device drivers are virtually identical from the UEFI *Driver Model's* point of view. The only difference is that a bus driver creates new device handles for the child controllers that the bus driver discovers on its bus. As a result, bus drivers are slightly more complex than device drivers, but this in turn simplifies the design and implementation of device drivers. There are two major types of bus drivers. The first creates handles for all child controllers on the first call to [Start\(\)](#). The other type allows the handles for the child controllers to be created across multiple calls to [Start\(\)](#). This second type of bus driver is very useful in supporting a rapid boot capability. It allows a few child handles or even one child handle to be created. On buses that take a long time to enumerate all of their children (e.g. SCSI), this can lead to a very large timesaving in booting a platform. [Figure 13](#) shows the tree structure of a bus controller before and after [Start\(\)](#) is called. The dashed line coming into the bus controller node represents a link to the bus controller's parent controller. If the bus controller is a *Host Bus Controller*, then it will not have a parent controller. Nodes A, B, C, D, and E represent the child controllers of the bus controller.

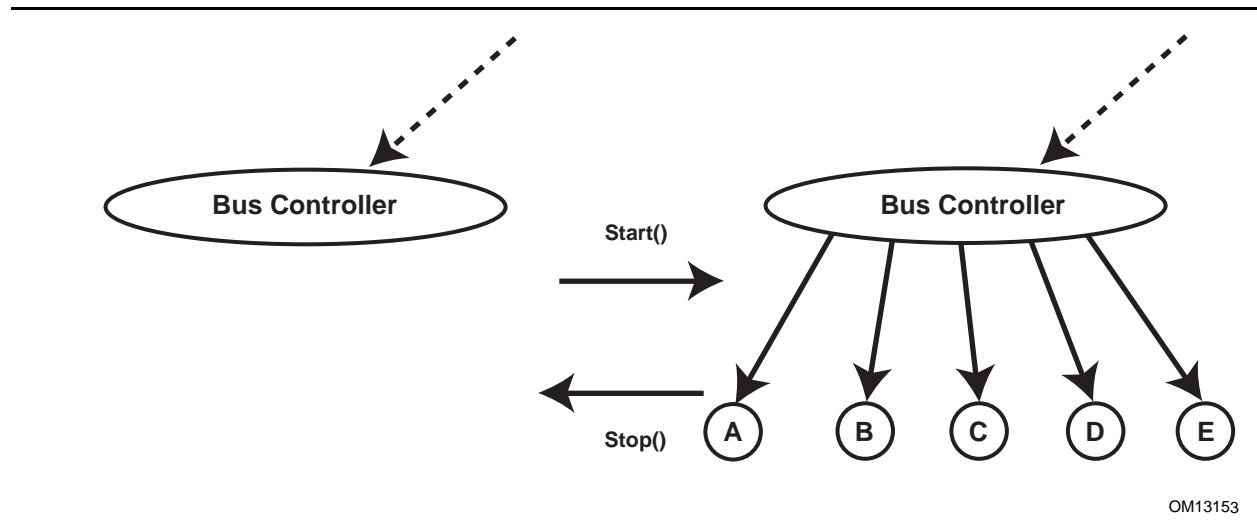

OM13153

Figure 13. Connecting Bus Drivers

A bus driver that supports creating one child on each call to **Start()** might choose to create child C first, and then child E, and then the remaining children A, B, and D. The **Supported()**, **Start()**, and **Stop()** functions of the Driver Binding Protocol are flexible enough to allow this type of behavior.

A bus driver must install protocol interfaces onto every child handle that it creates. At a minimum, it must install a protocol interface that provides an I/O abstraction of the bus's services to the child controllers. If the bus driver creates a child handle that represents a physical device, then the bus driver must also install a Device Path Protocol instance onto the child handle. A bus driver may optionally install a Bus Specific Driver Override Protocol onto each child handle. This protocol is used when drivers are connected to the child controllers. The boot service [EFI\\_BOOT\\_SERVICES.ConnectController\(\)](#) uses architecturally defined precedence rules to choose the best set of drivers for a given controller. The Bus Specific Driver Override Protocol has higher precedence than a general driver search algorithm, and lower precedence than platform overrides. An example of a bus specific driver selection occurs with PCI. A PCI Bus Driver gives a driver stored in a PCI controller's option ROM a higher precedence than drivers stored elsewhere in the platform. [Figure 14](#) shows an example child device handle that was created by the XYZ Bus Driver that supports a bus specific driver override mechanism.

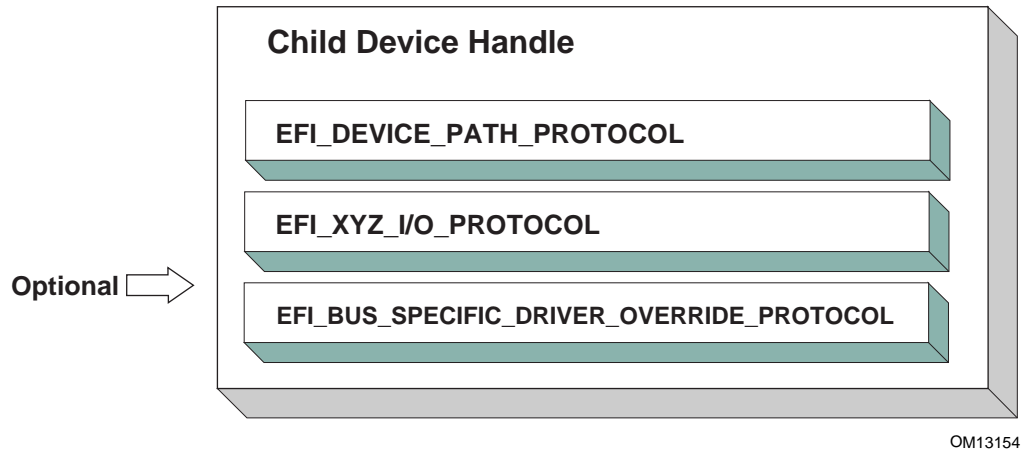

Figure 14. Child Device Handle with a Bus Specific Override

## 2.5.6 Platform Components

Under the *UEFI Driver Model*, the act of connecting and disconnecting drivers from controllers in a platform is under the platform firmware's control. This will typically be implemented as part of the UEFI Boot Manager, but other implementations are possible. The boot services [EFI\\_BOOT\\_SERVICES.ConnectController\(\)](#) and [EFI\\_BOOT\\_SERVICES.DisconnectController\(\)](#) can be used by the platform firmware to determine which controllers get started and which ones do not. If the platform wishes to perform system diagnostics or install an operating system, then it may choose to connect drivers to all possible boot devices. If a platform wishes to boot a preinstalled operating system, it may choose to only connect drivers to the devices that are required to boot the selected operating system. The *UEFI Driver Model* supports both these modes of operation through the boot services [ConnectController\(\)](#) and [DisconnectController\(\)](#). In addition, since the platform component that is in charge of booting the platform has to work with device paths for console devices and boot options, all of the services and protocols involved in the *UEFI Driver Model* are optimized with device paths in mind.

Since the platform firmware may choose to only connect the devices required to produce consoles and gain access to a boot device, the OS present device drivers cannot assume that a UEFI driver for a device has been executed. The presence of a UEFI driver in the system firmware or in an option ROM does not guarantee that the UEFI driver will be loaded, executed, or allowed to manage any devices in a platform. All OS present device drivers must be able to handle devices that have been managed by a UEFI driver and devices that have not been managed by a UEFI driver.

The platform may also choose to produce a protocol named the Platform Driver Override Protocol. This is similar to the Bus Specific Driver Override Protocol, but it has higher priority. This gives the platform firmware the highest priority when deciding which drivers are connected to which controllers. The Platform Driver Override Protocol is attached to a handle in the system. The boot service [ConnectController\(\)](#) will make use of this protocol if it is present in the system.

## 2.5.7 Hot-Plug Events

In the past, system firmware has not had to deal with hot-plug events in the preboot environment. However, with the advent of buses like USB, where the end user can add and remove devices at any time, it is important to make sure that it is possible to describe these types of buses in the *UEFI Driver Model*. It is up to the bus driver of a bus that supports the hot adding and removing of devices to provide support for such events. For these types of buses, some of the platform management is going to have to move into the bus drivers. For example, when a keyboard is hot added to a USB bus on a platform, the end user would expect the keyboard to be active. A USB Bus driver could detect the hot-add event and create a child handle for the keyboard device. However, because drivers are not connected to controllers unless [EFI\\_BOOT\\_SERVICES.ConnectController\(\)](#) is called, the keyboard would not become an active input device. Making the keyboard driver active requires the USB Bus driver to call [ConnectController\(\)](#) when a hot-add event occurs. In addition, the USB Bus Driver would have to call [EFI\\_BOOT\\_SERVICES.DisconnectController\(\)](#) when a hot-remove event occurs. If [EFI\\_BOOT\\_SERVICES.DisconnectController\(\)](#) returns an error the USB Bus Driver needs to retry the [EFI\\_BOOT\\_SERVICES.DisconnectController\(\)](#) from a timer event until it succeeds.

Device drivers are also affected by these hot-plug events. In the case of USB, a device can be removed without any notice. This means that the [Stop\(\)](#) functions of USB device drivers will have to deal with shutting down a driver for a device that is no longer present in the system. As a result, any outstanding I/O requests will have to be flushed without actually being able to touch the device hardware.

In general, adding support for hot-plug events greatly increases the complexity of both bus drivers and device drivers. Adding this support is up to the driver writer, so the extra complexity and size of the driver will need to be weighed against the need for the feature in the preboot environment.

## 2.5.8 EFI Services Binding

The *UEFI Driver Model* maps well onto hardware devices, hardware bus controllers, and simple combinations of software services that layer on top of hardware devices. However, the *UEFI driver Model* does not map well onto complex combinations of software services. As a result, an additional set of complementary protocols are required for more complex combinations of software services.

[Figure 15](#) contains three examples showing the different ways that software services relate to each other. In the first two cases, each service consumes one or more other services, and at most one other service consumes all of the services. Case #3 differs because two different services consume service A. The [EFI\\_DRIVER\\_BINDING\\_PROTOCOL](#) can be used to model cases #1 and #2, but it cannot be used to model case #3 because of the way that the *UEFI Boot Service* [OpenProtocol\(\)](#) behaves. When used with the [BY\\_DRIVER](#) open mode, [OpenProtocol\(\)](#) allows each protocol to have only at most one consumer. This feature is very useful and prevents multiple drivers from attempting to manage the same controller. However, it makes it difficult to produce sets of software services that look like case #3.

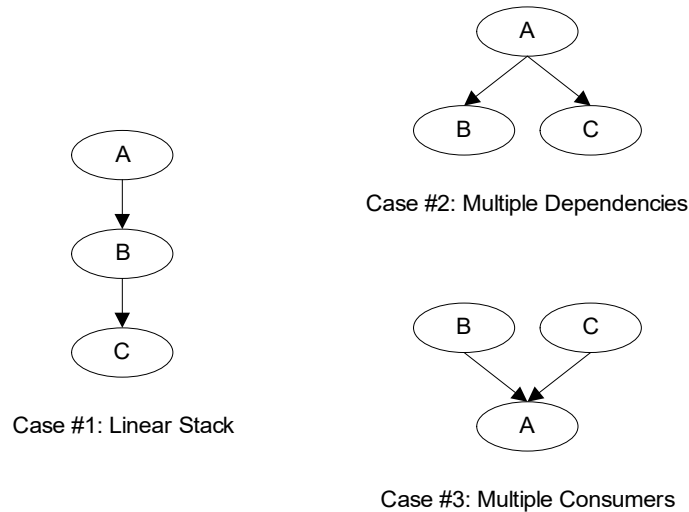

Figure 15. Software Service Relationships

The **EFI\_SERVICE\_BINDING\_PROTOCOL** provides the mechanism that allows protocols to have more than one consumer. The **EFI\_SERVICE\_BINDING\_PROTOCOL** is used with the **EFI\_DRIVER\_BINDING\_PROTOCOL**. A UEFI driver that produces protocols that need to be available to more than one consumer at the same time will produce both the **EFI\_DRIVER\_BINDING\_PROTOCOL** and the **EFI\_SERVICE\_BINDING\_PROTOCOL**. This type of driver is a hybrid driver that will produce the **EFI\_DRIVER\_BINDING\_PROTOCOL** in its driver entry point.

When the driver receives a request to start managing a controller, it will produce the **EFI\_SERVICE\_BINDING\_PROTOCOL** on the handle of the controller that is being started. The **EFI\_SERVICE\_BINDING\_PROTOCOL** is slightly different from other protocols defined in the *UEFI Specification*. It does not have a GUID associated with it. Instead, this protocol instance structure actually represents a family of protocols. Each software service driver that requires an **EFI\_SERVICE\_BINDING\_PROTOCOL** instance will be required to generate a new GUID for its own type of **EFI\_SERVICE\_BINDING\_PROTOCOL**. This requirement is why the various network protocols in this specification contain two GUIDs. One is the **EFI\_SERVICE\_BINDING\_PROTOCOL** GUID for that network protocol, and the other GUID is for the protocol that contains the specific member services produced by the network driver. The mechanism defined here is not limited to network protocol drivers. It can be applied to any set of protocols that the **EFI\_DRIVER\_BINDING\_PROTOCOL** cannot directly map because the protocols contain one or more relationships like case #3 in [Figure 15](#).

Neither the **EFI\_DRIVER\_BINDING\_PROTOCOL** nor the combination of the **EFI\_DRIVER\_BINDING\_PROTOCOL** and the **EFI\_SERVICE\_BINDING\_PROTOCOL** can handle circular dependencies. There are methods to allow circular references, but they require that the circular link be present for short periods of time. When the protocols across the circular link are used, these methods also require that the protocol must be opened with an open mode of **EXCLUSIVE**, so that any attempts to deconstruct the set of



protocols with a call to **DisconnectController()** will fail. As soon as the driver is finished with the protocol across the circular link, the protocol should be closed.

## 2.6 Requirements

This document is an architectural specification. As such, care has been taken to specify architecture in ways that allow maximum flexibility in implementation. However, there are certain requirements on which elements of this specification must be implemented to ensure that operating system loaders and other code designed to run with UEFI boot services can rely upon a consistent environment.

For the purposes of describing these requirements, the specification is broken up into required and optional elements. In general, an optional element is completely defined in the section that matches the element name. For required elements however, the definition may in a few cases not be entirely self contained in the section that is named for the particular element. In implementing required elements, care should be taken to cover all the semantics defined in this specification that relate to the particular element.

### 2.6.1 Required Elements

[Table 9](#) lists the required elements. Any system that is designed to conform to this specification *must* provide a complete implementation of all these elements. This means that all the required service functions and protocols must be present and the implementation must deliver the full semantics defined in the specification for all combinations of calls and parameters. Implementers of applications, drivers or operating system loaders that are designed to run on a broad range of systems conforming to the UEFI specification may assume that all such systems implement all the required elements.

A system vendor may choose not to implement all the required elements, for example on specialized system configurations that do not support all the services and functionality implied by the required elements. However, since most applications, drivers and operating system loaders are written assuming all the required elements are present on a system that implements the UEFI specification; any such code is likely to require explicit customization to run on a less than complete implementation of the required elements in this specification.

Table 9. Required UEFI Implementation Elements

Element	Description
<a href="#">EFI_SYSTEM_TABLE</a>	Provides access to UEFI Boot Services, UEFI Runtime Services, consoles, firmware vendor information, and the system configuration tables.
<a href="#">EFI_BOOT_SERVICES</a>	All functions defined as boot services.
<a href="#">EFI_RUNTIME_SERVICES</a>	All functions defined as runtime services.
<a href="#">EFI_LOADED_IMAGE_PROTOCOL</a>	Provides information on the image.
<a href="#">EFI_LOADED_IMAGE_DEVICE_PATH_PROTOCOL</a>	Specifies the device path that was used when a PE/COFF image was loaded through the EFI Boot Service LoadImage().
<a href="#">EFI_DEVICE_PATH_PROTOCOL</a>	Provides the location of the device.
<a href="#">EFI_DECOMPRESS_PROTOCOL</a>	Protocol interfaces to decompress an image that was compressed using the EFI Compression Algorithm.
<a href="#">EFI_DEVICE_PATH_UTILITIES_PROTOCOL</a>	Protocol interfaces to create and manipulate UEFI device paths and UEFI device path nodes.

## 2.6.2 Platform-Specific Elements

There are a number of elements that can be added or removed depending on the specific features that a platform requires. Platform firmware developers are required to implement UEFI elements based upon the features included. The following is a list of potential platform features and the elements that are required for each feature type:

1. If a platform includes console devices, the [EFI\\_SIMPLE\\_TEXT\\_INPUT\\_PROTOCOL](#), [EFI\\_SIMPLE\\_TEXT\\_INPUT\\_EX\\_PROTOCOL](#), and [EFI\\_SIMPLE\\_TEXT\\_OUTPUT\\_PROTOCOL](#) must be implemented.
2. If a platform includes a configuration infrastructure, then the [EFI\\_HII\\_DATABASE\\_PROTOCOL](#), [EFI\\_HII\\_STRING\\_PROTOCOL](#), [EFI\\_HII\\_CONFIG\\_ROUTING\\_PROTOCOL](#), and [EFI\\_HII\\_CONFIG\\_ACCESS\\_PROTOCOL](#) are required. If you support bitmapped fonts, you must support [EFI\\_HII\\_FONT\\_PROTOCOL](#).
3. If a platform includes graphical console devices, then the [EFI\\_GRAPHICS\\_OUTPUT\\_PROTOCOL](#), [EFI\\_EDID\\_DISCOVERED\\_PROTOCOL](#), and [EFI\\_EDID\\_ACTIVE\\_PROTOCOL](#) must be implemented. In order to support the [EFI\\_GRAPHICS\\_OUTPUT\\_PROTOCOL](#), a platform must contain a driver to consume [EFI\\_GRAPHICS\\_OUTPUT\\_PROTOCOL](#) and produce [EFI\\_SIMPLE\\_TEXT\\_OUTPUT\\_PROTOCOL](#) even if the [EFI\\_GRAPHICS\\_OUTPUT\\_PROTOCOL](#) is produced by an external driver.
4. If a platform includes a pointer device as part of its console support, the [EFI\\_SIMPLE\\_POINTER\\_PROTOCOL](#) must be implemented.
5. If a platform includes the ability to boot from a disk device, then the [EFI\\_BLOCK\\_IO\\_PROTOCOL](#), the [EFI\\_DISK\\_IO\\_PROTOCOL](#), the [EFI\\_SIMPLE\\_FILE\\_SYSTEM\\_PROTOCOL](#), and the [EFI\\_UNICODE\\_COLLATION\\_PROTOCOL](#) are required. In addition, partition support for MBR, GPT, and El Torito must be implemented. For disk devices supporting the security commands of the SPC-4 or ATA8-ACS command set, the [EFI\\_STORAGE\\_SECURITY\\_COMMAND\\_PROTOCOL](#) is also required. An external driver

- may produce the Block I/O Protocol and the [EFI STORAGE SECURITY COMMAND PROTOCOL](#). All other protocols required to boot from a disk device must be carried as part of the platform.
6. If a platform includes the ability to perform a TFTP-based boot from a network device, then the [EFI PXE BASE CODE PROTOCOL](#) is required. The platform must be prepared to produce this protocol on any of [EFI NETWORK INTERFACE IDENTIFIER PROTOCOL](#) (UNDI), [EFI SIMPLE NETWORK PROTOCOL](#), or the [EFI MANAGED NETWORK PROTOCOL](#). If a platform includes the ability to validate a boot image received through a network device, it is also required that image verification be supported, including *SetupMode* equal zero and the boot image hash or a verification certificate corresponding to the image exist in the 'db' variable and not in the 'dbx' variable. An external driver may produce the UEFI interface. All other protocols required to boot from a network device must be carried by the platform.
  7. If a platform supports UEFI general purpose network applications, then the [EFI MANAGED NETWORK PROTOCOL](#), [EFI MANAGED NETWORK SERVICE BINDING PROTOCOL](#), [EFI ARP PROTOCOL](#), [EFI ARP SERVICE BINDING PROTOCOL](#), [EFI DHCP4 PROTOCOL](#), [EFI DHCP4 SERVICE BINDING PROTOCOL](#), [EFI TCP4 PROTOCOL](#), [EFI TCP4 SERVICE BINDING PROTOCOL](#), [IP4 Protocol](#), [EFI IP4 SERVICE BINDING PROTOCOL](#), [EFI IP4 CONFIG2 PROTOCOL](#), [EFI UDP4 PROTOCOL](#), and [EFI UDP4 SERVICE BINDING PROTOCOL](#) are required. If additional IPv6 support is needed for the platform, then [EFI DHCP6 PROTOCOL](#), [EFI DHCP6 SERVICE BINDING PROTOCOL](#), [EFI TCP6 PROTOCOL](#), [EFI TCP6 SERVICE BINDING PROTOCOL](#), [EFI IP6 PROTOCOL](#), [EFI IP6 SERVICE BINDING PROTOCOL](#), [EFI IP6 CONFIG PROTOCOL](#), [EFI UDP6 PROTOCOL](#), and [EFI UDP6 SERVICE BINDING PROTOCOL](#) are additionally required. If the network application requires DNS capability, [EFI DNS4 SERVICE BINDING PROTOCOL](#) and [EFI DNS4 PROTOCOL](#) are required for the IPv4 stack. [EFI DNS6 SERVICE BINDING PROTOCOL](#) and [EFI DNS6 PROTOCOL](#) are required for the IPv6 stack. If the network environment requires TLS features, [EFI TLS SERVICE BINDING PROTOCOL](#), [EFI TLS PROTOCOL](#) and [EFI TLS CONFIGURATION PROTOCOL](#) are required. If the network environment requires IPSEC feature, [EFI IPSEC CONFIG PROTOCOL](#) and [EFI IPSEC2 PROTOCOL](#) are required. If the network environment requires VLAN features, [EFI VLAN CONFIG PROTOCOL](#) is required.
  8. If a platform includes a byte-stream device such as a UART, then the [EFI SERIAL IO PROTOCOL](#) must be implemented.
  9. If a platform includes PCI bus support, then the [EFI PCI ROOT BRIDGE IO PROTOCOL](#), the [EFI PCI IO PROTOCOL](#), must be implemented.
  10. If a platform includes USB bus support, then the [EFI USB2 HC PROTOCOL](#) and the [EFI USB IO PROTOCOL](#) must be implemented. An external device can support USB by producing a USB Host Controller Protocol.
  11. If a platform includes an NVM Express controller, then the [EFI NVM EXPRESS PASS THRU PROTOCOL](#) must be implemented.
  12. If a platform supports booting from a block-oriented NVM Express controller, then the [EFI BLOCK IO PROTOCOL](#) must be implemented. An external driver may produce the [EFI NVM EXPRESS PASS THRU PROTOCOL](#). All other protocols required to boot from an NVM Express subsystem must be carried by the platform.
  13. If a platform includes an I/O subsystem that utilizes SCSI command packets, then the [EFI EXT SCSI PASS THRU PROTOCOL](#) must be implemented.
  14. If a platform supports booting from a block oriented SCSI peripheral, then the [EFI SCSI IO PROTOCOL](#) and [EFI BLOCK IO PROTOCOL](#) must be implemented. An external driver may produce the [EFI EXT SCSI PASS THRU PROTOCOL](#). All other protocols required to boot from a SCSI I/O subsystem must be carried by the platform.

15. If a platform supports booting from an iSCSI peripheral, then the [EFI ISCSI INITIATOR NAME PROTOCOL](#) and the [EFI AUTHENTICATION INFO PROTOCOL](#) must be implemented.
16. If a platform includes debugging capabilities, then the [EFI DEBUG SUPPORT PROTOCOL](#), the [EFI DEBUGPORT PROTOCOL](#), and the [EFI Image Info Table](#) must be implemented.
17. If a platform includes the ability to override the default driver to the controller matching algorithm provided by the UEFI Driver Model, then the [EFI PLATFORM DRIVER OVERRIDE PROTOCOL](#) must be implemented.
18. If a platform includes an I/O subsystem that utilizes ATA command packets, then the [EFI ATA PASS THRU PROTOCOL](#) must be implemented.
19. If a platform supports option ROMs from devices not permanently attached to the platform and it supports the ability to authenticate those option ROMs, then it must support the option ROM validation methods described in [Network Protocols — UDP and MTFTP](#) and the authenticated EFI variables described in [Section 8.2](#).
20. If a platform includes the ability to authenticate UEFI images and the platform potentially supports more than one OS loader, it must support the methods described in [Network Protocols — UDP and MTFTP](#) and the authenticated UEFI variables described in [Section 8.2](#).
21. If a platform policy supports the inclusion or addition of any device that provides a container for one or more UEFI Drivers that are required for initialization of that device then an EBC interpreter must be implemented. If an EBC interpreter is implemented, then it must produce the [EFI EBC PROTOCOL](#) interface.
22. If a platform includes the ability to perform a HTTP-based boot from a network device, then the [EFI HTTP SERVICE BINDING PROTOCOL](#), [EFI HTTP PROTOCOL](#) and [EFI HTTP UTILITIES PROTOCOL](#) are required. If it includes the ability to perform a HTTPS-based boot from network device, besides above protocols, [EFI TLS SERVICE BINDING PROTOCOL](#), [EFI TLS PROTOCOL](#) and [EFI TLS CONFIGURATION PROTOCOL](#) are also required. If it includes the ability to perform a HTTP(S)-based boot with DNS feature, then [EFI DNS4 SERVICE BINDING PROTOCOL](#), [EFI DNS4 PROTOCOL](#) are required for the IPv4 stack; [EFI DNS6 SERVICE BINDING PROTOCOL](#) and [EFI DNS6 PROTOCOL](#) are required for the IPv6 stack.
23. If a platform includes the ability to perform a wireless boot from a network device with EAP feature, and if this platform provides a standalone wireless EAP driver, then [EFI EAP PROTOCOL](#), [EFI EAP CONFIGURATION PROTOCOL](#), and [EFI EAP MANAGEMENT2 PROTOCOL](#) are required; if the platform provides a standalone wireless supplicant, then [EFI SUPPLICANT PROTOCOL](#) and [EFI EAP CONFIGURATION PROTOCOL](#) are required. If it includes the ability to perform a wireless boot with TLS feature, then [EFI TLS SERVICE BINDING PROTOCOL](#), [EFI TLS PROTOCOL](#) and [EFI TLS CONFIGURATION PROTOCOL](#) are required.
24. If a platform supports classic Bluetooth, then [EFI BLUETOOTH HC PROTOCOL](#), [EFI BLUETOOTH IO PROTOCOL](#), and [EFI BLUETOOTH CONFIG PROTOCOL](#) must be implemented, and [EFI\\_BLUETOOTH\\_ATTRIBUTE\\_PROTOCOL](#) may be implemented. If a platform supports Bluetooth Smart (Bluetooth Low Energy), then [EFI BLUETOOTH HC PROTOCOL](#), [EFI BLUETOOTH ATTRIBUTE PROTOCOL](#) and [EFI BLUETOOTH LE CONFIG PROTOCOL](#) must be implemented. If a platform supports both Bluetooth classic and BluetoothLE, then both above requirements should be satisfied.
25. 24. If a platform supports RESTful communication over HTTP or over an in-band path to a BMC, then the [EFI REST PROTOCOL](#) must be implemented.
26. If a platform includes the ability to use a hardware feature to create high quality random numbers, this capability should be exposed by instance of [EFI RNG PROTOCOL](#) with at least one EFI RNG Algorithm supported.
27. If a platform permits the installation of Load Option Variables, (Boot####, or Driver####, or SysPrep####), the platform must support and recognize all defined values for Attributes within the variable and report these capabilities in BootOptionSupport. If a platform supports

installation of Load Option Variables of type Driver####, all installed Driver#### variables must be processed and the indicated driver loaded and initialized during every boot. And all installed SysPrep#### options must be processed prior to processing Boot#### options.

28. If the platform supports UEFI secure boot as described in [Secure Boot and Driver Signing](#), the platform must provide the PKCS verification functions described in [Section 36.4](#).
29. If a platform includes an I/O subsystem that utilizes SD or eMMC command packets, then the [EFI SD MMC PASS THRU PROTOCOL](#) must be implemented.
30. If a platform includes the ability to create/destroy a specified RAM disk, the [EFI RAM DISK PROTOCOL](#) must be implemented and only one instance of this protocol exists.
31. If a platform includes a mass storage device which supports hardware-based erase on a specified range, then the [EFI ERASE BLOCK PROTOCOL](#) must be implemented.
32. If a platform includes the ability to register for notifications when a call to ResetSystem is called, then the [EFI RESET NOTIFICATION PROTOCOL](#) must be implemented.
33. If a platform includes UFS devices, the EFI\_UFS\_DEVICE\_CONFIG\_PROTOCOL must be implemented.

### 2.6.3 Driver-Specific Elements

There are a number of UEFI elements that can be added or removed depending on the features that a specific driver requires. Drivers can be implemented by platform firmware developers to support buses and devices in a specific platform. Drivers can also be implemented by add-in card vendors for devices that might be integrated into the platform hardware or added to a platform through an expansion slot.

The following list includes possible driver features, and the UEFI elements that are required for each feature type:

1. If a driver follows the driver model of this specification, the [EFI DRIVER BINDING PROTOCOL](#) must be implemented. It is strongly recommended that all drivers that follow the driver model of this specification also implement the [EFI COMPONENT NAME2 PROTOCOL](#).
2. If a driver requires configuration information, the driver must use the [EFI HII DATABASE PROTOCOL](#). A driver should not otherwise display information to the user or request information from the user.
3. If a driver requires diagnostics, the [EFI DRIVER DIAGNOSTICS2 PROTOCOL](#) must be implemented. In order to support low boot times, limit diagnostics during normal boots. Time consuming diagnostics should be deferred until the [EFI DRIVER DIAGNOSTICS2 PROTOCOL](#) is invoked.
4. If a bus supports devices that are able to provide containers for drivers (e.g. option ROMs), then the bus driver for that bus type must implement the [EFI BUS SPECIFIC DRIVER OVERRIDE PROTOCOL](#).
5. If a driver is written for a console output device, then the [EFI SIMPLE TEXT OUTPUT PROTOCOL](#) must be implemented.
6. If a driver is written for a graphical console output device, then the [EFI GRAPHICS OUTPUT PROTOCOL](#), [EFI EDID DISCOVERED PROTOCOL](#) and [EFI EDID ACTIVE PROTOCOL](#) must be implemented.
7. If a driver is written for a console input device, then the [EFI SIMPLE TEXT INPUT PROTOCOL](#) and [EFI SIMPLE TEXT INPUT EX PROTOCOL](#) must be implemented.
8. If a driver is written for a pointer device, then the [EFI SIMPLE POINTER PROTOCOL](#) must be implemented.

9. If a driver is written for a network device, then the [EFI NETWORK INTERFACE IDENTIFIER PROTOCOL](#), [EFI SIMPLE NETWORK PROTOCOL](#) or [EFI MANAGED NETWORK PROTOCOL](#) must be implemented. If VLAN is supported in hardware, then driver for the network device may implement the [EFI VLAN CONFIG PROTOCOL](#). If a network device chooses to only produce the [EFI MANAGED NETWORK PROTOCOL](#), then the driver for the network device must implement the [EFI VLAN CONFIG PROTOCOL](#). If a driver is written for a network device to supply wireless feature, besides above protocols, [EFI ADAPTER INFORMATION PROTOCOL](#) must be implemented. If the wireless driver does not provide user configuration capability, [EFI WIRELESS MAC CONNECTION II PROTOCOL](#) must be implemented. If the wireless driver is written for a platform which provides a standalone wireless EAP driver, [EFI EAP PROTOCOL](#) must be implemented.
10. If a driver is written for a disk device, then the [EFI BLOCK IO PROTOCOL](#) and the [EFI BLOCK IO2 PROTOCOL](#) must be implemented. In addition, the [EFI STORAGE SECURITY COMMAND PROTOCOL](#) must be implemented for disk devices supporting the security commands of the SPC-4 or ATA8-ACS command set. In addition, for devices that support inline encryption in the host storage controller, the [EFI BLOCK IO CRYPTO PROTOCOL](#) must be supported.
11. If a driver is written for a disk device, then the [EFI BLOCK IO PROTOCOL](#) and the [EFI BLOCK IO2 PROTOCOL](#) must be implemented. In addition, the [EFI STORAGE SECURITY COMMAND PROTOCOL](#) must be implemented for disk devices supporting the security commands of the SPC-4 or ATA8-ACS command set.
12. If a driver is written for a device that is not a block oriented device but one that can provide a file system-like interface, then the [EFI SIMPLE FILE SYSTEM PROTOCOL](#) must be implemented.
13. If a driver is written for a PCI root bridge, then the [EFI PCI ROOT BRIDGE IO PROTOCOL](#) and the [EFI PCI IO PROTOCOL](#) must be implemented.
14. If a driver is written for an NVM Express controller, then the [EFI NVM EXPRESS PASS THRU PROTOCOL](#) must be implemented.
15. If a driver is written for a USB host controller, then the [EFI USB2\\_HC PROTOCOL](#) and the [EFI USB IO PROTOCOL](#) must be implemented. If a driver is written for a USB host controller, then the must be implemented.
16. If a driver is written for a SCSI controller, then the [EFI EXT SCSI PASS THRU PROTOCOL](#) must be implemented.
17. If a driver is digitally signed, it must embed the digital signature in the PE/COFF image as described in [“Embedded Signatures” on page 1975](#).
18. If a driver is written for a boot device that is not a block-oriented device, a file system-based device, or a console device, then the [EFI LOAD FILE PROTOCOL](#) must be implemented.
19. If a driver follows the driver model of this specification, and the driver wants to produce warning or error messages for the user, then the [EFI DRIVER HEALTH PROTOCOL](#) must be used to produce those messages. The Boot Manager may optionally display the messages to the user.
20. If a driver follows the driver model of this specification, and the driver needs to perform a repair operation that is not part of the normal initialization sequence, and that repair operation requires an extended period of time, then the [EFI DRIVER HEALTH PROTOCOL](#) must be used to provide the repair feature. If the Boot Manager detects a boot device that requires a repair operation, then the Boot Manager must use the [EFI DRIVER HEALTH PROTOCOL](#) to perform the repair operation. The Boot Manager can optionally display progress indicators as the repair operation is performed by the driver.
21. If a driver follows the driver model of this specification, and the driver requires the user to make software and/or hardware configuration changes before the boot devices that the driver manages can be used, then the [EFI DRIVER HEALTH PROTOCOL](#) must be produced. If the Boot Manager detects a boot device that requires software and/or hardware configuration



- changes to make the boot device usable, then the Boot Manager may optionally allow the user to make those configuration changes.
22. If a driver is written for an ATA controller, then the [EFI ATA PASS THRU PROTOCOL](#) must be implemented.
  23. If a driver follows the driver model of this specification, and the driver wants to be used with higher priority than the Bus Specific Driver Override Protocol when selecting the best driver for controller, then the [EFI DRIVER FAMILY OVERRIDE PROTOCOL](#) must be produced on the same handle as the [EFI DRIVER BINDING PROTOCOL](#).
  24. If a driver supports firmware management by an external agent or application, then the [EFI FIRMWARE MANAGEMENT PROTOCOL](#) must be used to support firmware management.
  25. If a driver follows the driver model of this specification and a driver is a device driver as defined in [Section 2.5](#), it must perform bus transactions via the bus abstraction protocol produced by a parent bus driver. Thus a driver for a device that conforms to the PCI specification must use [EFI PCI IO PROTOCOL](#) for all PCI memory space, PCI I/O, PCI configuration space, and DMA operations.
  26. If a driver is written for a classic Bluetooth controller, then [EFI BLUETOOTH HC PROTOCOL](#), [EFI BLUETOOTH IO PROTOCOL](#) and [EFI BLUETOOTH CONFIG PROTOCOL](#) must be implemented, and [EFI BLUETOOTH ATTRIBUTE PROTOCOL](#) may be implemented. If a driver written for a Bluetooth Smart (Bluetooth Low Energy) controller, then [EFI BLUETOOTH HC PROTOCOL](#), [EFI BLUETOOTH ATTRIBUTE PROTOCOL](#) and [EFI BLUETOOTH LE CONFIG PROTOCOL](#) must be implemented. If a driver supports both Bluetooth classic and BluetoothLE, then both above requirements should be satisfied.
  27. If a driver is written for an SD controller or eMMC controller, then the [EFI SD MMC PASS THRU PROTOCOL](#) must be implemented.
  28. If a driver is written for a UFS device, then `EFI_UFS_DEVICE_CONFIG_PROTOCOL` must be implemented.

## 2.6.4 Extensions to this Specification published elsewhere

This specification has been extended over time to include support for new devices and technologies. As the name of the specification implies, the original intent in its definition was to create a baseline for firmware interfaces that is extensible without the need to include extensions in the main body of this specification.

Readers of this specification may find that a feature or type of device is not treated by the specification. This does not necessarily mean that there is no agreed "standard" way to support the feature or device in implementations that claim conformance to this Specification. On occasion, it may be more appropriate for other standards organizations to publish their own extensions that are designed to be used in concert with the definitions presented here. This may for example allow support for new features in a more timely fashion than would be accomplished by waiting for a revision to this specification or perhaps that such support is defined by a group with a specific expertise in the subject area. Readers looking for means to access features or devices that are not treated in this document are therefore recommended to inquire of appropriate standards groups to ascertain if appropriate extension publications already exist before creating their own extensions.

By way of examples, at the time of writing the UEFI Forum is aware of a number of extension publications that are compatible with and designed for use with this specification. Such extensions include:

*Developers Interface Guide for Itanium® Architecture Based Servers:* published and hosted by the DIG64 group (See “Links to UEFI-Related Documents” (<http://uefi.org/uefi>) under the heading “Developers Interface Guide for Itanium® Architecture Based Servers”). This document is a set of technical guidelines that define hardware, firmware, and operating system compatibility for Itanium™-based servers;

*TCG EFI Platform Specification:* published and hosted by the Trusted Computing Group (See “Links to UEFI-Related Documents” (<http://uefi.org/uefi>) under the heading “TCG EFI Platform Specification”). This document is about the processes that boot an EFI platform and boot an OS on that platform. Specifically, this specification contains the requirements for measuring boot events into TPM PCRs and adding boot event entries into the Event Log.

*TCG EFI Protocol Specification:* published and hosted by the Trusted Computing Group (See “Links to UEFI-Related Documents” (<http://uefi.org/uefi>) under the heading “TCG EFI Protocol Specification”). This document defines a standard interface to the TPM on an EFI platform.

Other extension documents may exist outside the view of the UEFI Forum or may have been created since the last revision of this document.



## 3 Boot Manager

---

The UEFI boot manager is a firmware policy engine that can be configured by modifying architecturally defined global NVRAM variables. The boot manager will attempt to load UEFI drivers and UEFI applications (including UEFI OS boot loaders) in an order defined by the global NVRAM variables. The platform firmware must use the boot order specified in the global NVRAM variables for normal boot. The platform firmware may add extra boot options or remove invalid boot options from the boot order list.

The platform firmware may also implement value added features in the boot manager if an exceptional condition is discovered in the firmware boot process. One example of a value added feature would be not loading a UEFI driver if booting failed the first time the driver was loaded. Another example would be booting to an OEM-defined diagnostic environment if a critical error was discovered in the boot process.

The boot sequence for UEFI consists of the following:

- The boot order list is read from a globally defined NVRAM variable. Modifications to this variable are only guaranteed to take effect after the next platform reset. The boot order list defines a list of NVRAM variables that contain information about what is to be booted. Each NVRAM variable defines a name for the boot option that can be displayed to a user.
- The variable also contains a pointer to the hardware device and to a file on that hardware device that contains the UEFI image to be loaded.
- The variable might also contain paths to the OS partition and directory along with other configuration specific directories.

The NVRAM can also contain load options that are passed directly to the UEFI image. The platform firmware has no knowledge of what is contained in the load options. The load options are set by higher level software when it writes to a global NVRAM variable to set the platform firmware boot policy. This information could be used to define the location of the OS kernel if it was different than the location of the UEFI OS loader.

### 3.1 Firmware Boot Manager

The boot manager is a component in firmware conforming to this specification that determines which drivers and applications should be explicitly loaded and when. Once compliant firmware is initialized, it passes control to the boot manager. The boot manager is then responsible for determining what to load and any interactions with the user that may be required to make such a decision.

The actions taken by the boot manager depend upon the system type and the policies set by the system designer. For systems that allow the installation of new Boot Variables ([Section 3.4](#)), the Boot Manager must automatically or upon the request of the loaded item, initialize at least one system console, as well as perform all required initialization of the device indicated within the primary boot target. For such systems, the Boot Manager is also required to honor the priorities set in BootOrder variable.

In particular, likely implementation options might include any console interface concerning boot, integrated platform management of boot selections, and possible knowledge of other internal applications or recovery drivers that may be integrated into the system through the boot manager.

### 3.1.1 Boot Manager Programming

Programmatic interaction with the boot manager is accomplished through globally defined variables. On initialization the boot manager reads the values which comprise all of the published load options among the UEFI environment variables. By using the [SetVariable\(\)](#) function the data that contain these environment variables can be modified. Such modifications are guaranteed to take effect after the next system boot commences. However, boot manager implementations may choose to improve on this guarantee and have changes take immediate effect for all subsequent accesses to the variables that affect boot manager behavior without requiring any form of system reset

Each load option entry resides in a *Boot####*, *Driver####*, *SysPrep####*, *OsRecovery####* or *PlatformRecovery####* variable where *####* is replaced by a unique option number in printable hexadecimal representation using the digits 0–9, and the upper case versions of the characters A–F (0000–FFFF).

The *####* must always be four digits, so small numbers must use leading zeros. The load options are then logically ordered by an array of option numbers listed in the desired order. There are two such option ordering lists when booting normally. The first is *DriverOrder* that orders the *Driver####* load option variables into their load order. The second is *BootOrder* that orders the *Boot####* load options variables into their load order.

For example, to add a new boot option, a new *Boot####* variable would be added. Then the option number of the new *Boot####* variable would be added to the *BootOrder* ordered list and the *BootOrder* variable would be rewritten. To change boot option on an existing *Boot####*, only the *Boot####* variable would need to be rewritten. A similar operation would be done to add, remove, or modify the driver load list.

If the boot via *Boot####* returns with a status of **EFI\_SUCCESS**, platform firmware supports boot manager menu, and if firmware is configured to boot in an interactive mode, the boot manager will stop processing the *BootOrder* variable and present a boot manager menu to the user. If any of the above-mentioned conditions is not satisfied, the next *Boot####* in the *BootOrder* variable will be tried until all possibilities are exhausted. In this case, boot option recovery must be performed (see [Section 3.4](#)).

The boot manager may perform automatic maintenance of the database variables. For example, it may remove unreferenced load option variables or any load option variables that cannot be parsed, and it may rewrite any ordered list to remove any load options that do not have corresponding load option variables. The boot manager can also, at its own discretion, provide an administrator with the ability to invoke manual maintenance operations as well. Examples include choosing the order of any or all load options, activating or deactivating load options, initiating OS-defined or platform-defined recovery, etc. In addition, if a platform intends to create *PlatformRecovery####*, before attempting to load and execute any *DriverOrder* or *BootOrder* entries, the firmware must

create any and all *PlatformRecovery####* variables (see [Section 3.4.2](#)). The firmware should not, under normal operation, automatically remove any correctly formed *Boot####* variable currently referenced by the *BootOrder* or *BootNext* variables. Such removal should be limited to scenarios where the firmware is guided by direct user interaction.

The contents of *PlatformRecovery####* represent the final recovery options the firmware would have attempted had recovery been initiated during the current boot, and need not include entries to reflect contingencies such as significant hardware reconfiguration, or entries corresponding to specific hardware that the firmware is not yet aware of.

The behavior of the UEFI Boot Manager is impacted when Secure Boot is enabled, See [Section 31.4](#).

### 3.1.2 Load Option Processing

The boot manager is required to process the Driver load option entries before the Boot load option entries. If the **EFI\_OS\_INDICATIONS\_START\_OS\_RECOVERY** bit has been set in *OsIndications*, the firmware shall attempt OS-defined recovery (see [Section 3.4.1](#)) rather than normal boot processing. If the **EFI\_OS\_INDICATIONS\_START\_PLATFORM\_RECOVERY** bit has been set in *OsIndications*, the firmware shall attempt platform-defined recovery (see [Section 3.4.2](#)) rather than normal boot processing or handling of the **EFI\_OS\_INDICATIONS\_START\_OS\_RECOVERY** bit. In either case, both bits should be cleared.

Otherwise, the boot manager is also required to initiate a boot of the boot option specified by the *BootNext* variable as the first boot option on the next boot, and only on the next boot. The boot manager removes the *BootNext* variable before transferring control to the *BootNext* boot option. After the *BootNext* boot option is tried, the normal *BootOrder* list is used. To prevent loops, the boot manager deletes *BootNext* before transferring control to the preselected boot option.

If all entries of *BootNext* and *BootOrder* have been exhausted without success, or if the firmware has been instructed to attempt boot order recovery, the firmware must attempt boot option recovery (see [Section 3.4](#)).

The boot manager must call [EFI\\_BOOT\\_SERVICES.LoadImage\(\)](#) which supports at least [EFI\\_SIMPLE\\_FILE\\_SYSTEM\\_PROTOCOL](#) and [EFI\\_LOAD\\_FILE\\_PROTOCOL](#) for resolving load options. If [LoadImage\(\)](#) succeeds, the boot manager must enable the watchdog timer for 5 minutes by using the [EFI\\_BOOT\\_SERVICES.SetWatchdogTimer\(\)](#) boot service prior to calling [EFI\\_BOOT\\_SERVICES.StartImage\(\)](#). If a boot option returns control to the boot manager, the boot manager must disable the watchdog timer with an additional call to the [SetWatchdogTimer\(\)](#) boot service.

If the boot image is not loaded via [EFI\\_BOOT\\_SERVICES.LoadImage\(\)](#) the boot manager is required to check for a default application to boot. Searching for a default application to boot happens on both removable and fixed media types. This search occurs when the device path of the boot image listed in any boot option points directly to an **EFI\_SIMPLE\_FILE\_SYSTEM\_PROTOCOL** device and does not specify the exact file to load. The file discovery method is explained in [Section 3.4](#). The default media boot case

of a protocol other than **EFI\_SIMPLE\_FILE\_SYSTEM\_PROTOCOL** is handled by the **EFI\_LOAD\_FILE\_PROTOCOL** for the target device path and does not need to be handled by the boot manager.

The UEFI boot manager must support booting from a short-form device path that starts with the first element being a USB WWID (see [Table 61](#)) or a USB Class (see [Table 63](#)) device path. For USB WWID, the boot manager must use the device vendor ID, device product id, and serial number, and must match any USB device in the system that contains this information. If more than one device matches the USB WWID device path, the boot manager will pick one arbitrarily. For USB Class, the boot manager must use the vendor ID, Product ID, Device Class, Device Subclass, and Device Protocol, and must match any USB device in the system that contains this information. If any of the ID, Product ID, Device Class, Device Subclass, or Device Protocol contain all F's (0xFFFF or 0xFF), this element is skipped for the purpose of matching. If more than one device matches the USB Class device path, the boot manager will pick one arbitrarily.

The boot manager must also support booting from a short-form device path that starts with the first element being a hard drive media device path (see [Table 86](#)). The boot manager must use the GUID or signature and partition number in the hard drive device path to match it to a device in the system. If the drive supports the GPT partitioning scheme the GUID in the hard drive media device path is compared with the *UniquePartitionGuid* field of the GUID Partition Entry (see [Table 18](#)). If the drive supports the PC-AT MBR scheme the signature in the hard drive media device path is compared with the *UniqueMBRSignature* in the Legacy Master Boot Record (see [Table 13](#)). If a signature match is made, then the partition number must also be matched. The hard drive device path can be appended to the matching hardware device path and normal boot behavior can then be used. If more than one device matches the hard drive device path, the boot manager will pick one arbitrarily. Thus the operating system must ensure the uniqueness of the signatures on hard drives to guarantee deterministic boot behavior.

The boot manager must also support booting from a short-form device path that starts with the first element being a File Path Media Device Path (see [Table 89](#)). When the boot manager attempts to boot a short-form File Path Media Device Path, it will enumerate all removable media devices, followed by all fixed media devices, creating boot options for each device. The boot option `FilePathList[0]` is constructed by appending short-form File Path Media Device Path to the device path of a media. The order within each group is undefined. These new boot options must not be saved to non volatile storage, and may not be added to *BootOrder*. The boot manager will then attempt to boot from each boot option. If a device does not support the **EFI\_SIMPLE\_FILE\_SYSTEM\_PROTOCOL**, but supports the **EFI\_BLOCK\_IO\_PROTOCOL** protocol, then the EFI Boot Service *ConnectController* must be called for this device with *DriverImageHandle* and *RemainingDevicePath* set to NULL and the Recursive flag is set to **TRUE**. The firmware will then attempt to boot from any child handles produced using the algorithms outlined above.

The boot manager must also support booting from a short-form device path that starts with the first element being a URI Device Path (see [Table 78](#)). When the boot manager attempts to boot a short-form URI Device Path, it could attempt to connect any device which will produce a device path protocol including a URI device path node until it matches a device, or fail to match any device. The boot manager will enumerate all

*LoadFile* protocol instances, and invoke *LoadFile* protocol with *FilePath* set to the short-form device path during the matching process.

### 3.1.3 Load Options

Each load option variable contains an **EFI\_LOAD\_OPTION** descriptor that is a byte packed buffer of variable length fields.

```
typedef struct _EFI_LOAD_OPTION {
    UINT32      Attributes;
    UINT16      FilePathListLength;
    // CHAR16    Description[];
    // EFI_DEVICE_PATH_PROTOCOL FilePathList[];
    // UINT8     OptionalData[];
} EFI_LOAD_OPTION;
```

#### Parameters

<i>Attributes</i>	The attributes for this load option entry. All unused bits must be zero and are reserved by the UEFI specification for future growth. See “Related Definitions.”
<i>FilePathListLength</i>	Length in bytes of the <i>FilePathList</i> . <i>OptionalData</i> starts at offset <b>sizeof(UINT32) + sizeof(UINT16) + StrSize(Description) + FilePathListLength</b> of the <b>EFI_LOAD_OPTION</b> descriptor.
<i>Description</i>	The user readable description for the load option. This field ends with a Null character.
<i>FilePathList</i>	A packed array of UEFI device paths. The first element of the array is a device path that describes the device and location of the Image for this load option. The <i>FilePathList[0]</i> is specific to the device type. Other device paths may optionally exist in the <i>FilePathList</i> , but their usage is OSV specific. Each element in the array is variable length, and ends at the device path end structure. Because the size of <i>Description</i> is arbitrary, this data structure is not guaranteed to be aligned on a natural boundary. This data structure may have to be copied to an aligned natural boundary before it is used.
<i>OptionalData</i>	The remaining bytes in the load option descriptor are a binary data buffer that is passed to the loaded image. If the field is zero bytes long, a <b>NULL</b> pointer is passed to the loaded image. The number of bytes in <i>OptionalData</i> can be computed by subtracting the starting offset of <i>OptionalData</i> from total size in bytes of the <b>EFI_LOAD_OPTION</b> .

#### Related Definitions

```
//*****
// Attributes
```

```

//*****
#define LOAD_OPTION_ACTIVE          0x00000001
#define LOAD_OPTION_FORCE_RECONNECT 0x00000002
#define LOAD_OPTION_HIDDEN         0x00000008
#define LOAD_OPTION_CATEGORY       0x00001F00

#define LOAD_OPTION_CATEGORY_BOOT  0x00000000
#define LOAD_OPTION_CATEGORY_APP   0x00000100
// All values 0x00000200-0x00001F00 are reserved

```

## Description

Calling [SetVariable\(\)](#) creates a load option. The size of the load option is the same as the size of the *DataSize* argument to the [SetVariable\(\)](#) call that created the variable. When creating a new load option, all undefined attribute bits must be written as zero. When updating a load option, all undefined attribute bits must be preserved.

If a load option is marked as **LOAD\_OPTION\_ACTIVE**, the boot manager will attempt to boot automatically using the device path information in the load option. This provides an easy way to disable or enable load options without needing to delete and re-add them.

If any *Driver####* load option is marked as **LOAD\_OPTION\_FORCE\_RECONNECT**, then all of the UEFI drivers in the system will be disconnected and reconnected after the last *Driver####* load option is processed. This allows a UEFI driver loaded with a *Driver####* load option to override a UEFI driver that was loaded prior to the execution of the UEFI Boot Manager.

The executable indicated by *FilePathList[0]* in *Driver####* load option must be of type **EFI\_IMAGE\_SUBSYSTEM\_EFI\_BOOT\_SERVICE\_DRIVER** or **EFI\_IMAGE\_SUBSYSTEM\_EFI\_RUNTIME\_DRIVER** otherwise the indicated executable will not be entered for initialization.

The executable indicated by *FilePathList[0]* in *SysPrep###*, *Boot####*, or *OsRecovery####* load option must be of type **EFI\_IMAGE\_SUBSYSTEM\_EFI\_APPLICATION**, otherwise the indicated executable will not be entered.

The **LOAD\_OPTION\_CATEGORY** is a sub-field of Attributes that provides details to the boot manager to describe how it should group the *Boot####* load options. This field is ignored for variables of the form *Driver####*, *SysPrep####*, or *OsRecovery####*.

*Boot####* load options with **LOAD\_OPTION\_CATEGORY** set to **LOAD\_OPTION\_CATEGORY\_BOOT** are meant to be part of the normal boot processing.

*Boot####* load options with **LOAD\_OPTION\_CATEGORY** set to **LOAD\_OPTION\_CATEGORY\_APP** are executables which are not part of the normal boot processing but can be optionally chosen for execution if boot menu is provided, or via Hot Keys. See [Section 3.1.6](#) for details.

Boot options with reserved category values, will be ignored by the boot manager.



If any *Boot####* load option is marked as **LOAD\_OPTION\_HIDDEN**, then the load option will not appear in the menu (if any) provided by the boot manager for load option selection.

### 3.1.4 Boot Manager Capabilities

The boot manager can report its capabilities through the global variable *BootOptionSupport*. If the global variable is not present, then an installer or application must act as if a value of 0 was returned.

```
#define EFI_BOOT_OPTION_SUPPORT_KEY  0x00000001
#define EFI_BOOT_OPTION_SUPPORT_APP  0x00000002
#define EFI_BOOT_OPTION_SUPPORT_SYSPREP 0x00000010
#define EFI_BOOT_OPTION_SUPPORT_COUNT 0x00000300
```

If **EFI\_BOOT\_OPTION\_SUPPORT\_KEY** is set then the boot manager supports launching of *Boot####* load options using key presses. If **EFI\_BOOT\_OPTION\_SUPPORT\_APP** is set then the boot manager supports boot options with **LOAD\_OPTION\_CATEGORY\_APP**. If **EFI\_BOOT\_OPTION\_SUPPORT\_SYSPREP** is set then the boot manager supports boot options of form *SysPrep####*.

The value specified in **EFI\_BOOT\_OPTION\_SUPPORT\_COUNT** describes the maximum number of key presses which the boot manager supports in the **EFI\_KEY\_OPTION.KeyData.InputKeyCount**. This value is only valid if **EFI\_BOOT\_OPTION\_SUPPORT\_KEY** is set. Key sequences with more keys specified are ignored.

### 3.1.5 Launching Boot#### Applications

The boot manager may support a separate category of *Boot####* load option for applications. The boot manager indicates that it supports this separate category by setting the **EFI\_BOOT\_OPTION\_SUPPORT\_APP** in the *BootOptionSupport* global variable.

When an application's *Boot####* option is being added to the *BootOrder*, the installer should clear **LOAD\_OPTION\_ACTIVE** so that the boot manager does not attempt to automatically "boot" the application. If the boot manager indicates that it supports a separate application category, as described above, the installer should set **LOAD\_OPTION\_CATEGORY\_APP**. If not, it should set **LOAD\_OPTION\_CATEGORY\_BOOT**.

### 3.1.6 Launching Boot#### Load Options Using Hot Keys

The boot manager may support launching a *Boot####* load option using a special key press. If so, the boot manager reports this capability by setting **EFI\_BOOT\_OPTION\_SUPPORT\_KEY** in the *BootOptionSupport* global variable.

A boot manager which supports key press launch reads the current key information from the console. Then, if there was a key press, it compares the key returned against zero or more *Key####* global variables. If it finds a match, it verifies that the *Boot####* load option specified is valid and, if so, attempts to launch it immediately. The *####* in the

*Key####* is a printable hexadecimal number ('0'-'9', 'A'-'F') with leading zeroes. The order which the *Key####* variables are checked is implementation-specific.

The boot manager may ignore *Key####* variables where the hot keys specified overlap with those used for internal boot manager functions. It is recommended that the boot manager delete these keys.

The *Key####* variables have the following format:

## Prototype

```
typedef struct _EFI_KEY_OPTION {
    EFI_BOOT_KEY_DATA KeyData;
    UINT32    BootOptionCrc;
    UINT16    BootOption;
    // EFI_INPUT_KEY Keys[];
} EFI_KEY_OPTION;
```

## Parameters

### *KeyData*

Specifies options about how the key will be processed. Type **EFI\_BOOT\_KEY\_DATA** is defined in "Related Definitions" below.

### *BootOptionCrc*

The CRC-32 which should match the CRC-32 of the entire **EFI\_LOAD\_OPTION** to which *BootOption* refers. If the CRC-32s do not match this value, then this key option is ignored.

### *BootOption*

The *Boot####* option which will be invoked if this key is pressed and the boot option is active (**LOAD\_OPTION\_ACTIVE** is set).

### *Keys*

The key codes to compare against those returned by the **EFI\_SIMPLE\_TEXT\_INPUT** and **EFI\_SIMPLE\_TEXT\_INPUT\_EX** protocols. The number of key codes (0-3) is specified by the **EFI\_KEY\_CODE\_COUNT** field in *KeyOptions*.



## Related Definitions

```
typedef union {
  struct {
    UINT32 Revision : 8;
    UINT32 ShiftPressed : 1;
    UINT32 ControlPressed : 1;
    UINT32 AltPressed : 1;
    UINT32 LogoPressed : 1;
    UINT32 MenuPressed : 1;
    UINT32 SysReqPressed : 1;
    UINT32 Reserved : 16;
    UINT32 InputKeyCount : 2;
  } Options;
  UINT32 PackedValue;
} EFI_BOOT_KEY_DATA;
```

### *Revision*

Indicates the revision of the **EFI\_KEY\_OPTION** structure. This revision level should be 0.

### *ShiftPressed*

Either the left or right Shift keys must be pressed (1) or must not be pressed (0).

### *ControlPressed*

Either the left or right Control keys must be pressed (1) or must not be pressed (0).

### *AltPressed*

Either the left or right Alt keys must be pressed (1) or must not be pressed (0).

### *LogoPressed*

Either the left or right Logo keys must be pressed (1) or must not be pressed (0).

### *MenuPressed*

The Menu key must be pressed (1) or must not be pressed (0).

### *SysReqPressed*

The SysReq key must be pressed (1) or must not be pressed (0).

### *InputKeyCount*

Specifies the actual number of entries in **EFI\_KEY\_OPTION.Keys**, from 0-3. If zero, then only the shift state is considered. If more than one, then the boot option will only be launched if all of the specified keys are pressed with the same shift state.

Example #1: ALT is the hot key. *KeyData.PackedValue* = **0x00000400**.

Example #2: CTRL-ALT-P-R. *KeyData.PackedValue* = **0x80000600**.

Example #3: CTRL-F1. *KeyData.PackedValue* = **0x40000200**.

### 3.1.7 Required System Preparation Applications

A load option of the form *SysPrep####* is intended to designate a UEFI application that is required to execute in order to complete system preparation prior to processing of any *Boot####* variables. The execution order of *SysPrep####* applications is determined by the contents of the variable *SysPrepOrder* in a way directly analogous to the ordering of *Boot####* options by *BootOrder*.

The platform is required to examine all *SysPrep####* variables referenced in *SysPrepOrder*. If Attributes bit **LOAD\_OPTION\_ACTIVE** is set, and the application referenced by *FilePathList[0]* is present, the UEFI Applications thus identified must be loaded and launched in the order they appear in *SysPrepOrder* and prior to the launch of any load options of type *Boot####*.

When launched, the platform is required to provide the application loaded by *SysPrep####*, with the same services such as console and network as are normally provided at launch to applications referenced by a *Boot####* variable. *SysPrep####* application must exit and may not call **ExitBootServices()**. Processing of any Error Code returned at exit is according to system policy and does not necessarily change processing of following boot options. Any driver portion of the feature supported by *SysPrep####* boot option that is required to remain resident should be loaded by use of *Driver####* variable.

The Attributes option **LOAD\_OPTION\_FORCE\_RECONNECT** is ignored for *SysPrep####* variables, and in the event that an application so launched performs some action that adds to the available hardware or drivers, the system preparation application shall itself utilize appropriate calls to **ConnectController()** or **DisconnectController()** to revise connections between drivers and hardware.

After all *SysPrep####* variables have been launched and exited, the platform shall notify **EFI\_EVENT\_GROUP\_READY\_TO\_BOOT** event group and begin to evaluate *Boot####* variables with Attributes set to **LOAD\_OPTION\_CATEGORY\_BOOT** according to the order defined by *BootOrder*. The *FilePathList* of variables marked **LOAD\_OPTION\_CATEGORY\_BOOT** shall not be evaluated prior to the completion of **EFI\_EVENT\_GROUP\_READY\_TO\_BOOT** event group processing.

## 3.2 Boot Manager Policy Protocol

### EFI\_BOOT\_MANAGER\_POLICY\_PROTOCOL

#### Summary

This protocol is used by EFI Applications to request the UEFI Boot Manager to connect devices using platform policy.

## GUID

```
#define EFI_BOOT_MANAGER_POLICY_PROTOCOL_GUID \
{ 0xFEDF8E0C, 0xE147, 0x11E3, \
  { 0x99, 0x03, 0xB8, 0xE8, 0x56, 0x2C, 0xBA, 0xFA } }
```

## Protocol Interface Structure

```
typedef struct _EFI_BOOT_MANAGER_POLICY_PROTOCOL
EFI_BOOT_MANAGER_POLICY_PROTOCOL;
struct _EFI_BOOT_MANAGER_POLICY_PROTOCOL {
  UINT64          Revision;
  EFI_BOOT_MANAGER_POLICY_CONNECT_DEVICE_PATH ConnectDevicePath;
  EFI_BOOT_MANAGER_POLICY_CONNECT_DEVICE_CLASS ConnectDeviceClass;
};
```

*ConnectDevicePath*      Connect a Device Path following the platforms EFI Boot Manager policy.

*ConnectDeviceClass*      Connect a class of devices, named by **EFI\_GUID**, following the platforms UEFI Boot Manager policy.

## Description

The **EFI\_BOOT\_MANAGER\_PROTOCOL** is produced by the platform firmware to expose Boot Manager policy and platform specific [EFI\\_BOOT\\_SERVICES.ConnectController\(\)](#) behavior.

## Related Definitions

```
#define EFI_BOOT_MANAGER_POLICY_PROTOCOL_REVISION 0x00010000
```

## EFI\_BOOT\_MANAGER\_PROTOCOL.ConnectDevicePath()

### Summary

Connect a device path following the platform's EFI Boot Manager policy.

```

Prototype
typedef
EFI_STATUS
(EFIAPI *EFI_BOOT_MANAGER_POLICY_CONNECT_DEVICE_PATH)(
  IN EFI_BOOT_MANAGER_POLICY_PROTOCOL *This,
  IN EFI_DEVICE_PATH *DevicePath,
  IN BOOLEAN Recursive
);

```

### Parameters

This	A pointer to the <b>EFI_BOOT_MANAGER_POLICY_PROTOCOL</b> instance. Type <b>EFI_BOOT_MANAGER_POLICY_PROTOCOL</b> defined above.
DevicePath	Points to the start of the EFI device path to connect. If <i>DevicePath</i> is NULL then all the controllers in the system will be connected using the platform's EFI Boot Manager policy.
Recursive	If <b>TRUE</b> , then <b>ConnectController()</b> is called recursively until the entire tree of controllers below the controller specified by <i>DevicePath</i> have been created. If <b>FALSE</b> , then the tree of controllers is only expanded one level. If <i>DevicePath</i> is NULL then <i>Recursive</i> is ignored.

### Description

The **ConnectDevicePath()** function allows the caller to connect a *DevicePath* using the same policy as the EFI Boot Manager.

If *Recursive* is **TRUE**, then **ConnectController()** is called recursively until the entire tree of controllers below the controller specified by *DevicePath* have been created. If *Recursive* is **FALSE**, then the tree of controllers is only expanded one level. If *DevicePath* is NULL then *Recursive* is ignored.

### Status Codes Returned

EFI_SUCCESS	The <i>DevicePath</i> was connected
EFI_NOT_FOUND	The <i>DevicePath</i> was not found
EFI_NOT_FOUND	No driver was connected to <i>DevicePath</i> .
EFI_SECURITY_VIOLATION	The user has no permission to start UEFI device drivers on the <i>DevicePath</i> .
EFI_UNSUPPORTED	The current TPL is not <a href="#">TPL_APPLICATION</a> .

## EFI\_BOOT\_MANAGER\_PROTOCOL.ConnectDeviceClass()

### Summary

Connect a class of devices using the platform Boot Manager policy.

### Prototype

```
typedef
EFI_STATUS
(EFI_API *EFI_BOOT_MANAGER_POLICY_CONNECT_DEVICE_CLASS)(
  IN EFI_BOOT_MANAGER_POLICY_PROTOCOL *This,
  IN EFI_GUID          *Class
);
```

### Parameters

<i>This</i>	A pointer to the <b>EFI_BOOT_MANAGER_POLICY_PROTOCOL</b> instance. Type <b>EFI_BOOT_MANAGER_POLICY_PROTOCOL</b> is defined above.
<i>Class</i>	A pointer to an <b>EFI_GUID</b> that represents a class of devices that will be connected using the Boot Manager's platform policy.

### Description

The **ConnectDeviceClass()** function allows the caller to request that the Boot Manager connect a class of devices.

If *Class* is **EFI\_BOOT\_MANAGER\_POLICY\_CONSOLE\_GUID** then the Boot Manager will use platform policy to connect consoles. Some platforms may restrict the number of consoles connected as they attempt to fast boot, and calling **ConnectDeviceClass()** with a *Class* value of **EFI\_BOOT\_MANAGER\_POLICY\_CONSOLE\_GUID** must connect the set of consoles that follow the Boot Manager platform policy, and the **EFI\_SIMPLE\_TEXT\_INPUT\_PROTOCOL**, **EFI\_SIMPLE\_TEXT\_INPUT\_EX\_PROTOCOL**, and the **EFI\_SIMPLE\_TEXT\_OUTPUT\_PROTOCOL** are produced on the connected handles. The Boot Manager may restrict which consoles get connect due to platform policy, for example a security policy may require that a given console is not connected.

If *Class* is **EFI\_BOOT\_MANAGER\_POLICY\_NETWORK\_GUID** then the Boot Manager will connect the protocols the platform supports for UEFI general purpose network applications on one or more handles. The protocols associated with UEFI general purpose network applications are defined in [Section 2.6.2](#), list item number 7. If more than one network controller is available a platform will connect, one, many, or all of the networks based on platform policy. Connecting UEFI networking protocols, like **EFI\_DHCP4\_PROTOCOL**, does not establish connections on the network. The UEFI general purpose network application that called **ConnectDeviceClass()** may need to use the published protocols to establish the network connection. The Boot Manager can optionally have a policy to establish a network connection.

If *Class* is **EFI\_BOOT\_MANAGER\_POLICY\_CONNECT\_ALL\_GUID** then the Boot Manager will connect all UEFI drivers using the UEFI Boot Service [EFI\\_BOOT\\_SERVICES.ConnectController\(\)](#). If the Boot Manager has policy associated with connect all UEFI drivers this policy will be used.

A platform can also define platform specific *Class* values as a properly generated **EFI\_GUID** would never conflict with this specification.

## Related Definitions

```
#define EFI_BOOT_MANAGER_POLICY_CONSOLE_GUID \
  { 0xCAB0E94C, 0xE15F, 0x11E3, \
    { 0x91, 0x8D, 0xB8, 0xE8, 0x56, 0x2C, 0xBA, 0xFA } }
#define EFI_BOOT_MANAGER_POLICY_NETWORK_GUID \
  { 0xD04159DC, 0xE15F, 0x11E3, \
    { 0xB2, 0x61, 0xB8, 0xE8, 0x56, 0x2C, 0xBA, 0xFA } }
#define EFI_BOOT_MANAGER_POLICY_CONNECT_ALL_GUID \
  { 0x113B2126, 0xFC8A, 0x11E3, \
    { 0xBD, 0x6C, 0xB8, 0xE8, 0x56, 0x2C, 0xBA, 0xFA } }
```

## Status Codes Returned

EFI_SUCCESS	At least one devices of the <i>Class</i> was connected.
EFI_DEVICE_ERROR	Devices were not connected due to an error.
EFI_NOT_FOUND	The <i>Class</i> is not supported by the platform.
EFI_UNSUPPORTED	The current TPL is not <a href="#">TPL APPLICATION</a> .

## 3.3 Globally Defined Variables

This section defines a set of variables that have architecturally defined meanings. In addition to the defined data content, each such variable has an architecturally defined attribute that indicates when the data variable may be accessed. The variables with an attribute of NV are nonvolatile. This means that their values are persistent across resets and power cycles. The value of any environment variable that does not have this attribute will be lost when power is removed from the system and the state of firmware reserved memory is not otherwise preserved. The variables with an attribute of BS are only available before [EFI\\_BOOT\\_SERVICES.ExitBootServices\(\)](#) is called. This means that these environment variables can only be retrieved or modified in the preboot environment. They are not visible to an operating system. Environment variables with an attribute of RT are available before and after [ExitBootServices\(\)](#) is called. Environment variables of this type can be retrieved and modified in the preboot environment, and from an operating system. The variables with an attribute of AT are variables with a time-based authenticated write access defined in [Section 8.2.1](#). All architecturally defined variables use the **EFI\_GLOBAL\_VARIABLE** *VendorGuid*:

```
#define EFI_GLOBAL_VARIABLE \
  {0x8BE4DF61,0x93CA,0x11d2,\
```

**{0xAA,0x0D,0x00,0xE0,0x98,0x03,0x2B,0x8C}**

To prevent name collisions with possible future globally defined variables, other internal firmware data variables that are not defined here must be saved with a unique *VendorGuid* other than **EFI\_GLOBAL\_VARIABLE** or any other GUID defined by the UEFI Specification. Implementations must only permit the creation of variables with a UEFI Specification-defined *VendorGuid* when these variables are documented in the UEFI Specification.

Table 10. Global Variables

Variable Name	Attribute	Description
AuditMode	BS, RT	Whether the system is operating in Audit Mode (1) or not (0). All other values are reserved. Should be treated as read-only except when DeployedMode is 0. Always becomes read-only after ExitBootServices() is called.
Boot####	NV, BS, RT	A boot load option. #### is a printed hex value. No 0x or h is included in the hex value.
BootCurrent	BS, RT	The boot option that was selected for the current boot.
BootNext	NV, BS, RT	The boot option for the next boot only.
BootOrder	NV, BS, RT	The ordered boot option load list.
BootOptionSupport	BS,RT,	The types of boot options supported by the boot manager. Should be treated as read-only.
ConIn	NV, BS, RT	The device path of the default input console.
ConInDev	BS, RT	The device path of all possible console input devices.
ConOut	NV, BS, RT	The device path of the default output console.
ConOutDev	BS, RT	The device path of all possible console output devices.
dbDefault	BS, RT	The OEM's default secure boot signature store. Should be treated as read-only.
dbrDefault	BS, RT	The OEM's default OS Recovery signature store. Should be treated as read-only.
dbtDefault	BS, RT	The OEM's default secure boot timestamp signature store. Should be treated as read-only.
dbxDefault	BS, RT	The OEM's default secure boot blacklist signature store. Should be treated as read-only.
DeployedMode	BS, RT	Whether the system is operating in Deployed Mode (1) or not (0). All other values are reserved. Should be treated as read-only when its value is 1. Always becomes read-only after ExitBootServices() is called.
Driver####	NV, BS, RT	A driver load option. #### is a printed hex value.
DriverOrder	NV, BS, RT	The ordered driver load option list.
ErrOut	NV, BS, RT	The device path of the default error output device.
ErrOutDev	BS, RT	The device path of all possible error output devices.
HwErrRecSupport	NV, BS, RT	Identifies the level of hardware error record persistence support implemented by the platform. This variable is only modified by firmware and is read-only to the OS.
KEK	NV, BS, RT,AT	The Key Exchange Key Signature Database.
KEKDefault	BS, RT	The OEM's default Key Exchange Key Signature Database. Should be treated as read-only.
Key####	NV, BS, RT	Describes hot key relationship with a Boot#### load option.
Lang	NV, BS, RT	The language code that the system is configured for. This value is deprecated.



Variable Name	Attribute	Description
LangCodes	BS, RT	The language codes that the firmware supports. This value is deprecated.
OsIndications	NV, BS, RT	Allows the OS to request the firmware to enable certain features and to take certain actions.
OsIndicationsSupported	BS, RT	Allows the firmware to indicate supported features and actions to the OS.
OsRecoveryOrder	BS,RT,NV,AT	OS-specified recovery options.
PK	NV, BS, RT,AT	The public Platform Key.
PKDefault	BS, RT	The OEM's default public Platform Key. Should be treated as read-only.
PlatformLangCodes	BS, RT	The language codes that the firmware supports.
PlatformLang	NV, BS, RT	The language code that the system is configured for.
PlatformRecovery####	BS, RT	Platform-specified recovery options. These variables are only modified by firmware and are read-only to the OS.
SignatureSupport	BS, RT	Array of GUIDs representing the type of signatures supported by the platform firmware. Should be treated as read-only.
SecureBoot	BS, RT	Whether the platform firmware is operating in Secure boot mode (1) or not (0). All other values are reserved. Should be treated as read-only.
SetupMode	BS, RT	Whether the system should require authentication on SetVariable() requests to Secure Boot policy variables (0) or not (1). Should be treated as read-only. The system is in "Setup Mode" when SetupMode==1, AuditMode==0, and DeployedMode==0.
SysPrep####	NV, BS, RT	A System Prep application load option containing a <b>EFI_LOAD_OPTION</b> descriptor. #### is a printed hex value.
SysPrepOrder	NV, BS, RT	The ordered System Prep Application load option list.
Timeout	NV, BS, RT	The firmware's boot managers timeout, in seconds, before initiating the default boot selection.
VendorKeys	BS, RT	Whether the system is configured to use only vendor-provided keys or not. Should be treated as read-only.

The *PlatformLangCodes* variable contains a null-terminated ASCII string representing the language codes that the firmware can support. At initialization time the firmware computes the supported languages and creates this data variable. Since the firmware creates this value on each initialization, its contents are not stored in nonvolatile memory. This value is considered read-only. *PlatformLangCodes* is specified in Native RFC 4646 format. See [Appendix M](#). *LangCodes* is deprecated and may be provided for backwards compatibility.

The *PlatformLang* variable contains a null-terminated ASCII string language code that the machine has been configured for. This value may be changed to any value supported by *PlatformLangCodes*. If this change is made in the preboot environment, then the

change will take effect immediately. If this change is made at OS runtime, then the change does not take effect until the next boot. If the language code is set to an unsupported value, the firmware will choose a supported default at initialization and set *PlatformLang* to a supported value. *PlatformLang* is specified in Native RFC 4646 array format. See [Appendix M](#). *Lang* is deprecated and may be provided for backwards compatibility.

*Lang* has been deprecated. If the platform supports this variable, it must map any changes in the *Lang* variable into *PlatformLang* in the appropriate format.

*Langcodes* has been deprecated. If the platform supports this variable, it must map any changes in the *Langcodes* variable into *PlatformLang* in the appropriate format.

The *Timeout* variable contains a binary **UINT16** that supplies the number of seconds that the firmware will wait before initiating the original default boot selection. A value of 0 indicates that the default boot selection is to be initiated immediately on boot. If the value is not present, or contains the value of 0xFFFF then firmware will wait for user input before booting. This means the default boot selection is not automatically started by the firmware.

The *ConIn*, *ConOut*, and *ErrOut* variables each contain an [EFI\\_DEVICE\\_PATH\\_PROTOCOL](#) descriptor that defines the default device to use on boot. Changes to these values made in the preboot environment take effect immediately. Changes to these values at OS runtime do not take effect until the next boot. If the firmware cannot resolve the device path, it is allowed to automatically replace the values, as needed, to provide a console for the system. If the device path starts with a USB Class device path (see [Table 63](#)), then any input or output device that matches the device path must be used as a console if it is supported by the firmware.

The *ConInDev*, *ConOutDev*, and *ErrOutDev* variables each contain an **EFI\_DEVICE\_PATH\_PROTOCOL** descriptor that defines all the possible default devices to use on boot. These variables are volatile, and are set dynamically on every boot. *ConIn*, *ConOut*, and *ErrOut* are always proper subsets of *ConInDev*, *ConOutDev*, and *ErrOutDev*.

Each *Boot####* variable contains an **EFI\_LOAD\_OPTION**. Each *Boot####* variable is the name "Boot" appended with a unique four digit hexadecimal number. For example, Boot0001, Boot0002, Boot0A02, etc.

The *OsRecoveryOrder* variable contains an array of **EFI\_GUID** structures. Each **EFI\_GUID** structure specifies a namespace for variables containing OS-defined recovery entries (see [Section 3.4.1](#)). Write access to this variable is controlled by the security key database dbr (see [Section 8.2.1](#)).

*PlatformRecovery####* variables share the same structure as *Boot####* variables. These variables are processed when the system is performing recovery of boot options

The *BootOrder* variable contains an array of **UINT16**'s that make up an ordered list of the *Boot####* options. The first element in the array is the value for the first logical boot option, the second element is the value for the second logical boot option, etc. The *BootOrder* order list is used by the firmware's boot manager as the default boot order.

The *BootNext* variable is a single **UINT16** that defines the *Boot####* option that is to be tried first on the next boot. After the *BootNext* boot option is tried the normal *BootOrder* list is used. To prevent loops, the boot manager deletes this variable before transferring control to the preselected boot option.

The *BootCurrent* variable is a single **UINT16** that defines the *Boot####* option that was selected on the current boot.

The *BootOptionSupport* variable is a **UINT32** that defines the types of boot options supported by the boot manager.

Each *Driver####* variable contains an **EFI\_LOAD\_OPTION**. Each load option variable is appended with a unique number, for example *Driver0001*, *Driver0002*, etc.

The *DriverOrder* variable contains an array of **UINT16**'s that make up an ordered list of the *Driver####* variable. The first element in the array is the value for the first logical driver load option, the second element is the value for the second logical driver load option, etc. The *DriverOrder* list is used by the firmware's boot manager as the default load order for UEFI drivers that it should explicitly load.

The *Key####* variable associates a key press with a single boot option. Each *Key####* variable is the name "Key" appended with a unique four digit hexadecimal number. For example, *Key0001*, *Key0002*, *Key00A0*, etc.

The *HwErrRecSupport* variable contains a binary **UINT16** that supplies the level of support for Hardware Error Record Persistence (see [Section 8.2.4](#)) that is implemented by the platform. If the value is not present, then the platform implements no support for Hardware Error Record Persistence. A value of zero indicates that the platform implements no support for Hardware Error Record Persistence. A value of 1 indicates that the platform implements Hardware Error Record Persistence as defined in [Section 8.2.4](#). Firmware initializes this variable. All other values are reserved for future use.

The *SetupMode* variable is an 8-bit unsigned integer that defines whether the system is should require authentication (0) or not (1) on **SetVariable()** requests to Secure Boot Policy Variables. Secure Boot Policy Variables include:

- The global variables *PK*, *KEK*, and *OsRecoveryOrder*
- All variables named *OsRecovery####* under all VendorGuids
- All variables with the VendorGuid **EFI\_IMAGE\_SECURITY\_DATABASE\_GUID**.

Secure Boot Policy Variables must be created using the **EFI\_VARIABLE\_AUTHENTICATION\_2** structure.

The *AuditMode* variable is an 8-bit unsigned integer that defines whether the system is currently operating in Audit Mode.

The *DeployedMode* variable is an 8-bit unsigned integer that defines whether the system is currently operating in Deployed Mode.

The *KEK* variable contains the current Key Exchange Key database.

The *PK* variable contains the current Platform Key.

The *VendorKeys* variable is an 8-bit unsigned integer that defines whether the Security Boot Policy Variables have been modified by anyone other than the platform vendor or a holder of the vendor-provided keys. A value of 0 indicates that someone other than the platform vendor or a holder of the vendor-provided keys has modified the Secure Boot Policy Variables Otherwise, the value will be 1.

The *KEKDefault* variable, if present, contains the platform-defined Key Exchange Key database. This is not used at runtime but is provided in order to allow the OS to recover

the OEM's default key setup. The contents of this variable do not include an **EFI\_VARIABLE\_AUTHENTICATION** or **EFI\_VARIABLE\_AUTHENTICATION2** structure.

The *PKDefault* variable, if present, contains the platform-defined Platform Key. This is not used at runtime but is provided in order to allow the OS to recover the OEM's default key setup. The contents of this variable do not include an **EFI\_VARIABLE\_AUTHENTICATION2** structure.

The *dbDefault* variable, if present, contains the platform-defined secure boot signature database. This is not used at runtime but is provided in order to allow the OS to recover the OEM's default key setup. The contents of this variable do not include an **EFI\_VARIABLE\_AUTHENTICATION2** structure.

The *dbrDefault* variable, if present, contains the platform-defined secure boot authorized recovery signature database. This is not used at runtime but is provided in order to allow the OS to recover the OEM's default key setup. The contents of this variable do not include an **EFI\_VARIABLE\_AUTHENTICATION2** structure.

The *dbtDefault* variable, if present, contains the platform-defined secure boot timestamp signature database. This is not used at runtime but is provided in order to allow the OS to recover the OEM's default key setup. The contents of this variable do not include an **EFI\_VARIABLE\_AUTHENTICATION2** structure.

The *dbxDefault* variable, if present, contains the platform-defined secure boot blacklist signature database. This is not used at runtime but is provided in order to allow the OS to recover the OEM's default key setup. The contents of this variable do not include an **EFI\_VARIABLE\_AUTHENTICATION2** structure.

The *SignatureSupport* variable returns an array of GUIDs, with each GUID representing a type of signature which the platform firmware supports for images and other data. The different signature types are described in "Signature Database".

The *SecureBoot* variable is an 8-bit unsigned integer that defines whether the platform firmware is operating with Secure Boot enabled. A value of 1 indicates that platform firmware performs driver and boot application signature verification as specified in [UEFI Image Validation](#) during the current boot. A value of 0 indicates that driver and boot application signature verification is not active during the current boot. The SecureBoot variable is initialized prior to Secure Boot image authentication and thereafter should be treated as read-only and immutable. Its initialization value is determined by platform policy but must be 0 if the platform is in Setup Mode or Audit Mode during its initialization.

The *OsIndicationsSupported* variable indicates which of the OS indication features and actions that the firmware supports. This variable is recreated by firmware every boot, and cannot be modified by the OS (see **SetVariable()** Attributes usage rules once **ExitBootServices()** is performed).

The *OsIndications* variable is used to indicate which features the OS wants firmware to enable or which actions the OS wants the firmware to take. The OS will supply this data with a **SetVariable()** call. See [Section 8.5.4](#) for the variable definition.

## 3.4 Boot Option Recovery

Boot option recovery consists of two independent parts, *operating system-defined* recovery and *platform-defined* recovery. OS-defined recovery is an attempt to allow installed operating systems to recover any needed boot options, or to launch full operating system recovery. Platform-defined recovery includes any remedial actions performed by the platform as a last resort when no operating system is found, such as the *Default Boot Behavior* (see [Section 3.4.3](#)). This could include behaviors such as warranty service reconfiguration or diagnostic options.

In the event that boot option recovery must be performed, the boot manager must first attempt OS-defined recovery, re-attempt normal booting via *Boot####* and *BootOrder* variables, and finally attempt platform-defined recovery if no options have succeeded.

### 3.4.1 OS-Defined Boot Option Recovery

If the **EFI\_OS\_INDICATIONS\_START\_OS\_RECOVERY** bit is set in *OsIndications*, or if processing of *BootOrder* does not result in success, the platform must process OS-defined recovery options. In the case where OS-defined recovery is entered due to *OsIndications*, *SysPrepOrder* and *SysPrep####* variables should not be processed. Note that in order to avoid ambiguity in intent, this bit is ignored in *OsIndications* if **EFI\_OS\_INDICATIONS\_START\_PLATFORM\_RECOVERY** is set.

OS-defined recovery uses the *OsRecoveryOrder* variable, as well as variables created with vendor specific *VendorGuid* values and a name following the pattern *OsRecovery####*. Each of these variables must be an authenticated variable with the **EFI\_VARIABLE\_TIME\_BASED\_AUTHENTICATED\_WRITE\_ACCESS** attribute set.

To process these variables, the boot manager iterates over the array of *EFI\_GUID* structures in the *OsRecoveryOrder* variable, and each GUID specified is treated as a *VendorGuid* associated with a series of variable names. For each GUID, the firmware attempts to load and execute, in hexadecimal sort order, every variable with that GUID and a name following the pattern *OsRecovery####*. These variables have the same format as *Boot####* variables, and the boot manager must verify that each variable it attempts to load was created with a public key that is associated with a certificate chaining to one listed in the authorized recovery signature database *dbf* and not in the forbidden signature database, or is created by a key in the Key Exchange Key database *KEK* or the current Platform Key *PK*.

If the boot manager finishes processing *OsRecovery####* options without [EFI\\_BOOT\\_SERVICES.ExitBootServices\(\)](#) or [ResetSystem\(\)](#) having been called, it must attempt to process *BootOrder* a second time. If booting does not succeed during that process, OS-defined recovery has failed, and the boot manager must attempt platform-based recovery.

If, while processing *OsRecovery####* variables, the boot manager encounters an entry which cannot be loaded or executed due to a security policy violation, it must ignore that variable.

### 3.4.2 Platform-Defined Boot Option Recovery

If the **EFI\_OS\_INDICATIONS\_START\_PLATFORM\_RECOVERY** bit is set in *OsIndications*, or if OS-defined recovery has failed, the system firmware must commence with platform-specific recovery by iterating its *PlatformRecovery####* variables in the same manner as *OsRecovery####*, but must stop processing if any entry is successful. In the case where platform-specific recovery is entered due to *OsIndications*, *SysPrepOrder* and *SysPrep####* variables should not be processed.

### 3.4.3 Boot Option Variables Default Boot Behavior

The default state of globally-defined variables is firmware vendor specific. However the boot options require a standard default behavior in the exceptional case that valid boot options are not present on a platform. The default behavior must be invoked any time the *BootOrder* variable does not exist or only points to nonexistent boot options, or if no entry in *BootOrder* can successfully be executed.

If system firmware supports boot option recovery as described in [Section 3.4](#), system firmware must include a *PlatformRecovery####* variable specifying a short-form File Path Media Device Path (see [Section 3.1.2](#)) containing the platform default file path for removable media (see [Table 11](#)). It is recommended for maximal compatibility with prior versions of this specification that this entry be the first such variable, though it may be at any position within the list.

It is expected that this default boot will load an operating system or a maintenance utility. If this is an operating system setup program it is then responsible for setting the requisite environment variables for subsequent boots. The platform firmware may also decide to recover or set to a known set of boot options.

## 3.5 Boot Mechanisms

EFI can boot from a device using the **EFI\_SIMPLE\_FILE\_SYSTEM\_PROTOCOL** or the **EFI\_LOAD\_FILE\_PROTOCOL**. A device that supports the **EFI\_SIMPLE\_FILE\_SYSTEM\_PROTOCOL** must materialize a file system protocol for that device to be bootable. If a device does not wish to support a complete file system it may produce an **EFI\_LOAD\_FILE\_PROTOCOL** which allows it to materialize an image directly. The Boot Manager will attempt to boot using the **EFI\_SIMPLE\_FILE\_SYSTEM\_PROTOCOL** first. If that fails, then the **EFI\_LOAD\_FILE\_PROTOCOL** will be used.

### 3.5.1 Boot via the Simple File Protocol

When booting via the **EFI\_SIMPLE\_FILE\_SYSTEM\_PROTOCOL**, the *FilePath* will start with a device path that points to the device that implements the **EFI\_SIMPLE\_FILE\_SYSTEM\_PROTOCOL** or the **EFI\_BLOCK\_IO\_PROTOCOL**. The next part of the *FilePath* may point to the file name, including subdirectories, which contain the bootable image. If the file name is a null device path, the file name must be generated from the rules defined below.



If the `FilePathList[0]` device does not support the **EFI\_SIMPLE\_FILE\_SYSTEM\_PROTOCOL**, but supports the **EFI\_BLOCK\_IO\_PROTOCOL** protocol, then the EFI Boot Service [EFI\\_BOOT\\_SERVICES.ConnectController\(\)](#) must be called for `FilePathList[0]` with `DriverImageHandle` and `RemainingDevicePath` set to **NULL** and the `Recursive` flag is set to **TRUE**. The firmware will then attempt to boot from any child handles produced using the algorithms outlined below.

The format of the file system specified is contained in [Section 13.3](#). While the firmware must produce an **EFI\_SIMPLE\_FILE\_SYSTEM\_PROTOCOL** that understands the UEFI file system, any file system can be abstracted with the **EFI\_SIMPLE\_FILE\_SYSTEM\_PROTOCOL** interface.

### 3.5.1.1 Removable Media Boot Behavior

To generate a file name when none is present in the `FilePath`, the firmware must append a default file name in the form `\EFI\BOOT\BOOT{machine type short-name}.EFI` where machine type short-name defines a PE32+ image format architecture. Each file only contains one UEFI image type, and a system may support booting from one or more images types. [Table 11](#) lists the UEFI image types.

Table 11. UEFI Image Types

	File Name Convention	PE Executable Machine Type *
32-bit	BOOTIA32.EFI	0x14c
x64	BOOTx64.EFI	0x8664
Itanium architecture	BOOTIA64.EFI	0x200
AArch32 architecture	BOOTARM.EFI	0x01c2
AArch64 architecture	BOOTAA64.EFI	0xAA64
Note: * The PE Executable machine type is contained in the machine field of the COFF file header as defined in the Microsoft Portable Executable and Common Object File Format Specification, Revision 6.0		

Media may support multiple architectures by simply having a `\EFI\BOOT\BOOT{machine type short-name}.EFI` file of each possible machine type.

### 3.5.2 Boot via the Load File Protocol

When booting via the **EFI\_LOAD\_FILE\_PROTOCOL** protocol, the `FilePath` is a device path that points to a device that “speaks” the **EFI\_LOAD\_FILE\_PROTOCOL**. The image is loaded directly from the device that supports the **EFI\_LOAD\_FILE\_PROTOCOL**. The remainder of the `FilePath` will contain information that is specific to the device. Firmware passes this device-specific data to the loaded image, but does not use it to load the image. If the remainder of the `FilePath` is a null device path it is the loaded image's responsibility to implement a policy to find the correct boot device.

The **EFI\_LOAD\_FILE\_PROTOCOL** is used for devices that do not directly support file systems. Network devices commonly boot in this model where the image is materialized without the need of a file system.

### 3.5.2.1 Network Booting

Network booting is described by the *Preboot eXecution Environment (PXE) BIOS Support Specification* that is part of the *Wired for Management Baseline specification*. PXE specifies UDP, DHCP, and TFTP network protocols that a booting platform can use to interact with an intelligent system load server. UEFI defines special interfaces that are used to implement PXE. These interfaces are contained in the **EFI\_PXE\_BASE\_CODE\_PROTOCOL** ( see [Section 24.3](#)).

### 3.5.2.2 Future Boot Media

Since UEFI defines an abstraction between the platform and the OS and its loader it should be possible to add new types of boot media as technology evolves. The OS loader will not necessarily have to change to support new types of boot. The implementation of the UEFI platform services may change, but the interface will remain constant. The OS will require a driver to support the new type of boot media so that it can make the transition from UEFI boot services to OS control of the boot media.



## 4 EFI System Table

---

This section describes the entry point to a UEFI image and the parameters that are passed to that entry point. There are three types of UEFI images that can be loaded and executed by firmware conforming to this specification. These are UEFI applications (see [Section 2.1.2](#)), UEFI boot service drivers (see [Section 2.1.4](#)), and UEFI runtime drivers (see [Section 2.1.4](#)). UEFI applications include UEFI OS loaders (see [Section 2.1.3](#)). There are no differences in the entry point for these three image types.

### 4.1 UEFI Image Entry Point

The most significant parameter that is passed to an image is a pointer to the System Table. This pointer is [EFI\\_IMAGE\\_ENTRY\\_POINT](#) (see definition immediately below), the main entry point for a UEFI Image. The System Table contains pointers to the active console devices, a pointer to the Boot Services Table, a pointer to the Runtime Services Table, and a pointer to the list of system configuration tables such as ACPI, SMBIOS, and the SAL System Table. This section describes the System Table in detail.

#### EFI\_IMAGE\_ENTRY\_POINT

##### Summary

This is the main entry point for a UEFI Image. This entry point is the same for UEFI applications and UEFI drivers.

##### Prototype

```
typedef
EFI_STATUS
(EFI_API *EFI_IMAGE_ENTRY_POINT) (
    IN EFI_HANDLE ImageHandle,
    IN EFI_SYSTEM_TABLE *SystemTable
);
```

##### Parameters

<i>ImageHandle</i>	The firmware allocated handle for the UEFI image.
<i>SystemTable</i>	A pointer to the EFI System Table.

##### Description

This function is the entry point to an EFI image. An EFI image is loaded and relocated in system memory by the EFI Boot Service [EFI\\_BOOT\\_SERVICES.LoadImage\(\)](#). An EFI image is invoked through the EFI Boot Service [EFI\\_BOOT\\_SERVICES.StartImage\(\)](#).

The first argument is the image's image handle. The second argument is a pointer to the image's system table. The system table contains the standard output and input handles, plus pointers to the [EFI\\_BOOT\\_SERVICES](#) and [EFI\\_RUNTIME\\_SERVICES](#) tables. The

service tables contain the entry points in the firmware for accessing the core EFI system functionality. The handles in the system table are used to obtain basic access to the console. In addition, the System Table contains pointers to other standard tables that a loaded image may use if the associated pointers are initialized to nonzero values. Examples of such tables are ACPI, SMBIOS, SAL System Table, etc.

The *ImageHandle* is a firmware-allocated handle that is used to identify the image on various functions. The handle also supports one or more protocols that the image can use. All images support the **EFI\_LOADED\_IMAGE\_PROTOCOL** and the **EFI\_LOADED\_IMAGE\_DEVICE\_PATH\_PROTOCOL** that returns the source location of the image, the memory location of the image, the load options for the image, etc. The exact **EFI\_LOADED\_IMAGE\_PROTOCOL** and **EFI\_LOADED\_IMAGE\_DEVICE\_PATH\_PROTOCOL** structures are defined in [Section 9](#).

If the UEFI image is a UEFI application that is not a UEFI OS loader, then the application executes and either returns or calls the EFI Boot Services [EFI\\_BOOT\\_SERVICES.Exit\(\)](#). A UEFI application is always unloaded from memory when it exits, and its return status is returned to the component that started the UEFI application.

If the UEFI image is a UEFI OS Loader, then the UEFI OS Loader executes and either returns, calls the EFI Boot Service **Exit()**, or calls the EFI Boot Service [EFI\\_BOOT\\_SERVICES.ExitBootServices\(\)](#). If the EFI OS Loader returns or calls **Exit()**, then the load of the OS has failed, and the EFI OS Loader is unloaded from memory and control is returned to the component that attempted to boot the UEFI OS Loader. If [ExitBootServices\(\)](#) is called, then the UEFI OS Loader has taken control of the platform, and EFI will not regain control of the system until the platform is reset. One method of resetting the platform is through the EFI Runtime Service [ResetSystem\(\)](#).

If the UEFI image is a UEFI Driver, then the UEFI driver executes and either returns or calls the Boot Service **Exit()**. If the UEFI driver returns an error, then the driver is unloaded from memory. If the UEFI driver returns **EFI\_SUCCESS**, then it stays resident in memory. If the UEFI driver does not follow the UEFI Driver Model, then it performs any required initialization and installs its protocol services before returning. If the driver does follow the UEFI Driver Model, then the entry point is not allowed to touch any device hardware. Instead, the entry point is required to create and install the [EFI DRIVER BINDING PROTOCOL](#) (see [Section 11.1](#)) on the *ImageHandle* of the UEFI driver. If this process is completed, then **EFI\_SUCCESS** is returned. If the resources are not available to complete the UEFI driver initialization, then **EFI\_OUT\_OF\_RESOURCES** is returned.

## Status Codes Returned

EFI_SUCCESS	The driver was initialized.
EFI_OUT_OF_RESOURCES	The request could not be completed due to a lack of resources.

## 4.2 EFI Table Header

The data type **EFI\_TABLE\_HEADER** is the data structure that precedes all of the standard EFI table types. It includes a signature that is unique for each table type, a revision of the

table that may be updated as extensions are added to the EFI table types, and a 32-bit CRC so a consumer of an EFI table type can validate the contents of the EFI table.

## EFI\_TABLE\_HEADER

### Summary

Data structure that precedes all of the standard EFI table types.

### Related Definitions

```
typedef struct {
    UINT64 Signature;
    UINT32 Revision;
    UINT32 HeaderSize;
    UINT32 CRC32;
    UINT32 Reserved;
} EFI_TABLE_HEADER;
```

### Parameters

#### *Signature*

A 64-bit signature that identifies the type of table that follows. Unique signatures have been generated for the EFI System Table, the EFI Boot Services Table, and the EFI Runtime Services Table.

#### *Revision*

The revision of the EFI Specification to which this table conforms. The upper 16 bits of this field contain the major revision value, and the lower 16 bits contain the minor revision value. The minor revision values are binary coded decimals and are limited to the range of 00..99.

When printed or displayed UEFI spec revision is referred as (Major revision).(Minor revision upper decimal).(Minor revision lower decimal) or (Major revision).(Minor revision upper decimal) in case Minor revision lower decimal is set to 0. For example:

A specification with the revision value ((2<<16) | (30)) would be referred as 2.3;

A specification with the revision value ((2<<16) | (31)) would be referred as 2.3.1

#### *HeaderSize*

The size, in bytes, of the entire table including the **EFI\_TABLE\_HEADER**.

#### *CRC32*

The 32-bit CRC for the entire table. This value is computed by setting this field to 0, and computing the 32-bit CRC for *HeaderSize* bytes.

#### *Reserved*

Reserved field that must be set to 0.

**Note:** *The capabilities found in the EFI system table, runtime table and boot services table may change over time. The first field in each of these tables is an EFI\_TABLE\_HEADER. This header's Revision*

*field is incremented when new capabilities and functions are added to the functions in the table. When checking for capabilities, code should verify that Revision is greater than or equal to the revision level of the table at the point when the capabilities were added to the UEFI specification.*

**Note:** *Unless otherwise specified, UEFI uses a standard CCITT32 CRC algorithm with a seed polynomial value of 0x04c11db7 for its CRC calculations.*

**Note:** *The size of the system table, runtime services table, and boot services table may increase over time. It is very important to always use the **HeaderSize** field of the **EFI\_TABLE\_HEADER** to determine the size of these tables.*

## 4.3 EFI System Table

UEFI uses the EFI System Table, which contains pointers to the runtime and boot services tables. The definition for this table is shown in the following code fragments. Except for the table header, all elements in the service tables are pointers to functions as defined in [Section 7](#) and [Section 8](#). Prior to a call to [EFI\\_BOOT\\_SERVICES.ExitBootServices\(\)](#), all of the fields of the EFI System Table are valid. After an operating system has taken control of the platform with a call to [ExitBootServices\(\)](#), only the *Hdr*, *FirmwareVendor*, *FirmwareRevision*, *RuntimeServices*, *NumberOfTableEntries*, and *ConfigurationTable* fields are valid.

### EFI\_SYSTEM\_TABLE

#### Summary

Contains pointers to the runtime and boot services tables.

#### Related Definitions

```
#define EFI_SYSTEM_TABLE_SIGNATURE 0x5453595320494249
#define EFI_2_70_SYSTEM_TABLE_REVISION ((2<<16) | (70))
#define EFI_2_60_SYSTEM_TABLE_REVISION ((2<<16) | (60))
#define EFI_2_50_SYSTEM_TABLE_REVISION ((2<<16) | (50))
#define EFI_2_40_SYSTEM_TABLE_REVISION ((2<<16) | (40))
#define EFI_2_31_SYSTEM_TABLE_REVISION ((2<<16) | (31))
#define EFI_2_30_SYSTEM_TABLE_REVISION ((2<<16) | (30))
#define EFI_2_20_SYSTEM_TABLE_REVISION ((2<<16) | (20))
#define EFI_2_10_SYSTEM_TABLE_REVISION ((2<<16) | (10))
#define EFI_2_00_SYSTEM_TABLE_REVISION ((2<<16) | (00))
#define EFI_1_10_SYSTEM_TABLE_REVISION ((1<<16) | (10))
#define EFI_1_02_SYSTEM_TABLE_REVISION ((1<<16) | (02))
#define EFI_SPECIFICATION_VERSION EFI_SYSTEM_TABLE_REVISION
#define EFI_SYSTEM_TABLE_REVISION EFI_2_70_SYSTEM_TABLE_REVISION

typedef struct {
    EFI_TABLE_HEADER    Hdr;
    CHAR16              *FirmwareVendor;
    UINT32              FirmwareRevision;
```

```

EFI_HANDLE      ConsoleInHandle;
EFI_SIMPLE_TEXT_INPUT_PROTOCOL *ConIn;
EFI_HANDLE      ConsoleOutHandle;
EFI_SIMPLE_TEXT_OUTPUT_PROTOCOL *ConOut;
EFI_HANDLE      StandardErrorHandle;
EFI_SIMPLE_TEXT_OUTPUT_PROTOCOL *StdErr;
EFI_RUNTIME_SERVICES *RuntimeServices;
EFI_BOOT_SERVICES *BootServices;
UINTN           NumberOfTableEntries;
EFI_CONFIGURATION_TABLE *ConfigurationTable;
} EFI_SYSTEM_TABLE;

```

## Parameters

<i>Hdr</i>	The table header for the EFI System Table. This header contains the <b>EFI_SYSTEM_TABLE_SIGNATURE</b> and <b>EFI_SYSTEM_TABLE_REVISION</b> values along with the size of the <b>EFI_SYSTEM_TABLE</b> structure and a 32-bit CRC to verify that the contents of the EFI System Table are valid.
<i>FirmwareVendor</i>	A pointer to a null terminated string that identifies the vendor that produces the system firmware for the platform.
<i>FirmwareRevision</i>	A firmware vendor specific value that identifies the revision of the system firmware for the platform.
<i>ConsoleInHandle</i>	The handle for the active console input device. This handle must support <b>EFI_SIMPLE_TEXT_INPUT_PROTOCOL</b> and <b>EFI_SIMPLE_TEXT_INPUT_EX_PROTOCOL</b> .
<i>ConIn</i>	A pointer to the <b>EFI_SIMPLE_TEXT_INPUT_PROTOCOL</b> interface that is associated with <i>ConsoleInHandle</i> .
<i>ConsoleOutHandle</i>	The handle for the active console output device. This handle must support the <b>EFI_SIMPLE_TEXT_OUTPUT_PROTOCOL</b> .
<i>ConOut</i>	A pointer to the <b>EFI_SIMPLE_TEXT_OUTPUT_PROTOCOL</b> interface that is associated with <i>ConsoleOutHandle</i> .
<i>StandardErrorHandle</i>	The handle for the active standard error console device. This handle must support the <b>EFI_SIMPLE_TEXT_OUTPUT_PROTOCOL</b> .
<i>StdErr</i>	A pointer to the <b>EFI_SIMPLE_TEXT_OUTPUT_PROTOCOL</b> interface that is associated with <i>StandardErrorHandle</i> .
<i>RuntimeServices</i>	A pointer to the EFI Runtime Services Table. See <a href="#">Section 4.5</a> .
<i>BootServices</i>	A pointer to the EFI Boot Services Table. See <a href="#">Section 4.4</a> .
<i>NumberOfTableEntries</i>	The number of system configuration tables in the buffer <i>ConfigurationTable</i> .

*ConfigurationTable* A pointer to the system configuration tables. The number of entries in the table is *NumberOfTableEntries*.

## 4.4 EFI Boot Services Table

UEFI uses the EFI Boot Services Table, which contains a table header and pointers to all of the boot services. The definition for this table is shown in the following code fragments. Except for the table header, all elements in the EFI Boot Services Tables are prototypes of function pointers to functions as defined in [Section 7](#). The function pointers in this table are not valid after the operating system has taken control of the platform with a call to [EFI\\_BOOT\\_SERVICES.ExitBootServices\(\)](#).

### EFI\_BOOT\_SERVICES

#### Summary

Contains a table header and pointers to all of the boot services.

#### Related Definitions

```
#define EFI_BOOT_SERVICES_SIGNATURE 0x56524553544f4f42
#define EFI_BOOT_SERVICES_REVISION  EFI_SPECIFICATION_VERSION

typedef struct {
  EFI_TABLE_HEADER  Hdr;

  //
  // Task Priority Services
  //
  EFI_RAISE_TPL      RaiseTPL;      // EFI 1.0+
  EFI_RESTORE_TPL    RestoreTPL;    // EFI 1.0+

  //
  // Memory Services
  //
  EFI_ALLOCATE_PAGES  AllocatePages; // EFI 1.0+
  EFI_FREE_PAGES      FreePages;      // EFI 1.0+
  EFI_GET_MEMORY_MAP  GetMemoryMap;   // EFI 1.0+
  EFI_ALLOCATE_POOL   AllocatePool;   // EFI 1.0+
  EFI_FREE_POOL       FreePool;       // EFI 1.0+

  //
  // Event & Timer Services
  //
  EFI_CREATE_EVENT    CreateEvent;    // EFI 1.0+
```

```

EFI_SET_TIMER      SetTimer;      // EFI 1.0+
EFI_WAIT_FOR_EVENT  WaitForEvent; // EFI 1.0+
EFI_SIGNAL_EVENT    SignalEvent;   // EFI 1.0+
EFI_CLOSE_EVENT     CloseEvent;    // EFI 1.0+
EFI_CHECK_EVENT     CheckEvent;    // EFI 1.0+

//
// Protocol Handler Services
//
EFI_INSTALL_PROTOCOL_INTERFACE InstallProtocolInterface; // EFI 1.0+
EFI_REINSTALL_PROTOCOL_INTERFACE ReinstallProtocolInterface; // EFI 1.0+
EFI_UNINSTALL_PROTOCOL_INTERFACE UninstallProtocolInterface; // EFI 1.0+
EFI_HANDLE_PROTOCOL   HandleProtocol; // EFI 1.0+
VOID*                 Reserved; // EFI 1.0+
EFI_REGISTER_PROTOCOL_NOTIFY RegisterProtocolNotify; // EFI 1.0+
EFI_LOCATE_HANDLE     LocateHandle; // EFI 1.0+
EFI_LOCATE_DEVICE_PATH LocateDevicePath; // EFI 1.0+
EFI_INSTALL_CONFIGURATION_TABLE InstallConfigurationTable; // EFI 1.0+

//
// Image Services
//
EFI_IMAGE_LOAD      LoadImage;      // EFI 1.0+
EFI_IMAGE_START     StartImage;     // EFI 1.0+
EFI_EXIT            Exit;            // EFI 1.0+
EFI_IMAGE_UNLOAD    UnloadImage;    // EFI 1.0+
EFI_EXIT_BOOT_SERVICES ExitBootServices; // EFI 1.0+

//
// Miscellaneous Services
//
EFI_GET_NEXT_MONOTONIC_COUNT GetNextMonotonicCount; // EFI 1.0+
EFI_STALL                Stall;                // EFI 1.0+
EFI_SET_WATCHDOG_TIMER   SetWatchdogTimer; // EFI 1.0+

//
// DriverSupport Services
//
EFI_CONNECT_CONTROLLER ConnectController; // EFI 1.1
EFI_DISCONNECT_CONTROLLER DisconnectController; // EFI 1.1+

```

```

//
// Open and Close Protocol Services
//
EFI_OPEN_PROTOCOL      OpenProtocol;    // EFI 1.1+
EFI_CLOSE_PROTOCOL     CloseProtocol;   // EFI 1.1+
EFI_OPEN_PROTOCOL_INFORMATION  OpenProtocolInformation; // EFI 1.1+

//
// Library Services
//
EFI_PROTOCOLS_PER_HANDLE  ProtocolsPerHandle; // EFI 1.1+
EFI_LOCATE_HANDLE_BUFFER  LocateHandleBuffer; // EFI 1.1+
EFI_LOCATE_PROTOCOL       LocateProtocol;    // EFI 1.1+
EFI_INSTALL_MULTIPLE_PROTOCOL_INTERFACES  InstallMultipleProtocolInterfaces;
// EFI 1.1+
EFI_UNINSTALL_MULTIPLE_PROTOCOL_INTERFACES  UninstallMultipleProtocolInterfaces
; // EFI 1.1+

//
// 32-bit CRC Services
//
EFI_CALCULATE_CRC32      CalculateCrc32;    // EFI 1.1+

//
// Miscellaneous Services
//
EFI_COPY_MEM             CopyMem;          // EFI 1.1+
EFI_SET_MEM              SetMem;          // EFI 1.1+
EFI_CREATE_EVENT_EX      CreateEventEx;    // UEFI 2.0+
} EFI_BOOT_SERVICES;

```

## Parameters

<i>Hdr</i>	The table header for the EFI Boot Services Table. This header contains the <b>EFI_BOOT_SERVICES_SIGNATURE</b> and <b>EFI_BOOT_SERVICES_REVISION</b> values along with the size of the <b>EFI_BOOT_SERVICES</b> structure and a 32-bit CRC to verify that the contents of the EFI Boot Services Table are valid.
<i>RaiseTPL</i>	Raises the task priority level.
<i>RestoreTPL</i>	Restores/lowers the task priority level.
<i>AllocatePages</i>	Allocates pages of a particular type.
<i>FreePages</i>	Frees allocated pages.



<i>GetMemoryMap</i>	Returns the current boot services memory map and memory map key.
<i>AllocatePool</i>	Allocates a pool of a particular type.
<i>FreePool</i>	Frees allocated pool.
<i>CreateEvent</i>	Creates a general-purpose event structure.
<i>SetTimer</i>	Sets an event to be signaled at a particular time.
<i>WaitForEvent</i>	Stops execution until an event is signaled.
<i>SignalEvent</i>	Signals an event.
<i>CloseEvent</i>	Closes and frees an event structure.
<i>CheckEvent</i>	Checks whether an event is in the signaled state.
<i>InstallProtocolInterface</i>	Installs a protocol interface on a device handle.
<i>ReinstallProtocolInterface</i>	Reinstalls a protocol interface on a device handle.
<i>UninstallProtocolInterface</i>	Removes a protocol interface from a device handle.
<i>HandleProtocol</i>	Queries a handle to determine if it supports a specified protocol.
<i>Reserved</i>	Reserved. Must be <b>NULL</b> .
<i>RegisterProtocolNotify</i>	Registers an event that is to be signaled whenever an interface is installed for a specified protocol.
<i>LocateHandle</i>	Returns an array of handles that support a specified protocol.
<i>LocateDevicePath</i>	Locates all devices on a device path that support a specified protocol and returns the handle to the device that is closest to the path.
<i>InstallConfigurationTable</i>	Adds, updates, or removes a configuration table from the EFI System Table.
<i>LoadImage</i>	Loads an EFI image into memory.
<i>StartImage</i>	Transfers control to a loaded image's entry point.
<i>Exit</i>	Exits the image's entry point.
<i>UnloadImage</i>	Unloads an image.
<i>ExitBootServices</i>	Terminates boot services.
<i>GetNextMonotonicCount</i>	Returns a monotonically increasing count for the platform.
<i>Stall</i>	Stalls the processor.
<i>SetWatchdogTimer</i>	Resets and sets a watchdog timer used during boot services time.
<i>ConnectController</i>	Uses a set of precedence rules to find the best set of drivers to manage a controller.

<i>DisconnectController</i>	Informs a set of drivers to stop managing a controller.
<i>OpenProtocol</i>	Adds elements to the list of agents consuming a protocol interface.
<i>CloseProtocol</i>	Removes elements from the list of agents consuming a protocol interface.
<i>OpenProtocolInformation</i>	Retrieve the list of agents that are currently consuming a protocol interface.
<i>ProtocolsPerHandle</i>	Retrieves the list of protocols installed on a handle. The return buffer is automatically allocated.
<i>LocateHandleBuffer</i>	Retrieves the list of handles from the handle database that meet the search criteria. The return buffer is automatically allocated.
<i>LocateProtocol</i>	Finds the first handle in the handle database the supports the requested protocol.
<i>InstallMultipleProtocolInterfaces</i>	Installs one or more protocol interfaces onto a handle.
<i>UninstallMultipleProtocolInterfaces</i>	Uninstalls one or more protocol interfaces from a handle.
<i>CalculateCrc32</i>	Computes and returns a 32-bit CRC for a data buffer.
<i>CopyMem</i>	Copies the contents of one buffer to another buffer.
<i>SetMem</i>	Fills a buffer with a specified value.
<i>CreateEventEx</i>	Creates an event structure as part of an event group.

## 4.5 EFI Runtime Services Table

UEFI uses the EFI Runtime Services Table, which contains a table header and pointers to all of the runtime services. The definition for this table is shown in the following code fragments. Except for the table header, all elements in the EFI Runtime Services Tables are prototypes of function pointers to functions as defined in [Section 8](#). Unlike the EFI Boot Services Table, this table, and the function pointers it contains are valid after the UEFI OS loader and OS have taken control of the platform with a call to [EFI\\_BOOT\\_SERVICES.ExitBootServices\(\)](#). If a call to [SetVirtualAddressMap\(\)](#) is made by the OS, then the function pointers in this table are fixed up to point to the new virtually mapped entry points.

### EFI\_RUNTIME\_SERVICES

#### Summary

Contains a table header and pointers to all of the runtime services.

#### Related Definitions

```
#define EFI_RUNTIME_SERVICES_SIGNATURE 0x56524553544e5552
```

```
#define EFI_RUNTIME_SERVICES_REVISION EFI_SPECIFICATION_VERSION
typedef struct {
    EFI_TABLE_HEADER    Hdr;

    //
    // Time Services
    //
    EFI_GET_TIME        GetTime;
    EFI_SET_TIME        SetTime;
    EFI_GET_WAKEUP_TIME    GetWakeupTime;
    EFI_SET_WAKEUP_TIME    SetWakeupTime;

    //
    // Virtual Memory Services
    //
    EFI_SET_VIRTUAL_ADDRESS_MAP    SetVirtualAddressMap;
    EFI_CONVERT_POINTER            ConvertPointer;

    //
    // Variable Services
    //
    EFI_GET_VARIABLE            GetVariable;
    EFI_GET_NEXT_VARIABLE_NAME    GetNextVariableName;
    EFI_SET_VARIABLE            SetVariable;

    //
    // Miscellaneous Services
    //
    EFI_GET_NEXT_HIGH_MONO_COUNT    GetNextHighMonotonicCount;
    EFI_RESET_SYSTEM                ResetSystem;

    //
    // UEFI 2.0 Capsule Services
    //
    EFI_UPDATE_CAPSULE            UpdateCapsule;
    EFI_QUERY_CAPSULE_CAPABILITIES    QueryCapsuleCapabilities;

    //
    // Miscellaneous UEFI 2.0 Service
    //
    EFI_QUERY_VARIABLE_INFO        QueryVariableInfo;
} EFI_RUNTIME_SERVICES;
```

## Parameters

<i>Hdr</i>	The table header for the EFI Runtime Services Table. This header contains the <b>EFI_RUNTIME_SERVICES_SIGNATURE</b> and <b>EFI_RUNTIME_SERVICES_REVISION</b> values along with the size of the <b>EFI_RUNTIME_SERVICES</b> structure and a 32-bit CRC to verify that the contents of the EFI Runtime Services Table are valid.
<i>GetTime</i>	Returns the current time and date, and the time-keeping capabilities of the platform.
<i>SetTime</i>	Sets the current local time and date information.
<i>GetWakeupTime</i>	Returns the current wakeup alarm clock setting.
<i>SetWakeupTime</i>	Sets the system wakeup alarm clock time.
<i>SetVirtualAddressMap</i>	Used by a UEFI OS loader to convert from physical addressing to virtual addressing.
<i>ConvertPointer</i>	Used by EFI components to convert internal pointers when switching to virtual addressing.
<i>GetVariable</i>	Returns the value of a variable.
<i>GetNextVariableName</i>	Enumerates the current variable names.
<i>SetVariable</i>	Sets the value of a variable.
<i>GetNextHighMonotonicCount</i>	Returns the next high 32 bits of the platform's monotonic counter.
<i>ResetSystem</i>	Resets the entire platform.
<i>UpdateCapsule</i>	Passes capsules to the firmware with both virtual and physical mapping.
<i>QueryCapsuleCapabilities</i>	Returns if the capsule can be supported via <b>UpdateCapsule()</b> .
<i>QueryVariableInfo</i>	Returns information about the EFI variable store.

## 4.6 EFI Configuration Table & Properties Table

The EFI Configuration Table is the *ConfigurationTable* field in the EFI System Table. This table contains a set of GUID/pointer pairs. Each element of this table is described by the **EFI\_CONFIGURATION\_TABLE** structure below. The number of types of configuration tables is expected to grow over time. This is why a GUID is used to identify the configuration table type. The EFI Configuration Table may contain at most once instance of each table type.

## EFI\_CONFIGURATION\_TABLE

### Summary

Contains a set of GUID/pointer pairs comprised of the *ConfigurationTable* field in the EFI System Table.

### Related Definitions

```
typedef struct{
    EFI_GUID      VendorGuid;
    VOID          *VendorTable;
} EFI_CONFIGURATION_TABLE;
```

### Parameters

The following list shows the GUIDs for tables defined in some of the industry standards. These industry standards define tables accessed as UEFI Configuration Tables on UEFI-based systems. This list is not exhaustive and does not show GUIDS for all possible UEFI Configuration tables.

*VendorGuid*

The 128-bit GUID value that uniquely identifies the system configuration table.

*VendorTable*

A pointer to the table associated with *VendorGuid*. Whether this pointer is a physical address or a virtual address during runtime is determined by the *VendorGuid*. The *VendorGuid* associated with a given *VendorTable* pointer defines whether or not a particular address reported in the table gets fixed up when a call to [SetVirtualAddressMap\(\)](#) is made. It is the responsibility of the specification defining the *VendorTable* to specify whether to convert the addresses reported in the table.

The following list shows the GUIDs for tables defined in some of the industry standards. These industry standards define tables accessed as UEFI Configuration Tables on UEFI-based systems. All the addresses reported in these table entries will be referenced as physical and will not be fixed up when transition from preboot to runtime phase. This list is not exhaustive and does not show GUIDs for all possible UEFI Configuration tables.

```

#define EFI_ACPI_20_TABLE_GUID \
{0x8868e871,0xe4f1,0x11d3,\
 {0xbc,0x22,0x00,0x80,0xc7,0x3c,0x88,0x81}}

#define ACPI_TABLE_GUID \
{0xeb9d2d30,0x2d88,0x11d3,\
 {0x9a,0x16,0x00,0x90,0x27,0x3f,0xc1,0x4d}}

#define SAL_SYSTEM_TABLE_GUID \
{0xeb9d2d32,0x2d88,0x11d3,\
 {0x9a,0x16,0x00,0x90,0x27,0x3f,0xc1,0x4d}}

#define SMBIOS_TABLE_GUID \
{0xeb9d2d31,0x2d88,0x11d3,\
 {0x9a,0x16,0x00,0x90,0x27,0x3f,0xc1,0x4d}}

#define SMBIOS3_TABLE_GUID \
{0xf2fd1544, 0x9794, 0x4a2c,\
 {0x99,0x2e,0xe5,0xbb,0xcf,0x20,0xe3,0x94}}

#define MPS_TABLE_GUID \
{0xeb9d2d2f,0x2d88,0x11d3,\
 {0x9a,0x16,0x00,0x90,0x27,0x3f,0xc1,0x4d}}
//
// ACPI 2.0 or newer tables should use EFI_ACPI_TABLE_GUID
//
#define EFI_ACPI_TABLE_GUID \
{0x8868e871,0xe4f1,0x11d3,\
 {0xbc,0x22,0x00,0x80,0xc7,0x3c,0x88,0x81}}

#define EFI_ACPI_20_TABLE_GUID EFI_ACPI_TABLE_GUID

#define ACPI_TABLE_GUID \
{0xeb9d2d30,0x2d88,0x11d3,\
 {0x9a,0x16,0x00,0x90,0x27,0x3f,0xc1,0x4d}}

#define ACPI_10_TABLE_GUID ACPI_TABLE_GUID

```

## EFI\_PROPERTIES\_TABLE

This table is published if the platform meets some of the construction requirements listed in the *MemoryProtectionAttributes*.

```
typedef struct {
    UINT32 Version;
    UINT32 Length;
    UINT64 MemoryProtectionAttribute;
} EFI_PROPERTIES_TABLE;
```

*Version* This is revision of the table. Successive version may populate additional bits and growth the table length. In the case of the latter, the *Length* field will be adjusted appropriately

```
#define EFI_PROPERTIES_TABLE_VERSION 0x00010000
```

*Length* This is the size of the entire **EFI\_PROPERTIES\_TABLE** structure, including the version. The initial version will be of length 16.

*MemoryProtectionAttribute* This field is a bit mask. Any bits not defined shall be considered reserved. A set bit means that the underlying firmware has been constructed responsive to the given property.

```
//
// Memory attribute (Not defined bits are reserved)
//
#define
EFI_PROPERTIES_RUNTIME_MEMORY_PROTECTION_NON_EXECUTABLE_PE_DATA
  0x1 \
  // BIT 0 – description – implies the runtime data is separated from the code
```

This bit implies that the UEFI runtime code and data sections of the executable image are separate and must be aligned as specified in [Section 2.3](#). This bit also implies that the data pages do not have any executable code.

It is recommended not to use this attribute, especially for implementations that broke the runtime code memory map descriptors into the underlying code and data sections within UEFI modules. This splitting causes interoperability issues with operating systems that invoke **SetVirtualAddress()** without realizing that there is a relationship between these runtime descriptors.

## EFI\_MEMORY\_ATTRIBUTES\_TABLE

### Summary

When published by the system firmware, the **EFI\_MEMORY\_ATTRIBUTES\_TABLE** provides additional information about regions within the run-time memory blocks defined in the **EFI\_MEMORY\_DESCRIPTOR** entries returned from **EFI\_BOOT\_SERVICES.GetMemoryMap()** function. The Memory Attributes Table is

currently used to describe memory protections that may be applied to the EFI Runtime code and data by an operating system or hypervisor. Consumers of this table must currently ignore entries containing any values for *Type* except for *EfiRuntimeServicesData* and *EfiRuntimeServicesCode* to ensure compatibility with future uses of this table. The Memory Attributes Table may define multiple entries to describe sub-regions that comprise a single entry returned by **GetMemoryMap()** however the sub-regions must total to completely describe the larger region and may not cross boundaries between entries reported by **GetMemoryMap()**. If a run-time region returned in **GetMemoryMap()** entry is not described within the Memory Attributes Table, this region is assumed to not be compatible with any memory protections.

Only entire **EFI\_MEMORY\_DESCRIPTOR** entries as returned by **GetMemoryMap()** may be passed to **SetVirtualAddressMap()**.

## Prototype

```
#define EFI_MEMORY_ATTRIBUTES_TABLE_GUID \
{ 0xdcfa911d, 0x26eb, 0x469f, \
  {0xa2, 0x20, 0x38, 0xb7, 0xdc, 0x46, 0x12, 0x20}}
```

With the following data structure

```
/* *****
/* EFI_MEMORY_ATTRIBUTES_TABLE
/* *****
typedef struct {
  UINT32    Version ;
  UINT32    NumberOfEntries ;
  UINT32    DescriptorSize ;
  UINT32    Reserved;
  // EFI_MEMORY_DESCRIPTOR Entry [1];
} EFI_MEMORY_ATTRIBUTES_TABLE;
```

<i>Version</i>	The version of this table. Present version is 0x00000001
<i>NumberOfEntries</i>	Count of <b>EFI_MEMORY_DESCRIPTOR</b> entries provided. This is typically the total number of PE/COFF sections within all UEFI modules that comprise the UEFI Runtime and all UEFI Runtime Data regions (e.g. runtime heap).
<i>Entry</i>	Array of <i>Entries</i> of type <b>EFI_MEMORY_DESCRIPTOR</b> .
<i>DescriptorSize</i>	Size of the memory descriptor.
<i>Reserved</i>	Reserved bytes.

## Description

For each array entry, the **EFI\_MEMORY\_DESCRIPTOR.Attribute** field can inform a runtime agency, such as operating system or hypervisor, as to what class of protection settings can be made in the memory management unit for the



memory defined by this entry. The only valid bits for *Attribute* field currently are **EFI\_MEMORY\_RO**, **EFI\_MEMORY\_XP**, plus **EFI\_MEMORY\_RUNTIME**. Irrespective of the memory protections implied by *Attribute*, the **EFI\_MEMORY\_DESCRIPTOR.Type** field should match the type of the memory in enclosing **SetMemoryMap()** entry. *PhysicalStart* must be aligned as specified in [Section 2.3](#). The list must be sorted by physical start address in ascending order. *VirtualStart* field must be zero and ignored by the OS since it has no purpose for this table. *NumPages* must cover the entire memory region for the protection mapping. Each Descriptor in the **EFI\_MEMORY\_ATTRIBUTES\_TABLE** with attribute **EFI\_MEMORY\_RUNTIME** must not overlap any other Descriptor in the **EFI\_MEMORY\_ATTRIBUTES\_TABLE** with attribute **EFI\_MEMORY\_RUNTIME**. Additionally, every memory region described by a Descriptor in **EFI\_MEMORY\_ATTRIBUTES\_TABLE** must be a sub-region of, or equal to, a descriptor in the table produced by **GetMemoryMap()**.

Table 12. Usage of Memory Attribute Definitions

	EFI_MEMORY_RO	EFI_MEMORY_XP	EFI_MEMORY_RUNTIME
No memory access protection is possible for Entry	0	0	1
Write-protected Code	1	0	1
Read/Write Data	0	1	1
Read-only Data	1	1	1

## 4.7 Image Entry Point Examples

The examples in the following sections show how the various table examples are presented in the UEFI environment.

### 4.7.1 Image Entry Point Examples

The following example shows the image entry point for a UEFI Application. This application makes use of the EFI System Table, the EFI Boot Services Table, and the EFI Runtime Services Table.

```

EFI_SYSTEM_TABLE    *gST;
EFI_BOOT_SERVICES  *gBS;
EFI_RUNTIME_SERVICES *gRT;

EfiApplicationEntryPoint(
  IN EFI_HANDLE ImageHandle,
  IN EFI_SYSTEM_TABLE *SystemTable
)
{

```

```

EFI_STATUS Status;
EFI_TIME *Time;

gST = SystemTable;
gBS = gST->BootServices;
gRT = gST->RuntimeServices;

//
// Use EFI System Table to print "Hello World" to the active console output
// device.
//
Status = gST->ConOut->OutputString (gST->ConOut, L"Hello World\n\r");
if (EFI_ERROR (Status)) {
    return Status;
}

//
// Use EFI Boot Services Table to allocate a buffer to store the current time
// and date.
//
Status = gBS->AllocatePool (
    EfiBootServicesData,
    sizeof (EFI_TIME),
    (VOID **)&Time
);
if (EFI_ERROR (Status)) {
    return Status;
}

//
// Use the EFI Runtime Services Table to get the current time and date.
//
Status = gRT->GetTime (Time, NULL)
if (EFI_ERROR (Status)) {
    return Status;
}

return Status;
}

```

The following example shows the UEFI image entry point for a driver that does not follow the UEFI *Driver Model*. Since this driver returns **EFI\_SUCCESS**, it will stay resident in memory after it exits.

```

EFI_SYSTEM_TABLE *gST;
EFI_BOOT_SERVICES *gBS;
EFI_RUNTIME_SERVICES *gRT;

EfiDriverEntryPoint(
    IN EFI_HANDLE ImageHandle,
    IN EFI_SYSTEM_TABLE *SystemTable
)
{
    gST = SystemTable;
    gBS = gST->BootServices;
    gRT = gST->RuntimeServices;

    //
    // Implement driver initialization here.

```

```
//
return EFI_SUCCESS;
}
```

The following example shows the UEFI image entry point for a driver that also does not follow the UEFI *Driver Model*. Since this driver returns **EFI\_DEVICE\_ERROR**, it will not stay resident in memory after it exits.

```
EFI_SYSTEM_TABLE    *gST;
EFI_BOOT_SERVICES  *gBS;
EFI_RUNTIME_SERVICES *gRT;

EfiDriverEntryPoint(
  IN EFI_HANDLE  ImageHandle,
  IN EFI_SYSTEM_TABLE *SystemTable
)

{
  gST = SystemTable;
  gBS = gST->BootServices;
  gRT = gST->RuntimeServices;

  //
  // Implement driver initialization here.
  //

  return EFI_DEVICE_ERROR;
}
```

## 4.7.2 UEFI Driver Model Example

The following is an UEFI *Driver Model* example that shows the driver initialization routine for the ABC device controller that is on the XYZ bus. The [EFI DRIVER BINDING PROTOCOL](#) and the function prototypes for [AbcSupported\(\)](#), [AbcStart\(\)](#), and [AbcStop\(\)](#) are defined in [Section 11.1](#). This function saves the driver's image handle and a pointer to the EFI boot services table in global variables, so the other functions in the same driver can have access to these values. It then creates an instance of the **EFI\_DRIVER\_BINDING\_PROTOCOL** and installs it onto the driver's image handle.

```
extern EFI_GUID      gEfiDriverBindingProtocolGuid;
EFI_BOOT_SERVICES  *gBS;
static EFI_DRIVER_BINDING_PROTOCOL mAbcDriverBinding = {
  AbcSupported,
  AbcStart,
  AbcStop,
  1,
  NULL,
  NULL
};

AbcEntryPoint(
  IN EFI_HANDLE  ImageHandle,
  IN EFI_SYSTEM_TABLE *SystemTable
)

{
```

```

EFI_STATUS Status;

gBS = SystemTable->BootServices;

mAbcDriverBinding->ImageHandle = ImageHandle;
mAbcDriverBinding->DriverBindingHandle = ImageHandle;

Status = gBS->InstallMultipleProtocolInterfaces(
    &mAbcDriverBinding->DriverBindingHandle,
    &gEfiDriverBindingProtocolGuid, &mAbcDriverBinding,
    NULL
);
return Status;
}

```

### 4.7.3 UEFI Driver Model Example (Unloadable)

The following is the same UEFI *Driver Model* example as above, except it also includes the code required to allow the driver to be unloaded through the boot service [Unload\(\)](#). Any protocols installed or memory allocated in **AbcEntryPoint()** must be uninstalled or freed in the **AbcUnload()**.

```

extern EFI_GUID gEfiLoadedImageProtocolGuid;
extern EFI_GUID gEfiDriverBindingProtocolGuid;
EFI_BOOT_SERVICES *gBS;
static EFI_DRIVER_BINDING_PROTOCOL mAbcDriverBinding = {
    AbcSupported,
    AbcStart,
    AbcStop,
    1,
    NULL,
    NULL
};

EFI_STATUS
AbcUnload (
    IN EFI_HANDLE ImageHandle
);

AbcEntryPoint(
    IN EFI_HANDLE ImageHandle,
    IN EFI_SYSTEM_TABLE *SystemTable
)
{
    EFI_STATUS Status;
    EFI_LOADED_IMAGE_PROTOCOL *LoadedImage;

    gBS = SystemTable->BootServices;

    Status = gBS->OpenProtocol (
        ImageHandle,
        &gEfiLoadedImageProtocolGuid,
        &LoadedImage,
        ImageHandle,
        NULL,
        EFI_OPEN_PROTOCOL_GET_PROTOCOL
    );
    if (EFI_ERROR (Status)) {
        return Status;
    }
}

```

```

    }
    LoadedImage->Unload = AbcUnload;

    mAbcDriverBinding->ImageHandle = ImageHandle;
    mAbcDriverBinding->DriverBindingHandle = ImageHandle;

    Status = gBS->InstallMultipleProtocolInterfaces(
        &mAbcDriverBinding->DriverBindingHandle,
        &gEfiDriverBindingProtocolGuid, &mAbcDriverBinding,
        NULL
    );

    return Status;
}

EFI_STATUS
AbcUnload (
    IN EFI_HANDLE ImageHandle
)
{
    EFI_STATUS Status;

    Status = gBS->UninstallMultipleProtocolInterfaces (
        ImageHandle,
        &gEfiDriverBindingProtocolGuid, &mAbcDriverBinding,
        NULL
    );
    return Status;
}

```

#### 4.7.4 EFI Driver Model Example (Multiple Instances)

The following is the same as the first UEFI *Driver Model* example, except it produces three [EFI DRIVER BINDING PROTOCOL](#) instances. The first one is installed onto the driver's image handle. The other two are installed onto newly created handles.

```

extern EFI_GUID      gEfiDriverBindingProtocolGuid;
EFI_BOOT_SERVICES  *gBS;

static EFI_DRIVER_BINDING_PROTOCOL mAbcDriverBindingA = {
    AbcSupportedA,
    AbcStartA,
    AbcStopA,
    1,
    NULL,
    NULL
};

static EFI_DRIVER_BINDING_PROTOCOL mAbcDriverBindingB = {
    AbcSupportedB,
    AbcStartB,
    AbcStopB,
    1,
    NULL,
    NULL
};

static EFI_DRIVER_BINDING_PROTOCOL mAbcDriverBindingC = {

```

```

    AbcSupportedC,
    AbcStartC,
    AbcStopC,
    1,
    NULL,
    NULL
};

AbcEntryPoint(
    IN EFI_HANDLE ImageHandle,
    IN EFI_SYSTEM_TABLE *SystemTable
)
{
    EFI_STATUS Status;

    gBS = SystemTable->BootServices;

    //
    // Install mAbcDriverBindingA onto ImageHandle
    //
    mAbcDriverBindingA->ImageHandle = ImageHandle;
    mAbcDriverBindingA->DriverBindingHandle = ImageHandle;

    Status = gBS->InstallMultipleProtocolInterfaces(
        &mAbcDriverBindingA->DriverBindingHandle,
        &gEfiDriverBindingProtocolGuid, &mAbcDriverBindingA,
        NULL
    );
    if (EFI_ERROR (Status)) {
        return Status;
    }

    //
    // Install mAbcDriverBindingB onto a newly created handle
    //
    mAbcDriverBindingB->ImageHandle = ImageHandle;
    mAbcDriverBindingB->DriverBindingHandle = NULL;

    Status = gBS->InstallMultipleProtocolInterfaces(
        &mAbcDriverBindingB->DriverBindingHandle,
        &gEfiDriverBindingProtocolGuid, &mAbcDriverBindingB,
        NULL
    );
    if (EFI_ERROR (Status)) {
        return Status;
    }

    //
    // Install mAbcDriverBindingC onto a newly created handle
    //
    mAbcDriverBindingC->ImageHandle = ImageHandle;
    mAbcDriverBindingC->DriverBindingHandle = NULL;

    Status = gBS->InstallMultipleProtocolInterfaces(
        &mAbcDriverBindingC->DriverBindingHandle,
        &gEfiDriverBindingProtocolGuid, &mAbcDriverBindingC,
        NULL
    );

    return Status;
}

```

## 5 GUID Partition Table (GPT) Disk Layout

---

### 5.1 GPT and MBR disk layout comparison

This specification defines the GUID Partition table (GPT) disk layout (i.e., partitioning scheme). The following list outlines the advantages of using the GPT disk layout over the legacy Master Boot Record (MBR) disk layout:

- Logical Block Addresses (LBAs) are 64 bits (rather than 32 bits).
- Supports many partitions (rather than just four primary partitions).
- Provides both a primary and backup partition table for redundancy.
- Uses version number and size fields for future expansion.
- Uses CRC32 fields for improved data integrity.
- Defines a GUID for uniquely identifying each partition.
- Uses a GUID and attributes to define partition content type.
- Each partition contains a 36 character human readable name.

### 5.2 LBA 0 Format

LBA 0 (i.e., the first logical block) of the hard disk contains either

- a legacy Master Boot Record (MBR) (see [Section 5.2.1](#))
- or a protective MBR (see [Section 5.2.3](#)).

#### 5.2.1 Legacy Master Boot Record (MBR)

A legacy MBR may be located at LBA 0 (i.e., the first logical block) of the disk if it is not using the GPT disk layout (i.e., if it is using the MBR disk layout). The boot code on the MBR is not executed by UEFI firmware.

Table 13. Legacy MBR

Mnemonic	Byte Offset	Byte Length	Description
<i>BootCode</i>	0	424	x86 code used on a non-UEFI system to select an MBR partition record and load the first logical block of that partition. This code shall not be executed on UEFI systems.
<i>UniqueMBRDiskSignature</i>	440	4	Unique Disk Signature This may be used by the OS to identify the disk from other disks in the system. This value is always written by the OS and is never written by EFI firmware.
<i>Unknown</i>	444	2	Unknown. This field shall not be used by UEFI firmware.
<i>PartitionRecord</i>	446	16*4	Array of four legacy MBR partition records (see <a href="#">Table 14</a> ).
<i>Signature</i>	510	2	Set to 0xAA55 (i.e., byte 510 contains 0x55 and byte 511 contains 0xAA).
<i>Reserved</i>	512	Logical BlockSize - 512	The rest of the logical block, if any, is reserved.

The MBR contains four partition records (see Table 11) that each define the beginning and ending LBAs that a partition consumes on a disk.

Table 14. Legacy MBR Partition Record

Mnemonic	Byte Offset	Byte Length	Description
<i>BootIndicator</i>	0	1	0x80 indicates that this is the bootable legacy partition. Other values indicate that this is not a bootable legacy partition. This field shall not be used by UEFI firmware.
<i>StartingCHS</i>	1	3	Start of partition in CHS address format. This field shall not be used by UEFI firmware.
<i>OSType</i>	4	1	Type of partition. See <a href="#">Section 5.2.2</a> .
<i>EndingCHS</i>	5	3	End of partition in CHS address format. This field shall not be used by UEFI firmware.
<i>StartingLBA</i>	8	4	Starting LBA of the partition on the disk. This field is used by UEFI firmware to determine the start of the partition.
<i>SizeInLBA</i>	12	4	Size of the partition in LBA units of logical blocks. This field is used by UEFI firmware to determine the size of the partition.

If an MBR partition has an *OSType* field of 0xEF (i.e., UEFI System Partition), then the firmware must add the UEFI System Partition GUID to the handle for the MBR partition using `InstallProtocolInterface()`. This allows drivers and applications, including OS



loaders, to easily search for handles that represent UEFI System Partitions. The following test must be performed to determine if a legacy MBR is valid:

- The Signature must be 0xaa55.
- A Partition Record that contains an *OSType* value of zero or a *SizeInLBA* value of zero may be ignored.

Otherwise:

- The partition defined by each MBR Partition Record must physically reside on the disk (i.e., not exceed the capacity of the disk).
- Each partition must not overlap with other partitions.

[Figure 16](#) shows an example of an MBR disk layout with four partitions.

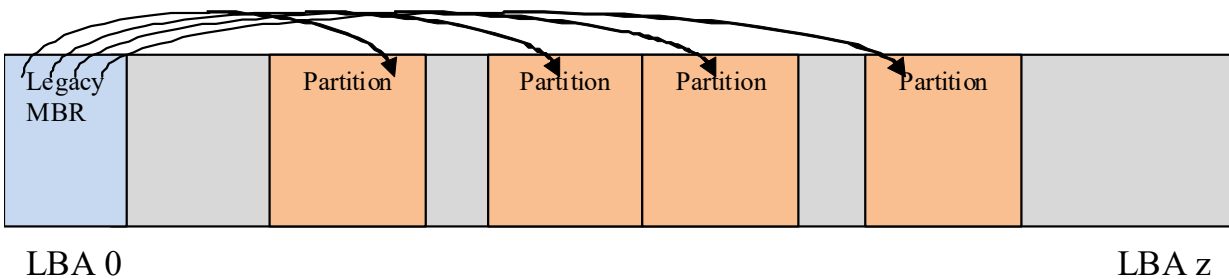

Figure 16. MBRDisk Layout with legacy MBR example

### Related Definitions:

```
#pragma pack(1)
///
/// MBR Partition Entry
///
typedef struct {
    UINT8 BootIndicator;
    UINT8 StartHead;
    UINT8 StartSector;
    UINT8 StartTrack;
    UINT8 OSIndicator;
    UINT8 EndHead;
    UINT8 EndSector;
    UINT8 EndTrack;
    UINT8 StartingLBA[4];
    UINT8 SizeInLBA[4];
} MBR_PARTITION_RECORD;

///
```

```
/// MBR Partition Table
///
typedef struct {
    UINT8      BootStrapCode[440];
    UINT8      UniqueMbrSignature[4];
    UINT8      Unknown[2];
    MBR_PARTITION_RECORD Partition[4];
    UINT16     Signature;
} MASTER_BOOT_RECORD;

#pragma pack()
```

## 5.2.2 OS Types

Unique types defined by this specification (other values are not defined by this specification):

- 0xEF (i.e., UEFI System Partition) defines a UEFI system partition.
- 0xEE (i.e., GPT Protective) is used by a protective MBR (see 5.2.2) to define a fake partition covering the entire disk.

Other values are used by legacy operating systems, and are allocated independently of the UEFI specification.

**Note:** “Partition types” by Andries Brouwer: See “Links to UEFI-Related Documents” (<http://uefi.org/uefi>) under the heading “OS Type values used in the MBR disk layout”.

## 5.2.3 Protective MBR

A Protective MBR may be located at LBA 0 (i.e., the first logical block) of the disk if it is using the GPT disk layout. The Protective MBR precedes the GUID Partition Table Header to maintain compatibility with existing tools that do not understand GPT partition structures.

Table 15. Protective MBR

Mnemonic	Byte Offset	Byte Length	Contents
Boot Code	0	440	Unused by UEFI systems.
Unique MBR Disk Signature	440	4	Unused. Set to zero.
Unknown	444	2	Unused. Set to zero.
Partition Record	446	16*4	Array of four MBR partition records. Contains: <ul style="list-style-type: none"> <li>one partition record as defined <a href="#">Table 16</a>; and</li> <li>three partition records each set to zero.</li> </ul>
Signature	510	2	Set to 0xAA55 (i.e., byte 510 contains 0x55 and byte 511 contains 0xAA).
Reserved	512	Logical Block Size - 512	The rest of the logical block, if any, is reserved. Set to zero.

One of the Partition Records shall be as defined in table 12, reserving the entire space on the disk after the Protective MBR itself for the GPT disk layout.

Table 16. Protective MBR Partition Record protecting the entire disk

Mnemonic	Byte Offset	Byte Length	Description
<i>BootIndicator</i>	0	1	Set to 0x00 to indicate a non-bootable partition. If set to any value other than 0x00 the behavior of this flag on non-UEFI systems is undefined. Must be ignored by UEFI implementations.
<i>StartingCHS</i>	1	3	Set to 0x000200, corresponding to the Starting LBA field.
<i>OSType</i>	4	1	Set to 0xEE (i.e., GPT Protective)
<i>EndingCHS</i>	5	3	Set to the CHS address of the last logical block on the disk. Set to 0FFFFFFF if it is not possible to represent the value in this field.
<i>StartingLBA</i>	8	4	Set to 0x00000001 (i.e., the LBA of the GPT Partition Header).
<i>SizeInLBA</i>	12	4	Set to the size of the disk minus one. Set to 0xFFFFFFFF if the size of the disk is too large to be represented in this field.

The remaining Partition Records shall each be set to zeros.

[Figure 17](#) shows an example of a GPT disk layout with four partitions with a protective MBR.

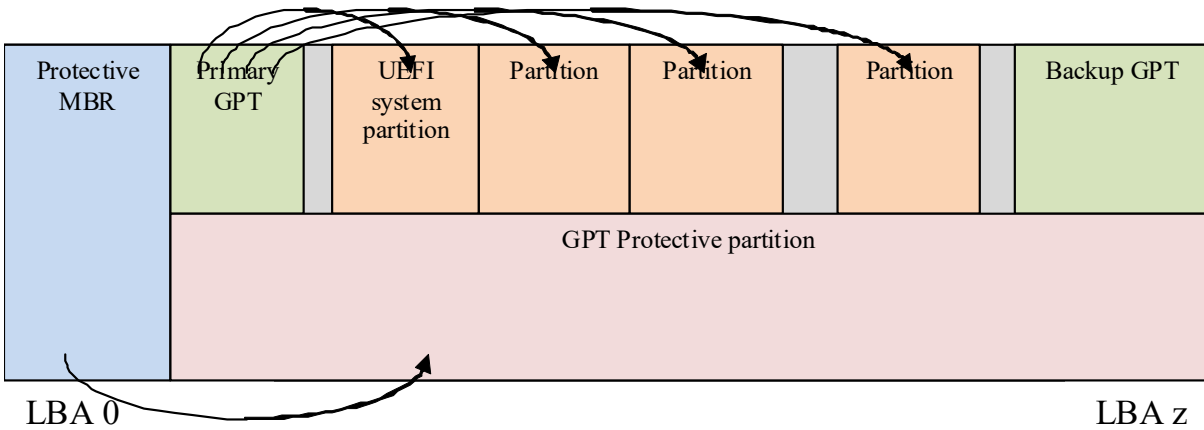

Figure 17. GPT disk layout with protective MBR example

Figure 18 shows an example of a GPT disk layout with four partitions with a protective MBR, where the disk capacity exceeds LBA 0xFFFFFFFF.

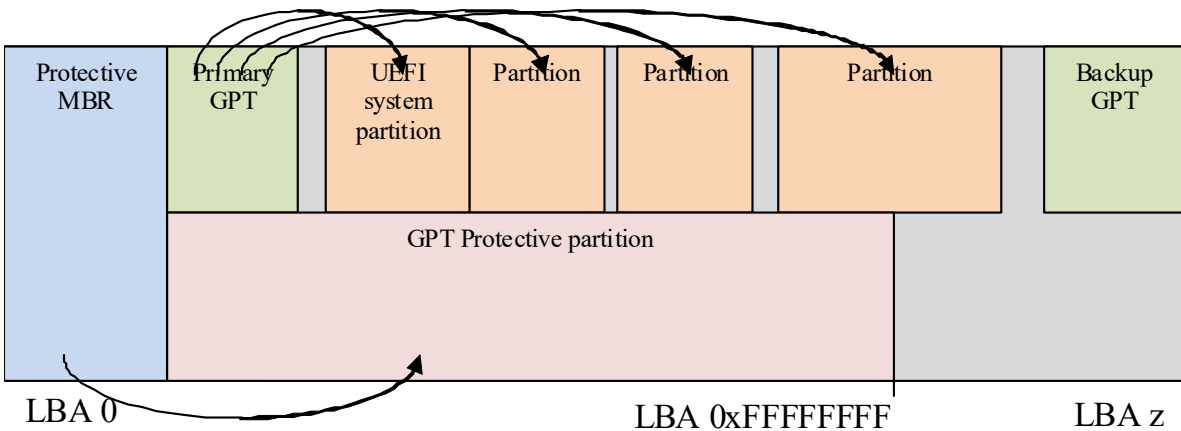

Figure 18. GPT disk layout with protective MBR on a disk with capacity exceeding LBA 0xFFFFFFFF example.

### 5.2.4 Partition Information

Install an `EFI_PARTITION_INFO` protocol on each of the device handles that logical `EFI_BLOCK_IO_PROTOCOLs` are installed.

## 5.3 GUID Partition Table (GPT) Disk Layout

### 5.3.1 GPT overview

The GPT partitioning scheme is depicted in [Figure 19](#). The GPT Header (see [Section 5.3.2](#)) includes a signature and a revision number that specifies the format of the data bytes in the partition header. The GUID Partition Table Header contains a header size field that is used in calculating the CRC32 that confirms the integrity of the GPT Header. While the GPT Header's size may increase in the future it cannot span more than one logical block on the device.

LBA 0 (i.e., the first logical block) contains a protective MBR (see [Section 5.2.3](#)).

Two GPT Header structures are stored on the device: the primary and the backup. The primary GPT Header must be located in LBA 1 (i.e., the second logical block), and the backup GPT Header must be located in the last LBA of the device. Within the GPT Header the *My LBA* field contains the LBA of the GPT Header itself, and the *Alternate LBA* field contains the LBA of the other GPT Header. For example, the primary GPT Header's *My LBA* value would be 1 and its *Alternate LBA* would be the value for the last LBA of the device. The backup GPT Header's fields would be reversed.

The GPT Header defines the range of LBAs that are usable by GPT Partition Entries. This range is defined to be inclusive of *First Usable LBA* through *Last Usable LBA* on the logical device. All data stored on the volume must be stored between the *First Usable LBA* through *Last Usable LBA*, and only the data structures defined by UEFI to manage partitions may reside outside of the usable space. The value of *Disk GUID* is a GUID that uniquely identifies the entire GPT Header and all its associated storage. This value can be used to uniquely identify the disk. The start of the GPT Partition Entry Array is located at the LBA indicated by the *Partition Entry LBA* field. The size of a GUID Partition Entry element is defined in the *Size Of Partition Entry* field. There is a 32-bit CRC of the GPT Partition Entry Array that is stored in the GPT Header in *Partition Entry Array CRC32* field. The size of the GPT Partition Entry Array is *Size Of Partition Entry* multiplied by *Number Of Partition Entries*. If the size of the GUID Partition Entry Array is not an even multiple of the logical block size, then any space left over in the last logical block is Reserved and not covered by the *Partition Entry Array CRC32* field. When a GUID Partition Entry is updated, the *Partition Entry Array CRC32* must be updated. When the *Partition Entry Array CRC32* is updated, the GPT Header CRC must also be updated, since the *Partition Entry Array CRC32* is stored in the GPT Header.

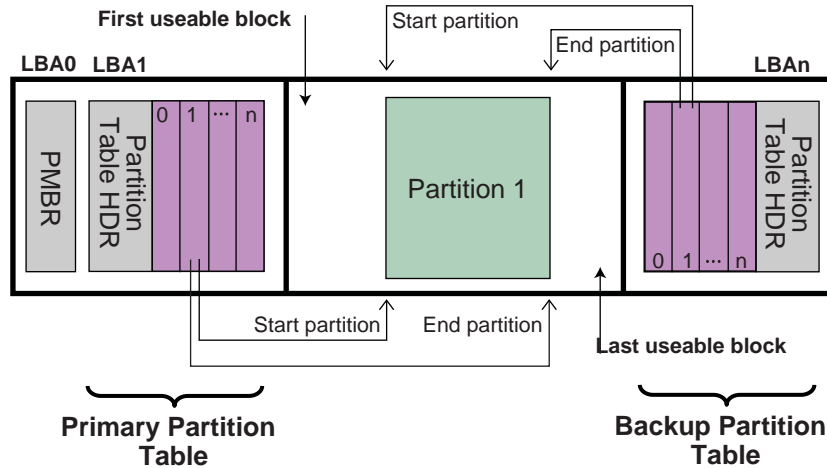

OM13160

Figure 19. GUID Partition Table (GPT) example

The primary GPT Partition Entry Array must be located after the primary GPT Header and end before the *First Usable LBA*. The backup GPT Partition Entry Array must be located after the *Last Usable LBA* and end before the backup GPT Header.

Therefore the primary and backup GPT Partition Entry Arrays are stored in separate locations on the disk. Each GPT Partition Entry defines a partition that is contained in a range that is within the usable space declared by the GPT Header. Zero or more GPT Partition Entries may be in use in the GPT Partition Entry Array. Each defined partition must not overlap with any other defined partition. If all the fields of a GUID Partition Entry are zero, the entry is not in use. A minimum of 16,384 bytes of space must be reserved for the GPT Partition Entry Array.

If the block size is 512, the *First Usable LBA* must be greater than or equal to 34 (allowing 1 block for the Protective MBR, 1 block for the Partition Table Header, and 32 blocks for the GPT Partition Entry Array); if the logical block size is 4096, the *First Usable LBA* must be greater than or equal to 6 (allowing 1 block for the Protective MBR, 1 block for the GPT Header, and 4 blocks for the GPT Partition Entry Array).

The device may present a logical block size that is not 512 bytes long. In ATA, this is called the Long Logical Sector feature set; an ATA device reports support for this feature set in IDENTIFY DEVICE data word 106 bit 12 and reports the number of words (i.e., 2 bytes) per logical sector in IDENTIFY DEVICE data words 117-118 (see ATA8-ACS). A SCSI device reports its logical block size in the READ CAPACITY parameter data Block Length In Bytes field (see SBC-3).

The device may present a logical block size that is smaller than the physical block size (e.g., present a logical block size of 512 bytes but implement a physical block size of 4,096 bytes). In ATA, this is called the Long Physical Sector feature set; an ATA device reports support for this feature set in IDENTIFY DEVICE data word 106 bit 13 and reports the Physical Sector Size/Logical Sector Size exponential ratio in IDENTIFY DEVICE data word 106 bits 3-0 (See ATA8-ACS). A SCSI device reports its logical block size/physical

block exponential ratio in the READ CAPACITY (16) parameter data Logical Blocks Per Physical Block Exponent field (see SBC-3). These fields return  $2^x$  logical sectors per physical sector (e.g., 3 means  $2^3=8$  logical sectors per physical sector).

A device implementing long physical blocks may present logical blocks that are not aligned to the underlying physical block boundaries. An ATA device reports the alignment of logical blocks within a physical block in IDENTIFY DEVICE data word 209 (see ATA8-ACS). A SCSI device reports its alignment in the READ CAPACITY (16) parameter data Lowest Aligned Logical Block Address field (see SBC-3). Note that the ATA and SCSI fields are defined differently (e.g., to make LBA 63 aligned, ATA returns a value of 1 while SCSI returns a value of 7).

In SCSI devices, the Block Limits VPD page Optimal Transfer Length Granularity field (see SBC-3) may also report a granularity that is important for alignment purposes (e.g., RAID controllers may return their RAID stripe depth in that field)

GPT partitions should be aligned to the larger of:

- a the physical block boundary, if any
- b the optimal transfer length granularity, if any.

For example

- a If the logical block size is 512 bytes, the physical block size is 4,096 bytes (i.e., 512 bytes x 8 logical blocks), there is no optimal transfer length granularity, and logical block 0 is aligned to a physical block boundary, then each GPT partition should start at an LBA that is a multiple of 8.
- b If the logical block size is 512 bytes, the physical block size is 8,192 bytes (i.e., 512 bytes x 16 logical blocks), the optimal transfer length granularity is 65,536 bytes (i.e., 512 bytes x 128 logical blocks), and logical block 0 is aligned to a physical block boundary, then each GPT partition should start at an LBA that is a multiple of 128.

To avoid the need to determine the physical block size and the optimal transfer length granularity, software may align GPT partitions at significantly larger boundaries. For example, assuming logical block 0 is aligned, it may use LBAs that are multiples of 2,048 to align to 1,048,576 byte (1 MiB) boundaries, which supports most common physical block sizes and RAID stripe sizes.

References are as follows:

ISO/IEC 24739-200 [ANSI INCITS 452-2008] AT Attachment 8 - ATA/ATAPI Command Set (ATA8-ACS). By the INCITS T13 technical committee. (See "Links to UEFI-Related Documents" (<http://uefi.org/uefi>) under the headings "InterNational Committee on Information Technology Standards (INCITS)" and "INCITS T13 technical committee").

ISO/IEC 14776-323 [T10/1799-D] SCSI Block Commands - 3 (SBC-3). Available from [www.incits.org](http://www.incits.org). By the INCITS T10 technical committee (See "Links to UEFI-Related Documents" (<http://uefi.org/uefi>) under the headings "InterNational Committee on Information Technology Standards (INCITS)" and "SCSI Block Commands").

## 5.3.2 GPT Header

[Table 17](#) defines the GPT Header.



Table 17. GPT Header

Mnemonic	Byte Offset	Byte Length	Description
<i>Signature</i>	0	8	Identifies EFI-compatible partition table header. This value must contain the ASCII string "EFI PART", encoded as the 64-bit constant 0x5452415020494645.
<i>Revision</i>	8	4	The revision number for this header. This revision value is not related to the UEFI Specification version. This header is version 1.0, so the correct value is 0x00010000.
<i>HeaderSize</i>	12	4	Size in bytes of the GPT Header. The <i>HeaderSize</i> must be greater than or equal to 92 and must be less than or equal to the logical block size.
<i>HeaderCRC32</i>	16	4	CRC32 checksum for the GPT Header structure. This value is computed by setting this field to 0, and computing the 32-bit CRC for <i>HeaderSize</i> bytes.
<i>Reserved</i>	20	4	Must be zero.
<i>MyLBA</i>	24	8	The LBA that contains this data structure.
<i>AlternateLBA</i>	32	8	LBA address of the alternate GPT Header.
<i>FirstUsableLBA</i>	40	8	The first usable logical block that may be used by a partition described by a GUID Partition Entry.
<i>LastUsableLBA</i>	48	8	The last usable logical block that may be used by a partition described by a GUID Partition Entry.
<i>DiskGUID</i>	56	16	GUID that can be used to uniquely identify the disk.
<i>PartitionEntryLBA</i>	72	8	The starting LBA of the GUID Partition Entry array.
<i>NumberOfPartitionEntries</i>	80	4	The number of Partition Entries in the GUID Partition Entry array.
<i>SizeOfPartitionEntry</i>	84	4	The size, in bytes, of each the GUID Partition Entry structures in the GUID Partition Entry array. This field shall be set to a value of $128 \times 2^n$ where n is an integer greater than or equal to zero (e.g., 128, 256, 512, etc.). NOTE: Previous versions of this specification allowed any multiple of 8..

Mnemonic	Byte Offset	Byte Length	Description
<i>PartitionEntryArrayCRC32</i>	88	4	The CRC32 of the GUID Partition Entry array. Starts at <i>PartitionEntryLBA</i> and is computed over a byte length of <i>NumberOfPartitionEntries * SizeOfPartitionEntry</i> .
<i>Reserved</i>	92	BlockSi ze - 92	The rest of the block is reserved by UEFI and must be zero.

The following test must be performed to determine if a GPT is valid:

- Check the Signature
- Check the Header CRC
- Check that the *MyLBA* entry points to the LBA that contains the GUID Partition Table
- Check the CRC of the GUID Partition Entry Array

If the GPT is the primary table, stored at LBA 1:

- Check the *AlternateLBA* to see if it is a valid GPT

If the primary GPT is corrupt, software must check the last LBA of the device to see if it has a valid GPT Header and point to a valid GPT Partition Entry Array. If it points to a valid GPT Partition Entry Array, then software should restore the primary GPT if allowed by platform policy settings (e.g. a platform may require a user to provide confirmation before restoring the table, or may allow the table to be restored automatically). Software must report whenever it restores a GPT.

Software should ask a user for confirmation before restoring the primary GPT and must report whenever it does modify the media to restore a GPT. If a GPT formatted disk is reformatted to the legacy MBR format by legacy software, the last logical block might not be overwritten and might still contain a stale GPT. If GPT-cognizant software then accesses the disk and honors the stale GPT, it will misinterpret the contents of the disk. Software may detect this scenario if the legacy MBR contains valid partitions rather than a protective MBR (see [Section 5.2.1](#)).

Any software that updates the primary GPT must also update the backup GPT. Software may update the GPT Header and GPT Partition Entry Array in any order, since all the CRCs are stored in the GPT Header. Software must update the backup GPT before the primary GPT, so if the size of device has changed (e.g. volume expansion) and the update is interrupted, the backup GPT is in the proper location on the disk

If the primary GPT is invalid, the backup GPT is used instead and it is located on the last logical block on the disk. If the backup GPT is valid it must be used to restore the primary GPT. If the primary GPT is valid and the backup GPT is invalid software must restore the backup GPT. If both the primary and backup GPTs are corrupted this block device is defined as not having a valid GUID Partition Header.

Both the primary and backup GPTs must be valid before an attempt is made to grow the size of a physical volume. This is due to the GPT recovery scheme depending on locating the backup GPT at the end of the device. A volume may grow in size when disks are added

to a RAID device. As soon as the volume size is increased the backup GPT must be moved to the end of the volume and the primary and backup GPT Headers must be updated to reflect the new volume size.

### 5.3.3 GPT Partition Entry Array

The GPT Partition Entry Array contains an array of GPT Partition Entries. [Table 18](#) defines the GPT Partition Entry.

**Table 18. GPT Partition Entry**

Mnemonic	Byte Offset	Byte Length	Description
<i>PartitionTypeGUID</i>	0	16	Unique ID that defines the purpose and type of this Partition. A value of zero defines that this partition entry is not being used.
<i>UniquePartitionGUID</i>	16	16	GUID that is unique for every partition entry. Every partition ever created will have a unique GUID. This GUID must be assigned when the GPT Partition Entry is created. The GPT Partition Entry is created whenever the <i>NumberOfPartitionEntries</i> in the GPT Header is increased to include a larger range of addresses.
<i>StartingLBA</i>	32	8	Starting LBA of the partition defined by this entry.
<i>EndingLBA</i>	40	8	Ending LBA of the partition defined by this entry.
<i>Attributes</i>	48	8	Attribute bits, all bits reserved by UEFI (see <a href="#">Table 19</a> ).
<i>PartitionName</i>	56	72	Null-terminated string containing a human-readable name of the partition.
<i>Reserved</i>	128	<i>SizeOfPartitionEntry</i> - 128	The rest of the GPT Partition Entry, if any, is reserved by UEFI and must be zero.

The *SizeOfPartitionEntry* variable in the GPT Header defines the size of each GUID Partition Entry. Each partition entry contains a *Unique Partition GUID* value that uniquely identifies every partition that will ever be created. Any time a new partition entry is created a new GUID must be generated for that partition, and every partition is guaranteed to have a unique GUID. The partition is defined as all the logical blocks inclusive of the *StartingLBA* and *EndingLBA*.

The *PartitionTypeGUID* field identifies the contents of the partition. This GUID is similar to the *OS Type* field in the MBR. Each filesystem must publish its unique GUID. The *Attributes* field can be used by utilities to make broad inferences about the usage of a partition and is defined in [Table 19](#).

The firmware must add the *PartitionTypeGuid* to the handle of every active GPT partition using [EFI\\_BOOT\\_SERVICES.InstallProtocolInterface\(\)](#). This will allow drivers and applications, including OS loaders, to easily search for handles that represent EFI System Partitions or vendor specific partition types.

Software that makes copies of GPT-formatted disks and partitions must generate new *Disk GUID* values in the GPT Headers and new *Unique Partition GUID* values in each GPT Partition Entry. If GPT-cognizant software encounters two disks or partitions with identical GUIDs, results will be indeterminate.

**Table 19. Defined GPT Partition Entry - Partition Type GUIDs**

Description	GUID Value
Unused Entry	00000000-0000-0000-0000-000000000000
EFI System Partition	C12A7328-F81F-11D2-BA4B-00A0C93EC93B
Partition containing a legacy MBR	024DEE41-33E7-11D3-9D69-0008C781F39F

OS vendors need to generate their own Partition Type GUIDs to identify their partition types.

Table 20. Defined GPT Partition Entry - Attributes

Bits	Name	Description
Bit 0	Required Partition	If this bit is set, the partition is required for the platform to function. The owner/creator of the partition indicates that deletion or modification of the contents can result in loss of platform features or failure for the platform to boot or operate. The system cannot function normally if this partition is removed, and it should be considered part of the hardware of the system. Actions such as running diagnostics, system recovery, or even OS install or boot could potentially stop working if this partition is removed. Unless OS software or firmware recognizes this partition, it should never be removed or modified as the UEFI firmware or platform hardware may become non-functional.
Bit 1	No Block IO Protocol	If this bit is set, then firmware must not produce an <b>EFI_BLOCK_IO_PROTOCOL</b> device for this partition. See <a href="#">Section 13.3.2</a> for more details. By not producing an <b>EFI_BLOCK_IO_PROTOCOL</b> partition, file system mappings will not be created for this partition in UEFI.
Bit 2	Legacy BIOS Bootable	This bit is set aside by this specification to let systems with traditional PC-AT BIOS firmware implementations inform certain limited, special-purpose software running on these systems that a GPT partition may be bootable. For systems with firmware implementations conforming to this specification, the UEFI boot manager (see chapter 3) must ignore this bit when selecting a UEFI-compliant application, e.g., an OS loader (see 2.1.3). Therefore there is no need for this specification to define the exact meaning of this bit.
Bits 3-47		Undefined and must be zero. Reserved for expansion by future versions of the UEFI specification.
Bits 48-63		Reserved for GUID specific use. The use of these bits will vary depending on the <i>PartitionTypeGUID</i> . Only the owner of the <i>PartitionTypeGUID</i> is allowed to modify these bits. They must be preserved if Bits 0-47 are modified.

### Related Definitions:

```
#pragma pack(1)
///
/// GPT Partition Entry.
///
typedef struct {
    EFI_GUID PartitionTypeGUID;
    EFI_GUID UniquePartitionGUID;
    EFI_LBA StartingLBA;
    EFI_LBA EndingLBA;
    UINT64 Attributes;
    CHAR16 PartitionName[36];
} EFI_PARTITION_ENTRY;
#pragma pack()
```



## 6 Block Translation Table (BTT) Layout

This specification defines the Block Translation Table (BTT) metadata layout. The following sub-sections outline the BTT format that is utilized on the media, the data structures involved, and a detailed description of how SW is to interpret the BTT layout.

### 6.1 Block Translation Table (BTT) Background

A namespace defines a contiguously-addressed range of Non-Volatile Memory conceptually similar to a SCSI Logical Unit (LUN) or a NVM Express namespace.

Any namespace being utilized for block storage may contain a Block Translation Table (BTT), which is a layout and set of rules for doing block I/O that provide powerfail write atomicity of a single block. Traditional block storage, including hard disks and SSDs, usually protect against *torn sectors*, which are sectors partially written when interrupted by power failure. Existing software, mostly file systems, depend on this behavior, often without the authors realizing it. To enable such software to work correctly on namespaces supporting block storage access, the BTT layout defined by this document sub-divides a namespace into one or more BTT Arenas, which are large sections of the namespace that contain the metadata required to provide the desired write atomicity. Each of these BTT Arenas contains a metadata layout as shown in [Figure 20](#) and [Figure 21](#).

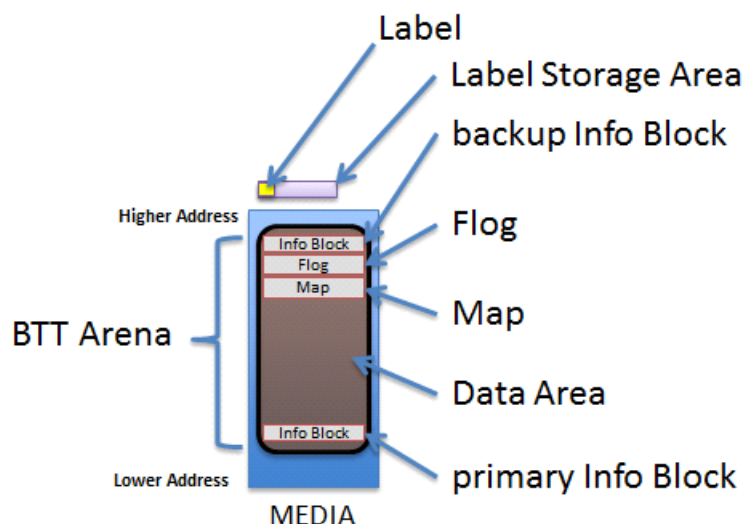

Figure 20. The BTT Layout in a BTT Arena

Each arena contains the layout shown in **Figure: The BTT Layout in a BTT Arena**, the primary info block, data area, map, flog, and a backup info block. Each of these areas is described in the following sections. When the namespace is larger than 512 GiB, multiple arenas are required by the BTT layout, as shown in [Figure 21](#). Each namespace using a BTT is divided into as many 512 GiB arenas as shall fit, followed by a smaller arena to

contain any remaining space as appropriate. The smallest arena size is 16MiB so the last arena size shall be between 16MiB and 512GiBs. Any remaining space less than 16MiB is unused. Because of these rules for arena placement, software can locate every primary Info block and every backup Info block without reading any metadata, based solely on the namespace size.

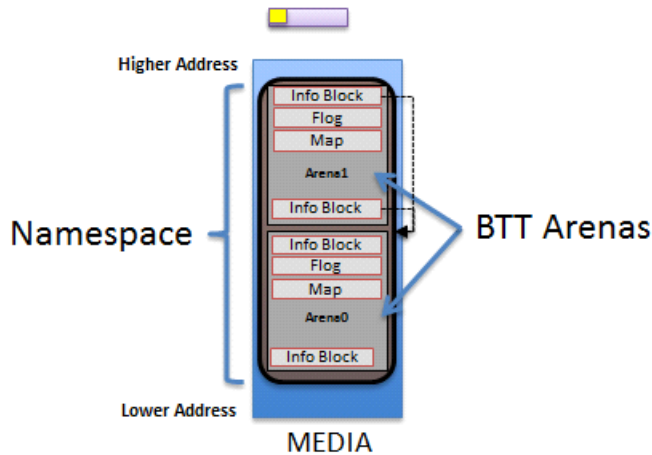

Figure 21. A BTT With Multiple Arenas in a Large Namespace

## 6.2 Block Translation Table (BTT) Data Structures

The following sub-sections outline the data structures associated with the BTT Layout.

### 6.2.1 BTT Info Block

```
// Alignment of all BTT structures
#define EFI_BTT_ALIGNMENT 4096
#define EFI_BTT_INFO_UNUSED_LEN 3968

#define EFI_BTT_INFO_BLOCK_SIG_LEN 16

// Constants for Flags field
#define EFI_BTT_INFO_BLOCK_FLAGS_ERROR 0x00000001

// Constants for Major and Minor version fields
#define EFI_BTT_INFO_BLOCK_MAJOR_VERSION 2
#define EFI_BTT_INFO_BLOCK_MINOR_VERSION 0

typedef struct _EFI_BTT_INFO_BLOCK {
    CHAR8  Sig[EFI_BTT_INFO_BLOCK_SIG_LEN];
    EFI_GUID  Uuid;
    EFI_GUID  ParentUuid;
}
```



```

    UINT32  Fl ags;
    UINT16  Major;
    UINT16  Minor;
    UINT32  External LbaSi ze;
    UINT32  External NLba;
    UINT32  Internal LbaSi ze;
    UINT32  Internal NLba;
    UINT32  NFree;
    UINT32  InfoSi ze;
    UINT64  NextOff;
    UINT64  DataOff;
    UINT64  MapOff;
    UINT64  Fl ogOff;
    UINT64  InfoOff;
    CHAR8   Unused[EFI _BTT _I NFO _U NUSED _L EN];
    UINT64  Checksum;
} EFI _BTT _I NFO _B L O C K

```

## Sig

Signature of the BTT Index Block data structure. Shall be "BTT\_ARENA\_INFO\0\0".

## Uuid

UUID identifying this BTT instance. A new UUID is created each time the initial BTT Arenas are written. This value shall be identical across all BTT Info Blocks within all arenas within a namespace.

## ParentUuid

UUID of containing namespace, used when validating the BTT Info Block to ensure this instance of the BTT layout is intended for the current surrounding namespace, and not left over from a previous namespace that used the same area of the media. This value shall be identical across all BTT Info Blocks within all arenas within a namespace.

## Flags

Boolean attributes of this BTT Info Block. See the additional description below on the use of the flags. The following values are defined:

**EFI\_BTT\_INFO\_BLOCK\_FLAGS\_ERROR** – The BTT Arena is in the error state. When a BTT implementation discovers issues such as inconsistent metadata or lost metadata due to unrecoverable media errors, the error bit for the associated arena shall be set. See the **BTT Theory of Operation** section regarding handling of **EFI\_BTT\_INFO\_BLOCK\_FLAGS\_ERROR**.

## Major

Major version number. Currently at version 2. This value shall be identical across all BTT Info Blocks within all arenas within a namespace.

## Minor

Minor version number. Currently at version 0. This value shall be identical across all BTT Info Blocks within all arenas within a namespace.

## ExternalLbaSize

Advertised LBA size in bytes. I/O requests shall be in this size chunk. This value shall be identical across all BTT Info Blocks within all arenas within a namespace.

## ExternalNLba

Advertised number of LBAs in this arena. The sum of this field, across all BTT Arenas, is the total number of available LBAs in the namespace.

## InternalLbaSize

Internal LBA size shall be greater than or equal to ExternalLbaSize and shall not be smaller than 512 bytes. Each block in the arena data area is this size in bytes and contains exactly one block of data. Optionally, this may be larger than the **ExternalLbaSize** due to alignment padding between LBAs. This value shall be identical across all BTT Info Blocks within all arenas within a namespace.

## InternalNLba

Number of internal blocks in the arena data area. This shall be equal to **ExternalNLba** + **NFree** because each internal lba is either mapped to an external lba or shown as free in the flog.

## NFree

Number of free blocks maintained for writes to this arena. **NFree** shall be equal to **InternalNLba** – **ExternalNLba**. This value shall be identical across all BTT Info Blocks within all arenas within a namespace.

## InfoSize

The size of this info block in bytes. This value shall be identical across all BTT Info Blocks within all arenas within a namespace.

## NextOff

Offset of next arena, relative to the beginning of this arena. An offset of 0 indicates that no arenas follow the current arena. This field is provided for convenience as the start of each arena can be calculated from the size of the namespace as described in the **Theory of Operation – Validating BTT Arenas at start-up** description. This value shall be identical in the primary and backup BTT Info Blocks within an arena.

## DataOff

Offset of the data area for this arena, relative to the beginning of this arena. The internal-LBA number zero lives at this offset. This value shall be identical in the primary and backup BTT Info Blocks within an arena.

**MapOff**

Offset of the map for this arena, relative to the beginning of this arena. This value shall be identical in the primary and backup BTT Info Blocks within an arena.

**FlogOff**

Offset of the flog for this arena, relative to the beginning of this arena. This value shall be identical in the primary and backup BTT Info Blocks within an arena.

**InfoOff**

Offset of the backup copy of this arena's info block, relative to the beginning of this arena. This value shall be identical in the primary and backup BTT Info Blocks within an arena.

**Reserved**

Shall be zero.

**Checksum**

64-bit *Fletcher64* checksum of all fields. This field is considered as containing zero when the checksum is computed.

**BTT Info Block Description**

The existence of a valid BTT Info Block is used to determine whether a namespace is used as a BTT block device.

Each BTT Arena contains two BTT Info Blocks, a primary copy at the beginning of the BTT Arena, at address offset 0, and ends with an identical backup BTT Info Block, in the highest block available in the arena aligned on a `EFI_BTT_ALIGNMENT` boundary. When writing the BTT layout, implementations shall write out the info blocks from the highest arena to the lowest, writing the backup info block and other BTT data structures before writing the primary info block. Writing the layout in this manner shall ensure that a valid BTT layout is only detected after the entire layout has been written.

**6.2.2 BTT Map Entry**

```
typedef struct _EFI_BTT_MAP_ENTRY {
    UINT32 PostMapLba : 30;
    UINT32 Error : 1;
    UINT32 Zero : 1;
} EFI_BTT_MAP_ENTRY;
```

**PostMapLba**

Post-map LBA number (block number in this arena's data area)

**Error**

When set and **Zero** is not set, reads on this block return an error. Writes to this block clear this flag.

## Zero

When set and **Error** is not set, reads on this block return a full block of zeros. Writes to this block clear this flag.

## BTT Map Description

The BTT Map area maps an LBA that indexes into the arena, to its actual location. The BTT Map is located as high as possible in the arena, after room for the backup info block and flog (and any required alignment) has been taken into account. The terminology *pre-map LBA* and *post-map LBA* is used to describe the input and output values of this mapping.

The BTT Map area is indexed by the pre-map LBA and each entry in the map contains the 30 bit post-map LBA and bits to indicate if there is an error or if LBA contains zeroes (see `EFI_BTT_MAP_ENTRY`).

The **Error** and **Zero** bits indicate conditions that cannot both be true at the same time, so that combination is used to indicate a *normal* map entry, where no error or zeroed block is indicated. The error condition is indicated only when the **Error** bit is set and the **Zero** bit is clear, with similar logic for the zero block condition. When neither condition is indicated, both **Error** and **Zero** are set to indicate a map entry in its normal, non-error state. This leaves the case where both **Error** and **Zero** are bits are zero, which is the initial state of all map entries when the BTT layout is first written. Both bits zero means that the map entry contains the initial *identity* mapping where the pre-map LBA is mapped to the same post-map LBA. Defining the map this way allows an implementation to leverage the case where the initial contents of the namespace is known to be zero, requiring no writes to the map when writing the layout. This can greatly improve the layout time since the map is the largest BTT data structure written during layout.

### 6.2.3 BTT Flog

```
// Alignment of each flog structure
#define EFI_BTT_FLOG_ENTRY_ALIGNMENT 64

typedef struct _EFI_BTT_FLOG {
    UINT32 Lba0;
    UINT32 OldMap0;
    UINT32 NewMap0;
    UINT32 Seq0;
    UINT32 Lba1;
    UINT32 OldMap1;
    UINT32 NewMap1;
    UINT32 Seq1;
} EFI_BTT_FLOG
```

## Lba0

Last pre-map LBA written using this flog entry. This value is used as an index into the BTT Map when updating it to complete the transaction.

## OldMap0

Old post-map LBA. This is the old entry in the map when the last write using this flog entry occurred. If the transaction is complete, this LBA is now the free block associated with this flog entry.

## NewMap0

New post-map LBA. This is the block allocated when the last write using this flog entry occurred. By definition, a write transaction is complete if the BTT Map entry contains this value.

## Seq0

The **Seq0** field in each flog entry is used to determine which set of fields is newer between the two sets (Lba0, OldMap0, NewMpa0, Seq0 vs Lba1, Oldmap1, NewMap1, Seq1). Updates to a flog entry shall always be made to the older set of fields and shall be implemented carefully so that the **Seq0** bits are only written after the other fields are known to be committed to persistence. The figure below shows the progression of the **Seq0** bits over time, where the newer entry is indicated by a value that is clockwise of the older value.

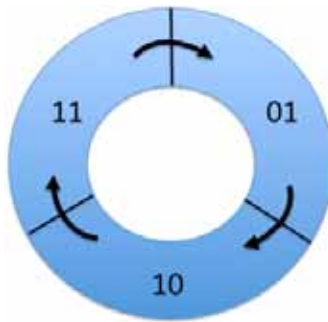

Figure 22. Cyclic Sequence Numbers for Flog Entries

## Lba1

Alternate lba entry

## OldMap1

Alternate old entry

## NewMap1

Alternate new entry

## Seq1

Alternate Seq entry

## BTT Flog Description

The BTT Flog is so named to illustrate that it is both a free list and a log, rolled into one data structure. The Flog size is determined by the **NFree** field in the BTT Info Block which determines how many of these flog entries there are. The flog location is the highest address in the arena after space for the backup info block and alignment requirements have been taken in account.

### 6.2.4 BTT Data Area

Starting from the low address to high, the BTT Data Area starts immediately after the BTT Info Block and extends to the beginning of the BTT Map data structure. The number of internal data blocks that can be stored in an arena is calculated by first calculating the necessary space required for the BTT Info Blocks, map, and flog (plus any alignment required), subtracting that amount from the total arena size, and then calculating how many blocks fit into the resulting space.

### 6.2.5 NVDIMM Label Protocol Address Abstraction Guid

This version of the BTT layout and behavior is collectively described by the AddressAbstractionGuid in the UEFI NVDIMM Label protocol section utilizing this GUID:

```
#define EFI_BTT_ABSTRACTION_GUID \
  {0x18633bfc,0x1735,0x4217,
   {0x8a,0xc9,0x17,0x23,0x92,0x82,0xd3,0xf8}}
```

## 6.3 BTT Theory of Operation

This section outlines the theory of operation for the BTT and describes the responsibilities that any software implementation shall follow.

A specific instance of the BTT layout depends on the size of the namespace and three administrative choices made at the time the initial layout is created:

- **ExternalLbaSize**: the desired block size
- **InternalLbaSize**: the block size with any internal padding
- **NFree**: the number of concurrent writes supported by the layout

The BTT data structures do not support an **InternalLbaSize** smaller than 512 bytes, so if **ExternalLbaSize** is smaller than 512 bytes, the **InternalLbaSize** shall be rounded up to 512. For performance, the **InternalLbaSize** may also include some padding bytes. For example, a BTT layout supporting 520-byte blocks may use 576-byte blocks internally in order to round up the size to a multiple of a 64-byte cache line size. In this example, the **ExternalLbaSize**, visible to software above the BTT software, would be 520 bytes, but the **InternalLbaSize** would be 576 bytes.

Once these administrative choices above are determined, the namespace is divided up into *arenas*, as described in the **BTT Arenas** section, where each arena uses the same values for **ExternalLbaSize**, **InternalLbaSize**, and **Nfree**.

### 6.3.1 BTT Arenas

In order to reduce the size of BTT metadata and increase the possibility of concurrent updates, the BTT layout in a namespace is divided into *arenas*. An arena cannot be larger than 512GiB or smaller than 16MiB. A namespace is divided into as many 512GiB arenas that shall fit, starting from offset zero and packed together without padding, followed by one arena smaller than 512GiB if the remaining space is at least 16MiB. The smaller arena size is rounded down to be a multiple of EFI\_BTT\_ALIGNMENT if necessary. Because of these rules, the location and size of every BTT Arena in a namespace can be determined from the namespace size.

Within an arena, the amount of space used for the Flog is **NFree** times the amount of space required for each Flog entry. Flog entries shall be aligned on 64-byte boundaries. In addition, the full BTT Flog table shall be aligned on a EFI\_BTT\_ALIGNMENT boundary and have a size that is padded to be multiple of EFI\_BTT\_ALIGNMENT. In summary, the space in an arena taken by the Flog is:

$$\text{FlogSize} = \text{roundup}(\text{NFree} * \text{roundup}(\text{sizeof}(\text{EFI\_BTT\_FLOG}), \text{EFI\_BTT\_FLOG\_ENTRY\_ALIGNMENT}), \text{EFI\_BTT\_ALIGNMENT})$$

Within an arena, the amount of space available for data blocks and the associated Map is the arena size minus the space used for the BTT Info Blocks and the Flog:

$$\text{DataAndMapSize} = \text{ArenaSize} - 2 * \text{sizeof}(\text{EFI\_BTT\_INFO\_BLOCK}) - \text{FlogSize}$$

Within an arena, the number of data blocks is calculated by dividing the available space, DataAndMapSize, by the **InternalLbaSize** plus the map overhead required for each block, and rounding down the result to ensure the data area is aligned on a EFI\_BTT\_ALIGNMENT boundary:

$$\text{InternalNLba} = (\text{DataAndMapSize} - \text{EFI\_BTT\_ALIGNMENT}) / (\text{InternalLbaSize} + \text{sizeof}(\text{EFI\_BTT\_MAP\_ENTRY}))$$

With the **InternalNLba** value known, the calculation for the number of external LBAs subtracts off **NFree** for the pool of unadvertised free blocks:

$$\text{ExternalNLba} = \text{InternalNLba} - \text{Nfree}$$

Within an arena, the number of bytes required for the BTT Map is one entry for each external LBA, plus any alignment required to maintain an alignment of EFI\_BTT\_ALIGNMENT for the entire map:

$$\text{MapSize} = \text{roundup}(\text{ExternalNLba} * \text{sizeof}(\text{EFI\_BTT\_MAP\_ENTRY}), \text{EFI\_BTT\_ALIGNMENT})$$

The number of concurrent writes allowed for an arena is based on the **NFree** value chosen at BTT layout time. For example, choosing **NFree** of 256 means the BTT Arena shall have 256 free blocks to use for in-flight write operations. Since BTT Arenas each have **NFree** free blocks, the number of concurrent writes allowed in a namespace may be larger when there are multiple arenas and the writes are spread out between multiple arenas.

### 6.3.2 Atomicity of Data Blocks in an Arena

The primary reason for the BTT is to provide failure atomicity when writing data blocks, so that any write of a single block cannot be torn by interruptions such as power loss. The BTT provides this by maintaining a pool of free blocks which are not part of the capacity

advertised to software layers above the BTT software. The BTT Data Area is large enough to hold the advertised capacity as well as the pool of free blocks. The BTT software manages the blocks in the BTT Data Area as a list of *internal LBAs*, which are block numbers only visible internally to the BTT software. The block numbers that make up the advertised capacity are known as *external LBAs*, and at any given point in time, each one of those external LBAs is mapped by the BTT Map to one of the blocks in the BTT Data Area. Each block write done by the BTT software starts by allocating one of the free blocks, writing the data to it, and only when that block is fully persistent (including any flushes required), are steps taken to make that block active, as outlined in the **BTT Theory of Operations – Write Path** section.

The BTT Flog (a combination of a free list and a log) is at the heart of the atomic updates when writing blocks. The “quiet” state of a BTT Flog, when no in-flight writes are happening and no recovery steps are outstanding, is that the **NFree** free blocks currently available for writes are contained in the OldMap fields in the Flog entries. A write shall use one of those Flog entries to find a free block to write to, and then the Lba and NewMap fields in the Flog are used as a *write-ahead-log* for the BTT Map update when the data portion of the write is complete, as described in the **Validating the Flog at start-up** section.

It is up to run-time logic in the BTT software to ensure that only one Flog entry is in use at a time, and that any reads still executing on the block indicated by the OldMap entry have finished before starting a write using that block.

### 6.3.3 Atomicity of BTT Data Structures

Byte-addressable persistent media may not support atomic updates larger than 8-bytes, so any data structure larger than 8-bytes in the BTT uses software-implemented atomicity for updates. Note that 8-byte write atomicity, meaning an 8-byte store to the persistent media cannot be torn by interruptions such as power failures, is a minimal requirement for using the BTT described in this document.

There are four types of data structures in the BTT:

- The BTT Info Blocks
- The BTT Map
- The BTT Flog
- The BTT Data Area

The BTT Map entries are 4-bytes in size, and so can be updated atomically with a single store instruction. All other data structures are updated by following the rules described in this document, which update an inactive version of the data structure first, followed by steps to make it active atomically.

For the BTT Info Blocks, atomicity is provided by always writing the backup Info block first, and only after that update is fully persistent (the block checksums correctly), is the primary BTT Info Block updated as described in the **Writing the initial BTT layout** section. Recovery from an interrupted update is provided by checking the primary Info block’s checksum on start-up, and if it is bad, copying the backup Info block to the



primary to complete the interrupted update as described in the **Validating BTT Arenas at start-up** section.

For the BTT Flog, each entry is double-sized, with two complete copies of every field (Lba, OldMap, NewMap, Seq). The active entry has the higher Seq number, so updates always write to the inactive fields, and once those fields are fully persistent, the Seq field for the inactive entry is updated to make it become the active entry atomically. This is described in the **Validating the Flog at start-up** section.

For the BTT Data Area, all block writes can be thought of as *allocating writes*, where an inactive block is chosen from the free list maintained by the Flog, and only after the new data written to that block is fully persistent, that block is made active atomically by updating the Flog and Map entries as described in the **Write Path** section.

### 6.3.4 Writing the Initial BTT layout

The overall layout of the BTT relies on the fact that all arenas shall be 512GiB in size, except the last arena which is a minimum of 16MiB. Initializing the BTT on-media structures only happens once in the lifetime of a BTT, when it is created. This sequence assumes that software has determined that new BTT layout needs to be created and the total raw size of the namespace is known.

Immediately before creating a new BTT layout, the UUID of the surrounding namespace may be updated to a newly-generated UUID. This optional step, depending on the needs of a BTT software implementation, has the effect of invalidating any previous BTT Info Blocks in the namespace and ensuring the detection of an invalid layout if the BTT layout creation process is interrupted. This detection works because the parent UUID field

The on-media structures in the BTT layout may be written out in any order except for the BTT Info Blocks, which shall be written out as the last step of the layout, starting from the last arena (highest offset in the namespace) to the first arena (lowest offset in the namespace), writing the backup BTT Info Block in each arena first, then writing the primary BTT Info block for that arena second. This allows the detection of an incomplete BTT layout when the algorithm in the **Validating BTT Arenas at start-up** section is executed.

Since the number of internal LBAs for an arena exceeds the number of external LBAs by **NFree**, there are enough internal LBA numbers to fully initialize the BTT Map as well as the BTT Flog, where the BTT Flog is initialized with the **NFree** highest internal LBA numbers, and the rest are used in the BTT Map.

The BTT Map in each arena is initialized to zeros. Zero entries in the map indicate the *identity* mapping of all pre-map LBAs to the corresponding post-map LBAs. This uses all but **NFree** of the internal LBAs, leaving **Nfree** of them for the BTT Flog.

The BTT Flog in each arena is initialized by starting with all zeros for the entire flog area, setting the **Lba0** field in each flog entry to unique pre-map LBAs, zero through **NFree - 1**, and both **OldMap0** and **NewMap0** fields in each flog entry are set to one of the remaining internal LBAs. For example, flog entry zero would have Lba0 set to 0, and **OldMap0** and **NewMap0** both set to the first internal LBA not represented in the map (since there are **ExternalNLba** entries in the map, the next available internal LBA is equal to **ExternalNLba**).

### 6.3.5 Validating BTT Arenas at start-up

When software prepares to access the BTT layout in a namespace, the first step is to check the BTT Arenas for consistency. Reading and validating BTT Arenas relies on the fact that all arenas shall be 512GiB in size, except the last arena which is a minimum of 16MiB.

The following tests shall pass before software considers the BTT layout to be valid:

- For each BTT Arena:
  - ReadAndVerifyPrimaryBttInfoBlock
    - If the read of the primary BTT Info Block fails, goto ReadAndVerifyBackupBttInfoBlock
    - If the primary BTT Info Block contains an incorrect **Sig** field it is invalid, goto ReadAndVerifyBackupBttInfoBlock
    - If the primary BTT Info Block ParentUuid field does not match the UUID of the surrounding namespace, goto ReadAndVerifyBackupBttInfoBlock
    - If the primary BTT Info Block contains an incorrect **Checksum** it is invalid, goto ReadAndVerifyBackupBttInfoBlock
    - The primary BTT Info Block is valid. Use the **NextOff** field to find the start of the next arena and continue BTT Info Block validation, goto ReadAndVerifyPrimaryBttInfoBlock
  - ReadAndVerifyBackupBttInfoBlock
    - Determine the location of the backup BTT Info Block:
      - 1.All of the arenas shall be the full 512GiB data area size except the last arena which is at least 16MiB.
      - 2.The backup BTT Info Block is the last EFI\_BTT\_ALIGNMENT aligned block in the arena.
    - If the read of the backup BTT Info Block at the high address of the BTT Arena fails, neither copy could be read, and software shall assume that there is no valid BTT metadata layout for the namespace
    - If the backup BTT Info Block contains an incorrect **Sig** field it is invalid, and software shall assume that there is no valid BTT metadata layout for the namespace
    - If the backup BTT Info Block ParentUuid field does not match the UUID of the surrounding namespace it is invalid, and software shall assume that there is no valid BTT metadata layout for the namespace
    - If the backup BTT Info Block contains an incorrect **Checksum** it is invalid, and software shall assume that there is no valid BTT metadata layout for the namespace
    - The backup BTT Info Block is valid. Since the primary copy is bad, software shall copy the contents of the valid backup BTT Info Block down to the primary BTT Info Block before validation of all of the BTT Info Blocks in all of the arenas can complete successfully.

### 6.3.6 Validating the Flog entries at start-up

After validating the BTT Info Blocks as described in the **Validating BTT Arenas at start-up** section, the next step software shall take is to validate the BTT Flog entries. When blocks of data are being written, as described in the **Write Path** section below, the persistent Flog and Map states are not updated until the free block is written with new data. This ensures a power failure at any point during the data transfer is harmless, leaving the partially written data in a free block that remains free. Once the Flog is updated (made atomic by the Seq bits in the Flog entry), the write algorithm is committed to the update and a power failure from this point in the write flow onwards shall be handled by completing the update to the BTT Map on recovery. The Flog contains all the information required to complete the Map entry update.

Note that the Flog entry recovery outlined here is intended to happen single-threaded, on an *inactive* BTT (before the BTT block namespace is allowed to accept I/O requests). The maximum amount of time required for recovery is determined by **NFree**, but is only a few loads and a single store (and the corresponding cache flushes) for each incomplete write discovered.

The following steps are executed for each flog entry in each arena, to recover any interrupted writes and to verify the flog entries are consistent at start up. Any consistency issues found during these steps results in setting the error state (EFI\_BTT\_INFO\_BLOCK\_FLAGS\_ERROR) for the arena and terminates the flog validation process for this arena.

1. The **Seq0** and **Seq1** fields are examined for the flog entry. If both fields are zero, or both fields are equal to each other, the flog entry is inconsistent. Otherwise, the higher Seq field indicates which set of flog fields to use for the next steps (**Lba0**, **OldMap0**, **NewMap0**, versus **Lba1**, **OldMap1**, **NewMap1**). From this point on in this section, the chosen fields are referenced as Lba, OldMap, and NewMap.
2. If OldMap and NewMap are equal, this is a flog entry that was never used since the initial layout of the BTT was created.
3. The Lba field is checked to ensure it is a valid pre-map LBA (in the range zero to **ExternalNLba** – 1). If the check fails, the flog entry is inconsistent.
4. The BTT Map entry corresponding to the Flog entry Lba field is fetched. Since the Map can contain special zero entries to indicate identity mappings, the fetched entry is adjusted to the corresponding internal LBA when a zero is encountered (by interpreting the entry as the same LBA as the Flog entry Lba field).
5. If the adjusted map entry from the previous step does not match the NewMap field in the Flog entry, and it matches the OldMap field, then an interrupted BTT Map update has been detected. The recovery step is to write the NewMap field to the BTT Map entry indexed by the Flog entry Lba field.

### 6.3.7 Read Path

The following high level sequence describes the steps to read a single block of data while utilizing the BTT as is illustrated in the **Figure: BTT Read Path Overview** below:

1. If `EFI_BTT_INFO_BLOCK_FLAGS_ERROR` is set in the arena's BTT Info Block, the BTT software may return an error for the read, or an implementation may choose to continue to provide read-only access and continue these steps.
2. Use the external LBA provided with the read operation to determine which BTT Arena to access. Starting from the first arena (lowest offset in the namespace), and looping through the arena in order, the **ExternalLba** field in the BTT Info Block describes how many external LBAs are in that area. Once the correct arena is identified, the external LBAs contained in the lower, skipped, arenas are subtracted from the provided LBA to obtain the pre-map LBA for the selected arena.
3. Use the pre-map LBA to index into the arena's BTT Map and fetch the map entry.
4. If both the **Zero** and **Error** bits are set in the map entry, this indicates a normal entry. The `PostMapLba` field in the Map entry is used to index into the arena Data Area by multiplying it by the **InternalLbaSize** and adding the result to the **DataOff** field from the arena's BTT Info Block. This provides the location of the data in the arena and software then copies **ExternalLbaSize** bytes into the provided buffer to satisfy the read request.
5. Otherwise, if only the **Error** bit is set in the map entry, a read error is returned.
6. Otherwise, if only the **Zero** bit is set in the map entry, a block of **ExternalLbaSize** bytes of zeros is copied into the provided buffer to satisfy the read request.
7. Finally, if both **Zero** and **Error** bits are clear, this indicates the initial identity mapping and the pre-map LBA is used to index into the arena Data Area by multiplying it by the **InternalLbaSize** and adding the result to the **DataOff** field from the arena's BTT Info Block. This provides the location of the data in the arena and software then copies **ExternalLbaSize** bytes into the provided buffer to satisfy the read request.

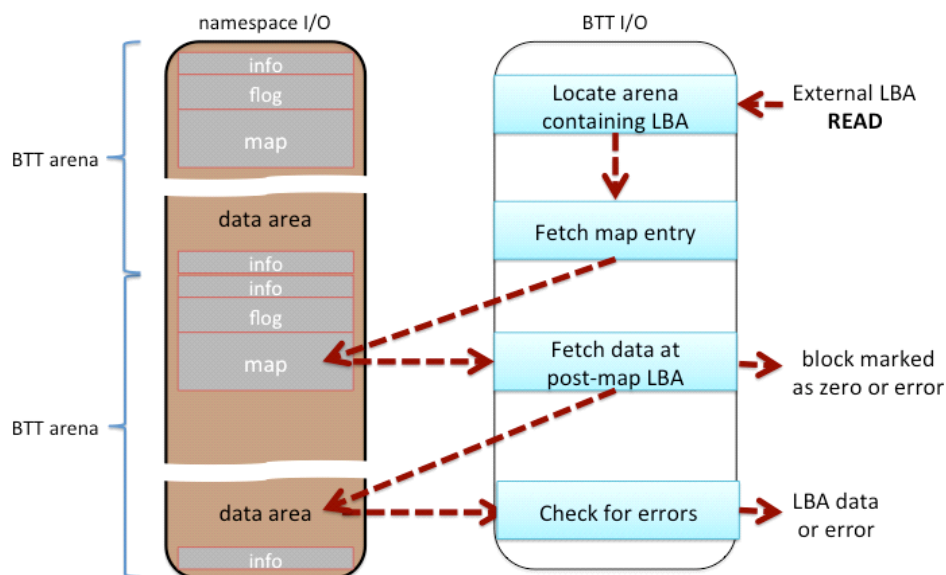

Figure 23. BTT Read Path Overview

### 6.3.8 Write Path

The following high level sequence describes the steps to write a single block of data while utilizing the BTT as is illustrated in the **Figure: BTT Write Path Overview** below:

1. If `EFI_BTT_INFO_BLOCK_FLAGS_ERROR` is set in the arena's BTT Info Block, the BTT software shall return an error for the write.
2. Use the external LBA provided with the write operation to determine which BTT Arena to access. Starting from the first arena (lowest offset in the namespace), and looping through the arena in order, the **ExternalNLba** field in the BTT Info Block describes how many external LBAs are in that area. Once the correct arena is identified, the external LBAs contained in the lower, skipped, arenas are subtracted from the provided LBA to obtain the pre-map LBA for the selected arena.
3. The BTT software allocates one of the Flog entries in the arena to be used for this write. The Flog entry shall not be shared by multiple concurrent writes. The exact method for managing the exclusive use of the Flog entries is BTT software implementation-dependent. There's no on-media indication of whether a Flog entry is currently allocated to a write request or not. Note that the free block tracked by the Flog entry in the OldMap field, may still have reads from relatively slow threads operating on it. The BTT software implementation shall ensure any such reads have completed before moving to the next step.
4. Lock out access to the BTT Map area associated with the pre-map LBA for the next three steps. The granularity of the locking is implementation-dependent; an implementation may choose to lock individual Map entries, lock the entire BTT Map, or something in-between.
5. Use the pre-map LBA to index into the arena's BTT Map and fetch the old map entry.
6. Update the Flog entry by writing the inactive set of Flog fields (the lower Seq number). First, update the Lba, OldMap, and NewMap fields with the pre-map LBA, old Map entry, and the free block chosen above, respectively. Once those fields are fully persistent (with any required flushes completed), the Seq field is updated to make the new fields active. This update of the Seq field commits the write – before this update, the write shall not take place if the operation is interrupted. After the Seq field is updated, the write shall take place even if the operation is interrupted because the Map update in the next step shall take place during the BTT recovery that happens on start-up.
7. Update the Map entry with the free block chosen above.
8. Drop the map lock acquired in step 4 above. The write request is now satisfied.

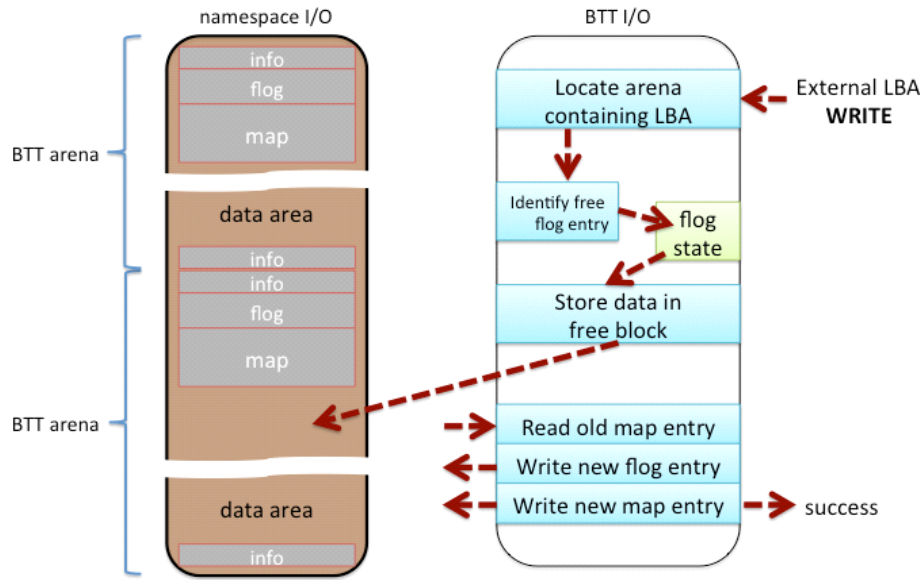

Figure 24. BTT Write Path Overview

## 7 Services — Boot Services

---

This section discusses the fundamental boot services that are present in a compliant system. The services are defined by interface functions that may be used by code running in the UEFI environment. Such code may include protocols that manage device access or extend platform capability, as well as applications running in the preboot environment, and OS loaders.

Two types of services apply in an compliant system:

Boot Services	Functions that are available <i>before</i> a successful call to <a href="#">EFI_BOOT_SERVICES.ExitBootServices()</a> . These functions are described in this section.
Runtime Services	Functions that are available <i>before and after</i> any call to <a href="#">ExitBootServices()</a> . These functions are described in <a href="#">Section 8</a> .

During boot, system resources are owned by the firmware and are controlled through boot services interface functions. These functions can be characterized as “global” or “handle-based.” The term “global” simply means that a function accesses system services and is available on all platforms (since all platforms support all system services). The term “handle-based” means that the function accesses a specific device or device functionality and may not be available on some platforms (since some devices are not available on some platforms). Protocols are created dynamically. This section discusses the “global” functions and runtime functions; subsequent sections discuss the “handle-based.”

UEFI applications (including UEFI OS loaders) must use boot services functions to access devices and allocate memory. On entry, an Image is provided a pointer to a system table which contains the Boot Services dispatch table and the default handles for accessing the console. All boot services functionality is available until a UEFI OS loader loads enough of its own environment to take control of the system's continued operation and then terminates boot services with a call to [ExitBootServices\(\)](#).

In principle, the [ExitBootServices\(\)](#) call is intended for use by the operating system to indicate that its loader is ready to assume control of the platform and all platform resource management. Thus boot services are available up to this point to assist the UEFI OS loader in preparing to boot the operating system. Once the UEFI OS loader takes control of the system and completes the operating system boot process, only runtime services may be called. Code other than the UEFI OS loader, however, may or may not choose to call [ExitBootServices\(\)](#). This choice may in part depend upon whether or not such code is designed to make continued use of boot services or the boot services environment.

The rest of this section discusses individual functions. Global boot services functions fall into these categories:

- Event, Timer, and Task Priority Services ([Section 7.1](#))
- Memory Allocation Services ([Section 7.2](#))
- Protocol Handler Services ([Section 7.3](#))

- Image Services ([Section 7.4](#))
- Miscellaneous Services ([Section 7.5](#))

## 7.1 Event, Timer, and Task Priority Services

The functions that make up the Event, Timer, and Task Priority Services are used during preboot to create, close, signal, and wait for events; to set timers; and to raise and restore task priority levels. See [Table 21](#).

**Table 21. Event, Timer, and Task Priority Functions**

Name	Type	Description
CreateEvent	Boot	Creates a general-purpose event structure
CreateEventEx	Boot	Creates an event structure as part of an event group
CloseEvent	Boot	Closes and frees an event structure
SignalEvent	Boot	Signals an event
WaitForEvent	Boot	Stops execution until an event is signaled
CheckEvent	Boot	Checks whether an event is in the signaled state
SetTimer	Boot	Sets an event to be signaled at a particular time
RaiseTPL	Boot	Raises the task priority level
RestoreTPL	Boot	Restores/lowers the task priority level

Execution in the boot services environment occurs at different task priority levels, or TPLs. The boot services environment exposes only three of these levels to UEFI applications and drivers:

- [TPL\\_APPLICATION](#), the lowest priority level
- [TPL\\_CALLBACK](#), an intermediate priority level
- [TPL\\_NOTIFY](#), the highest priority level

Tasks that execute at a higher priority level may interrupt tasks that execute at a lower priority level. For example, tasks that run at the **TPL\_NOTIFY** level may interrupt tasks that run at the **TPL\_APPLICATION** or **TPL\_CALLBACK** level. While **TPL\_NOTIFY** is the highest level exposed to the boot services applications, the firmware may have higher task priority items it deals with. For example, the firmware may have to deal with tasks of higher priority like timer ticks and internal devices. Consequently, there is a fourth TPL, [TPL\\_HIGH\\_LEVEL](#), designed for use exclusively by the firmware.

The intended usage of the priority levels is shown in [Table 22](#) from the lowest level (**TPL\_APPLICATION**) to the highest level (**TPL\_HIGH\_LEVEL**). As the level increases, the duration of the code and the amount of blocking allowed decrease. Execution generally occurs at the **TPL\_APPLICATION** level. Execution occurs at other levels as a direct result of the triggering of an event notification function (this is typically caused by the signaling of an event). During timer interrupts, firmware signals timer events when an event's "trigger time" has expired. This allows event notification functions to interrupt lower priority code to check devices (for example). The notification function can signal other



events as required. After all pending event notification functions execute, execution continues at the **TPL\_APPLICATION** level.

**Table 22. TPL Usage**

Task Priority Level	Usage
<b>TPL_APPLICATION</b>	This is the lowest priority level. It is the level of execution which occurs when no event notifications are pending and which interacts with the user. User I/O (and blocking on User I/O) can be performed at this level. The boot manager executes at this level and passes control to other UEFI applications at this level.
<b>TPL_CALLBACK</b>	Interrupts code executing below <b>TPL_CALLBACK</b> level Long term operations (such as file system operations and disk I/O) can occur at this level.
<b>TPL_NOTIFY</b>	Interrupts code executing below <b>TPL_NOTIFY</b> level Blocking is not allowed at this level. Code executes to completion and returns. If code requires more processing, it needs to signal an event to wait to obtain control again at whatever level it requires. This level is typically used to process low level IO to or from a device.
(Firmware Interrupts)	This level is internal to the firmware It is the level at which internal interrupts occur. Code running at this level interrupts code running at the <b>TPL_NOTIFY</b> level (or lower levels). If the interrupt requires extended time to complete, firmware signals another event (or events) to perform the longer term operations so that other interrupts can occur.
<b>TPL_HIGH_LEVEL</b>	Interrupts code executing below <b>TPL_HIGH_LEVEL</b> This is the highest priority level. It is not interruptible (interrupts are disabled) and is used sparingly by firmware to synchronize operations that need to be accessible from any priority level. For example, it must be possible to signal events while executing at any priority level. Therefore, firmware manipulates the internal event structure while at this priority level.

Executing code can temporarily raise its priority level by calling the [EFI\\_BOOT\\_SERVICES.RaiseTPL\(\)](#) function. Doing this masks event notifications from code running at equal or lower priority levels until the [EFI\\_BOOT\\_SERVICES.RestoreTPL\(\)](#) function is called to reduce the priority to a level below that of the pending event notifications. There are restrictions on the TPL levels at which many UEFI service functions and protocol interface functions can execute. [Table 23](#) summarizes the restrictions.

**Table 23. TPL Restrictions**

Name	Restrictions	Task Priority Level
ACPI Table Protocol	<	<b>TPL_NOTIFY</b>
ARP	<=	<b>TPL_CALLBACK</b>
ARP Service Binding	<=	<b>TPL_CALLBACK</b>
Authentication Info	<=	<b>TPL_NOTIFY</b>

Name	Restrictions	Task Priority Level
Block I/O Protocol	<=	TPL_CALLBACK
Block I/O 2 Protocol	<=	TPL_CALLBACK
Bluetooth Host Controller	<=	TPL_CALLBACK
Bluetooth IO Service Binding	<=	TPL_CALLBACK
Bluetooth IO	<=	TPL_CALLBACK
Bluetooth Attribute	<=	TPL_CALLBACK
Bluetooth Configuration	<=	TPL_CALLBACK
BluetoothLE Configuration	<=	TPL_CALLBACK
CheckEvent()	<	TPL_HIGH_LEVEL
CloseEvent()	<	TPL_HIGH_LEVEL
CreateEvent()	<	TPL_HIGH_LEVEL
Deferred Image Load Protocol	<=	TPL_NOTIFY
Device Path Utilities	<=	TPL_NOTIFY
Device Path From Text	<=	TPL_NOTIFY
DHCP4 Service Binding	<=	TPL_CALLBACK
DHCP4	<=	TPL_CALLBACK
DHCP6	<=	TPL_CALLBACK
DHCP6 Service Binding	<=	TPL_CALLBACK
Disk I/O Protocol	<=	TPL_CALLBACK
Disk I/O 2 Protocol	<=	TPL_CALLBACK
DNS4 Service Binding	<=	TPL_CALLBACK
DNS4	<=	TPL_CALLBACK
DNS6 Service Binding	<=	TPL_CALLBACK
DNS6	<=	TPL_CALLBACK
Driver Health	<=	TPL_NOTIFY
EAP	<=	TPL_CALLBACK
EAP Configuration	<=	TPL_CALLBACK
EAP Management	<=	TPL_CALLBACK
EAP Management2	<=	TPL_CALLBACK
EDID Active	<=	TPL_NOTIFY
EDID Discovered	<=	TPL_NOTIFY
EFI_SIMPLE_TEXT_INPUT_PROTOCOL	<=	TPL_CALLBACK
EFI_SIMPLE_TEXT_INPUT_PROTOCOL.ReadKeyStroke	<=	TPL_APPLICATION
EFI_SIMPLE_TEXT_INPUT_PROTOCOL.Reset	<=	TPL_APPLICATION

Name	Restrictions	Task Priority Level
EFI_SIMPLE_TEXT_INPUT_EX_PROTO COL	<=	<b>TPL_CALLBACK</b>
EFI_SIMPLE_TEXT_INPUT_EX_PROTO COL.ReadKeyStrokeEx	<=	<b>TPL_APPLICATION</b>
EFI_SIMPLE_TEXT_INPUT_EX_PROTO COL.Reset	<=	<b>TPL_APPLICATION</b>
Event Notification Levels	> <=	<b>TPL_APPLICATION</b> <b>TPL_HIGH_LEVEL</b>
Exit()	<=	<b>TPL_CALLBACK</b>
ExitBootServices()	=	<b>TPL_APPLICATION</b>
Form Browser2 Protocol/SendForm	=	<b>TPL_APPLICATION</b>
FTP	<=	<b>TPL_CALLBACK</b>
Graphics Output EDID Override	<=	<b>TPL_NOTIFY</b>
HII Protocols	<=	<b>TPL_NOTIFY</b>
HTTP Service Binding	<=	<b>TPL_CALLBACK</b>
HTTP	<=	<b>TPL_CALLBACK</b>
HTTP Utilities	<=	<b>TPL_CALLBACK</b>
IP4 Service Binding	<=	<b>TPL_CALLBACK</b>
IP4	<=	<b>TPL_CALLBACK</b>
IP4 Config	<=	<b>TPL_CALLBACK</b>
IP4 Config2	<=	<b>TPL_CALLBACK</b>
IP6	<=	<b>TPL_CALLBACK</b>
IP6 Config	<=	<b>TPL_CALLBACK</b>
IPSec Configuration	<=	<b>TPL_CALLBACK</b>
iSCSI Initiator Name	<=	<b>TPL_NOTIFY</b>
LoadImage()	<	<b>TPL_CALLBACK</b>
Managed Network Service Binding	<=	<b>TPL_CALLBACK</b>
Memory Allocation Services	<=	<b>TPL_NOTIFY</b>
MTFTP4 Service Binding	<=	<b>TPL_CALLBACK</b>
MTFTP4	<=	<b>TPL_CALLBACK</b>
MTFTP6	<=	<b>TPL_CALLBACK</b>
MTFTP6 Service Binding	<=	<b>TPL_CALLBACK</b>
PXE Base Code Protocol	<=	<b>TPL_CALLBACK</b>
Protocol Handler Services	<=	<b>TPL_NOTIFY</b>
REST	<=	<b>TPL_CALLBACK</b>
Serial I/O Protocol	<=	<b>TPL_CALLBACK</b>
SetTimer()	<	<b>TPL_HIGH_LEVEL</b>
SignalEvent()	<=	<b>TPL_HIGH_LEVEL</b>

Name	Restrictions	Task Priority Level
Simple File System Protocol	<=	TPL_CALLBACK
Simple Network Protocol	<=	TPL_CALLBACK
Simple Text Output Protocol	<=	TPL_NOTIFY
Stall()	<=	TPL_HIGH_LEVEL
StartImage()	<	TPL_CALLBACK
Supplicant	<=	TPL_CALLBACK
Tape IO	<=	TPL_NOTIFY
TCP4 Service Binding	<=	TPL_CALLBACK
TCP4	<=	TPL_CALLBACK
TCP6	<=	TPL_CALLBACK
TCP6 Service Binding	<=	TPL_CALLBACK
Time Services	<=	TPL_CALLBACK
TLS Service Binding	<=	TPL_CALLBACK
TLS	<=	TPL_CALLBACK
TLS Configuration	<=	TPL_CALLBACK
UDP4 Service Binding	<=	TPL_CALLBACK
UDP4	<=	TPL_CALLBACK
UDP6	<=	TPL_CALLBACK
UDP6 Service Binding	<=	TPL_CALLBACK
UnloadImage()	<=	TPL_CALLBACK
User Manager Protocol	<=	TPL_NOTIFY
User Manager Protocol/Identify()	=	TPL_APPLICATION
User Credential Protocol	<=	TPL_NOTIFY
User Info Protocol	<=	TPL_NOTIFY
Variable Services	<=	TPL_CALLBACK
VLAN Configuration	<=	TPL_CALLBACK
WaitForEvent()	=	TPL_APPLICATION
Wireless MAC Connection	<=	TPL_CALLBACK
Other protocols and services, if not listed above	<=	TPL_NOTIFY

## EFI\_BOOT\_SERVICES.CreateEvent()

### Summary

Creates an event.

### Prototype

```
typedef
EFI_STATUS
(EFIAPI *EFI_CREATE_EVENT) (
    IN UINT32    Type,
    IN EFI_TPL  NotifyTpl,
    IN EFI_EVENT_NOTIFY NotifyFunction, OPTIONAL
    IN VOID     *NotifyContext, OPTIONAL
    OUT EFI_EVENT *Event
);
```

### Parameters

<i>Type</i>	The type of event to create and its mode and attributes. The <b>#define</b> statements in “Related Definitions” can be used to specify an event’s mode and attributes.
<i>NotifyTpl</i>	The task priority level of event notifications, if needed. See <a href="#">EFI_BOOT_SERVICES.RaiseTPL()</a> .
<i>NotifyFunction</i>	Pointer to the event’s notification function, if any. See “Related Definitions.”
<i>NotifyContext</i>	Pointer to the notification function’s context; corresponds to parameter <i>Context</i> in the notification function.
<i>Event</i>	Pointer to the newly created event if the call succeeds; undefined otherwise.

### Related Definitions

```
/*******
// EFI_EVENT
//*****
typedef VOID *EFI_EVENT

/*******
// Event Types
//*****
// These types can be “ORed” together as needed – for example,
// EVT_TIMER might be “Ored” with EVT_NOTIFY_WAIT or
// EVT_NOTIFY_SIGNAL.
#define EVT_TIMER          0x80000000
#define EVT_RUNTIME       0x40000000

#define EVT_NOTIFY_WAIT   0x00000100
```

```
#define EVT_NOTIFY_SIGNAL      0x00000200
```

```
#define EVT_SIGNAL_EXIT_BOOT_SERVICES  0x00000201
```

```
#define EVT_SIGNAL_VIRTUAL_ADDRESS_CHANGE  0x60000202
```

<b>EVT_TIMER</b>	The event is a timer event and may be passed to <a href="#">EFI_BOOT_SERVICES.SetTimer()</a> . Note that timers only function during boot services time.
<b>EVT_RUNTIME</b>	The event is allocated from runtime memory. If an event is to be signaled after the call to <a href="#">EFI_BOOT_SERVICES.ExitBootServices()</a> , the event's data structure and notification function need to be allocated from runtime memory. For more information, see <a href="#">SetVirtualAddressMap()</a> .
<b>EVT_NOTIFY_WAIT</b>	If an event of this type is not already in the signaled state, then the event's <i>NotificationFunction</i> will be queued at the event's <i>NotifyTpl</i> whenever the event is being waited on via <a href="#">EFI_BOOT_SERVICES.WaitForEvent()</a> or <a href="#">EFI_BOOT_SERVICES.CheckEvent()</a> .
<b>EVT_NOTIFY_SIGNAL</b>	The event's <i>NotifyFunction</i> is queued whenever the event is signaled.
<b>EVT_SIGNAL_EXIT_BOOT_SERVICES</b>	This event is to be notified by the system when <a href="#">ExitBootServices()</a> is invoked. This event is of type <b>EVT_NOTIFY_SIGNAL</b> and should not be combined with any other event types. The notification function for this event is not allowed to use the Memory Allocation Services, or call any functions that use the Memory Allocation Services and must only call functions that are known not to use Memory Allocation Services, because these services modify the current memory map. The notification function must not depend on timer events since timer services will be deactivated before any notification functions are called.
<b>EVT_SIGNAL_VIRTUAL_ADDRESS_CHANGE</b>	The event is to be notified by the system when <a href="#">SetVirtualAddressMap()</a> is performed. This event type is a composite of <b>EVT_NOTIFY_SIGNAL</b> , <b>EVT_RUNTIME</b> , and <b>EVT_RUNTIME_CONTEXT</b> and should not be combined with any other event types.

```

//*****
// EFI_EVENT_NOTIFY
//*****
typedef
VOID
(EFI_API *EFI_EVENT_NOTIFY) (
    IN EFI_EVENT Event,

```

```

IN VOID *Context
);

```

<i>Event</i>	Event whose notification function is being invoked.
<i>Context</i>	Pointer to the notification function's context, which is implementation-dependent. <i>Context</i> corresponds to <i>NotifyContext</i> in <a href="#">EFI_BOOT_SERVICES.CreateEventEx()</a> .

## Description

The **CreateEvent()** function creates a new event of type *Type* and returns it in the location referenced by *Event*. The event's notification function, context, and task priority level are specified by *NotifyFunction*, *NotifyContext*, and *NotifyTpl*, respectively.

Events exist in one of two states, "waiting" or "signaled." When an event is created, firmware puts it in the "waiting" state. When the event is signaled, firmware changes its state to "signaled" and, if **EVT\_NOTIFY\_SIGNAL** is specified, places a call to its notification function in a FIFO queue. There is a queue for each of the "basic" task priority levels defined in [Section 7.1](#) (**TPL\_CALLBACK**, and **TPL\_NOTIFY**). The functions in these queues are invoked in FIFO order, starting with the highest priority level queue and proceeding to the lowest priority queue that is unmasked by the current TPL. If the current TPL is equal to or greater than the queued notification, it will wait until the TPL is lowered via [EFI\\_BOOT\\_SERVICES.RestoreTPL\(\)](#).

In a general sense, there are two "types" of events, synchronous and asynchronous. Asynchronous events are closely related to timers and are used to support periodic or timed interruption of program execution. This capability is typically used with device drivers. For example, a network device driver that needs to poll for the presence of new packets could create an event whose type includes **EVT\_TIMER** and then call the [EFI\\_BOOT\\_SERVICES.SetTimer\(\)](#) function. When the timer expires, the firmware signals the event.

Synchronous events have no particular relationship to timers. Instead, they are used to ensure that certain activities occur following a call to a specific interface function. One example of this is the cleanup that needs to be performed in response to a call to the [EFI\\_BOOT\\_SERVICES.ExitBootServices\(\)](#) function. **ExitBootServices()** can clean up the firmware since it understands firmware internals, but it cannot clean up on behalf of drivers that have been loaded into the system. The drivers have to do that themselves by creating an event whose type is **EVT\_SIGNAL\_EXIT\_BOOT\_SERVICES** and whose notification function is a function within the driver itself. Then, when **ExitBootServices()** has finished its cleanup, it signals each event of type **EVT\_SIGNAL\_EXIT\_BOOT\_SERVICES**.

Another example of the use of synchronous events occurs when an event of type **EVT\_SIGNAL\_VIRTUAL\_ADDRESS\_CHANGE** is used in conjunction with the [SetVirtualAddressMap\(\)](#).

The **EVT\_NOTIFY\_WAIT** and **EVT\_NOTIFY\_SIGNAL** flags are exclusive. If neither flag is specified, the caller does not require any notification concerning the event and the *NotifyTpl*, *NotifyFunction*, and *NotifyContext* parameters are ignored. If **EVT\_NOTIFY\_WAIT** is specified and the event is not in the signaled state, then **the**

**EVT\_NOTIFY\_WAIT** notify function is queued whenever a consumer of the event is waiting for **the event** (via [EFI\\_BOOT\\_SERVICES.WaitForEvent\(\)](#) or [EFI\\_BOOT\\_SERVICES.CheckEvent\(\)](#)). If the **EVT\_NOTIFY\_SIGNAL** flag is specified then the event's notify function is queued whenever the event is signaled.

**Note:** *Because its internal structure is unknown to the caller, **Event** cannot be modified by the caller. The only way to manipulate it is to use the published event interfaces.*

## Status Codes Returned

EFI_SUCCESS	The event structure was created.
EFI_INVALID_PARAMETER	One of the parameters has an invalid value.
EFI_INVALID_PARAMETER	<i>Event</i> is <b>NULL</b> .
EFI_INVALID_PARAMETER	<i>Type</i> has an unsupported bit set.
EFI_INVALID_PARAMETER	<i>Type</i> has both <b>EVT_NOTIFY_SIGNAL</b> and <b>EVT_NOTIFY_WAIT</b> set.
EFI_INVALID_PARAMETER	<i>Type</i> has either <b>EVT_NOTIFY_SIGNAL</b> or <b>EVT_NOTIFY_WAIT</b> set and <i>NotifyFunction</i> is <b>NULL</b> .
EFI_INVALID_PARAMETER	Type has either <b>EVT_NOTIFY_SIGNAL</b> or <b>EVT_NOTIFY_WAIT</b> set and <i>NotifyTpl</i> is not a supported TPL level.
EFI_OUT_OF_RESOURCES	The event could not be allocated.



## EFI\_BOOT\_SERVICES.CreateEventEx()

### Summary

Creates an event in a group.

### Prototype

```
typedef
EFI_STATUS
(EFI_API *EFI_CREATE_EVENT_EX) (
    IN UINT32    Type,
    IN EFI_TPL   NotifyTpl,
    IN EFI_EVENT_NOTIFY NotifyFunction OPTIONAL,
    IN CONST VOID *NotifyContext OPTIONAL,
    IN CONST EFI_GUID *EventGroup OPTIONAL,
    OUT EFI_EVENT *Event
);
```

### Parameters

<i>Type</i>	The type of event to create and its mode and attributes.
<i>NotifyTpl</i>	The task priority level of event notifications, if needed. See <a href="#">EFI_BOOT_SERVICES.RaiseTPL()</a> .
<i>NotifyFunction</i>	Pointer to the event's notification function, if any.
<i>NotifyContext</i>	Pointer to the notification function's context; corresponds to parameter <i>Context</i> in the notification function.
<i>EventGroup</i>	Pointer to the unique identifier of the group to which this event belongs. If this is <b>NULL</b> , then the function behaves as if the parameters were passed to <b>CreateEvent</b> .
<i>Event</i>	Pointer to the newly created event if the call succeeds; undefined otherwise.

### Description

The **CreateEventEx** function creates a new event of type *Type* and returns it in the specified location indicated by *Event*. The event's notification function, context and task priority are specified by *NotifyFunction*, *NotifyContext*, and *NotifyTpl*, respectively. The event will be added to the group of events identified by *EventGroup*.

If no group is specified by *EventGroup*, then this function behaves as if the same parameters had been passed to **CreateEvent**.

Event groups are collections of events identified by a shared EFI\_GUID where, when one member event is signaled, all other events are signaled and their individual notification actions are taken (as described in **CreateEvent**). All events are guaranteed to be signaled before the first notification action is taken. All notification functions will be executed in the order specified by their *NotifyTpl*.

A single event can only be part of a single event group. An event may be removed from an event group by using **CloseEvent**.

The *Type* of an event uses the same values as defined in **CreateEvent** except that **EVT\_SIGNAL\_EXIT\_BOOT\_SERVICES** and **EVT\_SIGNAL\_VIRTUAL\_ADDRESS\_CHANGE** are not valid.

If *Type* has **EVT\_NOTIFY\_SIGNAL** or **EVT\_NOTIFY\_WAIT**, then *NotifyFunction* must be non- **NULL** and *NotifyTpl* must be a valid task priority level. Otherwise these parameters are ignored.

More than one event of type **EVT\_TIMER** may be part of a single event group. However, there is no mechanism for determining which of the timers was signaled.

## Configuration Table Groups

The GUID for a configuration table also defines a corresponding event group GUID with the same value. If the data represented by a configuration table is changed, **InstallConfigurationTable()** should be called. When **InstallConfigurationTable()** is called, the corresponding event is signaled. When this event is signaled, any components that cache information from the configuration table can optionally update their cached state.

For example, **EFI\_ACPI\_TABLE\_GUID** defines a configuration table for ACPI data. When ACPI data is changed, **InstallConfigurationTable()** is called. During the execution of **InstallConfigurationTable()**, a corresponding event group with **EFI\_ACPI\_TABLE\_GUID** is signaled, allowing an application to invalidate any cached ACPI data.

## Pre-Defined Event Groups

This section describes the pre-defined event groups used by the UEFI specification.

### **EFI\_EVENT\_GROUP\_EXIT\_BOOT\_SERVICES**

This event group is notified by the system when **ExitBootServices()** is invoked. The notification function for this event is not allowed to use the Memory Allocation Services, or call any functions that use the Memory Allocation Services, because these services modify the current memory map. The notification function must not depend on timer events since timer services will be deactivated before any notification functions are called. This is functionally equivalent to the **EVT\_SIGNAL\_EXIT\_BOOT\_SERVICES** flag for the *Type* argument of **CreateEvent**.

### **EFI\_EVENT\_GROUP\_VIRTUAL\_ADDRESS\_CHANGE**

This event group is notified by the system when **SetVirtualAddressMap()** is invoked. This is functionally equivalent to the **EVT\_SIGNAL\_VIRTUAL\_ADDRESS\_CHANGE** flag for the *Type* argument of **CreateEvent**.

### **EFI\_EVENT\_GROUP\_MEMORY\_MAP\_CHANGE**

This event group is notified by the system when the memory map has changed. The notification function for this event should not use Memory Allocation Services to avoid reentrancy complications.

**EFI\_EVENT\_GROUP\_READY\_TO\_BOOT**

This event group is notified by the system when the Boot Manager is about to load and execute a boot option.

**EFI\_EVENT\_GROUP\_RESET\_SYSTEM**

This event group is notified by the system when `ResetSystem()` is invoked and the system is about to be reset. The event group is only notified prior to `ExitBootServices()` invocation.

**Related Definitions**

**EFI\_EVENT** is defined in **CreateEvent**.

**EVT\_SIGNAL\_EXIT\_BOOT\_SERVICES** and **EVT\_SIGNAL\_VIRTUAL\_ADDRESS\_CHANGE** are defined in **CreateEvent**.

```
#define EFI_EVENT_GROUP_EXIT_BOOT_SERVICES \
  {0x27abf055, 0xb1b8, 0x4c26, 0x80, 0x48, 0x74, 0x8f, 0x37, \
  0xba, 0xa2, 0xdf}
```

```
#define EFI_EVENT_GROUP_VIRTUAL_ADDRESS_CHANGE \
  {0x13fa7698, 0xc831, 0x49c7, 0x87, 0xea, 0x8f, 0x43, 0xfc, \
  0xc2, 0x51, 0x96}
```

```
#define EFI_EVENT_GROUP_MEMORY_MAP_CHANGE \
  {0x78bee926, 0x692f, 0x48fd, 0x9e, 0xdb, 0x1, 0x42, 0x2e, \
  0xf0, 0xd7, 0xab}
```

```
#define EFI_EVENT_GROUP_READY_TO_BOOT \
  {0x7ce88fb3, 0x4bd7, 0x4679, 0x87, 0xa8, 0xa8, 0xd8, 0xde, \
  0xe5, 0xd, 0x2b}
```

```
#define EFI_EVENT_GROUP_RESET_SYSTEM \
  { 0x62da6a56, 0x13fb, 0x485a, { 0xa8, 0xda, 0xa3, 0xdd, 0x79, 0x12, 0xcb, 0x6b } }
```

**Status Codes Returned**

EFI_SUCCESS	The event structure was created.
EFI_INVALID_PARAMETER	One of the parameters has an invalid value.
EFI_INVALID_PARAMETER	<i>Event</i> is <b>NULL</b> .
EFI_INVALID_PARAMETER	<i>Type</i> has an unsupported bit set.
EFI_INVALID_PARAMETER	<i>Type</i> has both <b>EVT_NOTIFY_SIGNAL</b> and <b>EVT_NOTIFY_WAIT</b> set.
EFI_INVALID_PARAMETER	<i>Type</i> has either <b>EVT_NOTIFY_SIGNAL</b> or <b>EVT_NOTIFY_WAIT</b> set and <i>NotifyFunction</i> is <b>NULL</b> .
EFI_INVALID_PARAMETER	<i>Type</i> has either <b>EVT_NOTIFY_SIGNAL</b> or <b>EVT_NOTIFY_WAIT</b> set and <i>NotifyTpl</i> is not a supported TPL level.

EFI_OUT_OF_RESOURCES	The event could not be allocated.
----------------------	-----------------------------------

## EFI\_BOOT\_SERVICES.CloseEvent()

### Summary

Closes an event.

### Prototype

```
typedef
EFI_STATUS
(EFI_API *EFI_CLOSE_EVENT) (
    IN EFI_EVENT Event
);
```

### Parameters

*Event*

The event to close. Type **EFI\_EVENT** is defined in the [CreateEvent\(\)](#) function description.

### Description

The **CloseEvent()** function removes the caller's reference to the event, removes it from any event group to which it belongs, and closes it. Once the event is closed, the event is no longer valid and may not be used on any subsequent function calls. If *Event* was registered with **RegisterProtocolNotify()** then **CloseEvent()** will remove the corresponding registration. It is safe to call **CloseEvent()** within the corresponding notify function.

### Status Codes Returned

EFI_SUCCESS	The event has been closed.
-------------	----------------------------

## EFI\_BOOT\_SERVICES.SignalEvent()

### Summary

Signals an event.

### Prototype

```
typedef
EFI_STATUS
(EFIAPI *EFI_SIGNAL_EVENT) (
    IN EFI_EVENT Event
);
```

### Parameters

*Event*

The event to signal. Type **EFI\_EVENT** is defined in the [EFI\\_BOOT\\_SERVICES.CheckEvent\(\)](#) function description.

### Description

The supplied *Event* is placed in the signaled state. If *Event* is already in the signaled state, then **EFI\_SUCCESS** is returned. If *Event* is of type **EVT\_NOTIFY\_SIGNAL**, then the event's notification function is scheduled to be invoked at the event's notification task priority level. **SignalEvent()** may be invoked from any task priority level.

If the supplied *Event* is a part of an event group, then all of the events in the event group are also signaled and their notification functions are scheduled.

When signaling an event group, it is possible to create an event in the group, signal it and then close the event to remove it from the group. For example:

```
EFI_EVENT Event;
EFI_GUID gMyEventGroupGuid = EFI_MY_EVENT_GROUP_GUID;
gBS->CreateEventEx (
    0,
    0,
    NULL,
    NULL,
    &gMyEventGroupGuid,
    &Event
);

gBS->SignalEvent (Event);
gBS->CloseEvent (Event);
```

### Status Codes Returned

EFI_SUCCESS	The event was signaled.
-------------	-------------------------

## EFI\_BOOT\_SERVICES.WaitForEvent()

### Summary

Stops execution until an event is signaled.

### Prototype

```
typedef
EFI_STATUS
(EFI_API *EFI_WAIT_FOR_EVENT) (
  IN UINTN   NumberOfEvents,
  IN EFI_EVENT *Event,
  OUT UINTN  *Index
);
```

### Parameters

<i>NumberOfEvents</i>	The number of events in the <i>Event</i> array.
<i>Event</i>	An array of <b>EFI_EVENT</b> . Type <b>EFI_EVENT</b> is defined in the <a href="#">CreateEvent()</a> function description.
<i>Index</i>	Pointer to the index of the event which satisfied the wait condition.

### Description

This function must be called at priority level **TPL\_APPLICATION**. If an attempt is made to call it at any other priority level, **EFI\_UNSUPPORTED** is returned.

The list of events in the *Event* array are evaluated in order from first to last, and this evaluation is repeated until an event is signaled or an error is detected. The following checks are performed on each event in the *Event* array.

- If an event is of type **EVT\_NOTIFY\_SIGNAL**, then **EFI\_INVALID\_PARAMETER** is returned and *Index* indicates the event that caused the failure.
- If an event is in the signaled state, the signaled state is cleared and **EFI\_SUCCESS** is returned, and *Index* indicates the event that was signaled.
- If an event is not in the signaled state but does have a notification function, the notification function is queued at the event's notification task priority level. If the execution of the event's notification function causes the event to be signaled, then the signaled state is cleared, **EFI\_SUCCESS** is returned, and *Index* indicates the event that was signaled.

To wait for a specified time, a timer event must be included in the *Event* array.

To check if an event is signaled without waiting, an already signaled event can be used as the last event in the list being checked, or the **CheckEvent()** interface may be used.

### Status Codes Returned

EFI_SUCCESS	The event indicated by <i>Index</i> was signaled.
-------------	---

EFI_INVALID_PARAMETER	<i>NumberOfEvents</i> is 0.
EFI_INVALID_PARAMETER	The event indicated by <i>Index</i> is of type <b>EVT_NOTIFY_SIGNAL</b> .
EFI_UNSUPPORTED	The current TPL is not <a href="#">TPL_APPLICATION</a> .



## EFI\_BOOT\_SERVICES.CheckEvent()

### Summary

Checks whether an event is in the signaled state.

### Prototype

```
typedef
EFI_STATUS
(EFIAPI *EFI_CHECK_EVENT) (
    IN EFI_EVENT Event
);
```

### Parameters

*Event*

The event to check. Type **EFI\_EVENT** is defined in the [CreateEvent\(\)](#) function description.

### Description

The **CheckEvent()** function checks to see whether *Event* is in the signaled state. If *Event* is of type **EVT\_NOTIFY\_SIGNAL**, then **EFI\_INVALID\_PARAMETER** is returned. Otherwise, there are three possibilities:

- If *Event* is in the signaled state, it is cleared and **EFI\_SUCCESS** is returned.
- If *Event* is not in the signaled state and has no notification function, **EFI\_NOT\_READY** is returned.
- If *Event* is not in the signaled state but does have a notification function, the notification function is queued at the event's notification task priority level. If the execution of the notification function causes *Event* to be signaled, then the signaled state is cleared and **EFI\_SUCCESS** is returned; if the *Event* is not signaled, then **EFI\_NOT\_READY** is returned.

### Status Codes Returned

EFI_SUCCESS	The event is in the signaled state.
EFI_NOT_READY	The event is not in the signaled state.
EFI_INVALID_PARAMETER	<i>Event</i> is of type EVT_NOTIFY_SIGNAL.

## EFI\_BOOT\_SERVICES.SetTimer()

### Summary

Sets the type of timer and the trigger time for a timer event.

### Prototype

```
typedef
EFI_STATUS
(EFI_API *EFI_SET_TIMER) (
    IN EFI_EVENT  Event,
    IN EFI_TIMER_DELAY Type,
    IN UINT64    TriggerTime
);
```

### Parameters

<i>Event</i>	The timer event that is to be signaled at the specified time. Type <b>EFI_EVENT</b> is defined in the <a href="#">CreateEvent()</a> function description.
<i>Type</i>	The type of time that is specified in <i>TriggerTime</i> . See the timer delay types in “Related Definitions.”
<i>TriggerTime</i>	The number of 100ns units until the timer expires. A <i>TriggerTime</i> of 0 is legal. If <i>Type</i> is <b>TimerRelative</b> and <i>TriggerTime</i> is 0, then the timer event will be signaled on the next timer tick. If <i>Type</i> is <b>TimerPeriodic</b> and <i>TriggerTime</i> is 0, then the timer event will be signaled on every timer tick.

### Related Definitions

```
/*******
//EFI_TIMER_DELAY
//*****
typedef enum {
    TimerCancel,
    TimerPeriodic,
    TimerRelative
} EFI_TIMER_DELAY;
```

<b>TimerCancel</b>	The event’s timer setting is to be cancelled and no timer trigger is to be set. <i>TriggerTime</i> is ignored when canceling a timer.
<b>TimerPeriodic</b>	The event is to be signaled periodically at <i>TriggerTime</i> intervals from the current time. This is the only timer trigger <i>Type</i> for which the event timer does not need to be reset for each notification. All other timer trigger types are “one shot.”

**TimerRelative**

The event is to be signaled in *TriggerTime* 100ns units.

**Description**

The **SetTimer()** function cancels any previous time trigger setting for the event, and sets the new trigger time for the event. This function can only be used on events of type **EVT\_TIMER**.

**Status Codes Returned**

EFI_SUCCESS	The event has been set to be signaled at the requested time.
EFI_INVALID_PARAMETER	<i>Event</i> or <i>Type</i> is not valid.

## EFI\_BOOT\_SERVICES.RaiseTPL()

### Summary

Raises a task's priority level and returns its previous level.

### Prototype

```
typedef
EFI_TPL
(EFI_API *EFI_RAISE_TPL) (
    IN EFI_TPL NewTpl
);
```

### Parameters

*NewTpl*

The new task priority level. It must be greater than or equal to the current task priority level. See "Related Definitions."

### Related Definitions

```
/**
//*****
// EFI_TPL
//*****
typedef UINTN EFI_TPL

//*****
// Task Priority Levels
//*****
#define TPL_APPLICATION 4
#define TPL_CALLBACK 8
#define TPL_NOTIFY 16
#define TPL_HIGH_LEVEL 31
```

### Description

The [EFI\\_BOOT\\_SERVICES.RaiseTPL\(\)](#) function raises the priority of the currently executing task and returns its previous priority level.

Only three task priority levels are exposed outside of the firmware during boot services execution. The first is [TPL\\_APPLICATION](#) where all normal execution occurs. That level may be interrupted to perform various asynchronous interrupt style notifications, which occur at the [TPL\\_CALLBACK](#) or [TPL\\_NOTIFY](#) level. By raising the task priority level to [TPL\\_NOTIFY](#) such notifications are masked until the task priority level is restored, thereby synchronizing execution with such notifications. Synchronous blocking I/O functions execute at [TPL\\_NOTIFY](#). [TPL\\_CALLBACK](#) is typically used for application level notification functions. Device drivers will typically use [TPL\\_CALLBACK](#) or [TPL\\_NOTIFY](#) for their notification functions. Applications and drivers may also use [TPL\\_NOTIFY](#) to protect data structures in critical sections of code.

The caller must restore the task priority level with [EFI\\_BOOT\\_SERVICES.RestoreTPL\(\)](#) to the previous level before returning.

**Note:** *If `NewTpl` is below the current TPL level, then the system behavior is indeterminate. Additionally, only `TPL_APPLICATION`, `TPL_CALLBACK`, `TPL_NOTIFY`, and `TPL_HIGH_LEVEL` may be used. All other values are reserved for use by the firmware; using them will result in unpredictable behavior. Good coding practice dictates that all code should execute at its lowest possible TPL level, and the use of TPL levels above `TPL_APPLICATION` must be minimized. Executing at TPL levels above `TPL_APPLICATION` for extended periods of time may also result in unpredictable behavior.*

## Status Codes Returned

Unlike other UEFI interface functions, [EFI\\_BOOT\\_SERVICES.RaiseTPL\(\)](#) does not return a status code. Instead, it returns the previous task priority level, which is to be restored later with a matching call to `RestoreTPL()`.

## EFI\_BOOT\_SERVICES.RestoreTPL()

### Summary

Restores a task's priority level to its previous value.

### Prototype

```
typedef
VOID
(EFI_API *EFI_RESTORE_TPL) (
    IN EFI_TPL OldTpl
)
```

### Parameters

*OldTpl*

The previous task priority level to restore (the value from a previous, matching call to [EFI\\_BOOT\\_SERVICES.RaiseTPL\(\)](#)). Type **EFI\_TPL** is defined in the [RaiseTPL\(\)](#) function description.

### Description

The [RestoreTPL\(\)](#) function restores a task's priority level to its previous value. Calls to [RestoreTPL\(\)](#) are matched with calls to [RaiseTPL\(\)](#).

**Note:** *If **OldTpl** is above the current TPL level, then the system behavior is indeterminate. Additionally, only [TPL\\_APPLICATION](#), [TPL\\_CALLBACK](#), [TPL\\_NOTIFY](#), and [TPL\\_HIGH\\_LEVEL](#) may be used. All other values are reserved for use by the firmware; using them will result in unpredictable behavior. Good coding practice dictates that all code should execute at its lowest possible TPL level, and the use of TPL levels above [TPL\\_APPLICATION](#) must be minimized. Executing at TPL levels above [TPL\\_APPLICATION](#) for extended periods of time may also result in unpredictable behavior.*

### Status Codes Returned

None.

## 7.2 Memory Allocation Services

The functions that make up Memory Allocation Services are used during preboot to allocate and free memory, and to obtain the system's memory map. See [Table 24](#).

**Table 24. Memory Allocation Functions**

Name	Type	Description
AllocatePages	Boot	Allocates pages of a particular type.
FreePages	Boot	Frees allocated pages.
GetMemoryMap	Boot	Returns the current boot services memory map and memory map key.
AllocatePool	Boot	Allocates a pool of a particular type.
FreePool	Boot	Frees allocated pool.

The way in which these functions are used is directly related to an important feature of UEFI memory design. This feature, which stipulates that EFI firmware owns the system's memory map during preboot, has three major consequences:

- During preboot, all components (including executing EFI images) must cooperate with the firmware by allocating and freeing memory from the system with the functions [EFI\\_BOOT\\_SERVICES.AllocatePages\(\)](#), [EFI\\_BOOT\\_SERVICES.AllocatePool\(\)](#), [EFI\\_BOOT\\_SERVICES.FreePages\(\)](#), and [EFI\\_BOOT\\_SERVICES.FreePool\(\)](#). The firmware dynamically maintains the memory map as these functions are called.
- During preboot, an executing EFI Image must only use the memory it has allocated.
- Before an executing EFI image exits and returns control to the firmware, it must free all resources it has explicitly allocated. This includes all memory pages, pool allocations, open file handles, etc. Memory allocated by the firmware to load an image is freed by the firmware when the image is unloaded.

When memory is allocated, it is "typed" according to the values in **EFI\_MEMORY\_TYPE** (see the description for [EFI\\_BOOT\\_SERVICES.AllocatePages\(\)](#)). Some of the types have a different usage *before* [EFI\\_BOOT\\_SERVICES.ExitBootServices\(\)](#) is called than they do *afterwards*. [Table 25](#) lists each type and its usage before the call; [Table 26](#) lists each type and its usage after the call. The system firmware must follow the processor-specific rules outlined in [Section 2.3.2](#) and [Section 2.3.4](#) in the layout of the EFI memory map to enable the OS to make the required virtual mappings.

Table 25. Memory Type Usage before **ExitBootServices()**

Mnemonic	Description
EfiReservedMemoryType	Not usable.
EfiLoaderCode	The code portions of a loaded UEFI application.
EfiLoaderData	The data portions of a loaded UEFI application and the default data allocation type used by a UEFI application to allocate pool memory.
EfiBootServicesCode	The code portions of a loaded UEFI Boot Service Driver.
EfiBootServicesData	The data portions of a loaded UEFI Boot Service Driver, and the default data allocation type used by a UEFI Boot Service Driver to allocate pool memory.
EfiRuntimeServicesCode	The code portions of a loaded UEFI Runtime Driver.
EfiRuntimeServicesData	The data portions of a loaded UEFI Runtime Driver and the default data allocation type used by a UEFI Runtime Driver to allocate pool memory.
EfiConventionalMemory	Free (unallocated) memory.
EfiUnusableMemory	Memory in which errors have been detected.
EfiACPIReclaimMemory	Memory that holds the ACPI tables.
EfiACPIMemoryNVS	Address space reserved for use by the firmware.
EfiMemoryMappedIO	Used by system firmware to request that a memory-mapped IO region be mapped by the OS to a virtual address so it can be accessed by EFI runtime services.
EfiMemoryMappedIOPortSpace	System memory-mapped IO region that is used to translate memory cycles to IO cycles by the processor.
EfiPalCode	Address space reserved by the firmware for code that is part of the processor.
EfiPersistentMemory	A memory region that operates as <i>EfiConventionalMemory</i> . However, it happens to also support byte-addressable non-volatility.

**Note:** There is only one region of type *EfiMemoryMappedIoPortSpace* defined in the architecture for Itanium-based platforms. As a result, there should be one and only one region of type *EfiMemoryMappedIoPortSpace* in the EFI memory map of an Itanium-based platform.

Table 26. Memory Type Usage after **ExitBootServices()**

Mnemonic	Description
EfiReservedMemoryType	Not usable.
EfiLoaderCode	The UEFI OS Loader and/or OS may use this memory as they see fit. Note: the UEFI OS loader that called <a href="#">EFI_BOOT_SERVICES.ExitBootServices()</a> is utilizing one or more <b>EfiLoaderCode</b> ranges.
EfiLoaderData	The Loader and/or OS may use this memory as they see fit. Note: the OS loader that called <b>ExitBootServices()</b> is utilizing one or more <b>EfiLoaderData</b> ranges.
EfiBootServicesCode	Memory available for general use.
EfiBootServicesData	Memory available for general use.



EfiRuntimeServicesCode	The memory in this range is to be preserved by the UEFI OS loader and OS in the working and ACPI S1–S3 states.
EfiRuntimeServicesData	The memory in this range is to be preserved by the UEFI OS loader and OS in the working and ACPI S1–S3 states.
EfiConventionalMemory	Memory available for general use.
EfiUnusableMemory	Memory that contains errors and is not to be used.
EfiACPIReclaimMemory	This memory is to be preserved by the UEFI OS loader and OS until ACPI is enabled. Once ACPI is enabled, the memory in this range is available for general use.
EfiACPIMemoryNVS	This memory is to be preserved by the UEFI OS loader and OS in the working and ACPI S1–S3 states.
EfiMemoryMappedIO	This memory is not used by the OS. All system memory-mapped IO information should come from ACPI tables.
EfiMemoryMappedIOPortSpace	This memory is not used by the OS. All system memory-mapped IO port space information should come from ACPI tables.
EfiPalCode	This memory is to be preserved by the UEFI OS loader and OS in the working and ACPI S1–S4 states. This memory may also have other attributes that are defined by the processor implementation.
EfiPersistentMemory	A memory region that operates as <i>EfiConventionalMemory</i> . However, it happens to also support byte-addressable non-volatility.

**Note:** An image that calls **ExitBootServices()** (i.e., a UEFI OS Loader) first calls **EFI\_BOOT\_SERVICES.GetMemoryMap()** to obtain the current memory map. Following the **ExitBootServices()** call, the image implicitly owns all unused memory in the map. This includes memory types *EfiLoaderCode*, *EfiLoaderData*, *EfiBootServicesCode*, *EfiBootServicesData*, and *EfiConventionalMemory*. A UEFI OS Loader and OS must preserve the memory marked as *EfiRuntimeServicesCode* and *EfiRuntimeServicesData*.

## EFI\_BOOT\_SERVICES.AllocatePages()

### Summary

Allocates memory pages from the system.

### Prototype

```
typedef
EFI_STATUS
(EFIAPI *EFI_ALLOCATE_PAGES) (
    IN EFI_ALLOCATE_TYPE  Type,
    IN EFI_MEMORY_TYPE    MemoryType,
    IN UINTN              Pages,
    IN OUT EFI_PHYSICAL_ADDRESS *Memory
);
```

### Parameters

<i>Type</i>	The type of allocation to perform. See “Related Definitions.”
<i>MemoryType</i>	The type of memory to allocate. The type <b>EFI_MEMORY_TYPE</b> is defined in “Related Definitions” below. These memory types are also described in more detail in <a href="#">Table 25</a> and <a href="#">Table 26</a> . Normal allocations (that is, allocations by any UEFI application) are of type <b>EfiLoaderData</b> . <i>MemoryType</i> values in the range 0x70000000..0x7FFFFFFF are reserved for OEM use. <i>MemoryType</i> values in the range 0x80000000..0xFFFFFFFF are reserved for use by UEFI OS loaders that are provided by operating system vendors.
<i>Pages</i>	The number of contiguous 4 KiB pages to allocate.
<i>Memory</i>	Pointer to a physical address. On input, the way in which the address is used depends on the value of <i>Type</i> . See “Description” for more information. On output the address is set to the base of the page range that was allocated. See “Related Definitions.”

**Note:** *UEFI Applications, UEFI Drivers, and UEFI OS Loaders must not allocate memory of type **EfiReservedMemoryType**.*

### Related Definitions

```

//*****
//EFI_ALLOCATE_TYPE
//*****
// These types are discussed in the "Description" section below.
typedef enum {
    AllocateAnyPages,
    AllocateMaxAddress,
    AllocateAddress,
    MaxAllocateType
} EFI_ALLOCATE_TYPE;

//*****
//EFI_MEMORY_TYPE
//*****
// These type values are discussed in Table 25 and Table 26.
typedef enum {
    EfiReservedMemoryType,
    EfiLoaderCode,
    EfiLoaderData,
    EfiBootServicesCode,
    EfiBootServicesData,
    EfiRuntimeServicesCode,
    EfiRuntimeServicesData,
    EfiConventionalMemory,
    EfiUnusableMemory,
    EfiACPIReclaimMemory,
    EfiACPIMemoryNVS,
    EfiMemoryMappedIO,
    EfiMemoryMappedIOPortSpace,
    EfiPalCode,
    EfiPersistentMemory,
    EfiMaxMemoryType
} EFI_MEMORY_TYPE;

//*****
//EFI_PHYSICAL_ADDRESS
//*****
typedef UINT64 EFI_PHYSICAL_ADDRESS;

```

## Description

The **AllocatePages()** function allocates the requested number of pages and returns a pointer to the base address of the page range in the location referenced by *Memory*. The function scans the memory map to locate free pages. When it finds a physically contiguous block of pages that is large enough and also satisfies the allocation requirements of *Type*, it changes the memory map to indicate that the pages are now of type *MemoryType*.

In general, UEFI OS loaders and UEFI applications should allocate memory (and pool) of type **EfiLoaderData**. UEFI boot service drivers must allocate memory (and pool) of type **EfiBootServicesData**. UEFI runtime drivers should allocate memory (and pool) of type **EfiRuntimeServicesData** (although such allocation can only be made during boot services time).

Allocation requests of *Type* **AllocateAnyPages** allocate any available range of pages that satisfies the request. On input, the address pointed to by *Memory* is ignored.

Allocation requests of *Type* **AllocateMaxAddress** allocate any available range of pages whose uppermost address is less than or equal to the address pointed to by *Memory* on input.

Allocation requests of *Type* **AllocateAddress** allocate pages at the address pointed to by *Memory* on input.

**Note:** UEFI drivers and UEFI applications that are not targeted for a specific implementation must perform memory allocations for the following runtime types using **AllocateAnyPages** address mode:

**EfiACPIReclaimMemory,**  
**EfiACPIMemoryNVS,**  
**EfiRuntimeServicesCode,**  
**EfiRuntimeServicesData,**  
**EfiReservedMemoryType.**

## Status Codes Returned

EFI_SUCCESS	The requested pages were allocated.
EFI_OUT_OF_RESOURCES	The pages could not be allocated.
EFI_INVALID_PARAMETER	<i>Type</i> is not <b>AllocateAnyPages</b> or <b>AllocateMaxAddress</b> or <b>AllocateAddress</b> .
EFI_INVALID_PARAMETER	<i>MemoryType</i> is in the range <b>EfiMaxMemoryType</b> ..0x6FFFFFFF.
EFI_INVALID_PARAMETER	<i>MemoryType</i> is <b>EfiPersistentMemory</b> .
EFI_INVALID_PARAMETER	<i>Memory</i> is NULL.
EFI_NOT_FOUND	The requested pages could not be found.

## EFI\_BOOT\_SERVICES.FreePages()

### Summary

Frees memory pages.

### Prototype

```
typedef
EFI_STATUS
(EFIAPI *EFI_FREE_PAGES) (
    IN EFI_PHYSICAL_ADDRESS      Memory,
    IN UINTN                     Pages
);
```

### Parameters

*Memory*

The base physical address of the pages to be freed. Type **EFI\_PHYSICAL\_ADDRESS** is defined in the [EFI\\_BOOT\\_SERVICES.AllocatePages\(\)](#) function description.

*Pages*

The number of contiguous 4 KiB pages to free.

### Description

The **FreePages()** function returns memory allocated by **AllocatePages()** to the firmware.

### Status Codes Returned

EFI_SUCCESS	The requested memory pages were freed.
EFI_NOT_FOUND	The requested memory pages were not allocated with <b>AllocatePages()</b> .
EFI_INVALID_PARAMETER	<i>Memory</i> is not a page-aligned address or <i>Pages</i> is invalid.

## EFI\_BOOT\_SERVICES.GetMemoryMap()

### Summary

Returns the current memory map.

### Prototype

```
typedef
EFI_STATUS
(EFI_API *EFI_GET_MEMORY_MAP) (
    IN OUT UINTN      *MemoryMapSize,
    IN OUT EFI_MEMORY_DESCRIPTOR *MemoryMap,
    OUT UINTN         *MapKey,
    OUT UINTN         *DescriptorSize,
    OUT UINT32        *DescriptorVersion
);
```

### Parameters

<i>MemoryMapSize</i>	A pointer to the size, in bytes, of the <i>MemoryMap</i> buffer. On input, this is the size of the buffer allocated by the caller. On output, it is the size of the buffer returned by the firmware if the buffer was large enough, or the size of the buffer needed to contain the map if the buffer was too small.
<i>MemoryMap</i>	A pointer to the buffer in which firmware places the current memory map. The map is an array of <b>EFI_MEMORY_DESCRIPTOR</b> s. See “Related Definitions.”
<i>MapKey</i>	A pointer to the location in which firmware returns the key for the current memory map.
<i>DescriptorSize</i>	A pointer to the location in which firmware returns the size, in bytes, of an individual <b>EFI_MEMORY_DESCRIPTOR</b> .
<i>DescriptorVersion</i>	A pointer to the location in which firmware returns the version number associated with the <b>EFI_MEMORY_DESCRIPTOR</b> . See “Related Definitions.”

## Related Definitions

```

//*****
//EFI_MEMORY_DESCRIPTOR
//*****
typedef struct {
  UINT32    Type;
  EFI_PHYSICAL_ADDRESS PhysicalStart;
  EFI_VIRTUAL_ADDRESS VirtualStart;
  UINT64    NumberOfPages;
  UINT64    Attribute;
} EFI_MEMORY_DESCRIPTOR;

```

<i>Type</i>	Type of the memory region. Type <b>EFI_MEMORY_TYPE</b> is defined in the <a href="#">AllocatePages()</a> function description.
<i>PhysicalStart</i>	region. <i>PhysicalStart</i> must be aligned on a 4 KiB boundary, and must not be above 0xffffffff000. Type <b>EFI_PHYSICAL_ADDRESS</b> is defined in the <a href="#">AllocatePages()</a> function description.
<i>VirtualStart</i>	Virtual address of the first byte in the memory region. <i>VirtualStart</i> must be aligned on a 4 KiB boundary, and must not be above 0xffffffff000. Type <b>EFI_VIRTUAL_ADDRESS</b> is defined in "Related Definitions."
<i>NumberOfPages</i>	Number of 4 KiB pages in the memory region. NumberOfPages must not be 0, and must not be any value that would represent a memory page with a start address, either physical or virtual, above 0xffffffff000
<i>Attribute</i>	Attributes of the memory region that describe the bit mask of capabilities for that memory region, and not necessarily the current settings for that memory region. See the following "Memory Attribute Definitions."

```

//*****
// Memory Attribute Definitions
//*****
// These types can be "ORed" together as needed.
#define EFI_MEMORY_UC    0x0000000000000001
#define EFI_MEMORY_WC    0x0000000000000002
#define EFI_MEMORY_WT    0x0000000000000004
#define EFI_MEMORY_WB    0x0000000000000008
#define EFI_MEMORY_UCE   0x0000000000000010
#define EFI_MEMORY_WP    0x0000000000001000
#define EFI_MEMORY_RP    0x0000000000002000
#define EFI_MEMORY_XP    0x0000000000004000
#define EFI_MEMORY_NV    0x0000000000008000
#define EFI_MEMORY_MORE_RELIABLE 0x0000000000010000
#define EFI_MEMORY_RO    0x0000000000020000
#define EFI_MEMORY_RUNTIME 0x8000000000000000

```

<b>EFI_MEMORY_UC</b>	Memory cacheability attribute: The memory region supports being configured as not cacheable.
<b>EFI_MEMORY_WC</b>	Memory cacheability attribute: The memory region supports being configured as write combining.
<b>EFI_MEMORY_WT</b>	Memory cacheability attribute: The memory region supports being configured as cacheable with a "write through" policy. Writes that hit in the cache will also be written to main memory.
<b>EFI_MEMORY_WB</b>	Memory cacheability attribute: The memory region supports being configured as cacheable with a "write back" policy. Reads and writes that hit in the cache do not propagate to main memory. Dirty data is written back to main memory when a new cache line is allocated.
<b>EFI_MEMORY_UCE</b>	Memory cacheability attribute: The memory region supports being configured as not cacheable, exported, and supports the "fetch and add" semaphore mechanism.
<b>EFI_MEMORY_WP</b>	Physical memory protection attribute: The memory region supports being configured as write-protected by system hardware. This is typically used as a cacheability attribute today. The memory region supports being configured as cacheable with a "write protected" policy. Reads come from cache lines when possible, and read misses cause cache fills. Writes are propagated to the system bus and cause corresponding cache lines on all processors on the bus to be invalidated.

**Note:** UEFI spec 2.5 and following: use `EFI_MEMORY_RO` as write-protected physical memory protection attribute. Also, `EFI_MEMORY_WP` means cacheability attribute.

<b>EFI_MEMORY_RP</b>	Physical memory protection attribute: The memory region supports being configured as read-protected by system hardware.
----------------------	---



<b>EFI_MEMORY_XP</b>	Physical memory protection attribute: The memory region supports being configured so it is protected by system hardware from executing code.
<b>EFI_MEMORY_NV</b>	Runtime memory attribute: The memory region refers to persistent memory
<b>EFI_MEMORY_MORE_RELIABLE</b>	The memory region provides higher reliability relative to other memory in the system. If all memory has the same reliability, then this bit is not used.
<b>EFI_MEMORY_RO</b>	Physical memory protection attribute: The memory region supports making this memory range read-only by system hardware.
<b>EFI_MEMORY_RUNTIME</b>	Runtime memory attribute: The memory region needs to be given a virtual mapping by the operating system when <a href="#">SetVirtualAddressMap()</a> is called (described in <a href="#">Section 8.4</a> ).

```

//*****
//EFI_VIRTUAL_ADDRESS
//*****
typedef UINT64 EFI_VIRTUAL_ADDRESS;

//*****
// Memory Descriptor Version Number
//*****
#define EFI_MEMORY_DESCRIPTOR_VERSION 1

```

## Description

The [GetMemoryMap\(\)](#) function returns a copy of the current memory map. The map is an array of memory descriptors, each of which describes a contiguous block of memory. The map describes all of memory, no matter how it is being used. That is, it includes blocks allocated by [EFI\\_BOOT\\_SERVICES.AllocatePages\(\)](#) and [EFI\\_BOOT\\_SERVICES.AllocatePool\(\)](#), as well as blocks that the firmware is using for its own purposes. The memory map is only used to describe memory that is present in the system. The firmware does not return a range description for address space regions that are not backed by physical hardware. Regions that are backed by physical hardware, but are not supposed to be accessed by the OS, must be returned as **EfiReservedMemoryType**. The OS may use addresses of memory ranges that are not described in the memory map at its own discretion.

Until [EFI\\_BOOT\\_SERVICES.ExitBootServices\(\)](#) is called, the memory map is owned by the firmware and the currently executing UEFI Image should only use memory pages it has explicitly allocated.

If the *MemoryMap* buffer is too small, the **EFI\_BUFFER\_TOO\_SMALL** error code is returned and the *MemoryMapSize* value contains the size of the buffer needed to contain

the current memory map. The actual size of the buffer allocated for the consequent call to **GetMemoryMap()** should be bigger than the value returned in *MemoryMapSize*, since allocation of the new buffer may potentially increase memory map size.

On success a *MapKey* is returned that identifies the current memory map. The firmware's key is changed every time something in the memory map changes. In order to successfully invoke **EFI\_BOOT\_SERVICES.ExitBootServices()** the caller must provide the current memory map key.

The **GetMemoryMap()** function also returns the size and revision number of the **EFI\_MEMORY\_DESCRIPTOR**. The *DescriptorSize* represents the size in bytes of an **EFI\_MEMORY\_DESCRIPTOR** array element returned in *MemoryMap*. The size is returned to allow for future expansion of the **EFI\_MEMORY\_DESCRIPTOR** in response to hardware innovation. The structure of the **EFI\_MEMORY\_DESCRIPTOR** may be extended in the future but it will remain backwards compatible with the current definition. Thus OS software must use the *DescriptorSize* to find the start of each **EFI\_MEMORY\_DESCRIPTOR** in the *MemoryMap* array.

## Status Codes Returned

EFI_SUCCESS	The memory map was returned in the <i>MemoryMap</i> buffer.
EFI_BUFFER_TOO_SMALL	The <i>MemoryMap</i> buffer was too small. The current buffer size needed to hold the memory map is returned in <i>MemoryMapSize</i> .
EFI_INVALID_PARAMETER	<i>MemoryMapSize</i> is <b>NULL</b> .
EFI_INVALID_PARAMETER	The <i>MemoryMap</i> buffer is not too small and <i>MemoryMap</i> is <b>NULL</b> .

## EFI\_BOOT\_SERVICES.AllocatePool()

### Summary

Allocates pool memory.

### Prototype

```
typedef
EFI_STATUS
(EFIAPI *EFI_ALLOCATE_POOL) (
    IN EFI_MEMORY_TYPE PoolType,
    IN UINTN           Size,
    OUT VOID          **Buffer
);
```

### Parameters

*PoolType*

The type of pool to allocate. Type **EFI\_MEMORY\_TYPE** is defined in the [EFI\\_BOOT\\_SERVICES.AllocatePages\(\)](#) function description. *PoolType* values in the range 0x70000000..0x7FFFFFFF are reserved for OEM use. *PoolType* values in the range 0x80000000..0xFFFFFFFF are reserved for use by UEFI OS loaders that are provided by operating system vendors.

*Size*

The number of bytes to allocate from the pool.

*Buffer*

A pointer to a pointer to the allocated buffer if the call succeeds; undefined otherwise.

**Note:** UEFI applications and UEFI drivers must not allocate memory of type **EfiReservedMemoryType**.

### Description

The **AllocatePool()** function allocates a memory region of *Size* bytes from memory of type *PoolType* and returns the address of the allocated memory in the location referenced by *Buffer*. This function allocates pages from **EfiConventionalMemory** as needed to grow the requested pool type. All allocations are eight-byte aligned.

The allocated pool memory is returned to the available pool with the [EFI\\_BOOT\\_SERVICES.FreePool\(\)](#) function.

### Status Codes Returned

EFI_SUCCESS	The requested number of bytes was allocated.
EFI_OUT_OF_RESOURCES	The pool requested could not be allocated.
EFI_INVALID_PARAMETER	<i>PoolType</i> is in the range <b>EfiMaxMemoryType</b> ..0x6FFFFFFF.
EFI_INVALID_PARAMETER	<i>PoolType</i> is <b>EfiPersistentMemory</b> .
EFI_INVALID_PARAMETER	<i>Buffer</i> is NULL.

## EFI\_BOOT\_SERVICES.FreePool()

### Summary

Returns pool memory to the system.

### Prototype

```
typedef
EFI_STATUS
(EFI_API *EFI_FREE_POOL) (
    IN VOID *Buffer
);
```

### Parameters

*Buffer* Pointer to the buffer to free.

### Description

The **FreePool()** function returns the memory specified by *Buffer* to the system. On return, the memory's type is **EfiConventionalMemory**. The *Buffer* that is freed must have been allocated by **AllocatePool()**.

### Status Codes Returned

EFI_SUCCESS	The memory was returned to the system.
EFI_INVALID_PARAMETER	<i>Buffer</i> was invalid.

## 7.3 Protocol Handler Services

In the abstract, a protocol consists of a 128-bit globally unique identifier (GUID) and a Protocol Interface structure. The structure contains the functions and instance data that are used to access a device. The functions that make up Protocol Handler Services allow applications to install a protocol on a handle, identify the handles that support a given protocol, determine whether a handle supports a given protocol, and so forth. See [Table 27](#).

Table 27. Protocol Interface Functions

Name	Type	Description
InstallProtocolInterface	Boot	Installs a protocol interface on a device handle.
UninstallProtocolInterface	Boot	Removes a protocol interface from a device handle.
ReinstallProtocolInterface	Boot	Reinstalls a protocol interface on a device handle.
RegisterProtocolNotify	Boot	Registers an event that is to be signaled whenever an interface is installed for a specified protocol.
LocateHandle	Boot	Returns an array of handles that support a specified protocol.
HandleProtocol	Boot	Queries a handle to determine if it supports a specified protocol.
LocateDevicePath	Boot	Locates all devices on a device path that support a specified protocol and returns the handle to the device that is closest to the path.
OpenProtocol	Boot	Adds elements to the list of agents consuming a protocol interface.
CloseProtocol	Boot	Removes elements from the list of agents consuming a protocol interface.
OpenProtocolInformation	Boot	Retrieve the list of agents that are currently consuming a protocol interface.
ConnectController	Boot	Uses a set of precedence rules to find the best set of drivers to manage a controller.
DisconnectController	Boot	Informs a set of drivers to stop managing a controller.
ProtocolsPerHandle	Boot	Retrieves the list of protocols installed on a handle. The return buffer is automatically allocated.
LocateHandleBuffer	Boot	Retrieves the list of handles from the handle database that meet the search criteria. The return buffer is automatically allocated.
LocateProtocol	Boot	Finds the first handle in the handle database the supports the requested protocol.
InstallMultipleProtocolInterfaces	Boot	Installs one or more protocol interfaces onto a handle.
UninstallMultipleProtocolInterfaces	Boot	Uninstalls one or more protocol interfaces from a handle.

The Protocol Handler boot services have been modified to take advantage of the information that is now being tracked with the [EFI\\_BOOT\\_SERVICES.OpenProtocol\(\)](#) and [EFI\\_BOOT\\_SERVICES.CloseProtocol\(\)](#) boot services. Since the usage of protocol interfaces is being tracked with these new boot services, it is now possible to safely uninstall and reinstall protocol interfaces that are being consumed by UEFI drivers.

As depicted in [Figure 25](#), the firmware is responsible for maintaining a “data base” that shows which protocols are attached to each device handle. (The figure depicts the “data base” as a linked list, but the choice of data structure is implementation-dependent.) The “data base” is built dynamically by calling the [EFI\\_BOOT\\_SERVICES.InstallProtocolInterface\(\)](#) function. Protocols can only be installed

by UEFI drivers or the firmware itself. In the figure, a device handle (**EFI\_HANDLE**) refers to a list of one or more registered protocol interfaces for that handle. The first handle in the system has four attached protocols, and the second handle has two attached protocols. Each attached protocol is represented as a GUID/Interface pointer pair. The GUID is the name of the protocol, and Interface points to a protocol instance. This data structure will typically contain a list of interface functions, and some amount of instance data.

Access to devices is initiated by calling the [EFI\\_BOOT\\_SERVICES.HandleProtocol\(\)](#) function, which determines whether a handle supports a given protocol. If it does, a pointer to the matching Protocol Interface structure is returned.

When a protocol is added to the system, it may either be added to an existing device handle or it may be added to create a new device handle. [Figure 25](#) shows that protocol handlers are listed for each device handle and that each protocol handler is logically a UEFI driver.

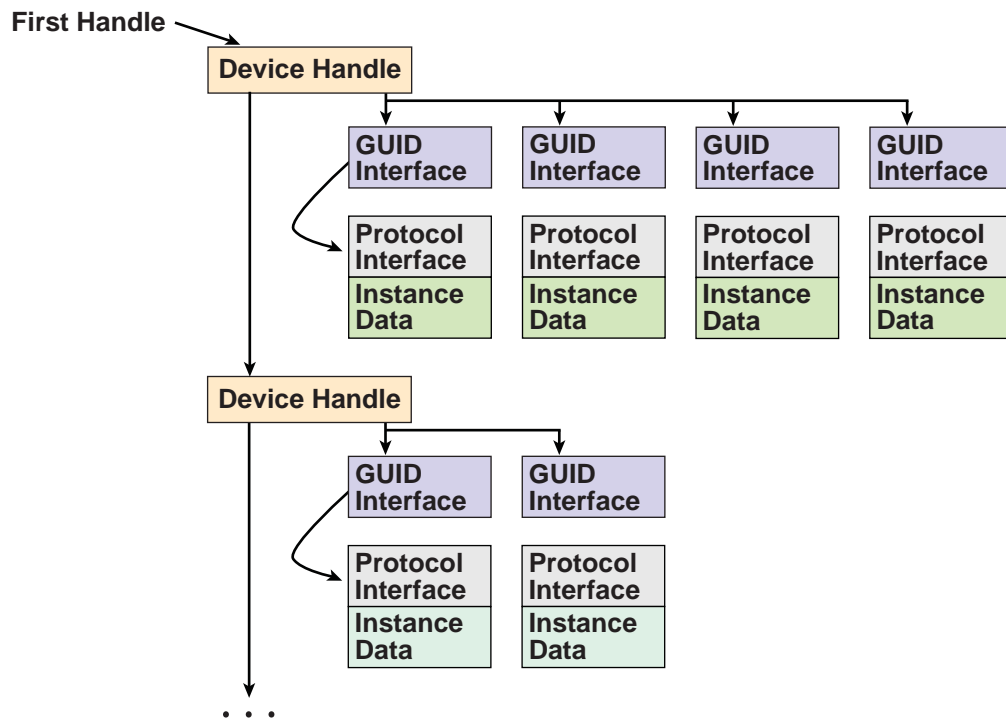

Figure 25. Device Handle to Protocol Handler Mapping

The ability to add new protocol interfaces as new handles or to layer them on existing interfaces provides great flexibility. Layering makes it possible to add a new protocol that builds on a device’s basic protocols. An example of this might be to layer on a [EFI SIMPLE TEXT OUTPUT PROTOCOL](#) support that would build on the handle’s underlying [EFI SERIAL IO PROTOCOL](#).

The ability to add new handles can be used to generate new devices as they are found, or even to generate abstract devices. An example of this might be to add a multiplexing device that replaces *ConsoleOut* with a virtual device that multiplexes the **EFI\_SIMPLE\_TEXT\_OUTPUT\_PROTOCOL** protocol onto multiple underlying device handles.

## Driver Model Boot Services

Following is a detailed description of the new UEFI boot services that are required by the UEFI *Driver Model*. These boot services are being added to reduce the size and complexity of the bus drivers and device drivers. This, in turn, will reduce the amount of ROM space required by drivers that are programmed into ROMs on adapters or into system FLASH, and reduce the development and testing time required by driver writers.

These new services fall into two categories. The first group is used to track the usage of protocol interfaces by different agents in the system. Protocol interfaces are stored in a handle database. The handle database consists of a list of handles, and on each handle there is a list of one or more protocol interfaces. The boot services [EFI\\_BOOT\\_SERVICES.InstallProtocolInterface\(\)](#), [EFI\\_BOOT\\_SERVICES.UninstallProtocolInterface\(\)](#), and [EFI\\_BOOT\\_SERVICES.ReinstallProtocolInterface\(\)](#) are used to add, remove, and replace protocol interfaces in the handle database. The boot service [EFI\\_BOOT\\_SERVICES.HandleProtocol\(\)](#) is used to look up a protocol interface in the handle database. However, agents that call **HandleProtocol()** are not tracked, so it is not safe to call **UninstallProtocolInterface()** or **ReinstallProtocolInterface()** because an agent may be using the protocol interface that is being removed or replaced.

The solution is to track the usage of protocol interfaces in the handle database itself. To accomplish this, each protocol interface includes a list of agents that are consuming the protocol interface. [Figure 26](#) shows an example handle database with these new agent lists. An agent consists of an image handle, a controller handle, and some attributes. The image handle identifies the driver or application that is consuming the protocol interface. The controller handle identifies the controller that is consuming the protocol interface. Since a driver may manage more than one controller, the combination of a driver's image handle and a controller's controller handle uniquely identifies the agent that is consuming the protocol interface. The attributes show how the protocol interface is being used.

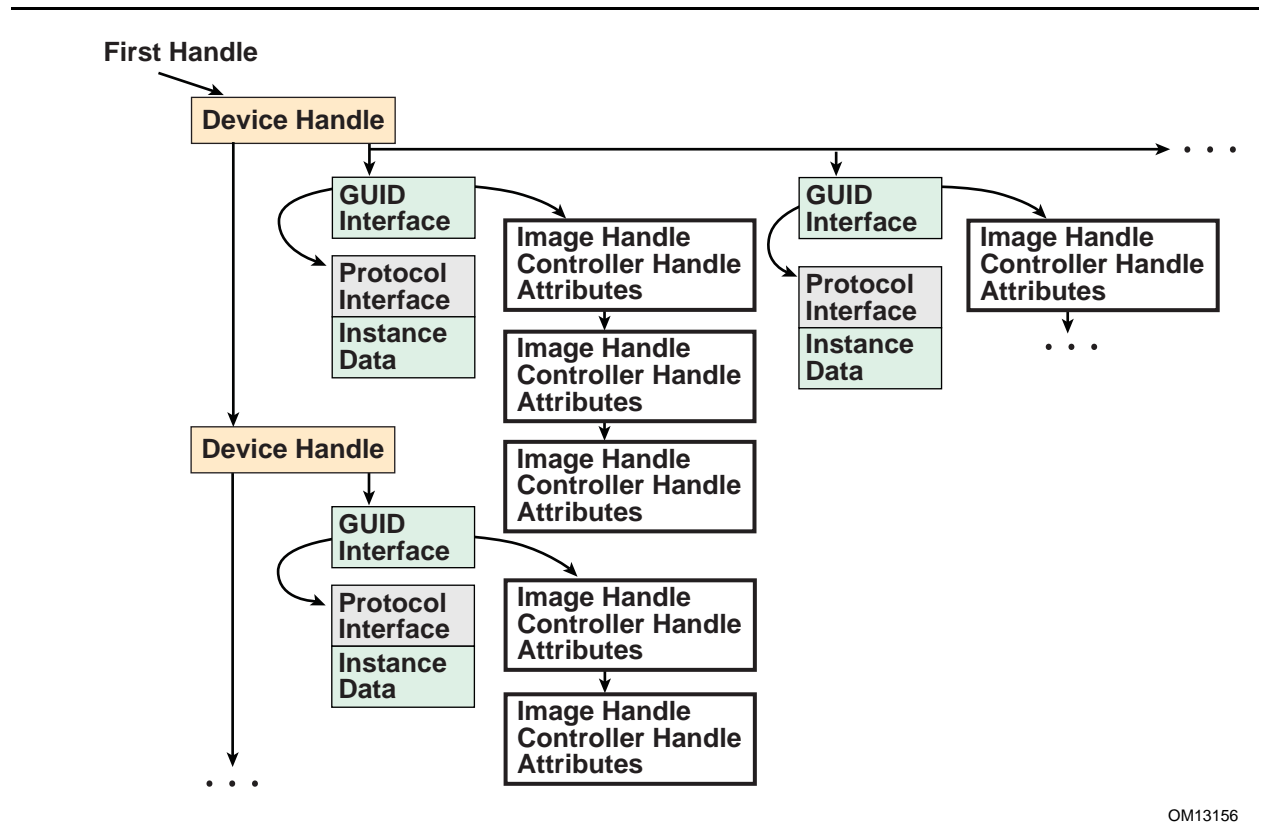

OM13156

Figure 26. Handle Database

In order to maintain these agent lists in the handle database, some new boot services are required. These are [EFI\\_BOOT\\_SERVICES.OpenProtocol\(\)](#), [EFI\\_BOOT\\_SERVICES.CloseProtocol\(\)](#), and [EFI\\_BOOT\\_SERVICES.OpenProtocolInformation\(\)](#). **OpenProtocol()** adds elements to the list of agents consuming a protocol interface. **CloseProtocol()** removes elements from the list of agents consuming a protocol interface, and [EFI\\_BOOT\\_SERVICES.OpenProtocolInformation\(\)](#) retrieves the entire list of agents that are currently using a protocol interface.

The second group of boot services is used to deterministically connect and disconnect drivers to controllers. The boot services in this group are [EFI\\_BOOT\\_SERVICES.ConnectController\(\)](#) and [EFI\\_BOOT\\_SERVICES.DisconnectController\(\)](#). These services take advantage of the new features of the handle database along with the new protocols described in this document to manage the drivers and controllers present in the system. **ConnectController()** uses a set of strict precedence rules to find the best set of drivers for a controller. This provides a deterministic matching of drivers to controllers with extensibility mechanisms for OEMs, IBVs, and IHVs. **DisconnectController()** allows drivers to be disconnected from controllers in a controlled manner, and by using the new features of the handle database it is possible to fail a disconnect request because a protocol interface cannot be released at the time of the disconnect request.



The third group of boot services is designed to help simplify the implementation of drivers, and produce drivers with smaller executable footprints. The [EFI\\_BOOT\\_SERVICES.LocateHandleBuffer\(\)](#) is a new version of [EFI\\_BOOT\\_SERVICES.LocateHandle\(\)](#) that allocates the required buffer for the caller. This eliminates two calls to [LocateHandle\(\)](#) and a call to [EFI\\_BOOT\\_SERVICES.AllocatePool\(\)](#) from the caller's code. [EFI\\_BOOT\\_SERVICES.LocateProtocol\(\)](#) searches the handle database for the first protocol instance that matches the search criteria. The [EFI\\_BOOT\\_SERVICES.InstallMultipleProtocolInterfaces\(\)](#) and [EFI\\_BOOT\\_SERVICES.UninstallMultipleProtocolInterfaces\(\)](#) are very useful to driver writers. These boot services allow one or more protocol interfaces to be added or removed from a handle. In addition, [InstallMultipleProtocolInterfaces\(\)](#) guarantees that a duplicate device path is never added to the handle database. This is very useful to bus drivers that can create one child handle at a time, because it guarantees that the bus driver will not inadvertently create two instances of the same child handle.

## EFI\_BOOT\_SERVICES.InstallProtocolInterface()

### Summary

Installs a protocol interface on a device handle. If the handle does not exist, it is created and added to the list of handles in the system. **InstallMultipleProtocolInterfaces()** performs more error checking than **InstallProtocolInterface()**, so it is recommended that **InstallMultipleProtocolInterfaces()** be used in place of **InstallProtocolInterface()**

### Prototype

```
typedef
EFI_STATUS
(EFI_API *EFI_INSTALL_PROTOCOL_INTERFACE) (
    IN OUT EFI_HANDLE *Handle,
    IN EFI_GUID *Protocol,
    IN EFI_INTERFACE_TYPE InterfaceType,
    IN VOID *Interface
);
```

### Parameters

*Handle*

A pointer to the **EFI\_HANDLE** on which the interface is to be installed. If *\*Handle* is **NULL** on input, a new handle is created and returned on output. If *\*Handle* is not **NULL** on input, the protocol is added to the handle, and the handle is returned unmodified. The type **EFI\_HANDLE** is defined in "Related Definitions." If *\*Handle* is not a valid handle, then **EFI\_INVALID\_PARAMETER** is returned.

*Protocol*

The numeric ID of the protocol interface. The type **EFI\_GUID** is defined in "Related Definitions." It is the caller's responsibility to pass in a valid GUID. See "Wired For Management Baseline" for a description of valid GUID values.

*InterfaceType*

Indicates whether *Interface* is supplied in native form. This value indicates the original execution environment of the request. See "Related Definitions."

*Interface*

A pointer to the protocol interface. The *Interface* must adhere to the structure defined by *Protocol*. **NULL** can be used if a structure is not associated with *Protocol*.

### Related Definitions

```

//*****
//EFI_HANDLE
//*****
typedef VOID *EFI_HANDLE;

//*****
//EFI_GUID
//*****
typedef struct {
    UINT32 Data1;
    UINT16 Data2;
    UINT16 Data3;
    UINT8 Data4[8];
} EFI_GUID;

//*****
//EFI_INTERFACE_TYPE
//*****
typedef enum {
    EFI_NATIVE_INTERFACE
} EFI_INTERFACE_TYPE;

```

## Description

The **InstallProtocolInterface()** function installs a protocol interface (a GUID/Protocol Interface structure pair) on a device handle. The same GUID cannot be installed more than once onto the same handle. If installation of a duplicate GUID on a handle is attempted, an **EFI\_INVALID\_PARAMETER** will result.

Installing a protocol interface allows other components to locate the *Handle*, and the interfaces installed on it.

When a protocol interface is installed, the firmware calls all notification functions that have registered to wait for the installation of *Protocol*. For more information, see the [EFI\\_BOOT\\_SERVICES.RegisterProtocolNotify\(\)](#) function description.

## Status Codes Returned

EFI_SUCCESS	The protocol interface was installed.
EFI_OUT_OF_RESOURCES	Space for a new handle could not be allocated.
EFI_INVALID_PARAMETER	<i>Handle</i> is <b>NULL</b> .
EFI_INVALID_PARAMETER	<i>Protocol</i> is <b>NULL</b> .
EFI_INVALID_PARAMETER	<i>InterfaceType</i> is not <b>EFI_NATIVE_INTERFACE</b> .
EFI_INVALID_PARAMETER	<i>Protocol</i> is already installed on the handle specified by <i>Handle</i> .

## EFI\_BOOT\_SERVICES.UninstallProtocolInterface()

### Summary

Removes a protocol interface from a device handle. It is recommended that **UninstallMultipleProtocolInterfaces()** be used in place of **UninstallProtocolInterface()**.

### Prototype

```
typedef
EFI_STATUS
(EFI_API *EFI_UNINSTALL_PROTOCOL_INTERFACE) (
    IN EFI_HANDLE Handle,
    IN EFI_GUID *Protocol,
    IN VOID *Interface
);
```

### Parameters

<i>Handle</i>	The handle on which the interface was installed. If <i>Handle</i> is not a valid handle, then <b>EFI_INVALID_PARAMETER</b> is returned. Type <b>EFI_HANDLE</b> is defined in the <a href="#">EFI_BOOT_SERVICES.InstallProtocolInterface()</a> function description.
<i>Protocol</i>	The numeric ID of the interface. It is the caller's responsibility to pass in a valid GUID. See "Wired For Management Baseline" for a description of valid GUID values. Type <b>EFI_GUID</b> is defined in the <b>InstallProtocolInterface()</b> function description.
<i>Interface</i>	A pointer to the interface. <b>NULL</b> can be used if a structure is not associated with <i>Protocol</i> .

### Description

The **UninstallProtocolInterface()** function removes a protocol interface from the handle on which it was previously installed. The *Protocol* and *Interface* values define the protocol interface to remove from the handle.

The caller is responsible for ensuring that there are no references to a protocol interface that has been removed. In some cases, outstanding reference information is not available in the protocol, so the protocol, once added, cannot be removed. Examples include Console I/O, Block I/O, Disk I/O, and (in general) handles to device protocols.

If the last protocol interface is removed from a handle, the handle is freed and is no longer valid.

### EFI 1.10 Extension

The extension to this service directly addresses the limitations described in the section above. There may be some drivers that are currently consuming the protocol interface that needs to be uninstalled, so it may be dangerous to just blindly remove a protocol interface from the system. Since the usage of protocol interfaces is now being tracked for

components that use the [EFI\\_BOOT\\_SERVICES.OpenProtocol\(\)](#) and [EFI\\_BOOT\\_SERVICES.CloseProtocol\(\)](#) boot services, a safe version of this function can be implemented. Before the protocol interface is removed, an attempt is made to force all the drivers that are consuming the protocol interface to stop consuming that protocol interface. This is done by calling the boot service [EFI\\_BOOT\\_SERVICES.DisconnectController\(\)](#) for the driver that currently have the protocol interface open with an attribute of **EFI\_OPEN\_PROTOCOL\_BY\_DRIVER** or **EFI\_OPEN\_PROTOCOL\_BY\_DRIVER | EFI\_OPEN\_PROTOCOL\_EXCLUSIVE**.

If the disconnect succeeds, then those agents will have called the boot service [EFI\\_BOOT\\_SERVICES.CloseProtocol\(\)](#) to release the protocol interface. Lastly, all of the agents that have the protocol interface open with an attribute of **EFI\_OPEN\_PROTOCOL\_BY\_HANDLE\_PROTOCOL**, **EFI\_OPEN\_PROTOCOL\_GET\_PROTOCOL**, or **EFI\_OPEN\_PROTOCOL\_TEST\_PROTOCOL** are closed. If there are any agents remaining that still have the protocol interface open, the protocol interface is not removed from the handle and **EFI\_ACCESS\_DENIED** is returned. In addition, all of the drivers that were disconnected with the boot service [DisconnectController\(\)](#) earlier, are reconnected with the boot service [EFI\\_BOOT\\_SERVICES.ConnectController\(\)](#). If there are no agents remaining that are consuming the protocol interface, then the protocol interface is removed from the handle as described above.

## Status Codes Returned

EFI_SUCCESS	The interface was removed.
EFI_NOT_FOUND	The interface was not found.
EFI_ACCESS_DENIED	The interface was not removed because the interface is still being used by a driver.
EFI_INVALID_PARAMETER	<i>Handle</i> is <b>NULL</b> .
EFI_INVALID_PARAMETER	<i>Protocol</i> is <b>NULL</b> .

## EFI\_BOOT\_SERVICES.ReinstallProtocolInterface()

### Summary

Reinstalls a protocol interface on a device handle.

### Prototype

```
typedef
EFI_STATUS
(EFI_API *EFI_REINSTALL_PROTOCOL_INTERFACE) (
  IN EFI_HANDLE Handle,
  IN EFI_GUID *Protocol,
  IN VOID *OldInterface,
  IN VOID *NewInterface
);
```

### Parameters

<i>Handle</i>	Handle on which the interface is to be reinstalled. If <i>Handle</i> is not a valid handle, then <b>EFI_INVALID_PARAMETER</b> is returned. Type <b>EFI_HANDLE</b> is defined in the <a href="#">EFI_BOOT_SERVICES.InstallProtocolInterface()</a> function description.
<i>Protocol</i>	The numeric ID of the interface. It is the caller's responsibility to pass in a valid GUID. See "Wired For Management Baseline" for a description of valid GUID values. Type <b>EFI_GUID</b> is defined in the <a href="#">InstallProtocolInterface()</a> function description.
<i>OldInterface</i>	A pointer to the old interface. <b>NULL</b> can be used if a structure is not associated with <i>Protocol</i> .
<i>NewInterface</i>	A pointer to the new interface. <b>NULL</b> can be used if a structure is not associated with <i>Protocol</i> .

### Description

The [ReinstallProtocolInterface\(\)](#) function reinstalls a protocol interface on a device handle. The *OldInterface* for *Protocol* is replaced by the *NewInterface*. *NewInterface* may be the same as *OldInterface*. If it is, the registered protocol notifies occur for the handle without replacing the interface on the handle.

As with [InstallProtocolInterface\(\)](#), any process that has registered to wait for the installation of the interface is notified.

The caller is responsible for ensuring that there are no references to the *OldInterface* that is being removed.

### EFI 1.10 Extension

The extension to this service directly addresses the limitations described in the section above. There may be some number of drivers currently consuming the protocol interface

that is being reinstalled. In this case, it may be dangerous to replace a protocol interface in the system. It could result in an unstable state, because a driver may attempt to use the old protocol interface after a new one has been reinstalled. Since the usage of protocol interfaces is now being tracked for components that use the [EFI\\_BOOT\\_SERVICES.OpenProtocol\(\)](#) and [EFI\\_BOOT\\_SERVICES.CloseProtocol\(\)](#) boot services, a safe version of this function can be implemented.

When this function is called, a call is first made to the boot service [UninstallProtocolInterface\(\)](#). This will guarantee that all of the agents are currently consuming the protocol interface *OldInterface* will stop using *OldInterface*. If [UninstallProtocolInterface\(\)](#) returns **EFI\_ACCESS\_DENIED**, then this function returns **EFI\_ACCESS\_DENIED**, *OldInterface* remains on *Handle*, and the protocol notifies are not processed because *NewInterface* was never installed.

If [UninstallProtocolInterface\(\)](#) succeeds, then a call is made to the boot service [EFI\\_BOOT\\_SERVICES.InstallProtocolInterface\(\)](#) to put the *NewInterface* onto *Handle*.

Finally, the boot service [EFI\\_BOOT\\_SERVICES.ConnectController\(\)](#) is called so all agents that were forced to release *OldInterface* with [UninstallProtocolInterface\(\)](#) can now consume the protocol interface *NewInterface* that was installed with [InstallProtocolInterface\(\)](#). After *OldInterface* has been replaced with *NewInterface*, any process that has registered to wait for the installation of the interface is notified.

## Status Codes Returned

EFI_SUCCESS	The protocol interface was reinstalled.
EFI_NOT_FOUND	The <i>OldInterface</i> on the handle was not found.
EFI_ACCESS_DENIED	The protocol interface could not be reinstalled, because <i>OldInterface</i> is still being used by a driver that will not release it.
EFI_INVALID_PARAMETER	<i>Handle</i> is <b>NULL</b> .
EFI_INVALID_PARAMETER	<i>Protocol</i> is <b>NULL</b> .

## EFI\_BOOT\_SERVICES.RegisterProtocolNotify()

### Summary

Creates an event that is to be signaled whenever an interface is installed for a specified protocol.

### Prototype

```
typedef
EFI_STATUS
(EFI_API *EFI_REGISTER_PROTOCOL_NOTIFY) (
  IN EFI_GUID *Protocol,
  IN EFI_EVENT Event,
  OUT VOID **Registration
);
```

### Parameters

<i>Protocol</i>	The numeric ID of the protocol for which the event is to be registered. Type <b>EFI_GUID</b> is defined in the <a href="#">EFI_BOOT_SERVICES.InstallProtocolInterface()</a> function description.
<i>Event</i>	Event that is to be signaled whenever a protocol interface is registered for <i>Protocol</i> . The type <b>EFI_EVENT</b> is defined in the <a href="#">CreateEvent()</a> function description. The same <b>EFI_EVENT</b> may be used for multiple protocol notify registrations.
<i>Registration</i>	A pointer to a memory location to receive the registration value. This value must be saved and used by the notification function of <i>Event</i> to retrieve the list of handles that have added a protocol interface of type <i>Protocol</i> .

### Description

The [RegisterProtocolNotify\(\)](#) function creates an event that is to be signaled whenever a protocol interface is installed for *Protocol* by [InstallProtocolInterface\(\)](#) or [EFI\\_BOOT\\_SERVICES.ReinstallProtocolInterface\(\)](#).

Once **Event** has been signaled, the [EFI\\_BOOT\\_SERVICES.LocateHandle\(\)](#) function can be called to identify the newly installed, or reinstalled, handles that support *Protocol*. The **Registration** parameter in [EFI\\_BOOT\\_SERVICES.RegisterProtocolNotify\(\)](#) corresponds to the **SearchKey** parameter in [LocateHandle\(\)](#). Note that the same handle may be returned multiple times if the handle reinstalls the target protocol ID multiple times. This is typical for removable media devices, because when such a device reappears, it will reinstall the Block I/O protocol to indicate that the device needs to be checked again. In response, layered Disk I/O and Simple File System protocols may then reinstall their protocols to indicate that they can be re-checked, and so forth.



Events that have been registered for protocol interface notification can be unregistered by calling **CloseEvent()**.

### Status Codes Returned

EFI_SUCCESS	The notification event has been registered.
EFI_OUT_OF_RESOURCES	Space for the notification event could not be allocated.
EFI_INVALID_PARAMETER	<i>Protocol</i> is <b>NULL</b> .
EFI_INVALID_PARAMETER	<i>Event</i> is <b>NULL</b> .
EFI_INVALID_PARAMETER	<i>Registration</i> is <b>NULL</b> .

## EFI\_BOOT\_SERVICES.LocateHandle()

### Summary

Returns an array of handles that support a specified protocol.

### Prototype

```
typedef
EFI_STATUS
(EFIAPI *EFI_LOCATE_HANDLE) (
  IN EFI_LOCATE_SEARCH_TYPE SearchType,
  IN EFI_GUID      *Protocol OPTIONAL,
  IN VOID          *SearchKey OPTIONAL,
  IN OUT UINTN     *BufferSize,
  OUT EFI_HANDLE   *Buffer
);
```

### Parameters

<i>SearchType</i>	Specifies which handle(s) are to be returned. Type <b>EFI_LOCATE_SEARCH_TYPE</b> is defined in "Related Definitions."
<i>Protocol</i>	Specifies the protocol to search by. This parameter is only valid if <i>SearchType</i> is <b>ByProtocol</b> . Type <b>EFI_GUID</b> is defined in the <a href="#">EFI_BOOT_SERVICES.InstallProtocolInterface()</a> function description.
<i>SearchKey</i>	Specifies the search key. This parameter is ignored if <i>SearchType</i> is <b>AllHandles</b> or <b>ByProtocol</b> . If <i>SearchType</i> is <b>ByRegisterNotify</b> , the parameter must be the <i>Registration</i> value returned by function <a href="#">EFI_BOOT_SERVICES.RegisterProtocolNotify()</a> .
<i>BufferSize</i>	On input, the size in bytes of <i>Buffer</i> . On output, the size in bytes of the array returned in <i>Buffer</i> (if the buffer was large enough) or the size, in bytes, of the buffer needed to obtain the array (if the buffer was not large enough).
<i>Buffer</i>	The buffer in which the array is returned. Type <b>EFI_HANDLE</b> is defined in the <a href="#">InstallProtocolInterface()</a> function description.

## Related Definitions

```

//*****
// EFI_LOCATE_SEARCH_TYPE
//*****
typedef enum {
    AllHandles,
    ByRegisterNotify,
    ByProtocol
} EFI_LOCATE_SEARCH_TYPE;
    
```

- AllHandles**                      *Protocol* and *SearchKey* are ignored and the function returns an array of every handle in the system.
- ByRegisterNotify**              *SearchKey* supplies the *Registration* value returned by [EFI\\_BOOT\\_SERVICES.RegisterProtocolNotify\(\)](#). The function returns the next handle that is new for the registration. Only one handle is returned at a time, starting with the first, and the caller must loop until no more handles are returned. *Protocol* is ignored for this search type.
- ByProtocol**                      All handles that support *Protocol* are returned. *SearchKey* is ignored for this search type.

## Description

The **LocateHandle()** function returns an array of handles that match the *SearchType* request. If the input value of *BufferSize* is too small, the function returns **EFI\_BUFFER\_TOO\_SMALL** and updates *BufferSize* to the size of the buffer needed to obtain the array.

## Status Codes Returned

EFI_SUCCESS	The array of handles was returned.
EFI_NOT_FOUND	No handles match the search.
EFI_BUFFER_TOO_SMALL	The <i>BufferSize</i> is too small for the result. <i>BufferSize</i> has been updated with the size needed to complete the request.
EFI_INVALID_PARAMETER	<i>SearchType</i> is not a member of <b>EFI_LOCATE_SEARCH_TYPE</b> .
EFI_INVALID_PARAMETER	<i>SearchType</i> is <b>ByRegisterNotify</b> and <i>SearchKey</i> is <b>NULL</b> .
EFI_INVALID_PARAMETER	<i>SearchType</i> is <b>ByProtocol</b> and <i>Protocol</i> is <b>NULL</b> .
EFI_INVALID_PARAMETER	One or more matches are found and <i>BufferSize</i> is <b>NULL</b> .
EFI_INVALID_PARAMETER	<i>BufferSize</i> is large enough for the result and <i>Buffer</i> is <b>NULL</b> .

## EFI\_BOOT\_SERVICES.HandleProtocol()

### Summary

Queries a handle to determine if it supports a specified protocol.

### Prototype

```
typedef
EFI_STATUS
(EFI_API *EFI_HANDLE_PROTOCOL) (
    IN EFI_HANDLE Handle,
    IN EFI_GUID *Protocol,
    OUT VOID **Interface
);
```

### Parameters

*Handle*

The handle being queried. If *Handle* is **NULL**, then **EFI\_INVALID\_PARAMETER** is returned. Type **EFI\_HANDLE** is defined in the [EFI\\_BOOT\\_SERVICES.InstallProtocolInterface\(\)](#) function description.

*Protocol*

The published unique identifier of the protocol. It is the caller's responsibility to pass in a valid GUID. See "Wired For Management Baseline" for a description of valid GUID values. Type **EFI\_GUID** is defined in the [InstallProtocolInterface\(\)](#) function description.

*Interface*

Supplies the address where a pointer to the corresponding Protocol Interface is returned. **NULL** will be returned in *\*Interface* if a structure is not associated with *Protocol*.

### Description

The **HandleProtocol()** function queries **Handle** to determine if it supports *Protocol*. If it does, then on return *Interface* points to a pointer to the corresponding Protocol Interface. *Interface* can then be passed to any protocol service to identify the context of the request.

### EFI 1.10 Extension

The **HandleProtocol()** function is still available for use by old EFI applications and drivers. However, all new applications and drivers should use [EFI\\_BOOT\\_SERVICES.OpenProtocol\(\)](#) in place of **HandleProtocol()**. The following code fragment shows a possible implementation of **HandleProtocol()** using **OpenProtocol()**. The variable **EfiCoreImageHandle** is the image handle of the EFI core.

```

EFI_STATUS
HandleProtocol (
  IN EFI_HANDLE  Handle,
  IN EFI_GUID    *Protocol,
  OUT VOID       **Interface
)
{
  return OpenProtocol (
    Handle,
    Protocol,
    Interface,
    EfiCoreImageHandle,
    NULL,
    EFI_OPEN_PROTOCOL_BY_HANDLE_PROTOCOL
  );
}

```

### Status Codes Returned

EFI_SUCCESS	The interface information for the specified protocol was returned.
EFI_UNSUPPORTED	The device does not support the specified protocol.
EFI_INVALID_PARAMETER	<i>Handle</i> is <b>NULL</b> .
EFI_INVALID_PARAMETER	<i>Protocol</i> is <b>NULL</b> .
EFI_INVALID_PARAMETER	<i>Interface</i> is <b>NULL</b> .

## EFI\_BOOT\_SERVICES.LocateDevicePath()

### Summary

Locates the handle to a device on the device path that supports the specified protocol.

### Prototype

```
typedef
EFI_STATUS
(EFI_API *EFI_LOCATE_DEVICE_PATH) (
    IN EFI_GUID          *Protocol,
    IN OUT EFI_DEVICE_PATH_PROTOCOL **DevicePath,
    OUT EFI_HANDLE       *Device
);
```

### Parameters

*Protocol*

The protocol to search for. Type **EFI\_GUID** is defined in the [EFI\\_BOOT\\_SERVICES.InstallProtocolInterface\(\)](#) function description.

*DevicePath*

On input, a pointer to a pointer to the device path. On output, the device path pointer is modified to point to the remaining part of the device path—that is, when the function finds the closest handle, it splits the device path into two parts, stripping off the front part, and returning the remaining portion. **EFI\_DEVICE\_PATH\_PROTOCOL** is defined in [Section 10.2](#).

*Device*

A pointer to the returned device handle. Type **EFI\_HANDLE** is defined in the [InstallProtocolInterface\(\)](#) function description.

### Description

The **LocateDevicePath()** function locates all devices on *DevicePath* that support *Protocol* and returns the handle to the device that is closest to *DevicePath*. *DevicePath* is advanced over the device path nodes that were matched.

This function is useful for locating the proper instance of a protocol interface to use from a logical parent device driver. For example, a target device driver may issue the request with its own device path and locate the interfaces to perform I/O on its bus. It can also be used with a device path that contains a file path to strip off the file system portion of the device path, leaving the file path and handle to the file system driver needed to access the file.

If the handle for *DevicePath* supports the protocol (a direct match), the resulting device path is advanced to the device path terminator node. If *DevicePath* is a multi-instance device path, the function will operate on the first instance.

## Status Codes Returned

EFI_SUCCESS	The resulting handle was returned.
EFI_NOT_FOUND	No handles matched the search.
EFI_INVALID_PARAMETER	<i>Protocol</i> is <b>NULL</b> .
EFI_INVALID_PARAMETER	<i>DevicePath</i> is <b>NULL</b> .
EFI_INVALID_PARAMETER	A handle matched the search and <i>Device</i> is <b>NULL</b> .

## EFI\_BOOT\_SERVICES.OpenProtocol()

### Summary

Queries a handle to determine if it supports a specified protocol. If the protocol is supported by the handle, it opens the protocol on behalf of the calling agent. This is an extended version of the EFI boot service [EFI\\_BOOT\\_SERVICES.HandleProtocol\(\)](#).

### Prototype

```
typedef
EFI_STATUS
(EFI_API *EFI_OPEN_PROTOCOL) (
  IN EFI_HANDLE    Handle,
  IN EFI_GUID      *Protocol,
  OUT VOID         **Interface OPTIONAL,
  IN EFI_HANDLE    AgentHandle,
  IN EFI_HANDLE    ControllerHandle,
  IN UINT32        Attributes
);
```

### Parameters

<i>Handle</i>	The handle for the protocol interface that is being opened.
<i>Protocol</i>	The published unique identifier of the protocol. It is the caller's responsibility to pass in a valid GUID. See "Wired For Management Baseline" for a description of valid GUID values.
<i>Interface</i>	Supplies the address where a pointer to the corresponding Protocol Interface is returned. <b>NULL</b> will be returned in <i>Interface</i> if a structure is not associated with <i>Protocol</i> . This parameter is optional, and will be ignored if <i>Attributes</i> is <b>EFI_OPEN_PROTOCOL_TEST_PROTOCOL</b> .
<i>AgentHandle</i>	The handle of the agent that is opening the protocol interface specified by <i>Protocol</i> and <i>Interface</i> . For agents that follow the UEFI <i>Driver Model</i> , this parameter is the handle that contains the <b>EFI_DRIVER_BINDING_PROTOCOL</b> instance that is produced by the UEFI driver that is opening the protocol interface. For UEFI applications, this is the image handle of the UEFI application that is opening the protocol interface. For applications that use <b>HandleProtocol()</b> to open a protocol interface, this parameter is the image handle of the EFI firmware.
<i>ControllerHandle</i>	If the agent that is opening a protocol is a driver that follows the UEFI <i>Driver Model</i> , then this parameter is the controller handle that requires the protocol interface. If the agent does not follow the UEFI <i>Driver Model</i> , then this parameter is optional and may be <b>NULL</b> .



*Attributes*

The open mode of the protocol interface specified by *Handle* and *Protocol*. See "Related Definitions" for the list of legal attributes.

**Description**

This function opens a protocol interface on the handle specified by *Handle* for the protocol specified by *Protocol*. The first three parameters are the same as [EFI\\_BOOT\\_SERVICES.HandleProtocol\(\)](#). The only difference is that the agent that is opening a protocol interface is tracked in an EFI's internal handle database. The tracking is used by the UEFI *Driver Model*, and also used to determine if it is safe to uninstall or reinstall a protocol interface.

The agent that is opening the protocol interface is specified by *AgentHandle*, *ControllerHandle*, and *Attributes*. If the protocol interface can be opened, then *AgentHandle*, *ControllerHandle*, and *Attributes* are added to the list of agents that are consuming the protocol interface specified by *Handle* and *Protocol*. In addition, the protocol interface is returned in *Interface*, and **EFI\_SUCCESS** is returned. If *Attributes* is **TEST\_PROTOCOL**, then *Interface* is optional, and can be **NULL**.

There are a number of reasons that this function call can return an error. If an error is returned, then *AgentHandle*, *ControllerHandle*, and *Attributes* are not added to the list of agents consuming the protocol interface specified by *Handle* and *Protocol*, and *Interface* is returned unmodified. The following is the list of conditions that must be checked before this function can return **EFI\_SUCCESS**.

If *Protocol* is **NULL**, then **EFI\_INVALID\_PARAMETER** is returned.

If *Interface* is **NULL** and *Attributes* is not **TEST\_PROTOCOL**, then **EFI\_INVALID\_PARAMETER** is returned.

If *Handle* is **NULL**, then **EFI\_INVALID\_PARAMETER** is returned.

If *Handle* does not support *Protocol*, then **EFI\_UNSUPPORTED** is returned.

If *Attributes* is not a legal value, then **EFI\_INVALID\_PARAMETER** is returned. The legal values are listed in "Related Definitions."

If *Attributes* is **BY\_CHILD\_CONTROLLER**, **BY\_DRIVER**, **EXCLUSIVE**, or **BY\_DRIVER|EXCLUSIVE**, and *AgentHandle* is **NULL**, then **EFI\_INVALID\_PARAMETER** is returned.

If *Attributes* is **BY\_CHILD\_CONTROLLER**, **BY\_DRIVER**, or **BY\_DRIVER|EXCLUSIVE**, and *ControllerHandle* is **NULL**, then **EFI\_INVALID\_PARAMETER** is returned.

If *Attributes* is **BY\_CHILD\_CONTROLLER** and *Handle* is identical to *ControllerHandle*, then **EFI\_INVALID\_PARAMETER** is returned.

If *Attributes* is **BY\_DRIVER**, **BY\_DRIVER|EXCLUSIVE**, or **EXCLUSIVE**, and there are any items on the open list of the protocol interface with an attribute of **EXCLUSIVE** or **BY\_DRIVER|EXCLUSIVE**, then **EFI\_ACCESS\_DENIED** is returned.

If *Attributes* is **BY\_DRIVER**, and there are any items on the open list of the protocol interface with an attribute of **BY\_DRIVER**, and *AgentHandle* is the same agent handle in the open list item, then **EFI\_ALREADY\_STARTED** is returned.

If *Attributes* is **BY\_DRIVER**, and there are any items on the open list of the protocol interface with an attribute of **BY\_DRIVER**, and *AgentHandle* is different than the agent handle in the open list item, then **EFI\_ACCESS\_DENIED** is returned.

If *Attributes* is **BY\_DRIVER|EXCLUSIVE**, and there are any items on the open list of the protocol interface with an attribute of **BY\_DRIVER|EXCLUSIVE**, and *AgentHandle* is the same agent handle in the open list item, then **EFI\_ALREADY\_STARTED** is returned.

If *Attributes* is **BY\_DRIVER|EXCLUSIVE**, and there are any items on the open list of the protocol interface with an attribute of **BY\_DRIVER|EXCLUSIVE**, and *AgentHandle* is different than the agent handle in the open list item, then **EFI\_ACCESS\_DENIED** is returned.

If *Attributes* is **BY\_DRIVER|EXCLUSIVE** or **EXCLUSIVE**, and there is an item on the open list of the protocol interface with an attribute of **BY\_DRIVER**, then the boot service [EFI\\_BOOT\\_SERVICES.DisconnectController\(\)](#) is called for the driver on the open list. If there is an item in the open list of the protocol interface with an attribute of **BY\_DRIVER** remaining after the [DisconnectController\(\)](#) call has been made, **EFI\_ACCESS\_DENIED** is returned.

## Related Definitions

```
#define EFI_OPEN_PROTOCOL_BY_HANDLE_PROTOCOL 0x00000001
#define EFI_OPEN_PROTOCOL_GET_PROTOCOL      0x00000002
#define EFI_OPEN_PROTOCOL_TEST_PROTOCOL     0x00000004
#define EFI_OPEN_PROTOCOL_BY_CHILD_CONTROLLER 0x00000008
#define EFI_OPEN_PROTOCOL_BY_DRIVER        0x00000010
#define EFI_OPEN_PROTOCOL_EXCLUSIVE        0x00000020
```

The following is the list of legal values for the *Attributes* parameter, and how each value is used.

**BY\_HANDLE\_PROTOCOL** Used in the implementation of [EFI\\_BOOT\\_SERVICES.HandleProtocol\(\)](#). Since [EFI\\_BOOT\\_SERVICES.OpenProtocol\(\)](#) performs the same function as [HandleProtocol\(\)](#) with additional functionality, [HandleProtocol\(\)](#) can simply call [OpenProtocol\(\)](#) with this *Attributes* value.

**GET\_PROTOCOL** Used by a driver to get a protocol interface from a handle. Care must be taken when using this open mode because the driver that opens a protocol interface in this manner will not be informed if the protocol interface is uninstalled or reinstalled. The caller is also not required to close the protocol interface with [EFI\\_BOOT\\_SERVICES.CloseProtocol\(\)](#).

**TEST\_PROTOCOL** Used by a driver to test for the existence of a protocol interface on a handle. *Interface* is optional for this attribute value, so it is ignored, and the caller should only use the return status code. The caller is also not required to close the protocol interface with [CloseProtocol\(\)](#).

- BY\_CHILD\_CONTROLLER** Used by bus drivers to show that a protocol interface is being used by one of the child controllers of a bus. This information is used by the boot service [EFI\\_BOOT\\_SERVICES.ConnectController\(\)](#) to recursively connect all child controllers and by the boot service [EFI\\_BOOT\\_SERVICES.DisconnectController\(\)](#) to get the list of child controllers that a bus driver created.
- BY\_DRIVER** Used by a driver to gain access to a protocol interface. When this mode is used, the driver's [Stop\(\)](#) function will be called by [EFI\\_BOOT\\_SERVICES.DisconnectController\(\)](#) if the protocol interface is reinstalled or uninstalled. Once a protocol interface is opened by a driver with this attribute, no other drivers will be allowed to open the same protocol interface with the **BY\_DRIVER** attribute.
- BY\_DRIVER|EXCLUSIVE** Used by a driver to gain exclusive access to a protocol interface. If any other drivers have the protocol interface opened with an attribute of **BY\_DRIVER**, then an attempt will be made to remove them with [DisconnectController\(\)](#).
- EXCLUSIVE** Used by applications to gain exclusive access to a protocol interface. If any drivers have the protocol interface opened with an attribute of **BY\_DRIVER**, then an attempt will be made to remove them by calling the driver's [Stop\(\)](#) function.

## Status Codes Returned

EFI_SUCCESS	An item was added to the open list for the protocol interface, and the protocol interface was returned in <i>Interface</i> .
EFI_INVALID_PARAMETER	<i>Protocol</i> is <b>NULL</b> .
EFI_INVALID_PARAMETER	<i>Interface</i> is <b>NULL</b> , and <i>Attributes</i> is not <b>TEST_PROTOCOL</b> .
EFI_INVALID_PARAMETER	<i>Handle</i> is <b>NULL</b> ..
EFI_UNSUPPORTED	<i>Handle</i> does not support <i>Protocol</i> .
EFI_INVALID_PARAMETER	<i>Attributes</i> is not a legal value.
EFI_INVALID_PARAMETER	<i>Attributes</i> is <b>BY_CHILD_CONTROLLER</b> and <i>AgentHandle</i> is <b>NULL</b> ..
EFI_INVALID_PARAMETER	<i>Attributes</i> is <b>BY_DRIVER</b> and <i>AgentHandle</i> is <b>NULL</b> .
EFI_INVALID_PARAMETER	<i>Attributes</i> is <b>BY_DRIVER EXCLUSIVE</b> and <i>AgentHandle</i> is <b>NULL</b> .
EFI_INVALID_PARAMETER	<i>Attributes</i> is <b>EXCLUSIVE</b> and <i>AgentHandle</i> is <b>NULL</b> .
EFI_INVALID_PARAMETER	<i>Attributes</i> is <b>BY_CHILD_CONTROLLER</b> and <i>ControllerHandle</i> is <b>NULL</b> .

EFI_INVALID_PARAMETER	<i>Attributes</i> is <b>BY_DRIVER</b> and <i>ControllerHandle</i> is <b>NULL</b> .
EFI_INVALID_PARAMETER	<i>Attributes</i> is <b>BY_DRIVER EXCLUSIVE</b> and <i>ControllerHandle</i> is <b>NULL</b> .
EFI_INVALID_PARAMETER	<i>Attributes</i> is <b>BY_CHILD_CONTROLLER</b> and <i>Handle</i> is identical to <i>ControllerHandle</i> .
EFI_ACCESS_DENIED	<i>Attributes</i> is <b>BY_DRIVER</b> and there is an item on the open list with an attribute of <b>BY_DRIVER EXCLUSIVE</b> or <b>EXCLUSIVE</b> .
EFI_ACCESS_DENIED	<i>Attributes</i> is <b>BY_DRIVER EXCLUSIVE</b> and there is an item on the open list with an attribute of <b>EXCLUSIVE</b> .
EFI_ACCESS_DENIED	<i>Attributes</i> is <b>EXCLUSIVE</b> and there is an item on the open list with an attribute of <b>BY_DRIVER EXCLUSIVE</b> or <b>EXCLUSIVE</b> .
EFI_ALREADY_STARTED	<i>Attributes</i> is <b>BY_DRIVER</b> and there is an item on the open list with an attribute of <b>BY_DRIVER</b> whose agent handle is the same as <i>AgentHandle</i> .
EFI_ACCESS_DENIED	<i>Attributes</i> is <b>BY_DRIVER</b> and there is an item on the open list with an attribute of <b>BY_DRIVER</b> whose agent handle is different than <i>AgentHandle</i> .
EFI_ALREADY_STARTED	<i>Attributes</i> is <b>BY_DRIVER EXCLUSIVE</b> and there is an item on the open list with an attribute of <b>BY_DRIVER EXCLUSIVE</b> whose agent handle is the same as <i>AgentHandle</i> .
EFI_ACCESS_DENIED	<i>Attributes</i> is <b>BY_DRIVER EXCLUSIVE</b> and there is an item on the open list with an attribute of <b>BY_DRIVER EXCLUSIVE</b> whose agent handle is different than <i>AgentHandle</i> .
EFI_ACCESS_DENIED	<i>Attributes</i> is <b>BY_DRIVER EXCLUSIVE</b> or <b>EXCLUSIVE</b> and there are items in the open list with an attribute of <b>BY_DRIVER</b> that could not be removed when <a href="#">EFI_BOOT_SERVICES.DisconnectController()</a> was called for that open item.

## Examples

```

EFI_BOOT_SERVICES *gBS;
EFI_HANDLE ImageHandle;
EFI_DRIVER_BINDING_PROTOCOL *This;
IN EFI_HANDLE ControllerHandle,
extern EFI_GUID gEfiXyzloProtocol;
EFI_XYZ_IO_PROTOCOL *Xyzlo;
EFI_STATUS Status;

//
// EFI_OPEN_PROTOCOL_BY_HANDLE_PROTOCOL example
// Retrieves the XYZ I/O Protocol instance from ControllerHandle
// The application that is opening the protocol is identified by ImageHandle
// Possible return status codes:
// EFI_SUCCESS : The protocol was opened and returned in Xyzlo

```

```

// EFI_UNSUPPORTED : The protocol is not present on ControllerHandle
//
Status = gBS->OpenProtocol (
    ControllerHandle,
    &gEfiXyzloProtocol,
    &Xyzlo,
    ImageHandle,
    NULL,
    EFI_OPEN_PROTOCOL_BY_HANDLE_PROTOCOL
);

//
// EFI_OPEN_PROTOCOL_GET_PROTOCOL example
// Retrieves the XYZ I/O Protocol instance from ControllerHandle
// The driver that is opening the protocol is identified by the
// Driver Binding Protocol instance This. This->DriverBindingHandle
// identifies the agent that is opening the protocol interface, and it
// is opening this protocol on behalf of ControllerHandle.
// Possible return status codes:
// EFI_SUCCESS : The protocol was opened and returned in Xyzlo
// EFI_UNSUPPORTED : The protocol is not present on ControllerHandle
//
Status = gBS->OpenProtocol (
    ControllerHandle,
    &gEfiXyzloProtocol,
    &Xyzlo,
    This->DriverBindingHandle,
    ControllerHandle,
    EFI_OPEN_PROTOCOL_GET_PROTOCOL
);

//
// EFI_OPEN_PROTOCOL_TEST_PROTOCOL example
// Tests to see if the XYZ I/O Protocol is present on ControllerHandle
// The driver that is opening the protocol is identified by the
// Driver Binding Protocol instance This. This->DriverBindingHandle
// identifies the agent that is opening the protocol interface, and it
// is opening this protocol on behalf of ControllerHandle.
// EFI_SUCCESS : The protocol was opened and returned in Xyzlo
// EFI_UNSUPPORTED : The protocol is not present on ControllerHandle
//
Status = gBS->OpenProtocol (
    ControllerHandle,
    &gEfiXyzloProtocol,
    NULL,
    This->DriverBindingHandle,
    ControllerHandle,
    EFI_OPEN_PROTOCOL_TEST_PROTOCOL
);

//
// EFI_OPEN_PROTOCOL_BY_DRIVER example
// Opens the XYZ I/O Protocol on ControllerHandle
// The driver that is opening the protocol is identified by the
// Driver Binding Protocol instance This. This->DriverBindingHandle
// identifies the agent that is opening the protocol interface, and it
// is opening this protocol on behalf of ControllerHandle.
// Possible return status codes:
// EFI_SUCCESS : The protocol was opened and returned in Xyzlo
// EFI_UNSUPPORTED : The protocol is not present on ControllerHandle
// EFI_ALREADY_STARTED : The protocol is already opened by the driver

```

```

// EFI_ACCESS_DENIED : The protocol is managed by a different driver
//
Status = gBS->OpenProtocol (
    ControllerHandle,
    &gEfiXyzloProtocol,
    &Xyzlo,
    This->DriverBindingHandle,
    ControllerHandle,
    EFI_OPEN_PROTOCOL_BY_DRIVER
);

//
// EFI_OPEN_PROTOCOL_BY_DRIVER | EFI_OPEN_PROTOCOL_EXCLUSIVE example
// Opens the XYZ I/O Protocol on ControllerHandle
// The driver that is opening the protocol is identified by the
// Driver Binding Protocol instance This. This->DriverBindingHandle
// identifies the agent that is opening the protocol interface, and it
// is opening this protocol on behalf of ControllerHandle.
// Possible return status codes:
// EFI_SUCCESS : The protocol was opened and returned in Xyzlo. If // a different driver had the
XYZ I/O Protocol opened
// BY_DRIVER, then that driver was disconnected to
// allow this driver to open the XYZ I/O Protocol.
// EFI_UNSUPPORTED : The protocol is not present on ControllerHandle
// EFI_ALREADY_STARTED : The protocol is already opened by the driver
// EFI_ACCESS_DENIED : The protocol is managed by a different driver that // already has the
protocol opened with an EXCLUSIVE // attribute.
//
Status = gBS->OpenProtocol (
    ControllerHandle,
    &gEfiXyzloProtocol,
    &Xyzlo,
    This->DriverBindingHandle,
    ControllerHandle,
    EFI_OPEN_PROTOCOL_BY_DRIVER | EFI_OPEN_PROTOCOL_EXCLUSIVE
);

```

## EFI\_BOOT\_SERVICES.CloseProtocol()

### Summary

Closes a protocol on a handle that was opened using

[EFI\\_BOOT\\_SERVICES.OpenProtocol\(\)](#).

### Prototype

```
typedef
EFI_STATUS
(EFIAPI *EFI_CLOSE_PROTOCOL) (
  IN EFI_HANDLE   Handle,
  IN EFI_GUID     *Protocol,
  IN EFI_HANDLE   AgentHandle,
  IN EFI_HANDLE   ControllerHandle
);
```

### Parameters

*Handle*

The handle for the protocol interface that was previously opened with **OpenProtocol()**, and is now being closed.

*Protocol*

The published unique identifier of the protocol. It is the caller's responsibility to pass in a valid GUID. See "Wired For Management Baseline" for a description of valid GUID values.

*AgentHandle*

The handle of the agent that is closing the protocol interface. For agents that follow the *UEFI Driver Model*, this parameter is the handle that contains the **EFI\_DRIVER\_BINDING\_PROTOCOL** instance that is produced by the UEFI driver that is opening the protocol interface. For UEFI applications, this is the image handle of the UEFI application. For applications that used [EFI\\_BOOT\\_SERVICES.HandleProtocol\(\)](#) to open the protocol interface, this will be the image handle of the EFI firmware.

*ControllerHandle*

If the agent that opened a protocol is a driver that follows the *UEFI Driver Model*, then this parameter is the controller handle that required the protocol interface. If the agent does not follow the *UEFI Driver Model*, then this parameter is optional and may be **NULL**.

### Description

This function updates the handle database to show that the protocol instance specified by *Handle* and *Protocol* is no longer required by the agent and controller specified *AgentHandle* and *ControllerHandle*.

If *Handle* or *AgentHandle* is **NULL**, then **EFI\_INVALID\_PARAMETER** is returned. If *ControllerHandle* is not **NULL**, and *ControllerHandle* is **NULL**, then

**EFI\_INVALID\_PARAMETER** is returned. If *Protocol* is **NULL**, then **EFI\_INVALID\_PARAMETER** is returned.

If the interface specified by *Protocol* is not supported by the handle specified by *Handle*, then **EFI\_NOT\_FOUND** is returned.

If the interface specified by *Protocol* is supported by the handle specified by *Handle*, then a check is made to see if the protocol instance specified by *Protocol* and *Handle* was opened by *AgentHandle* and *ControllerHandle* with [EFI\\_BOOT\\_SERVICES.OpenProtocol\(\)](#). If the protocol instance was not opened by *AgentHandle* and *ControllerHandle*, then **EFI\_NOT\_FOUND** is returned. If the protocol instance was opened by *AgentHandle* and *ControllerHandle*, then all of those references are removed from the handle database, and **EFI\_SUCCESS** is returned.

## Status Codes Returned

EFI_SUCCESS	The protocol instance was closed.
EFI_INVALID_PARAMETER	<i>Handle</i> is <b>NULL</b> .
EFI_INVALID_PARAMETER	<i>AgentHandle</i> is <b>NULL</b> .
EFI_INVALID_PARAMETER	<i>ControllerHandle</i> is not <b>NULL</b> and <i>ControllerHandle</i> is <b>NULL</b> .
EFI_INVALID_PARAMETER	<i>Protocol</i> is <b>NULL</b> .
EFI_NOT_FOUND	<i>Handle</i> does not support the protocol specified by <i>Protocol</i> .
EFI_NOT_FOUND	The protocol interface specified by <i>Handle</i> and <i>Protocol</i> is not currently open by <i>AgentHandle</i> and <i>ControllerHandle</i> .

## Examples

```

EFI_BOOT_SERVICES *gBS;
EFI_HANDLE ImageHandle;
EFI_DRIVER_BINDING_PROTOCOL *This;
IN EFI_HANDLE ControllerHandle,
extern EFI_GUID gEfiXyzloProtocol;
EFI_STATUS Status;

//
// Close the XYZ I/O Protocol that was opened on behalf of ControllerHandle
//
Status = gBS->CloseProtocol (
    ControllerHandle,
    &gEfiXyzloProtocol,
    This->DriverBindingHandle,
    ControllerHandle
);

//
// Close the XYZ I/O Protocol that was opened with BY_HANDLE_PROTOCOL
//
Status = gBS->CloseProtocol (
    ControllerHandle,

```



```
&gEfiXyzloProtocol,  
ImageHandle,  
NULL  
);
```

## EFI\_BOOT\_SERVICES.OpenProtocolInformation()

### Summary

Retrieves the list of agents that currently have a protocol interface opened.

### Prototype

```
typedef
EFI_STATUS
(EFI_API *EFI_OPEN_PROTOCOL_INFORMATION) (
    IN EFI_HANDLE      Handle,
    IN EFI_GUID        *Protocol,
    OUT EFI_OPEN_PROTOCOL_INFORMATION_ENTRY **EntryBuffer,
    OUT UINTN          *EntryCount
);
```

### Parameters

<i>Handle</i>	The handle for the protocol interface that is being queried.
<i>Protocol</i>	The published unique identifier of the protocol. It is the caller's responsibility to pass in a valid GUID. See "Wired For Management Baseline" for a description of valid GUID values.
<i>EntryBuffer</i>	A pointer to a buffer of open protocol information in the form of <b>EFI_OPEN_PROTOCOL_INFORMATION_ENTRY</b> structures. See "Related Definitions" for the declaration of this type. The buffer is allocated by this service, and it is the caller's responsibility to free this buffer when the caller no longer requires the buffer's contents.
<i>EntryCount</i>	A pointer to the number of entries in <i>EntryBuffer</i> .

### Related Definitions

```
typedef struct {
    EFI_HANDLE      AgentHandle;
    EFI_HANDLE      ControllerHandle;
    UINT32          Attributes;
    UINT32          OpenCount;
} EFI_OPEN_PROTOCOL_INFORMATION_ENTRY;
```

### Description

This function allocates and returns a buffer of **EFI\_OPEN\_PROTOCOL\_INFORMATION\_ENTRY** structures. The buffer is returned in *EntryBuffer*, and the number of entries is returned in *EntryCount*.

If the interface specified by *Protocol* is not supported by the handle specified by *Handle*, then **EFI\_NOT\_FOUND** is returned.

If the interface specified by *Protocol* is supported by the handle specified by *Handle*, then *EntryBuffer* is allocated with the boot service [EFI\\_BOOT\\_SERVICES.AllocatePool\(\)](#), and *EntryCount* is set to the number of entries in *EntryBuffer*. Each entry of *EntryBuffer* is filled in with the image handle, controller handle, and attributes that were passed to [EFI\\_BOOT\\_SERVICES.OpenProtocol\(\)](#) when the protocol interface was opened. The field **OpenCount** shows the number of times that the protocol interface has been opened by the agent specified by **ImageHandle**, **ControllerHandle**, and **Attributes**. After the contents of *EntryBuffer* have been filled in, **EFI\_SUCCESS** is returned. It is the caller's responsibility to call [EFI\\_BOOT\\_SERVICES.FreePool\(\)](#) on *EntryBuffer* when the caller no longer required the contents of *EntryBuffer*.

If there are not enough resources available to allocate *EntryBuffer*, then **EFI\_OUT\_OF\_RESOURCES** is returned.

### Status Codes Returned

EFI_SUCCESS	The open protocol information was returned in <i>EntryBuffer</i> , and the number of entries was returned <i>EntryCount</i> .
EFI_NOT_FOUND	<i>Handle</i> does not support the protocol specified by <i>Protocol</i> .
EFI_OUT_OF_RESOURCES	There are not enough resources available to allocate <i>EntryBuffer</i> .

### Examples

See example in the [EFI\\_BOOT\\_SERVICES.LocateHandleBuffer\(\)](#) function description for an example on how **LocateHandleBuffer()**, [EFI\\_BOOT\\_SERVICES.ProtocolsPerHandle\(\)](#), **OpenProtocol()**, and [EFI\\_BOOT\\_SERVICES.OpenProtocolInformation\(\)](#) can be used to traverse the entire handle database.

## EFI\_BOOT\_SERVICES.ConnectController()

### Summary

Connects one or more drivers to a controller.

### Prototype

```
typedef
EFI_STATUS
(EFI_API *EFI_CONNECT_CONTROLLER) (
  IN EFI_HANDLE      ControllerHandle,
  IN EFI_HANDLE      *DriverImageHandle OPTIONAL,
  IN EFI_DEVICE_PATH_PROTOCOL *RemainingDevicePath OPTIONAL,
  IN BOOLEAN         Recursive
);
```

### Parameters

<i>ControllerHandle</i>	The handle of the controller to which driver(s) are to be connected.
<i>DriverImageHandle</i>	A pointer to an ordered list handles that support the <b>EFI_DRIVER_BINDING_PROTOCOL</b> . The list is terminated by a <b>NULL</b> handle value. These handles are candidates for the Driver Binding Protocol(s) that will manage the controller specified by <i>ControllerHandle</i> . This is an optional parameter that may be <b>NULL</b> . This parameter is typically used to debug new drivers.
<i>RemainingDevicePath</i>	A pointer to the device path that specifies a child of the controller specified by <i>ControllerHandle</i> . This is an optional parameter that may be <b>NULL</b> . If it is <b>NULL</b> , then handles for all the children of <i>ControllerHandle</i> will be created. This parameter is passed unchanged to the <a href="#">Supported()</a> and <a href="#">Start()</a> services of the <b>EFI_DRIVER_BINDING_PROTOCOL</b> attached to <i>ControllerHandle</i> .
<i>Recursive</i>	If <b>TRUE</b> , then <b>ConnectController()</b> is called recursively until the entire tree of controllers below the controller specified by <i>ControllerHandle</i> have been created. If <b>FALSE</b> , then the tree of controllers is only expanded one level.

### Description

This function connects one or more drivers to the controller specified by *ControllerHandle*. If *ControllerHandle* is **NULL**, then **EFI\_INVALID\_PARAMETER** is returned. If there are no **EFI\_DRIVER\_BINDING\_PROTOCOL** instances present in the system, then return **EFI\_NOT\_FOUND**. If there are not enough resources available to complete this function, then **EFI\_OUT\_OF\_RESOURCES** is returned.

If the platform supports user authentication, as specified in [Section 35](#), the device path associated with *ControllerHandle* is checked against the connect permissions in the current user profile. If forbidden, then **EFI\_SECURITY\_VIOLATION** is returned. Then, before connecting any of the *DriverImageHandles*, the device path associated with the handle is checked against the connect permissions in the current user profile.

If *Recursive* is **FALSE**, then this function returns after all drivers have been connected to *ControllerHandle*. If *Recursive* is **TRUE**, then **ConnectController()** is called recursively on all of the child controllers of *ControllerHandle*. The child controllers can be identified by searching the handle database for all the controllers that have opened *ControllerHandle* with an attribute of **EFI\_OPEN\_PROTOCOL\_BY\_CHILD\_CONTROLLER**.

This functions uses five precedence rules when deciding the order that drivers are tested against controllers. These five rules from highest precedence to lowest precedence are as follows:

1. *Context Override*: *DriverImageHandle* is an ordered list of handles that support the **EFI\_DRIVER\_BINDING\_PROTOCOL**. The highest priority image handle is the first element of the list, and the lowest priority image handle is the last element of the list. The list is terminated with a **NULL** image handle.
2. *Platform Driver Override*: If an **EFI\_PLATFORM\_DRIVER\_OVERRIDE\_PROTOCOL** instance is present in the system, then the **GetDriver()** service of this protocol is used to retrieve an ordered list of image handles for *ControllerHandle*. From this list, the image handles found in rule (1) above are removed. The first image handle returned from **GetDriver()** has the highest precedence, and the last image handle returned from **GetDriver()** has the lowest precedence. The ordered list is terminated when **GetDriver()** returns **EFI\_NOT\_FOUND**. It is legal for no image handles to be returned by **GetDriver()**. There can be at most a single instance in the system of the **EFI\_PLATFORM\_DRIVER\_OVERRIDE\_PROTOCOL**. If there is more than one, then the system behavior is not deterministic.
3. *Driver Family Override Search*: The list of available driver image handles can be found by using the boot service **EFI\_BOOT\_SERVICES.LocateHandle()** with a *SearchType* of *ByProtocol* for the GUID of the **EFI\_DRIVER\_FAMILY\_OVERRIDE\_PROTOCOL**. From this list, the image handles found in rules (1), and (2) above are removed. The remaining image handles are sorted from highest to lowest based on the value returned from the **GetVersion()** function of the **EFI\_DRIVER\_FAMILY\_OVERRIDE\_PROTOCOL** associated with each image handle.
4. *Bus Specific Driver Override*: If there is an instance of the **EFI\_BUS\_SPECIFIC\_DRIVER\_OVERRIDE\_PROTOCOL** attached to *ControllerHandle*, then the **GetDriver()** service of this protocol is used to retrieve an ordered list of image handle for *ControllerHandle*. From this list, the image handles found in rules (1), (2), and (3) above are removed. The first image handle returned from **GetDriver()** has the highest precedence, and the last image handle returned from **GetDriver()** has the lowest precedence. The ordered list is terminated when **GetDriver()** returns **EFI\_NOT\_FOUND**. It is legal for no image handles to be returned by **GetDriver()**.
5. *Driver Binding Search*: The list of available driver image handles can be found by using the boot service **EFI\_BOOT\_SERVICES.LocateHandle()** with a *SearchType* of *ByProtocol* for the GUID of the **EFI\_DRIVER\_BINDING\_PROTOCOL**. From this list, the image handles found in rules (1), (2), (3), and (4) above are removed. The remaining

image handles are sorted from highest to lowest based on the *Version* field of the **EFI\_DRIVER\_BINDING\_PROTOCOL** instance associated with each image handle.

Each of the five groups of image handles listed above is tested against *ControllerHandle* in order by using the **EFI\_DRIVER\_BINDING\_PROTOCOL** service **Supported()**.

*RemainingDevicePath* is passed into **Supported()** unmodified. The first image handle whose **Supported()** service returns **EFI\_SUCCESS** is marked so the image handle will not be tried again during this call to **ConnectController()**. Then, the **Start()** service of the **EFI\_DRIVER\_BINDING\_PROTOCOL** is called for *ControllerHandle*. Once again, *RemainingDevicePath* is passed in unmodified. Every time **Supported()** returns **EFI\_SUCCESS**, the search for drivers restarts with the highest precedence image handle. This process is repeated until no image handles pass the **Supported()** check.

If at least one image handle returned **EFI\_SUCCESS** from its **Start()** service, then **EFI\_SUCCESS** is returned.

If no image handles returned **EFI\_SUCCESS** from their **Start()** service then **EFI\_NOT\_FOUND** is returned unless *RemainingDevicePath* is not **NULL**, and *RemainingDevicePath* is an End Node. In this special case, **EFI\_SUCCESS** is returned because it is not an error to fail to start a child controller that is specified by an End Device Path Node.

## Status Codes Returned

EFI_SUCCESS	One or more drivers were connected to <i>ControllerHandle</i> .
EFI_SUCCESS	No drivers were connected to <i>ControllerHandle</i> , but <i>RemainingDevicePath</i> is not <b>NULL</b> , and it is an End Device Path Node.
EFI_INVALID_PARAMETER	<i>ControllerHandle</i> is <b>NULL</b> .
EFI_NOT_FOUND	There are no <b>EFI_DRIVER_BINDING_PROTOCOL</b> instances present in the system.
EFI_NOT_FOUND	No drivers were connected to <i>ControllerHandle</i> .
EFI_SECURITY_VIOLATION	The user has no permission to start UEFI device drivers on the device path associated with the <i>ControllerHandle</i> or specified by the <i>RemainingDevicePath</i> .

## Examples

```
//
// Connect All Handles Example
// The following example recursively connects all controllers in a platform.
//
EFI_STATUS      Status;
EFI_BOOT_SERVICES *gBS;
UINTN          HandleCount;
EFI_HANDLE      *HandleBuffer;
UINTN          HandleIndex;

//
// Retrieve the list of all handles from the handle database
```

```

//
Status = gBS->LocateHandleBuffer (
    AllHandles,
    NULL,
    NULL,
    &HandleCount,
    &HandleBuffer
);
if (!EFI_ERROR (Status)) {
for (HandleIndex = 0; HandleIndex < HandleCount; HandleIndex++) {
    Status = gBS->ConnectController (
        HandleBuffer[HandleIndex],
        NULL,
        NULL,
        TRUE
    );
}
gBS->FreePool(HandleBuffer);
}

//
// Connect Device Path Example
// The following example walks the device path nodes of a device path, and
// connects only the drivers required to force a handle with that device path
// to be present in the handle database. This algorithm guarantees that
// only the minimum number of devices and drivers are initialized.
//

EFI_STATUS    Status;
EFI_DEVICE_PATH_PROTOCOL *DevicePath;
EFI_DEVICE_PATH_PROTOCOL *RemainingDevicePath;
EFI_HANDLE    Handle;

do {
//
// Find the handle that best matches the Device Path. If it is only a
// partial match the remaining part of the device path is returned in
// RemainingDevicePath.
//
RemainingDevicePath = DevicePath;
Status = gBS->LocateDevicePath (
    &gEfiDevicePathProtocolGuid,
    &RemainingDevicePath,
    &Handle
);
if (EFI_ERROR(Status)) {
return EFI_NOT_FOUND;
}

//
// Connect all drivers that apply to Handle and RemainingDevicePath
// If no drivers are connected Handle, then return EFI_NOT_FOUND
// The Recursive flag is FALSE so only one level will be expanded.
//
Status = gBS->ConnectController (
    Handle,
    NULL,
    RemainingDevicePath,
    FALSE
);
if (EFI_ERROR(Status)) {

```

```
    return EFI_NOT_FOUND;
}

//
// Loop until RemainingDevicePath is an empty device path
//
} while (!IsDevicePathEnd (RemainingDevicePath));

//
// A handle with DevicePath exists in the handle database
//
return EFI_SUCCESS;
```



## EFI\_BOOT\_SERVICES.DisconnectController()

### Summary

Disconnects one or more drivers from a controller.

### Prototype

```
typedef
EFI_STATUS
(EFI_API *EFI_DISCONNECT_CONTROLLER) (
    IN EFI_HANDLE ControllerHandle,
    IN EFI_HANDLE DriverImageHandle OPTIONAL,
    IN EFI_HANDLE ChildHandle OPTIONAL
);
```

### Parameters

<i>ControllerHandle</i>	The handle of the controller from which driver(s) are to be disconnected.
<i>DriverImageHandle</i>	The driver to disconnect from <i>ControllerHandle</i> . If <i>DriverImageHandle</i> is <b>NULL</b> , then all the drivers currently managing <i>ControllerHandle</i> are disconnected from <i>ControllerHandle</i> .
<i>ChildHandle</i>	The handle of the child to destroy. If <i>ChildHandle</i> is <b>NULL</b> , then all the children of <i>ControllerHandle</i> are destroyed before the drivers are disconnected from <i>ControllerHandle</i> .

### Description

This function disconnects one or more drivers from the controller specified by *ControllerHandle*. If *DriverImageHandle* is **NULL**, then all of the drivers currently managing *ControllerHandle* are disconnected from *ControllerHandle*. If *DriverImageHandle* is not **NULL**, then only the driver specified by *DriverImageHandle* is disconnected from *ControllerHandle*. If *ChildHandle* is **NULL**, then all of the children of *ControllerHandle* are destroyed before the drivers are disconnected from *ControllerHandle*. If *ChildHandle* is not **NULL**, then only the child controller specified by *ChildHandle* is destroyed. If *ChildHandle* is the only child of *ControllerHandle*, then the driver specified by *DriverImageHandle* will be disconnected from *ControllerHandle*. A driver is disconnected from a controller by calling the **Stop()** service of the **EFI\_DRIVER\_BINDING\_PROTOCOL**. The **EFI\_DRIVER\_BINDING\_PROTOCOL** is on the driver image handle, and the handle of the controller is passed into the **Stop()** service. The list of drivers managing a controller, and the list of children for a specific controller can be retrieved from the handle database with the boot service [EFI\\_BOOT\\_SERVICES.OpenProtocolInformation\(\)](#). If all the required drivers are disconnected from *ControllerHandle*, then **EFI\_SUCCESS** is returned.

If *ControllerHandle* is **NULL**, then **EFI\_INVALID\_PARAMETER** is returned. If no drivers are managing *ControllerHandle*, then **EFI\_SUCCESS** is returned. If *DriverImageHandle* is not

**NULL**, and *DriverImageHandle* is **NULL**, then **EFI\_INVALID\_PARAMETER** is returned. If *DriverImageHandle* is not **NULL**, and *DriverImageHandle* is not currently managing *ControllerHandle*, then **EFI\_SUCCESS** is returned. If *ChildHandle* is not **NULL**, and *ChildHandle* is **NULL**, then **EFI\_INVALID\_PARAMETER** is returned. If there are not enough resources available to disconnect drivers from *ControllerHandle*, then **EFI\_OUT\_OF\_RESOURCES** is returned.

## Status Codes Returned

EFI_SUCCESS	One or more drivers were disconnected from the controller.
EFI_SUCCESS	On entry, no drivers are managing <i>ControllerHandle</i> .
EFI_SUCCESS	<i>DriverImageHandle</i> is not <b>NULL</b> , and on entry <i>DriverImageHandle</i> is not managing <i>ControllerHandle</i> .
EFI_INVALID_PARAMETER	<i>ControllerHandle</i> is <b>NULL</b> .
EFI_INVALID_PARAMETER	<i>DriverImageHandle</i> is not <b>NULL</b> , and it is not a valid <b>EFI_HANDLE</b> .
EFI_INVALID_PARAMETER	<i>ChildHandle</i> is not <b>NULL</b> , and it is not a valid <b>EFI_HANDLE</b> .
EFI_OUT_OF_RESOURCES	There are not enough resources available to disconnect any drivers from <i>ControllerHandle</i> .
EFI_DEVICE_ERROR	The controller could not be disconnected because of a device error.
EFI_INVALID_PARAMETER	<i>DriverImageHandle</i> does not support the <b>EFI_DRIVER_BINDING_PROTOCOL</b> .

## Examples

```
//
// Disconnect All Handles Example
// The following example recursively disconnects all drivers from all
// controllers in a platform.
//
EFI_STATUS      Status;
EFI_BOOT_SERVICES *gBS;
UINTN          HandleCount;
EFI_HANDLE      *HandleBuffer;
UINTN          HandleIndex;

//
// Retrieve the list of all handles from the handle database
//
Status = gBS->LocateHandleBuffer (
    AllHandles,
    NULL,
    NULL,
    &HandleCount,
    &HandleBuffer
);
if (!EFI_ERROR (Status)) {
    for (HandleIndex = 0; HandleIndex < HandleCount; HandleIndex++) {
```

```
Status = gBS->DisconnectController (  
    HandleBuffer[HandleIndex],  
    NULL,  
    NULL  
);  
}  
gBS->FreePool(HandleBuffer);
```

## EFI\_BOOT\_SERVICES.ProtocolsPerHandle()

### Summary

Retrieves the list of protocol interface GUIDs that are installed on a handle in a buffer allocated from pool.

### Prototype

```
typedef
EFI_STATUS
(EFI_API *EFI_PROTOCOLS_PER_HANDLE) (
    IN EFI_HANDLE Handle,
    OUT EFI_GUID ***ProtocolBuffer,
    OUT UINTN *ProtocolBufferCount
);
```

### Parameters

<i>Handle</i>	The handle from which to retrieve the list of protocol interface GUIDs.
<i>ProtocolBuffer</i>	A pointer to the list of protocol interface GUID pointers that are installed on <i>Handle</i> . This buffer is allocated with a call to the Boot Service <a href="#">EFI_BOOT_SERVICES.AllocatePool()</a> . It is the caller's responsibility to call the Boot Service <a href="#">EFI_BOOT_SERVICES.FreePool()</a> when the caller no longer requires the contents of <i>ProtocolBuffer</i> .
<i>ProtocolBufferCount</i>	A pointer to the number of GUID pointers present in <i>ProtocolBuffer</i> .

### Description

The **ProtocolsPerHandle()** function retrieves the list of protocol interface GUIDs that are installed on *Handle*. The list is returned in *ProtocolBuffer*, and the number of GUID pointers in *ProtocolBuffer* is returned in *ProtocolBufferCount*.

If *Handle* is **NULL** or *Handle* is **NULL**, then **EFI\_INVALID\_PARAMETER** is returned.

If *ProtocolBuffer* is **NULL**, then **EFI\_INVALID\_PARAMETER** is returned.

If *ProtocolBufferCount* is **NULL**, then **EFI\_INVALID\_PARAMETER** is returned.

If there are not enough resources available to allocate *ProtocolBuffer*, then **EFI\_OUT\_OF\_RESOURCES** is returned.

## Status Codes Returned

EFI_SUCCESS	The list of protocol interface GUIDs installed on <i>Handle</i> was returned in <i>ProtocolBuffer</i> . The number of protocol interface GUIDs was returned in <i>ProtocolBufferCount</i> .
EFI_INVALID_PARAMETER	<i>Handle</i> is <b>NULL</b> .
EFI_INVALID_PARAMETER	<i>ProtocolBuffer</i> is <b>NULL</b> .
EFI_INVALID_PARAMETER	<i>ProtocolBufferCount</i> is <b>NULL</b> .
EFI_OUT_OF_RESOURCES	There is not enough pool memory to store the results.

## Examples

See example in the [EFI\\_BOOT\\_SERVICES.LocateHandleBuffer\(\)](#) function description for an example on how [LocateHandleBuffer\(\)](#), [EFI\\_BOOT\\_SERVICES.ProtocolsPerHandle\(\)](#), [EFI\\_BOOT\\_SERVICES.OpenProtocol\(\)](#), and [EFI\\_BOOT\\_SERVICES.OpenProtocolInformation\(\)](#) can be used to traverse the entire handle database.

## EFI\_BOOT\_SERVICES.LocateHandleBuffer()

### Summary

Returns an array of handles that support the requested protocol in a buffer allocated from pool.

### Prototype

```
typedef
EFI_STATUS
(EFI_API *EFI_LOCATE_HANDLE_BUFFER) (
  IN EFI_LOCATE_SEARCH_TYPE SearchType,
  IN EFI_GUID *Protocol OPTIONAL,
  IN VOID *SearchKey OPTIONAL,
  IN OUT UINTN *NoHandles,
  OUT EFI_HANDLE **Buffer
);
```

### Parameters

<i>SearchType</i>	Specifies which handle(s) are to be returned.
<i>Protocol</i>	Provides the protocol to search by. This parameter is only valid for a <i>SearchType</i> of <b>ByProtocol</b> .
<i>SearchKey</i>	Supplies the search key depending on the <i>SearchType</i> .
<i>NoHandles</i>	The number of handles returned in <i>Buffer</i> .
<i>Buffer</i>	A pointer to the buffer to return the requested array of handles that support <i>Protocol</i> . This buffer is allocated with a call to the Boot Service <a href="#">EFI_BOOT_SERVICES.AllocatePool()</a> . It is the caller's responsibility to call the Boot Service <a href="#">EFI_BOOT_SERVICES.FreePool()</a> when the caller no longer requires the contents of <i>Buffer</i> .

### Description

The **LocateHandleBuffer()** function returns one or more handles that match the *SearchType* request. *Buffer* is allocated from pool, and the number of entries in *Buffer* is returned in *NoHandles*. Each *SearchType* is described below:

<b>AllHandles</b>	<i>Protocol</i> and <i>SearchKey</i> are ignored and the function returns an array of every handle in the system.
<b>ByRegisterNotify</b>	<i>SearchKey</i> supplies the Registration returned by <a href="#">EFI_BOOT_SERVICES.RegisterProtocolNotify()</a> . The function returns the next handle that is new for the Registration. Only one handle is returned at a time, and the caller must loop until no more handles are returned. <i>Protocol</i> is ignored for this search type.
<b>ByProtocol</b>	All handles that support <i>Protocol</i> are returned. <i>SearchKey</i> is ignored for this search type.

If *NoHandles* is **NULL**, then **EFI\_INVALID\_PARAMETER** is returned.

If *Buffer* is **NULL**, then **EFI\_INVALID\_PARAMETER** is returned.

If there are no handles in the handle database that match the search criteria, then **EFI\_NOT\_FOUND** is returned.

If there are not enough resources available to allocate *Buffer*, then **EFI\_OUT\_OF\_RESOURCES** is returned.

## Status Codes Returned

EFI_SUCCESS	The array of handles was returned in <i>Buffer</i> , and the number of handles in <i>Buffer</i> was returned in <i>NoHandles</i> .
EFI_INVALID_PARAMETER	<i>NoHandles</i> is <b>NULL</b>
EFI_INVALID_PARAMETER	<i>Buffer</i> is <b>NULL</b>
EFI_NOT_FOUND	No handles match the search.
EFI_OUT_OF_RESOURCES	There is not enough pool memory to store the matching results.

## Examples

```
//
// The following example traverses the entire handle database. First all of
// the handles in the handle database are retrieved by using
// LocateHandleBuffer(). Then it uses ProtocolsPerHandle() to retrieve the
// list of protocol GUIDs attached to each handle. Then it uses OpenProtocol()
// to get the protocol instance associated with each protocol GUID on the
// handle. Finally, it uses OpenProtocolInformation() to retrieve the list of
// agents that have opened the protocol on the handle. The caller of these
// functions must make sure that they free the return buffers with FreePool()
// when they are done.
//
EFI_STATUS      Status;
EFI_BOOT_SERVICES *gBS;
EFI_HANDLE      ImageHandle;
UINTN           HandleCount;
EFI_HANDLE      *HandleBuffer;
UINTN           HandleIndex;
EFI_GUID        **ProtocolGuidArray;
UINTN           ArrayCount;
UINTN           ProtocolIndex;
EFI_OPEN_PROTOCOL_INFORMATION_ENTRY *OpenInfo;
UINTN           OpenInfoCount;
UINTN           OpenInfoIndex;

//
// Retrieve the list of all handles from the handle database
//
Status = gBS->LocateHandleBuffer (
    AllHandles,
    NULL,
    NULL,
    &HandleCount,
    &HandleBuffer
);
if (!EFI_ERROR (Status)) {
```

```

for (HandleIndex = 0; HandleIndex < HandleCount; HandleIndex++) {
//
// Retrieve the list of all the protocols on each handle
//
Status = gBS->ProtocolsPerHandle (
    HandleBuffer[HandleIndex],
    &ProtocolGuidArray,
    &ArrayCount
);
if (!EFI_ERROR (Status)) {
for (ProtocolIndex = 0; ProtocolIndex < ArrayCount; ProtocolIndex++) {
//
// Retrieve the protocol instance for each protocol
//
Status = gBS->OpenProtocol (
    HandleBuffer[HandleIndex],
    ProtocolGuidArray[ProtocolIndex],
    &Instance,
    ImageHandle,
    NULL,
    EFI_OPEN_PROTOCOL_GET_PROTOCOL
);

//
// Retrieve the list of agents that have opened each protocol
//
Status = gBS->OpenProtocolInformation (
    HandleBuffer[HandleIndex],
    ProtocolGuidArray[ProtocolIndex],
    &OpenInfo,
    &OpenInfoCount
);
if (!EFI_ERROR (Status)) {
for (OpenInfoIndex=0;OpenInfoIndex<OpenInfoCount;OpenInfoIndex++) {
//
// HandleBuffer[HandleIndex] is the handle
// ProtocolGuidArray[ProtocolIndex] is the protocol GUID
// Instance is the protocol instance for the protocol
// OpenInfo[OpenInfoIndex] is an agent that has opened a protocol
//
}
if (OpenInfo != NULL) {
gBS->FreePool(OpenInfo);
}
}
if (ProtocolGuidArray != NULL) {
gBS->FreePool(ProtocolGuidArray);
}
}
}
if (HandleBuffer != NULL) {
gBS->FreePool (HandleBuffer);
}
}

```



## EFI\_BOOT\_SERVICES.LocateProtocol()

### Summary

Returns the first protocol instance that matches the given protocol.

### Prototype

```
typedef
EFI_STATUS
(EFI_API *EFI_LOCATE_PROTOCOL) (
  IN EFI_GUID *Protocol,
  IN VOID *Registration OPTIONAL,
  OUT VOID **Interface
);
```

### Parameters

<i>Protocol</i>	Provides the protocol to search for.
<i>Registration</i>	Optional registration key returned from <a href="#">EFI_BOOT_SERVICES.RegisterProtocolNotify()</a> . If <i>Registration</i> is <b>NULL</b> , then it is ignored.
<i>Interface</i>	On return, a pointer to the first interface that matches <i>Protocol</i> and <i>Registration</i> .

### Description

The **LocateProtocol()** function finds the first device handle that support *Protocol*, and returns a pointer to the protocol interface from that handle in *Interface*. If no protocol instances are found, then *Interface* is set to **NULL**.

If *Interface* is **NULL**, then **EFI\_INVALID\_PARAMETER** is returned.

If *Protocol* is **NULL**, then **EFI\_INVALID\_PARAMETER** is returned.

If *Registration* is **NULL**, and there are no handles in the handle database that support *Protocol*, then **EFI\_NOT\_FOUND** is returned.

If *Registration* is not **NULL**, and there are no new handles for *Registration*, then **EFI\_NOT\_FOUND** is returned.

### Status Codes Returned

EFI_SUCCESS	A protocol instance matching <i>Protocol</i> was found and returned in <i>Interface</i> .
EFI_INVALID_PARAMETER	<i>Interface</i> is <b>NULL</b> . <i>Protocol</i> is <b>NULL</b> .
EFI_NOT_FOUND	No protocol instances were found that match <i>Protocol</i> and <i>Registration</i> .

## EFI\_BOOT\_SERVICES.InstallMultipleProtocolInterfaces()

### Summary

Installs one or more protocol interfaces into the boot services environment.

### Prototype

```
typedef
EFI_STATUS
EFI_API *EFI_INSTALL_MULTIPLE_PROTOCOL_INTERFACES) (
    IN OUT EFI_HANDLE *Handle,
    ...
);
```

### Parameters

<i>Handle</i>	The pointer to a handle to install the new protocol interfaces on, or a pointer to <b>NULL</b> if a new handle is to be allocated.
...	A variable argument list containing pairs of protocol GUIDs and protocol interfaces.

### Description

This function installs a set of protocol interfaces into the boot services environment. It removes arguments from the variable argument list in pairs. The first item is always a pointer to the protocol's GUID, and the second item is always a pointer to the protocol's interface. These pairs are used to call the boot service [EFI\\_BOOT\\_SERVICES.InstallProtocolInterface\(\)](#) to add a protocol interface to *Handle*. If *Handle* is **NULL** on entry, then a new handle will be allocated. The pairs of arguments are removed in order from the variable argument list until a **NULL** protocol GUID value is found. If any errors are generated while the protocol interfaces are being installed, then all the protocols installed prior to the error will be uninstalled with the boot service [EFI\\_BOOT\\_SERVICES.UninstallProtocolInterface\(\)](#) before the error is returned. The same GUID cannot be installed more than once onto the same handle.

It is illegal to have two handles in the handle database with identical device paths. This service performs a test to guarantee a duplicate device path is not inadvertently installed on two different handles. Before any protocol interfaces are installed onto *Handle*, the list of GUID/pointer pair parameters are searched to see if a Device Path Protocol instance is being installed. If a Device Path Protocol instance is going to be installed onto *Handle*, then a check is made to see if a handle is already present in the handle database with an identical Device Path Protocol instance. If an identical Device Path Protocol instance is already present in the handle database, then no protocols are installed onto *Handle*, and **EFI\_ALREADY\_STARTED** is returned.

### Status Codes Returned

EFI_SUCCESS	All the protocol interfaces were installed.
-------------	---

EFI_ALREADY_STARTED	A Device Path Protocol instance was passed in that is already present in the handle database.
EFI_OUT_OF_RESOURCES	There was not enough memory in pool to install all the protocols.
EFI_INVALID_PARAMETER	Handle is NULL.
EFI_INVALID_PARAMETER	Protocol is already installed on the handle specified by Handle.

## EFI\_BOOT\_SERVICES.UninstallMultipleProtocolInterfaces()

### Summary

Removes one or more protocol interfaces into the boot services environment.

### Prototype

```
typedef
EFI_STATUS
EFI_API *EFI_UNINSTALL_MULTIPLE_PROTOCOL_INTERFACES) (
    IN EFI_HANDLE Handle,
    ...
);
```

### Parameters

*Handle* The handle to remove the protocol interfaces from.

...A variable argument list containing pairs of protocol GUIDs and protocol interfaces.

### Description

This function removes a set of protocol interfaces from the boot services environment. It removes arguments from the variable argument list in pairs. The first item is always a pointer to the protocol's GUID, and the second item is always a pointer to the protocol's interface. These pairs are used to call the boot service [EFI\\_BOOT\\_SERVICES.UninstallProtocolInterface\(\)](#) to remove a protocol interface from *Handle*. The pairs of arguments are removed in order from the variable argument list until a **NULL** protocol GUID value is found. If all of the protocols are uninstalled from *Handle*, then **EFI\_SUCCESS** is returned. If any errors are generated while the protocol interfaces are being uninstalled, then the protocols uninstalled prior to the error will be reinstalled with the boot service [EFI\\_BOOT\\_SERVICES.InstallProtocolInterface\(\)](#) and the status code **EFI\_INVALID\_PARAMETER** is returned.

### Status Codes Returned

EFI_SUCCESS	All the protocol interfaces were removed.
EFI_INVALID_PARAMETER	One of the protocol interfaces was not previously installed on <i>Handle</i> .

## 7.4 Image Services

Three types of images can be loaded: UEFI applications written (see [Section 2.1.2](#)), UEFI boot services drivers (see [Section 2.1.4](#)), and EFI runtime drivers (see [Section 2.1.4](#)). A UEFI OS Loader (see [Section 2.1.3](#)) is a type of UEFI application. The most significant difference between these image types is the type of memory into which they are loaded by the firmware's loader. [Table 28](#) summarizes the differences between images.

Table 28. Image Type Differences Summary

	UEFI Application	UEFI Boot Service Driver	UEFI Runtime Driver
Description	A transient application that is loaded during boot services time. UEFI applications are either unloaded when they complete (see <a href="#">Section 2.1.2</a> ), or they take responsibility for the continued operation of the system via <b>ExitBootServices()</b> (see <a href="#">Section 2.1.3</a> ). The UEFI applications are loaded in sequential order by the boot manager, but one UEFI application may dynamically load another.	A program that is loaded into boot services memory and stays resident until boot services terminate. See <a href="#">Section 2.1.4</a> .	A program that is loaded into runtime services memory and stays resident during runtime. The memory required for a UEFI runtime services driver must be performed in a single memory allocation, and marked as <b>EfiRuntimeServicesData</b> . (Note that the memory only stays resident when booting an EFI-compatible operating system. Legacy operating systems will reuse the memory.) See <a href="#">Section 2.1.4</a> .
Loaded into memory type	<b>EfiLoaderCode</b> , <b>EfiLoaderData</b>	<b>EfiBootServicesCode</b> , <b>EfiBootServicesData</b>	EfiRuntimeServicesCode, EfiRuntimeServicesData
Default pool allocations from memory type	EfiLoaderData	EfiBootServicesData	<b>EfiRuntimeServicesData</b>
Exit behavior	When an application exits, firmware frees the memory used to hold its image.	When a UEFI boot service driver exits with an error code, firmware frees the memory used to hold its image. When a UEFI boot service driver's entry point completes with <b>EFI_SUCCESS</b> , the image is retained in memory.	When a UEFI runtime driver exits with an error code, firmware frees the memory used to hold its image. When a UEFI runtime services driver's entry point completes with <b>EFI_SUCCESS</b> , the image is retained in memory.
Notes	This type of image would not install any protocol interfaces or handles.	This type of image would typically use <b>InstallProtocolInterface()</b> .	A UEFI runtime driver can only allocate runtime memory during boot services time. Due to the complexity of performing a virtual relocation for a runtime image, this driver type is discouraged unless it is absolutely required.

Most UEFI images are loaded by the boot manager. When a UEFI application or UEFI driver is installed, the installation procedure registers itself with the boot manager for loading. However, in some cases a UEFI application or UEFI driver may want to programmatically load and start another UEFI image. This can be done with the [EFI\\_BOOT\\_SERVICES.LoadImage\(\)](#) and [EFI\\_BOOT\\_SERVICES.StartImage\(\)](#) interfaces. UEFI drivers may only load UEFI applications during the UEFI driver's initialization entry point. [Table 29](#) lists the functions that make up Image Services.

**Table 29. Image Functions**

Name	Type	Description
LoadImage	Boot	Loads an EFI image into memory.
StartImage	Boot	Transfers control to a loaded image's entry point.
UnloadImage	Boot	Unloads an image.
EFI_IMAGE_ENTRY_POINT	Boot	Prototype of an EFI Image's entry point.
Exit	Boot	Exits the image's entry point.
ExitBootServices	Boot	Terminates boot services.

The Image boot services have been modified to take advantage of the information that is now being tracked with the [EFI\\_BOOT\\_SERVICES.OpenProtocol\(\)](#) and [EFI\\_BOOT\\_SERVICES.CloseProtocol\(\)](#) boot services. Since the usage of protocol interfaces is being tracked with these new boot services, it is now possible to automatically close protocol interfaces when a UEFI application or a UEFI driver is unloaded or exited.

## EFI\_BOOT\_SERVICES.LoadImage()

### Summary

Loads an EFI image into memory.

### Prototype

```
typedef
EFI_STATUS
(EFIAPI *EFI_IMAGE_LOAD) (
    IN BOOLEAN      BootPolicy,
    IN EFI_HANDLE   ParentImageHandle,
    IN EFI_DEVICE_PATH_PROTOCOL *DevicePath,
    IN VOID         *SourceBuffer OPTIONAL,
    IN UINTN        SourceSize,
    OUT EFI_HANDLE  *ImageHandle
);
```

### Parameters

<i>BootPolicy</i>	If <b>TRUE</b> , indicates that the request originates from the boot manager, and that the boot manager is attempting to load <i>DevicePath</i> as a boot selection. Ignored if <i>SourceBuffer</i> is not <b>NULL</b> .
<i>ParentImageHandle</i>	The caller's image handle. Type <b>EFI_HANDLE</b> is defined in the <a href="#">EFI_BOOT_SERVICES.InstallProtocolInterface()</a> function description. This field is used to initialize the <i>ParentHandle</i> field of the <a href="#">EFI_LOADED_IMAGE_PROTOCOL</a> for the image that is being loaded.
<i>DevicePath</i>	The <i>DeviceHandle</i> specific file path from which the image is loaded. <b>EFI_DEVICE_PATH_PROTOCOL</b> is defined in <a href="#">Section 10.2</a> .
<i>SourceBuffer</i>	If not <b>NULL</b> , a pointer to the memory location containing a copy of the image to be loaded.
<i>SourceSize</i>	The size in bytes of <i>SourceBuffer</i> . Ignored if <i>SourceBuffer</i> is <b>NULL</b> .
<i>ImageHandle</i>	Pointer to the returned image handle that is created when the image is successfully loaded. Type <b>EFI_HANDLE</b> is defined in the <a href="#">InstallProtocolInterface()</a> function description.

## Related Definitions

```
#define EFI_HII_PACKAGE_LIST_PROTOCOL_GUID \
  { 0x6a1ee763, 0xd47a, 0x43b4, \
    { 0xaa, 0xbe, 0xef, 0x1d, 0xe2, 0xab, 0x56, 0xfc } }

typedef EFI_HII_PACKAGE_LIST_HEADER *EFI_HII_PACKAGE_LIST_PROTOCOL;
```

## Description

The **LoadImage()** function loads an EFI image into memory and returns a handle to the image. The image is loaded in one of two ways.

- If *SourceBuffer* is not **NULL**, the function is a memory-to-memory load in which *SourceBuffer* points to the image to be loaded and *SourceSize* indicates the image's size in bytes. In this case, the caller has copied the image into *SourceBuffer* and can free the buffer once loading is complete.
- If *SourceBuffer* is **NULL**, the function is a file copy operation that uses the [EFI\\_SIMPLE\\_FILE\\_SYSTEM\\_PROTOCOL](#).

If there is no instance of [EFI\\_SIMPLE\\_FILE\\_SYSTEM\\_PROTOCOL](#) associated with file path, then this function will attempt to use [EFI\\_LOAD\\_FILE\\_PROTOCOL](#) (*BootPolicy* is **TRUE**) or [EFI\\_LOAD\\_FILE2\\_PROTOCOL](#), and then [EFI\\_LOAD\\_FILE\\_PROTOCOL](#) (*BootPolicy* is **FALSE**).

In all cases, this function will use the instance of these protocols associated with the handle that most closely matches *DevicePath* will be used. See the boot service description for more information on how the closest handle is located.

- In the case of [EFI\\_SIMPLE\\_FILE\\_SYSTEM\\_PROTOCOL](#), the path name from the File Path Media Device Path node(s) of *DevicePath* is used.
- In the case of [EFI\\_LOAD\\_FILE\\_PROTOCOL](#), the remaining device path nodes of *DevicePath* and the *BootPolicy* flag are passed to the [EFI\\_LOAD\\_FILE\\_PROTOCOL.LoadFile\(\)](#) function. The default image responsible for booting is loaded when *DevicePath* specifies only the device (and there are no further device nodes). For more information see the discussion of the [EFI\\_LOAD\\_FILE\\_PROTOCOL](#) in [Section 13.1](#).
- In the case of [EFI\\_LOAD\\_FILE2\\_PROTOCOL](#), the behavior is the same as above, except that it is only used if *BootOption* is **FALSE**. For more information, see the discussion of the [EFI\\_LOAD\\_FILE2\\_PROTOCOL](#).
- If the platform supports driver signing, as specified in [Section 31.4.2](#), and the image signature is not valid, then information about the image is recorded (see Image Execution Information Table in [Section 31.4.2](#)) and **EFI\_SECURITY\_VIOLATION** is returned.
- If the platform supports user authentication, as described in [Section 35](#), and loading of images on the specified *FilePath* is forbidden in the current user profile, then the information about the image is recorded (see Deferred Execution in [Section 35.1.5](#)) and **EFI\_SECURITY\_VIOLATION** is returned.



Once the image is loaded, firmware creates and returns an **EFI\_HANDLE** that identifies the image and supports [EFI\\_LOADED\\_IMAGE\\_PROTOCOL](#) and the **EFI\_LOADED\_IMAGE\_DEVICE\_PATH\_PROTOCOL**. The caller may fill in the image's "load options" data, or add additional protocol support to the handle before passing control to the newly loaded image by calling [EFI\\_BOOT\\_SERVICES.StartImage\(\)](#). Also, once the image is loaded, the caller either starts it by calling **StartImage()** or unloads it by calling [EFI\\_BOOT\\_SERVICES.UnloadImage\(\)](#).

Once the image is loaded, **LoadImage()** installs **EFI\_HII\_PACKAGE\_LIST\_PROTOCOL** on the handle if the image contains a custom PE/COFF resource with the type 'HII'. The protocol's interface pointer points to the HII package list which is contained in the resource's data. The format of this is in [Section 32.3.1](#).

## Status Codes Returned

EFI_SUCCESS	Image was loaded into memory correctly.
EFI_NOT_FOUND	Both <i>SourceBuffer</i> and <i>DevicePath</i> are <b>NULL</b> .
EFI_INVALID_PARAMETER	One of the parameters has an invalid value.
EFI_INVALID_PARAMETER	<i>ImageHandle</i> is <b>NULL</b> .
EFI_INVALID_PARAMETER	<i>ParentImageHandle</i> is <b>NULL</b> .
EFI_INVALID_PARAMETER	<i>ParentImageHandle</i> is <b>NULL</b> .
EFI_UNSUPPORTED	The image type is not supported.
EFI_OUT_OF_RESOURCES	Image was not loaded due to insufficient resources.
EFI_LOAD_ERROR	Image was not loaded because the image format was corrupt or not understood.
EFI_DEVICE_ERROR	Image was not loaded because the device returned a read error.
EFI_ACCESS_DENIED	Image was not loaded because the platform policy prohibits the image from being loaded. <b>NULL</b> is returned in <i>*ImageHandle</i> .
EFI_SECURITY_VIOLATION	Image was loaded and an <i>ImageHandle</i> was created with a valid <b>EFI_LOADED_IMAGE_PROTOCOL</b> . However, the current platform policy specifies that the image should not be started.

## EFI\_BOOT\_SERVICES.StartImage()

### Summary

Transfers control to a loaded image's entry point.

### Prototype

```
typedef
EFI_STATUS
(EFI_API *EFI_IMAGE_START) (
    IN EFI_HANDLE    ImageHandle,
    OUT UINTN        *ExitDataSize,
    OUT CHAR16       **ExitData OPTIONAL
);
```

### Parameters

<i>ImageHandle</i>	Handle of image to be started. Type <b>EFI_HANDLE</b> is defined in the <a href="#">EFI_BOOT_SERVICES.InstallProtocolInterface()</a> function description.
<i>ExitDataSize</i>	Pointer to the size, in bytes, of <i>ExitData</i> . If <i>ExitData</i> is <b>NULL</b> , then this parameter is ignored and the contents of <i>ExitDataSize</i> are not modified.
<i>ExitData</i>	Pointer to a pointer to a data buffer that includes a Null-terminated string, optionally followed by additional binary data. The string is a description that the caller may use to further indicate the reason for the image's exit.

### Description

The **StartImage()** function transfers control to the entry point of an image that was loaded by [EFI\\_BOOT\\_SERVICES.LoadImage\(\)](#). The image may only be started one time.

Control returns from **StartImage()** when the loaded image's **EFI\_IMAGE\_ENTRY\_POINT** returns or when the loaded image calls [EFI\\_BOOT\\_SERVICES.Exit\(\)](#). When that call is made, the *ExitData* buffer and *ExitDataSize* from **Exit()** are passed back through the *ExitData* buffer and *ExitDataSize* in this function. The caller of this function is responsible for returning the *ExitData* buffer to the pool by calling [EFI\\_BOOT\\_SERVICES.FreePool\(\)](#) when the buffer is no longer needed. Using **Exit()** is similar to returning from the image's **EFI\_IMAGE\_ENTRY\_POINT** except that **Exit()** may also return additional *ExitData*. **Exit()** function description defines clean up procedure performed by the firmware once loaded image returns control.

### EFI 1.10 Extension

To maintain compatibility with UEFI drivers that are written to the *EFI 1.02 Specification*, **StartImage()** must monitor the handle database before and after each image is started. If any handles are created or modified when an image is started, then [EFI\\_BOOT\\_SERVICES.ConnectController\(\)](#) must be called with the *Recursive* parameter

set to **TRUE** for each of the newly created or modified handles before **StartImage()** returns.

### Status Codes Returned

EFI_INVALID_PARAMETER	<i>ImageHandle</i> is either an invalid image handle or the image has already been initialized with StartImage
Exit code from image	Exit code from image.
EFI_SECURITY_VIOLATION	The current platform policy specifies that the image should not be started.

## EFI\_BOOT\_SERVICES.UnloadImage()

### Summary

Unloads an image.

### Prototype

```
typedef
EFI_STATUS
(EFIAPI *EFI_IMAGE_UNLOAD) (
    IN EFI_HANDLE ImageHandle
);
```

### Parameters

*ImageHandle* Handle that identifies the image to be unloaded.

### Description

The **UnloadImage()** function unloads a previously loaded image.

There are three possible scenarios. If the image has not been started, the function unloads the image and returns **EFI\_SUCCESS**.

If the image has been started and has an **Unload()** entry point, control is passed to that entry point. If the image's unload function returns **EFI\_SUCCESS**, the image is unloaded; otherwise, the error returned by the image's unload function is returned to the caller. The image unload function is responsible for freeing all allocated memory and ensuring that there are no references to any freed memory, or to the image itself, before returning **EFI\_SUCCESS**.

If the image has been started and does not have an **Unload()** entry point, the function returns **EFI\_UNSUPPORTED**.

### EFI 1.10 Extension

All of the protocols that were opened by *ImageHandle* using the boot service [EFI\\_BOOT\\_SERVICES.OpenProtocol\(\)](#) are automatically closed with the boot service [EFI\\_BOOT\\_SERVICES.CloseProtocol\(\)](#). If all of the open protocols are closed, then **EFI\_SUCCESS** is returned. If any call to **CloseProtocol()** fails, then the error code from **CloseProtocol()** is returned.

## Status Codes Returned

EFI_SUCCESS	The image has been unloaded.
EFI_UNSUPPORTED	The image has been started, and does not support unload.
EFI_INVALID_PARAMETER	<i>ImageHandle</i> is not a valid image handle.
Exit code from Unload handler	Exit code from the image's unload function.

## EFI\_IMAGE\_ENTRY\_POINT

### Summary

This is the declaration of an EFI image entry point. This can be the entry point to an application written to this specification, an EFI boot service driver, or an EFI runtime driver.

### Prototype

```
typedef
EFI_STATUS
(EFI_API *EFI_IMAGE_ENTRY_POINT) (
    IN EFI_HANDLE    ImageHandle,
    IN EFI_SYSTEM_TABLE *SystemTable
);
```

### Parameters

*ImageHandle*

Handle that identifies the loaded image. Type **EFI\_HANDLE** is defined in the [EFI\\_BOOT\\_SERVICES.InstallProtocolInterface\(\)](#) function description.

*SystemTable*

System Table for this image. Type **EFI\_SYSTEM\_TABLE** is defined in [Section 4](#).

### Description

An image's entry point is of type **EFI\_IMAGE\_ENTRY\_POINT**. After firmware loads an image into memory, control is passed to the image's entry point. The entry point is responsible for initializing the image. The image's *ImageHandle* is passed to the image. The *ImageHandle* provides the image with all the binding and data information it needs. This information is available through protocol interfaces. However, to access the protocol interfaces on *ImageHandle* requires access to boot services functions. Therefore, [EFI\\_BOOT\\_SERVICES.LoadImage\(\)](#) passes to the **EFI\_IMAGE\_ENTRY\_POINT** a *SystemTable* that is inherited from the current scope of [LoadImage\(\)](#).

All image handles support the [EFI\\_LOADED\\_IMAGE\\_PROTOCOL](#) and the [EFI\\_LOADED\\_IMAGE\\_DEVICE\\_PATH\\_PROTOCOL](#). These protocols can be used to obtain information about the loaded image's state—for example, the device from which the image was loaded and the image's load options. In addition, the *ImageHandle* may support other protocols provided by the parent image.

If the image supports dynamic unloading, it must supply an unload function in the **EFI\_LOADED\_IMAGE\_PROTOCOL** structure before returning control from its entry point.

In general, an image returns control from its initialization entry point by calling [EFI\\_BOOT\\_SERVICES.Exit\(\)](#) or by returning control from its entry point. If the image returns control from its entry point, the firmware passes control to **Exit()** using the return code as the *ExitStatus* parameter to **Exit()**.

See **Exit()** below for entry point exit conditions.

## EFI\_BOOT\_SERVICES.Exit()

### Summary

Terminates a loaded EFI image and returns control to boot services.

### Prototype

```
typedef
EFI_STATUS
(EFIAPI *EFI_EXIT) (
    IN EFI_HANDLE ImageHandle,
    IN EFI_STATUS ExitStatus,
    IN UINTN ExitDataSize,
    IN CHAR16 *ExitData OPTIONAL
);
```

### Parameters

<i>ImageHandle</i>	Handle that identifies the image. This parameter is passed to the image on entry.
<i>ExitStatus</i>	The image's exit code.
<i>ExitDataSize</i>	The size, in bytes, of <i>ExitData</i> . Ignored if <i>ExitStatus</i> is <b>EFI_SUCCESS</b> .
<i>ExitData</i>	Pointer to a data buffer that includes a Null-terminated string, optionally followed by additional binary data. The string is a description that the caller may use to further indicate the reason for the image's exit. <i>ExitData</i> is only valid if <i>ExitStatus</i> is something other than <b>EFI_SUCCESS</b> . The <i>ExitData</i> buffer must be allocated by calling <a href="#">EFI_BOOT_SERVICES.AllocatePool()</a> .

### Description

The **Exit()** function terminates the image referenced by *ImageHandle* and returns control to boot services. This function may not be called if the image has already returned from its entry point ([EFI\\_IMAGE\\_ENTRY\\_POINT](#)) or if it has loaded any child images that have not exited (all child images must exit before this image can exit).

Using **Exit()** is similar to returning from the image's **EFI\_IMAGE\_ENTRY\_POINT** except that **Exit()** may also return additional *ExitData*.

When an application exits a compliant system, firmware frees the memory used to hold the image. The firmware also frees its references to the *ImageHandle* and the handle itself. Before exiting, the application is responsible for freeing any resources it allocated. This includes memory (pages and/or pool), open file system handles, and so forth. The only exception to this rule is the *ExitData* buffer, which must be freed by the caller of [EFI\\_BOOT\\_SERVICES.StartImage\(\)](#). (If the buffer is needed, firmware must allocate it by calling [EFI\\_BOOT\\_SERVICES.AllocatePool\(\)](#) and must return a pointer to it to the caller of **StartImage()**.)

When an EFI boot service driver or runtime service driver exits, firmware frees the image only if the *ExitStatus* is an error code; otherwise the image stays resident in memory. The driver must not return an error code if it has installed any protocol handlers or other active callbacks into the system that have not (or cannot) be cleaned up. If the driver exits with an error code, it is responsible for freeing all resources before exiting. This includes any allocated memory (pages and/or pool), open file system handles, and so forth.

It is valid to call **Exit()** or **UnloadImage()** for an image that was loaded by [EFI\\_BOOT\\_SERVICES.LoadImage\(\)](#) before calling [EFI\\_BOOT\\_SERVICES.StartImage\(\)](#). This will free the image from memory without having started it.

### EFI 1.10 Extension

If *ImageHandle* is a UEFI application, then all of the protocols that were opened by *ImageHandle* using the boot service [EFI\\_BOOT\\_SERVICES.OpenProtocol\(\)](#) are automatically closed with the boot service [EFI\\_BOOT\\_SERVICES.CloseProtocol\(\)](#). If *ImageHandle* is a UEFI boot service driver or UEFI runtime service driver, and *ExitStatus* is an error code, then all of the protocols that were opened by *ImageHandle* using the boot service **OpenProtocol()** are automatically closed with the boot service **CloseProtocol()**. If *ImageHandle* is a UEFI boot service driver or UEFI runtime service driver, and *ExitStatus* is not an error code, then no protocols are automatically closed by this service.

### Status Codes Returned

(Does not return.)	Image exit. Control is returned to the <b>StartImage()</b> call that invoked the image specified by <i>ImageHandle</i> .
EFI_SUCCESS	The image specified by <i>ImageHandle</i> was unloaded. This condition only occurs for images that have been loaded with <b>LoadImage()</b> but have not been started with <b>StartImage()</b> .
EFI_INVALID_PARAMETER	The image specified by <i>ImageHandle</i> has been loaded and started with <b>LoadImage()</b> and <b>StartImage()</b> , but the image is not the currently executing image.



## EFI\_BOOT\_SERVICES.ExitBootServices()

### Summary

Terminates all boot services.

### Prototype

```
typedef
EFI_STATUS
(EFI_API *EFI_EXIT_BOOT_SERVICES) (
    IN EFI_HANDLE    ImageHandle,
    IN UINTN         MapKey
);
```

### Parameters

<i>ImageHandle</i>	Handle that identifies the exiting image. Type <b>EFI_HANDLE</b> is defined in the <a href="#">EFI_BOOT_SERVICES.InstallProtocolInterface()</a> function description.
<i>MapKey</i>	Key to the latest memory map.

### Description

The **ExitBootServices()** function is called by the currently executing UEFI OS loader image to terminate all boot services. On success, the UEFI OS loader becomes responsible for the continued operation of the system. All events of type **EVT\_SIGNAL\_EXIT\_BOOT\_SERVICES** must be signaled before **ExitBootServices()** returns **EFI\_SUCCESS**. The events are only signaled once even if **ExitBootServices()** is called multiple times.

A UEFI OS loader must ensure that it has the system's current memory map at the time it calls **ExitBootServices()**. This is done by passing in the current memory map's *MapKey* value as returned by [EFI\\_BOOT\\_SERVICES.GetMemoryMap\(\)](#). Care must be taken to ensure that the memory map does not change between these two calls. It is suggested that **GetMemoryMap()** be called immediately before calling **ExitBootServices()**. If *MapKey* value is incorrect, **ExitBootServices()** returns **EFI\_INVALID\_PARAMETER** and **GetMemoryMap()** with **ExitBootServices()** must be called again. Firmware implementation may choose to do a partial shutdown of the boot services during the first call to **ExitBootServices()**. A UEFI OS loader should not make calls to any boot service function other than **GetMemoryMap()** after the first call to **ExitBootServices()**.

On success, the UEFI OS loader owns all available memory in the system. In addition, the UEFI OS loader can treat all memory in the map marked as **EfiBootServicesCode** and **EfiBootServicesData** as available free memory. No further calls to boot service functions or EFI device-handle-based protocols may be used, and the boot services watchdog timer is disabled. On success, several fields of the EFI System Table should be set to **NULL**. These include *ConsoleInHandle*, *ConIn*, *ConsoleOutHandle*, *ConOut*, *StandardErrorHandle*, *StdErr*, and *BootServicesTable*. In addition, since fields of the EFI

System Table are being modified, the 32-bit CRC for the EFI System Table must be recomputed.

Firmware must ensure that timer event activity is stopped before any of the **EXIT\_BOOT\_SERVICES** handlers are called within UEFI drivers. UEFI Drivers must not rely on timer event functionality in order to accomplish ExitBootServices handling since timer events will be disabled.

## Status Codes Returned

EFI_SUCCESS	Boot services have been terminated.
EFI_INVALID_PARAMETER	<i>MapKey</i> is incorrect.

## 7.5 Miscellaneous Boot Services

This section contains the remaining function definitions for boot services not defined elsewhere but which are required to complete the definition of the EFI environment.

[Table 30](#) lists the Miscellaneous Boot Services Functions.

**Table 30. Miscellaneous Boot Services Functions**

Name	Type	Description
SetWatchDogTimer	Boot	Resets and sets a watchdog timer used during boot services time.
Stall	Boot	Stalls the processor.
CopyMem	Boot	Copies the contents of one buffer to another buffer.
SetMem	Boot	Fills a buffer with a specified value.
GetNextMonotonicCount	Boot	Returns a monotonically increasing count for the platform.
InstallConfigurationTable	Boot	Adds, updates, or removes a configuration table from the EFI System Table.
CalculateCrc32	Boot	Computes and returns a 32-bit CRC for a data buffer.

The [EFI\\_BOOT\\_SERVICES.CalculateCrc32\(\)](#) service was added because there are several places in EFI that 32-bit CRCs are used. These include the EFI System Table, the EFI Boot Services Table, the EFI Runtime Services Table, and the GUID Partition Table (GPT) structures. The **CalculateCrc32()** service allows new 32-bit CRCs to be computed, and existing 32-bit CRCs to be validated.

## EFI\_BOOT\_SERVICES.SetWatchdogTimer()

### Summary

Sets the system's watchdog timer.

### Prototype

```
typedef
EFI_STATUS
(EFI_API *EFI_SET_WATCHDOG_TIMER) ((
  IN UINTN      Timeout,
  IN UINT64     WatchdogCode,
  IN UINTN      DataSize,
  IN CHAR16     *WatchdogData OPTIONAL
  );
```

### Parameters

<i>Timeout</i>	The number of seconds to set the watchdog timer to. A value of zero disables the timer.
<i>WatchdogCode</i>	The numeric code to log on a watchdog timer timeout event. The firmware reserves codes 0x0000 to 0xFFFF. Loaders and operating systems may use other timeout codes.
<i>DataSize</i>	The size, in bytes, of <i>WatchdogData</i> .
<i>WatchdogData</i>	A data buffer that includes a Null-terminated string, optionally followed by additional binary data. The string is a description that the call may use to further indicate the reason to be logged with a watchdog event.

### Description

The **SetWatchdogTimer()** function sets the system's watchdog timer.

If the watchdog timer expires, the event is logged by the firmware. The system may then either reset with the Runtime Service [ResetSystem\(\)](#), or perform a platform specific action that must eventually cause the platform to be reset. The watchdog timer is armed before the firmware's boot manager invokes an EFI boot option. The watchdog must be set to a period of 5 minutes. The EFI Image may reset or disable the watchdog timer as needed. If control is returned to the firmware's boot manager, the watchdog timer must be disabled.

The watchdog timer is only used during boot services. On successful completion of [EFI\\_BOOT\\_SERVICES.ExitBootServices\(\)](#) the watchdog timer is disabled.

The accuracy of the watchdog timer is +/- 1 second from the requested *Timeout*.

### Status Codes Returned

EFI_SUCCESS	The timeout has been set.
-------------	---------------------------

EFI_INVALID_PARAMETER	The supplied <i>WatchdogCode</i> is invalid.
EFI_UNSUPPORTED	The system does not have a watchdog timer.
EFI_DEVICE_ERROR	The watch dog timer could not be programmed due to a hardware error.

## EFI\_BOOT\_SERVICES.Stall()

### Summary

Induces a fine-grained stall.

### Prototype

```
typedef
EFI_STATUS
(EFI_API *EFI_STALL) (
  IN UINTN Microseconds
)
```

### Parameters

*Microseconds*

The number of microseconds to stall execution.

### Description

The **Stall()** function stalls execution on the processor for at least the requested number of microseconds. Execution of the processor is *not* yielded for the duration of the stall.

### Status Codes Returned

EFI_SUCCESS	Execution was stalled at least the requested number of <i>Microseconds</i> .
-------------	--

## EFI\_BOOT\_SERVICES.CopyMem()

### Summary

The **CopyMem()** function copies the contents of one buffer to another buffer.

### Prototype

```
typedef
VOID
(EFI_API *EFI_COPY_MEM) (
    IN VOID *Destination,
    IN VOID *Source,
    IN UINTN Length
);
```

### Parameters

<i>Destination</i>	Pointer to the destination buffer of the memory copy.
<i>Source</i>	Pointer to the source buffer of the memory copy.
<i>Length</i>	Number of bytes to copy from <i>Source</i> to <i>Destination</i> .

### Description

The **CopyMem()** function copies *Length* bytes from the buffer *Source* to the buffer *Destination*.

The implementation of **CopyMem()** must be reentrant, and it must handle overlapping *Source* and *Destination* buffers. This means that the implementation of **CopyMem()** must choose the correct direction of the copy operation based on the type of overlap that exists between the *Source* and *Destination* buffers. If either the *Source* buffer or the *Destination* buffer crosses the top of the processor's address space, then the result of the copy operation is unpredictable.

The contents of the *Destination* buffer on exit from this service must match the contents of the *Source* buffer on entry to this service. Due to potential overlaps, the contents of the *Source* buffer may be modified by this service. The following rules can be used to guarantee the correct behavior:

1. If *Destination* and *Source* are identical, then no operation should be performed.
2. If  $Destination > Source$  and  $Destination < (Source + Length)$ , then the data should be copied from the *Source* buffer to the *Destination* buffer starting from the end of the buffers and working toward the beginning of the buffers.
3. Otherwise, the data should be copied from the *Source* buffer to the *Destination* buffer starting from the beginning of the buffers and working toward the end of the buffers.

### Status Codes Returned

None.

## EFI\_BOOT\_SERVICES.SetMem()

### Summary

The **SetMem()** function fills a buffer with a specified value.

### Prototype

```
typedef
VOID
EFI_API *EFI_SET_MEM) (
  IN VOID *Buffer,
  IN UINTN Size,
  IN UINT8 Value
);
```

### Parameters

<i>Buffer</i>	Pointer to the buffer to fill.
<i>Size</i>	Number of bytes in <i>Buffer</i> to fill.
<i>Value</i>	Value to fill <i>Buffer</i> with.

### Description

This function fills *Size* bytes of *Buffer* with *Value*. The implementation of **SetMem()** must be reentrant. If *Buffer* crosses the top of the processor's address space, the result of the **SetMem()** operation is unpredictable.

### Status Codes Returned

None.

## EFI\_BOOT\_SERVICES.GetNextMonotonicCount()

### Summary

Returns a monotonically increasing count for the platform.

### Prototype

```
typedef
EFI_STATUS
(EFIAPI *EFI_GET_NEXT_MONOTONIC_COUNT) (
    OUT UINT64 *Count
);
```

### Parameters

*Count* Pointer to returned value.

### Description

The **GetNextMonotonicCount()** function returns a 64-bit value that is numerically larger than the last time the function was called.

The platform's monotonic counter is comprised of two parts: the high 32 bits and the low 32 bits. The low 32-bit value is volatile and is reset to zero on every system reset. It is increased by 1 on every call to **GetNextMonotonicCount()**. The high 32-bit value is nonvolatile and is increased by one on whenever the system resets or the low 32-bit counter overflows.

### Status Codes Returned

EFI_SUCCESS	The next monotonic count was returned.
EFI_DEVICE_ERROR	The device is not functioning properly.
EFI_INVALID_PARAMETER	<i>Count</i> is <b>NULL</b> .



## EFI\_BOOT\_SERVICES.InstallConfigurationTable()

### Summary

Adds, updates, or removes a configuration table entry from the EFI System Table.

### Prototype

```
typedef
EFI_STATUS
(EFIAPI *EFI_INSTALL_CONFIGURATION_TABLE) (
    IN EFI_GUID  *Guid,
    IN VOID     *Table
);
```

### Parameters

*Guid*

A pointer to the GUID for the entry to add, update, or remove.

*Table*

A pointer to the configuration table for the entry to add, update, or remove. May be **NULL**.

### Description

The **InstallConfigurationTable()** function is used to maintain the list of configuration tables that are stored in the EFI System Table. The list is stored as an array of (GUID, Pointer) pairs. The list must be allocated from pool memory with *PoolType* set to **EfiRuntimeServicesData**.

If *Guid* is **NULL**, **EFI\_INVALID\_PARAMETER** is returned. If *Guid* is valid, there are four possibilities:

- If *Guid* is not present in the System Table, and *Table* is not **NULL**, then the (*Guid*, *Table*) pair is added to the System Table. See Note below.
- If *Guid* is not present in the System Table, and *Table* is **NULL**, then **EFI\_NOT\_FOUND** is returned.
- If *Guid* is present in the System Table, and *Table* is not **NULL**, then the (*Guid*, *Table*) pair is updated with the new *Table* value.
- If *Guid* is present in the System Table, and *Table* is **NULL**, then the entry associated with *Guid* is removed from the System Table.

If an add, modify, or remove operation is completed, then **EFI\_SUCCESS** is returned.

**Note:** *If there is not enough memory to perform an add operation, then **EFI\_OUT\_OF\_RESOURCES** is returned.*

### Status Codes Returned

EFI_SUCCESS	The ( <i>Guid</i> , <i>Table</i> ) pair was added, updated, or removed.
EFI_INVALID_PARAMETER	<i>Guid</i> is <b>NULL</b> .
EFI_NOT_FOUND	An attempt was made to delete a nonexistent entry.

EFI_OUT_OF_RESOURCES	There is not enough memory available to complete the operation.
----------------------	---

## EFI\_BOOT\_SERVICES.CalculateCrc32()

### Summary

Computes and returns a 32-bit CRC for a data buffer.

### Prototype

```
typedef
EFI_STATUS
(EFIAPI *EFI_CALCULATE_CRC32)
IN VOID *Data,
IN UINTN DataSize,
OUT UINT32 *Crc32
);
```

### Parameters

<i>Data</i>	A pointer to the buffer on which the 32-bit CRC is to be computed.
<i>DataSize</i>	The number of bytes in the buffer <i>Data</i> .
<i>Crc32</i>	The 32-bit CRC that was computed for the data buffer specified by <i>Data</i> and <i>DataSize</i> .

### Description

This function computes the 32-bit CRC for the data buffer specified by *Data* and *DataSize*. If the 32-bit CRC is computed, then it is returned in *Crc32* and **EFI\_SUCCESS** is returned.

If *Data* is **NULL**, then **EFI\_INVALID\_PARAMETER** is returned.

If *Crc32* is **NULL**, then **EFI\_INVALID\_PARAMETER** is returned.

If *DataSize* is 0, then **EFI\_INVALID\_PARAMETER** is returned.

### Status Codes Returned

EFI_SUCCESS	The 32-bit CRC was computed for the data buffer and returned in <i>Crc32</i> .
EFI_INVALID_PARAMETER	<i>Data</i> is <b>NULL</b> .
EFI_INVALID_PARAMETER	<i>Crc32</i> is <b>NULL</b> .
EFI_INVALID_PARAMETER	<i>DataSize</i> is 0.



## 8 Services — Runtime Services

---

This section discusses the fundamental services that are present in a compliant system. The services are defined by interface functions that may be used by code running in the EFI environment. Such code may include protocols that manage device access or extend platform capability, as well as applications running in the preboot environment and EFI OS loaders.

Two types of services are described here:

- **Boot Services.** Functions that are available *before* a successful call to [EFI\\_BOOT\\_SERVICES.ExitBootServices\(\)](#). These functions are described in [Section 7](#).
- **Runtime Services.** Functions that are available *before and after* any call to [ExitBootServices\(\)](#). These functions are described in this section.

During boot, system resources are owned by the firmware and are controlled through boot services interface functions. These functions can be characterized as “global” or “handle-based.” The term “global” simply means that a function accesses system services and is available on all platforms (since all platforms support all system services). The term “handle-based” means that the function accesses a specific device or device functionality and may not be available on some platforms (since some devices are not available on some platforms). Protocols are created dynamically. This section discusses the “global” functions and runtime functions; subsequent sections discuss the “handle-based.”

UEFI applications (including UEFI OS loaders) must use boot services functions to access devices and allocate memory. On entry, an image is provided a pointer to a system table which contains the Boot Services dispatch table and the default handles for accessing the console. All boot services functionality is available until a UEFI OS loader loads enough of its own environment to take control of the system's continued operation and then terminates boot services with a call to [ExitBootServices\(\)](#).

In principle, the [ExitBootServices\(\)](#) call is intended for use by the operating system to indicate that its loader is ready to assume control of the platform and all platform resource management. Thus boot services are available up to this point to assist the UEFI OS loader in preparing to boot the operating system. Once the UEFI OS loader takes control of the system and completes the operating system boot process, only runtime services may be called. Code other than the UEFI OS loader, however, may or may not choose to call [ExitBootServices\(\)](#). This choice may in part depend upon whether or not such code is designed to make continued use of EFI boot services or the boot services environment.

The rest of this section discusses individual functions. Runtime Services fall into these categories:

- Runtime Rules and Restrictions ([Section 8.1](#))
- Variable Services ([Section 8.2](#))
- Time Services ([Section 8.3](#))
- Virtual Memory Services ([Section 8.4](#))

- Miscellaneous Services ([Section 8.5](#))

## 8.1 Runtime Services Rules and Restrictions

All of the Runtime Services may be called with interrupts enabled if desired. The Runtime Service functions will internally disable interrupts when it is required to protect access to hardware resources. The interrupt enable control bit will be returned to its entry state after the access to the critical hardware resources is complete.

All callers of Runtime Services are restricted from calling the same or certain other Runtime Service functions prior to the completion and return of a previous Runtime Service call. These restrictions apply to:

- Runtime Services that have been interrupted
- Runtime Services that are active on another processor.

Callers are prohibited from using certain other services from another processor or on the same processor following an interrupt as specified in [Table 31](#). For this table 'Busy' is defined as the state when a Runtime Service has been entered and has not returned to the caller.

The consequence of a caller violating these restrictions is undefined except for certain special cases described below.

**Table 31. Rules for Reentry Into Runtime Services**

If previous call is busy in	Forbidden to call
Any	SetVirtualAddressMap()
ConvertPointer()	ConvertPointer()
SetVariable(), UpdateCapsule(), SetTime(), SetWakeupTime(), GetNextHighMonotonicCount()	ResetSystem()
GetVariable(), GetNextVariableName(), SetVariable(), QueryVariableInfo(), UpdateCapsule(), QueryCapsuleCapabilities(), GetNextHighMonotonicCount()	GetVariable(), GetNextVariableName(), SetVariable(), QueryVariableInfo(), UpdateCapsule(), QueryCapsuleCapabilities(), GetNextHighMonotonicCount()
GetTime(), SetTime(), GetWakeupTime(), SetWakeupTime()	GetTime(), SetTime(), GetWakeupTime(), SetWakeupTime()

### 8.1.1 Exception for Machine Check, INIT, and NMI

Certain asynchronous events (e.g., NMI on IA-32 and x64 systems, Machine Check and INIT on Itanium systems) can not be masked and may occur with any setting of interrupt enabled. These events also may require OS level handler's involvement that may involve the invocation of some of the runtime services (see below).

If **SetVirtualAddressMap()** has been called, all calls to runtime services after Machine Check, INIT, or NMI, must be made using the virtual address map set by that call.

A Machine Check may have interrupted a runtime service (see below). If the OS determines that the Machine Check is recoverable, the OS level handler must follow the normal restrictions in [Table 31](#).

If the OS determines that the Machine Check is non-recoverable, the OS level handler may ignore the normal restrictions and may invoke the runtime services described in [Table 32](#) even in the case where a previous call was busy. The system firmware will honor the new runtime service call(s) and the operation of the previous interrupted call is not guaranteed. Any interrupted runtime functions will not be restarted.

The INIT and NMI events follow the same restrictions.

**Note:** *On Itanium systems, the OS Machine Check Handler must not call ResetSystem(). If a reset is required, the OS Machine Check Handler may request SAL to reset upon return to SAL\_CHECK.*

The platform implementations are required to clear any runtime services in progress in order to enable the OS handler to invoke these runtime services even in the case where a

previous call was busy. In this case, the proper operation of the original interrupted call is not guaranteed.

**Table 32. Functions that may be called after Machine Check ,INIT and NMI**

Function	Called after Machine Check, INIT and NMI
GetTime()	Yes, even if previously busy
GetVariable()	Yes, even if previously busy
GetNextVariableName()	Yes, even if previously busy
QueryVariableInfo()	Yes, even if previously busy
SetVariable()	Yes, even if previously busy
UpdateCapsule()	Yes, even if previously busy
QueryCapsuleCapabilities()	Yes, even if previously busy
ResetSystem()	Yes, even if previously busy

## 8.2 Variable Services

Variables are defined as key/value pairs that consist of identifying information plus attributes (the key) and arbitrary data (the value). Variables are intended for use as a means to store data that is passed between the EFI environment implemented in the platform and EFI OS loaders and other applications that run in the EFI environment.

Although the implementation of variable storage is not defined in this specification, variables must be persistent in most cases. This implies that the EFI implementation on a platform must arrange it so that variables passed in for storage are retained and available for use each time the system boots, at least until they are explicitly deleted or overwritten. Provision of this type of nonvolatile storage may be very limited on some platforms, so variables should be used sparingly in cases where other means of communicating information cannot be used.

[Table 33](#) lists the variable services functions described in this section:

**Table 33. Variable Services Functions**

Name	Type	Description
GetVariable	Runtime	Returns the value of a variable.
GetNextVariableName	Runtime	Enumerates the current variable names.
SetVariable	Runtime	Sets the value of a variable.
QueryVariableInfo	Runtime	Returns information about the EFI variables



## GetVariable()

### Summary

Returns the value of a variable.

### Prototype

```
typedef
EFI_STATUS
GetVariable (
  IN CHAR16          *VariableName,
  IN EFI_GUID       *VendorGuid,
  OUT UINT32        *Attributes OPTIONAL,
  IN OUT UINTN     *DataSize,
  OUT VOID          *Data OPTIONAL
);
```

### Parameters

<i>VariableName</i>	A Null-terminated string that is the name of the vendor's variable.
<i>VendorGuid</i>	A unique identifier for the vendor. Type <b>EFI_GUID</b> is defined in the <a href="#">EFI_BOOT_SERVICES.InstallProtocolInterface()</a> function description.
<i>Attributes</i>	If not <b>NULL</b> , a pointer to the memory location to return the attributes bitmask for the variable. See "Related Definitions."
<i>DataSize</i>	On input, the size in bytes of the return <i>Data</i> buffer. On output the size of data returned in <i>Data</i> .
<i>Data</i>	The buffer to return the contents of the variable. May be <b>NULL</b> with a zero <i>DataSize</i> in order to determine the size buffer needed.

## Related Definitions

```

//*****
// Variable Attributes
//*****
#define EFI_VARIABLE_NON_VOLATILE    0x00000001
#define EFI_VARIABLE_BOOTSERVICE_ACCESS  0x00000002
#define EFI_VARIABLE_RUNTIME_ACCESS    0x00000004
#define EFI_VARIABLE_HARDWARE_ERROR_RECORD 0x00000008 \
//This attribute is identified by the mnemonic 'HR' elsewhere
//in this specification.
#define EFI_VARIABLE_AUTHENTICATED_WRITE_ACCESS 0x00000010
//NOTE: EFI_VARIABLE_AUTHENTICATED_WRITE_ACCESS is deprecated
//and should be considered reserved.
#define EFI_VARIABLE_TIME_BASED_AUTHENTICATED_WRITE_ACCESS \
0x00000020
#define EFI_VARIABLE_APPEND_WRITE    0x00000040
#define EFI_VARIABLE_ENHANCED_AUTHENTICATED_ACCESS 0x00000080
//This attribute indicates that the variable payload begins
//with an EFI_VARIABLE_AUTHENTICATION_3 structure, and
//potentially more structures as indicated by fields of this
//structure. See definition below and in SetVariable().

```

## Description

Each vendor may create and manage its own variables without the risk of name conflicts by using a unique *VendorGuid*. When a variable is set its *Attributes* are supplied to indicate how the data variable should be stored and maintained by the system. The attributes affect when the variable may be accessed and volatility of the data. If **EFI\_BOOT\_SERVICES.ExitBootServices()** has already been executed, data variables without the **EFI\_VARIABLE\_RUNTIME\_ACCESS** attribute set will not be visible to **GetVariable()** and will return an **EFI\_NOT\_FOUND** error.

If the *Data* buffer is too small to hold the contents of the variable, the error **EFI\_BUFFER\_TOO\_SMALL** is returned and *DataSize* is set to the required buffer size to obtain the data.

The **EFI\_VARIABLE\_TIME\_BASED\_AUTHENTICATED\_WRITE\_ACCESS** and the **EFI\_VARIABLE\_AUTHENTICATED\_WRITE\_ACCESS** attributes may both be set in the returned *Attributes* bitmask parameter of a **GetVariable()** call, though it should be noted that the **EFI\_VARIABLE\_AUTHENTICATED\_WRITE\_ACCESS** attribute is deprecated and should no longer be used. The **EFI\_VARIABLE\_APPEND\_WRITE** attribute will never be set in the returned *Attributes* bitmask parameter.

Variables stored with the **EFI\_VARIABLE\_ENHANCED\_AUTHENTICATED\_ACCESS** attribute set will return metadata in addition to variable data when **GetVariable()** is called. If a **GetVariable()** call indicates that this attribute is set, the **GetVariable()** payload must be interpreted according to the metadata headers. In addition to the headers described in **SetVariable()**, the following header is used to indicate what certificate may be currently associated with a variable.

```
//  
// EFI_VARIABLE_AUTHENTICATION_3_CERT_ID descriptor  
//  
// An extensible structure to identify a unique x509 cert  
// associated with a given variable  
//  
#define EFI_VARIABLE_AUTHENTICATION_3_CERT_ID_SHA256 1  
  
typedef struct {  
    UINT8    Type;  
    UINT32   IdSize;  
    // UINT8   Id[IdSize];  
} EFI_VARIABLE_AUTHENTICATION_3_CERT_ID;
```

*Type*

Identifies the type of ID that is returned and how the ID should be interpreted.

*IdSize*

Indicates the size of the Id buffer that follows this field in the structure.

*Id (Not a formal structure member)*

This is a unique identifier for the associated certificate as defined by the Type field. For CERT\_ID\_SHA256, the buffer will be a SHA-256 digest of the tbsCertificate (To Be Signed Certificate data defined in x509) data for the cert.

When the attribute **EFI\_VARIABLE\_ENHANCED\_AUTHENTICATED\_ACCESS** is set, the Data buffer shall be interpreted as follows:

// NOTE: “||” indicates concatenation.

// Example: **EFI\_VARIABLE\_AUTHENTICATION\_3\_TIMESTAMP\_TYPE**

```
EFI_VARIABLE_AUTHENTICATION_3 || EFI_TIME ||
EFI_VARIABLE_AUTHENTICATION_3_CERT_ID || Data
```

// Example: **EFI\_VARIABLE\_AUTHENTICATION\_3\_NONCE\_TYPE**

```
EFI_VARIABLE_AUTHENTICATION_3 || EFI_VARIABLE_AUTHENTICATION_3_NONCE ||
EFI_VARIABLE_AUTHENTICATION_3_CERT_ID || Data
```

NOTE: The MetadataSize field of the **EFI\_VARIABLE\_AUTHENTICATION\_3** structure in each of these examples does not include any **WIN\_CERTIFICATE\_UEFI\_GUID** structures. These structures are used in the SetVariable() interface, not GetVariable(), as described in the above examples.

### Status Codes Returned

EFI_SUCCESS	The function completed successfully.
EFI_NOT_FOUND	The variable was not found.
EFI_BUFFER_TOO_SMALL	The <i>DataSize</i> is too small for the result. <i>DataSize</i> has been updated with the size needed to complete the request.
EFI_INVALID_PARAMETER	<i>VariableName</i> is <b>NULL</b> .
EFI_INVALID_PARAMETER	<i>VendorGuid</i> is <b>NULL</b> .
EFI_INVALID_PARAMETER	<i>DataSize</i> is <b>NULL</b> .
EFI_INVALID_PARAMETER	The <i>DataSize</i> is not too small and <i>Data</i> is <b>NULL</b> .
EFI_DEVICE_ERROR	The variable could not be retrieved due to a hardware error.
EFI_SECURITY_VIOLATION	The variable could not be retrieved due to an authentication failure.

## GetNextVariableName()

### Summary

Enumerates the current variable names.

### Prototype

```
typedef
EFI_STATUS
GetNextVariableName (
  IN OUT UINTN   *VariableNameSize,
  IN OUT CHAR16 *VariableName,
  IN OUT EFI_GUID *VendorGuid
);
```

### Parameters

<i>VariableNameSize</i>	The size of the <i>VariableName</i> buffer. The size must be large enough to fit input string supplied in VariableName buffer.
<i>VariableName</i>	On input, supplies the last <i>VariableName</i> that was returned by <b>GetNextVariableName()</b> . On output, returns the Null-terminated string of the current variable.
<i>VendorGuid</i>	On input, supplies the last <i>VendorGuid</i> that was returned by <b>GetNextVariableName()</b> . On output, returns the <i>VendorGuid</i> of the current variable. Type <b>EFI_GUID</b> is defined in the <a href="#">EFI_BOOT_SERVICES.InstallProtocolInterface()</a> function description.

### Description

**GetNextVariableName()** is called multiple times to retrieve the *VariableName* and *VendorGuid* of all variables currently available in the system. On each call to **GetNextVariableName()** the previous results are passed into the interface, and on output the interface returns the next variable name data. When the entire variable list has been returned, the error **EFI\_NOT\_FOUND** is returned.

Note that if **EFI\_BUFFER\_TOO\_SMALL** is returned, the *VariableName* buffer was too small for the next variable. When such an error occurs, the *VariableNameSize* is updated to reflect the size of buffer needed. In all cases when calling **GetNextVariableName()** the *VariableNameSize* must not exceed the actual buffer size that was allocated for *VariableName*. The *VariableNameSize* must not be smaller the size of the variable name string passed to **GetNextVariableName()** on input in the *VariableName* buffer.

To start the search, a Null-terminated string is passed in *VariableName*; that is, *VariableName* is a pointer to a Null character. This is always done on the initial call to **GetNextVariableName()**. When *VariableName* is a pointer to a Null character, *VendorGuid* is ignored. **GetNextVariableName()** cannot be used as a filter to return variable names with a specific GUID. Instead, the entire list of variables must be retrieved,

and the caller may act as a filter if it chooses. Calls to [SetVariable\(\)](#) between calls to [GetNextVariableName\(\)](#) may produce unpredictable results. If a *VariableName* buffer on input is not a Null-terminated string, *EFI\_INVALID\_PARAMETER* is returned. If input values of *VariableName* and *VendorGuid* are not a name and GUID of an existing variable, *EFI\_INVALID\_PARAMETER* is returned.

Once [EFI\\_BOOT\\_SERVICES.ExitBootServices\(\)](#) is performed, variables that are only visible during boot services will no longer be returned. To obtain the data contents or attribute for a variable returned by [GetNextVariableName\(\)](#), the [GetVariable\(\)](#) interface is used.

## Status Codes Returned

EFI_SUCCESS	The function completed successfully.
EFI_NOT_FOUND	The next variable was not found.
EFI_BUFFER_TOO_SMALL	The <i>VariableNameSize</i> is too small for the result. <i>VariableNameSize</i> has been updated with the size needed to complete the request.
EFI_INVALID_PARAMETER	<i>VariableNameSize</i> is <b>NULL</b> .
EFI_INVALID_PARAMETER	<i>VariableName</i> is <b>NULL</b> .
EFI_INVALID_PARAMETER	<i>VendorGuid</i> is <b>NULL</b> .
EFI_INVALID_PARAMETER	The input values of <i>VariableName</i> and <i>VendorGuid</i> are not a name and GUID of an existing variable.
EFI_INVALID_PARAMETER	Null-terminator is not found in the first <i>VariableNameSize</i> bytes of the input <i>VariableName</i> buffer.
EFI_DEVICE_ERROR	The variable name could not be retrieved due to a hardware error.

## SetVariable()

### Summary

Sets the value of a variable.

### Prototype

```
typedef
EFI_STATUS
SetVariable (
  IN CHAR16 *VariableName,
  IN EFI_GUID *VendorGuid,
  IN UINT32 Attributes,
  IN UINTN DataSize,
  IN VOID *Data
);
```

### Parameters

<i>VariableName</i>	A Null-terminated string that is the name of the vendor's variable. Each <i>VariableName</i> is unique for each <i>VendorGuid</i> . <i>VariableName</i> must contain 1 or more characters. If <i>VariableName</i> is an empty string, then <b>EFI_INVALID_PARAMETER</b> is returned.
<i>VendorGuid</i>	A unique identifier for the vendor. Type <b>EFI_GUID</b> is defined in the <a href="#">EFI_BOOT_SERVICES.InstallProtocolInterface()</a> function description.
<i>Attributes</i>	Attributes bitmask to set for the variable. Refer to the <a href="#">GetVariable()</a> function description.
<i>DataSize</i>	The size in bytes of the <i>Data</i> buffer. Unless the <b>EFI_VARIABLE_APPEND_WRITE</b> , <b>EFI_VARIABLE_AUTHENTICATED_WRITE_ACCESS</b> , <b>EFI_VARIABLE_ENHANCED_AUTHENTICATED_ACCESS</b> , or <b>EFI_VARIABLE_TIME_BASED_AUTHENTICATED_WRITE_ACCESS</b> attribute is set, a size of zero causes the variable to be deleted. When the <b>EFI_VARIABLE_APPEND_WRITE</b> attribute is set, then a <b>SetVariable()</b> call with a <i>DataSize</i> of zero will not cause any change to the variable value (the timestamp associated with the variable may be updated however, even if no new data value is provided; see the description of the <b>EFI_VARIABLE_AUTHENTICATION_2</b> descriptor below). In this case the <i>DataSize</i> will not be zero since the <b>EFI_VARIABLE_AUTHENTICATION_2</b> descriptor will be populated).
<i>Data</i>	The contents for the variable.

## Related Definitions

```

//*****
// Variable Attributes
//*****

// NOTE: This interface is deprecated and should no longer be used!
//
// EFI_VARIABLE_AUTHENTICATION descriptor
//
// A counter-based authentication method descriptor template
//
typedef struct {
    UINT64      MonotonicCount;
    WIN_CERTIFICATE_UEFI_GUID AuthInfo;
} EFI_VARIABLE_AUTHENTICATION;

```

### *MonotonicCount*

Included in the signature of *AuthInfo*. Used to ensure freshness/no replay. Incremented during each "Write" access.

### *AuthInfo*

Provides the authorization for the variable access. It is a signature across the variable data and the Monotonic Count value. Caller uses Private key that is associated with a public key that has been provisioned via the key exchange.

```

//
// EFI_VARIABLE_AUTHENTICATION_2 descriptor
//
// A time-based authentication method descriptor template
//
typedef struct {
    EFI_TIME      TimeStamp;
    WIN_CERTIFICATE_UEFI_GUID AuthInfo;
} EFI_VARIABLE_AUTHENTICATION_2;

```

### *TimeStamp*

Time associated with the authentication descriptor. For the *TimeStamp* value, components *Pad1*, *Nanosecond*, *TimeZone*, *Daylight* and *Pad2* shall be set to 0. This means that the time shall always be expressed in GMT.

### *AuthInfo*

Provides the authorization for the variable access. Only a *CertType* of **EFI\_CERT\_TYPE\_PKCS7\_GUID** is accepted.



```

//
// EFI_VARIABLE_AUTHENTICATION_3 descriptor
//
// An extensible implementation of the Variable Authentication
// structure.
//
#define EFI_VARIABLE_AUTHENTICATION_3_TIMESTAMP_TYPE 1
#define EFI_VARIABLE_AUTHENTICATION_3_NONCE_TYPE 2

typedef struct {
    UINT8    Version;
    UINT8    Type;
    UINT32   MetadataSize;
    UINT32   Flags;
} EFI_VARIABLE_AUTHENTICATION_3;

```

### *Version*

This field is used in case the **EFI\_VARIABLE\_AUTHENTICATION\_3** structure itself ever requires updating. For now, it is hardcoded to "0x1".

### *Type*

Declares what structure immediately follows this structure in the Variable Data payload. For **EFI\_VARIABLE\_AUTHENTICATION\_3\_TIMESTAMP\_TYPE**, it will be an instance of **EFI\_TIME** (for the TimeStamp). For **EFI\_VARIABLE\_AUTHENTICATION\_3\_NONCE\_TYPE** the structure will be an instance of **EFI\_VARIABLE\_AUTHENTICATION\_3\_NONCE**. This structure is defined below. Note that none of these structures contains a **WIN\_CERTIFICATE\_UEFI\_GUID** structure. See [Section 8.2.1](#) for an explanation of structure sequencing.

### *MetadataSize*

Declares the size of all variable authentication metadata (data related to the authentication of the variable that is not variable data itself), including this header structure, and type-specific structures (eg. **EFI\_VARIABLE\_AUTHENTICATION\_3\_NONCE**), and any **WIN\_CERTIFICATE\_UEFI\_GUID** structures.

### *Flags*

Bitfield indicating any optional configuration for this call. Currently, the only defined value is:

```
#define EFI_VARIABLE_ENHANCED_AUTH_FLAG_UPDATE_CERT 0x00000001
```

The presence of this flag on `SetVariable()` indicates that there are two instances of the **WIN\_CERTIFICATE\_UEFI\_GUID** structure following the type-specific structures. The first instance describes the new cert to be set as the authority for the variable. The second is the signed data to authorize the current updated.

NOTE: All other bits are currently Reserved on `SetVariable()`.

NOTE: All flags are reserved on `GetVariable()`.

```

//
// EFI_VARIABLE_AUTHENTICATION_3_NONCE descriptor
//
// A nonce-based authentication method descriptor template. This
// structure will always be followed by a
// WIN_CERTIFICATE_UEFI_GUID structure.
//
typedef struct {
    UINT32    NonceSize;
    // UINT8    Nonce[NonceSize];
} EFI_VARIABLE_AUTHENTICATION_3_NONCE;

```

#### *NonceSize*

Indicates the size of the Nonce buffer that follows this field in the structure. Must not be 0.

#### *Nonce (Not a formal structure member)*

Unique, random value that guarantees a signed payload cannot be shared between multiple machines or machine families. On `SetVariable()`, if the Nonce field is all 0's, the host machine will try to use an internally generated random number. Will return **EFI\_UNSUPPORTED** if not possible. Also, on `SetVariable()` if the variable already exists and the nonce is identical to the current nonce, will return **EFI\_INVALID\_PARAMETER**.

## Description

Variables are stored by the firmware and may maintain their values across power cycles. Each vendor may create and manage its own variables without the risk of name conflicts by using a unique *VendorGuid*.

Each variable has *Attributes* that define how the firmware stores and maintains the data value. If the **EFI\_VARIABLE\_NON\_VOLATILE** attribute is *not* set, the firmware stores the variable in normal memory and it is not maintained across a power cycle. Such variables are used to pass information from one component to another. An example of this is the firmware's language code support variable. It is created at firmware initialization time for access by EFI components that may need the information, but does not need to be backed up to nonvolatile storage.

**EFI\_VARIABLE\_NON\_VOLATILE** variables are stored in fixed hardware that has a limited storage capacity; sometimes a severely limited capacity. Software should only use a nonvolatile variable when absolutely necessary. In addition, if software uses a nonvolatile variable it should use a variable that is only accessible at boot services time if possible.

A variable must contain one or more bytes of *Data*. Unless the **EFI\_VARIABLE\_APPEND\_WRITE**, **EFI\_VARIABLE\_TIME\_BASED\_AUTHENTICATED\_WRITE\_ACCESS**, or **EFI\_VARIABLE\_ENHANCED\_AUTHENTICATED\_ACCESS** attribute is set (see below), using `SetVariable()` with a *DataSize* of zero will cause the entire variable to be deleted.

The space consumed by the deleted variable may not be available until the next power cycle.

The Attributes have the following usage rules:

- If a preexisting variable is rewritten with different attributes, **SetVariable()** shall not modify the variable and shall return **EFI\_INVALID\_PARAMETER**. The only exception to this is when the only attribute differing is **EFI\_VARIABLE\_APPEND\_WRITE**. In such cases the call's successful outcome or not is determined by the actual value being written. There are two exceptions to this rule:
  - If a preexisting variable is rewritten with no access attributes specified, the variable will be deleted.
  - **EFI\_VARIABLE\_APPEND\_WRITE** attribute presents a special case. It is acceptable to rewrite the variable with or without **EFI\_VARIABLE\_APPEND\_WRITE** attribute.
- Setting a data variable with no access attributes causes it to be deleted.
- **EFI\_VARIABLE\_AUTHENTICATED\_WRITE\_ACCESS** is deprecated and should not be used. Platforms should return **EFI\_UNSUPPORTED** if a caller to *SetVariable()* specifies this attribute.
- Unless the **EFI\_VARIABLE\_APPEND\_WRITE**, **EFI\_VARIABLE\_TIME\_BASED\_AUTHENTICATED\_WRITE\_ACCESS**, or **EFI\_VARIABLE\_ENHANCED\_AUTHENTICATED\_WRITE\_ACCESS** attribute is set, setting a data variable with zero *DataSize* specified, causes it to be deleted.
- Runtime access to a data variable implies boot service access. Attributes that have **EFI\_VARIABLE\_RUNTIME\_ACCESS** set must also have **EFI\_VARIABLE\_BOOTSERVICE\_ACCESS** set. The caller is responsible for following this rule.
- Once [EFI\\_BOOT\\_SERVICES.ExitBootServices\(\)](#) is performed, data variables that did not have **EFI\_VARIABLE\_RUNTIME\_ACCESS** set are no longer visible to [GetVariable\(\)](#).
- Once **ExitBootServices()** is performed, only variables that have **EFI\_VARIABLE\_RUNTIME\_ACCESS** and **EFI\_VARIABLE\_NON\_VOLATILE** set can be set with **SetVariable()**. Variables that have runtime access but that are not nonvolatile are read-only data variables once **ExitBootServices()** is performed. When the **EFI\_VARIABLE\_ENHANCED\_AUTHENTICATED\_ACCESS** attribute is set in a *SetVariable()* call, the authentication shall use the **EFI\_VARIABLE\_AUTHENTICATION\_3** descriptor, which will be followed by any descriptors indicated in the Type and Flags fields.
- When the **EFI\_VARIABLE\_TIME\_BASED\_AUTHENTICATED\_WRITE\_ACCESS** attribute is set in a **SetVariable()** call, the authentication shall use the **EFI\_VARIABLE\_AUTHENTICATION\_2** descriptor.
- If both the **EFI\_VARIABLE\_TIME\_BASED\_AUTHENTICATED\_WRITE\_ACCESS** and the **EFI\_VARIABLE\_ENHANCED\_AUTHENTICATED\_ACCESS** attribute are set in a **SetVariable()** call, then the firmware must return **EFI\_INVALID\_PARAMETER**.

- If the **EFI\_VARIABLE\_APPEND\_WRITE** attribute is set in a **SetVariable()** call, then any existing variable value shall be appended with the value of the *Data* parameter. If the firmware does not support the append operation, then the **SetVariable()** call shall return **EFI\_INVALID\_PARAMETER**.
- If the **EFI\_VARIABLE\_TIME\_BASED\_AUTHENTICATED\_WRITE\_ACCESS** attribute is set in a **SetVariable()** call, and firmware does not support signature type of the certificate included in the **EFI\_VARIABLE\_AUTHENTICATION\_2** descriptor, then the **SetVariable()** call shall return **EFI\_INVALID\_PARAMETER**. The list of signature types supported by the firmware is defined by the SignatureSupport variable. Signature type of the certificate is defined by its digest and encryption algorithms.
- If the **EFI\_VARIABLE\_HARDWARE\_ERROR\_RECORD** attribute is set, *VariableName* and *VendorGuid* must comply with the rules stated in [Section 8.2.4.2](#) and [Appendix P](#). Otherwise, the **SetVariable()** call shall return **EFI\_INVALID\_PARAMETER**.
- Globally Defined Variables defined in [Section 3.3](#) must be created with the attributes defined in the [Table 10](#). If a globally defined variable is created with the wrong attributes, the result is indeterminate and may vary between implementations.
- If using the **EFI\_VARIABLE\_ENHANCED\_AUTHENTICATED\_ACCESS** interface to update the cert authority for a given variable, it is valid for the *Data* region of the payload to be empty. This would update the cert without modifying the data itself. If the *Data* region is empty AND no NewCert is specified, the variable will be deleted (assuming all authorizations are verified).
- Secure Boot Policy Variable must be created with the **EFI\_VARIABLE\_TIME\_BASED\_AUTHENTICATED\_WRITE\_ACCESS** attribute set, and the authentication shall use the **EFI\_VARIABLE\_AUTHENTICATION\_2** descriptor. If the appropriate attribute bit is not set, then the firmware shall return **EFI\_INVALID\_PARAMETER**.

The only rules the firmware must implement when saving a nonvolatile variable is that it has actually been saved to nonvolatile storage before returning **EFI\_SUCCESS**, and that a partial save is not performed. If power fails during a call to **SetVariable()** the variable may contain its previous value, or its new value. In addition there is no read, write, or delete security protection.

To delete a variable created with the **EFI\_VARIABLE\_TIME\_BASED\_AUTHENTICATED\_WRITE\_ACCESS** attribute, *SetVariable* must be used with attributes matching the existing variable and the *DataSize* set to the size of the *AuthInfo* descriptor. The *Data* buffer must contain an instance of the *AuthInfo* descriptor which will be validated according to the steps in the appropriate section above referring to updates of Authenticated variables. An attempt to delete a variable created with the **EFI\_VARIABLE\_TIME\_BASED\_AUTHENTICATED\_WRITE\_ACCESS** attribute for which the prescribed *AuthInfo* validation fails or when called using *DataSize* of zero will fail with an **EFI\_SECURITY\_VIOLATION** status.

To delete a variable created with the **EFI\_VARIABLE\_ENHANCED\_AUTHENTICATED\_ACCESS** attribute, *SetVariable* must be used with attributes matching the existing variable and the *DataSize* set to the size of the entire payload including all descriptors and certificates. The *Data* buffer must contain an

instance of the **EFI\_VARIABLE\_AUTHENTICATION\_3** descriptor which will indicate how to validate the payload according to the description in [Section 8.2.1](#). An attempt to delete a variable created with the **EFI\_VARIABLE\_ENHANCED\_AUTHENTICATED\_ACCESS** attribute for which the prescribed validation fails or when called using *DataSize* of zero will fail with an **EFI\_SECURITY\_VIOLATION** status.

## Status Codes Returned

EFI_SUCCESS	The firmware has successfully stored the variable and its data as defined by the Attributes.
EFI_INVALID_PARAMETER	An invalid combination of attribute bits, name, and GUID was supplied, or the <i>DataSize</i> exceeds the maximum allowed.
EFI_INVALID_PARAMETER	<i>VariableName</i> is an empty string.
EFI_OUT_OF_RESOURCES	Not enough storage is available to hold the variable and its data.
EFI_DEVICE_ERROR	The variable could not be saved due to a hardware failure.
EFI_WRITE_PROTECTED	The variable in question is read-only.
EFI_WRITE_PROTECTED	The variable in question cannot be deleted.
EFI_SECURITY_VIOLATION	The variable could not be written due to <b>EFI_VARIABLE_ENHANCED_AUTHENTICATED_ACCESS</b> or <b>EFI_VARIABLE_TIME_BASED_AUTHENTICATED_WRITE_ACCESS</b> being set, but the payload does NOT pass the validation check carried out by the firmware.
EFI_NOT_FOUND	The variable trying to be updated or deleted was not found.

### 8.2.1 Using the EFI\_VARIABLE\_AUTHENTICATION\_3 descriptor

When the attribute **EFI\_VARIABLE\_ENHANCED\_AUTHENTICATED\_ACCESS** is set, the payload buffer (passed into `SetVariable()` as "Data") shall be constructed as follows:

// NOTE: "||" indicates concatenation.

// NOTE: "[]" indicates an optional element.

// Example: **EFI\_VARIABLE\_AUTHENTICATION\_3\_TIMESTAMP\_TYPE**

EFI\_VARIABLE\_AUTHENTICATION\_3 || EFI\_TIME || [ NewCert ] || SigningCert || Data

// Example: **EFI\_VARIABLE\_AUTHENTICATION\_3\_NONCE\_TYPE**

EFI\_VARIABLE\_AUTHENTICATION\_3 || EFI\_VARIABLE\_AUTHENTICATION\_3\_NONCE || [ NewCert ] || SigningCert || Data

In this example, `NewCert` and `SigningCert` are both instances of **WIN\_CERTIFICATE\_UEFI\_GUID**. The presence of `NewCert` is indicated by the

[EFI\\_VARIABLE\\_AUTHENTICATION\\_3.Flags](#) field (see Definition in SetVariable()). If provided – and assuming the payload passes all integrity and security verifications – this cert will be set as the new authority for the underlying variable, even if the variable is being newly created.

The NewCert element must have a CertType of EFI\_CERT\_TYPE\_PKCS7\_GUID and the CertData must be a DER-encoded PKCS#7 version 1.5 SignedData structure. When creating the SignedData structure, the following steps shall be followed:

1. Create a [WIN\\_CERTIFICATE\\_UEFI\\_GUID](#) structure where CertType is set to [EFI\\_CERT\\_TYPE\\_PKCS7\\_GUID](#).
2. Use the x509 cert being added as the new authority to sign its own tbsCertificate data.
3. Construct a DER-encoded PKCS #7 version 1.5 SignedData (see [RFC2315]) with the signed content as follows:
  - a SignedData.version shall be set to 1.
  - b SignedData.digestAlgorithms shall contain the digest algorithm used when preparing the signature. Only a digest algorithm of SHA-256 is accepted.
  - c SignedData.contentInfo.contentType shall be set to id-data.
  - d SignedData.contentInfo.content shall be the tbsCertificate data that was signed for the new x509 cert.
  - e SignedData.certificates shall contain, at a minimum, the signer's DER-encoded X.509 certificate.
  - f SignedData.crls is optional.
  - g SignedData.signerInfos shall be constructed as:
    - SignerInfo.version shall be set to 1.
    - SignerInfo.issuerAndSerial shall be present and as in the signer's certificate.
    - SignerInfo.authenticatedAttributes shall not be present.
    - SignerInfo.digestEncryptionAlgorithm shall be set to the algorithm used to sign the data. Only a digest encryption algorithm of RSA with PKCS #1 v1.5 padding (RSASSA\_PKCS1v1\_5). is accepted.
    - SignerInfo.encryptedDigest shall be present.
    - SignerInfo.unauthenticatedAttributes shall not be present.
4. Set the CertData field to the DER-encoded PKCS#7 SignedData value.

A caller to SetVariable() attempting to create, update, or delete a variable with the [EFI\\_VARIABLE\\_ENHANCED\\_AUTHENTICATED\\_ACCESS](#) set shall perform the following steps to create the SignedData structure for SigningCert:

1. Create an [EFI\\_VARIABLE\\_AUTHENTICATION\\_3](#) Primary Descriptor with the following values:
  - a Version shall be set appropriate to the version of metadata headers being used (currently 1).
  - b Type should be set based on caller specifications (see [EFI\\_VARIABLE\\_AUTHENTICATION\\_3 descriptor](#) under SetVariable()).

- c MetadataSize can be ignored for now, and will be updated when constructing the final payload.
  - d Flags shall be set based on caller specifications.
2. A Secondary Descriptor may need to be created based on the Type.
    - a For **EFI\_VARIABLE\_AUTHENTICATION\_3\_TIMESTAMP\_TYPE** type, this will be an instance of **EFI\_TIME** set to the current time.
    - b For **EFI\_VARIABLE\_AUTHENTICATION\_3\_NONCE\_TYPE** type, this will be an instance of **EFI\_VARIABLE\_AUTHENTICATION\_3\_NONCE** updated with NonceSize set based on caller specifications (must not be zero), and Nonce (informal structure member) set to:
      - All zeros to request that the platform create a random nonce.
      - Caller specified value for a pre-generated nonce.
  3. Hash a serialization of the payload. Serialization shall contain the following elements in this order:
    - a VariableName, VendorGuid, Attributes, and the Secondary Descriptor if it exists for this Type.
    - b Variable's new value (ie. the Data parameter's new variable content).
    - c If this is an update to or deletion of a variable with type **EFI\_VARIABLE\_AUTHENTICATION\_3\_NONCE**, serialize the current nonce. The current nonce is the one currently associated with this variable, not the one in the Secondary Descriptor. Serialize only the nonce buffer contents, not the size or any additional data. If this is an attempt to create a new variable (ie. there is no current nonce), skip this step.
    - d If the authority cert for this variable is being updated and the **EFI\_VARIABLE\_AUTHENTICATION\_3.Flags** field indicates the presence of a NewCert structure, serialize the entire NewCert structure (described at the beginning of this section).
  4. Sign the resulting digest.
  5. Create a **WIN\_CERTIFICATE\_UEFI\_GUID** structure where CertType is set to **EFI\_CERT\_TYPE\_PKCS7\_GUID**.
  6. Construct a DER-encoded PKCS #7 version 1.5 SignedData (see [RFC2315]) following the steps described for NewCert (step 3), above, with the following exception:
    - a SignedData.contentInfo.content shall be absent (the content is provided in the *Data* parameter to the SetVariable() call)
  7. Construct the final payload for SetVariable() according to the descriptions for "payload buffer" at the beginning of this section.
  8. Update the **EFI\_VARIABLE\_AUTHENTICATION\_3.MetadataSize** field to include all parts of the final payload except "Data".

Firmware that implements the SetVariable() services and supports the **EFI\_VARIABLE\_ENHANCED\_AUTHENTICATED\_ACCESS** attribute shall do the following in response to being called:



1. Read the [EFI\\_VARIABLE\\_AUTHENTICATION\\_3](#) descriptor to determine what type of authentication is being performed and how to parse the rest of the payload.
2. Verify that SigningCert.CertType is [EFI\\_CERT\\_TYPE\\_PKCS7\\_GUID](#).
  - a. If [EFI\\_VARIABLE\\_AUTHENTICATION\\_3.Flags](#) field indicates presence of a NewCert, verify that NewCert.CertType is [EFI\\_CERT\\_TYPE\\_PKCS7\\_GUID](#).
  - b. If either fails, return `EFI_INVALID_PARAMETER`.
3. If the variable already exists, verify that the incoming type matches the existing type.
4. Verify that any [EFI\\_TIME](#) structures have Pad1, Nanosecond, TimeZone, Daylight, and Pad2 fields set to zero.
5. If [EFI\\_VARIABLE\\_AUTHENTICATION\\_3\\_NONCE\\_TYPE](#):
  - a. Verify that NonceSize is greater than zero. If zero, return `EFI_INVALID_PARAMETER`.
  - b. If incoming nonce is all zeros, confirm that platform supports generating random nonce. If unsupported, return `EFI_UNSUPPORTED`.
  - c. If nonce is specified and variable already exists, verify that incoming nonce does not match existing nonce. If identical, return `EFI_INVALID_PARAMETER`.
6. If [EFI\\_VARIABLE\\_AUTHENTICATION\\_3\\_TIMESTAMP\\_TYPE](#) and variable already exists, verify that new timestamp is chronologically greater than current timestamp.
7. Verify the payload signature by:
  - a. Parsing entire payload according to descriptors.
  - b. Using descriptor contents (and, if necessary, metadata from existing variable) to construct the serialization described previously in this section (step 3 of the SetVariable() instructions).
  - c. Compute the digest and compare with the result of applying the SigningCert's public key to the signature.
8. If the variable already exists, verify that the SigningCert authority is the same as the authority already associated with the variable.
9. If NewCert is provided, verify the NewCert signature by:
  - a. Parsing entire payload according to descriptors.
  - b. Compute a digest of the tbsCertificate of x509 certificate in NewCert and compare with the result of applying NewCert's public key to the signature.
  - c. If this fails, return `EFI_SECURITY_VIOLATION`.

### 8.2.2 Using the [EFI\\_VARIABLE\\_AUTHENTICATION\\_2](#) descriptor

When the attribute `EFI_VARIABLE_TIME_BASED_AUTHENTICATED_WRITE_ACCESS` is set, then the Data buffer shall begin with an instance of a complete (and serialized) [EFI\\_VARIABLE\\_AUTHENTICATION\\_2](#) descriptor. The descriptor shall be followed by the new variable value and DataSize shall reflect the combined size of the descriptor and the new variable value. The authentication descriptor is not part of the variable data and is not returned by subsequent calls to GetVariable().



A caller that invokes the SetVariable() service with the EFI\_VARIABLE\_TIME\_BASED\_AUTHENTICATED\_WRITE\_ACCESS attribute set shall do the following prior to invoking the service:

1. Create a descriptor

Create an EFI\_VARIABLE\_AUTHENTICATION\_2 descriptor where:

- TimeStamp is set to the current time.

**Note:** *In certain environments a reliable time source may not be available. In this case, an implementation may still add values to an authenticated variable since the EFI\_VARIABLE\_APPEND\_WRITE attribute, when set, disables timestamp verification (see below). In these instances, the special time value where every component of the EFI\_TIME struct including the Day and Month is set to 0 shall be used.*

- AuthInfo.CertType is set to EFI\_CERT\_TYPE\_PKCS7\_GUID.

2. Hash the serialization of the values of the VariableName, VendorGuid and Attributes parameters of the SetVariable() call and the TimeStamp component of the EFI\_VARIABLE\_AUTHENTICATION\_2 descriptor followed by the variable's new value (i.e. the Data parameter's new variable content). That is, digest = hash (VariableName, VendorGuid, Attributes, TimeStamp, DataNew\_variable\_content). The NULL character terminating the VariableName value shall not be included in the hash computation.
3. Sign the resulting digest using a selected signature scheme (e.g. PKCS #1 v1.5)
4. Construct a DER-encoded PKCS #7 version 1.5 SignedData (see [RFC2315]) with the signed content as follows:
- a SignedData.version shall be set to 1
  - b SignedData.digestAlgorithms shall contain the digest algorithm used when preparing the signature. Only a digest algorithm of SHA-256 is accepted.
  - c SignedData.contentInfo.contentType shall be set to id-data
  - d SignedData.contentInfo.content shall be absent (the content is provided in the Data parameter to the SetVariable() call)
  - e SignedData.certificates shall contain, at a minimum, the signer's DER-encoded X.509 certificate
  - f SignedData.crls is optional.
  - g SignedData.signerInfos shall be constructed as:
    - SignerInfo.version shall be set to 1
    - SignerInfo.issuerAndSerial shall be present and as in the signer's certificate — SignerInfo.authenticatedAttributes shall not be present.
    - SignerInfo.digestEncryptionAlgorithm shall be set to the algorithm used to sign the data. Only a digest encryption algorithm of RSA with PKCS #1 v1.5 padding (RSASSA\_PKCS1v1\_5). is accepted.
    - SignerInfo.encryptedDigest shall be present
    - SignerInfo.unauthenticatedAttributes shall not be present.
5. Set AuthInfo.CertData to the DER-encoded PKCS #7 SignedData value.

6. Construct Data parameter: Construct the SetVariable()'s Data parameter by concatenating the complete, serialized EFI\_VARIABLE\_AUTHENTICATION\_2 descriptor with the new value of the variable (DataNew\_variable\_content).

Firmware that implements the SetVariable() service and supports the EFI\_VARIABLE\_TIME\_BASED\_AUTHENTICATED\_WRITE\_ACCESS attribute shall do the following in response to being called:

1. Verify that the correct AuthInfo.CertType (EFI\_CERT\_TYPE\_PKCS7\_GUID) has been used and that the AuthInfo.CertData value parses correctly as a PKCS #7 SignedData value
2. Verify that Pad1, Nanosecond, TimeZone, Daylight and Pad2 components of the TimeStamp value are set to zero. Unless the EFI\_VARIABLE\_APPEND\_WRITE attribute is set, verify that the TimeStamp value is later than the current timestamp value associated with the variable.
3. If the variable SetupMode==1, and the variable is a secure boot policy variable, then the firmware implementation shall consider the checks in the following steps 4 and 5 to have passed, and proceed with updating the variable value as outlined below.
4. Verify the signature by:
  - extracting the EFI\_VARIABLE\_AUTHENTICATION\_2 descriptor from the Data buffer;
  - using the descriptor contents and other parameters to (a) construct the input to the digest algorithm; (b) computing the digest; and (c) comparing the digest with the result of applying the signer's public key to the signature.
5. If the variable is the global PK variable or the global KEK variable, verify that the signature has been made with the current Platform Key.
  - If the variable is the "db", "dbt", "dbr", or "dbx" variable mentioned in step 3, verify that the signer's certificate chains to a certificate in the Key Exchange Key database (or that the signature was made with the current Platform Key).
  - If the variable is the "OsRecoveryOrder" or "OsRecovery####" variable mentioned in step 3, verify that the signer's certificate chains to a certificate in the "dbr" database or the Key Exchange Key database, or that the signature was made with the current Platform Key.
  - Otherwise, if the variable is none of the above, it shall be designated a Private Authenticated Variable. If the Private Authenticated Variable does not exist, then the CN of the signing certificate's Subject and the hash of the tbsCertificate of the top-level issuer certificate (or the signing certificate itself if no other certificates are present or the certificate chain is of length 1) in SignedData.certificates is registered for use in subsequent verifications of this variable. Implementations may store just a single hash of these two elements to reduce storage requirements. If the Private Authenticated variable previously existed, that the signer's certificate chains to the information previously associated with the variable. Observe that because no revocation list exists for them, if any member of the certificate chain is compromised, the only method to revoke trust in a certificate for a Private Authenticated Variable is to delete the variable, re-issue all certificate authorities in the chain, and re-create the variable using the new certificate chain. As such, the remaining benefits may be strong identification of

the originator, or compliance with some certificate authority policy. Further note that the PKCS7 bundle for the authenticated variable update must contain the signing certificate chain, through and including the full certificate of the desired trust anchor. The trust anchor might be a mid-level certificate or root, though many roots may be unsuitable trust anchors due to the number of CAs they issue for different purposes. Some tools require non-default parameters to include the trust anchor certificate.

The driver shall update the value of the variable only if all of these checks pass. If any of the checks fails, firmware must return `EFI_SECURITY_VIOLATION`.

The firmware shall perform an append to an existing variable value only if the `EFI_VARIABLE_APPEND_WRITE` attribute is set.

For variables with the GUID `EFI_IMAGE_SECURITY_DATABASE_GUID` (i.e. where the data buffer is formatted as `EFI_SIGNATURE_LIST`), the driver shall not perform an append of `EFI_SIGNATURE_DATA` values that are already part of the existing variable value.

**Note:** *This situation is not considered an error, and shall in itself not cause a status code other than `EFI_SUCCESS` to be returned or the timestamp associated with the variable not to be updated.*

The firmware shall associate the new timestamp with the updated value (in the case when the `EFI_VARIABLE_APPEND_WRITE` attribute is set, this only applies if the new `TimeStamp` value is later than the current timestamp associated with the variable).

If the variable did not previously exist, and is not one of the variables listed in step 3 above, then firmware shall associate the signer's public key with the variable for future verification purposes.

### 8.2.3 Using the `EFI_VARIABLE_AUTHENTICATION` descriptor

**Note:** *This interface is deprecated and should no longer be used! It will be removed from future versions of the spec.*

When the attribute `EFI_VARIABLE_AUTHENTICATED_WRITE_ACCESS` is set, but the `EFI_VARIABLE_TIME_BASED_AUTHENTICATED_WRITE_ACCESS` is not set (i.e. when the `EFI_VARIABLE_AUTHENTICATION` descriptor is used), then the *Data* buffer shall begin with an instance of the authentication descriptor *AuthInfo* prior to the data payload and *DataSize* should reflect the data and descriptor size. The authentication descriptor is not part of the variable data and is not returned by the subsequent calls to *GetVariable*. The caller shall digest the Monotonic Count value and the associated data for the variable update using the SHA-256 1-way hash algorithm. The ensuing the 32-byte digest will be signed using the private key associated w/ the public 2048-bit RSA key *PublicKey* described in the `EFI_CERT_BLOCK_RSA_2048_SHA256` structure.

The `WIN_CERTIFICATE` shall be used to describe the signature of the Variable data *\*Data*. In addition, the signature will also include the *MonotonicCount* value to guard against replay attacks. The *MonotonicCount* value must be increased by the caller prior to an update of the *\*Data* when the `EFI_VARIABLE_AUTHENTICATED_WRITE_ACCESS` is set.

From the `EFI_CERT_BLOCK_RSA_2048_SHA256`, the *HashType* will be `EFI_SHA256_HASH` and the `ANYSIZE_ARRAY` of *Signature* will be 256. The `WIN_CERTIFICATE_PKCS1_15` could have been used but was not for the following

reason: There are possibly various different principals to create authenticated variables, so the public key corresponding to a given principal is added to the **EFI\_CERT\_BLOCK\_RSA\_2048\_SHA256** within the **WIN\_CERTIFICATE**. This does not lend cryptographic value so much as it provides something akin to a handle for the platform firmware to use during its verification operation.

The *MonotonicCount* value must be strictly greater for each successive variable update operation. This allows for ensuring freshness of the update operation and defense against replay attacks (i.e., if someone had the value of a former *AuthInfo*, such as a Man-in-the-Middle they could not re-invoke that same update session). For maintenance, the party who initially provisioned the variable (i.e., caller of `SetVariable`) and set the monotonic count will have to pass the credential (key-pair and monotonic count) to any party who is delegated to make successive updates to the variable with the **EFI\_VARIABLE\_AUTHENTICATED\_WRITE\_ACCESS** set. This 3-tuple of {public key, private key, monotonic count} becomes part of the management metadata for these access-controlled items.

The responsibility of the caller that invokes the `SetVariable()` service with the **EFI\_VARIABLE\_AUTHENTICATED\_WRITE\_ACCESS** attribute will do the following prior to invoking the service:

- Update the Monotonic Count value.
- Hash the variable contents (Data, Size, Monotonic count) using the *HashType* in the *AuthInfo* structure.
- Sign the resultant hash of above step using a caller private key and create the digital signature *Signature*. Ensure that the public key associated with signing private key is in the *AuthInfo* structure.
- Invoke `SetVariables` with **EFI\_VARIABLE\_AUTHENTICATED\_WRITE\_ACCESS** attribute set.

The responsibility of the firmware that implements the `SetVariable()` service and supports the **EFI\_VARIABLE\_AUTHENTICATED\_WRITE\_ACCESS** attribute will do the following in response to being called:

- The first time it uses `SetVariable` with the **EFI\_VARIABLE\_AUTHENTICATED\_WRITE\_ACCESS** attribute set. Use the public key in the *AuthInfo* structure for subsequent verification.
- Hash the variable contents (Data, Size, Monotonic count) using the *HashType* in the *AuthInfo* structure.
- Compare the public key in the *AuthInfo* structure with the public key passed in on the first invocation.
- Verify the digital signature *Signature* of the signed hash using the stored public key associated with the variable.
- Compare the verification of the signature with the instance generated by the caller
- If comparison fails, return **EFI\_SECURITY\_VIOLATION**.

- Compare the new monotonic count and ensure that it is greater than the last SetVariable operation with the **EFI\_VARIABLE\_AUTHENTICATED\_WRITE\_ACCESS** attribute set.
- If new monotonic count is not strictly greater, then return **EFI\_SECURITY\_VIOLATION**.

**NOTE:** Special processing by SetVariable() for Secure Boot Mode variables and the Platform Key is defined in [Firmware/OS Key Exchange: creating trust relationships](#).

## QueryVariableInfo()

### Summary

Returns information about the EFI variables.

### Prototype

```
typedef
EFI_STATUS
QueryVariableInfo (
    IN UINT32  Attributes,
    OUT UINT64 *MaximumVariableStorageSize,
    OUT UINT64 *RemainingVariableStorageSize,
    OUT UINT64 *MaximumVariableSize
);
```

*Attributes* Attributes bitmask to specify the type of variables on which to return information. Refer to the **GetVariable()** function description. The **EFI\_VARIABLE\_APPEND\_WRITE** attribute, if set in the attributes bitmask, will be ignored.

*MaximumVariableStorageSize* On output the maximum size of the storage space available for the EFI variables associated with the attributes specified.

*RemainingVariableStorageSize* Returns the remaining size of the storage space available for EFI variables associated with the attributes specified.

*MaximumVariableSize* Returns the maximum size of an individual EFI variable associated with the attributes specified.

### Description

The **QueryVariableInfo()** function allows a caller to obtain the information about the maximum size of the storage space available for the EFI variables, the remaining size of the storage space available for the EFI variables and the maximum size of each individual EFI variable, associated with the attributes specified.

The *MaximumVariableSize* value will reflect the overhead associated with the saving of a single EFI variable with the exception of the overhead associated with the length of the string name of the EFI variable.

The returned *MaximumVariableStorageSize*, *RemainingVariableStorageSize*, *MaximumVariableSize* information may change immediately after the call based on other runtime activities including asynchronous error events. Also, these values associated with different attributes are not additive in nature.

After the system has transitioned into runtime (after **ExitBootServices()** is called), an implementation may not be able to accurately return information about the Boot Services variable store. In such cases, **EFI\_INVALID\_PARAMETER** should be returned.

## Status Codes Returned

EFI_SUCCESS	Valid answer returned.
EFI_INVALID_PARAMETER	An invalid combination of attribute bits was supplied
EFI_UNSUPPORTED	The attribute is not supported on this platform, and the <i>MaximumVariableStorageSize</i> , <i>RemainingVariableStorageSize</i> , <i>MaximumVariableSize</i> are undefined.

### 8.2.4 Hardware Error Record Persistence

This section defines how Hardware Error Record Persistence is to be implemented. By implementing support for Hardware Error Record Persistence, the platform enables the OS to utilize the EFI Variable Services to save hardware error records so they are persistent and remain available across OS sessions until they are explicitly cleared or overwritten by their creator.

#### 8.2.4.1 Hardware Error Record Non-Volatile Store

A platform which implements support hardware error record persistence is required to guarantee some amount of NVR is available to the OS for saving hardware error records. The platform communicates the amount of space allocated for error records via the QueryVariableInfo routine as described in [Appendix P](#).

#### 8.2.4.2 Hardware Error Record Variables

This section defines a set of Hardware Error Record variables that have architecturally defined meanings. In addition to the defined data content, each such variable has an architecturally defined attribute that indicates when the data variable may be accessed. The variables with an attribute of HR are stored in the portion of NVR allocated for error records. NV, BS and RT have the meanings defined in section 3.2. All hardware error record variables use the **EFI\_HARDWARE\_ERROR\_VARIABLE** VendorGuid:

```
#define EFI_HARDWARE_ERROR_VARIABLE \
{0x414E6BDD,0xE47B,0x47cc,{0xB2,0x44,0xBB,0x61,0x02,0x0C,0xF5,0x16}}
```

Table 34. Hardware Error Record Persistence Variables

Variable Name	Attribute	Description
HwErrRec####	NV, BS, RT, HR	A hardware error record. #### is a printed hex value. No 0x or h is included in the hex value

The HwErrRec#### variable contains a hardware error record. Each HwErrRec#### variable is the name "HwErrRec" appended with a unique 4-digit hexadecimal number. For example, HwErrRec0001, HwErrRec0002, HwErrRecF31A, etc. The HR attribute indicates that this variable is to be stored in the portion of NVR allocated for error records.

### 8.2.4.3 Common Platform Error Record Format

Error record variables persisted using this interface are encoded in the Common Platform Error Record format, which is described in appendix N of the *UEFI Specification*. Because error records persisted using this interface conform to this standardized format, the error information may be used by entities other than the OS.

## 8.3 Time Services

This section contains function definitions for time-related functions that are typically needed by operating systems at runtime to access underlying hardware that manages time information and services. The purpose of these interfaces is to provide operating system writers with an abstraction for hardware time devices, thereby relieving the need to access legacy hardware devices directly. There is also a stalling function for use in the preboot environment. [Table 35](#) lists the time services functions described in this section:

**Table 35. Time Services Functions**

Name	Type	Description
GetTime	Runtime	Returns the current time and date, and the time-keeping capabilities of the platform.
SetTime	Runtime	Sets the current local time and date information.
GetWakeupTime	Runtime	Returns the current wakeup alarm clock setting.
SetWakeupTime	Runtime	Sets the system wakeup alarm clock time.



## GetTime()

### Summary

Returns the current time and date information, and the time-keeping capabilities of the hardware platform.

### Prototype

```
typedef
EFI_STATUS
GetTime (
    OUT EFI_TIME      *Time,
    OUT EFI_TIME_CAPABILITIES *Capabilities OPTIONAL
);
```

### Parameters

<i>Time</i>	A pointer to storage to receive a snapshot of the current time. Type <b>EFI_TIME</b> is defined in “Related Definitions.”
<i>Capabilities</i>	An optional pointer to a buffer to receive the real time clock device’s capabilities. Type <b>EFI_TIME_CAPABILITIES</b> is defined in “Related Definitions.”

### Related Definitions

```
//*****
//EFI_TIME
//*****
// This represents the current time information
typedef struct {
    UINT16 Year; // 1900 – 9999
    UINT8 Month; // 1 – 12
    UINT8 Day; // 1 – 31
    UINT8 Hour; // 0 – 23
    UINT8 Minute; // 0 – 59
    UINT8 Second; // 0 – 59
    UINT8 Pad1;
    UINT32 Nanosecond; // 0 – 999,999,999
    INT16 TimeZone; // -1440 to 1440 or 2047
    UINT8 Daylight;
    UINT8 Pad2;
} EFI_TIME;

//*****
// Bit Definitions for EFI_TIME.Daylight. See below.
```

```
//*****
#define EFI_TIME_ADJUST_DAYLIGHT 0x01
#define EFI_TIME_IN_DAYLIGHT 0x02

//*****
// Value Definition for EFI_TIME. TimeZone. See below.
//*****
#define EFI_UNSPECIFIED_TIMEZONE 0x07FF
```

*Year, Month, Day* The current local date.

*Hour, Minute, Second, Nanosecond*

The current local time. Nanoseconds report the current fraction of a second in the device. The format of the time is *hh:mm:ss.nnnnnnnn*. A battery backed real time clock device maintains the date and time.

*TimeZone*

The time's offset in minutes from UTC. If the value is **EFI\_UNSPECIFIED\_TIMEZONE**, then the time is interpreted as a local time. The *TimeZone* is the number of minutes that the local time is relative to UTC. To calculate the *TimeZone* value, follow this equation: Localtime = UTC - *TimeZone*.

To further illustrate this, an example is given below:

PST (Pacific Standard Time is 12PM) = UTC (8PM) - 8 hours (480 minutes)

In this case, the value for *Timezone* would be 480 if referencing PST.

*Daylight*

A bitmask containing the daylight savings time information for the time.

The **EFI\_TIME\_ADJUST\_DAYLIGHT** bit indicates if the time is affected by daylight savings time or not. This value does not indicate that the time has been adjusted for daylight savings time. It indicates only that it should be adjusted when the **EFI\_TIME** enters daylight savings time.

If **EFI\_TIME\_IN\_DAYLIGHT** is set, the time has been adjusted for daylight savings time.

All other bits must be zero.

When entering daylight saving time, if the time is affected, but hasn't been adjusted (DST = 1), use the new calculation:

1. The date/time should be increased by the appropriate amount.
2. The *TimeZone* should be decreased by the appropriate amount (EX: +480 changes to +420 when moving from PST to PDT).

3. The *Daylight* value changes to 3.

When exiting daylight saving time, if the time is affected and has been adjusted (DST = 3), use the new calculation:

1. The date/time should be decreased by the appropriate amount.
2. The *TimeZone* should be increased by the appropriate amount.
3. The *Daylight* value changes to 1.

```
//*****
// EFI_TIME_CAPABILITIES
//*****
// This provides the capabilities of the
// real time clock device as exposed through the EFI interfaces.
typedef struct {
    UINT32 Resolution;
    UINT32 Accuracy;
    BOOLEAN SetsToZero;
} EFI_TIME_CAPABILITIES;
```

*Resolution*

Provides the reporting resolution of the real-time clock device in counts per second. For a normal PC-AT CMOS RTC device, this value would be 1 Hz, or 1, to indicate that the device only reports the time to the resolution of 1 second.

*Accuracy*

Provides the timekeeping accuracy of the real-time clock in an error rate of 1E-6 parts per million. For a clock with an accuracy of 50 parts per million, the value in this field would be 50,000,000.

*SetsToZero*

A **TRUE** indicates that a time set operation clears the device's time below the *Resolution* reporting level. A **FALSE** indicates that the state below the *Resolution* level of the device is not cleared when the time is set. Normal PC-AT CMOS RTC devices set this value to **FALSE**.

## Description

The **GetTime()** function returns a time that was valid sometime during the call to the function. While the returned **EFI\_TIME** structure contains *TimeZone* and *Daylight* savings time information, the actual clock does not maintain these values. The current time zone and daylight saving time information returned by **GetTime()** are the values that were last set via **SetTime()**.

The **GetTime()** function should take approximately the same amount of time to read the time each time it is called. All reported device capabilities are to be rounded up.

During runtime, if a PC-AT CMOS device is present in the platform the caller must synchronize access to the device before calling **GetTime()**.

## Status Codes Returned

EFI_SUCCESS	The operation completed successfully.
EFI_INVALID_PARAMETER	<i>Time</i> is <b>NULL</b> .
EFI_DEVICE_ERROR	The time could not be retrieved due to a hardware error.

## SetTime()

### Summary

Sets the current local time and date information.

### Prototype

```
typedef
EFI_STATUS
SetTime (
    IN EFI_TIME *Time
);
```

### Parameters

*Time*

A pointer to the current time. Type **EFI\_TIME** is defined in the [GetTime\(\)](#) function description. Full error checking is performed on the different fields of the **EFI\_TIME** structure (refer to the **EFI\_TIME** definition in the [GetTime\(\)](#) function description for full details), and **EFI\_INVALID\_PARAMETER** is returned if any field is out of range.

### Description

The **SetTime()** function sets the real time clock device to the supplied time, and records the current time zone and daylight savings time information. The **SetTime()** function is not allowed to loop based on the current time. For example, if the device does not support a hardware reset for the sub-resolution time, the code is *not* to implement the feature by waiting for the time to wrap.

During runtime, if a PC-AT CMOS device is present in the platform the caller must synchronize access to the device before calling **SetTime()**.

### Status Codes Returned

EFI_SUCCESS	The operation completed successfully.
EFI_INVALID_PARAMETER	A time field is out of range.
EFI_DEVICE_ERROR	The time could not be set due to a hardware error.

## GetWakeupTime()

### Summary

Returns the current wakeup alarm clock setting.

### Prototype

```
typedef
EFI_STATUS
GetWakeupTime (
  OUT BOOLEAN *Enabled,
  OUT BOOLEAN *Pending,
  OUT EFI_TIME *Time
);
```

### Parameters

*Enabled*

Indicates if the alarm is currently enabled or disabled.

*Pending*

Indicates if the alarm signal is pending and requires acknowledgement.

*Time*

The current alarm setting. Type **EFI\_TIME** is defined in the [GetTime\(\)](#) function description.

### Description

The alarm clock time may be rounded from the set alarm clock time to be within the resolution of the alarm clock device. The resolution of the alarm clock device is defined to be one second.

During runtime, if a PC-AT CMOS device is present in the platform the caller must synchronize access to the device before calling **GetWakeupTime()**.

### Status Codes Returned

EFI_SUCCESS	The alarm settings were returned.
EFI_INVALID_PARAMETER	<i>Enabled</i> is <b>NULL</b> .
EFI_INVALID_PARAMETER	<i>Pending</i> is <b>NULL</b> .
EFI_INVALID_PARAMETER	<i>Time</i> is <b>NULL</b> .
EFI_DEVICE_ERROR	The wakeup time could not be retrieved due to a hardware error.
EFI_UNSUPPORTED	A wakeup timer is not supported on this platform.

## SetWakeupTime()

### Summary

Sets the system wakeup alarm clock time.

### Prototype

```
typedef
EFI_STATUS
SetWakeupTime (
  IN BOOLEAN Enable,
  IN EFI_TIME *Time OPTIONAL
);
```

### Parameters

*Enable*

Enable or disable the wakeup alarm.

*Time*

If *Enable* is **TRUE**, the time to set the wakeup alarm for. Type **EFI\_TIME** is defined in the [GetTime\(\)](#) function description. If *Enable* is **FALSE**, then this parameter is optional, and may be **NULL**.

### Description

Setting a system wakeup alarm causes the system to wake up or power on at the set time. When the alarm fires, the alarm signal is latched until it is acknowledged by calling **SetWakeupTime()** to disable the alarm. If the alarm fires before the system is put into a sleeping or off state, since the alarm signal is latched the system will immediately wake up. If the alarm fires while the system is off and there is insufficient power to power on the system, the system is powered on when power is restored.

For an ACPI-aware operating system, this function only handles programming the wakeup alarm for the desired wakeup time. The operating system still controls the wakeup event as it normally would through the ACPI Power Management register set.

The resolution for the wakeup alarm is defined to be 1 second.

During runtime, if a PC-AT CMOS device is present in the platform the caller must synchronize access to the device before calling **SetWakeupTime()**.

## Status Codes Returned

EFI_SUCCESS	If <i>Enable</i> is <b>TRUE</b> , then the wakeup alarm was enabled. If <i>Enable</i> is <b>FALSE</b> , then the wakeup alarm was disabled.
EFI_INVALID_PARAMETER	A time field is out of range.
EFI_DEVICE_ERROR	The wakeup time could not be set due to a hardware error.
EFI_UNSUPPORTED	A wakeup timer is not supported on this platform.

## 8.4 Virtual Memory Services

This section contains function definitions for the virtual memory support that may be optionally used by an operating system at runtime. If an operating system chooses to make EFI runtime service calls in a virtual addressing mode instead of the flat physical mode, then the operating system must use the services in this section to switch the EFI runtime services from flat physical addressing to virtual addressing. [Table 36](#) lists the virtual memory service functions described in this section. The system firmware must follow the processor-specific rules outlined in [Section 2.3.2](#) through [Section 2.3.6](#) in the layout of the EFI memory map to enable the OS to make the required virtual mappings.

**Table 36. Virtual Memory Functions**

Name	Type	Description
SetVirtualAddressMap	Runtime	Used by an OS loader to convert from physical addressing to virtual addressing.
ConvertPointer	Runtime	Used by EFI components to convert internal pointers when switching to virtual addressing.



## SetVirtualAddressMap()

### Summary

Changes the runtime addressing mode of EFI firmware from physical to virtual.

### Prototype

```
typedef
EFI_STATUS
SetVirtualAddressMap (
    IN UINTN      MemoryMapSize,
    IN UINTN      DescriptorSize,
    IN UINT32     DescriptorVersion,
    IN EFI_MEMORY_DESCRIPTOR *VirtualMap
);
```

### Parameters

<i>MemoryMapSize</i>	The size in bytes of <i>VirtualMap</i> .
<i>DescriptorSize</i>	The size in bytes of an entry in the <i>VirtualMap</i> .
<i>DescriptorVersion</i>	The version of the structure entries in <i>VirtualMap</i> .
<i>VirtualMap</i>	An array of memory descriptors which contain new virtual address mapping information for all runtime ranges. Type <b>EFI_MEMORY_DESCRIPTOR</b> is defined in the <a href="#">EFI_BOOT_SERVICES.GetMemoryMap()</a> function description.

### Description

The **SetVirtualAddressMap()** function is used by the OS loader. The function can only be called at runtime, and is called by the owner of the system's memory map: i.e., the component which called [EFI\\_BOOT\\_SERVICES.ExitBootServices\(\)](#). All events of type **EVT\_SIGNAL\_VIRTUAL\_ADDRESS\_CHANGE** must be signaled before **SetVirtualAddressMap()** returns.

This call changes the addresses of the runtime components of the EFI firmware to the new virtual addresses supplied in the *VirtualMap*. The supplied *VirtualMap* must provide a new virtual address for every entry in the memory map at **ExitBootServices()** that is marked as being needed for runtime usage. All of the virtual address fields in the *VirtualMap* must be aligned on 4 KiB boundaries.

The call to **SetVirtualAddressMap()** must be done with the physical mappings. On successful return from this function, the system must then make any future calls with the newly assigned virtual mappings. All address space mappings must be done in accordance to the cacheability flags as specified in the original address map.

When this function is called, all events that were registered to be signaled on an address map change are notified. Each component that is notified must update any internal pointers for their new addresses. This can be done with the [ConvertPointer\(\)](#) function. Once all events have been notified, the EFI firmware reapplies image "fix-up" information

to virtually relocate all runtime images to their new addresses. In addition, all of the fields of the EFI Runtime Services Table except *SetVirtualAddressMap* and *ConvertPointer* must be converted from physical pointers to virtual pointers using the **ConvertPointer()** service. The **SetVirtualAddressMap()** and **ConvertPointer()** services are only callable in physical mode, so they do not need to be converted from physical pointers to virtual pointers. Several fields of the EFI System Table must be converted from physical pointers to virtual pointers using the **ConvertPointer()** service. These fields include *FirmwareVendor*, *RuntimeServices*, and *ConfigurationTable*. Because contents of both the EFI Runtime Services Table and the EFI System Table are modified by this service, the 32-bit CRC for the EFI Runtime Services Table and the EFI System Table must be recomputed.

A virtual address map may only be applied one time. Once the runtime system is in virtual mode, calls to this function return **EFI\_UNSUPPORTED**.

### Status Codes Returned

EFI_SUCCESS	The virtual address map has been applied.
EFI_UNSUPPORTED	EFI firmware is not at runtime, or the EFI firmware is already in virtual address mapped mode.
EFI_INVALID_PARAMETER	<i>DescriptorSize</i> or <i>DescriptorVersion</i> is invalid.
EFI_NO_MAPPING	A virtual address was not supplied for a range in the memory map that requires a mapping.
EFI_NOT_FOUND	A virtual address was supplied for an address that is not found in the memory map.

## ConvertPointer()

### Summary

Determines the new virtual address that is to be used on subsequent memory accesses.

### Prototype

```
typedef
EFI_STATUS
ConvertPointer (
  IN UINTN DebugDisposition,
  IN VOID **Address
);
```

### Parameters

<i>DebugDisposition</i>	Supplies type information for the pointer being converted. See “Related Definitions.”
<i>Address</i>	A pointer to a pointer that is to be fixed to be the value needed for the new virtual address mappings being applied.

### Related Definitions

```
//*****
// EFI_OPTIONAL_PTR
//*****
#define EFI_OPTIONAL_PTR 0x00000001
```

### Description

The **ConvertPointer()** function is used by an EFI component during the [SetVirtualAddressMap\(\)](#) operation. **ConvertPointer()** must be called using physical address pointers during the execution of **SetVirtualAddressMap()**.

The **ConvertPointer()** function updates the current pointer pointed to by *Address* to be the proper value for the new address map. Only runtime components need to perform this operation. The [EFI\\_BOOT\\_SERVICES.CreateEvent\(\)](#) function is used to create an event that is to be notified when the address map is changing. All pointers the component has allocated or assigned must be updated.

If the **EFI\_OPTIONAL\_PTR** flag is specified, the pointer being converted is allowed to be **NULL**.

Once all components have been notified of the address map change, firmware fixes any compiled in pointers that are embedded in any runtime image.

## Status Codes Returned

EFI_SUCCESS	The pointer pointed to by <i>Address</i> was modified.
EFI_NOT_FOUND	The pointer pointed to by <i>Address</i> was not found to be part of the current memory map. This is normally fatal.
EFI_INVALID_PARAMETER	<i>Address</i> is <b>NULL</b> .
EFI_INVALID_PARAMETER	* <i>Address</i> is <b>NULL</b> and <i>DebugDisposition</i> does not have the <b>EFI_OPTIONAL_PTR</b> bit set.

## 8.5 Miscellaneous Runtime Services

This section contains the remaining function definitions for runtime services not defined elsewhere but which are required to complete the definition of the EFI environment. [Table 37](#) lists the Miscellaneous Runtime Services.

**Table 37. Miscellaneous Runtime Services**

Name	Type	Description
GetNextHighMonotonicCount	Runtime	Returns the next high 32 bits of the platform's monotonic counter.
ResetSystem	Runtime	Resets the entire platform.
UpdateCapsule	Runtime	Pass capsules to the firmware. The firmware may process the capsules immediately or return a value to be passed into <a href="#">ResetSystem()</a> that will cause the capsule to be processed by the firmware as part of the reset process.
QueryCapsuleCapabilities	Runtime	Returns if the capsule can be supported via <b>UpdateCapsule()</b>

### 8.5.1 Reset System

This section describes the reset system runtime service and its associated data structures.

## ResetSystem()

### Summary

Resets the entire platform. If the platform supports [EFI RESET NOTIFICATION PROTOCOL](#), then prior to completing the reset of the platform, all of the pending notifications must be called.

### Prototype

```
typedef
VOID
(EFI_API *EFI_RESET_SYSTEM) (
    IN EFI_RESET_TYPE ResetType,
    IN EFI_STATUS ResetStatus,
    IN UINTN DataSize,
    IN VOID *ResetData OPTIONAL
);
```

### Parameters

<i>ResetType</i>	The type of reset to perform. Type <b>EFI_RESET_TYPE</b> is defined in “Related Definitions” below.
<i>ResetStatus</i>	The status code for the reset. If the system reset is part of a normal operation, the status code would be <b>EFI_SUCCESS</b> . If the system reset is due to some type of failure the most appropriate EFI Status code would be used.
<i>DataSize</i>	The size, in bytes, of <i>ResetData</i> .
<i>ResetData</i>	For a <i>ResetType</i> of <b>EfiResetCold</b> , <b>EfiResetWarm</b> , or <b>EfiResetShutdown</b> the data buffer starts with a Null-terminated string, optionally followed by additional binary data. The string is a description that the caller may use to further indicate the reason for the system reset. <i>ResetData</i> is only valid if <i>ResetStatus</i> is something other than <b>EFI_SUCCESS</b> unless the <i>ResetType</i> is <b>EfiResetPlatformSpecific</b> where a minimum amount of <i>ResetData</i> is always required.  For a <i>ResetType</i> of <b>EfiResetPlatformSpecific</b> the data buffer also starts with a Null-terminated string that is followed by an EFI_GUID that describes the specific type of reset to perform.

## Related Definitions

```

//*****
// EFI_RESET_TYPE
//*****
typedef enum {
    EfiResetCold,
    EfiResetWarm,
    EfiResetShutdown
    EfiResetPlatformSpecific
} EFI_RESET_TYPE;

```

## Description

The **ResetSystem()** function resets the entire platform, including all processors and devices, and reboots the system.

Calling this interface with *ResetType* of **EfiResetCold** causes a system-wide reset. This sets all circuitry within the system to its initial state. This type of reset is asynchronous to system operation and operates without regard to cycle boundaries. **EfiResetCold** is tantamount to a system power cycle.

Calling this interface with *ResetType* of **EfiResetWarm** causes a system-wide initialization. The processors are set to their initial state, and pending cycles are not corrupted. If the system does not support this reset type, then an **EfiResetCold** must be performed.

Calling this interface with *ResetType* of **EfiResetShutdown** causes the system to enter a power state equivalent to the ACPI G2/S5 or G3 states. If the system does not support this reset type, then when the system is rebooted, it should exhibit the **EfiResetCold** attributes.

Calling this interface with *ResetType* of **EfiResetPlatformSpecific** causes a system-wide reset. The exact type of the reset is defined by the **EFI\_GUID** that follows the Null-terminated Unicode string passed into *ResetData*. If the platform does not recognize the **EFI\_GUID** in *ResetData* the platform must pick a supported reset type to perform. The platform may optionally log the parameters from any non-normal reset that occurs.

The **ResetSystem()** function does not return.

## 8.5.2 Get Next High Monotonic Count

This section describes the `GetNextHighMonotonicCount` runtime service and its associated data structures.

## GetNextHighMonotonicCount()

### Summary

Returns the next high 32 bits of the platform's monotonic counter.

### Prototype

```
typedef
EFI_STATUS
GetNextHighMonotonicCount (
    OUT UINT32 *HighCount
);
```

### Parameters

*HighCount*                      Pointer to returned value.

### Description

The **GetNextHighMonotonicCount()** function returns the next high 32 bits of the platform's monotonic counter.

The platform's monotonic counter is comprised of two 32-bit quantities: the high 32 bits and the low 32 bits. During boot service time the low 32-bit value is volatile: it is reset to zero on every system reset and is increased by 1 on every call to

**GetNextMonotonicCount()**. The high 32-bit value is nonvolatile and is increased by 1 whenever the system resets, whenever **GetNextHighMonotonicCount()** is called, or whenever the low 32-bit count (returned by **GetNextMonotonicCount()**) overflows.

The [EFI\\_BOOT\\_SERVICES.GetNextMonotonicCount\(\)](#) function is only available at boot services time. If the operating system wishes to extend the platform monotonic counter to runtime, it may do so by utilizing **GetNextHighMonotonicCount()**. To do this, before calling [EFI\\_BOOT\\_SERVICES.ExitBootServices\(\)](#) the operating system would call **GetNextMonotonicCount()** to obtain the current platform monotonic count. The operating system would then provide an interface that returns the next count by:

- Adding 1 to the last count.
- Before the lower 32 bits of the count overflows, call **GetNextHighMonotonicCount()**. This will increase the high 32 bits of the platform's nonvolatile portion of the monotonic count by 1.

This function may only be called at Runtime.

### Status Codes Returned

EFI_SUCCESS	The next high monotonic count was returned.
EFI_DEVICE_ERROR	The device is not functioning properly.
EFI_INVALID_PARAMETER	<i>HighCount</i> is <b>NULL</b> .

### 8.5.3 Update Capsule

This runtime function allows a caller to pass information to the firmware. Update Capsule is commonly used to update the firmware FLASH or for an operating system to have information persist across a system reset.



## UpdateCapsule()

### Summary

Passes capsules to the firmware with both virtual and physical mapping. Depending on the intended consumption, the firmware may process the capsule immediately. If the payload should persist across a system reset, the reset value returned from *EfiQueryCapsuleCapabilities* must be passed into [ResetSystem\(\)](#) and will cause the capsule to be processed by the firmware as part of the reset process.

### Prototype

```
typedef
EFI_STATUS
UpdateCapsule (
  IN EFI_CAPSULE_HEADER **CapsuleHeaderArray,
  IN UINTN CapsuleCount,
  IN EFI_PHYSICAL_ADDRESS ScatterGatherList OPTIONAL
);
```

### Parameters

<i>CapsuleHeaderArray</i>	Virtual pointer to an array of virtual pointers to the capsules being passed into update capsule. Each capsules is assumed to stored in contiguous virtual memory. The capsules in the <i>CapsuleHeaderArray</i> must be the same capsules as the <i>ScatterGatherList</i> . The <i>CapsuleHeaderArray</i> must have the capsules in the same order as the <i>ScatterGatherList</i> .
<i>CapsuleCount</i>	Number of pointers to <b>EFI_CAPSULE_HEADER</b> in <i>CapsuleHeaderArray</i> .
<i>ScatterGatherList</i>	Physical pointer to a set of <b>EFI_CAPSULE_BLOCK_DESCRIPTOR</b> that describes the location in physical memory of a set of capsules. See "Related Definitions" for an explanation of how more than one capsule is passed via this interface. The capsules in the <i>ScatterGatherList</i> must be in the same order as the <i>CapsuleHeaderArray</i> . This parameter is only referenced if the capsules are defined to persist across system reset.

### Related Definitions

```
typedef struct {
  UINT64 Length;
  union {
    EFI_PHYSICAL_ADDRESS DataBlock;
    EFI_PHYSICAL_ADDRESS ContinuationPointer;
  }Union;
} EFI_CAPSULE_BLOCK_DESCRIPTOR;
```

<i>Length</i>	Length in bytes of the data pointed to by <i>DataBlock/ContinuationPointer</i> .
<i>DataBlock</i>	Physical address of the data block. This member of the union is used if <i>Length</i> is not equal to zero.
<i>ContinuationPointer</i>	Physical address of another block of <b>EFI_CAPSULE_BLOCK_DESCRIPTOR</b> structures. This member of the union is used if <i>Length</i> is equal to zero. If <i>ContinuationPointer</i> is zero this entry represents the end of the list.

This data structure defines the *ScatterGatherList* list the OS passes to the firmware. *ScatterGatherList* represents an array of structures and is terminated with a structure member whose *Length* is 0 and *DataBlock* physical address is 0. If *Length* is 0 and *DataBlock* physical address is not 0, the specified physical address is known as a “continuation pointer” and it points to a further list of **EFI\_CAPSULE\_BLOCK\_DESCRIPTOR** structures. A continuation pointer is used to allow the scatter gather list to be contained in physical memory that is not contiguous. It also is used to allow more than a single capsule to be passed at one time.

```
typedef struct {
    EFI_GUID CapsuleGuid;
    UINT32 HeaderSize;
    UINT32 Flags;
    UINT32 CapsuleImageSize;
} EFI_CAPSULE_HEADER;
```

<i>CapsuleGuid</i>	A GUID that defines the contents of a capsule.
<i>HeaderSize</i>	The size of the capsule header. This may be larger than the size of the <b>EFI_CAPSULE_HEADER</b> since <i>CapsuleGuid</i> may imply extended header entries.
<i>Flags</i>	Bit-mapped list describing the capsule attributes. The Flag values of 0x0000 – 0xFFFF are defined by <i>CapsuleGuid</i> . Flag values of 0x10000 – 0xFFFFFFFF are defined by this specification
<i>CapsuleImageSize</i>	Size in bytes of the capsule.

```
#define CAPSULE_FLAGS_PERSIST_ACROSS_RESET 0x00010000
#define CAPSULE_FLAGS_POPULATE_SYSTEM_TABLE 0x00020000
#define CAPSULE_FLAGS_INITIATE_RESET 0x00040000
```

**Note:** A capsule which has the *CAPSULE\_FLAGS\_INITIATE\_RESET* Flag must have *CAPSULE\_FLAGS\_PERSIST\_ACROSS\_RESET* set in its header as well. Firmware that encounters a capsule which has the *CAPSULE\_FLAGS\_INITIATE\_RESET* Flag set in its header will initiate a reset

*of the platform which is compatible with the passed-in capsule request and will not return back to the caller.*

## Description

The **UpdateCapsule()** function allows the operating system to pass information to firmware. The **UpdateCapsule()** function supports passing capsules in operating system virtual memory back to firmware. Each capsule is contained in a contiguous virtual memory range in the operating system, but both a virtual and physical mapping for the capsules are passed to the firmware.

If a capsule has the **CAPSULE\_FLAGS\_PERSIST\_ACROSS\_RESET** *Flag* set in its header, the firmware will process the capsules after system reset. The caller must ensure to reset the system using the required reset value obtained from **QueryCapsuleCapabilities**. If this flag is not set, the firmware will process the capsules immediately.

A capsule which has the **CAPSULE\_FLAGS\_POPULATE\_SYSTEM\_TABLE** *Flag* must have **CAPSULE\_FLAGS\_PERSIST\_ACROSS\_RESET** set in its header as well. Firmware that processes a capsule that has the **CAPSULE\_FLAGS\_POPULATE\_SYSTEM\_TABLE** *Flag* set in its header will coalesce the contents of the capsule from the **ScatterGatherList** into a contiguous buffer and must then place a pointer to this coalesced capsule in the **EFI System Table** after the system has been reset. Agents searching for this capsule will look in the **EFI\_CONFIGURATION\_TABLE** and search for the capsule's **GUID** and associated pointer to retrieve the data after the reset.

Table 38. Flag Firmware Behavior

Flags	Firmware Behavior
No Specification defined flags	Firmware attempts to immediately processes or launch the capsule. If capsule is not recognized, can expect an error.
CAPSULE_FLAGS_PERSIST_ACROSS_RESET	Firmware will attempt to process or launch the capsule across a reset. If capsule is not recognized, can expect an error. If the processing requires a reset which is unsupported by the platform, expect an error.
CAPSULE_FLAGS_PERSIST_ACROSS_RESET + CAPSULE_FLAGS_POPULATE_SYSTEM_TABLE	Firmware will coalesce the capsule from the ScatterGatherList into a contiguous buffer and place a pointer to the coalesced capsule in the EFI System Table. Platform recognition of the capsule type is not required. If the action requires a reset which is unsupported by the platform, expect an error.
CAPSULE_FLAGS_PERSIST_ACROSS_RESET + CAPSULE_FLAGS_INITIATE_RESET	Firmware will attempt to process or launch the capsule across a reset. The firmware will initiate a reset which is compatible with the passed-in capsule request and will not return back to the caller. If the capsule is not recognized, can expect an error. If the processing requires a reset which is unsupported by the platform, expect an error.
CAPSULE_FLAGS_PERSIST_ACROSS_RESET + CAPSULE_FLAGS_INITIATE_RESET + CAPSULE_FLAGS_POPULATE_SYSTEM_TABLE	The firmware will initiate a reset which is compatible with the passed-in capsule request and not return back to the caller. Upon resetting, the firmware will coalesce the capsule from the ScatterGatherList into a contiguous buffer and place a pointer to the coalesced capsule in the EFI System Table. Platform recognition of the capsule type is not required. If the action requires a reset which is unsupported by the platform, expect an error.

The EFI System Table entry must use the GUID from the **CapsuleGuid** field of the **EFI\_CAPSULE\_HEADER**. The EFI System Table entry must point to an array of capsules that contain the same **CapsuleGuid** value. The array must be prefixed by a **UINT32** that represents the size of the array of capsules.

The set of capsules is pointed to by **ScatterGatherList** and **CapsuleHeaderArray** so the firmware will know both the physical and virtual addresses of the operating system allocated buffers. The scatter-gather list supports the situation where the virtual address range of a capsule is contiguous, but the physical addresses are not.

If any of the capsules that are passed into this function encounter an error, the entire set of capsules will not be processed and the error encountered will be returned to the caller.

## Status Codes Returned

EFI_SUCCESS	Valid capsule was passed. If CAPSULE_FLAGS_PERSIST_ACROSS_RESET is not set, the capsule has been successfully processed by the firmware.
EFI_INVALID_PARAMETER	<i>CapsuleSize</i> , or an incompatible set of flags were set in the capsule header.
EFI_INVALID_PARAMETER	<i>CapsuleCount</i> is 0
EFI_DEVICE_ERROR	The capsule update was started, but failed due to a device error.
EFI_UNSUPPORTED	The capsule type is not supported on this platform.
EFI_OUT_OF_RESOURCES	When <b>ExitBootServices()</b> has been previously called this error indicates the capsule is compatible with this platform but is not capable of being submitted or processed in runtime. The caller may resubmit the capsule prior to <b>ExitBootServices()</b> .
EFI_OUT_OF_RESOURCES	When <b>ExitBootServices()</b> has not been previously called then this error indicates the capsule is compatible with this platform but there are insufficient resources to process.

### 8.5.3.1 Capsule Definition

A capsule is simply a contiguous set of data that starts with an **EFI\_CAPSULE\_HEADER**. The *CapsuleGuid* field in the header defines the format of the capsule.

The capsule contents are designed to be communicated from an OS-present environment to the system firmware. To allow capsules to persist across system reset, a level of indirection is required for the description of a capsule, since the OS primarily uses virtual memory and the firmware at boot time uses physical memory. This level of abstraction is accomplished via the **EFI\_CAPSULE\_BLOCK\_DESCRIPTOR**. The **EFI\_CAPSULE\_BLOCK\_DESCRIPTOR** allows the OS to allocate contiguous virtual address space and describe this address space to the firmware as a discontinuous set of physical address ranges. The firmware is passed both physical and virtual addresses and pointers to describe the capsule so the firmware can process the capsule immediately or defer processing of the capsule until after a system reset.

In most instruction sets and OS architecture, allocation of physical memory is possible only on a “page” granularity (which can range for 4 KiB to at least 1 MiB). The **EFI\_CAPSULE\_BLOCK\_DESCRIPTOR** must have the following properties to ensure the safe and well defined transition of the data:

- Each new capsule must start on a new page of memory.
- All pages except for the last must be completely filled by the capsule.
  - It is legal to pad the header to make it consume an entire page of data to enable the passing of page aligned data structures via a capsule. The last page must have at least one byte of capsule in it.
- Pages must be naturally aligned

- Pages may not overlap on another
- Firmware may never make an assumption about the page sizes the operating system is using.

Multiple capsules can be concatenated together and passed via a single call to **UpdateCapsule()**. The physical address description of capsules are concatenated by converting the terminating **EFI\_CAPSULE\_BLOCK\_DESCRIPTOR** entry of the 1<sup>st</sup> capsule into a continuation pointer by making it point to the **EFI\_CAPSULE\_BLOCK\_DESCRIPTOR** that represents the start of the 2<sup>nd</sup> capsule. There is only a single terminating **EFI\_CAPSULE\_BLOCK\_DESCRIPTOR** entry and it is at the end of the last capsule in the chain.

The following algorithm must be used to find multiple capsules in a single scatter gather list:

- Look at the capsule header to determine the size of the capsule
  - The first Capsule header is always pointed to by the first **EFI\_CAPSULE\_BLOCK\_DESCRIPTOR** entry
- Walk the **EFI\_CAPSULE\_BLOCK\_DESCRIPTOR** list keeping a running count of the size each entry represents.
- If the **EFI\_CAPSULE\_BLOCK\_DESCRIPTOR** entry is a continuation pointer and the running current capsule size count is greater than or equal to the size of the current capsule this is the start of the next capsule.
- Make the new capsules the current capsule and repeat the algorithm.

[Figure 27](#) shows a Scatter-Gather list of **EFI\_CAPSULE\_BLOCK\_DESCRIPTOR** structures that describes two capsules. The left side of the figure shows OS view of the capsules as two separate contiguous virtual memory buffers. The center of the figure shows the layout of the data in system memory. The right hand side of the figure shows the *ScatterGatherList* list passed into the firmware. Since there are two capsules two independent **EFI\_CAPSULE\_BLOCK\_DESCRIPTOR** lists exist that were joined together via a continuation pointer in the first list.

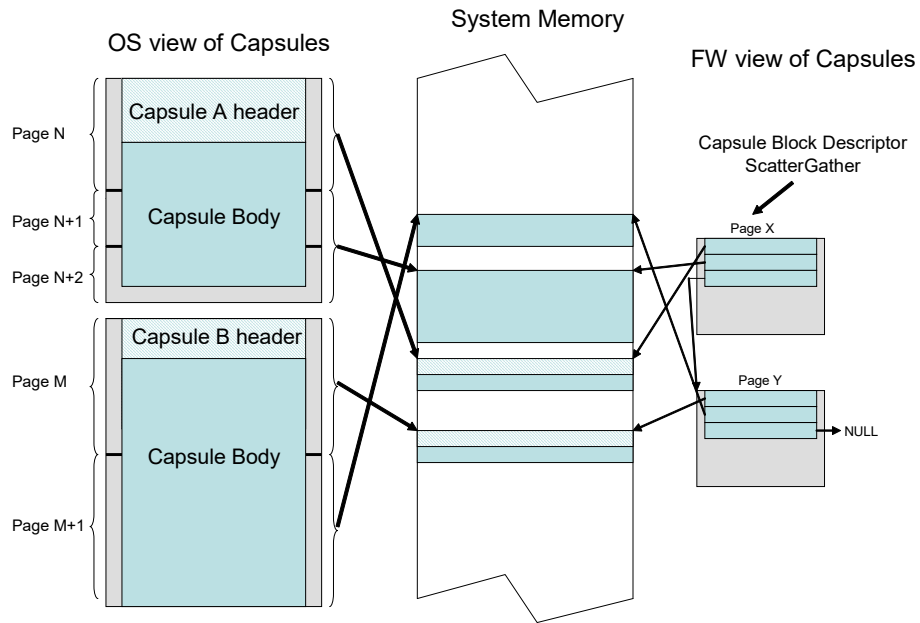

Figure 27. Scatter-Gather List of EFI\_CAPSULE\_BLOCK\_DESCRIPTOR Structures

## QueryCapsuleCapabilities()

### Summary

Returns if the capsule can be supported via **UpdateCapsule()**.

### Prototype

```
typedef
EFI_STATUS
QueryCapsuleCapabilities (
  IN EFI_CAPSULE_HEADER **CapsuleHeaderArray,
  IN UINTN CapsuleCount,
  OUT UINT64 *MaximumCapsuleSize,
  OUT EFI_RESET_TYPE *ResetType
);
```

#### *CapsuleHeaderArray*

Virtual pointer to an array of virtual pointers to the capsules being passed into update capsule. The capsules are assumed to stored in contiguous virtual memory.

#### *CapsuleCount*

Number of pointers to **EFI\_CAPSULE\_HEADER** in *CapsuleHeaderArray*.

#### *MaximumCapsuleSize*

On output the maximum size in bytes that **UpdateCapsule()** can support as an argument to **UpdateCapsule()** via *CapsuleHeaderArray* and *ScatterGatherList*. Undefined on input.

#### *ResetType*

Returns the type of reset required for the capsule update. Undefined on input.

### Description

The **QueryCapsuleCapabilities()** function allows a caller to test to see if a capsule or capsules can be updated via **UpdateCapsule()**. The Flags values in the capsule header and size of the entire capsule is checked.

If the caller needs to query for generic capsule capability a fake **EFI\_CAPSULE\_HEADER** can be constructed where *CapsuleImageSize* is equal to *HeaderSize* that is equal to sizeof (**EFI\_CAPSULE\_HEADER**). To determine reset requirements, **CAPSULE\_FLAGS\_PERSIST\_ACROSS\_RESET** should be set in the *Flags* field of the **EFI\_CAPSULE\_HEADER**.



## Status Codes Returned

EFI_SUCCESS	Valid answer returned.
EFI_INVALID_PARAMETER	<i>MaximumCapsuleSize</i> is <b>NULL</b> .
EFI_UNSUPPORTED	The capsule type is not supported on this platform, and <i>MaximumCapsuleSize</i> and <i>ResetType</i> are undefined.
EFI_OUT_OF_RESOURCES	When <b>ExitBootServices()</b> has been previously called this error indicates the capsule is compatible with this platform but is not capable of being submitted or processed in runtime. The caller may resubmit the capsule prior to <b>ExitBootServices()</b> .
EFI_OUT_OF_RESOURCES	When <b>ExitBootServices()</b> has not been previously called then this error indicates the capsule is compatible with this platform but there are insufficient resources to process.

### 8.5.4 Exchanging information between the OS and Firmware

The firmware and an Operating System may exchange information through the *OsIndicationsSupported* and the *OSIndications* variables as follows:

- The *OsIndications* variable returns a UINT64 bitmask owned by the OS and is used to indicate which features the OS wants firmware to enable or which actions the OS wants the firmware to take. The OS will supply this data with a **SetVariable()** call.
- The *OsIndicationsSupported* variable returns a UINT64 bitmask owned by the firmware and indicates which of the OS indication features and actions that the firmware supports. This variable is recreated by firmware every boot, and cannot be modified by the OS.

The **EFI\_OS\_INDICATIONS\_BOOT\_TO\_FW\_UI** bit can be set in the *OsIndicationsSupported* variable by the firmware, if the firmware supports OS requests to stop at a firmware user interface. The **EFI\_OS\_INDICATIONS\_BOOT\_TO\_FW\_UI** bit can be set by the OS in the *OsIndications* variable, if the OS desires for the firmware to stop at a firmware user interface on the next boot. Once the firmware consumes this bit in the *OsIndications* variable and stops at the firmware user interface, the firmware should clear the bit from the *OsIndications* variable in order to acknowledge to the OS that the information was consumed and, more importantly, to prevent the firmware user interface from showing again on subsequent boots.

The **EFI\_OS\_INDICATIONS\_TIMESTAMP\_REVOCATION** bit can be set in the *OsIndicationsSupported* variable by the firmware, if the firmware supports timestamp based revocation and the "dbt" authorized timestamp database variable.

The **EFI\_OS\_INDICATIONS\_FMP\_CAPSULE\_SUPPORTED** bit is set in *OsIndicationsSupported* variable if platform supports processing of Firmware Management Protocol update capsule as defined in [Section 23.2](#). If set in *OsIndications* variable, the **EFI\_OS\_INDICATIONS\_FMP\_CAPSULE\_SUPPORTED** bit has no function and is cleared on the next reboot.

The **EFI\_OS\_INDICATIONS\_FILE\_CAPSULE\_DELIVERY\_SUPPORTED** bit in *OsIndicationsSupported* variable is set if platform supports processing of file capsules per [Section 8.5.5](#).

When submitting capsule via the Mass Storage Device method of [Section 8.5.5](#), the bit **EFI\_OS\_INDICATIONS\_FILE\_CAPSULE\_DELIVERY\_SUPPORTED** in *OsIndications* variable must be set by submitter to trigger processing of submitted capsule on next reboot. This bit will be cleared from *OsIndications* by system firmware in all cases during processing following reboot.

The **EFI\_OS\_INDICATIONS\_CAPSULE\_RESULT\_VAR\_SUPPORTED** bit is set in *OsIndicationsSupported* variable if platform supports reporting of deferred capsule processing by creation of result variable as defined in [Section 8.5.6](#). This bit has no function if set in *OsIndications*.

The **EFI\_OS\_INDICATIONS\_START\_OS\_RECOVERY** bit is set in the *OsIndicationsSupported* variable if the platform supports both the ability for an OS to indicate that OS-defined recovery should commence upon reboot, as well as support for the short-form File Path Media Device Path (see [Section 3.1.2](#)). If this bit is set in *OsIndications*, the platform firmware must bypass processing of the *BootOrder* variable during boot, and skip directly to OS-defined recovery (see [Section 3.4.1](#)) followed by Platform-defined recovery (see [Section 3.4.2](#)). System firmware must clear this bit in *OsIndications* when it starts OS-defined recovery.

The **EFI\_OS\_INDICATIONS\_START\_PLATFORM\_RECOVERY** bit is set in the *OsIndicationsSupported* variable if the platform supports both the ability for an OS to indicate that Platform-defined recovery should commence upon reboot, as well as support for the short-form File Path Media Device Path (see [Section 3.1.2](#)). If this bit is set in *OsIndications*, the platform firmware must bypass processing of the *BootOrder* variable during boot, and skip directly to platform-defined recovery (see [Section 3.4.2](#)). System firmware must clear this bit in *OsIndications* when it starts Platform-defined recovery.

In all cases, if either of **EFI\_OS\_INDICATIONS\_START\_OS\_RECOVERY** or **EFI\_OS\_INDICATIONS\_START\_PLATFORM\_RECOVERY** is set in *OsIndicationsSupported*, both must be set and supported.

## Related Definitions

```
#define EFI_OS_INDICATIONS_BOOT_TO_FW_UI 0x0000000000000001

#define EFI_OS_INDICATIONS_TIMESTAMP_REVOCATION \
0x0000000000000002

#define EFI_OS_INDICATIONS_FILE_CAPSULE_DELIVERY_SUPPORTED \
0x0000000000000004

#define EFI_OS_INDICATIONS_FMP_CAPSULE_SUPPORTED \
0x0000000000000008

#define EFI_OS_INDICATIONS_CAPSULE_RESULT_VAR_SUPPORTED \
0x0000000000000010

#define EFI_OS_INDICATIONS_START_OS_RECOVERY 0x0000000000000020

#define EFI_OS_INDICATIONS_START_PLATFORM_RECOVERY \
0x0000000000000040
```

### 8.5.5 Delivery of Capsules via file on Mass Storage device

As an alternative to the `UpdateCapsule()` runtime API, capsules of any type supported by platform may also be delivered to firmware via a file within the EFI system partition on the mass storage device targeted for boot. Capsules staged using this method are processed on the next system restart. This method is only available when booting from mass storage devices which are formatted with GPT ([Section 5.3](#)) and contain an EFI System Partition in the device image. System firmware will search for capsule when `EFI_OS_INDICATIONS_FILE_CAPSULE_DELIVERY_SUPPORTED` bit in *OsIndications* is set as described in [Section 8.5.4](#).

The directory `\EFI\UpdateCapsule` (letter case ignored) within the active EFI System Partition is defined for delivery of capsule to firmware. The binary structure of a capsule file on mass storage device is identical to the contents of capsule delivered via the EFI RunTime API except that fragmentation using `EFI_CAPSULE_BLOCK_DESCRIPTOR` is not supported and the single capsule must be stored in contiguous bytes within the file starting with `EFI_CAPSULE_HEADER`. The size of the file must equal `EFI_CAPSULE_HEADER.CapsuleImageSize` or error will be generated and the capsule ignored. Only a single capsule with a single `EFI_CAPSULE_HEADER` may be submitted within a file but more than one file each containing a capsule may be submitted during a single restart.

The file name of the capsule shall be chosen by submitter using 8-bit ASCII characters appropriate to the file system of the EFI system partition ([Section 13.3.1](#)). After examination and processing of a file placed in this directory the file will (if possible) be deleted by firmware. The deletion is performed in case of successful processing and also in the case of error but failure to successfully delete is not itself a reportable error.

More than one capsule file each containing a single capsule image may be stored in the specified directory. In case of multiple files, the system firmware shall process files in alphabetical order using sort based on CHAR16 numerical value of file name characters, compared left to right. Lower case letter characters will be converted to upper case before compare. When comparing file names of unequal length, the space character shall be used to pad shorter file names. In case of file name containing one or more period characters (.), the right-most period, and the text to the right of the right-most period in the file name, will be removed before compare. In case of any file names with identical text after excluding any text after the right-most period, the order of processing shall be determined by sorting of any text found to right of the right-most period in file name string.

If a capsule processing is terminated by error any remaining additional capsule files will be processed normally.

The directory **\EFI\UpdateCapsule** is checked for capsules only within the EFI system partition on the device specified in the active boot option determine by reference to **BootNext** variable or **BootOrder** variable processing. The active Boot Variable is the variable with highest priority **BootNext** or within **BootOrder** that refers to a device found to be present. Boot variables in **BootOrder** but referring to devices not present are ignored when determining active boot variable.

The device to be checked for **\EFI\UpdateCapsule** is identified by reference to **FilePathList** field within the selected active **Boot####** variable. The system firmware is not required to check mass storage devices that do not contain boot target that is highest priority for boot nor to check a second EFI system partition not the target of the active boot variable.

In all cases that a capsule is identified for processing the system is restarted after capsule processing is completed. In case where **BootNext** variable was set, this variable is cleared when capsule processing is performed without actual boot of the variable indicated.

### 8.5.6 UEFI variable reporting on the Success or any Errors encountered in processing of capsules after restart

In cases where the processing of capsules is (1) delivered by call to **UpdateCapsule()** API but deferred to next restart, or (2) when capsules are delivered via mass storage device, a UEFI variable is created by firmware to indicate to capsule provider the status of the capsule processing. In the case were multiple capsules are delivered in calls to **UpdateCapsule()**, or multiple files on disk as described in [Section 8.5.5](#), or when a capsule contains multiple payloads as described in [Section 23.2](#), a separate result variable will be created for each capsule payload processed. The firmware will over-write result variables when calculated variable name already exists. However, to avoid unnecessarily consuming system variable store the result variable should be deleted by capsule provider after result status is examined.

UEFI variable reports will not be used when the entirety of capsule processing occurs within the call to **UpdateCapsule()** function.

The reporting variable attributes will be **EFI\_VARIABLE\_NON\_VOLATILE + EFI\_VARIABLE\_BOOTSERVICE\_ACCESS + EFI\_VARIABLE\_RUNTIME\_ACCESS**.

The Vendor GUID of the reporting variable will be **EFI\_CAPSULE\_REPORT\_GUID**. The name of the reporting variable will be *CapsuleNNNN* where *NNNN* is 4-digit hex number chosen by the firmware. The values of *NNNN* will be incremented by firmware starting at *Capsule0000* and continuing up to the platform-defined maximum.

The platform will publish the platform maximum in a read-only variable named **EFI\_CAPSULE\_REPORT\_GUID:CapsuleMax**. The contents of *CapsuleMax* will be the string "CapsuleNNNN" where *NNNN* is the highest value used by platform before rolling over to *Capsule0000*. The platform will also publish the name of the last variable created in **EFI\_CAPSULE\_REPORT\_GUID:CapsuleLast**.

When creating a new result variable, any previous variable with the same name will be overwritten. In case where variable storage is limited system firmware may optionally delete oldest report variables to create free space. If sufficient variable space cannot be freed the variable is not created.

**Table 39. Variables Using EFI\_CAPSULE\_REPORT\_GUID**

Variable Name	Attributes	Internal Format
Capsule0000, Capsule0001, ... up to max	NV, BS, RT	EFI_CAPSULE_RESULT_VARIABLE
CapsuleMax	BS, RT, Read-Only	CHAR16[11] (no zero terminator)
CapsuleLast	NV, BS, RT, Read-Only	CHAR16[11] (no zero terminator)

## EFI\_CAPSULE\_REPORT\_GUID

```
// {39B68C46-F7FB-441B-B6EC-16B0F69821F3}
#define EFI_CAPSULE_REPORT_GUID \
{ 0x39b68c46, 0xf7fb, 0x441b, \
  {0xb6, 0xec, 0x16, 0xb0, 0xf6, 0x98, 0x21, 0xf3 } };
```

## Structure of the Capsule Processing Result Variable

The Capsule Processing Result Variable contents always begin with the **EFI\_CAPSULE\_RESULT\_VARIABLE\_HEADER** structure. The value of *CapsuleGuid* determines any additional data that may follow within the instance of the Result Variable contents. For some values of *CapsuleGuid* no additional data may be defined.

As noted below, *VariableTotalSize* is the size of complete result variable including the entire header and any additional data required for particular *CapsuleGuid* types.

```
typedef struct {
    UINT32  VariableTotalSize;
    UINT32  Reserved; //for alignment
    EFI_GUID CapsuleGuid;
    EFI_TIME CapsuleProcessed;
    EFI_STATUS CapsuleStatus;
} EFI_CAPSULE_RESULT_VARIABLE_HEADER;
```

*VariableTotalSize*

Size in bytes of the variable including any data beyond header as specified by *CapsuleGuid*.

*CapsuleGuid*

Guid from **EFI\_CAPSULE\_HEADER**

*CapsuleProcessed*

Timestamp using system time when processing completed.

*CapsuleStatus*

Result of the capsule processing. Exact interpretation of any error code may depend upon type of capsule processed.

### Additional Structure When CapsuleGuid is EFI\_FIRMWARE\_MANAGEMENT\_CAPSULE\_ID\_GUID

The Capsule Processing Result Variable contents always begin with **EFI\_CAPSULE\_RESULT\_VARIABLE\_HEADER**. When *CapsuleGuid* is **EFI\_FIRMWARE\_MANAGEMENT\_CAPSULE\_ID\_GUID**, the header is followed by additional data as defined by **EFI\_CAPSULE\_RESULT\_VARIABLE\_FMP**.

```
typedef struct {
    UINT16  Version;
    UINT8   PayloadIndex;
    UINT8   UpdateImageIndex;

    EFI_GUID UpdateImageTypeId;
    // CHAR16 CapsuleFileName[];
    // CHAR16 CapsuleTarget[];
} EFI_CAPSULE_RESULT_VARIABLE_FMP;
```

*Version*

The version of this structure, currently 0x00000001.

*PayloadIndex*

The index, starting from zero, of the payload within the FMP capsule which was processed to generate this report.

*UpdateImageIndex*

The *UpdateImageIndex* from **EFI\_FIRMWARE\_MANAGEMENT\_CAPSULE\_IMAGE\_HEADER** (after unsigned conversion from UINT8 to UINT16).

<i>UpdateImageTypeId</i>	The <i>UpdateImageTypeId</i> Guid from <b>EFI_FIRMWARE_MANAGEMENT_CAPSULE_IMAGE_HEADER</b> .
<i>CapsuleFileName</i>	In case of capsule loaded from disk, the zero-terminated array containing file name of capsule that was processed. In case of capsule submitted directly to <b>UpdateCapsule()</b> there is no file name, and this field is required to contain a single 16-bit zero character which is included in <i>VariableTotalSize</i> .
<i>CapsuleTarget</i>	This field will contain a zero-terminated CHAR16 string containing the text representation of the device path of device publishing Firmware Management Protocol (if present). In case where device path is not present and the target is not otherwise known to firmware, or when payload was blocked by policy, or skipped, this field is required to contain a single 16-bit zero character which is included in <i>VariableTotalSize</i> .

### Status Codes Returned in *CapsuleStatus*

EFI_SUCCESS	Valid capsule was passed and the capsule has been successfully processed by the firmware.
EFI_INVALID_PARAMETER	Invalid <i>CapsuleSize</i> , or an incompatible set of flags were set in the capsule header. In the case of a capsule file, the file size was not valid or an error was detected in the internal structure of the file.
EFI_DEVICE_ERROR	The capsule update was started, but failed due to a device error.
EFI_ACCESS_DENIED	Image within capsule was not loaded because the platform policy prohibits the image from being loaded.
EFI_LOAD_ERROR	For capsule with included driver, no driver with correct format for the platform was found.
EFI_UNSUPPORTED	The capsule type is not supported on this platform. Or the capsule internal structures were not recognized as valid by the platform.
EFI_OUT_OF_RESOURCES	There were insufficient resources to process the capsule.
EFI_NOT_READY	Capsule payload blocked by platform policy.
EFI_ABORTED	Capsule payload was skipped.





## 9 Protocols — EFI Loaded Image

---

This section defines **EFI\_LOADED\_IMAGE\_PROTOCOL** and the **EFI\_LOADED\_IMAGE\_DEVICE\_PATH\_PROTOCOL**. Respectively, these protocols describe an Image that has been loaded into memory and specifies the device path used when a PE/COFF image was loaded through the EFI Boot Service **LoadImage()**. These descriptions include the source from which the image was loaded, the current location of the image in memory, the type of memory allocated for the image, and the parameters passed to the image when it was invoked.

### 9.1 EFI Loaded Image Protocol

#### EFI\_LOADED\_IMAGE\_PROTOCOL

##### Summary

Can be used on any image handle to obtain information about the loaded image.

##### GUID

```
#define EFI_LOADED_IMAGE_PROTOCOL_GUID\
{0x5B1B31A1,0x9562,0x11d2,\
{0x8E,0x3F,0x00,0xA0,0xC9,0x69,0x72,0x3B}}
```

##### Revision Number

```
#define EFI_LOADED_IMAGE_PROTOCOL_REVISION 0x1000
```

##### Protocol Interface Structure

```
typedef struct {
    UINT32      Revision;
    EFI_HANDLE  ParentHandle;
    EFI_SYSTEM_TABLE *SystemTable;

    // Source location of the image
    EFI_HANDLE  DeviceHandle;
    EFI_DEVICE_PATH_PROTOCOL *FilePath;
    VOID        *Reserved;

    // Image's load options
    UINT32      LoadOptionsSize;
    VOID        *LoadOptions;
```

```
// Location where image was loaded
VOID      *ImageBase;
UINT64    ImageSize;
EFI_MEMORY_TYPE  ImageCodeType;
EFI_MEMORY_TYPE  ImageDataType;
EFI_IMAGE_UNLOAD  Unload;
} EFI_LOADED_IMAGE_PROTOCOL;
```

## Parameters

<i>Revision</i>	Defines the revision of the <b>EFI_LOADED_IMAGE_PROTOCOL</b> structure. All future revisions will be backward compatible to the current revision.
<i>ParentHandle</i>	Parent image's image handle. <b>NULL</b> if the image is loaded directly from the firmware's boot manager. Type <b>EFI_HANDLE</b> is defined in <a href="#">Section 7</a> .
<i>SystemTable</i>	The image's EFI system table pointer. Type <b>EFI_SYSTEM_TABLE</b> is defined in <a href="#">Section 4</a> .
<i>DeviceHandle</i>	The device handle that the EFI Image was loaded from. Type <b>EFI_HANDLE</b> is defined in <a href="#">Section 7</a> .
<i>FilePath</i>	A pointer to the file path portion specific to <i>DeviceHandle</i> that the EFI Image was loaded from. <b>EFI_DEVICE_PATH_PROTOCOL</b> is defined in <a href="#">Section 10.2</a> .
<i>Reserved</i>	Reserved. DO NOT USE.
<i>LoadOptionsSize</i>	The size in bytes of <i>LoadOptions</i> .
<i>LoadOptions</i>	A pointer to the image's binary load options.
<i>ImageBase</i>	The base address at which the image was loaded.
<i>ImageSize</i>	The size in bytes of the loaded image.
<i>ImageCodeType</i>	The memory type that the code sections were loaded as. Type <b>EFI_MEMORY_TYPE</b> is defined in <a href="#">Section 7</a> .
<i>ImageDataType</i>	The memory type that the data sections were loaded as. Type <b>EFI_MEMORY_TYPE</b> is defined in <a href="#">Section 7</a> .
<i>Unload</i>	Function that unloads the image. See <a href="#">Unload()</a> .

## Description

Each loaded image has an image handle that supports **EFI\_LOADED\_IMAGE\_PROTOCOL**. When an image is started, it is passed the image handle for itself. The image can use the handle to obtain its relevant image data stored in the **EFI\_LOADED\_IMAGE\_PROTOCOL** structure, such as its load options.

## EFI\_LOADED\_IMAGE\_PROTOCOL.Unload()

### Summary

Unloads an image from memory.

### Prototype

```
typedef
EFI_STATUS
(EFIAPI *EFI_IMAGE_UNLOAD) (
    IN EFI_HANDLE ImageHandle,
);
```

### Parameters

*ImageHandle*

The handle to the image to unload. Type [EFI\\_HANDLE](#) is defined in [Section](#).

### Description

The **Unload()** function is a callback that a driver registers to do cleanup when the UnloadImage boot service function is called.

### Status Codes Returned

EFI_SUCCESS	The image was unloaded.
EFI_INVALID_PARAMETER	The <i>ImageHandle</i> was not valid.

## 9.2 EFI Loaded Image Device Path Protocol

### EFI\_LOADED\_IMAGE\_DEVICE\_PATH\_PROTOCOL

#### Summary

When installed, the Loaded Image Device Path Protocol specifies the device path that was used when a PE/COFF image was loaded through the EFI Boot Service **LoadImage()**.

#### GUID

```
#define EFI_LOADED_IMAGE_DEVICE_PATH_PROTOCOL_GUID \
    {0xbc62157e,0x3e33,0x4fec,\
    {0x99,0x20,0x2d,0x3b,0x36,0xd7,0x50,0xdf}}
```

#### Description

The Loaded Image Device Path Protocol uses the same protocol interface structure as the Device Path Protocol defined in Chapter 9. The only difference between the Device Path Protocol and the Loaded Image Device Path Protocol is the protocol GUID value.

The Loaded Image Device Path Protocol must be installed onto the image handle of a PE/COFF image loaded through the EFI Boot Service **LoadImage()**. A copy of the device path specified by the *DevicePath* parameter to the EFI Boot Service **LoadImage()** is made before it is installed onto the image handle. It is legal to call **LoadImage()** for a buffer in memory with a **NULL** *DevicePath* parameter. In this case, the Loaded Image Device Path Protocol is installed with a **NULL** interface pointer.

## 10 Protocols — Device Path Protocol

---

This section contains the definition of the device path protocol and the information needed to construct and manage device paths in the UEFI environment. A device path is constructed and used by the firmware to convey the location of important devices, such as the boot device and console, consistent with the software-visible topology of the system.

### 10.1 Device Path Overview

A *Device Path* is used to define the programmatic path to a device. The primary purpose of a Device Path is to allow an application, such as an OS loader, to determine the physical device that the interfaces are abstracting.

A collection of device paths is usually referred to as a name space. ACPI, for example, is rooted around a name space that is written in ASL (ACPI Source Language). Given that EFI does not replace ACPI and defers to ACPI when ever possible, it would seem logical to utilize the ACPI name space in EFI. However, the ACPI name space was designed for usage at operating system runtime and does not fit well in platform firmware or OS loaders. Given this, EFI defines its own name space, called a *Device Path*.

A Device Path is designed to make maximum leverage of the ACPI name space. One of the key structures in the Device Path defines the linkage back to the ACPI name space. The Device Path also is used to fill in the gaps where ACPI defers to buses with standard enumeration algorithms. The Device Path is able to relate information about which device is being used on buses with standard enumeration mechanisms. The Device Path is also used to define the location on a medium where a file should be, or where it was loaded from. A special case of the Device Path can also be used to support the optional booting of legacy operating systems from legacy media.

The Device Path was designed so that the OS loader and the operating system could tell which devices the platform firmware was using as boot devices. This allows the operating system to maintain a view of the system that is consistent with the platform firmware. An example of this is a “headless” system that is using a network connection as the boot device and console. In such a case, the firmware will convey to the operating system the network adapter and network protocol information being used as the console and boot device in the device path for these devices.

### 10.2 EFI Device Path Protocol

This section provides a detailed description of **EFI\_DEVICE\_PATH\_PROTOCOL**.

## EFI\_DEVICE\_PATH\_PROTOCOL

### Summary

Can be used on any device handle to obtain generic path/location information concerning the physical device or logical device. If the handle does not logically map to a physical device, the handle may not necessarily support the device path protocol. The device path describes the location of the device the handle is for. The size of the Device Path can be determined from the structures that make up the Device Path.

### GUID

```
#define EFI_DEVICE_PATH_PROTOCOL_GUID \
{0x09576e91,0x6d3f,0x11d2,\
{0x8e,0x39,0x00,0xa0,0xc9,0x69,0x72,0x3b}}
```

### Protocol Interface Structure

```
/**
// EFI_DEVICE_PATH_PROTOCOL
//
typedef struct _EFI_DEVICE_PATH_PROTOCOL {
    UINT8 Type;
    UINT8 SubType;
    UINT8 Length[2];
} EFI_DEVICE_PATH_PROTOCOL;
```

### Description

The executing UEFI Image may use the device path to match its own device drivers to the particular device. Note that the executing UEFI OS loader and UEFI application images must access all physical devices via Boot Services device handles until [EFI\\_BOOT\\_SERVICES.ExitBootServices\(\)](#) is successfully called. A UEFI driver may access only a physical device for which it provides functionality.

## 10.3 Device Path Nodes

There are six major types of Device Path nodes:

- Hardware Device Path. This Device Path defines how a device is attached to the resource domain of a system, where resource domain is simply the shared memory, memory mapped I/O, and I/O space of the system.
- ACPI Device Path. This Device Path is used to describe devices whose enumeration is not described in an industry-standard fashion. These devices must be described using ACPI AML in the ACPI name space; this Device Path is a linkage to the ACPI name space.
- Messaging Device Path. This Device Path is used to describe the connection of devices outside the resource domain of the system. This Device Path can describe physical

messaging information such as a SCSI ID, or abstract information such as networking protocol IP addresses.

- **Media Device Path.** This Device Path is used to describe the portion of a medium that is being abstracted by a boot service. For example, a Media Device Path could define which partition on a hard drive was being used.
- **BIOS Boot Specification Device Path.** This Device Path is used to point to boot legacy operating systems; it is based on the BIOS Boot Specification Version 1.01. Refer to [Appendix Q](#) for details on obtaining this specification.
- **End of Hardware Device Path.** Depending on the Sub-Type, this Device Path node is used to indicate the end of the Device Path instance or Device Path structure.

### 10.3.1 Generic Device Path Structures

A Device Path is a variable-length binary structure that is made up of variable-length generic Device Path nodes. [Table 40](#) defines the structure of a variable-length generic Device Path node and the lengths of its components. The table defines the type and sub-type values corresponding to the Device Paths described in [Section 10.3](#); all other type and sub-type values are *Reserved*.

**Table 40. Generic Device Path Node Structure**

Mnemonic	Byte Offset	Byte Length	Description
Type	0	1	Type 0x01 – Hardware Device Path Type 0x02 – ACPI Device Path Type 0x03 – Messaging Device Path Type 0x04 – Media Device Path Type 0x05 – BIOS Boot Specification Device Path Type 0x7F – End of Hardware Device Path
Sub-Type	1	1	Sub-Type – Varies by Type. (See <a href="#">Table 41</a> .)
Length	2	2	Length of this structure in bytes. Length is 4 + <i>n</i> bytes.
Specific Device Path Data	4	<i>n</i>	Specific Device Path data. Type and Sub-Type define type of data. Size of data is included in Length.

A Device Path is a series of generic Device Path nodes. The first Device Path node starts at byte offset zero of the Device Path. The next Device Path node starts at the end of the previous Device Path node. Therefore all nodes are byte-packed data structures that may appear on any byte boundary. All code references to device path nodes must assume all fields are unaligned. Since every Device Path node contains a length field in a known place, it is possible to traverse Device Path nodes that are of an unknown type. There is no limit to the number, type, or sequence of nodes in a Device Path.

A Device Path is terminated by an End of Hardware Device Path node. This type of node has two sub-types (see [Table 41](#)):

- *End This Instance of a Device Path* (sub-type 0x01). This type of node terminates one Device Path instance and denotes the start of another. This is only required when an

environment variable represents multiple devices. An example of this would be the **ConsoleOut** environment variable that consists of both a VGA console and serial output console. This variable would describe a console output stream that is sent to both VGA and serial concurrently and thus has a Device Path that contains two complete Device Paths.

- *End Entire Device Path* (sub-type 0xFF). This type of node terminates an entire Device Path. Software searches for this sub-type to find the end of a Device Path. All Device Paths must end with this sub-type.

**Table 41. Device Path End Structure**

Mnemonic	Byte Offset	Byte Length	Description
Type	0	1	Type 0x7F – End of Hardware Device Path
Sub-Type	1	1	Sub-Type 0xFF – End Entire Device Path, or Sub-Type 0x01 – End This Instance of a Device Path and start a new Device Path
Length	2	2	Length of this structure in bytes. Length is 4 bytes.

### 10.3.2 Hardware Device Path

This Device Path defines how a device is attached to the resource domain of a system, where resource domain is simply the shared memory, memory mapped I/O, and I/O space of the system. It is possible to have multiple levels of Hardware Device Path such as a PCCARD device that was attached to a PCCARD PCI controller.

#### 10.3.2.1 PCI Device Path

The Device Path for PCI defines the path to the PCI configuration space address for a PCI device. There is one PCI Device Path entry for each device and function number that defines the path from the root PCI bus to the device. Because the PCI bus number of a device may potentially change, a flat encoding of single PCI Device Path entry cannot be used. An example of this is when a PCI device is behind a bridge, and one of the following events occurs:

- OS performs a Plug and Play configuration of the PCI bus.
- A hot plug of a PCI device is performed.
- The system configuration changes between reboots.

The PCI Device Path entry must be preceded by an ACPI Device Path entry that uniquely identifies the PCI root bus. The programming of root PCI bridges is not defined by any PCI specification and this is why an ACPI Device Path entry is required.



Table 42. PCI Device Path

Mnemonic	Byte Offset	Byte Length	Description
Type	0	1	Type 1 – Hardware Device Path
Sub-Type	1	1	Sub-Type 1 – PCI
Length	2	2	Length of this structure is 6 bytes
Function	4	1	PCI Function Number
Device	5	1	PCI Device Number

### 10.3.2.2 PCCARD Device Path

Table 43. PCCARD Device Path

Mnemonic	Byte Offset	Byte Length	Description
Type	0	1	Type 1 – Hardware Device Path
Sub-Type	1	1	Sub-Type 2 – PCCARD
Length	2	2	Length of this structure in bytes. Length is 5 bytes.
Function Number	4	1	Function Number (0 = First Function)

### 10.3.2.3 Memory Mapped Device Path

Table 44. Memory Mapped Device Path

Mnemonic	Byte Offset	Byte Length	Description
Type	0	1	Type 1 – Hardware Device Path.
Sub-Type	1	1	Sub-Type 3 – Memory Mapped.
Length	2	2	Length of this structure in bytes. Length is 24 bytes.
Memory Type	4	4	<b>EFI_MEMORY_TYPE</b> . Type <b>EFI_MEMORY_TYPE</b> is defined in the <a href="#">EFI_BOOT_SERVICES.AllocatePages()</a> function description.
Start Address	8	8	Starting Memory Address.
End Address	16	8	Ending Memory Address.

### 10.3.2.4 Vendor Device Path

The Vendor Device Path allows the creation of vendor-defined Device Paths. A vendor must allocate a Vendor GUID for a Device Path. The Vendor GUID can then be used to define the contents on the  $n$  bytes that follow in the Vendor Device Path node.

**Table 45. Vendor-Defined Device Path**

Mnemonic	Byte Offset	Byte Length	Description
Type	0	1	Type 1 – Hardware Device Path.
Sub-Type	1	1	Sub-Type 4 – Vendor.
Length	2	2	Length of this structure in bytes. Length is 20 + <i>n</i> bytes.
Vendor_GUID	4	16	Vendor-assigned GUID that defines the data that follows.
Vendor Defined Data	20	<i>n</i>	Vendor-defined variable size data.

### 10.3.2.5 Controller Device Path

**Table 46. Controller Device Path**

Mnemonic	Byte Offset	Byte Length	Description
Type	0	1	Type 1 – Hardware Device Path.
Sub-Type	1	1	Sub-Type 5 – Controller.
Length	2	2	Length of this structure in bytes. Length is 8 bytes.
Controller Number	4	4	Controller number.

### 10.3.2.6 BMC Device Path

The Device Path for a Baseboard Management Controller (BMC) host interface.

**Table 47. BMC Device Path**

Mnemonic	Byte Offset	Byte Length	Description
Type	0	1	Type 1 – Hardware Device Path.
Sub-Type	1	1	Sub Type 6 – BMC
Length	2	2	Length of this structure in bytes. Length is 13 bytes.
Interface Type	4	1	The Baseboard Management Controller (BMC) host interface type:  0x00: Unknown 0x01: KCS: Keyboard Controller Style 0x02: SMIC: Server Management Interface Chip 0x03: BT: Block Transfer
Base Address	5	8	Base address (either memory-mapped or I/O) of the BMC. If the least-significant bit of the field is a 1, the address is in I/O space; otherwise, the address is memory-mapped. Refer to the IPMI Interface Specification for usage details.

### 10.3.3 ACPI Device Path

This Device Path contains ACPI Device IDs that represent a device’s Plug and Play Hardware ID and its corresponding unique persistent ID. The ACPI IDs are stored in the

ACPI \_HID, \_CID, and \_UID device identification objects that are associated with a device. The ACPI Device Path contains values that must match exactly the ACPI name space that is provided by the platform firmware to the operating system. Refer to the ACPI specification for a complete description of the \_HID, \_CID, and \_UID device identification objects.

The \_HID and \_CID values are optional device identification objects that appear in the ACPI name space. If only \_HID is present, the \_HID must be used to describe any device that will be enumerated by the ACPI driver. The \_CID, if present, contains information that is important for the OS to attach generic driver (e.g., PCI Bus Driver), while the \_HID contains information important for the OS to attach device-specific driver. The ACPI bus driver only enumerates a device when no standard bus enumerator exists for a device.

The \_UID object provides the OS with a serial number-style ID for a device that does not change across reboots. The object is optional, but is required when a system contains two devices that report the same \_HID. The \_UID only needs to be unique among all device objects with the same \_HID value. If no \_UID exists in the ACPI name space for a \_HID the value of zero must be stored in the \_UID field of the ACPI Device Path.

The ACPI Device Path is only used to describe devices that are not defined by a Hardware Device Path. An \_HID (along with \_CID if present) is required to represent a PCI root bridge, since the PCI specification does not define the programming model for a PCI root bridge. There are two subtypes of the ACPI Device Path: a simple subtype that only includes the \_HID and \_UID fields, and an extended subtype that includes the \_HID, \_CID, and \_UID fields.

The ACPI Device Path node only supports numeric 32-bit values for the \_HID and \_UID values. The Expanded ACPI Device Path node supports both numeric and string values for the \_HID, \_UID, and \_CID values. As a result, the ACPI Device Path node is smaller and should be used if possible to reduce the size of device paths that may potentially be stored in nonvolatile storage. If a string value is required for the \_HID field, or a string value is required for the \_UID field, or a \_CID field is required, then the Expanded ACPI Device Path node must be used. If a string field of the Expanded ACPI Device Path node is present, then the corresponding numeric field is ignored.

The \_HID and \_CID fields in the ACPI Device Path node and Expanded ACPI Device Path node are stored as a 32-bit compressed EISA-type IDs. The following macro can be used to compute these EISA-type IDs from a Plug and Play Hardware ID. The Plug and Play Hardware IDs used to compute the \_HID and \_CID fields in the EFI device path nodes must match the Plug and Play Hardware IDs used to build the matching entries in the ACPI tables. The compressed EISA-type IDs produced by this macro differ from the compressed EISA-type IDs stored in ACPI tables. As a result, the compressed EISA-type IDs from the ACPI Device Path nodes cannot be directly compared to the compressed EISA-type IDs from the ACPI table.

```
#define EFI_PNP_ID(ID) (UINT32)(((ID) << 16) | 0x41D0)  
#define EISA_PNP_ID(ID) EFI_PNP_ID(ID)
```

**Table 48. ACPI Device Path**

Mnemonic	Byte Offset	Byte Length	Description
Type	0	1	Type 2 – ACPI Device Path.
Sub-Type	1	1	Sub-Type 1 ACPI Device Path.
Length	2	2	Length of this structure in bytes. Length is 12 bytes.
_HID	4	4	Device's PnP hardware ID stored in a numeric 32-bit compressed EISA-type ID. This value must match the corresponding _HID in the ACPI name space.
_UID	8	4	Unique ID that is required by ACPI if two devices have the same _HID. This value must also match the corresponding _UID/_HID pair in the ACPI name space. Only the 32-bit numeric value type of _UID is supported; thus strings must not be used for the _UID in the ACPI name space.

**Table 49. Expanded ACPI Device Path**

Mnemonic	Byte Offset	Byte Length	Description
Type	0	1	Type 2 – ACPI Device Path.
Sub-Type	1	1	Sub-Type 2 Expanded ACPI Device Path.
Length	2	2	Length of this structure in bytes. Minimum length is 19 bytes. The actual size will depend on the size of the _HIDSTR, _UIDSTR, and _CIDSTR fields.
_HID	4	4	Device's PnP hardware ID stored in a numeric 32-bit compressed EISA-type ID. This value must match the corresponding _HID in the ACPI name space.
_UID	8	4	Unique ID that is required by ACPI if two devices have the same _HID. This value must also match the corresponding _UID/_HID pair in the ACPI name space.
_CID	12	4	Device's compatible PnP hardware ID stored in a numeric 32-bit compressed EISA-type ID. This value must match at least one of the compatible device IDs returned by the corresponding _CID in the ACPI name space.
_HIDSTR	16	>=1	Device's PnP hardware ID stored as a null-terminated ASCII string. This value must match the corresponding _HID in the ACPI name space. If the length of this string not including the null-terminator is 0, then the _HID field is used. If the length of this null-terminated string is greater than 0, then this field supersedes the _HID field.

Mnemonic	Byte Offset	Byte Length	Description
_UIDSTR	Varies	>=1	Unique ID that is required by ACPI if two devices have the same _HID. This value must also match the corresponding _UID/_HID pair in the ACPI name space. This value is stored as a null-terminated ASCII string. If the length of this string not including the null-terminator is 0, then the _UID field is used. If the length of this null-terminated string is greater than 0, then this field supersedes the _UID field. The Byte Offset of this field can be computed by adding 16 to the size of the _HIDSTR field.
_CIDSTR	Varies	>=1	Device's compatible PnP hardware ID stored as a null-terminated ASCII string. This value must match at least one of the compatible device IDs returned by the corresponding _CID in the ACPI name space. If the length of this string not including the null-terminator is 0, then the _CID field is used. If the length of this null-terminated string is greater than 0, then this field supersedes the _CID field. The Byte Offset of this field can be computed by adding 16 to the sum of the sizes of the _HIDSTR and _UIDSTR fields.

### 10.3.4 ACPI \_ADR Device Path

The \_ADR device path is used to contain video output device attributes to support the Graphics Output Protocol. The device path can contain multiple \_ADR entries if multiple video output devices are displaying the same output.

Table 50. ACPI \_ADR Device Path

Mnemonic	Byte Offset	Byte Length	Description
Type	0	1	Type 2 – ACPI Device Path
Sub-Type	1	1	Sub-Type3 _ADR Device Path
Length	2	2	Length of this structure in bytes. Minimum length is 8.
_ADR	4	4	_ADR value. For video output devices the value of this field comes from Table B-2 ACPI 3.0 specification. At least one _ADR value is required
Additional _ADR	8	N	This device path may optionally contain more than one _ADR entry.

### 10.3.5 Messaging Device Path

This Device Path is used to describe the connection of devices outside the resource domain of the system. This Device Path can describe physical messaging information like SCSI ID, or abstract information like networking protocol IP addresses.

### 10.3.5.1 ATAPI Device Path

Table 51. ATAPI Device Path

Mnemonic	Byte Offset	Byte Length	Description
Type	0	1	Type 3 – Messaging Device Path
Sub-Type	1	1	Sub-Type 1 – ATAPI
Length	2	2	Length of this structure in bytes. Length is 8 bytes.
PrimarySecondary	4	1	Set to zero for primary or one for secondary
SlaveMaster	5	1	Set to zero for master or one for slave mode
Logical Unit Number	6	2	Logical Unit Number

### 10.3.5.2 SCSI Device Path

Table 52. SCSI Device Path

Mnemonic	Byte Offset	Byte Length	Description
Type	0	1	Type 3 – Messaging Device Path
Sub-Type	1	1	Sub-Type 2 – SCSI
Length	2	2	Length of this structure in bytes. Length is 8 bytes.
Target ID	4	2	Target ID on the SCSI bus (PUN)
Logical Unit Number	6	2	Logical Unit Number ( LUN)

### 10.3.5.3 Fibre Channel Device Path

Table 53. Fibre Channel Device Path

Mnemonic	Byte Offset	Byte Length	Description
Type	0	1	Type 3 – Messaging Device Path
Sub-Type	1	1	Sub-Type 3 – Fibre Channel
Length	2	2	Length of this structure in bytes. Length is 24 bytes.
Reserved	4	4	Reserved
World Wide Name	8	8	Fibre Channel World Wide Name
Logical Unit Number	16	8	Fibre Channel Logical Unit Number

Table 54. Fibre Channel Ex Device Path

Mnemonic	Byte Offset	Byte Length	Description
Type	0	1	Type 3 – Messaging Device Path
Sub-Type	1	1	Sub-Type 21 – Fibre Channel Ex
Length	2	2	Length of this structure in bytes. Length is 24 bytes.

Reserved	4	4	Reserved
World Wide Name	8	8	8 byte array containing Fibre Channel End Device Port Name (a.k.a., World Wide Name)
Logical Unit Number	16	8	8 byte array containing Fibre Channel Logical Unit Number

The Fibre Channel Ex device path clarifies the definition of the Logical Unit Number field to conform with the T-10 SCSI Architecture Model 4 specification. The 8 byte Logical Unit Number field in the device path must conform with a logical unit number returned by a SCSI REPORT LUNS command.

When the Fibre Channel Ex Device Path is used with the Extended SCSI Pass Thru Protocol the UIN64 LUN argument must be converted to the eight byte array Logical Unit Number field in the device path by treating the eight byte array as an EFI UIN64. For example a Logical Unit Number array of { 0,1,2,3,4,5,6,7 } becomes a UIN64 of 0x0706050403020100.

When an application client displays or otherwise makes a 64-bit LUN visible to a user, it should be done in conformance with SAM-4. SAM-4 requires a LUN to be displayed in hexadecimal format with byte 0 first (i.e., on the left) and byte 7 last (i.e., on the right) regardless of the internal representation of the LUN. UEFI defines all data structures a “little endian” and SCSI defines all data structures as “big endian”. Fibre Channel Ex Device Path Example shows an example device path for a Fibre Channel controller on a typical UEFI platform. This Fibre Channel Controller is connected to the port 0 of the root hub, and its interface number is 0. The Fibre Channel Host Controller is a PCI device whose PCI device number 0x1F and PCI function 0x00. So, the whole device path for this Fibre Channel Controller consists an ACPI Device Path Node, a PCI Device Path Node, a Fibre Channel Device Path Node and a Device Path End Structure. The \_HID and \_UID must match the ACPI table description of the PCI Root Bridge. The Fibre Channel WWN and LUN were picked to show byte order and they are not typical real world values. The shorthand notation for this device path is:

*PciRoot(0)/PCI(31,0)/FibreEx(0x0001020304050607, 0x0001020304050607)*

**Table 55. Fibre Channel Ex Device Path Example**

Byte Offset	Byte Length	Data	Description
0	1	0x02	<b>Generic Device Path Header</b> – Type ACPI Device Path
1	1	0x01	Sub type – ACPI Device Path
2	2	0x0C	Length – 0x0C bytes
4	4	0x41D0, 0x0A03	_HID PNPOA03 – 0x41D0 represents the compressed string ‘PNP’ and is encoded in the low order bytes. The compression method is described in the ACPI Specification.
8	4	0x0000	_UID
12	1	0x01	<b>Generic Device Path Header</b> – Type Hardware Device Path
13	1	0x01	Sub type – PCI
14	2	0x06	Length – 0x06 bytes
16	1	0x0	PCI Function
17	1	0x1F	PCI Device
18	1	0x03	<b>Generic Device Path Header</b> – Type Message Device Path
19	1	0x15	Sub type – Fibre Channel Ex
20	2	0x14	Length – 20 bytes
21	1	0x00	8 byte array containing Fibre Channel End Device Port Name (a.k.a., World Wide Name)
22	1	0x01	
23	1	0x02	
24	1	0x03	
25	1	0x04	
26	1	0x05	
27	1	0x06	
28	1	0x07	
29	1	0x00	8 byte array containing Fibre Channel Logical Unit Number
30	1	0x01	
31	1	0x02	
32	1	0x03	
33	1	0x04	
34	1	0x05	
35	1	0x06	
36	1	0x07	
37	1	0xFF	<b>Generic Device Path Header</b> – Type End of Hardware Device Path
38	1	0xFF	Sub type – End of Entire Device Path
39	2	0x04	Length – 0x04 bytes

### 10.3.5.4 1394 Device Path



Table 56. 1394 Device Path

Mnemonic	Byte Offset	Byte Length	Description
Type	0	1	Type 3 – Messaging Device Path
Sub-Type	1	1	Sub-Type 4 – 1394
Length	2	2	Length of this structure in bytes. Length is 16 bytes.
Reserved	4	4	Reserved
GUID <sup>1</sup>	8	8	1394 Global Unique ID (GUID) <sup>1</sup>

Note: <sup>1</sup> The usage of the term GUID is per the 1394 specification. This is not the same as the **EFI\_GUID** type defined in the EFI Specification.

### 10.3.5.5 USB Device Paths

Table 57. USB Device Path

Mnemonic	Byte Offset	Byte Length	Description
Type	0	1	Type 3 – Messaging Device Path
Sub-Type	1	1	Sub-Type 5 – USB
Length	2	2	Length of this structure in bytes. Length is 6 bytes.
USB Parent Port Number	4	1	USB Parent Port Number
Interface	5	1	USB Interface Number

#### 10.3.5.5.1 USB Device Path Example

[Table 58](#) shows an example device path for a USB controller on a desktop platform. This USB Controller is connected to the port 0 of the root hub, and its interface number is 0. The USB Host Controller is a PCI device whose PCI device number 0x1F and PCI function 0x02. So, the whole device path for this USB Controller consists an ACPI Device Path Node, a PCI Device Path Node, a USB Device Path Node and a Device Path End Structure. The `_HID` and `_UID` must match the ACPI table description of the PCI Root Bridge. The shorthand notation for this device path is:

PciRoot(0)/PCI(31,2)/USB(0,0).

**Table 58. USB Device Path Examples**

Byte Offset	Byte Length	Data	Description
0x00	0x01	0x02	<b>Generic Device Path Header</b> – Type ACPI Device Path
0x01	0x01	0x01	Sub type – ACPI Device Path
0x02	0x02	0x0C	Length – 0x0C bytes
0x04	0x04	0x41D0, 0x0A03	_HID PNPOA03 – 0x41D0 represents the compressed string ‘PNP’ and is encoded in the low order bytes. The compression method is described in the ACPI Specification.
0x08	0x04	0x0000	_UID
0x0C	0x01	0x01	<b>Generic Device Path Header</b> – Type Hardware Device Path
0x0D	0x01	0x01	Sub type – PCI
0x0E	0x02	0x06	Length – 0x06 bytes
0x10	0x01	0x02	PCI Function
0x11	0x01	0x1F	PCI Device
0x12	0x01	0x03	<b>Generic Device Path Header</b> – Type Message Device Path
0x13	0x01	0x05	Sub type – USB
0x14	0x02	0x06	Length – 0x06 bytes
0x16	0x01	0x00	Parent Hub Port Number
0x17	0x01	0x00	Controller Interface Number
0x18	0x01	0xFF	<b>Generic Device Path Header</b> – Type End of Hardware Device Path
0x19	0x01	0xFF	Sub type – End of Entire Device Path
0x1A	0x02	0x04	Length – 0x04 bytes

Another example is a USB Controller (interface number 0) that is connected to port 3 of a USB Hub Controller (interface number 0), and this USB Hub Controller is connected to the port 1 of the root hub. The shorthand notation for this device path is:

**PciRoot(0)/PCI(31,2)/USB(1,0)/USB(3,0).**

[Table 58](#) shows the device path for this USB Controller.

Table 59. Another USB Device Path Example

Byte Offset	Byte Length	Data	Description
0x00	0x01	0x02	<b>Generic Device Path Header</b> – Type ACPI Device Path
0x01	0x01	0x01	Sub type – ACPI Device Path
0x02	0x02	0x0C	Length – 0x0C bytes
0x04	0x04	0x41D0, 0x0A03	_HID PNPOA03 – 0x41D0 represents the compressed string 'PNP' and is encoded in the low order bytes. The compression method is described in the ACPI Specification.
0x08	0x04	0x0000	_UID
0x0C	0x01	0x01	<b>Generic Device Path Header</b> – Type Hardware Device Path
0x0D	0x01	0x01	Sub type – PCI
0x0E	0x02	0x06	Length – 0x06 bytes
0x10	0x01	0x02	PCI Function
0x11	0x01	0x1F	PCI Device
0x12	0x01	0x03	<b>Generic Device Path Header</b> – Type Message Device Path
0x13	0x01	0x05	Sub type – USB
0x14	0x02	0x06	Length – 0x06 bytes
0x16	0x01	0x01	Parent Hub Port Number
0x17	0x01	0x00	Controller Interface Number
0x18	0x01	0x03	<b>Generic Device Path Header</b> – Type Message Device Path
0x19	0x01	0x05	Sub type – USB
0x1A	0x02	0x06	Length – 0x06 bytes
0x1C	0x01	0x03	Parent Hub Port Number
0x1D	0x01	0x00	Controller Interface Number
0x1E	0x01	0xFF	<b>Generic Device Path Header</b> – Type End of Hardware Device Path
0x1F	0x01	0xFF	Sub type – End of Entire Device Path
0x20	0x02	0x04	Length – 0x04 bytes

### 10.3.5.6 SATA Device Path

Table 60. SATA Device Path

Mnemonic	Byte Offset	Byte Length	Description
Type	0	1	Type 3 – Messaging Device Path
Sub-Type	1	1	Sub-Type 18 – SATA
Length	2	2	Length of this structure in bytes. Length is 10 bytes.
HBA Port Number	4	2	The HBA port number that facilitates the connection to the device or a port multiplier. The value 0xFFFF is reserved.
Port Multiplier Port Number	6	2	The Port multiplier port number that facilitates the connection to the device. Must be set to 0xFFFF if the device is directly connected to the HBA.

Logical Unit Number	8	2	Logical Unit Number.
---------------------	---	---	----------------------

### 10.3.5.7 USB Device Paths (WWID)

This device path describes a USB device using its serial number.

Specifications, such as the USB Mass Storage class, bulk-only transport subclass, require that some portion of the suffix of the device’s serial number be unique with respect to the vendor and product id for the device. So, in order to avoid confusion and overlap of WWID’s, the interface’s class, subclass, and protocol are included.

**Table 61. USB WWID Device Path**

Mnemonic	Byte Offset	Byte Length	Description
Type	0	1	Type 3 - Messaging Device Path
Sub-Type	1	1	Sub-Type 16- USB WWID
Length	2	2	Length of this structure in bytes. Length is 10+
• Interface Number	4	2	USB interface number
• Device Vendor Id	6	2	USB vendor id of the device
• Device Product Id	8	2	USB product id of the device
• Serial Number	10	n	Last 64-or-fewer UTF-16 characters of the USB serial number. The length of the string is determined by the <i>Length</i> field less the offset of the <i>Serial Number</i> field (10)

Devices that do not have a serial number string must use with the USB Device Path (type 5) as described in [Section 10.3.5.5](#).

Including the interface as part of this node allows distinction for multi-interface devices, e.g., an HID interface and a Mass Storage interface on the same device, or two Mass Storage interfaces.

[Section 3.1.2](#) defines special rules for processing the USB WWID Device Path. These special rules enable a device location to change and still have the system boot from the device.

### 10.3.5.8 Device Logical Unit

For some classes of devices, such as USB Mass Storage, it is necessary to specify the Logical Unit Number (LUN), since a single device may have multiple logical units. In order to boot from one of these logical units of the device, the Device Logical Unit device node is appended to the device path. The EFI path node subtype is defined, as in [Table 62](#).

Table 62. Device Logical Unit

Mnemonic	Byte Offset	Byte Length	Description
Type	0	1	Type 3 - Messaging Device Path
Sub-Type	1	1	Sub-Type 17 – Device Logical unit
Length	2	2	Length of this structure in bytes. Length is 5
LUN	4	1	Logical Unit Number for the interface

[Section 3.1.2](#) defines special rules for processing the USB Class Device Path. These special rules enable a device location to change and still have the system recognize the device.

[Section 3.3](#) defines how the *ConIn*, *ConOut*, and *ErrOut* variables are processed and contains special rules for processing the USB Class device path. These special rules allow all USB keyboards to be specified as valid input devices.

### 10.3.5.9 USB Device Path (Class)

Table 63. USB Class Device Path

Mnemonic	Byte Offset	Byte Length	Description
Type	0	1	Type 3 - Messaging Device Path.
Sub-Type	1	1	Sub-Type 15 - USB Class.
Length	2	2	Length of this structure in bytes. Length is 11 bytes.
Vendor ID	4	2	Vendor ID assigned by USB-IF. A value of 0xFFFF will match any Vendor ID.
Product ID	6	2	Product ID assigned by USB-IF. A value of 0xFFFF will match any Product ID.
Device Class	8	1	The class code assigned by the USB-IF. A value of 0xFF will match any class code.
Device Subclass	9	1	The subclass code assigned by the USB-IF. A value of 0xFF will match any subclass code.
Device Protocol	10	1	The protocol code assigned by the USB-IF. A value of 0xFF will match any protocol code.

### 10.3.5.10 I2O Device Path

Table 64. I<sub>2</sub>O Device Path

Mnemonic	Byte Offset	Byte Length	Description
Type	0	1	Type 3 – Messaging Device Path
Sub-Type	1	1	Sub-Type 6 – I2O Random Block Storage Class
Length	2	2	Length of this structure in bytes. Length is 8 bytes.
TID	4	4	Target ID (TID) for a device

### 10.3.5.11 MAC Address Device Path

Table 65. MAC Address Device Path

Mnemonic	Byte Offset	Byte Length	Description
Type	0	1	Type 3 – Messaging Device Path
Sub-Type	1	1	Sub-Type 11 – MAC Address for a network interface
Length	2	2	Length of this structure in bytes. Length is 37 bytes.
MAC Address	4	32	The MAC address for a network interface padded with 0s
IfType	36	1	Network interface type(i.e., 802.3, FDDI). See RFC 3232

### 10.3.5.12 IPv4 Device Path

Previous versions of the specification only defined a 19 byte IPv4 device path. To access

fields at off-set 19 or greater, the size of the device path must be checked first.

**Table 66. IPv4 Device Path**

Mnemonic	Byte Offset	Byte Length	Description
Type	0	1	Type 3 – Messaging Device Path
Sub-Type	1	1	Sub-Type 12 – IPv4
Length	2	2	Length of this structure in bytes. Length is 27 bytes.
Local IP Address	4	4	The local IPv4 address
Remote IP Address	8	4	The remote IPv4 address
Local Port	12	2	The local port number
Remote Port	14	2	The remote port number
Protocol	16	2	The network protocol(i.e., UDP, TCP). See RFC 3232
StaticIPAddress	18	1	0x00 - The Source IP Address was assigned though DHCP 0x01 - The Source IP Address is statically bound
GatewayIPAddress	19	4	The Gateway IP Address
Subnet Mask	23	4	Subnet mask

### 10.3.5.13 IPv6 Device Path

**Table 67. IPv6 Device Path**

Mnemonic	Byte Offset	Byte Length	Description
Type	0	1	Type 3 – Messaging Device Path
Sub-Type	1	1	Sub-Type 13 – IPv6
Length	2	2	Length of this structure in bytes. Length is 60 bytes.
Local IP Address	4	16	The local IPv6 address
Remote IP Address	20	16	The remote IPv6 address
Local Port	36	2	The local port number
Remote Port	38	2	The remote port number
Protocol	40	2	The network protocol (i.e., UDP, TCP). See RFC 3232
IPAddressOrigin	42	1	0x00 - The Local IP Address was manually configured. 0x01 - The Local IP Address is assigned through IPv6 stateless auto-configuration. 0x02 - The Local IP Address is assigned through IPv6stateful configuration.
PrefixLength	43	1	The Prefix Length
GatewayIPAddress	44	16	The Gateway IP Address

### 10.3.5.14 2.VLAN device path node

Mnemonic	Byte Offset	Byte Length	Description
Type	0	1	Type 3 – Messaging Device Path



Sub-Type	1	1	Sub-Type 20 – Vlan (802.1q)
Length	2	2	Length of this device node
VlanId	4	2	VLAN identifier (0-4094)

### 10.3.5.15 InfiniBand Device Path

Table 68. InfiniBand Device Path

Mnemonic	Byte Offset	Byte Length	Description
Type	0	1	Type 3 – Messaging Device Path
Sub-Type	1	1	Sub-Type 9 – InfiniBand
Length	2	2	Length of this structure in bytes. Length is 48 bytes.
Resource Flags	4	4	Flags to help identify/manage InfiniBand device path elements: <ul style="list-style-type: none"> <li>• Bit 0 – IOC/Service (0b = IOC, 1b = Service)</li> <li>• Bit 1 – Extend Boot Environment</li> <li>• Bit 2 – Console Protocol</li> <li>• Bit 3 – Storage Protocol</li> <li>• Bit 4 – Network Protocol</li> </ul> All other bits are reserved.
PORT GUID	8	16	128-bit Global Identifier for remote fabric port
IOC GUID/Service ID	24	8	64-bit unique identifier to remote IOC or server process. Interpretation of field specified by Resource Flags (bit 0)
Target Port ID	32	8	64-bit persistent ID of remote IOC port
Device ID	40	8	64-bit persistent ID of remote device
Note: The usage of the terms GUID and GID is per the InfiniBand Specification. The term GUID is not the same as the <b>EFI_GUID</b> type defined in this EFI Specification.			

### 10.3.5.16 UART Device Path

Table 69. UART Device Path

Mnemonic	Byte Offset	Byte Length	Description
Type	0	1	Type 3 – Messaging Device Path
Sub-Type	1	1	Sub-Type 14 – UART
Length	2	2	Length of this structure in bytes. Length is 19 bytes.
Reserved	4	4	Reserved
Baud Rate	8	8	The baud rate setting for the UART style device. A value of 0 means that the device's default baud rate will be used.
Data Bits	16	1	The number of data bits for the UART style device. A value of 0 means that the device's default number of data bits will be used.

Parity	17	1	The parity setting for the UART style device. Parity 0x00 - Default Parity Parity 0x01 - No Parity Parity 0x02 - Even Parity Parity 0x03 - Odd Parity Parity 0x04 - Mark Parity Parity 0x05 - Space Parity
Stop Bits	18	1	The number of stop bits for the UART style device. Stop Bits 0x00 - Default Stop Bits Stop Bits 0x01 - 1 Stop Bit Stop Bits 0x02 - 1.5 Stop Bits Stop Bits 0x03 - 2 Stop Bits

### 10.3.5.17 Vendor-Defined Messaging Device Path

Table 70. Vendor-Defined Messaging Device Path

Mnemonic	Byte Offset	Byte Length	Description
Type	0	1	Type 3 – Messaging Device Path
Sub-Type	1	1	Sub-Type 10 – Vendor
Length	2	2	Length of this structure in bytes. Length is 20 + <i>n</i> bytes.
Vendor GUID	4	16	Vendor-assigned GUID that defines the data that follows
Vendor Defined Data	20	<i>n</i>	Vendor-defined variable size data

The following GUIDs are used with a Vendor-Defined Messaging Device Path to describe the transport protocol for use with PC-ANSI, VT-100, VT-100+, and VT-UTF8 terminals. Device paths can be constructed with this node as the last node in the device path. The rest of the device path describes the physical device that is being used to transmit and receive data. The PC-ANSI, VT-100, VT-100+, and VT-UTF8 GUIDs define the format of the data that is being sent through the physical device. Additional GUIDs can be generated to describe additional transport protocols.

```
#define EFI_PC_ANSI_GUID \
{ 0xe0c14753,0xf9be,0x11d2,{0x9a,0x0c,0x00,0x90,0x27,0x3f,0xc1,0x4d }}

#define EFI_VT_100_GUID \
{ 0xdfa66065,0xb419,0x11d3,{0x9a,0x2d,0x00,0x90,0x27,0x3f,0xc1,0x4d }}

#define EFI_VT_100_PLUS_GUID \
{ 0x7baec70b,0x57e0,0x4c76,{0x8e,0x87,0x2f,0x9e,0x28,0x08,0x83,0x43 }}

#define EFI_VT_UTF8_GUID \
{ 0xad15a0d6,0x8bec,0x4acf,{0xa0,0x73,0xd0,0x1d,0xe7,0x7e,0x2d,0x88 }}
```

### 10.3.5.18 UART Flow Control Messaging Path

The UART messaging device path defined in the EFI 1.02 specification does not contain a provision for flow control. Therefore, a new device path node is needed to declare flow control characteristics. It is a vendor-defined messaging node which may be appended to the UART node in a device path. It has the following definition:

```
#define DEVICE_PATH_MESSAGING_UART_FLOW_CONTROL \
{0x37499a9d,0x542f,0x4c89,{0xa0,0x26,0x35,0xda,0x14,0x20,0x94,0xe4}}
```

Table 71. UART Flow Control Messaging Device Path

Mnemonic	Byte Offset	Byte Length	Description
Type	0	1	Type 3 – Messaging Device Path
Sub-Type	1	1	Sub-Type 10 – Vendor
Length	2	2	Length of this structure in bytes. Length is 24 bytes.
Vendor GUID	4	16	<b>DEVICE_PATH_MESSAGING_UART_FLOW_CONTROL</b>
Flow_Control_Map	20	4	Bitmap of supported flow control types. <ul style="list-style-type: none"> <li>• Bit 0 set indicates hardware flow control.</li> <li>• Bit 1 set indicates Xon/Xoff flow control.</li> <li>• All other bits are reserved and are clear.</li> </ul>

A debugport driver that implements Xon/Xoff flow control would produce a device path similar to the following:

```
PciRoot(0)/Pci(0x1f,0)/ACPI(PNP0501,0)/UART(115200,N,8,1)/UartFlowCtrl(2)/
DebugPort()
```

**Note:** *If no bits are set in the Flow\_Control\_Map, this indicates there is no flow control and is equivalent to leaving the flow control node out of the device path completely.*

### 10.3.5.19 Serial Attached SCSI (SAS) Device Path

This section defines the device node for Serial Attached SCSI (SAS) devices.

Table 72. Messaging Device Path Structure

Mnemonic	Byte Offset	Byte Length	Description
Type	0	1	Type -3 Messaging
Sub Type	1	1	10 ( Vendor)
Length	2	2	Length of this Structure.
Vendor GUID	4	16	d487ddb4-008b-11d9-afdc-001083ffca4d
Reserved	20	4	Reserved for future use.
SAS Address	24	8	SAS Address for Serial Attached SCSI Target.
Logical Unit Number	32	8	SAS Logical Unit Number.
SAS/SATA device and Topology Info	40	2	More Information about the device and its interconnect
Relative Target Port	42	2	Relative Target Port (RTP)

## Summary

The device node represented by the structure in [Table 72](#) (above) shall be appended after the Hardware Device Path node in the device path.

There are two cases for boot devices connected with SAS HBA's. Each of the cases is described below with an example of the expected Device Path for these.

- SAS Device anywhere in an SAS domain accessed through SSP Protocol.  
**PciRoot(0)/PCI(1,0)/Sas(0x31000004CF13F6BD, 0)**  
 The first 64-bit number represents the SAS address of the target SAS device.  
 The second number is the boot LUN of the target SAS device.  
 The third number is the Relative Target Port (RTP)
- SATA Device connected directly to a HBA port.  
**PciRoot(0)/PCI(1,0)/Sas(0x31000004CF13F6BD)**  
 The first number represents either a real SAS address reserved by the HBA for above connections, or a fake but unique SAS address generated by the HBA to represent the SATA device.

### 10.3.5.19.1 Device and Topology Information

First Byte (At offset 40 into the structure):

Bits 0:3:

Value 0x0 -> No Additional Information about device topology.

Value 0x1 -> More Information about device topology valid in this byte.

Value 0x2 -> More Information about device topology valid in this and next 1 byte.

Values 0x3 thru 0xF -> Reserved.

Bits 4:5: Device Type ( Valid only if the More Information field above is non-zero)

Value 0x0 -> SAS Internal Device

Value 0x1 -> SATA Internal Device

Value 0x2 -> SAS External Device

Value 0x3 -> SATA External Device

Bits 6:7: Topology / Interconnect (Valid only if the More Information field above is non-zero)

Value 0x0 -> Direct Connect (Connected directly with the HBA Port/Phy)

Value 0x1 -> Expander Connect (Connected thru/via one or more Expanders)

Value 0x2 and 0x3 > Reserved

### 10.3.5.19.2 Device and Topology Information

Second Byte (At offset 41 into the structure). Valid only if bits 0-3 of More Information in Byte 40 have a value of 2:

Bits 0-7: Internal Drive/Bay Id (Only applicable if Internal Drive is indicated in Device Type)

Value 0x0 thru 0xFF -> Drive 1 thru Drive 256

### 10.3.5.19.3 Relative Target Port

At offset 42 into the structure:

This two-byte field shall contain the “Relative Target Port” of the target SAS port. Relative Target Port can be obtained by performing an INQUIRY command to VPD page 0x83 in the target. Implementation of RTP is mandatory for SAS targets as defined in Section 10.2.10 of sas1r07 specification (or later).

**Note:** *If a LUN is seen thru multiple RTPs in a given target, then the UEFI driver shall create separate device path instances for both paths. RTP in the device path shall distinguish these two device path instantiations.*

**Note:** *Changing the values of the SAS/SATA device topology information or the RTP fields of the device path will make UEFI think this is a different device.*

### 10.3.5.19.4 Examples Of Correct Device Path Display Format

Case 1: When Additional Information is not Valid or Not Present (Bits 0:3 of Byte 40 have a value of 0)

**PciRoot(0)/PCI(1,0)/SAS(0x31000004CF13F6BD, 0)**

Case 2: When Additional Information is Valid and present (Bits 0:3 of Byte 40 have a value of 1 or 2)

- If Bits 4-5 of Byte 40 (Device and Topology information) indicate an SAS device (Internal or External) i.e., has values 0x0 or 0x2, then the following format shall be used.

**PciRoot(0)/PCI(1,0)/SAS(0x31000004CF13F6BD, 0, SAS)**

- If Bits 4-5 of Byte 40 (Device and Topology information) indicate a SATA device (Internal or External) i.e., has a value of 0x1 or 0x3, then the following format shall be used.

**ACPI(PnP)/PCI(1,0)/SAS(0x31000004CF13F6BD, SATA)****10.3.5.20 Serial Attached SCSI (SAS) Ex Device Path**

This section defines the extended device node for Serial Attached SCSI (SAS) devices. In this device path the SAS Address and LUN are now defined as arrays to remove the need to endian swap the values.

**Table 73. Messaging Device Path Structure**

Mnemonic	Byte Offset	Byte Length	Description
Type	0	1	Type -3 Messaging
Sub Type	1	1	Sub-type 22 SAS Ex
Length	2	2	Length of this Structure. 32 bytes
SAS Address	4	8	8-byte array of the SAS Address for Serial Attached SCSI Target Port.
Logical Unit Number	20	8	8-byte array of the SAS Logical Unit Number.
SAS/SATA device and Topology Info	28	2	More Information about the device and its interconnect
Relative Target Port	30	2	Relative Target Port (RTP)

The SAS Ex device path clarifies the definition of the Logical Unit Number field to conform with the T-10 SCSI Architecture Model 4 specification. The 8 byte Logical Unit Number field in the device path must conform with a logical unit number returned by a SCSI REPORT LUNS command.

When the SAS Device Path Ex is used with the Extended SCSI Pass Thru Protocol, the UINT64 LUN must be converted to the eight byte array Logical Unit Number field in the device path by treating the eight byte array as an EFI UINT64. For example, a Logical Unit Number array of { 0,1,2,3,4,5,6,7 } becomes a UINT64 of 0x0706050403020100.

When an application client displays or otherwise makes a 64-bit LUN (8 byte array) visible to a user, it should be done in conformance with SAM-4. SAM-4 requires a LUN to be displayed in hexadecimal format with byte 0 first (i.e., on the left) and byte 7 last (i.e., on the right) regardless of the internal representation of the LUN. UEFI defines all data structures a "little endian" and SCSI defines all data structures as "big endian".

### 10.3.5.21 iSCSI Device Path

Table 74. iSCSI Device Path Node (Base Information)

Mnemonic	Byte Offset	Byte Length	Description
Type	0	1	Type 3 – Messaging Device Path
Sub-Type	1	1	Sub-Type 19 – (iSCSI)
Length	2	2	Length of this structure in bytes. Length is (18 + n) bytes
Protocol	4	2	Network Protocol (0 = TCP, 1+ = reserved)
Options	6	2	iSCSI Login Options
Logical Unit Number	8	8	8 byte array containing the iSCSI Logical Unit Number
Target Portal group tag	16	2	iSCSI Target Portal group tag the initiator intends to establish a session with.
iSCSI Target Name	18	n	iSCSI NodeTarget Name. The length of the name is determined by subtracting the offset of this field from <i>Length</i> .

#### 10.3.5.21.1 iSCSI Login Options

The iSCSI Device Node Options describe the iSCSI login options for the key values:

Bits 0:1:

0 = No Header Digest

2 = Header Digest Using CRC32C

Bits 2-3:

0 = No Data Digest

2 = Data Digest Using CRC32C

Bits 4:9:

Reserved for future use

Bits 10-11:

0 = AuthMethod\_CHAP

2 = AuthMethod\_None

Bit 12:

0 = CHAP\_BI

1 = CHAP\_UNI

For each specific login key, none, some or all of the defined values may be configured. If none of the options are defined for a specific key, the iSCSI driver shall propose “None” as the value. If more than one option is configured for a specific key, all the configured values will be proposed (ordering of the values is implementation dependent).



- Portal Group Tag: defines the iSCSI portal group the initiator intends to establish Session with.
- Logical Unit Number: defines the 8 byte SCSI LUN. The Logical Unit Number field must conform to the T-10 SCSI Architecture Model 4 specification. The 8 byte Logical Unit Number field in the device path must conform with a logical unit number returned by a SCSI REPORT LUNS command.
- iSCSI Target Name: defines the iSCSI Target Name for the iSCSI Node. The size of the iSCSI Target Name can be up to a maximum of 223 bytes.

#### 10.3.5.21.2 Device Path Examples

Some examples for the Device Path for the case the boot device connected to iSCSI bootable controller:

- With IPv4 configuration:  
**PciRoot(0)/Pci(19|0)/Mac(001320F5FA77,0x01)/  
IPv4(192.168.0.100,TCP,Static,192.168.0.1)/ iSCSI(iqn.1991-**

**05.com.microsoft:iscsitarget-iscsidisk-target,0x1,0x0,None,None,None,TCP)/  
HD(1,GPT,15E39A00-1DD2-1000-8D7F-00A0C92408FC,0x22,0x2710000)**

**Table 75. IPv4 configuration**

Byte Offset	Byte Length	Data	Description
0x00	1	0x02	<b>Generic Device Path Header</b> – Type ACPI Device Path
0x01	1	0x01	Sub type – ACPI Device Path
0x02	2	0x0C	Length – 0x0C bytes
0x04	4	0x41D0, 0x0A03	_HID PNP0A03 – 0x41D0 represents the compressed string ‘PNP’ and is encoded in the low order bytes. The compression method is described in the ACPI Specification.
0x08	4	0x0000	_UID
0x0C	1	0x01	<b>Generic Device Path Header</b> – Type Hardware Device Path
0x0D	1	0x01	Sub type – PCI
0x0E	2	0x06	Length – 0x06 bytes
0x10	1	0x0	PCI Function
0x11	1	0x19	PCI Device
0x12	1	0x03	<b>Generic Device Path Header</b> – Messaging Device Path
0x13	1	0x0B	Sub type – MAC Address Device path
0x14	2	0x25	Length – 0x25



0x4A	4		Gateway IP Address
0x4E	4		Subnet mask
0x52	1	0x03	<b>Generic Device Path Header</b> – Messaging Device Path
0x53	1	0x13	Sub type – iSCSI
0x54	2	0x49	Length – 0x49
0x56	2	0x00	Network Protocol
0x58	2	0x800	iSCSI Login Options – AuthMethod_None
0x5A	8	0x00, 0x00, 0x00, 0x00, 0x00, 0x00, 0x00, 0x00	iSCSI LUN
0x62	2	0x01	Target Portal group tag
0x64	55	0x69, 0x71, 0x6E, 0x2E, 0x31, 0x39, 0x39, 0x31, 0x2D, 0x30, 0x35, 0x2E, 0x63, 0x6F, 0x6D, 0x2E, 0x6D, 0x69, 0x63, 0x72, 0x6F, 0x73, 0x6F, 0x66, 0x74,	iSCSI node name.

0x64 (cont.)	55 (cont.)	0x3A, 0x69, 0x73, 0x63, 0x73, 0x69, 0x74, 0x61, 0x72, 0x67, 0x65, 0x74, 0x2D, 0x69, 0x73, 0x63, 0x73, 0x69, 0x64, 0x69, 0x73, 0x6B, 0x2D, 0x74, 0x61, 0x72, 0x67, 0x65, 0x74, 0x00	iSCSI node name (cont.)
0x9B	1	0x04	<b>Generic Device Path Header</b> – Media Device Path
0x9C	1	0x01	Sub type – Hard Drive
0x9D	2	0x2A	Length – 0x2a
0x9F	4	0x1	Partition Number
0xA3	8	0x22	Partition Start
0xAB	8	0x2710 000	Partition Size

0xB3	16	0x00, 0x9A, 0xE3, 0x15, 0xD2, 0x1D, 0x00, 0x10, 0x8D, 0x7F, 0x00, 0xA0, 0xC9, 0x24, 0x08, 0xFC	Partition Signature
0xC3	1	0x02	Partition Format – GPT
0xC4	1	0x02	Signature Type – GUID
0xC5	1	0xFF	<b>Generic Device Path Header</b> – Type End of Hardware Device Path
0xC6	1	0xFF	Sub type – End of Entire Device Path
0xC7	2	0x04	Length – 0x04 bytes

- With IPv6 configuration:  
**PciRoot(0x0)/Pci(0x1C,0x2)/Pci(0x0,0x0)/MAC(001517215593,0x0)/  
 IPv6(2001:4898:000A:1005:95A6:EE6C:BED3:4859,TCPDHCP,2001:4898:000A:100**

5:0215:17FF:FE21:5593)/iSCSI(iqn.1991-05.com.microsoft:iscsiipv6-ipv6test-target,0x1,0x0,None,None,None,TCP)/HD(1,MBR,0xA0021243,0x800,0x2EE000)

Table 76. IPv6 configuration

Byte Offset	Byte Length	Data	Description
0x00	1	0x02	<b>Generic Device Path Header</b> – Type ACPI Device Path
0x01	1	0x01	Sub type – ACPI Device Path
0x02	2	0x0C	Length – 0x0C bytes
0x04	4	0x41D0, 0x0A03	_HID PNP0A03 – 0x41D0 represents the compressed string ‘PNP’ and is encoded in the low order bytes. The compression method is described in the ACPI Specification.
0x08	4	0x0000	_UID
0x0C	1	0x01	<b>Generic Device Path Header</b> – Type Hardware Device Path
0x0D	1	0x01	Sub type – PCI
0x0E	2	0x06	Length – 0x06 bytes
0x10	1	0x02	PCI Function
0x11	1	0x1C	PCI Device
0x12	1	0x01	<b>Generic Device Path Header</b> – Type Hardware Device Path
0x13	1	0x01	Sub type – PCI
0x14	2	0x06	Length – 0x06 bytes
0x16	1	0x00	PCI Function
0x17	1	0x00	PCI Device
0x18	1	0x03	<b>Generic Device Path Header</b> – Messaging Device Path
0x19	1	0x0B	Sub type – MAC Address Device path
0x1A	2	0x25	Length – 0x25





0x41	16	0x20, 0x01, 0x48, 0x98, 0x00, 0x0A, 0x10, 0x05, 0x02, 0x15, 0x17, 0xFF, 0xFE, 0x21, 0x55, 0x93	Local IPv6 address – 2001:4898:000A:1005:0215:17FF:FE21:5593
0x51	16	0x20, 0x01, 0x48, 0x98, 0x00, 0x0A, 0x10, 0x05, 0x95, 0xA6, 0xEE, 0x6C, 0xBE, 0xD3, 0x48, 0x59	Remote IPv6 address – 2001:4898:000A:1005:95A6:EE6C:BED3:4859
0x61	2	0x0000	Local Port Number – 0
0x63	2	0x0CBC	Remote Port Number – 3260
0x65	2	0x6	Network Protocol. See RFC 3232. TCP
0x66	1	1	IP Address Origin
0x67	1		The Prefix Length
0x68	16		The Gateway IP Address
0x78	1	0x03	<b>Generic Device Path Header</b> – Messaging Device Path
0x79	1	0x13	Sub type – iSCSI
0x7A	2	0x46	Length – 0x46
0x7C	2	0x00	Network Protocol
0x7E	2	0x800	iSCSI Login Options – AuthMethod_None

0x81	8	0x00, 0x00, 0x00, 0x00, 0x00, 0x00, 0x00, 0x00	iSCSI LUN
0x89	2	0x01	Target Portal group tag
0x8B	52	0x69, 0x71, 0x6E, 0x2E, 0x31, 0x39, 0x39, 0x31, 0x2D, 0x30, 0x35, 0x2E, 0x63, 0x6F, 0x6D, 0x2E, 0x6D, 0x69, 0x63, 0x72, 0x6F, 0x73, 0x6F, 0x66, 0x74, 0x3A, 0x69, 0x73, 0x63, 0x73, 0x69, 0x69, 0x70, 0x76,	iSCSI node name.

0x8B (cont.)	52 (cont.)	0x36, 0x2D, 0x69, 0x70, 0x76, 0x36, 0x74, 0x65, 0x73, 0x74, 0x2D, 0x74, 0x61, 0x72, 0x67, 0x65, 0x74, 0x00	iSCSI node name (cont.)
0xBF	1	0x04	<b>Generic Device Path Header – Media Device Path</b>
0xC0	1	0x01	Sub type – Hard Drive
0xC1	2	0x2A	Length – 0x2a
0xC3	4	0x1	Partition Number
0xC7	8	0x800	Partition Start
0xCF	8	0x2EE0 00	Partition Size
0xDF	16	0x43, 0x12, 0x02, 0xA0, 0x00, 0x00, 0x00, 0x00, 0x00, 0x00, 0x00, 0x00, 0x00, 0x00, 0x00, 0x00, 0x00	Partition Signature
0xEF	1	0x01	Partition Format – MBR
0xF0	1	0x01	Signature Type – 32bit signature
0xF1	1	0xFF	<b>Generic Device Path Header – Type End of Hardware Device Path</b>
0xF2	1	0xFF	Sub type – End of Entire Device Path
0xF3	2	0x04	Length – 0x04 bytes

### 10.3.5.22 NVM Express namespace messaging device path node

Table 77. NVM Express Namespace Device Path

Mnemonic	Byte Offset	Byte Length	Description
Type	0	1	Type 3 – Messaging Device Path
Sub-Type	1	1	Sub Type 23 – NVM Express Namespace
Length	2	2	Length of this structure in bytes. Length is 16 bytes.
Namespace Identifier	4	4	Namespace identifier (NSID). The values of 0 and 0xFFFFFFFF are invalid.
IEEE Extended Unique Identifier	8	8	This field contains the IEEE Extended Unique Identifier (EUI-64). Devices without an EUI-64 value must initialize this field with a value of 0.

Refer to the latest NVM Express specification for descriptions of Namespace Identifier (NSID) and IEEE Extended Unique Identifier (EUI-64): See “Links to UEFI-Related Documents” (<http://uefi.org/uefi> under the headings “NVM Express Specification”.

### 10.3.5.23 Uniform Resource Identifiers (URI) Device Path

Refer to RFC 3986 for details on the URI contents.

Table 78. URI Device Path

Mnemonic	Byte Offset	Byte Length	Description
Type	0	1	Type 3 – Messaging Device Path
Sub-Type	1	1	Sub Type 24 – Universal Resource Identifier (URI) Device Path
Length	2	2	Length of this structure in bytes. Length is 4 + <i>n</i> bytes.
...	4	<i>n</i>	Instance of the URI pursuant to RFC 3986. For an empty URI, Length is 4 bytes.

### 10.3.5.24 UFS (Universal Flash Storage) device messaging device path node

Table 79. UFS Device Path

Mnemonic	Byte Offset	Byte Length	Description
Type	0	1	Type 3 – Messaging Device Path
Sub-Type	1	1	Sub-Type 25 – UFS
Length	2	2	Length of this structure in bytes. Length is 6 bytes.
Target ID	4	1	Target ID on the UFS interface (PUN).
LUN	5	1	Logical Unit Number (LUN).

Refer to the UFS 2.0 specification for additional LUN descriptions: See “Links to UEFI-Related Documents” (<http://uefi.org/uefi>) under the heading “UFS 2.0 Specification”.

- *PUN field*: According to current available UFS 2.0 spec, the topology is one device per UFS port. A topology to support multiple devices on a single interface is planned for future revision. So suggest to reserve/introduce this field to support multiple devices per UFS port. This value should be 0 for current UFS2.0 spec compliance.
- *LUN field*: This field is used to specify up to 8 normal LUNs(0-7) and 4 well-known LUNs(81h, D0h, B0h and C4h). For those well-known LUNs, the BIT7 is set. See Figure 10.2 of UFS 2.0 spec for details.

### 10.3.5.25 SD (Secure Digital) Device Path

Table 80. SD Device Path

Mnemonic	Byte Offset	Byte Length	Description
Type	0	1	Type 3 – Messaging Device Path
Sub-Type	1	1	Sub-Type 26 – SD
Length	2	2	Length of this structure in bytes. Length is 5 bytes.
Slot Number	4	1	Slot Number

### 10.3.5.26 EFI Bluetooth Device Path

Table 81. Bluetooth Device Path

Mnemonic	Byte Offset	Byte Length	Description
Type	0	1	Type 3 – Messaging Device Path
Sub-Type	1	1	Sub-Type 27 – Bluetooth
Length	2	2	Length of this structure in bytes. Length is 10 bytes.
Bluetooth Device Address	4	6	48-bit Bluetooth device address.

### 10.3.5.27 Wireless Device Path

Table 82. Wi-Fi Device Path

Mnemonic	Byte Offset	Byte Length	Description
Type	0	1	Type 3 – Messaging Device Path
Sub-Type	1	1	Sub Type 28 – Wi-Fi Device Path
Length	2	2	Length of this structure in bytes. Length is 36 bytes.
SSID	4	32	SSID in octet string

### 10.3.5.28 eMMC (Embedded Multi-Media Card) Device Path

Table 83. eMMC Device Path

Mnemonic	Byte Offset	Byte Length	Description
Type	0	1	Type 3 – Messaging Device Path
Sub-Type	1	1	Sub-Type 29 – eMMC
Length	2	2	Length of this structure in bytes. Length is 5 bytes.

Slot Number	4	1	Slot Number
-------------	---	---	-------------

### 10.3.5.29 EFI BluetoothLE Device Path

**Table 84. EFI BluetoothLE Device Path**

Mnemonic	Byte Offset	Byte Length	Description
Type	0	1	Type 3 – Messaging Device Path
Sub-Type	1	1	Sub-Type 30 – BluetoothLE
Length	2	2	Length of this structure in bytes. Length is 11 bytes.
Bluetooth Device Address	4	6	48-bit Bluetooth device address
Address Type	10	1	0x00 – Public Device Address 0x01 – Random Device Address

### 10.3.5.30 DNS Device Path

**Table 85. DNS Device Path**

Mnemonic	Byte Offset	Byte Length	Description
Type	0	1	Type 3 – Messaging Device Path
Sub-Type	1	1	Sub-Type 31 – DNS Device Path
Length	2	2	Length of this structure in bytes. Length is 5 + n bytes.
IsIPv6	4	1	0x00 – The DNS server address is IPv4 address. 0x01 – The DNS server address is IPv6 address.
...	5	n	One or more instances of the DNS server address in EFI_IP_ADDRESS.



### 10.3.5.31 NVDIMM Device Path

This device path describes an NVDIMM device using the ACPI 6.0 specification defined NFIT Device Handle as the `_ADR` method value. According to the ACPI specification, the NFIT Device Handle is reported in the `_ADR` Device Path method for each NVDIMM device. To avoid duplication and reduce complexity, the NVDIMM Device Path is described as *the* ACPI `_ADR` Device Path for the NVDIMM device.

The following Table outlines the format of the NVDIMM Device Path, identically matching an `_ADR` Device Path with NFIT Device Handle identifier contained within the `_ADR` payload, as defined in the ACPI specification:

ACPI <code>_ADR</code> Device Path Mnemonic	Byte Offset	Byte Length	ACPI <code>_ADR</code> Device Path Description
Type	0	1	See UEFI Protocols – Device Path Protocol & <code>_ADR</code> Device Path subsection
Sub-Type	1	1	
Length	2	2	8 – Single NFIT Device Handle is supported.
<code>_ADR</code>	4	4	<code>_ADR</code> Payload -NFIT Device Handle - Unique physical identifier. -See ACPI Defined Devices and Device Specific Objects section, NVDIMM Devices sub-chapter for the specific definition of the fields utilized for this handle.

### 10.3.6 Media Device Path

This Device Path is used to describe the portion of the medium that is being abstracted by a boot service. An example of Media Device Path would be defining which partition on a hard drive was being used.

#### 10.3.6.1 Hard Drive

The Hard Drive Media Device Path is used to represent a partition on a hard drive. Each partition has at least Hard Drive Device Path node, each describing an entry in a partition table. EFI supports MBR and GPT partitioning formats. Partitions are numbered according to their entry in their respective partition table, starting with 1. Partitions are addressed in EFI starting at LBA zero. A partition number of zero can be used to represent the raw hard drive or a raw extended partition.

The partition format is stored in the Device Path to allow new partition formats to be supported in the future. The Hard Drive Device Path also contains a Disk Signature and a Disk Signature Type. The disk signature is maintained by the OS and only used by EFI to

partition Device Path nodes. The disk signature enables the OS to find disks even after they have been physically moved in a system.

[Section 3.1.2](#) defines special rules for processing the Hard Drive Media Device Path. These special rules enable a disk’s location to change and still have the system boot from the disk.

**Table 86. Hard Drive Media Device Path**

Mnemonic	Byte Offset	Byte Length	Description
Type	0	1	Type 4 – Media Device Path
Sub-Type	1	1	Sub-Type 1 – Hard Drive
Length	2	2	Length of this structure in bytes. Length is 42 bytes.
Partition Number	4	4	Describes the entry in a partition table, starting with entry 1. Partition number zero represents the entire device. Valid partition numbers for a MBR partition are [1, 4]. Valid partition numbers for a GPT partition are [1, NumberOfPartitionEntries].
Partition Start	8	8	Starting LBA of the partition on the hard drive
Partition Size	16	8	Size of the partition in units of Logical Blocks
Partition Signature	24	16	Signature unique to this partition: If SignatureType is 0, this field has to be initialized with 16 zeroes. If SignatureType is 1, the MBR signature is stored in the first 4 bytes of this field. The other 12 bytes are initialized with zeroes. If SignatureType is 2, this field contains a 16 byte signature.
Partition Format	40	1	Partition Format: (Unused values reserved) 0x01 – PC-AT compatible legacy MBR (see <a href="#">Section 5.2.1</a> ). Partition Start and Partition Size come from <code>PartitionStartingLBA</code> and <code>PartitionSizeInLBA</code> for the partition. 0x02 – GUID Partition Table (see <a href="#">Section 5.3.2</a> ).
Signature Type	41	1	Type of Disk Signature: (Unused values reserved) 0x00 – No Disk Signature. 0x01 – 32-bit signature from address 0x1b8 of the type 0x01 MBR. 0x02 – GUID signature.

### 10.3.6.2 CD-ROM Media Device Path

The CD-ROM Media Device Path is used to define a system partition that exists on a CD-ROM. The CD-ROM is assumed to contain an ISO-9660 file system and follow the CD-ROM “El Torito” format. The Boot Entry number from the Boot Catalog is how the “El Torito” specification defines the existence of bootable entities on a CD-ROM. In EFI the bootable entity is an EFI System Partition that is pointed to by the Boot Entry.

Table 87. CD-ROM Media Device Path

Mnemonic	Byte Offset	Byte Length	Description
Type	0	1	Type 4 – Media Device Path.
Sub-Type	1	1	Sub-Type 2 – CD-ROM “El Torito” Format.
Length	2	2	Length of this structure in bytes. Length is 24 bytes.
Boot Entry	4	4	Boot Entry number from the Boot Catalog. The Initial/Default entry is defined as zero.
Partition Start	8	8	Starting RBA of the partition on the medium. CD-ROMs use Relative logical Block Addressing.
Partition Size	16	8	Size of the partition in units of Blocks, also called Sectors.

### 10.3.6.3 Vendor-Defined Media Device Path

Table 88. Vendor-Defined Media Device Path

Mnemonic	Byte Offset	Byte Length	Description
Type	0	1	Type 4 – Media Device Path.
Sub-Type	1	1	Sub-Type 3 – Vendor.
Length	2	2	Length of this structure in bytes. Length is 20 + <i>n</i> bytes.
Vendor GUID	4	16	Vendor-assigned GUID that defines the data that follows.
Vendor Defined Data	20	<i>n</i>	Vendor-defined variable size data.

### 10.3.6.4 File Path Media Device Path

Table 89. File Path Media Device Path

Mnemonic	Byte Offset	Byte Length	Description
Type	0	1	Type 4 – Media Device Path.
Sub-Type	1	1	Sub-Type 4 – File Path.
Length	2	2	Length of this structure in bytes. Length is 4 + <i>n</i> bytes.
Path Name	4	<i>N</i>	A NULL-terminated Path string including directory and file names. The length of this string <i>n</i> can be determined by subtracting 4 from the Length entry. A device path may contain one or more of these nodes. Each node can optionally add a “\” separator to the beginning and/or the end of the Path Name string. The complete path to a file can be found by logically concatenating all the Path Name strings in the File Path Media Device Path nodes. This is typically used to describe the directory path in one node, and the filename in another node.

Rules for Path Name conversion:

- When concatenating two Path Names, ensure that the resulting string does not contain a double-separator "\\". If it does, convert that double-separator to a single-separator.
- In the case where a Path Name which has no end separator is being concatenated to a Path Name with no beginning separator, a separator will need to be inserted between the Path Names.
- Single file path nodes with no directory path data are presumed to have their files located in the root directory of the device.

### 10.3.6.5 Media Protocol Device Path

The Media Protocol Device Path is used to denote the protocol that is being used in a device path at the location of the path specified. Many protocols are inherent to the style of device path.

**Table 90. Media Protocol Media Device Path**

Mnemonic	Byte Offset	Byte Length	Description
Type	0	1	Type 4 – Media Device Path.
Sub-Type	1	1	Sub-Type 5 – Media Protocol.
Length	2	2	Length of this structure in bytes. Length is 20 bytes.
Protocol GUID	4	16	The ID of the protocol.

### 10.3.6.6 PIWG Firmware File

This type is used by systems implementing the UEFI PI Specification to describe a firmware file. The exact format and usage are defined in that specification.

**Table 91. PIWG Firmware Volume Device Path**

Mnemonic	Byte Offset	Byte Length	Description
Type	0	1	Type 4 – Media Device Path.
Sub-Type	1	1	Sub-Type 6 – PIWG Firmware File.
Length	2	2	Length of this structure in bytes. Length is 4 + <i>n</i> bytes.
...	4	<i>n</i>	Contents are defined in the UEFI PI Specification.

### 10.3.6.7 PIWG Firmware Volume

This type is used by systems implementing the UEFI PI Specification to describe a firmware volume. The exact format and usage are defined in that specification.

**Table 92. PIWG Firmware Volume Device Path**

Mnemonic	Byte Offset	Byte Length	Description
Type	0	1	Type 4 – Media Device Path.
Sub-Type	1	1	Sub-Type 7 – PIWG Firmware Volume.
Length	2	2	Length of this structure in bytes. Length is 4 + <i>n</i> bytes.
...	4	<i>n</i>	Contents are defined in the UEFI PI Specification.

### 10.3.6.8 Relative Offset Range

This device path node specifies a range of offsets relative to the first byte available on the device. The starting offset is the first byte of the range and the ending offset is the last byte of the range (not the last byte + 1).

**Table 93. Relative Offset Range**

Mnemonic	Byte Offset	Byte Length	Description
Type	0	1	Type 4 – Media Device Path
Sub-Type	1	1	Sub-Type 8 – Relative Offset Range
Length	2	2	Length of this structure in bytes.
Reserved	4	4	Reserved for future use.
Starting Offset	8	8	Offset of the first byte, relative to the parent device node.
Ending Offset	16	8	Offset of the last byte, relative to the parent device node.

### 10.3.6.9 RAM Disk

**Table 94. RAM Disk Device Path**

Mnemonic	Byte Offset	Byte Length	Description
Type	0	1	Type 4 – Media Device Path
Sub-Type	1	1	Sub Type 9 – RAM Disk Device Path
Length	2	2	Length of this structure in bytes. Length is 38 bytes.
Starting Address	4	8	Starting Memory Address.
Ending Address	12	8	Ending Memory Address.
Disk Type GUID	20	16	GUID that defines the type of the RAM Disk. The GUID can be any of the values defined below, or a vendor defined GUID.
Disk Instance	36	2	RAM Disk instance number, if supported. The default value is zero.

The following GUIDs are used with a RAM Disk Device Path to describe the RAM Disk Type. Additional GUIDs can be generated to describe additional RAM Disk Types. The

Disk Type GUID values used in the RAM Disk device path must match the corresponding values in the Address Range Type GUID of the ACPI NFIT table. Refer to the ACPI specification for details.

This GUID defines a RAM Disk supporting a raw disk format in volatile memory:

```
#define EFI_VIRTUAL_DISK_GUID \
{ 0x77AB535A,0x45FC,0x624B,\
{0x55,0x60,0xF7,0xB2,0x81,0xD1,0xF9,0x6E }}
```

This GUID defines a RAM Disk supporting an ISO image in volatile memory:

```
#define EFI_VIRTUAL_CD_GUID \
{ 0x3D5ABD30,0x4175,0x87CE,\
{0x6D,0x64,0xD2,0xAD,0xE5,0x23,0xC4,0xBB }}
```

This GUID defines a RAM Disk supporting a raw disk format in persistent memory:

```
#define EFI_PERSISTENT_VIRTUAL_DISK_GUID \
{ 0x5CEA02C9,0x4D07,0x69D3,\
{0x26,0x9F,0x44,0x96,0xFB,0xE0,0x96,0xF9 }}
```

This GUID defines a RAM Disk supporting an ISO image in persistent memory:

```
#define EFI_PERSISTENT_VIRTUAL_CD_GUID \
{ 0x08018188,0x42CD,0xBB48,\
{0x10,0x0F,0x53,0x87,0xD5,0x3D,0xED,0x3D }}
```

### 10.3.7 BIOS Boot Specification Device Path

This Device Path is used to describe the booting of non-EFI-aware operating systems. This Device Path is based on the IPL and BCV table entry data structures defined in Appendix A of the *BIOS Boot Specification*. The BIOS Boot Specification Device Path defines a complete Device Path and is not used with other Device Path entries. This Device Path is only needed to enable platform firmware to select a legacy non-EFI OS as a boot option.

**Table 95. BIOS Boot Specification Device Path**

Mnemonic	Byte Offset	Byte Length	Description
Type	0	1	Type 5 – BIOS Boot Specification Device Path.
Sub-Type	1	1	Sub-Type 1 – BIOS Boot Specification Version 1.01.
Length	2	2	Length of this structure in bytes. Length is 8 + <i>n</i> bytes.
Device Type	4	2	Device Type as defined by the BIOS Boot Specification.
Status Flag	6	2	Status Flags as defined by the BIOS Boot Specification
Description String	8	<i>n</i>	A null-terminated ASCII string that describes the boot device to a user. The size of this string <i>n</i> can be determined by subtracting 8 from the Length entry.

Example BIOS Boot Specification Device Types include:

- 00h = Reserved
- 01h = Floppy
- 02h = Hard Disk
- 03h = CD-ROM
- 04h = PCMCIA
- 05h = USB
- 06h = Embedded network
- 07h..7Fh = Reserved
- 80h = BEV device
- 81h..FEh = Reserved
- FFh = Unknown

**Note:** When UEFI Secure Boot is enabled, attempts to boot non-UEFI OS shall fail; see [Section 31.4](#).

## 10.4 Device Path Generation Rules

### 10.4.1 Housekeeping Rules

The Device Path is a set of Device Path nodes. The Device Path must be terminated by an End of Device Path node with a sub-type of End the Entire Device Path. A NULL Device Path consists of a single End Device Path Node. A Device Path that contains a NULL pointer and no Device Path structures is illegal.

All Device Path nodes start with the generic Device Path structure. Unknown Device Path types can be skipped when parsing the Device Path since the length field can be used to find the next Device Path structure in the stream. Any future additions to the Device Path structure types will always start with the current standard header. The size of a Device Path can be determined by traversing the generic Device Path structures in each header

and adding up the total size of the Device Path. This size will include the four bytes of the End of Device Path structure.

Multiple hardware devices may be pointed to by a single Device Path. Each hardware device will contain a complete Device Path that is terminated by the Device Path End Structure. The Device Path End Structures that do not end the Device Path contain a sub-type of End This Instance of the Device Path. The last Device Path End Structure contains a sub-type of End Entire Device Path.

### 10.4.2 Rules with ACPI \_HID and \_UID

As described in the ACPI specification, ACPI supports several different kinds of device identification objects, including \_HID, \_CID and \_UID. The \_UID device identification objects are optional in ACPI and only required if more than one \_HID exists with the same ID. The ACPI Device Path structure must contain a zero in the \_UID field if the ACPI name space does not implement \_UID. The \_UID field is a unique serial number that persists across reboots.

If a device in the ACPI name space has a \_HID and is described by a \_CRS (Current Resource Setting) then it should be described by an ACPI Device Path structure. A \_CRS implies that a device is not mapped by any other standard. A \_CRS is used by ACPI to make a nonstandard device into a Plug and Play device. The configuration methods in the ACPI name space allow the ACPI driver to configure the device in a standard fashion. The presence of a \_CID determines whether the ACPI Device Path node or the Expanded ACPI Device Path node should be used.

[Table 96](#) maps ACPI \_CRS devices to EFI Device Path.

**Table 96. ACPI \_CRS to EFI Device Path Mapping**

ACPI _CRS Item	EFI Device Path
PCI Root Bus	ACPI Device Path: _HID PNP0A03, _UID
Floppy	ACPI Device Path: _HID PNP0604, _UID drive select encoding 0-3
Keyboard	ACPI Device Path: _HID PNP0301, _UID 0
Serial Port	ACPI Device Path: _HID PNP0501, _UID Serial Port COM number 0-3
Parallel Port	ACPI Device Path: _HID PNP0401, _UID LPT number 0-3

Support of root PCI bridges requires special rules in the EFI Device Path. A root PCI bridge is a PCI device usually contained in a chipset that consumes a proprietary bus and produces a PCI bus. In typical desktop and mobile systems there is only one root PCI bridge. On larger server systems there are typically multiple root PCI bridges. The operation of root PCI bridges is not defined in any current PCI specification. A root PCI bridge should not be confused with a PCI to PCI bridge that both consumes and produces a PCI bus. The operation and configuration of PCI to PCI bridges is fully specified in current PCI specifications.

Root PCI bridges will use the plug and play ID of PNP0A03, This will be stored in the ACPI Device Path \_HID field, or in the Expanded ACPI Device Path \_CID field to match the ACPI



name space. The `_UID` in the ACPI Device Path structure must match the `_UID` in the ACPI name space.

### 10.4.3 Rules with ACPI `_ADR`

If a device in the ACPI name space can be completely described by a `_ADR` object then it will map to an EFI ACPI, Hardware, or Message Device Path structure. A `_ADR` method implies a bus with a standard enumeration algorithm. If the ACPI device has a `_ADR` and a `_CRS` method, then it should also have a `_HID` method and follow the rules for using `_HID`.

[Table 97](#) relates the ACPI `_ADR` bus definition to the EFI Device Path:

**Table 97. ACPI `_ADR` to EFI Device Path Mapping**

ACPI <code>_ADR</code> Bus	EFI Device Path
EISA	Not supported
Floppy Bus	ACPI Device Path: <code>_HID PNP0604, _UID</code> drive select encoding 0-3
IDE Controller	ATAPI Message Device Path: Maser/Slave : LUN
IDE Channel	ATAPI Message Device Path: Maser/Slave : LUN
PCI	PCI Hardware Device Path
PCMCIA	Not Supported
PC CARD	PC CARD Hardware Device Path
SMBus	Not Supported
SATA bus	SATA Messaging Device Path

### 10.4.4 Hardware vs. Messaging Device Path Rules

Hardware Device Paths are used to define paths on buses that have a standard enumeration algorithm and that relate directly to the coherency domain of the system. The coherency domain is defined as a global set of resources that is visible to at least one processor in the system. In a typical system this would include the processor memory space, IO space, and PCI configuration space.

Messaging Device Paths are used to define paths on buses that have a standard enumeration algorithm, but are not part of the global coherency domain of the system. SCSI and Fibre Channel are examples of this kind of bus. The Messaging Device Path can also be used to describe virtual connections over network-style devices. An example would be the TCP/IP address of an internet connection.

Thus Hardware Device Path is used if the bus produces resources that show up in the coherency resource domain of the system. A Message Device Path is used if the bus consumes resources from the coherency domain and produces resources out side the coherency domain of the system.

### 10.4.5 Media Device Path Rules

The Media Device Path is used to define the location of information on a medium. Hard Drives are subdivided into partitions by the MBR and a Media Device Path is used to

define which partition is being used. A CD-ROM has boot partitions that are defined by the “El Torito” specification, and the Media Device Path is used to point to these partitions.

An [EFI\\_BLOCK\\_IO\\_PROTOCOL](#) is produced for both raw devices and partitions on devices. This allows the [EFI\\_SIMPLE\\_FILE\\_SYSTEM\\_PROTOCOL](#) protocol to not have to understand media formats. The [EFI\\_BLOCK\\_IO\\_PROTOCOL](#) for a partition contains the same Device Path as the parent [EFI\\_BLOCK\\_IO\\_PROTOCOL](#) for the raw device with the addition of a Media Device Path that defines which partition is being abstracted.

The Media Device Path is also used to define the location of a file in a file system. This Device Path is used to load files and to represent what file an image was loaded from.

### 10.4.6 Other Rules

The BIOS Boot Specification Device Path is not a typical Device Path. A Device Path containing the BIOS Boot Specification Device Path should only contain the required End Device Path structure and no other Device Path structures. The BIOS Boot Specification Device Path is only used to allow the EFI boot menus to boot a legacy operating system from legacy media.

The EFI Device Path can be extended in a compatible fashion by assigning your own vendor GUID to a Hardware, Messaging, or Media Device Path. This extension is guaranteed to never conflict with future extensions of this specification.

The EFI specification reserves all undefined Device Path types and subtypes. Extension is only permitted using a Vendor GUID Device Path entry.

## 10.5 Device Path Utilities Protocol

This section describes the [EFI\\_DEVICE\\_PATH\\_UTILITIES\\_PROTOCOL](#), which aids in creating and manipulating device paths.

### EFI\_DEVICE\_PATH\_UTILITIES\_PROTOCOL

#### Summary

Creates and manipulates device paths and device nodes.

#### GUID

```
// {0379BE4E-D706-437d-B037-EDB82FB772A4}
#define EFI_DEVICE_PATH_UTILITIES_PROTOCOL_GUID \
{0x379be4e,0xd706,0x437d,\
{0xb0,0x37,0xed,0xb8,0x2f,0xb7,0x72,0xa4 }}
```

## Protocol Interface Structure

```
typedef struct _EFI_DEVICE_PATH_UTILITIES_PROTOCOL {
  EFI_DEVICE_PATH_UTILS_GET_DEVICE_PATH_SIZE GetDevicePathSize;
  EFI_DEVICE_PATH_UTILS_DUP_DEVICE_PATH DuplicateDevicePath;
  EFI_DEVICE_PATH_UTILS_APPEND_PATH AppendDevicePath;
  EFI_DEVICE_PATH_UTILS_APPEND_NODE AppendDeviceNode;
  EFI_DEVICE_PATH_UTILS_APPEND_INSTANCE
    AppendDevicePathInstance;
  EFI_DEVICE_PATH_UTILS_GET_NEXT_INSTANCE
    GetNextDevicePathInstance;
  EFI_DEVICE_PATH_UTILS_IS_MULTI_INSTANCE
    IsDevicePathMultiInstance;
  EFI_DEVICE_PATH_UTILS_CREATE_NODE CreateDeviceNode;
} EFI_DEVICE_PATH_UTILITIES_PROTOCOL;
```

## Parameters

<i>GetDevicePathSize</i>	Returns the size of the specified device path, in bytes.
<i>DuplicateDevicePath</i>	Duplicates a device path structure.
<i>AppendDeviceNode</i>	Appends the device node to the specified device path.
<i>AppendDevicePath</i>	Appends the device path to the specified device path.
<i>AppendDevicePathInstance</i>	Appends a device path instance to another device path.
<i>GetNextDevicePathInstance</i>	Retrieves the next device path instance from a device path data structure.
<i>IsDevicePathMultiInstance</i>	Returns TRUE if this is a multi-instance device path.
<i>CreateDeviceNode</i>	Allocates memory for a device node with the specified type and sub-type.

## Description

The **EFI\_DEVICE\_PATH\_UTILITIES\_PROTOCOL** provides common utilities for creating a manipulating device paths and device nodes.

## EFI\_DEVICE\_PATH\_UTILITIES\_PROTOCOL.GetDevicePathSize()

### Summary

Returns the size of the device path, in bytes.

### Prototype

```
typedef
UINTN
(EFI_API *EFI_DEVICE_PATH_UTILS_GET_DEVICE_PATH_SIZE) (
    IN CONST EFI_DEVICE_PATH_PROTOCOL *DevicePath
);
```

### Parameters

*DevicePath* Points to the start of the EFI device path.

### Description

This function returns the size of the specified device path, in bytes, including the end-of-path tag. If *DevicePath* is **NULL** then zero is returned.

### Related Definitions

**EFI\_DEVICE\_PATH\_PROTOCOL** is defined in [Section 10.2](#).

## EFI\_DEVICE\_PATH\_UTILITIES\_PROTOCOL.DuplicateDevicePath()

### Summary

Create a duplicate of the specified path.

### Prototype

```
typedef
EFI_DEVICE_PATH_PROTOCOL*
(EFI_API *EFI_DEVICE_PATH_UTILS_DUP_DEVICE_PATH) (
    IN CONST EFI_DEVICE_PATH_PROTOCOL *DevicePath
);
```

### Parameters

*DevicePath* Points to the source device path.

### Description

This function creates a duplicate of the specified device path. The memory is allocated from EFI boot services memory. It is the responsibility of the caller to free the memory allocated. If *DevicePath* is **NULL** then **NULL** will be returned and no memory will be allocated.

### Related Definitions

**EFI\_DEVICE\_PATH\_PROTOCOL** is defined in [Section 10.2](#).

### Returns

This function returns a pointer to the duplicate device path or **NULL** if there was insufficient memory.

## EFI\_DEVICE\_PATH\_UTILITIES\_PROTOCOL.AppendDevicePath()

### Summary

Create a new path by appending the second device path to the first.

### Prototype

```
typedef
EFI_DEVICE_PATH_PROTOCOL*
(EFI_API *EFI_DEVICE_PATH_UTILS_APPEND_PATH) (
  IN CONST EFI_DEVICE_PATH_PROTOCOL *Src1,
  IN CONST EFI_DEVICE_PATH_PROTOCOL *Src2
);
```

### Parameters

*Src1* Points to the first device path.  
*Src2* Points to the second device path.

### Description

This function creates a new device path by appending a copy of the second device path to a copy of the first device path in a newly allocated buffer. Only the end-of-device-path device node from the second device path is retained. If *Src1* is **NULL** and *Src2* is non-**NULL**, then a duplicate of *Src2* is returned. If *Src1* is non-**NULL** and *Src2* is **NULL**, then a duplicate of *Src1* is returned. If *Src1* and *Src2* are both **NULL**, then a copy of an end-of-device-path is returned.

The memory is allocated from EFI boot services memory. It is the responsibility of the caller to free the memory allocated.

### Related Definitions

**EFI\_DEVICE\_PATH\_PROTOCOL** is defined in [Section 10.2](#).

### Returns

This function returns a pointer to the newly created device path or **NULL** if memory could not be allocated.

## EFI\_DEVICE\_PATH\_UTILITIES\_PROTOCOL.AppendDeviceNode()

### Summary

Creates a new path by appending the device node to the device path.

### Prototype

```
typedef
EFI_DEVICE_PATH_PROTOCOL*
(EFI_API *EFI_DEVICE_PATH_UTILS_APPEND_NODE) (
    IN CONST EFI_DEVICE_PATH_PROTOCOL *DevicePath,
    IN CONST EFI_DEVICE_PATH_PROTOCOL *DeviceNode
);
```

### Parameters

<i>DevicePath</i>	Points to the device path.
<i>DeviceNode</i>	Points to the device node.

### Description

This function creates a new device path by appending a copy of the specified device node to a copy of the specified device path in an allocated buffer. The end-of-device-path device node is moved after the end of the appended device node. If *DeviceNode* is **NULL** then a copy of *DevicePath* is returned. If *DevicePath* is **NULL** then a copy of *DeviceNode*, followed by an end-of-device path device node is returned. If both *DeviceNode* and *DevicePath* are **NULL** then a copy of an end-of-device-path device node is returned.

The memory is allocated from EFI boot services memory. It is the responsibility of the caller to free the memory allocated.

### Related Definitions

**EFI\_DEVICE\_PATH\_PROTOCOL** is defined in [Section 10.2](#).

### Returns

This function returns a pointer to the allocated device path, or **NULL** if there was insufficient memory.

**EFI\_DEVICE\_PATH\_UTILITIES\_PROTOCOL.AppendDevicePathInstance()****Summary**

Creates a new path by appending the specified device path instance to the specified device path.

**Prototype**

```
typedef
EFI_DEVICE_PATH_PROTOCOL*
(EFI_API *EFI_DEVICE_PATH_UTILS_APPEND_INSTANCE) (
    IN CONST EFI_DEVICE_PATH_PROTOCOL *DevicePath,
    IN CONST EFI_DEVICE_PATH_PROTOCOL *DevicePathInstance
);
```

**Parameters**

*DevicePath* Points to the device path. If NULL, then ignored.  
*DevicePathInstance* Points to the device path instance

**Description**

This function creates a new device path by appending a copy of the specified device path instance to a copy of the specified device path in an allocated buffer. The end-of-device-path device node is moved after the end of the appended device node and a new end-of-device-path-instance node is inserted between. If *DevicePath* is NULL, then a copy of *DevicePathInstance* is returned instead.

The memory is allocated from EFI boot services memory. It is the responsibility of the caller to free the memory allocated.

**Related Definitions**

**EFI\_DEVICE\_PATH\_PROTOCOL** is defined in [Section 10.2](#).

**Returns**

This function returns a pointer to the newly created device path or NULL if *DevicePathInstance* is NULL or there was insufficient memory.



## EFI\_DEVICE\_PATH\_UTILITIES\_PROTOCOL.GetNextDevicePathInstance( )

### Summary

Creates a copy of the current device path instance and returns a pointer to the next device path instance.

### Prototype

```
typedef
EFI_DEVICE_PATH_PROTOCOL*
(EFI_API *EFI_DEVICE_PATH_UTILS_GET_NEXT_INSTANCE) (
  IN OUT EFI_DEVICE_PATH_PROTOCOL **DevicePathInstance,
  OUT UINTN      *DevicePathInstanceSize OPTIONAL
);
```

### Parameters

*DevicePathInstance* On input, this holds the pointer to the current device path instance. On output, this holds the pointer to the next device path instance or NULL if there are no more device path instances in the device path.

*DevicePathInstanceSize* On output, this holds the size of the device path instance, in bytes or zero, if *DevicePathInstance* is **NULL**. If **NULL**, then the instance size is not output.

### Description

This function creates a copy of the current device path instance. It also updates *DevicePathInstance* to point to the next device path instance in the device path (or NULL if no more) and updates *DevicePathInstanceSize* to hold the size of the device path instance copy.

The memory is allocated from EFI boot services memory. It is the responsibility of the caller to free the memory allocated.

### Related Definitions

**EFI\_DEVICE\_PATH\_PROTOCOL** is defined in [Section 10.2](#).

### Returns

This function returns a pointer to the copy of the current device path instance or NULL if *DevicePathInstance* was NULL on entry or there was insufficient memory.

**EFI\_DEVICE\_PATH\_UTILITIES\_PROTOCOL.CreateDeviceNode()****Summary**

Creates a device node

**Prototype**

```
typedef
EFI_DEVICE_PATH_PROTOCOL*
(EFI_API *EFI_DEVICE_PATH_UTILS_CREATE_NODE) (
  IN UINT8 NodeType,
  IN UINT8 NodeSubType,
  IN UINT16 NodeLength
);
```

**Parameters**

<i>NodeType</i>	NodeType is the device node type ( <b>EFI_DEVICE_PATH_PROTOCOL.Type</b> ) for the new device node.
<i>NodeSubType</i>	NodeSubType is the device node sub-type ( <b>EFI_DEVICE_PATH_PROTOCOL.SubType</b> ) for the new device node.
<i>NodeLength</i>	NodeLength is the length of the device node ( <b>EFI_DEVICE_PATH_PROTOCOL.Length</b> ) for the new device node.

**Description**

This function creates a new device node in a newly allocated buffer.

The memory is allocated from EFI boot services memory. It is the responsibility of the caller to free the memory allocated.

**Related Definitions**

**EFI\_DEVICE\_PATH\_PROTOCOL** is defined in [Section 10.2](#).

**Returns**

This function returns a pointer to the created device node or NULL if *NodeLength* is less than the size of the header or there was insufficient memory.

## EFI\_DEVICE\_PATH\_UTILITIES\_PROTOCOL.IsDevicePathMultiInstance()

### Summary

Returns whether a device path is multi-instance.

### Prototype

```
typedef
BOOLEAN
(EFI_API *EFI_DEVICE_PATH_UTILS_IS_MULTI_INSTANCE) (
    IN CONST EFI_DEVICE_PATH_PROTOCOL *DevicePath
);
```

### Parameters

*DevicePath* Points to the device path. If **NULL**, then ignored.

### Description

This function returns whether the specified device path has multiple path instances.

### Related Definitions

**EFI\_DEVICE\_PATH\_PROTOCOL** is defined in [Section 10.2](#).

### Returns

This function returns TRUE if the device path has more than one instance or FALSE if it is empty or contains only a single instance.

## 10.6 EFI Device Path Display Format Overview

This section describes the recommended conversion between an EFI Device Path Protocol and text. It also describes standard protocols for implementing these. The goals are:

- Standardized display format. This allows documentation and test tools to understand output coming from drivers provided by multiple vendors.
- Increase Readability. Device paths need to be read by people, so the format should be in a form which can be deciphered, maintaining as much as possible the industry standard means of presenting data. In this case, there are two forms, a display-only form and a parse-able form.
- Round-trip conversion from text to binary form and back to text without loss, if desired.
- Ease of command-line parsing. Since device paths can appear on the command-lines of UEFI applications executed from a shell, the conversion format should not prohibit basic command-line processing, either by the application or by a shell.

## 10.6.1 Design Discussion

The following subsections describe the design considerations for conversion to and from the EFI Device Path Protocol binary format and its corresponding text form.

### 10.6.1.1 Standardized Display Format

Before the UEFI 2.0, there was no standardized format for the conversion from the EFI Device Path protocol and text. Some de-facto standards arose, either as part of the standard implementation or in descriptive text in the EFI Device Driver Writer’s Guide, although they didn’t agree. The standardized format attempts to maintain at least the spirit of these earlier ideas.

### 10.6.1.2 Readability

Since these are conversions to text and, in many cases, users have to read and understand the text form of the EFI Device Path, it makes sense to make them as readable as reasonably possible. Several strategies are used to accomplish this:

- Creating simplified forms for well-known device paths. For example, a PCI root Bridge can be represented as Acpi(PNP0A03,0), but makes more sense as PciRoot(0). When converting from text to binary form, either form is accepted, but when converting from binary form to text, the latter is preferred.
- Omitting the conversion of fields which have empty or default values. By doing this, the average display length is greatly shortened, which improves readability.

### 10.6.1.3 Round-Trip Conversion

The conversions specified here guarantee at least that conversion to and from the binary representation of the EFI Device Path will be semantically identical.

---

Text<sub>1</sub> ð Binary<sub>1</sub> ð Text<sub>2</sub> ð Binary<sub>2</sub>

---

**Figure 28. Text to Binary Conversion**

In [Figure 28](#), the process described in this section is applied to Text<sub>1</sub>, converting it to Binary<sub>1</sub>. Subsequently, Binary<sub>1</sub> is converted to Text<sub>2</sub>. Finally, the Text<sub>2</sub> is converted to Binary<sub>2</sub>. In these cases, Binary<sub>1</sub> and Binary<sub>2</sub> will always be identical. Text<sub>1</sub> and Text<sub>2</sub> may or may not be identical. This is the result of the fact that the text representation has, in some cases, more than one way of representing the same EFI Device Path node.

---

Binary<sub>1</sub> ð Text<sub>1</sub> ð Binary<sub>2</sub> ð Text<sub>2</sub>

---

**Figure 29. Binary to Text Conversion**

In [Figure 29](#) the process described in this section is applied to Binary<sub>1</sub>, converting it to Text<sub>1</sub>. Subsequently, Text<sub>1</sub> is converted to Binary<sub>2</sub>. Finally, Binary<sub>2</sub> is converted to Text<sub>2</sub>. In these cases, Binary<sub>1</sub> and Binary<sub>2</sub> will always be identical and Text<sub>1</sub> and Text<sub>2</sub> will always be identical.

Another consideration in round-trip conversion is potential ambiguity in parsing. This happens when the text representation could be converted into more than type of device node, thus requiring information beyond that contained in the text representation in order to determine the correct conversion to apply. In the case of EFI Device Paths, this causes problems primarily with literal strings in the device path, such as those found in file names, volumes or directories.

For example, the file name `Acpi(PNP0A03,0)` might be a legal FAT32 file name. However, in parsing this, it is not clear whether it refers to an Acpi device node or a file name. Thus, it is ambiguous. In order to prevent ambiguity, certain characters may only be used for device node keywords and may not be used in file names or directories.

#### 10.6.1.4 Command-Line Parsing

Applications written to this specification need to accept the text representation of EFI device paths as command-line parameters, possibly in the context of a command-prompt or shell. In order to do this, the text representation must follow simple guidelines concerning its format.

Command-line parsing generally involves three separate concepts: substitution, redirection and division.

In substitution, the invoker of the application modifies the actual contents of the command-line before it is passed to the application. For example:

```
copy *.xyz
```

In redirection, the invoker of the application gleans from the command line parameters which it uses to, for example, redirect or pipe input or output. For example:

```
echo This text is copied to a file >abc
```

```
dir | more
```

Finally, in division, the invoker or the application startup code divides the command-line up into individual arguments. The following line, for example, has (at least) three arguments, divided by whitespace.

```
copy /b file1.info file2.info
```

#### 10.6.1.5 Text Representation Basics

This section describes the basic rules for the text representation of device nodes and device paths. The formal grammar describing appears later.

The text representation of a device path (or text device path) consists of one or more text device nodes, each preceded by a '/' or '\ ' character. The behavior of a device path where the first node is not preceded by one of these characters is undefined. Some implementations may treat it as a relative path from a current working directory.

Spaces are not allowed at any point within the device path except when quoted with double quotes ("). The '|' (bar), '<' (less than) and '>' (greater than) characters are likewise reserved for use by the shell.

---

```

device-path := \ device-node
               / device-node
               \ device-path device-node
               / device-path device-node

```

---

**Figure 30. Device Path Text Representation**

There are two types of text device nodes : file-name/directory or canonical. Canonical text device nodes are prefixed by an option name consisting of only alphanumerical characters, followed by a parenthesis, followed by option-specific parameters separated by a ',' (comma). File names and directories have no prefixes.

---

```

device-node := standard-device-node | file-name/directory
standard-device-node := option-name(option-parameters)
file-name/directory := any character except '/' '\ '|' '>' '<'

```

---

**Figure 31. Text Device Node Names**

The canonical device node can have zero or more option parameters between the parentheses. Multiple option parameters are separated by a comma. The meaning of the option parameters depends primarily on the option name, then the parameter-identifier (if present) and then the order of appearance in the parameter list. The parameter identifier allows the text representation to only contain the non-default option parameter value, even if it would normally appear fourth in the list of option parameters. Missing parameters do not require the comma unless needed as a placeholder to correctly increment the parameter count for a subsequent parameter.

Consider

```
AcpiEx(HWP0002, PNP0A03,0)
```

Which could also be written:

```
AcpiEx(HWP0002,CID=PNP0A03) or
```

```
AcpiEx(HWP0002,PNP0A03)
```

Since CID and UID are optional parameters. Or consider:

```
Acpi(HWP0002,0)
```

Which could also be written:

```
Acpi(HWP0002)
```

Since UID is an optional parameter.

---

*option-name* := alphanumerical characters string  
*option-parameters* := *option-parameter*  
*option-parameters,option-parameter*  
*option-parameter* := parameter-value  
parameter-identifier=parameter-value

---

Figure 32. Device Node Option Names

#### 10.6.1.6 Text Device Node Reference

In each of the following table rows, a specific device node type and sub-type are given, along with the most general form of the text representation. Any parameters for the device node are listed in italics. In each case, the type is listed and along with it what is required or optional, and any default value, if applicable.

On subsequent lines, alternate representations are listed. In general, these alternate representations are simplified by the assumption that one or more of the parameters is set to a specific value.

#### Parameter Types

This section describes the various types of option parameter values.

**Table 98. EFI Device Path Option Parameter Values**

GUID	An EFI GUID in standard format xxxxxxxx-xxxx-xxxx-xxxx-xxxxxxxxxxxx. See "GUID and Time Formats" on page 2527.
Keyword	In some cases, one of a series of keywords must be listed.
Integer	Unless otherwise specified, this indicates an unsigned integer in the range of 0 to 2 <sup>32</sup> -1. The value is decimal, unless preceded by "0x" or "0X", in which case it is hexadecimal.
EISAID	A seven character text identifier in the format used by the ACPI specification. The first three characters must be alphabetic, either upper or lower case. The second four characters are hexadecimal digits, either numeric, upper case or lower case. Optionally, it can be the number 0.
String	Series of alphabetic, numeric and punctuation characters not including a right parenthesis ')', bar ' ', less-than '<' or greater than '>' character.
HexDump	Series of bytes, represented by two hexadecimal characters per byte. Unless otherwise indicated, the size is only limited by the length of the device node.
IPv4 Address	Series of four integer values (each between 0-255), separated by a ':'. Optionally, followed by a ':' and an integer value between 0-65555. If the ':' is not present, then the port value is zero.
IPv6 Address	IPv6 Address is expressed in the format [address]:port. The 'address' is expressed in the way defined in RFC4291 Section 2.2. The ':port' after the [address] is optional. If present, the 'port' is an integer value between 0-65535 to represent the port number, or else, port number is zero..

**Table 99. Device Node Table**

Device Node Type/SubType/Other	Description
(when type is not recognized)	<b>Path</b> ( <i>type, subtype, data</i> ) The <i>type</i> is an integer from 0-255. The <i>sub-type</i> is an integer from 0-255. The <i>data</i> is a hex dump.
Type: 1 (Hardware Device Path)  (when subtype is not recognized)	<b>HardwarePath</b> ( <i>subtype, data</i> )  The <i>subtype</i> is an integer from 0-255. The <i>data</i> is a hex dump.
Type: 1 (Hardware Device Path) SubType: 1 (PCI)	<b>Pci</b> ( <i>Device, Function</i> )  The <i>Device</i> is an integer from 0-31 and is required. The <i>Function</i> is an integer from 0-7 and is required.
Type: 1 (Hardware Device Path) SubType: 2 (PcPcard)	<b>PcCard</b> ( <i>Function</i> )  The <i>Function</i> is an integer from 0-255 and is required.
Type: 1 (Hardware Device Path) SubType: 3 (Memory Mapped)	<b>MemoryMapped</b> ( <i>EfiMemoryType, StartingAddress, EndingAddress</i> )  The <i>EfiMemoryType</i> is a 32-bit integer and is required. The <i>StartingAddress</i> and <i>EndingAddress</i> are both 64-bit integers and are both required.



Device Node Type/SubType/Other	Description
Type: 1 (Hardware Device Path) SubType: 4 (Vendor)	<b>VenHw</b> ( <i>Guid, Data</i> )  The <i>Guid</i> is a GUID and is required. The <i>Data</i> is a Hex Dump and is optional. The default value is zero bytes.
Type: 1 (Hardware Device Path) SubType: 5 (Controller)	<b>Ctrl</b> ( <i>Controller</i> )  The <i>Controller</i> is an integer and is required.
Type: 1 (Hardware Device Path) SubType: 6 (BMC)	<b>BMC</b> ( <i>Type,Address</i> )  The <i>Type</i> is an integer from 0-255, and is required. The <i>Address</i> is an unsigned 64-bit integer, and is required.
Type: 2 (ACPI Device Path)  (when subtype is not recognized)	<b>AcpiPath</b> ( <i>subtype, data</i> )  The <i>subtype</i> is an integer from 0-255. The <i>data</i> is a hex dump.
Type: 2 (ACPI Device Path) SubType: 1 (ACPI Device Path)	<b>Acpi</b> ( <i>HID,UID</i> )  The <i>HID</i> parameter is an EISAID and is required. The <i>UID</i> parameter is an integer and is optional. The default value is zero.
Type: 2 (ACPI Device Path) SubType: 1 (ACPI Device Path) HID=PNPOA03	<b>PciRoot</b> ( <i>UID</i> )  The <i>UID</i> parameter is an integer. It is optional but required for display. The default value is zero.
Type: 2 (ACPI Device Path) SubType: 1 (ACPI Device Path) HID=PNPOA08	<b>PcieRoot</b> ( <i>UID</i> )  The <i>UID</i> parameter is an integer. It is optional but required for display. The default value is zero.
Type: 2 (ACPI Device Path) SubType: 1 (ACPI Device Path) HID=PNPO604	<b>Floppy</b> ( <i>UID</i> )  The <i>UID</i> parameter is an integer. It is optional for input but required for display. The default value is zero.
Type: 2 (ACPI Device Path) SubType: 1 (ACPI Device Path) HID=PNPO301	<b>Keyboard</b> ( <i>UID</i> )  The <i>UID</i> parameter is an integer. It is optional for input but required for display. The default value is 0.
Type: 2 (ACPI Device Path) SubType: 1 (ACPI Device Path) HID=PNP0501	<b>Serial</b> ( <i>UID</i> )  The <i>UID</i> parameter is an integer. It is optional for input but required for display. The default value is 0.
Type: 2 (ACPI Device Path) SubType: 1 (ACPI Device Path) HID=PNP0401	<b>ParallelPort</b> ( <i>UID</i> )  The <i>UID</i> parameter is an integer. It is optional for input but required for display. The default value is 0.

Device Node Type/SubType/Other	Description
Type: 2 (ACPI Device Path) SubType: 2 (ACPI Expanded Device Path)	<p><b>AcpiEx</b>(<i>HID,CID,UID,HIDSTR,CIDSTR,UIDSTR</i>)  <b>AcpiEx</b>(<i>HID HIDSTR,(CID CIDSTR,UID UIDSTR)</i>)(Display Only)</p> <p>The <i>HID</i> parameter is an EISAID. The default value is 0. Either <i>HID</i> or <i>HIDSTR</i> must be present.                      The <i>CID</i> parameter is an EISAID. The default value is 0. Either <i>CID</i> must be 0 or <i>CIDSTR</i> must be empty.                      The <i>UID</i> parameter is an integer. The default value is 0. Either <i>UID</i> must be 0 or <i>UIDSTR</i> must be empty.                      The <i>HIDSTR</i> is a string. The default value is the empty string. Either <i>HID</i> or <i>HIDSTR</i> must be present.                      The <i>CIDSTR</i> is a string. The default value is an empty string. Either <i>CID</i> must be 0 or <i>CIDSTR</i> must be empty.                      The <i>UIDSTR</i> is a string. The default value is an empty string. Either <i>UID</i> must be 0 or <i>UIDSTR</i> must be empty.</p>
Type: 2 (ACPI Device Path) SubType: 2 (ACPI Expanded Device Path) HIDSTR=empty CIDSTR=empty UID STR!=empty	<p><b>AcpiExp</b>(<i>HID,CID,UIDSTR</i>)</p> <p>The <i>HID</i> parameter is an EISAID. It is required.                      The <i>CID</i> parameter is an EISAID. It is optional and has a default value of 0.                      The <i>UIDSTR</i> parameter is a string. If <i>UID</i> is 0 and <i>UIDSTR</i> is empty, then use <i>AcpiEx</i> format.</p>
Type: 2 (ACPI Device Path) SubType: 2 (ACPI Expanded Device Path) HID=PNPOA03 or CID=PNPOA03 and HID != PNPOA08.	<p><b>PciRoot</b>(<i>UID UIDSTR</i>) (Display Only)</p>
Type: 2 (ACPI Device Path) SubType: 2 (ACPI Expanded Device Path) HID=PNPOA08 or CID=PNPOA08.	<p><b>PcieRoot</b>(<i>UID UIDSTR</i>) (Display Only)</p>
Type: 2 (ACPI Device Path) SubType: 3 (ACPI ADR Device Path)	<p><b>AcpiAdr</b>(<i>DisplayDevice[, DisplayDevice...]</i>)</p> <p>The <i>DisplayDevice</i> parameter is an Integer. There may be one or more, separated by a comma.</p>
Type: 3 MessagingPath  (when subtype is not recognized)	<p><b>Msg</b>(<i>subtype, data</i>)</p> <p>The <i>subtype</i> is an integer from 0-255.                      The <i>data</i> is a hex dump.</p>
Type: 3 (Messaging Device Path) SubType: 1 (ATAPI)	<p><b>Ata</b>(<i>Controller,Drive,LUN</i>)  <b>Ata</b>(<i>LUN</i>) (Display only)</p> <p>The <i>Controller</i> is either an integer with a value of 0 or 1 <i>or</i> else the keyword <b>Primary</b> (0) or <b>Secondary</b> (1). It is required.                      The <i>Drive</i> is either an integer with the value of 0 or 1 <i>or</i> else the keyword <b>Master</b> (0) or <b>Slave</b> (1). It is required.                      The <i>LUN</i> is a 16-bit integer. It is required.</p>

Device Node Type/SubType/Other	Description
Type: 3 (Messaging Device Path) SubType: 2 (SCSI)	<b>Scsi(<i>PUN,LUN</i>)</b>  The <i>PUN</i> is an integer between 0 and 65535 and is required. The <i>LUN</i> is an integer between 0 and 65535 and is required.
Type: 3 (Messaging Device Path) SubType: 3 (Fibre Channel)	<b>Fibre(<i>WWN,LUN</i>)</b>  The <i>WWN</i> is a 64-bit unsigned integer and is required. The <i>LUN</i> is a 64-bit unsigned integer and is required.
Type: 3 (Messaging Device Path) SubType: 21 (Fibre Channel Ex)	<b>FibreEx(<i>WWN,LUN</i>)</b>  The <i>WWN</i> is an 8 byte array that is displayed in hexadecimal format with byte 0 first (i.e., on the left) and byte 7 last (i.e., on the right), and is required. The <i>LUN</i> is an 8 byte array that is displayed in hexadecimal format with byte 0 first (i.e., on the left) and byte 7 last (i.e., on the right), and is required.
Type: 3 (Messaging Device Path) SubType: 4 (1394)	<b>I1394(<i>GUID</i>)</b>  The <i>GUID</i> is a GUID and is required.
Type: 3 (Messaging Device Path) SubType: 5 (USB)	<b>USB(<i>Port,Interface</i>)</b>  The <i>Port</i> is an integer between 0 and 255 and is required. The <i>Interface</i> is an integer between 0 and 255 and is required.
Type: 3 (Messaging Device Path) SubType: 6 (I <sub>2</sub> O)	<b>I2O(<i>TID</i>)</b>  The <i>TID</i> is an integer and is required.
Type: 3 (Messaging Device Path) SubType: 9 (Infiniband)	<b>Infiniband(<i>Flags, Guid, Serviceld, Targetld, Deviceld</i>)</b>  <i>Flags</i> is an integer. <i>Guid</i> is a guid.. <i>Serviceld, Targetld</i> and <i>Deviceld</i> are 64-bit unsigned integers. All fields are required.
Type: 3 (Messaging Device Path) SubType: 10 (Vendor)	<b>VenMsg(<i>Guid, Data</i>)</b>  The <i>Guid</i> is a GUID and is required. The <i>Data</i> is a Hex Dump and is option. The default value is zero bytes.
Type: 3 (Messaging Device Path) SubType: 10 (Vendor) GUID=EFI_PC_ANSI_GUID	<b>VenPcAnsi()</b>
Type: 3 (Messaging Device Path) SubType: 10 (Vendor) GUID=EFI_VT_100_GIUD	<b>VenVt100()</b>
Type: 3 (Messaging Device Path) SubType: 10 (Vendor) GUID=EFI_VT_100_PLUS_GUID	<b>VenVt100Plus()</b>

Device Node Type/SubType/ Other	Description
Type: 3 (Messaging Device Path) SubType: 10 (Vendor) GUID=EFI_VT_UTF8_GUID	<b>VenUtf8()</b>
Type: 3 (Messaging Device Path) SubType: 10 (Vendor) GUID=DEVICE_PATH_MESSAGING _UART_FLOW_CONTROL	<b>UartFlowCtrl(Value)</b>  The <i>Value</i> is either an integer with the value 0, 1 or 2 or the keywords <b>XonXoff</b> (2) or <b>Hardware</b> (1) or <b>None</b> (0).
Type: 3 (Messaging Device Path) SubType: 10 (Serial Attached SCSI) Vendor GUID: d487ddb4-008b- 11d9-afdc-001083ffca4d	<b>SAS(Address, LUN, RTP, SASSATA, Location, Connect, DriveBay, Reserved)</b>  The <i>Address</i> is a 64-bit unsigned integer representing the SAS Address and is required. The <i>LUN</i> is a 64-bit unsigned integer representing the Logical Unit Number and is optional. The default value is 0. The <i>RTP</i> is a 16-bit unsigned integer representing the Relative Target Port and is optional. The default value is 0. The <i>SASSATA</i> is a keyword <b>SAS</b> or <b>SATA</b> or <b>NoTopology</b> or an unsigned 16-bit integer and is optional. The default is <b>NoTopology</b> . If <b>NoTopology</b> or an integer are specified, then <i>Location</i> , <i>Connect</i> and <i>DriveBay</i> are prohibited. If <b>SAS</b> or <b>SATA</b> is specified, then <i>Location</i> and <i>Connect</i> are required, but <i>DriveBay</i> is optional. If an integer is specified, then the topology information is filled with the integer value. The <i>Location</i> is an integer between 0 and 1 or else the keyword <b>Internal</b> (0) or <b>External</b> (1) and is optional. If <i>SASSATA</i> is an integer or <b>NoTopology</b> , it is prohibited. The default value is 0. The <i>Connect</i> is an integer between 0 and 3 or else the keyword <b>Direct</b> (0) or <b>Expanded</b> (1) and is optional. If <i>SASSATA</i> is an integer or <b>NoTopology</b> , it is prohibited. The default value is 0. The <i>DriveBay</i> is an integer between 1 and 256 and is optional <b>unless</b> <i>SASSATA</i> is an integer or <b>NoTopology</b> , in which case it is prohibited. The <i>Reserved</i> field is an integer and is optional. The default value is 0.
Type: 3 (Messaging Device Path) SubType: 10 (Vendor) GUID=EFI_DEBUGPORT_ PROTOCOL_GUID	<b>DebugPort()</b>
Type: 3 (Messaging Device Path) SubType: 11 (MAC Address)	<b>MAC(MacAddr, IType)</b>  The <i>MacAddr</i> is a Hex Dump and is required. If <i>IType</i> is 0 or 1, then the <i>MacAddr</i> must be exactly six bytes. The <i>IType</i> is an integer from 0-255 and is optional. The default is zero.

Device Node Type/SubType/ Other	Description
Type: 3 (Messaging Device Path) SubType: 12 (IPv4)	<p><b>IPv4</b>(<i>Remotelp</i>, <i>Protocol</i>, <i>Type</i>, <i>Locallp</i>, <i>GatewayIPAddress</i>, <i>SubnetMask</i>)  <b>IPv4</b>(<i>Remotelp</i>) (Display Only)</p> <p>The <i>Remotelp</i> is an IP Address and is required.  The <i>Protocol</i> is an integer between 0 and 255 or else the keyword <b>UDP</b> (17) or <b>TCP</b> (6). The default value is <b>UDP</b>.  The <i>Type</i> is a keyword, either <b>Static</b> (1) or <b>DHCP</b> (0). It is optional. The default value is <b>DHCP</b>.  The <i>Locallp</i> is an IP Address and is optional. The default value is all zeroes.  The <i>GatewayIPAddress</i> is an IP Address and is optional. The default value is all zeroes.  The <i>SubnetMask</i> is an IP Address and is optional. The default value is all zeroes.</p>
Type: 3 (Messaging Device Path) SubType: 13 (IPv6)	<p><b>IPv6</b>(<i>Remotelp</i>, <i>Protocol</i>, <i>IPAddressOrigin</i>, <i>Locallp</i>, <i>GatewayIPAddress</i>, <i>SubnetMask</i>)  <b>IPv6</b>(<i>Remotelp</i>) (Display Only)</p> <p>The <i>Remotelp</i> is an IPv6 Address and is required.  The <i>Protocol</i> is an integer between 0 and 255 or else the keyword <b>UDP</b> (17) or <b>TCP</b> (6). The default value is <b>UDP</b>.  The <i>IPAddressOrigin</i> is a keyword, could be <b>Static</b> (0), <b>StatelessAutoConfigure</b> (1), or <b>StatefulAutoConfigure</b> (2).  The <i>Locallp</i> is the IPv6 Address and is optional. The default value is all zeroes.  The <i>GatewayIPAddress</i> is an IP Address. The <i>PrefixLength</i> is the prefix length of the Local IPv6 Address.  The <i>GatewayIPAddress</i> is the IPv6 Address of the Gateway.</p>
Type: 3 (Messaging Device Path) SubType: 14 (UART)	<p><b>Uart</b>(<i>Baud</i>, <i>DataBits</i>, <i>Parity</i>, <i>StopBits</i>)</p> <p>The <i>Baud</i> is a 64-bit integer and is optional. The default value is 115200.  The <i>DataBits</i> is an integer from 0 to 255 and is optional. The default value is 8.  The <i>Parity</i> is either an integer from 0-255 or else a keyword and should be <b>D</b> (0), <b>N</b> (1), <b>E</b> (2), <b>O</b> (3), <b>M</b> (4) or <b>S</b> (5). It is optional. The default value is 0.  The <i>StopBits</i> is a either an integer from 0-255 or else a keyword and should be <b>D</b> (0), <b>1</b> (1), <b>1.5</b> (2), <b>2</b> (3). It is optional. The default value is 0.</p>

Device Node Type/SubType/ Other	Description
Type: 3 (Messaging Device Path) SubType: 15 (USB Class)	<p><b>UsbClass</b>(<i>VID,PID,Class,SubClass,Protocol</i>)</p> <p>The <i>VID</i> is an integer between 0 and 65535 and is optional. The default value is 0xFFFF.</p> <p>The <i>PID</i> is an integer between 0 and 65535 and is optional. The default value is 0xFFFF.</p> <p>The <i>Class</i> is an integer between 0 and 255 and is optional. The default value is 0xFF.</p> <p>The <i>SubClass</i> is an integer between 0 and 255 and is optional. The default value is 0xFF.</p> <p>The <i>Protocol</i> is an integer between 0 and 255 and is optional. The default value is 0xFF.</p>
Type: 3 (Messaging Device Path) SubType: 15 (USB Class) Class 1	<p><b>UsbAudio</b>(<i>VID,PID,SubClass,Protocol</i>)</p> <p>The <i>VID</i> is an integer between 0 and 65535 and is optional. The default value is 0xFFFF.</p> <p>The <i>PID</i> is an integer between 0 and 65535 and is optional. The default value is 0xFFFF.</p> <p>The <i>SubClass</i> is an integer between 0 and 255 and is optional. The default value is 0xFF.</p> <p>The <i>Protocol</i> is an integer between 0 and 255 and is optional. The default value is 0xFF.</p>
Type: 3 (Messaging Device Path) SubType: 15 (USB Class) Class 2	<p><b>UsbCDCControl</b>(<i>VID,PID,SubClass,Protocol</i>)</p> <p>The <i>VID</i> is an optional integer between 0 and 65535 and is optional. The default value is 0xFFFF.</p> <p>The <i>PID</i> is an optional integer between 0 and 65535 and is optional. The default value is 0xFFFF.</p> <p>The <i>SubClass</i> is an optional integer between 0 and 255 and is optional. The default value is 0xFF.</p> <p>The <i>Protocol</i> is an optional integer between 0 and 255 and is optional. The default value is 0xFF.</p>
Type: 3 (Messaging Device Path) SubType: 15 (USB Class) Class 3	<p><b>UsbHID</b>(<i>VID,PID,SubClass,Protocol</i>)</p> <p>The <i>VID</i> is an integer between 0 and 65535 and is optional. The default value is 0xFFFF.</p> <p>The <i>PID</i> is an integer between 0 and 65535 and is optional. The default value is 0xFFFF.</p> <p>The <i>SubClass</i> is an integer between 0 and 255 and is optional. The default value is 0xFF.</p> <p>The <i>Protocol</i> is an integer between 0 and 255 and is optional. The default value is 0xFF.</p>

Device Node Type/SubType/ Other	Description
Type: 3 (Messaging Device Path) SubType: 15 (USB Class) Class 6	<b>UsbImage</b> ( <i>VID,PID,SubClass,Protocol</i> )  The <i>VID</i> is an integer between 0 and 65535 and is optional. The default value is 0xFFFF. The <i>PID</i> is an integer between 0 and 65535 and is optional. The default value is 0xFFFF. The <i>SubClass</i> is an integer between 0 and 255 and is optional. The default value is 0xFF. The <i>Protocol</i> is an integer between 0 and 255 and is optional. The default value is 0xFF.
Type: 3 (Messaging Device Path) SubType: 15 (USB Class) Class 7	<b>UsbPrinter</b> ( <i>VID,PID,SubClass,Protocol</i> )  The <i>VID</i> is an integer between 0 and 65535 and is optional. The default value is 0xFFFF. The <i>PID</i> is an integer between 0 and 65535 and is optional. The default value is 0xFFFF. The <i>SubClass</i> is an integer between 0 and 255 and is optional. The default value is 0xFF. The <i>Protocol</i> is an integer between 0 and 255 and is optional. The default value is 0xFF.
Type: 3 (Messaging Device Path) SubType: 15 (USB Class) Class 8	<b>UsbMassStorage</b> ( <i>VID,PID,SubClass,Protocol</i> )  The <i>VID</i> is an integer between 0 and 65535 and is optional. The default value is 0xFFFF. The <i>PID</i> is an integer between 0 and 65535 and is optional. The default value is 0xFFFF. The <i>SubClass</i> is an integer between 0 and 255 and is optional. The default value is 0xFF. The <i>Protocol</i> is an integer between 0 and 255 and is optional. The default value is 0xFF.
Type: 3 (Messaging Device Path) SubType: 15 (USB Class) Class 9	<b>UsbHub</b> ( <i>VID,PID,SubClass,Protocol</i> )  The <i>VID</i> is an integer between 0 and 65535 and is optional. The default value is 0xFFFF. The <i>PID</i> is an integer between 0 and 65535 and is optional. The default value is 0xFFFF. The <i>SubClass</i> is an integer between 0 and 255 and is optional. The default value is 0xFF. The <i>Protocol</i> is an integer between 0 and 255 and is optional. The default value is 0xFF.

Device Node Type/SubType/ Other	Description
Type: 3 (Messaging Device Path) SubType: 15 (USB Class) Class 10	<p><b>UsbCDCData</b>(<i>VID,PID,SubClass,Protocol</i>)</p> <p>The <i>VID</i> is an integer between 0 and 65535 and is optional. The default value is 0xFFFF.</p> <p>The <i>PID</i> is an integer between 0 and 65535 and is optional. The default value is 0xFFFF.</p> <p>The <i>SubClass</i> is an integer between 0 and 255 and is optional. The default value is 0xFF.</p> <p>The <i>Protocol</i> is an integer between 0 and 255 and is optional. The default value is 0xFF.</p>
Type: 3 (Messaging Device Path) SubType: 15 (USB Class) Class 11	<p><b>UsbSmartCard</b>(<i>VID,PID,SubClass,Protocol</i>)</p> <p>The <i>VID</i> is an integer between 0 and 65535 and is optional. The default value is 0xFFFF.</p> <p>The <i>PID</i> is an integer between 0 and 65535 and is optional. The default value is 0xFFFF.</p> <p>The <i>SubClass</i> is an integer between 0 and 255 and is optional. The default value is 0xFF.</p> <p>The <i>Protocol</i> is an integer between 0 and 255 and is optional. The default value is 0xFF.</p>
Type: 3 (Messaging Device Path) SubType: 15 (USB Class) Class 14	<p><b>UsbVideo</b>(<i>VID,PID,SubClass,Protocol</i>)</p> <p>The <i>VID</i> is an integer between 0 and 65535 and is optional. The default value is 0xFFFF.</p> <p>The <i>PID</i> is an integer between 0 and 65535 and is optional. The default value is 0xFFFF.</p> <p>The <i>SubClass</i> is an integer between 0 and 255 and is optional. The default value is 0xFF.</p> <p>The <i>Protocol</i> is an integer between 0 and 255 and is optional. The default value is 0xFF.</p>
Type: 3 (Messaging Device Path) SubType: 15 (USB Class) Class 220	<p><b>UsbDiagnostic</b>(<i>VID,PID,SubClass,Protocol</i>)</p> <p>The <i>VID</i> is an integer between 0 and 65535 and is optional. The default value is 0xFFFF.</p> <p>The <i>PID</i> is an integer between 0 and 65535 and is optional. The default value is 0xFFFF.</p> <p>The <i>SubClass</i> is an integer between 0 and 255 and is optional. The default value is 0xFF.</p> <p>The <i>Protocol</i> is an integer between 0 and 255 and is optional. The default value is 0xFF.</p>



Device Node Type/SubType/ Other	Description
Type: 3 (Messaging Device Path) SubType: 15 (USB Class) Class 224	<p><b>UsbWireless</b>(<i>VID,PID,SubClass,Protocol</i>)</p> <p>The <i>VID</i> is an integer between 0 and 65535 and is optional. The default value is 0xFFFF.</p> <p>The <i>PID</i> is an integer between 0 and 65535 and is optional. The default value is 0xFFFF.</p> <p>The <i>SubClass</i> is an integer between 0 and 255 and is optional. The default value is 0xFF.</p> <p>The <i>Protocol</i> is an integer between 0 and 255 and is optional. The default value is 0xFF.</p>
Type: 3 (Messaging Device Path) SubType: 15 (USB Class) Class 254 SubClass: 1	<p><b>UsbDeviceFirmwareUpdate</b>(<i>VID,PID,Protocol</i>)</p> <p>The <i>VID</i> is an integer between 0 and 65535 and is optional. The default value is 0xFFFF.</p> <p>The <i>PID</i> is an integer between 0 and 65535 and is optional. The default value is 0xFFFF.</p> <p>The <i>Protocol</i> is an integer between 0 and 255 and is optional. The default value is 0xFF.</p>
Type: 3 (Messaging Device Path) SubType: 15 (USB Class) Class 254 SubClass: 2	<p><b>UsblrdaBridge</b>(<i>VID,PID,Protocol</i>)</p> <p>The <i>VID</i> is an integer between 0 and 65535 and is optional. The default value is 0xFFFF.</p> <p>The <i>PID</i> is an integer between 0 and 65535 and is optional. The default value is 0xFFFF.</p> <p>The <i>Protocol</i> is an integer between 0 and 255 and is optional. The default value is 0xFF.</p>
Type: 3 (Messaging Device Path) SubType: 15 (USB Class) Class 254 SubClass: 3	<p><b>UsbTestAndMeasurement</b>(<i>VID,PID,Protocol</i>)</p> <p>The <i>VID</i> is an integer between 0 and 65535 and is optional. The default value is 0xFFFF.</p> <p>The <i>PID</i> is an integer between 0 and 65535 and is optional. The default value is 0xFFFF.</p> <p>The <i>Protocol</i> is an integer between 0 and 255 and is optional. The default value is 0xFF.</p>
Type: 3 (Messaging Device Path) SubType: 16 (USB WWID Class)	<p><b>UsbWwid</b>(<i>VID,PID,InterfaceNumber,"WWID"</i>)</p> <p>The <i>VID</i> is an integer between 0 and 65535 and is required.</p> <p>The <i>PID</i> is an integer between 0 and 65535 and is required.</p> <p>The <i>InterfaceNumber</i> is an integer between 0 and 255 and is required.</p> <p>The <i>WWID</i> is a string and is required.</p>
Type: 3 (Messaging Device Path) SubType: 17 (Logical Unit Class)	<p><b>Unit</b>(<i>LUN</i>)</p> <p>The <i>LUN</i> is an integer and is required.</p>

Device Node Type/SubType/ Other	Description
Type: 3 (Messaging Device Path) SubType: 18 (SATA)	<p><b>Sata</b>(<i>HPN, PMPN, LUN</i>)</p> <p>The <i>HPN</i> is an integer between 0 and 65534 and is required.                      The <i>PMPN</i> is an integer between 0 and 65535 and is optional. If not provided, the default is 0xFFFF, which implies no port multiplier.                      The <i>LUN</i> is a 16-bit integer. It is required. Note that LUN is applicable to ATAPI devices only, and most ATAPI devices assume LUN=0</p>
Type: 3 (Messaging Device Path) SubType: 19 (iSCSI)	<p><b>iSCSI</b>(<i>TargetName, PortalGroup, LUN, HeaderDigest, DataDigest, Authentication, Protocol</i>)</p> <p>The <i>TargetName</i> is a string and is required.                      The <i>PortalGroup</i> is an unsigned 16-bit integer and is required.                      The <i>LUN</i> is an 8 byte array that is displayed in hexadecimal format with byte 0 first (i.e., on the left) and byte 7 last (i.e., on the right), and is required.                      The <i>HeaderDigest</i> is a keyword None or CRC32C is optional. The default is None.                      The <i>DataDigest</i> is a keyword None or CRC32C is optional. The default is None.                      The <i>Authentication</i> is a keyword None or CHAP_BI or CHAP_UNI and optional. The default is None.                      The <i>Protocol</i> defines the network protocol used by iSCSI and is optional. The default is TCP.</p>
Type: 3 (Messaging Device Path) SubType: 20 (VLAN)	<p><b>Vlan</b>(<i>VlanId</i>)</p>

Device Node Type/SubType/ Other	Description
Type: 3 (Messaging Device Path) SubType: 22 (Serial Attached SCSI Ex)	<p><b>SasEx</b>(<i>Address, LUN, RTP, SASSATA, Location, Connect, DriveBay</i>)</p> <p>The <i>Address</i> is an 8 byte array that is displayed in hexadecimal format with byte 0 first (i.e., on the left) and byte 7 last (i.e., on the right), and is required.</p> <p>The <i>LUN</i> is an 8 byte array that is displayed in hexadecimal format with byte 0 first (i.e., on the left) and byte 7 last (i.e., on the right), and is optional. The default value is 0.</p> <p>The <i>RTP</i> is a 16-bit unsigned integer representing the Relative Target Port and is optional. The default value is 0.</p> <p>The <i>SASSATA</i> is a keyword <b>SAS</b> or <b>SATA</b> or <b>NoTopology</b> or an unsigned 16-bit integer and is optional. The default is NoTopology. If NoTopology or an integer are specified, then <i>Location, Connect</i> and <i>DriveBay</i> are prohibited. If <b>SAS</b> or <b>SATA</b> is specified, then <i>Location</i> and <i>Connect</i> are required, but <i>DriveBay</i> is optional. If an integer is specified, then the topology information is filled with the integer value.</p> <p>The <i>Location</i> is an integer between 0 and 1 or else the keyword <b>Internal</b> (0) or <b>External</b> (1) and is optional. If <i>SASSATA</i> is an integer or <b>NoTopology</b>, it is prohibited. The default value is 0.</p> <p>The <i>Connect</i> is an integer between 0 and 3 or else the keyword <b>Direct</b> (0) or <b>Expanded</b> (1) and is optional. If <i>SASSATA</i> is an integer or <b>NoTopology</b>, it is prohibited. The default value is 0.</p> <p>The <i>DriveBay</i> is an integer between 1 and 256 and is optional unless <i>SASSATA</i> is an integer or <b>NoTopology</b>, in which case it is prohibited.</p>
Type: 3 (Messaging Device Path) SubType: 23 (NVM Express Namespace)	<p><b>NVMe</b>(<i>NSID, EUI</i>)</p> <p>The <i>NSID</i> is a namespace identifier that is displayed in hexadecimal format with an integer value between 0 and 0xFFFFFFFF.</p> <p>The <i>EUI</i> is the IEEE Extended Unique Identifier (EUI-64) that is displayed in hexadecimal format represented as a set of octets separated by dashes (hexadecimal notation), e.g., FF-FF-FF-FF-FF-FF-FF-FF-FF.</p>
Type: 3 (Messaging Device Path) SubType: 24 (URI)	<p><b>Uri</b>(<i>Uri</i>)</p> <p>The <i>Uri</i> is optional.</p>
Type: 3 (Messaging Device Path) SubType: 25 (Universal Flash Storage)	<p><b>UFS</b>(<i>PUN, LUN</i>)</p> <p>The <i>PUN</i> is 0 for current UFS2.0 spec. For future UFS specs which support multiple devices on a UFS port, it would reflect the device ID on the UFS port.</p> <p>The <i>LUN</i> is 0-7 for common LUNs or 81h, D0h, B0h and C4h for well-known LUNs supported by UFS.</p>
Type: 3 (Messaging Device Path) SubType: 26 (SD)	<p><b>SD</b>(<i>Slot Number</i>)</p> <p><i>SlotNumber</i> is an integer. It is optional and has a default value of 0.</p>

Device Node Type/SubType/ Other	Description
Type: 3 (Messaging Device Path) SubType: 27 (Bluetooth)	<b>Bluetooth(BD_ADDR)</b>  <i>BD_ADDR</i> is HEX dump of 48-bit Bluetooth device address.
Type: 3 (Messaging Device Path)  SubType: 28 (Wi-Fi)	<b>Wi-Fi(SSID)</b> The <i>SSID</i> is a string and is required.
Type: 3 (Messaging Device Path) SubType: 29 (eMMC)	<b>eMMC(SlotNumber)</b> SlotNumber is an integer. It is optional and has a default value of 0.
Type: 3 (Messaging Device Path) SubType: 30 (BluetoothLE)	<b>BluetoothLE(BD_ADDR, AddressType)</b> BD_ADDR is HEX dump of 48-bit Bluetooth device address. AddressType is an integer.
Type: 3 (Messaging Device Path) SubType: 31 (DNS)	<b>Dns(DnsServerIp[, DnsServerIp...])</b> DnsServerIp is optional. It is the IP address of DNS server.
Type: 4 (Media Device Path) (when subtype is not recognized)	<b>MediaPath(subtype, data)</b> The <i>subtype</i> is an integer from 0-255 and is required. The <i>data</i> is a hex dump.
Type: 4 (Media Device Path) SubType: 1 (Hard Drive)	<b>HD(Partition, Type, Signature, Start, Size)</b> <b>HD(Partition, Type, Signature)</b> (Display Only)  The <i>Partition</i> is an integer representing the partition number. It is optional and the default is 0. If <i>Partition</i> is 0, then <i>Start</i> and <i>Size</i> are prohibited. The <i>Type</i> is an integer between 0-255 or else the keyword <b>MBR</b> (1) or <b>GPT</b> (2). The type is optional and the default is 2. The <i>Signature</i> is an integer if <i>Type</i> is 1 or else GUID if <i>Type</i> is 2. The signature is required. The <i>Start</i> is a 64-bit unsigned integer. It is prohibited if <i>Partition</i> is 0. Otherwise it is required. The <i>Size</i> is a 64-bit unsigned integer. It is prohibited if <i>Partition</i> is 0. Otherwise it is required.
Type: 4 (Media Device Path) SubType: 2 (CD-ROM)	<b>CDROM(Entry, Start, Size)</b> <b>CDROM(Entry)</b> (Display Only)  The <i>Entry</i> is an integer representing the Boot Entry from the Boot Catalog. It is optional and the default is 0. The <i>Start</i> is a 64-bit integer and is required. The <i>Size</i> is a 64-bit integer and is required.
Type: 4 (Media Device Path) SubType: 3 (Vendor)	<b>VenMedia(GUID, Data)</b>  The <i>Guid</i> is a GUID and is required. The <i>Data</i> is a Hex Dump and is option. The default value is zero bytes.
Type: 4 (Media Device Path) SubType: 4 (File Path)	<b>String</b>  The <i>String</i> is the file path and is a string.

Device Node Type/SubType/Other	Description
Type: 4 (Media Device Path) SubType: 5 (Media Protocol)	<b>Media</b> ( <i>Guid</i> )  The <i>Guid</i> is a GUID and is required.
Type: 4 (Media Device Path) SubType: 6 (PIWG Firmware File)	Contents are defined in the UEFI <i>PI Specification</i> .
Type: 4 (Media Device Path) SubType: 7 (PIWG Firmware Volume)	Contents are defined in the UEFI <i>PI Specification</i> .
Type: 4 (Media Device Path) SubType: 8 (Relative Offset Range)	<b>Offset</b> ( <i>StartingOffset,EndingOffset</i> ) The <i>StartingOffset</i> is an unsigned 64-bit integer. The <i>EndingOffset</i> is an unsigned 64-bit integer.
Type: 4 (Media Device Path) SubType: 9 (RAM Disk)	<b>RamDisk</b> ( <i>StartingAddress,EndingAddress,DiskInstance,DiskTypeGuid</i> )  The <i>StartingAddress</i> and <i>EndingAddress</i> are both 64-bit integers and are both required. The <i>DiskInstance</i> is a 16-bit integer and is optional. The default value is 0. The <i>DiskTypeGuid</i> is a GUID and is required.
Type: 4 (Media Device Path) SubType: 9 (RAM Disk) Disk Type GUID= EFI_VIRTUAL_DISK_GUID	<b>VirtualDisk</b> ( <i>StartingAddress,EndingAddress,DiskInstance</i> )  The <i>StartingAddress</i> and <i>EndingAddress</i> are both 64-bit integers and are both required. The <i>DiskInstance</i> is a 16-bit integer and is optional. The default value is 0.
Type: 4 (Media Device Path) SubType: 9 (RAM Disk) Disk Type GUID= EFI_VIRTUAL_CD_GUID	<b>VirtualCD</b> ( <i>StartingAddress,EndingAddress,DiskInstance</i> )  The <i>StartingAddress</i> and <i>EndingAddress</i> are both 64-bit integers and are both required. The <i>DiskInstance</i> is a 16-bit integer and is optional. The default value is 0.
Type: 4 (Media Device Path) SubType: 9 (RAM Disk) Disk Type GUID= EFI_PERSISTENT_VIRTUAL_DISK_GUID	<b>PersistentVirtualDisk</b> ( <i>StartingAddress,EndingAddress,DiskInstance</i> )  The <i>StartingAddress</i> and <i>EndingAddress</i> are both 64-bit integers and are both required. The <i>DiskInstance</i> is a 16-bit integer and is optional. The default value is 0.
Type: 4 (Media Device Path) SubType: 9 (RAM Disk) Disk Type GUID= EFI_PERSISTENT_VIRTUAL_CD_GUID	<b>PersistentVirtualCD</b> ( <i>StartingAddress,EndingAddress,DiskInstance</i> ) The <i>StartingAddress</i> and <i>EndingAddress</i> are both 64-bit integers and are both required. The <i>DiskInstance</i> is a 16-bit integer and is optional. The default value is 0.

Device Node Type/SubType/Other	Description
Type: 5 (Media Device Path)  (when subtype is not recognized)	<b>BbsPath</b> ( <i>subtype, data</i> )  The <i>subtype</i> is an integer from 0-255. The <i>data</i> is a hex dump.
Type: 5 (BIOS Boot Specification Device Path) SubType: 1 (BBS 1.01)	<b>BBS</b> ( <i>Type,Id,Flags</i> ) <b>BBS</b> ( <i>Type, Id</i> ) (Display Only) The <i>Type</i> is an integer from 0-65535 or else one of the following keywords: <b>Floppy</b> (1), <b>HD</b> (2), <b>CDROM</b> (3), <b>PCMCIA</b> (4), <b>USB</b> (5), <b>Network</b> (6). It is required. The <i>Id</i> is a string and is required. The <i>Flags</i> are an integer and are optional. The default value is 0.

## 10.6.2 Device Path to Text Protocol

### EFI\_DEVICE\_PATH\_TO\_TEXT\_PROTOCOL

#### Summary

Convert device nodes and paths to text

#### GUID

```
#define EFI_DEVICE_PATH_TO_TEXT_PROTOCOL_GUID \
{0x8b843e20,0x8132,0x4852,\
{0x90,0xcc,0x55,0x1a,0x4e,0x4a,0x7f,0x1c}}
```

#### Protocol Interface Structure

```
typedef struct _EFI_DEVICE_PATH_TO_TEXT_PROTOCOL {
    EFI_DEVICE_PATH_TO_TEXT_NODE ConvertDeviceNodeToText;
    EFI_DEVICE_PATH_TO_TEXT_PATH ConvertDevicePathToText;
} EFI_DEVICE_PATH_TO_TEXT_PROTOCOL;
```

#### Parameters

*ConvertDeviceNodeToText* Converts a device node to text.

*ConvertDevicePathToText* Converts a device path to text.

#### Description

The **EFI\_DEVICE\_PATH\_TO\_TEXT\_PROTOCOL** provides common utility functions for converting device nodes and device paths to a text representation.

## EFI\_DEVICE\_PATH\_TO\_TEXT\_PROTOCOL.ConvertDeviceNodeToText()

### Summary

Convert a device node to its text representation.

### Prototype

```
typedef
CHAR16*
(EFI_API *EFI_DEVICE_PATH_TO_TEXT_NODE) (
    IN CONST EFI_DEVICE_PATH_PROTOCOL* DeviceNode,
    IN BOOLEAN DisplayOnly,
    IN BOOLEAN AllowShortcuts
);
```

### Parameters

<i>DeviceNode</i>	Points to the device node to be converted.
<i>DisplayOnly</i>	If <i>DisplayOnly</i> is <b>TRUE</b> , then the shorter text representation of the display node is used, where applicable. If <i>DisplayOnly</i> is <b>FALSE</b> , then the longer text representation of the display node is used.
<i>AllowShortcuts</i>	If <i>AllowShortcuts</i> is <b>TRUE</b> , then the shortcut forms of text representation for a device node can be used, where applicable.

### Description

The ConvertDeviceNodeToText function converts a device node to its text representation and copies it into a newly allocated buffer.

The *DisplayOnly* parameter controls whether the longer (parseable) or shorter (display-only) form of the conversion is used.

The *AllowShortcuts* is **FALSE**, then the shortcut forms of text representation for a device node cannot be used. A shortcut form is one which uses information other than the type or subtype.

The memory is allocated from EFI boot services memory. It is the responsibility of the caller to free the memory allocated.

### Related Definitions

**EFI\_DEVICE\_PATH\_PROTOCOL** is defined in [Section 10.2](#).

### Returns

This function returns the pointer to the allocated text representation of the device node data or else NULL if *DeviceNode* was NULL or there was insufficient memory.

## EFI\_DEVICE\_PATH\_TO\_TEXT\_PROTOCOL.ConvertDevicePathToText()

### Summary

Convert a device path to its text representation.

### Prototype

```
typedef
CHAR16*
(EFI_API *EFI_DEVICE_PATH_TO_TEXT_PATH) (
  IN CONST EFI_DEVICE_PATH_PROTOCOL *DevicePath,
  IN BOOLEAN DisplayOnly,
  IN BOOLEAN AllowShortcuts
);
```

### Parameters

<i>DeviceNode</i>	Points to the device path to be converted.
<i>DisplayOnly</i>	If <i>DisplayOnly</i> is TRUE, then the shorter text representation of the display node is used, where applicable. If <i>DisplayOnly</i> is FALSE, then the longer text representation of the display node is used.
<i>AllowShortcuts</i>	The <i>AllowShortcuts</i> is FALSE, then the shortcut forms of text representation for a device node cannot be used.

### Description

This function converts a device path into its text representation and copies it into an allocated buffer.

The *DisplayOnly* parameter controls whether the longer (parseable) or shorter (display-only) form of the conversion is used.

The *AllowShortcuts* is **FALSE**, then the shortcut forms of text representation for a device node cannot be used. A shortcut form is one which uses information other than the type or subtype.

The memory is allocated from EFI boot services memory. It is the responsibility of the caller to free the memory allocated.

### Related Definitions

**EFI\_DEVICE\_PATH\_PROTOCOL** is defined in [Section 10.2](#).

### Returns

This function returns a pointer to the allocated text representation of the device node or NULL if *DevicePath* was NULL or there was insufficient memory.



## 10.6.3 Device Path from Text Protocol

### EFI\_DEVICE\_PATH\_FROM\_TEXT\_PROTOCOL

#### Summary

Convert text to device paths and device nodes.

#### GUID

```
#define EFI_DEVICE_PATH_FROM_TEXT_PROTOCOL_GUID \
{0x5c99a21,0xc70f,0x4ad2,\
 {0x8a,0x5f,0x35,0xdf,0x33,0x43,0xf5, 0x1e}}
```

#### Protocol Interface Structure

```
typedef struct _EFI_DEVICE_PATH_FROM_TEXT_PROTOCOL {
  EFI_DEVICE_PATH_FROM_TEXT_NODE ConvertTextToDeviceNode;
  EFI_DEVICE_PATH_FROM_TEXT_PATH ConvertTextToDevicePath;
} EFI_DEVICE_PATH_FROM_TEXT_PROTOCOL;
```

#### Parameters

*ConvertTextToDeviceNode* Converts text to a device node.

*ConvertTextToDevicePath* Converts text to a device path.

#### Description

The **EFI\_DEVICE\_PATH\_FROM\_TEXT\_PROTOCOL** provides common utilities for converting text to device paths and device nodes.

## EFI\_DEVICE\_PATH\_FROM\_TEXT\_PROTOCOL.ConvertTextToDeviceNode()

### Summary

Convert text to the binary representation of a device node.

### Prototype

```
typedef
EFI_DEVICE_PATH_PROTOCOL*
(EFI_API *EFI_DEVICE_PATH_FROM_TEXT_NODE) (
    IN CONST CHAR16* TextDeviceNode
);
```

### Parameters

*TextDeviceNode*

*TextDeviceNode* points to the text representation of a device node. Conversion starts with the first character and continues until the first non-device node character.

### Description

This function converts text to its binary device node representation and copies it into an allocated buffer.

The memory is allocated from EFI boot services memory. It is the responsibility of the caller to free the memory allocated.

### Related Definitions

**EFI\_DEVICE\_PATH\_PROTOCOL** is defined in [Section 10.2](#).

### Returns

This function returns a pointer to the EFI device node or NULL if *TextDeviceNode* is NULL or there was insufficient memory.

## EFI\_DEVICE\_PATH\_FROM\_TEXT\_PROTOCOL.ConvertTextToDevicePath ()

### Summary

Convert a text to its binary device path representation.

### Prototype

```
typedef
EFI_DEVICE_PATH_PROTOCOL*
(EFI_API *EFI_DEVICE_PATH_FROM_TEXT_PATH) (
    IN CONST CHAR16* TextDevicePath
);
```

### Parameters

*TextDevicePath*

*TextDevicePath* points to the text representation of a device path. Conversion starts with the first character and continues until the first non-device path character.

### Description

This function converts text to its binary device path representation and copies it into an allocated buffer.

The memory is allocated from EFI boot services memory. It is the responsibility of the caller to free the memory allocated.

### Related Definitions

**EFI\_DEVICE\_PATH\_PROTOCOL** is defined in [Section 10.2](#).

### Returns

This function returns a pointer to the allocated device path or NULL if *TextDevicePath* is NULL or there was insufficient memory.



## 11 Protocols — UEFI Driver Model

---

EFI drivers that follow the UEFI *Driver Model* are not allowed to search for controllers to manage. When a specific controller is needed, the EFI boot service [EFI\\_BOOT\\_SERVICES.ConnectController\(\)](#) is used along with the [EFI\\_DRIVER\\_BINDING\\_PROTOCOL](#) services to identify the best drivers for a controller. Once [ConnectController\(\)](#) has identified the best drivers for a controller, the start service in the [EFI\\_DRIVER\\_BINDING\\_PROTOCOL](#) is used by [ConnectController\(\)](#) to start each driver on the controller. Once a controller is no longer needed, it can be released with the EFI boot service [EFI\\_BOOT\\_SERVICES.DisconnectController\(\)](#). [DisconnectController\(\)](#) calls the stop service in each [EFI\\_DRIVER\\_BINDING\\_PROTOCOL](#) to stop the controller.

The driver initialization routine of an UEFI driver is not allowed to touch any device hardware. Instead, it just installs an instance of the [EFI\\_DRIVER\\_BINDING\\_PROTOCOL](#) on the *ImageHandle* of the UEFI driver. The test to determine if a driver supports a given controller must be performed in as little time as possible without causing any side effects on any of the controllers it is testing. As a result, most of the controller initialization code is present in the start and stop services of the [EFI\\_DRIVER\\_BINDING\\_PROTOCOL](#).

### 11.1 EFI Driver Binding Protocol

This section provides a detailed description of the [EFI\\_DRIVER\\_BINDING\\_PROTOCOL](#). This protocol is produced by every driver that follows the UEFI *Driver Model*, and it is the central component that allows drivers and controllers to be managed. It provides a service to test if a specific controller is supported by a driver, a service to start managing a controller, and a service to stop managing a controller. These services apply equally to drivers for both bus controllers and device controllers.

#### EFI\_DRIVER\_BINDING\_PROTOCOL

##### Summary

Provides the services required to determine if a driver supports a given controller. If a controller is supported, then it also provides routines to start and stop the controller.

##### GUID

```
#define EFI_DRIVER_BINDING_PROTOCOL_GUID \
{0x18A031AB,0xB443,0x4D1A,\
{0xA5,0xC0,0x0C,0x09,0x26,0x1E,0x9F,0x71}}
```

##### Protocol Interface Structure

```
typedef struct _EFI_DRIVER_BINDING_PROTOCOL {
EFI_DRIVER_BINDING_PROTOCOL_SUPPORTED Supported;
EFI_DRIVER_BINDING_PROTOCOL_START Start;
EFI_DRIVER_BINDING_PROTOCOL_STOP Stop;
```

```

UINT32          Version;
EFI_HANDLE     ImageHandle;
EFI_HANDLE     DriverBindingHandle;
} EFI_DRIVER_BINDING_PROTOCOL;
    
```

## Parameters

<i>Supported</i>	Tests to see if this driver supports a given controller. This service is called by the EFI boot service <a href="#">EFI_BOOT_SERVICES.ConnectController()</a> . In order to make drivers as small as possible, there are a few calling restrictions for this service. <b>ConnectController()</b> must follow these calling restrictions. If any other agent wishes to call <a href="#">Supported()</a> it must also follow these calling restrictions. See the <b>Supported()</b> function description.
<i>Start</i>	Starts a controller using this driver. This service is called by the EFI boot service <b>ConnectController()</b> . In order to make drivers as small as possible, there are a few calling restrictions for this service. <b>ConnectController()</b> must follow these calling restrictions. If any other agent wishes to call <a href="#">Start()</a> it must also follow these calling restrictions. See the <b>Start()</b> function description.
<i>Stop</i>	Stops a controller using this driver. This service is called by the EFI boot service <a href="#">EFI_BOOT_SERVICES.DisconnectController()</a> . In order to make drivers as small as possible, there are a few calling restrictions for this service. <b>DisconnectController()</b> must follow these calling restrictions. If any other agent wishes to call <a href="#">Stop()</a> it must also follow these calling restrictions. See the <b>Stop()</b> function description.
<i>Version</i>	The version number of the UEFI driver that produced the <b>EFI_DRIVER_BINDING_PROTOCOL</b> . This field is used by the EFI boot service <b>ConnectController()</b> to determine the order that driver's <b>Supported()</b> service will be used when a controller needs to be started. EFI Driver Binding Protocol instances with higher <i>Version</i> values will be used before ones with lower <i>Version</i> values. The <i>Version</i> values of <i>0x0-0x0f</i> and <i>0xffffffff0-0xffffffff</i> are reserved for platform/OEM specific drivers. The <i>Version</i> values of <i>0x10-0xffffffffef</i> are reserved for IHV-developed drivers.
<i>ImageHandle</i>	The image handle of the UEFI driver that produced this instance of the <b>EFI_DRIVER_BINDING_PROTOCOL</b> .
<i>DriverBindingHandle</i>	The handle on which this instance of the <b>EFI_DRIVER_BINDING_PROTOCOL</b> is installed. In most cases, this is the same handle as <i>ImageHandle</i> . However, for UEFI drivers that produce more than one instance of the <b>EFI_DRIVER_BINDING_PROTOCOL</b> , this value may not be the same as <i>ImageHandle</i> .

## Description

The **EFI\_DRIVER\_BINDING\_PROTOCOL** provides a service to determine if a driver supports a given controller. If a controller is supported, then it also provides services to start and stop the controller. All UEFI drivers are required to be reentrant so they can manage one or more controllers. This requires that drivers not use global variables to store device context. Instead, they must allocate a separate context structure per controller that the driver is managing. Bus drivers must support starting and stopping the same bus multiple times, and they must also support starting and stopping all of their children, or just a subset of their children.

## EFI\_DRIVER\_BINDING\_PROTOCOL.Supported()

### Summary

Tests to see if this driver supports a given controller. If a child device is provided, it further tests to see if this driver supports creating a handle for the specified child device.

### Prototype

```
typedef
EFI_STATUS
(EFIAPI *EFI_DRIVER_BINDING_PROTOCOL_SUPPORTED) (
    IN EFI_DRIVER_BINDING_PROTOCOL *This,
    IN EFI_HANDLE      ControllerHandle,
    IN EFI_DEVICE_PATH_PROTOCOL *RemainingDevicePath OPTIONAL
);
```

### Parameters

<i>This</i>	A pointer to the <a href="#">EFI_DRIVER_BINDING_PROTOCOL</a> instance.
<i>ControllerHandle</i>	The handle of the controller to test. This handle must support a protocol interface that supplies an I/O abstraction to the driver. Sometimes just the presence of this I/O abstraction is enough for the driver to determine if it supports <i>ControllerHandle</i> . Sometimes, the driver may use the services of the I/O abstraction to determine if this driver supports <i>ControllerHandle</i> .
<i>RemainingDevicePath</i>	A pointer to the remaining portion of a device path. For bus drivers, if this parameter is not <b>NULL</b> , then the bus driver must determine if the bus controller specified by <i>ControllerHandle</i> and the child controller specified by <i>RemainingDevicePath</i> are both supported by this bus driver.

### Description

This function checks to see if the driver specified by *This* supports the device specified by *ControllerHandle*. Drivers will typically use the device path attached to *ControllerHandle* and/or the services from the bus I/O abstraction attached to *ControllerHandle* to determine if the driver supports *ControllerHandle*. This function may be called many times during platform initialization. In order to reduce boot times, the tests performed by this function must be very small, and take as little time as possible to execute. This function must not change the state of any hardware devices, and this function must be aware that the device specified by *ControllerHandle* may already be managed by the same driver or a different driver. This function must match its calls to [EFI\\_BOOT\\_SERVICES.AllocatePages\(\)](#) with [EFI\\_BOOT\\_SERVICES.FreePages\(\)](#), [EFI\\_BOOT\\_SERVICES.AllocatePool\(\)](#) with [EFI\\_BOOT\\_SERVICES.FreePool\(\)](#), and [EFI\\_BOOT\\_SERVICES.OpenProtocol\(\)](#) with [EFI\\_BOOT\\_SERVICES.CloseProtocol\(\)](#). Since *ControllerHandle* may have been previously started by the same driver, if a protocol is



already in the opened state, then it must not be closed with **CloseProtocol()**. This is required to guarantee the state of *ControllerHandle* is not modified by this function.

If any of the protocol interfaces on the device specified by *ControllerHandle* that are required by the driver specified by *This* are already open for exclusive access by a different driver or application, then **EFI\_ACCESS\_DENIED** is returned.

If any of the protocol interfaces on the device specified by *ControllerHandle* that are required by the driver specified by *This* are already opened by the same driver, then **EFI\_ALREADY\_STARTED** is returned. However, if the driver specified by *This* is a bus driver, then it is not an error, and the bus driver should continue with its test of *ControllerHandle* and *RemainingDevicePath*. This allows a bus driver to create one child handle on the first call to **Supported()** and **Start()**, and create additional child handles on additional calls to **Supported()** and **Start()**. This also allows a bus driver to create no child handle on the first call to **Supported()** and **Start()** by specifying an End of Device Path Node *RemainingDevicePath*, and create additional child handles on additional calls to **Supported()** and **Start()**.

If *ControllerHandle* is not supported by *This*, then **EFI\_UNSUPPORTED** is returned.

If *This* is a bus driver that creates child handles with an **EFI\_DEVICE\_PATH\_PROTOCOL**, then *ControllerHandle* must support the **EFI\_DEVICE\_PATH\_PROTOCOL**. If it does not, then **EFI\_UNSUPPORTED** is returned.

If *ControllerHandle* is supported by *This*, and *This* is a device driver, then **EFI\_SUCCESS** is returned.

If *ControllerHandle* is supported by *This*, and *This* is a bus driver, and *RemainingDevicePath* is **NULL** or the first Device Path Node is the End of Device Path Node, then **EFI\_SUCCESS** is returned.

If *ControllerHandle* is supported by *This*, and *This* is a bus driver, and *RemainingDevicePath* is not **NULL**, then *RemainingDevicePath* must be analyzed. If the first node of **RemainingDevicePath** is the End of Device Path Node or an EFI Device Path node that the bus driver recognizes and supports, then **EFI\_SUCCESS** is returned. Otherwise, **EFI\_UNSUPPORTED** is returned.

The **Supported()** function is designed to be invoked from the EFI boot service **EFI\_BOOT\_SERVICES.ConnectController()**. As a result, much of the error checking on the parameters to **Supported()** has been moved into this common boot service. It is legal to call **Supported()** from other locations, but the following calling restrictions must be followed or the system behavior will not be deterministic.

*ControllerHandle* must be a valid **EFI\_HANDLE**. If *RemainingDevicePath* is not **NULL**, then it must be a pointer to a naturally aligned **EFI\_DEVICE\_PATH\_PROTOCOL**.

## Status Codes Returned

EFI_SUCCESS	The device specified by <i>ControllerHandle</i> and <i>RemainingDevicePath</i> is supported by the driver specified by <i>This</i> .
EFI_ALREADY_STARTED	The device specified by <i>ControllerHandle</i> and <i>RemainingDevicePath</i> is already being managed by the driver specified by <i>This</i> .
EFI_ACCESS_DENIED	The device specified by <i>ControllerHandle</i> and <i>RemainingDevicePath</i> is already being managed by a different driver or an application that requires exclusive access.
EFI_UNSUPPORTED	The device specified by <i>ControllerHandle</i> and <i>RemainingDevicePath</i> is not supported by the driver specified by <i>This</i> .

## Examples

```
extern EFI_GUID    gEfiDriverBindingProtocolGuid;
EFI_HANDLE        DriverImageHandle;
EFI_HANDLE        ControllerHandle;
EFI_DRIVER_BINDING_PROTOCOL *DriverBinding;
EFI_DEVICE_PATH_PROTOCOL *RemainingDevicePath;

//
// Use the DriverImageHandle to get the Driver Binding Protocol instance
//
Status = gBS->OpenProtocol (
    DriverImageHandle,
    &gEfiDriverBindingProtocolGuid,
    &DriverBinding,
    DriverImageHandle,
    NULL,
    EFI_OPEN_PROTOCOL_GET_PROTOCOL
);
if (EFI_ERROR (Status)) {
    return Status;
}

//
// EXAMPLE #1
//
// Use the Driver Binding Protocol instance to test to see if the
// driver specified by DriverImageHandle supports the controller
// specified by ControllerHandle
//
Status = DriverBinding->Supported (
    DriverBinding,
    ControllerHandle,
    NULL
);
return Status;

//
// EXAMPLE #2
```

```

//
// The RemainingDevicePath parameter can be used to initialize only
// the minimum devices required to boot. For example, maybe we only
// want to initialize 1 hard disk on a SCSI channel. If DriverImageHandle
// is a SCSI Bus Driver, and ControllerHandle is a SCSI Controller, and
// we only want to create a child handle for PUN=3 and LUN=0, then the
// RemainingDevicePath would be SCSI(3,0)/END. The following example
// would return EFI_SUCCESS if the SCSI driver supports creating the
// child handle for PUN=3, LUN=0. Otherwise it would return an error.
//
Status = DriverBinding->Supported (
    DriverBinding,
    ControllerHandle,
    RemainingDevicePath
);
return Status;

```

## Pseudo Code

Listed below are the algorithms for the [Supported\(\)](#) function for three different types of drivers. How the [Start\(\)](#) function of a driver is implemented can affect how the [Supported\(\)](#) function is implemented. All of the services in the [EFI\\_DRIVER\\_BINDING\\_PROTOCOL](#) need to work together to make sure that all resources opened or allocated in [Supported\(\)](#) and [Start\(\)](#) are released in [Stop\(\)](#).

The first algorithm is a simple device driver that does not create any additional handles. It only attaches one or more protocols to an existing handle. The second is a bus driver that always creates all of its child handles on the first call to [Start\(\)](#). The third is a more advanced bus driver that can either create one child handles at a time on successive calls to [Start\(\)](#), or it can create all of its child handles or all of the remaining child handles in a single call to [Start\(\)](#).

### Device Driver:

1. Ignore the parameter *RemainingDevicePath*.
2. Open all required protocols with [EFI\\_BOOT\\_SERVICES.OpenProtocol\(\)](#). A standard driver should use an *Attribute* of [EFI\\_OPEN\\_PROTOCOL\\_BY\\_DRIVER](#). If this driver needs exclusive access to a protocol interface, and it requires any drivers that may be using the protocol interface to disconnect, then the driver should use an *Attribute* of [EFI\\_OPEN\\_PROTOCOL\\_BY\\_DRIVER | EFI\\_OPEN\\_PROTOCOL\\_EXCLUSIVE](#).
3. If any of the calls to [OpenProtocol\(\)](#) in (2) returned an error, then close all of the protocols opened in (2) with [EFI\\_BOOT\\_SERVICES.CloseProtocol\(\)](#), and return the status code from the call to [OpenProtocol\(\)](#) that returned an error.
4. Use the protocol instances opened in (2) to test to see if this driver supports the controller. Sometimes, just the presence of the protocols is enough of a test. Other times, the services of the protocols opened in (2) are used to further check the identity of the controller. If any of these tests fails, then close all the protocols opened in (2) with [CloseProtocol\(\)](#) and return [EFI\\_UNSUPPORTED](#).
5. Close all protocols opened in (2) with [CloseProtocol\(\)](#).
6. Return [EFI\\_SUCCESS](#).

### Bus Driver that creates all of its child handles on the first call to Start():

1. Check the contents of the first Device Path Node of *RemainingDevicePath* to make sure it is the End of Device Path Node or a legal Device Path Node for this bus driver's children. If it is not, then return **EFI\_UNSUPPORTED**.
2. Open all required protocols with [EFI\\_BOOT\\_SERVICES.OpenProtocol\(\)](#). A standard driver should use an *Attribute* of **EFI\_OPEN\_PROTOCOL\_BY\_DRIVER**. If this driver needs exclusive access to a protocol interface, and it requires any drivers that may be using the protocol interface to disconnect, then the driver should use an *Attribute* of **EFI\_OPEN\_PROTOCOL\_BY\_DRIVER | EFI\_OPEN\_PROTOCOL\_EXCLUSIVE**.
3. If any of the calls to **OpenProtocol()** in (2) returned an error, then close all of the protocols opened in (2) with [EFI\\_BOOT\\_SERVICES.CloseProtocol\(\)](#), and return the status code from the call to **OpenProtocol()** that returned an error.
4. Use the protocol instances opened in (2) to test to see if this driver supports the controller. Sometimes, just the presence of the protocols is enough of a test. Other times, the services of the protocols opened in (2) are used to further check the identity of the controller. If any of these tests fails, then close all the protocols opened in (2) with **CloseProtocol()** and return **EFI\_UNSUPPORTED**.
5. Close all protocols opened in (2) with **CloseProtocol()**.
6. Return **EFI\_SUCCESS**.

**Bus Driver that is able to create all or one of its child handles on each call to Start():**

1. Check the contents of the first Device Path Node of *RemainingDevicePath* to make sure it is the End of Device Path Node or a legal Device Path Node for this bus driver's children. If it is not, then return **EFI\_UNSUPPORTED**.
2. Open all required protocols with **OpenProtocol()**. A standard driver should use an *Attribute* of **EFI\_OPEN\_PROTOCOL\_BY\_DRIVER**. If this driver needs exclusive access to a protocol interface, and it requires any drivers that may be using the protocol interface to disconnect, then the driver should use an *Attribute* of **EFI\_OPEN\_PROTOCOL\_BY\_DRIVER | EFI\_OPEN\_PROTOCOL\_EXCLUSIVE**.
3. If any of the calls to **OpenProtocol()** in (2) failed with an error other than **EFI\_ALREADY\_STARTED**, then close all of the protocols opened in (2) that did not return **EFI\_ALREADY\_STARTED** with **CloseProtocol()**, and return the status code from the **OpenProtocol()** call that returned an error.
4. Use the protocol instances opened in (2) to test to see if this driver supports the controller. Sometimes, just the presence of the protocols is enough of a test. Other times, the services of the protocols opened in (2) are used to further check the identity of the controller. If any of these tests fails, then close all the protocols opened in (2) that did not return **EFI\_ALREADY\_STARTED** with **CloseProtocol()** and return **EFI\_UNSUPPORTED**.
5. Close all protocols opened in (2) that did not return **EFI\_ALREADY\_STARTED** with **CloseProtocol()**.
6. Return **EFI\_SUCCESS**.

Listed below is sample code of the [Supported\(\)](#) function of device driver for a device on the XYZ bus. The XYZ bus is abstracted with the **EFI\_XYZ\_IO\_PROTOCOL**. Just the presence of the **EFI\_XYZ\_IO\_PROTOCOL** on *ControllerHandle* is enough to determine if this driver supports *ControllerHandle*. The **gBS** variable is initialized in this driver's entry point. See [Section 4](#).

```
extern EFI_GUID  gEfiXyzloProtocol;
EFI_BOOT_SERVICES *gBS;

EFI_STATUS
AbcSupported (
    IN EFI_DRIVER_BINDING_PROTOCOL *This,
    IN EFI_HANDLE      ControllerHandle,
    IN EFI_DEVICE_PATH_PROTOCOL *RemainingDevicePath OPTIONAL
)

{
    EFI_STATUS  Status;
    EFI_XYZ_IO_PROTOCOL *Xyzlo;

    Status = gBS->OpenProtocol (
        ControllerHandle,
        &gEfiXyzloProtocol,
        &Xyzlo,
        This->DriverBindingHandle,
        ControllerHandle,
        EFI_OPEN_PROTOCOL_BY_DRIVER
    );
    if (EFI_ERROR (Status)) {
        return Status;
    }

    gBS->CloseProtocol (
        ControllerHandle,
        &gEfiXyzloProtocol,
        This->DriverBindingHandle,
        ControllerHandle
    );

    return EFI_SUCCESS;
}
```

## EFI\_DRIVER\_BINDING\_PROTOCOL.Start()

### Summary

Starts a device controller or a bus controller. The **Start()** and **Stop()** services of the [EFI\\_DRIVER\\_BINDING\\_PROTOCOL](#) mirror each other.

### Prototype

```
typedef
EFI_STATUS
(EFIAPI *EFI_DRIVER_BINDING_PROTOCOL_START) (
    IN EFI_DRIVER_BINDING_PROTOCOL *This,
    IN EFI_HANDLE ControllerHandle,
    IN EFI_DEVICE_PATH_PROTOCOL *RemainingDevicePath OPTIONAL
);
```

### Parameters

<i>This</i>	A pointer to the <b>EFI_DRIVER_BINDING_PROTOCOL</b> instance.
<i>ControllerHandle</i>	The handle of the controller to start. This handle must support a protocol interface that supplies an I/O abstraction to the driver.
<i>RemainingDevicePath</i>	<p>A pointer to the remaining portion of a device path. For a bus driver, if this parameter is <b>NULL</b>, then handles for all the children of <i>Controller</i> are created by this driver.</p> <p>If this parameter is not <b>NULL</b> and the first Device Path Node is not the End of Device Path Node, then only the handle for the child device specified by the first Device Path Node of <i>RemainingDevicePath</i> is created by this driver.</p> <p>If the first Device Path Node of <i>RemainingDevicePath</i> is the End of Device Path Node, no child handle is created by this driver.</p>

### Description

This function starts the device specified by *Controller* with the driver specified by *This*. Whatever resources are allocated in **Start()** must be freed in **Stop()**. For example, every [EFI\\_BOOT\\_SERVICES.AllocatePool\(\)](#), [EFI\\_BOOT\\_SERVICES.AllocatePages\(\)](#), [EFI\\_BOOT\\_SERVICES.OpenProtocol\(\)](#), and [EFI\\_BOOT\\_SERVICES.InstallProtocolInterface\(\)](#) in **Start()** must be matched with a [EFI\\_BOOT\\_SERVICES.FreePool\(\)](#), [EFI\\_BOOT\\_SERVICES.FreePages\(\)](#), [EFI\\_BOOT\\_SERVICES.CloseProtocol\(\)](#), and [EFI\\_BOOT\\_SERVICES.UninstallProtocolInterface\(\)](#) in **Stop()**.

If *Controller* is started, then **EFI\_SUCCESS** is returned.

If *Controller* could not be started, but can potentially be repaired with configuration or repair operations using the **EFI\_DRIVER\_HEALTH\_PROTOCOL** and this driver produced

an instance of the **EFI\_DRIVER\_HEALTH\_PROTOCOL** for *Controller*, then return **EFI\_SUCCESS**.

If *Controller* cannot be started due to a device error and the driver does not produce the **EFI\_DRIVER\_HEALTH\_PROTOCOL** for *Controller*, then return **EFI\_DEVICE\_ERROR**.

If the driver does not support *Controller* then **EFI\_DEVICE\_ERROR** is returned. This condition will only be met if **Supported()** returns **EFI\_SUCCESS** and a more extensive supported check in **Start()** fails.

If there are not enough resources to start the device or bus specified by *Controller*, then **EFI\_OUT\_OF\_RESOURCES** is returned.

If the driver specified by *This* is a device driver, then *RemainingDevicePath* is ignored.

If the driver specified by *This* is a bus driver, and *RemainingDevicePath* is **NULL**, then all of the children of *Controller* are discovered and enumerated, and a device handle is created for each child.

If the driver specified by *This* is a bus driver, and *RemainingDevicePath* is not **NULL** and begins with the End of Device Path node, then the driver must not enumerate any of the children of *Controller* nor create any child device handle. Only the controller initialization should be performed. If the driver implements

**EFI\_DRIVER\_DIAGNOSTICS2\_PROTOCOL**, **EFI\_COMPONENT\_NAME2\_PROTOCOL**, **EFI\_SERVICE\_BINDING\_PROTOCOL**, **EFI\_DRIVER\_FAMILY\_OVERRIDE\_PROTOCOL**, or **EFI\_DRIVER\_HEALTH\_PROTOCOL**, the driver still should install the implemented protocols. If the driver supports

**EFI\_PLATFORM\_TO\_DRIVER\_CONFIGURATION\_PROTOCOL**, the driver still should retrieve and process the configuration information.

If the driver specified by *This* is a bus driver that is capable of creating one child handle at a time and *RemainingDevicePath* is not **NULL** and does not begin with the End of Device Path node, then an attempt is made to create the device handle for the child device specified by *RemainingDevicePath*. Depending on the bus type, all of the child devices may need to be discovered and enumerated, but at most only the device handle for the one child specified by *RemainingDevicePath* shall be created.

The **Start()** function is designed to be invoked from the EFI boot service **EFI\_BOOT\_SERVICES.ConnectController()**. As a result, much of the error checking on the parameters to **Start()** has been moved into this common boot service. It is legal to call **Start()** from other locations, but the following calling restrictions must be followed or the system behavior will not be deterministic.

- *ControllerHandle* must be a valid **EFI\_HANDLE**.
- If *RemainingDevicePath* is not **NULL**, then it must be a pointer to a naturally aligned **EFI\_DEVICE\_PATH\_PROTOCOL**.
- Prior to calling **Start()**, the **Supported()** function for the driver specified by *This* must have been called with the same calling parameters, and **Supported()** must have returned **EFI\_SUCCESS**.

## Status Codes Returned

EFI_SUCCESS	The device was started.
EFI_SUCCESS	The device could not be started because the device needs to be configured by the user or requires a repair operation, and the driver produced the Driver Health Protocol that will return the required configuration and repair operations for this device.
EFI_DEVICE_ERROR	The driver does not produce the Driver Health Protocol and the device could not be started due to a device error.
EFI_DEVICE_ERROR	The driver produces the Driver Health Protocol, and the driver does not support the device.
EFI_OUT_OF_RESOURCES	The request could not be completed due to a lack of resources.

## Examples

```
extern EFI_GUID    gEfiDriverBindingProtocolGuid;
EFI_HANDLE        DriverImageHandle;
EFI_HANDLE        ControllerHandle;
EFI_DRIVER_BINDING_PROTOCOL *DriverBinding;
EFI_DEVICE_PATH_PROTOCOL *RemainingDevicePath;

//
// Use the DriverImageHandle to get the Driver Binding Protocol instance
//
Status = gBS->OpenProtocol (
    DriverImageHandle,
    &gEfiDriverBindingProtocolGuid,
    &DriverBinding,
    DriverImageHandle,
    NULL,
    EFI_OPEN_PROTOCOL_GET_PROTOCOL
);
if (EFI_ERROR (Status)) {
    return Status;
}

//
// EXAMPLE #1
//
// Use the Driver Binding Protocol instance to test to see if the
// driver specified by DriverImageHandle supports the controller
// specified by ControllerHandle
//
Status = DriverBinding->Supported (
    DriverBinding,
    ControllerHandle,
    NULL
);
if (!EFI_ERROR (Status)) {
    Status = DriverBinding->Start (
```



```

        DriverBinding,
        ControllerHandle,
        NULL
    );
}

return Status;

//
// EXAMPLE #2
//
// The RemainingDevicePath parameter can be used to initialize only
// the minimum devices required to boot. For example, maybe we only
// want to initialize 1 hard disk on a SCSI channel. If DriverImageHandle
// is a SCSI Bus Driver, and ControllerHandle is a SCSI Controller, and
// we only want to create a child handle for PUN=3 and LUN=0, then the
// RemainingDevicePath would be SCSI(3,0)/END. The following example
// would return EFI_SUCCESS if the SCSI driver supports creating the
// child handle for PUN=3, LUN=0. Otherwise it would return an error.
//
Status = DriverBinding->Supported (
    DriverBinding,
    ControllerHandle,
    RemainingDevicePath
);
if (!EFI_ERROR (Status)) {
    Status = DriverBinding->Start (
        DriverBinding,
        ControllerHandle,
        RemainingDevicePath
    );
}

return Status;

```

## Pseudo Code

Listed below are the algorithms for the [Start\(\)](#) function for three different types of drivers. How the [Start\(\)](#) function of a driver is implemented can affect how the [Supported\(\)](#) function is implemented. All of the services in the [EFI DRIVER BINDING PROTOCOL](#) need to work together to make sure that all resources opened or allocated in [Supported\(\)](#) and [Start\(\)](#) are released in [Stop\(\)](#).

The first algorithm is a simple device driver that does not create any additional handles. It only attaches one or more protocols to an existing handle. The second is a simple bus driver that always creates all of its child handles on the first call to [Start\(\)](#). It does not attach any additional protocols to the handle for the bus controller. The third is a more advanced bus driver that can either create one child handles at a time on successive calls to [Start\(\)](#), or it can create all of its child handles or all of the remaining child handles in a single call to [Start\(\)](#). Once again, it does not attach any additional protocols to the handle for the bus controller.

### Device Driver:

1. Ignore the parameter *RemainingDevicePath*.
2. Open all required protocols with [EFI\\_BOOT\\_SERVICES.OpenProtocol\(\)](#). A standard driver should use an *Attribute* of [EFI\\_OPEN\\_PROTOCOL\\_BY\\_DRIVER](#). If this driver

needs exclusive access to a protocol interface, and it requires any drivers that may be using the protocol interface to disconnect, then the driver should use an *Attribute* of **EFI\_OPEN\_PROTOCOL\_BY\_DRIVER | EFI\_OPEN\_PROTOCOL\_EXCLUSIVE**. It must use the same *Attribute* value that was used in **Supported()**.

3. If any of the calls to **OpenProtocol()** in (2) returned an error, then close all of the protocols opened in (2) with **EFI\_BOOT\_SERVICES.CloseProtocol()**, and return the status code from the call to **OpenProtocol()** that returned an error.
4. Initialize the device specified by *ControllerHandle*. If the driver does not support the device specified by *ControllerHandle*, then close all of the protocols opened in (2) with **CloseProtocol()**, and return **EFI\_DEVICE\_ERROR**. If the driver does support the device specified by *ControllerHandle* and an error is detected, and that error can not be resolved with the **EFI\_DRIVER\_HEALTH\_PROTOCOL**, then close all of the protocols opened in (2) with **CloseProtocol()**, and return **EFI\_DEVICE\_ERROR**. If the driver does support the device specified by *ControllerHandle* and an error is detected, and that error can be resolved with the **EFI\_DRIVER\_HEALTH\_PROTOCOL**, then produce the **EFI\_DRIVER\_HEALTH\_PROTOCOL** for *ControllerHandle* and make sure **EFI\_SUCCESS** is returned from **Start()**. In this case, depending on the type of error detected, not all of the following steps may be completed
5. Allocate and initialize all of the data structures that this driver requires to manage the device specified by *ControllerHandle*. This would include space for public protocols and space for any additional private data structures that are related to *ControllerHandle*. If an error occurs allocating the resources, then close all of the protocols opened in (2) with **CloseProtocol()**, and return **EFI\_OUT\_OF\_RESOURCES**.
6. Install all the new protocol interfaces onto *ControllerHandle* using **EFI\_BOOT\_SERVICES.InstallMultipleProtocolInterfaces()**. If an error occurs, close all of the protocols opened in (1) with **CloseProtocol()**, and return the error from **InstallMultipleProtocolInterfaces()**.
7. Return **EFI\_SUCCESS**.

#### Bus Driver that creates all of its child handles on the first call to **Start()**:

1. Ignore the parameter *RemainingDevicePath*. with the exception that if the first Device Path Node is the End of Device Path Node, skip steps 5-8.
2. Open all required protocols with **EFI\_BOOT\_SERVICES.OpenProtocol()**. A standard driver should use an *Attribute* of **EFI\_OPEN\_PROTOCOL\_BY\_DRIVER**. If this driver needs exclusive access to a protocol interface, and it requires any drivers that may be using the protocol interface to disconnect, then the driver should use an *Attribute* of **EFI\_OPEN\_PROTOCOL\_BY\_DRIVER | EFI\_OPEN\_PROTOCOL\_EXCLUSIVE**. It must use the same *Attribute* value that was used in **Supported()**.
3. If any of the calls to **OpenProtocol()** in (2) returned an error, then close all of the protocols opened in (2) with **EFI\_BOOT\_SERVICES.CloseProtocol()**, and return the status code from the call to **OpenProtocol()** that returned an error.
4. Initialize the device specified by *ControllerHandle*. If the driver does not support the device specified by *ControllerHandle*, then close all of the protocols opened in (2) with **CloseProtocol()**, and return **EFI\_DEVICE\_ERROR**. If the driver does support the device specified by *ControllerHandle* and an error is detected, and that error can not be resolved with the **EFI\_DRIVER\_HEALTH\_PROTOCOL**, then close all of the protocols opened in (2) with **CloseProtocol()**, and return **EFI\_DEVICE\_ERROR**. If the driver does support the device specified by *ControllerHandle* and an error is detected,

and that error can be resolved with the **EFI\_DRIVER\_HEALTH\_PROTOCOL**, then produce the **EFI\_DRIVER\_HEALTH\_PROTOCOL** for *ControllerHandle* and make sure **EFI\_SUCCESS** is returned from **Start()**. In this case, depending on the type of error detected, not all of the following steps may be completed.

5. Discover all the child devices of the bus controller specified by *ControllerHandle*.
6. If the bus requires it, allocate resources to all the child devices of the bus controller specified by *ControllerHandle*.
7. FOR each child C of *ControllerHandle*:
  - a. Allocate and initialize all of the data structures that this driver requires to manage the child device C. This would include space for public protocols and space for any additional private data structures that are related to the child device C. If an error occurs allocating the resources, then close all of the protocols opened in (2) with **CloseProtocol()**, and return **EFI\_OUT\_OF\_RESOURCES**.
  - b. If the bus driver creates device paths for the child devices, then create a device path for the child C based upon the device path attached to *ControllerHandle*.
  - c. Initialize the child device C. If an error occurs, close all of the protocols opened in (2) with **CloseProtocol()**, and return **EFI\_DEVICE\_ERROR**.
  - d. Create a new handle for C, and install the protocol interfaces for child device C using [EFI\\_BOOT\\_SERVICES.InstallMultipleProtocolInterfaces\(\)](#). This may include the [EFI\\_DEVICE\\_PATH\\_PROTOCOL](#).
  - e. Call **OpenProtocol()** on behalf of the child C with an *Attribute* of **EFI\_OPEN\_PROTOCOL\_BY\_CHILD\_CONTROLLER**.
8. END FOR
9. If the bus driver also produces protocols on *ControllerHandle*, then install all the new protocol interfaces onto *ControllerHandle* using **InstallMultipleProtocolInterfaces()**. If an error occurs, close all of the protocols opened in (2) with **CloseProtocol()**, and return the error from **InstallMultipleProtocolInterfaces()**.
10. Return **EFI\_SUCCESS**.

**Bus Driver that is able to create all or one of its child handles on each call to Start():**

1. Open all required protocols with [EFI\\_BOOT\\_SERVICES.OpenProtocol\(\)](#). A standard driver should use an *Attribute* of **EFI\_OPEN\_PROTOCOL\_BY\_DRIVER**. If this driver needs exclusive access to a protocol interface, and it requires any drivers that may be using the protocol interface to disconnect, then the driver should use an *Attribute* of **EFI\_OPEN\_PROTOCOL\_BY\_DRIVER | EFI\_OPEN\_PROTOCOL\_EXCLUSIVE**. It must use the same *Attribute* value that was used in [Supported\(\)](#).
2. If any of the calls to **OpenProtocol()** in (1) returned an error, then close all of the protocols opened in (1) with [EFI\\_BOOT\\_SERVICES.CloseProtocol\(\)](#), and return the status code from the call to **OpenProtocol()** that returned an error.
3. Initialize the device specified by *ControllerHandle*. If the driver does not support the device specified by *ControllerHandle*, then close all of the protocols opened in (1) with **CloseProtocol()**, and return **EFI\_DEVICE\_ERROR**. If the driver does support the device specified by *ControllerHandle* and an error is detected, and that error can not be resolved with the **EFI\_DRIVER\_HEALTH\_PROTOCOL**, then close all of the protocols opened in (1) with **CloseProtocol()**, and return **EFI\_DEVICE\_ERROR**. If the

driver does support the device specified by *ControllerHandle* and an error is detected, and that error can be resolved with the **EFI\_DRIVER\_HEALTH\_PROTOCOL**, then produce the **EFI\_DRIVER\_HEALTH\_PROTOCOL** for *ControllerHandle* and make sure **EFI\_SUCESS** is returned from **Start()**. In this case, depending on the type of error detected, not all of the following steps may be completed.

4. IF *RemainingDevicePath* is not **NULL**, THEN
  - a C is the child device specified by *RemainingDevicePath*. If the first Device Path Node is the End of Device Path Node, proceed to step 6.
  - b Allocate and initialize all of the data structures that this driver requires to manage the child device C. This would include space for public protocols and space for any additional private data structures that are related to the child device C. If an error occurs allocating the resources, then close all of the protocols opened in (1) with **CloseProtocol()**, and return **EFI\_OUT\_OF\_RESOURCES**.
  - c If the bus driver creates device paths for the child devices, then create a device path for the child C based upon the device path attached to *ControllerHandle*.
  - d Initialize the child device C.
  - e Create a new handle for C, and install the protocol interfaces for child device C using **EFI\_BOOT\_SERVICES.InstallMultipleProtocolInterfaces()**. This may include the **EFI\_DEVICE\_PATH\_PROTOCOL**.
  - f Call **OpenProtocol()** on behalf of the child C with an *Attribute* of **EFI\_OPEN\_PROTOCOL\_BY\_CHILD\_CONTROLLER**.

ELSE

  - a Discover all the child devices of the bus controller specified by *ControllerHandle*.
  - b If the bus requires it, allocate resources to all the child devices of the bus controller specified by *ControllerHandle*.
  - c FOR each child C of *ControllerHandle*

Allocate and initialize all of the data structures that this driver requires to manage the child device C. This would include space for public protocols and space for any additional private data structures that are related to the child device C. If an error occurs allocating the resources, then close all of the protocols opened in (1) with **CloseProtocol()**, and return **EFI\_OUT\_OF\_RESOURCES**.

If the bus driver creates device paths for the child devices, then create a device path for the child C based upon the device path attached to *ControllerHandle*.

Initialize the child device C.

Create a new handle for C, and install the protocol interfaces for child device C using **InstallMultipleProtocolInterfaces()**. This may include the **EFI\_DEVICE\_PATH\_PROTOCOL**.

Call **EFI\_BOOT\_SERVICES.OpenProtocol()** on behalf of the child C with an *Attribute* of **EFI\_OPEN\_PROTOCOL\_BY\_CHILD\_CONTROLLER**.
  - d END FOR
5. END IF
6. If the bus driver also produces protocols on *ControllerHandle*, then install all the new protocol interfaces onto *ControllerHandle* using **InstallMultipleProtocolInterfaces()**.

If an error occurs, close all of the protocols opened in (2) with **CloseProtocol()**, and return the error from **InstallMultipleProtocolInterfaces()**.

7. Return **EFI\_SUCCESS**.

Listed below is sample code of the **Start()** function of a device driver for a device on the XYZ bus. The XYZ bus is abstracted with the **EFI\_XYZ\_IO\_PROTOCOL**. This driver does allow the **EFI\_XYZ\_IO\_PROTOCOL** to be shared with other drivers, and just the presence of the **EFI\_XYZ\_IO\_PROTOCOL** on *ControllerHandle* is enough to determine if this driver supports *ControllerHandle*. This driver installs the **EFI\_ABC\_IO\_PROTOCOL** on *ControllerHandle*. The **gBS** variable is initialized in this driver's entry point as shown in the UEFI Driver Model examples in [Section 1.7](#).

```
extern EFI_GUID  gEfiXyzloProtocol;
extern EFI_GUID  gEfiAbcloProtocol;
EFI_BOOT_SERVICES *gBS;

EFI_STATUS
AbcStart (
    IN EFI_DRIVER_BINDING_PROTOCOL *This,
    IN EFI_HANDLE      ControllerHandle,
    IN EFI_DEVICE_PATH_PROTOCOL *RemainingDevicePath OPTIONAL
)
{
    EFI_STATUS  Status;
    EFI_XYZ_IO_PROTOCOL *Xyzlo;
    EFI_ABC_DEVICE  AbcDevice;

    //
    // Open the Xyz I/O Protocol that this driver consumes
    //
    Status = gBS->OpenProtocol (
        ControllerHandle,
        &gEfiXyzloProtocol,
        &Xyzlo,
        This->DriverBindingHandle,
        ControllerHandle,
        EFI_OPEN_PROTOCOL_BY_DRIVER
    );
    if (EFI_ERROR (Status)) {
        return Status;
    }

    //
    // Allocate and zero a private data structure for the Abc device.
    //
    Status = gBS->AllocatePool (
        EfiBootServicesData,
        sizeof (EFI_ABC_DEVICE),
        &AbcDevice
    );
    if (EFI_ERROR (Status)) {
        goto ErrorExit;
    }
    ZeroMem (AbcDevice, sizeof (EFI_ABC_DEVICE));

    //
    // Initialize the contents of the private data structure for the Abc device.
```

```

// This includes the Xyzlo protocol instance and other private data fields
// and the EFI_ABC_IO_PROTOCOL instance that will be installed.
//
AbcDevice->Signature = EFI_ABC_DEVICE_SIGNATURE;
AbcDevice->Xyzlo = Xyzlo;

AbcDevice->PrivateData1 = PrivateValue1;
AbcDevice->PrivateData2 = PrivateValue2;
...
AbcDevice->PrivateDataN = PrivateValueN;

AbcDevice->Abclo.Revision = EFI_ABC_IO_PROTOCOL_REVISION;
AbcDevice->Abclo.Func1 = AbcloFunc1;
AbcDevice->Abclo.Func2 = AbcloFunc2;
...
AbcDevice->Abclo.FuncN = AbcloFuncN;

AbcDevice->Abclo.Data1 = Value1;
AbcDevice->Abclo.Data2 = Value2;
...
AbcDevice->Abclo.DataN = ValueN;

//
// Install protocol interfaces for the ABC I/O device.
//
Status = gBS->InstallMultipleProtocolInterfaces (
    &ControllerHandle,
    &gEfiAbcloProtocolGuid, &AbcDevice->Abclo,
    NULL
);
if (EFI_ERROR (Status)) {
    goto ErrorExit;
}

return EFI_SUCCESS;

ErrorExit:
//
// When there is an error, the private data structures need to be freed and
// the protocols that were opened need to be closed.
//
if (AbcDevice != NULL) {
    gBS->FreePool (AbcDevice);
}
gBS->CloseProtocol (
    ControllerHandle,
    &gEfiXyzloProtocolGuid,
    This->DriverBindingHandle,
    ControllerHandle
);
return Status;
}

```

## EFI\_DRIVER\_BINDING\_PROTOCOL.Stop()

### Summary

Stops a device controller or a bus controller. The [Start\(\)](#) and [Stop\(\)](#) services of the [EFI\\_DRIVER\\_BINDING\\_PROTOCOL](#) mirror each other.

### Prototype

```
typedef
EFI_STATUS
(EFIAPI *EFI_DRIVER_BINDING_PROTOCOL_STOP) (
    IN EFI_DRIVER_BINDING_PROTOCOL *This,
    IN EFI_HANDLE      ControllerHandle,
    IN UINTN           NumberOfChildren,
    IN EFI_HANDLE      *ChildHandleBuffer OPTIONAL
);
```

### Parameters

<i>This</i>	A pointer to the <a href="#">EFI_DRIVER_BINDING_PROTOCOL</a> instance. Type <a href="#">EFI_DRIVER_BINDING_PROTOCOL</a> is defined in <a href="#">Section 11.1</a> .
<i>ControllerHandle</i>	A handle to the device being stopped. The handle must support a bus specific I/O protocol for the driver to use to stop the device.
<i>NumberOfChildren</i>	The number of child device handles in <i>ChildHandleBuffer</i> .
<i>ChildHandleBuffer</i>	An array of child handles to be freed. May be <b>NULL</b> if <i>NumberOfChildren</i> is 0.

### Description

This function performs different operations depending on the parameter *NumberOfChildren*. If *NumberOfChildren* is not zero, then the driver specified by *This* is a bus driver, and it is being requested to free one or more of its child handles specified by *NumberOfChildren* and *ChildHandleBuffer*. If all of the child handles are freed, then **EFI\_SUCCESS** is returned. If *NumberOfChildren* is zero, then the driver specified by *This* is either a device driver or a bus driver, and it is being requested to stop the controller specified by *ControllerHandle*. If *ControllerHandle* is stopped, then **EFI\_SUCCESS** is returned. In either case, this function is required to undo what was performed in [Start\(\)](#). Whatever resources are allocated in [Start\(\)](#) must be freed in [Stop\(\)](#). For example, every [EFI\\_BOOT\\_SERVICES.AllocatePool\(\)](#), [EFI\\_BOOT\\_SERVICES.AllocatePages\(\)](#), [EFI\\_BOOT\\_SERVICES.OpenProtocol\(\)](#), and [EFI\\_BOOT\\_SERVICES.InstallProtocolInterface\(\)](#) in [Start\(\)](#) must be matched with a [EFI\\_BOOT\\_SERVICES.FreePool\(\)](#), [EFI\\_BOOT\\_SERVICES.FreePages\(\)](#), [EFI\\_BOOT\\_SERVICES.CloseProtocol\(\)](#), and [EFI\\_BOOT\\_SERVICES.UninstallProtocolInterface\(\)](#) in [Stop\(\)](#).



If *ControllerHandle* cannot be stopped, then **EFI\_DEVICE\_ERROR** is returned. If, for some reason, there are not enough resources to stop *ControllerHandle*, then **EFI\_OUT\_OF\_RESOURCES** is returned.

The **Stop()** function is designed to be invoked from the EFI boot service [EFI\\_BOOT\\_SERVICES.DisconnectController\(\)](#). As a result, much of the error checking on the parameters to **Stop()** has been moved into this common boot service. It is legal to call **Stop()** from other locations, but the following calling restrictions must be followed or the system behavior will not be deterministic.

- *ControllerHandle* must be a valid **EFI\_HANDLE** that was used on a previous call to this same driver's [Start\(\)](#) function.
- The first *NumberOfChildren* handles of *ChildHandleBuffer* must all be a valid **EFI\_HANDLE**. In addition, all of these handles must have been created in this driver's **Start()** function, and the **Start()** function must have called [EFI\\_BOOT\\_SERVICES.OpenProtocol\(\)](#) on *ControllerHandle* with an *Attribute* of **EFI\_OPEN\_PROTOCOL\_BY\_CHILD\_CONTROLLER**.

### Status Codes Returned

EFI_SUCCESS	The device was stopped.
EFI_DEVICE_ERROR	The device could not be stopped due to a device error.

### Examples

```
extern EFI_GUID    gEfiDriverBindingProtocolGuid;
EFI_HANDLE        DriverImageHandle;
EFI_HANDLE        ControllerHandle;
EFI_HANDLE        ChildHandle;
EFI_DRIVER_BINDING_PROTOCOL *DriverBinding;

//
// Use the DriverImageHandle to get the Driver Binding Protocol instance
//
Status = gBS->OpenProtocol (
    DriverImageHandle,
    &gEfiDriverBindingProtocolGuid,
    &DriverBinding,
    DriverImageHandle,
    NULL,
    EFI_OPEN_PROTOCOL_GET_PROTOCOL
);
if (EFI_ERROR (Status)) {
    return Status;
}

//
// Use the Driver Binding Protocol instance to free the child
// specified by ChildHandle. Then, use the Driver Binding
// Protocol to stop ControllerHandle.
//
Status = DriverBinding->Stop (
    DriverBinding,
    ControllerHandle,
    1,
```



```

        &ChildHandle
    );

    Status = DriverBinding->Stop (
        DriverBinding,
        ControllerHandle,
        0,
        NULL
    );

```

## Pseudo Code

### Device Driver:

1. Uninstall all the protocols that were installed onto *ControllerHandle* in [Start\(\)](#).
2. Close all the protocols that were opened on behalf of *ControllerHandle* in **Start()**.
3. Free all the structures that were allocated on behalf of *ControllerHandle* in **Start()**.
4. Return **EFI\_SUCCESS**.

### Bus Driver that creates all of its child handles on the first call to Start():

### Bus Driver that is able to create all or one of its child handles on each call to Start():

1. IF *NumberOfChildren* is zero THEN:
  - a Uninstall all the protocols that were installed onto *ControllerHandle* in **Start()**.
  - b Close all the protocols that were opened on behalf of *ControllerHandle* in **Start()**.
  - c Free all the structures that were allocated on behalf of *ControllerHandle* in **Start()**.
2. ELSE
  - a FOR each child C in *ChildHandleBuffer*
    - Uninstall all the protocols that were installed onto C in **Start()**.
    - Close all the protocols that were opened on behalf of C in **Start()**.
    - Free all the structures that were allocated on behalf of C in **Start()**.
  - b END FOR
3. END IF
4. Return **EFI\_SUCCESS**.

Listed below is sample code of the [Stop\(\)](#) function of a device driver for a device on the XYZ bus. The XYZ bus is abstracted with the **EFI\_XYZ\_IO\_PROTOCOL**. This driver does allow the **EFI\_XYZ\_IO\_PROTOCOL** to be shared with other drivers, and just the presence of the **EFI\_XYZ\_IO\_PROTOCOL** on *ControllerHandle* is enough to determine if this driver supports *ControllerHandle*. This driver installs the **EFI\_ABC\_IO\_PROTOCOL** on *ControllerHandle* in [Start\(\)](#). The **gBS** variable is initialized in this driver's entry point. See [Section 4](#).

```

extern EFI_GUID  gEfiXyzIoProtocol;
extern EFI_GUID  gEfiAbcIoProtocol;
EFI_BOOT_SERVICES *gBS;

EFI_STATUS
AbcStop (
    IN EFI_DRIVER_BINDING_PROTOCOL *This,
    IN EFI_HANDLE      ControllerHandle,
    IN UINTN           NumberOfChildren,

```

```

    IN EFI_HANDLE      *ChildHandleBuffer OPTIONAL
  )
  {
    EFI_STATUS  Status;
    EFI_ABC_IO  AbcIo;
    EFI_ABC_DEVICE  AbcDevice;

    //
    // Get our context back
    //
    Status = gBS->OpenProtocol (
      ControllerHandle,
      &gEfiAbcIoProtocolGuid,
      &AbcIo,
      This->DriverBindingHandle,
      ControllerHandle,
      EFI_OPEN_PROTOCOL_GET_PROTOCOL
    );
    if (EFI_ERROR (Status)) {
      return EFI_UNSUPPORTED;
    }

    //
    // Use Containment Record Macro to get AbcDevice structure from
    // a pointer to the AbcIo structure within the AbcDevice structure.
    //
    AbcDevice = ABC_IO_PRIVATE_DATA_FROM_THIS (AbcIo);

    //
    // Uninstall the protocol installed in Start()
    //
    Status = gBS->UninstallMultipleProtocolInterfaces (
      ControllerHandle,
      &gEfiAbcIoProtocolGuid, &AbcDevice->AbcIo,
      NULL
    );
    if (!EFI_ERROR (Status)) {

      //
      // Close the protocol opened in Start()
      //
      Status = gBS->CloseProtocol (
        ControllerHandle,
        &gEfiXyzIoProtocolGuid,
        This->DriverBindingHandle,
        ControllerHandle
      );

      //
      // Free the structure allocated in Start().
      //
      gBS->FreePool (AbcDevice);
    }

    return Status;
  }

```

## 11.2 EFI Platform Driver Override Protocol

This section provides a detailed description of the **EFI\_PLATFORM\_DRIVER\_OVERRIDE\_PROTOCOL**. This protocol can override the default algorithm for matching drivers to controllers.

### EFI\_PLATFORM\_DRIVER\_OVERRIDE\_PROTOCOL

#### Summary

This protocol matches one or more drivers to a controller. A platform driver produces this protocol, and it is installed on a separate handle. This protocol is used by the [EFI\\_BOOT\\_SERVICES.ConnectController\(\)](#) boot service to select the best driver for a controller. All of the drivers returned by this protocol have a higher precedence than drivers found from an EFI Bus Specific Driver Override Protocol or drivers found from the general UEFI driver Binding search algorithm. If more than one driver is returned by this protocol, then the drivers are returned in order from highest precedence to lowest precedence.

#### GUID

```
#define EFI_PLATFORM_DRIVER_OVERRIDE_PROTOCOL_GUID \
{0x6b30c738,0xa391,0x11d4,\
 {0x9a,0x3b,0x00,0x90,0x27,0x3f,0xc1,0x4d}}
```

#### Protocol Interface Structure

```
typedef struct _EFI_PLATFORM_DRIVER_OVERRIDE_PROTOCOL {
  EFI_PLATFORM_DRIVER_OVERRIDE_GET_DRIVER  GetDriver;
  EFI_PLATFORM_DRIVER_OVERRIDE_GET_DRIVER_PATH GetDriverPath;
  EFI_PLATFORM_DRIVER_OVERRIDE_DRIVER_LOADED DriverLoaded;
} EFI_PLATFORM_DRIVER_OVERRIDE_PROTOCOL;
```

#### Parameters

<b>GetDriver</b>	Retrieves the image handle of a platform override driver for a controller in the system. See the <a href="#">GetDriver()</a> function description.
<b>GetDriverPath</b>	Retrieves the device path of a platform override driver for a controller in the system. See the <a href="#">GetDriverPath()</a> function description.
<b>DriverLoaded</b>	This function is used after a driver has been loaded using a device path returned by <a href="#">GetDriverPath()</a> . This function associates a device path to an image handle, so the image handle can be returned the next time that <a href="#">GetDriver()</a> is called for the same controller. See the <a href="#">DriverLoaded()</a> function description.

## Description

The **EFI\_PLATFORM\_DRIVER\_OVERRIDE\_PROTOCOL** is used by the EFI boot service [EFI\\_BOOT\\_SERVICES.ConnectController\(\)](#) to determine if there is a platform specific driver override for a controller that is about to be started. The bus drivers in a platform will use a bus defined matching algorithm for matching drivers to controllers. This protocol allows the platform to override the bus driver's default driver matching algorithm. This protocol can be used to specify the drivers for on-board devices whose drivers may be in a system ROM not directly associated with the on-board controller, or it can even be used to manage the matching of drivers and controllers in add-in cards. This can be very useful if there are two adapters that are identical except for the revision of the driver in the adapter's ROM. This protocol, along with a platform configuration utility, could specify which of the two drivers to use for each of the adapters.

The drivers that this protocol returns can be either in the form of an image handle or a device path. [EFI\\_BOOT\\_SERVICES.ConnectController\(\)](#) can only use image handles, so [ConnectController\(\)](#) is required to use the [GetDriver\(\)](#) service. A different component, such as the Boot Manager, will have to use the [GetDriverPath\(\)](#) service to retrieve the list of drivers that need to be loaded from I/O devices. Once a driver has been loaded and started, this same component can use the [DriverLoaded\(\)](#) service to associate the device path of a driver with the image handle of the loaded driver. Once this association has been established, the image handle can then be returned by the [GetDriver\(\)](#) service the next time it is called by [ConnectController\(\)](#).

## EFI\_PLATFORM\_DRIVER\_OVERRIDE\_PROTOCOL.GetDriver()

### Summary

Retrieves the image handle of the platform override driver for a controller in the system.

### Prototype

```
typedef
EFI_STATUS
(EFI_API *EFI_PLATFORM_DRIVER_OVERRIDE_GET_DRIVER) (
  IN EFI_PLATFORM_DRIVER_OVERRIDE_PROTOCOL *This,
  IN EFI_HANDLE ControllerHandle,
  IN OUT EFI_HANDLE *DriverImageHandle
);
```

### Parameters

<i>This</i>	A pointer to the <a href="#">EFI_PLATFORM_DRIVER_OVERRIDE_PROTOCOL</a> instance.
<i>ControllerHandle</i>	The device handle of the controller to check if a driver override exists.
<i>DriverImageHandle</i>	On input, a pointer to the previous driver image handle returned by <a href="#">GetDriver()</a> . On output, a pointer to the next driver image handle. Passing in a <b>NULL</b> , will return the first driver image handle for <b>ControllerHandle</b> .

### Description

This function is used to retrieve a driver image handle that is selected in a platform specific manner. The first driver image handle is retrieved by passing in a *DriverImageHandle* value of **NULL**. This will cause the first driver image handle to be returned in *DriverImageHandle*. On each successive call, the previous value of *DriverImageHandle* must be passed in. If a call to this function returns a valid driver image handle, then **EFI\_SUCCESS** is returned. This process is repeated until **EFI\_NOT\_FOUND** is returned. If a *DriverImageHandle* is passed in that was not returned on a prior call to this function, then **EFI\_INVALID\_PARAMETER** is returned. If *ControllerHandle* is **NULL**, then **EFI\_INVALID\_PARAMETER** is returned. The first driver image handle has the highest precedence, and the last driver image handle has the lowest precedence. This ordered list of driver image handles is used by the boot service [EFI\\_BOOT\\_SERVICES.ConnectController\(\)](#) to search for the best driver for a controller.

### Status Codes Returned

EFI_SUCCESS	The driver override for <i>ControllerHandle</i> was returned in <i>DriverImageHandle</i> .
EFI_NOT_FOUND	A driver override for <i>ControllerHandle</i> was not found.

<p>EFI_INVALID_PARAMETER</p>	<p>The handle specified by <i>ControllerHandle</i> is not a valid handle.</p>
<p>EFI_INVALID_PARAMETER</p>	<p><i>DriverImageHandle</i> is not a handle that was returned on a previous call to <b>GetDriver()</b>.</p>

## EFI\_PLATFORM\_DRIVER\_OVERRIDE\_PROTOCOL.GetDriverPath()

### Summary

Retrieves the device path of the platform override driver for a controller in the system.

### Prototype

```
typedef
EFI_STATUS
(EFI_API *EFI_PLATFORM_DRIVER_OVERRIDE_GET_DRIVER_PATH) (
    IN EFI_PLATFORM_DRIVER_OVERRIDE_PROTOCOL *This,
    IN EFI_HANDLE ControllerHandle,
    IN OUT EFI_DEVICE_PATH_PROTOCOL **DriverImagePath
);
```

### Parameters

<i>This</i>	A pointer to the <a href="#">EFI_PLATFORM_DRIVER_OVERRIDE_PROTOCOL</a> instance.
<i>ControllerHandle</i>	The device handle of the controller to check if a driver override exists.
<i>DriverImagePath</i>	On input, a pointer to the previous driver device path returned by <a href="#">GetDriverPath()</a> . On output, a pointer to the next driver device path. Passing in a pointer to <b>NULL</b> , will return the first driver device path for <b>ControllerHandle</b> .

### Description

This function is used to retrieve a driver device path that is selected in a platform specific manner. The first driver device path is retrieved by passing in a *DriverImagePath* value that is a pointer to **NULL**. This will cause the first driver device path to be returned in *DriverImagePath*. On each successive call, the previous value of *DriverImagePath* must be passed in. If a call to this function returns a valid driver device path, then **EFI\_SUCCESS** is returned. This process is repeated until **EFI\_NOT\_FOUND** is returned. If a *DriverImagePath* is passed in that was not returned on a prior call to this function, then **EFI\_INVALID\_PARAMETER** is returned. If *ControllerHandle* is **NULL**, then **EFI\_INVALID\_PARAMETER** is returned. The first driver device path has the highest precedence, and the last driver device path has the lowest precedence. This ordered list of driver device paths is used by a platform specific component, such as the EFI Boot Manager, to load and start the platform override drivers by using the EFI boot services [EFI\\_BOOT\\_SERVICES.LoadImage\(\)](#) and [EFI\\_BOOT\\_SERVICES.StartImage\(\)](#). Each time one of these drivers is loaded and started, the [DriverLoaded\(\)](#) service is called.

### Status Codes Returned

EFI_SUCCESS	The driver override for <i>ControllerHandle</i> was returned in <i>DriverImagePath</i> .
EFI_UNSUPPORTED	The operation is not supported.

EFI_NOT_FOUND	A driver override for <i>ControllerHandle</i> was not found.
EFI_INVALID_PARAMETER	The handle specified by <i>ControllerHandle</i> is not a valid handle.
EFI_INVALID_PARAMETER	<i>DriverImagePath</i> is not a device path that was returned on a previous call to <b>GetDriverPath()</b> .



## EFI\_PLATFORM\_DRIVER\_OVERRIDE\_PROTOCOL.DriverLoaded()

### Summary

Used to associate a driver image handle with a device path that was returned on a prior call to the [GetDriverPath\(\)](#) service. This driver image handle will then be available through the [GetDriver\(\)](#) service.

### Prototype

```
typedef
EFI_STATUS
(EFI_API *EFI_PLATFORM_DRIVER_OVERRIDE_DRIVER_LOADED) (
  IN EFI_PLATFORM_DRIVER_OVERRIDE_PROTOCOL *This,
  IN EFI_HANDLE      ControllerHandle,
  IN EFI_DEVICE_PATH_PROTOCOL *DriverImagePath,
  IN EFI_HANDLE      DriverImageHandle
);
```

### Parameters

<i>This</i>	A pointer to the <a href="#">EFI_PLATFORM_DRIVER_OVERRIDE_PROTOCOL</a> instance.
<i>ControllerHandle</i>	The device handle of a controller. This must match the controller handle that was used in a prior call to <a href="#">GetDriver()</a> to retrieve <i>DriverImagePath</i> .
<i>DriverImagePath</i>	A pointer to the driver device path that was returned in a prior call to <a href="#">GetDriverPath()</a> .
<i>DriverImageHandle</i>	The driver image handle that was returned by <a href="#">EFI_BOOT_SERVICES.LoadImage()</a> when the driver specified by <i>DriverImagePath</i> was loaded into memory.

### Description

This function associates the image handle specified by *DriverImageHandle* with the device path of a driver specified by *DriverImagePath*. *DriverImagePath* must be a value that was returned on a prior call to [GetDriverPath\(\)](#) for the controller specified by *ControllerHandle*. Once this association has been established, then the service [GetDriver\(\)](#) must return *DriverImageHandle* as one of the override drivers for the controller specified by *ControllerHandle*.

If the association between the image handle specified by *DriverImageHandle* and the device path specified by *DriverImagePath* is established for the controller specified by *ControllerHandle*, then **EFI\_SUCCESS** is returned. If *ControllerHandle* is **NULL**, or *DriverImagePath* is not a valid device path, or *DriverImageHandle* is **NULL**, then **EFI\_INVALID\_PARAMETER** is returned. If *DriverImagePath* is not a device path that was returned on a prior call to [GetDriver\(\)](#) for the controller specified by *ControllerHandle*, then **EFI\_NOT\_FOUND** is returned.

## Status Codes Returned

EFI_SUCCESS	The association between <i>DriverImagePath</i> and <i>DriverImageHandle</i> was established for the controller specified by <i>ControllerHandle</i> .
EFI_UNSUPPORTED	The operation is not supported.
EFI_NOT_FOUND	<i>DriverImagePath</i> is not a device path that was returned on a prior call to <a href="#">GetDriverPath()</a> for the controller specified by <i>ControllerHandle</i> .
EFI_INVALID_PARAMETER	<i>ControllerHandle</i> is not a valid device handle.
EFI_INVALID_PARAMETER	<i>DriverImagePath</i> is not a valid device path.
EFI_INVALID_PARAMETER	<i>DriverImageHandle</i> is not a valid image handle.

## 11.3 EFI Bus Specific Driver Override Protocol

This section provides a detailed description of the **EFI\_BUS\_SPECIFIC\_DRIVER\_OVERRIDE\_PROTOCOL**. Bus drivers that have a bus specific algorithm for matching drivers to controllers are required to produce this protocol for each controller. For example, a PCI Bus Driver will produce an instance of this protocol for every PCI controller that has a PCI option ROM that contains one or more UEFI drivers. The protocol instance is attached to the handle of the PCI controller.

### EFI\_BUS\_SPECIFIC\_DRIVER\_OVERRIDE\_PROTOCOL

#### Summary

This protocol matches one or more drivers to a controller. This protocol is produced by a bus driver, and it is installed on the child handles of buses that require a bus specific algorithm for matching drivers to controllers. This protocol is used by the [EFI\\_BOOT\\_SERVICES.ConnectController\(\)](#) boot service to select the best driver for a controller. All of the drivers returned by this protocol have a higher precedence than drivers found in the general EFI Driver Binding search algorithm, but a lower precedence than those drivers returned by the EFI Platform Driver Override Protocol. If more than one driver image handle is returned by this protocol, then the drivers image handles are returned in order from highest precedence to lowest precedence.

## GUID

```
#define EFI_BUS_SPECIFIC_DRIVER_OVERRIDE_PROTOCOL_GUID \
{0x3bc1b285,0x8a15,0x4a82,\
 {0xaa,0xbf,0x4d,0x7d,0x13,0xfb,0x32,0x65}}
```

## Protocol Interface Structure

```
typedef struct _EFI_BUS_SPECIFIC_DRIVER_OVERRIDE_PROTOCOL {
    EFI_BUS_SPECIFIC_DRIVER_OVERRIDE_GET_DRIVER GetDriver;
} EFI_BUS_SPECIFIC_DRIVER_OVERRIDE_PROTOCOL;
```

## Parameters

*GetDriver*

Uses a bus specific algorithm to retrieve a driver image handle for a controller. See the [GetDriver\(\)](#) function description.

## Description

The **EFI\_BUS\_SPECIFIC\_DRIVER\_OVERRIDE\_PROTOCOL** provides a mechanism for bus drivers to override the default driver selection performed by the **ConnectController()** boot service. This protocol is attached to the handle of a child device after the child handle is created by the bus driver. The service in this protocol can return a bus specific override driver to **ConnectController()**. **ConnectController()** must call this service until all of the bus specific override drivers have been retrieved. **ConnectController()** uses this information along with the EFI Platform Driver Override Protocol and all of the EFI Driver Binding protocol instances to select the best drivers for a controller. Since a controller can be managed by more than one driver, this protocol can return more than one bus specific override driver.

## EFI\_BUS\_SPECIFIC\_DRIVER\_OVERRIDE\_PROTOCOL.GetDriver()

### Summary

Uses a bus specific algorithm to retrieve a driver image handle for a controller.

### Prototype

```
typedef
EFI_STATUS
(EFI_API *EFI_BUS_SPECIFIC_DRIVER_OVERRIDE_GET_DRIVER) (
    IN EFI_BUS_SPECIFIC_DRIVER_OVERRIDE_PROTOCOL *This,
    IN OUT EFI_HANDLE          *DriverImageHandle
);
```

### Parameters

<i>This</i>	A pointer to the <a href="#">EFI BUS SPECIFIC DRIVER OVERRIDE PROTOCOL</a> instance.
<i>DriverImageHandle</i>	On input, a pointer to the previous driver image handle returned by <a href="#">GetDriver()</a> . On output, a pointer to the next driver image handle. Passing in a <b>NULL</b> , will return the first driver image handle.

### Description

This function is used to retrieve a driver image handle that is selected in a bus specific manner. The first driver image handle is retrieved by passing in a *DriverImageHandle* value of **NULL**. This will cause the first driver image handle to be returned in *DriverImageHandle*. On each successive call, the previous value of *DriverImageHandle* must be passed in. If a call to this function returns a valid driver image handle, then **EFI\_SUCCESS** is returned. This process is repeated until **EFI\_NOT\_FOUND** is returned. If a *DriverImageHandle* is passed in that was not returned on a prior call to this function, then **EFI\_INVALID\_PARAMETER** is returned. The first driver image handle has the highest precedence, and the last driver image handle has the lowest precedence. This ordered list of driver image handles is used by the boot service [EFI\\_BOOT\\_SERVICES.ConnectController\(\)](#) to search for the best driver for a controller.

## Status Codes Returned

EFI_SUCCESS	A bus specific override driver is returned in <i>DriverImageHandle</i> .
EFI_NOT_FOUND	The end of the list of override drivers was reached. A bus specific override driver is not returned in <i>DriverImageHandle</i> .
EFI_INVALID_PARAMETER	<i>DriverImageHandle</i> is not a handle that was returned on a previous call to <b>GetDriver()</b> .

## 11.4 EFI Driver Diagnostics Protocol

This section provides a detailed description of the **EFI\_DRIVER\_DIAGNOSTICS2\_PROTOCOL**. This is a protocol that allows a UEFI driver to perform diagnostics on a controller that the driver is managing.

### EFI\_DRIVER\_DIAGNOSTICS2\_PROTOCOL

#### Summary

Used to perform diagnostics on a controller that a UEFI driver is managing.

#### GUID

```
#define EFI_DRIVER_DIAGNOSTICS2_PROTOCOL_GUID \
{0x4d330321,0x025f,0x4aac,\
{0x90,0xd8,0x5e,0xd9,0x00,0x17,0x3b,0x63}}
```

#### Protocol Interface Structure

```
typedef struct _EFI_DRIVER_DIAGNOSTICS2_PROTOCOL {
    EFI_DRIVER_DIAGNOSTICS2_RUN_DIAGNOSTICS RunDiagnostics;
    CHAR8 *SupportedLanguages;
} EFI_DRIVER_DIAGNOSTICS2_PROTOCOL;
```

#### Parameters

<i>RunDiagnostics</i>	Runs diagnostics on a controller. See the <a href="#">RunDiagnostics()</a> function description.
<i>SupportedLanguages</i>	A Null-terminated ASCII string that contains one or more supported language codes. This is the list of language codes that this protocol supports. The number of languages supported by a driver is up to the driver writer. <i>SupportedLanguages</i> is specified in RFC 4646 format. See <a href="#">Appendix M</a> for the format of language codes and language code arrays.

#### Description

The **EFI\_DRIVER\_DIAGNOSTICS2\_PROTOCOL** is used by a platform management utility to allow the user to run driver specific diagnostics on a controller. This protocol is

optionally attached to the image handle of driver in the driver's entry point. The platform management utility can collect all the **EFI\_DRIVER\_DIAGNOSTICS2\_PROTOCOL** instances present in the system, and present the user with a menu of the controllers that have diagnostic capabilities. This platform management utility is invoked through a platform component such as the EFI Boot Manager.

## EFI\_DRIVER\_DIAGNOSTICS2\_PROTOCOL.RunDiagnostics()

### Summary

Runs diagnostics on a controller.

### Prototype

```
typedef
EFI_STATUS
(EFIAPI *EFI_DRIVER_DIAGNOSTICS2_RUN_DIAGNOSTICS) (
    IN EFI_DRIVER_DIAGNOSTICS2_PROTOCOL *This,
    IN EFI_HANDLE      ControllerHandle,
    IN EFI_HANDLE      ChildHandle OPTIONAL,
    IN EFI_DRIVER_DIAGNOSTIC_TYPE DiagnosticType,
    IN CHAR8           *Language,
    OUT EFI_GUID       **ErrorType,
    OUT UINTN          *BufferSize,
    OUT CHAR16         **Buffer
);
```

### Parameters

<i>This</i>	A pointer to the <b>EFI_DRIVER_DIAGNOSTICS2_PROTOCOL</b> instance.
<i>ControllerHandle</i>	The handle of the controller to run diagnostics on.
<i>ChildHandle</i>	The handle of the child controller to run diagnostics on. This is an optional parameter that may be <b>NULL</b> . It will be <b>NULL</b> for device drivers. It will also be <b>NULL</b> for a bus drivers that attempt to run diagnostics on the bus controller. It will not be <b>NULL</b> for a bus driver that attempts to run diagnostics on one of its child controllers.
<i>DiagnosticType</i>	Indicates type of diagnostics to perform on the controller specified by <i>ControllerHandle</i> and <i>ChildHandle</i> . See “Related Definitions” for the list of supported types.
<i>Language</i>	A pointer to a Null-terminated ASCII string array indicating the language. This is the language in which the optional error message should be returned in <i>Buffer</i> , and it must match one of the languages specified in SupportedLanguages. The number of languages supported by a driver is up to the driver writer. <i>Language</i> is specified in RFC 4646 language code format. See <a href="#">Appendix M</a> for the format of language codes. Callers of interfaces that require RFC 4646 language codes to retrieve a Unicode string must use the RFC 4647 algorithm to lookup the Unicode string with the closest matching RFC 4646 language code.
<i>ErrorType</i>	A GUID that defines the format of the data returned in <i>Buffer</i> .

*BufferSize* The size, in bytes, of the data returned in *Buffer*.

*Buffer* A buffer that contains a Null-terminated string plus some additional data whose format is defined by *ErrorType*. *Buffer* is allocated by this function with [EFI\\_BOOT\\_SERVICES.AllocatePool\(\)](#), and it is the caller's responsibility to free it with a call to [EFI\\_BOOT\\_SERVICES.FreePool\(\)](#).

### Description

This function runs diagnostics on the controller specified by *ControllerHandle* and *ChildHandle*. *DiagnosticType* specifies the type of diagnostics to perform on the controller specified by *ControllerHandle* and *ChildHandle*. If the driver specified by *This* does not support the language specified by *Language*, then **EFI\_UNSUPPORTED** is returned. If the controller specified by *ControllerHandle* and *ChildHandle* is not supported by the driver specified by *This*, then **EFI\_UNSUPPORTED** is returned. If the diagnostics type specified by *DiagnosticType* is not supported by this driver, then **EFI\_UNSUPPORTED** is returned. If there are not enough resources available to complete the diagnostic, then **EFI\_OUT\_OF\_RESOURCES** is returned. If the controller specified by *ControllerHandle* and *ChildHandle* passes the diagnostic, then **EFI\_SUCCESS** is returned. Otherwise, **EFI\_DEVICE\_ERROR** is returned.

If the language specified by *Language* is supported by this driver, then status information is returned in *ErrorType*, *BufferSize*, and *Buffer*. *Buffer* contains a Null-terminated string followed by additional data whose format is defined by *ErrorType*. *BufferSize* is the size of *Buffer* in bytes, and it is the caller's responsibility to call **FreePool()** on *Buffer* when the caller is done with the return data. If there are not enough resources available to return the status information, then **EFI\_OUT\_OF\_RESOURCES** is returned.

### Related Definitions

```

//*****
// EFI_DRIVER_DIAGNOSTIC_TYPE
//*****
typedef enum {
    EfiDriverDiagnosticTypeStandard    = 0,
    EfiDriverDiagnosticTypeExtended    = 1,
    EfiDriverDiagnosticTypeManufacturing = 2,
    EfiDriverDiagnosticTypeCancel      = 3,
    EfiDriverDiagnosticTypeMaximum
} EFI_DRIVER_DIAGNOSTIC_TYPE;

```

#### EfiDriverDiagnosticTypeStandard

Performs standard diagnostics on the controller. This diagnostic type is required to be supported by all implementations of this protocol.

#### EfiDriverDiagnosticTypeExtended

This is an optional diagnostic type that performs diagnostics on the controller that may take an extended amount of time to execute.



**EfiDriverDiagnosticTypeManufacturing**

This is an optional diagnostic type that performs diagnostics on the controller that are suitable for a manufacturing and test environment.

**EfiDriverDiagnosticTypeCancel**

This is an optional diagnostic type that would only be used in the situation where an `EFI_NOT_READY` had been returned by a previous call to **RunDiagnostics()** and there is a desire to cancel the current running diagnostics operation.

**Status Codes Returned**

EFI_SUCCESS	The controller specified by <i>ControllerHandle</i> and <i>ChildHandle</i> passed the diagnostic.
EFI_ACCESS_DENIED	The request for initiating diagnostics was unable to be completed due to some underlying hardware or software state.
EFI_INVALID_PARAMETER	<i>ControllerHandle</i> is <b>NULL</b> .
EFI_INVALID_PARAMETER	The driver specified by <i>This</i> is not a device driver, and <i>ChildHandle</i> is not <b>NULL</b> .
EFI_INVALID_PARAMETER	<i>Language</i> is <b>NULL</b> .
EFI_INVALID_PARAMETER	<i>ErrorType</i> is <b>NULL</b> .
EFI_INVALID_PARAMETER	<i>BufferSize</i> is <b>NULL</b> .
EFI_INVALID_PARAMETER	<i>Buffer</i> is <b>NULL</b> .
EFI_UNSUPPORTED	The driver specified by <i>This</i> does not support running diagnostics for the controller specified by <i>ControllerHandle</i> and <i>ChildHandle</i> .
EFI_UNSUPPORTED	The driver specified by <i>This</i> does not support the type of diagnostic specified by <i>DiagnosticType</i> .
EFI_UNSUPPORTED	The driver specified by <i>This</i> does not support the language specified by <i>Language</i> .
EFI_OUT_OF_RESOURCES	There are not enough resources available to complete the diagnostics.
EFI_OUT_OF_RESOURCES	There are not enough resources available to return the status information in <i>ErrorType</i> , <i>BufferSize</i> , and <i>Buffer</i> .
EFI_DEVICE_ERROR	The controller specified by <i>ControllerHandle</i> and <i>ChildHandle</i> did not pass the diagnostic.
EFI_NOT_READY	The diagnostic operation was started, but not yet completed.

**11.5 EFI Component Name Protocol**

This section provides a detailed description of the **EFI\_COMPONENT\_NAME2\_PROTOCOL**. This is a protocol that allows a driver to provide a user readable name of a UEFI Driver, and a user readable name for each of the

controllers that the driver is managing. This protocol is used by platform management utilities that wish to display names of components. These names may include the names of expansion slots, external connectors, embedded devices, and add-in devices.

## EFI\_COMPONENT\_NAME2\_PROTOCOL

### Summary

Used to retrieve user readable names of drivers and controllers managed by UEFI Drivers.

### GUID

```
#define EFI_COMPONENT_NAME2_PROTOCOL_GUID \
{0x6a7a5cff, 0xe8d9, 0x4f70, \
  {0xba, 0xda, 0x75, 0xab, 0x30, 0x25, 0xce, 0x14}}
```

### Protocol Interface Structure

```
typedef struct _EFI_COMPONENT_NAME2_PROTOCOL {
  EFI_COMPONENT_NAME_GET_DRIVER_NAME  GetDriverName;
  EFI_COMPONENT_NAME_GET_CONTROLLER_NAME  GetControllerName;
  CHAR8                               *SupportedLanguages;
} EFI_COMPONENT_NAME2_PROTOCOL;
```

### Parameters

<i>GetDriverName</i>	Retrieves a string that is the user readable name of the driver. See the <a href="#">GetDriverName()</a> function description.
<i>GetControllerName</i>	Retrieves a string that is the user readable name of a controller that is being managed by a driver. See the <a href="#">GetControllerName()</a> function description.
<i>SupportedLanguages</i>	A Null-terminated ASCII string array that contains one or more supported language codes. This is the list of language codes that this protocol supports. The number of languages supported by a driver is up to the driver writer. <i>SupportedLanguages</i> is specified in RFC 4646 format. See <a href="#">Appendix M</a> for the format of language codes and language code arrays.

### Description

The **EFI\_COMPONENT\_NAME2\_PROTOCOL** is used to retrieve a driver's user readable name and the names of all the controllers that a driver is managing from the driver's point of view. Each of these names is returned as a Null-terminated string. The caller is required to specify the language in which the string is returned, and this language must be present in the list of languages that this protocol supports specified by *SupportedLanguages*.

## EFI\_COMPONENT\_NAME2\_PROTOCOL.GetDriverName()

### Summary

Retrieves a string that is the user readable name of the driver.

### Prototype

```
typedef
EFI_STATUS
(EFIAPI *EFI_COMPONENT_NAME_GET_DRIVER_NAME) (
  IN EFI_COMPONENT_NAME2_PROTOCOL *This,
  IN CHAR8      *Language,
  OUT CHAR16    **DriverName
);
```

### Parameters

<i>This</i>	A pointer to the <a href="#">EFI_COMPONENT_NAME2_PROTOCOL</a> instance.
<i>Language</i>	A pointer to a Null-terminated ASCII string array indicating the language. This is the language of the driver name that the caller is requesting, and it must match one of the languages specified in SupportedLanguages. The number of languages supported by a driver is up to the driver writer. <i>Language</i> is specified in RFC 4646 language code format. See <a href="#">Appendix M</a> for the format of language codes. Callers of interfaces that require RFC 4646 language codes to retrieve a Unicode string must use the RFC 4647 algorithm to lookup the Unicode string with the closest matching RFC 4646 language code.
<i>DriverName</i>	A pointer to the string to return. This string is the name of the driver specified by <i>This</i> in the language specified by <i>Language</i> .

### Description

This function retrieves the user readable name of a driver in the form of a string. If the driver specified by *This* has a user readable name in the language specified by *Language*, then a pointer to the driver name is returned in *DriverName*, and **EFI\_SUCCESS** is returned. If the driver specified by *This* does not support the language specified by *Language*, then **EFI\_UNSUPPORTED** is returned.

### Status Codes Returned

EFI_SUCCESS	The string for the user readable name in the language specified by <i>Language</i> for the driver specified by <i>This</i> was returned in <i>DriverName</i> .
EFI_INVALID_PARAMETER	<i>Language</i> is <b>NULL</b> .

EFI_INVALID_PARAMETER	<i>DriverName</i> is <b>NULL</b> .
EFI_UNSUPPORTED	The driver specified by <i>This</i> does not support the language specified by <i>Language</i> .

## EFI\_COMPONENT\_NAME2\_PROTOCOL.GetControllerName()

### Summary

Retrieves a string that is the user readable name of the controller that is being managed by a driver.

### Prototype

```
typedef
EFI_STATUS
(EFI_API *EFI_COMPONENT_NAME_GET_CONTROLLER_NAME) (
  IN EFI_COMPONENT_NAME2_PROTOCOL *This,
  IN EFI_HANDLE      ControllerHandle,
  IN EFI_HANDLE      ChildHandle OPTIONAL,
  IN CHAR8           *Language,
  OUT CHAR16         **ControllerName
);
```

### Parameters

<i>This</i>	A pointer to the <a href="#">EFI_COMPONENT_NAME2_PROTOCOL</a> instance.
<i>ControllerHandle</i>	The handle of a controller that the driver specified by <i>This</i> is managing. This handle specifies the controller whose name is to be returned.
<i>ChildHandle</i>	The handle of the child controller to retrieve the name of. This is an optional parameter that may be <b>NULL</b> . It will be <b>NULL</b> for device drivers. It will also be <b>NULL</b> for bus drivers that attempt to retrieve the name of the bus controller. It will not be <b>NULL</b> for a bus driver that attempts to retrieve the name of a child controller.
<i>Language</i>	A pointer to a Null-terminated ASCII string array indicating the language. This is the language of the controller name that the caller is requesting, and it must match one of the languages specified in SupportedLanguages. The number of languages supported by a driver is up to the driver writer. <i>Language</i> is specified in RFC 4646 language code format. See <a href="#">Appendix M</a> for the format of language codes. Callers of interfaces that require RFC 4646 language codes to retrieve a Unicode string must use the RFC 4647 algorithm to lookup the Unicode string with the closest matching RFC 4646 language code.
<i>ControllerName</i>	A pointer to the string to return. This string is the name of the controller specified by <i>ControllerHandle</i> and <i>ChildHandle</i> in the language specified by <i>Language</i> from the point of view of the driver specified by <i>This</i> .

## Description

This function retrieves the user readable name of the controller specified by *ControllerHandle* and *ChildHandle* in the form of a string. If the driver specified by *This* has a user readable name in the language specified by *Language*, then a pointer to the controller name is returned in *ControllerName*, and **EFI\_SUCCESS** is returned.

If the driver specified by *This* is not currently managing the controller specified by *ControllerHandle* and *ChildHandle*, then **EFI\_UNSUPPORTED** is returned.

If the driver specified by *This* does not support the language specified by *Language*, then **EFI\_UNSUPPORTED** is returned.

## Status Codes Returned

EFI_SUCCESS	The string for the user readable name specified by <i>This</i> , <i>ControllerHandle</i> , <i>ChildHandle</i> , and <i>Language</i> was returned in <i>ControllerName</i> .
EFI_INVALID_PARAMETER	<i>ControllerHandle</i> is <b>NULL</b> .
EFI_INVALID_PARAMETER	The driver specified by <i>This</i> is not a device driver, and <i>ChildHandle</i> is not <b>NULL</b> .
EFI_INVALID_PARAMETER	<i>Language</i> is <b>NULL</b> .
EFI_INVALID_PARAMETER	<i>ControllerName</i> is <b>NULL</b> .
EFI_UNSUPPORTED	The driver specified by <i>This</i> is a device driver and <i>ChildHandle</i> is not <b>NULL</b> .
EFI_UNSUPPORTED	The driver specified by <i>This</i> is not currently managing the controller specified by <i>ControllerHandle</i> and <i>ChildHandle</i> .
EFI_UNSUPPORTED	The driver specified by <i>This</i> does not support the language specified by <i>Language</i> .

## 11.6 EFI Service Binding Protocol

This section provides a detailed description of the **EFI\_SERVICE\_BINDING\_PROTOCOL**. This protocol may be produced only by drivers that follow the UEFI Driver Model. Use this protocol with the **EFI\_DRIVER\_BINDING\_PROTOCOL** to produce a set of protocols related to a device. The **EFI\_DRIVER\_BINDING\_PROTOCOL** supports simple layering of protocols on a device, but it does not support more complex relationships such as trees or graphs. The **EFI\_SERVICE\_BINDING\_PROTOCOL** provides a member function to create a child handle with a new protocol installed on it, and another member function to destroy a previously created child handle. These member functions apply equally to all drivers.

## EFI\_SERVICE\_BINDING\_PROTOCOL

### Summary

Provides services that are required to create and destroy child handles that support a given set of protocols.

### GUID

This protocol does not have its own GUID. Instead, drivers for other protocols will define a GUID that shares the same protocol interface as the **EFI\_SERVICE\_BINDING\_PROTOCOL**. The protocols defined in this document that have this property include the following:

- **EFI\_MANAGED\_NETWORK\_SERVICE\_BINDING\_PROTOCOL**
- **EFI\_ARP\_SERVICE\_BINDING\_PROTOCOL**
- **EFI\_EAP\_SERVICE\_BINDING\_PROTOCOL**
- **EFI\_IP4\_SERVICE\_BINDING\_PROTOCOL**
- **EFI\_TCP4\_SERVICE\_BINDING\_PROTOCOL**
- **EFI\_UDP4\_SERVICE\_BINDING\_PROTOCOL**
- **EFI\_MTFTP4\_SERVICE\_BINDING\_PROTOCOL**
- **EFI\_DHCP4\_SERVICE\_BINDING\_PROTOCOL**

### Protocol Interface Structure

```
typedef struct _EFI_SERVICE_BINDING_PROTOCOL {
    EFI_SERVICE_BINDING_CREATE_CHILD CreateChild;
    EFI_SERVICE_BINDING_DESTROY_CHILD DestroyChild;
} EFI_SERVICE_BINDING_PROTOCOL;
```

### Parameters

<i>CreateChild</i>	Creates a child handle and installs a protocol. See the <a href="#">CreateChild()</a> function description.
<i>DestroyChild</i>	Destroys a child handle with a protocol installed on it. See the <a href="#">DestroyChild()</a> function description.

### Description

The **EFI\_SERVICE\_BINDING\_PROTOCOL** provides member functions to create and destroy child handles. A driver is responsible for adding protocols to the child handle in **CreateChild()** and removing protocols in **DestroyChild()**. It is also required that the **CreateChild()** function opens the parent protocol BY\_CHILD\_CONTROLLER to establish the parent-child relationship, and closes the protocol in **DestroyChild()**. The pseudo code for **CreateChild()** and **DestroyChild()** is provided to specify the required behavior, not to specify the required implementation. Each consumer of a software protocol is responsible for calling **CreateChild()** when it requires the protocol and calling **DestroyChild()** when it is finished with that protocol.

## EFI\_SERVICE\_BINDING\_PROTOCOL.CreateChild()

### Summary

Creates a child handle and installs a protocol.

### Prototype

```
typedef
EFI_STATUS
(EFIAPI *EFI_SERVICE_BINDING_CREATE_CHILD) (
    IN EFI_SERVICE_BINDING_PROTOCOL *This,
    IN OUT EFI_HANDLE *ChildHandle
);
```

### Parameters

<i>This</i>	Pointer to the <b>EFI_SERVICE_BINDING_PROTOCOL</b> instance.
<i>ChildHandle</i>	Pointer to the handle of the child to create. If it is a pointer to <b>NULL</b> , then a new handle is created. If it is a pointer to an existing UEFI handle, then the protocol is added to the existing UEFI handle.

### Description

The **CreateChild()** function installs a protocol on *ChildHandle*. If *ChildHandle* is a pointer to **NULL**, then a new handle is created and returned in *ChildHandle*. If *ChildHandle* is not a pointer to **NULL**, then the protocol installs on the existing *ChildHandle*.

### Status Codes Returned

EFI_SUCCESS	The protocol was added to <i>ChildHandle</i> .
EFI_INVALID_PARAMETER	<i>ChildHandle</i> is <b>NULL</b> .
EFI_OUT_OF_RESOURCES	There are not enough resources available to create the child.
Other	The child handle was not created.

### Examples

The following example shows how a consumer of the EFI ARP Protocol would use the **CreateChild()** function of the **EFI\_SERVICE\_BINDING\_PROTOCOL** to create a child handle with the EFI ARP Protocol installed on that handle.



```
EFI_HANDLE      ControllerHandle;
EFI_HANDLE      DriverBindingHandle;
EFI_HANDLE      ChildHandle;
EFI_arp_service_binding_protocol *ArpSb;
EFI_arp_protocol *Arp;

//
// Get the ArpServiceBinding Protocol
//
Status = gBS->OpenProtocol (
    ControllerHandle,
    &gEfiArpServiceBindingProtocolGuid,
    (VOID **)&ArpSb,
    DriverBindingHandle,
    ControllerHandle,
    EFI_OPEN_PROTOCOL_GET_PROTOCOL
);
if (EFI_ERROR (Status)) {
    return Status;
}
//
// Initialize a ChildHandle
//
ChildHandle = NULL;
//
// Create a ChildHandle with the Arp Protocol
//
Status = ArpSb->CreateChild (ArpSb, &ChildHandle);
if (EFI_ERROR (Status)) {
    goto ErrorExit;
}
```

```

//
// Retrieve the Arp Protocol from ChildHandle
//
Status = gBS->OpenProtocol (
    ChildHandle,
    &gEfiArpProtocolGuid,
    (VOID **)&Arp,
    DriverBindingHandle,
    ControllerHandle,
    EFI_OPEN_PROTOCOL_BY_DRIVER
);
if (EFI_ERROR (Status)) {
    goto ErrorExit;
}

```

## Pseudo Code

The following is the general algorithm for implementing the **CreateChild()** function:

1. Allocate and initialize any data structures that are required to produce the requested protocol on a child handle. If the allocation fails, then return **EFI\_OUT\_OF\_RESOURCES**.
2. Install the requested protocol onto *ChildHandle*. If *ChildHandle* is a pointer to **NULL**, then the requested protocol installs onto a new handle.
3. Open the parent protocol **BY\_CHILD\_CONTROLLER** to establish the parent-child relationship. If the parent protocol cannot be opened, then destroy the *ChildHandle* created in step 2, free the data structures allocated in step 1, and return an error.
4. Increment the number of children created by **CreateChild()**.
5. Return **EFI\_SUCCESS**.

Listed below is sample code of the **CreateChild()** function of the EFI ARP Protocol driver. This driver looks up its private context data structure from the instance of the **EFI\_SERVICE\_BINDING\_PROTOCOL** produced on the handle for the network controller. After retrieving the private context data structure, the driver can use its contents to build the private context data structure for the child being created. The EFI ARP Protocol driver then installs the **EFI\_ARP\_PROTOCOL** onto *ChildHandle*.

```
EFI_STATUS
EFI_API
ArpServiceBindingCreateChild (
  IN EFI_SERVICE_BINDING_PROTOCOL *This,
  IN EFI_HANDLE *ChildHandle
)
{
  EFI_STATUS Status;
  ARP_PRIVATE_DATA *Private;
  ARP_PRIVATE_DATA *PrivateChild;

  //
  // Retrieve the Private Context Data Structure
  //
  Private = ARP_PRIVATE_DATA_FROM_SERVICE_BINDING_THIS (This);

  //
  // Create a new child
  //
  PrivateChild = EfiLibAllocatePool (sizeof (ARP_PRIVATE_DATA));
  if (PrivateChild == NULL) {
    return EFI_OUT_OF_RESOURCES;
  }

  //
  // Copy Private Context Data Structure
  //
  gBS->CopyMem (PrivateChild, Private, sizeof (ARP_PRIVATE_DATA));
}
```

```
//
// Install Arp onto ChildHandle
//
Status = gBS->InstallMultipleProtocolInterfaces (
    ChildHandle,
    &gEfiArpProtocolGuid, &PrivateChild->Arp,
    NULL
);
if (EFI_ERROR (Status)) {
    gBS->FreePool (PrivateChild);
    return Status;
}

Status = gBS->OpenProtocol (
    Private->ChildHandle,
    &gEfiManagedNetworkProtocolGuid,
    (VOID **)&PrivateChild->ManagedNetwork,
    gArpDriverBinding.DriverBindingHandle,
    *ChildHandle,
    EFI_OPEN_PROTOCOL_BY_CHILD_CONTROLLER
);
if (EFI_ERROR (Status)) {
    ArpSB->DestroyChild (This, ChildHandle);
    return Status;
}

//
// Increase number of children created
//
Private->NumberCreated++;

return EFI_SUCCESS;
}
```

## EFI\_SERVICE\_BINDING\_PROTOCOL.DestroyChild()

### Summary

Destroys a child handle with a protocol installed on it.

### Prototype

```
typedef
EFI_STATUS
(EFIAPI *EFI_SERVICE_BINDING_DESTROY_CHILD) (
    IN EFI_SERVICE_BINDING_PROTOCOL *This,
    IN EFI_HANDLE                    ChildHandle
);
```

### Parameters

<i>This</i>	Pointer to the <b>EFI_SERVICE_BINDING_PROTOCOL</b> instance.
<i>ChildHandle</i>	Handle of the child to destroy.

### Description

The **DestroyChild()** function does the opposite of **CreateChild()**. It removes a protocol that was installed by **CreateChild()** from *ChildHandle*. If the removed protocol is the last protocol on *ChildHandle*, then *ChildHandle* is destroyed.

### Status Codes Returned

EFI_SUCCESS	The protocol was removed from <i>ChildHandle</i> .
EFI_UNSUPPORTED	<i>ChildHandle</i> does not support the protocol that is being removed.
EFI_INVALID_PARAMETER	<i>ChildHandle</i> is not a valid UEFI handle.
EFI_ACCESS_DENIED	The protocol could not be removed from the <i>ChildHandle</i> because its services are being used.
Other	The child handle was not destroyed.

### Examples

The following example shows how a consumer of the EFI ARP Protocol would use the **DestroyChild()** function of the **EFI\_SERVICE\_BINDING\_PROTOCOL** to destroy a child handle with the EFI ARP Protocol installed on that handle.

```

EFI_HANDLE      ControllerHandle;
EFI_HANDLE      DriverBindingHandle;
EFI_HANDLE      ChildHandle;
EFI_ARSERVICE_BINDING_PROTOCOL *Arp;

//
// Get the Arp Service Binding Protocol
//
Status = gBS->OpenProtocol (
    ControllerHandle,
    &gEfiArpServiceBindingProtocolGuid,
    (VOID **)&ArpSb,
    DriverBindingHandle,
    ControllerHandle,
    EFI_OPEN_PROTOCOL_GET_PROTOCOL
);
if (EFI_ERROR (Status)) {
    return Status;
}

//
// Destroy the ChildHandle with the Arp Protocol
//
Status = ArpSb->DestroyChild (ArpSb, ChildHandle);
if (EFI_ERROR (Status)) {
    return Status;
}

```

## Pseudo Code

The following is the general algorithm for implementing the **DestroyChild()** function:

1. Retrieve the protocol from *ChildHandle*. If this retrieval fails, then return **EFI\_SUCCESS** because the child has already been destroyed.
2. If this call is a recursive call to destroy the same child, then return **EFI\_SUCCESS**.
3. Close the parent protocol with **CloseProtocol()**.
4. Set a flag to detect a recursive call to destroy the same child.
5. Remove the protocol from *ChildHandle*. If this removal fails, then reopen the parent protocol and clear the flag to detect a recursive call to destroy the same child.
6. Free any data structures that allocated in **CreateChild()**.
7. Decrement the number of children that created with **CreateChild()**.
8. Return **EFI\_SUCCESS**.

Listed below is sample code of the **DestroyChild()** function of the EFI ARP Protocol driver. This driver looks up its private context data structure from the instance of the **EFI\_SERVICE\_BINDING\_PROTOCOL** produced on the handle for the network controller. The driver attempts to retrieve the **EFI\_ARSERVICE\_BINDING\_PROTOCOL** from *ChildHandle*. If that fails, then **EFI\_SUCCESS** is returned. The **EFI\_ARSERVICE\_BINDING\_PROTOCOL** is then used to retrieve the

private context data structure for the child. The private context data stores the flag that detects if **DestroyChild()** is being called recursively. If a recursion is detected, then **EFI\_SUCCESS** is returned. Otherwise, the **EFI\_ARD\_PROTOCOL** is removed from *ChildHandle*, the number of children are decremented, and **EFI\_SUCCESS** is returned.

```

EFI_STATUS
EFIAPI
ArpServiceBindingDestroyChild (
  IN EFI_SERVICE_BINDING_PROTOCOL *This,
  IN EFI_HANDLE      ChildHandle
)
{
  EFI_STATUS  Status;
  EFI_ARP_PROTOCOL *Arp;
  ARP_PRIVATE_DATA *Private;
  ARP_PRIVATE_DATA *PrivateChild;

  //
  // Retrieve the Private Context Data Structure
  //
  Private = ARP_PRIVATE_DATA_FROM_SERVICE_BINDING_THIS (This);

  //
  // Retrieve Arp Protocol from ChildHandle
  //
  Status = gBS->OpenProtocol (
    ChildHandle,
    &gEfiArpProtocolGuid,
    (VOID **)&Arp,
    gArpDriverBinding.DriverBindingHandle,
    ChildHandle,
    EFI_OPEN_PROTOCOL_GET_PROTOCOL
  );
  if (EFI_ERROR (Status)) {
    return EFI_SUCCESS;
  }

  //
  // Retrieve Private Context Data Structure
  //
  PrivateChild = ARP_PRIVATE_DATA_FROM_ARP_THIS (Arp);
  if (PrivateChild->Destroy) {
    return EFI_SUCCESS;
  }

  //
  // Close the ManagedNetwork Protocol
  //
  gBS->CloseProtocol (
    Private->ChildHandle,
    &gEfiManagedNetworkProtocolGuid,
    gArpDriverBinding.DriverBindingHandle,

```



```

        ChildHandle
    );

    PrivateChild->Destroy = TRUE;

    //
    // Uninstall Arp from ChildHandle
    //
    Status = gBS->UninstallMultipleProtocolInterfaces (
        ChildHandle,
        &gEfiArpProtocolGuid, &PrivateChild->Arp,
        NULL
    );
    if (EFI_ERROR (Status)) {
        //
        // Uninstall failed, so reopen the parent Arp Protocol and
        // return an error
        //
        PrivateChild->Destroy = FALSE;
        gBS->OpenProtocol (
            Private->ChildHandle,
            &gEfiManagedNetworkProtocolGuid,
            (VOID **)&PrivateChild->ManagedNetwork,
            gArpDriverBinding.DriverBindingHandle,
            ChildHandle,
            EFI_OPEN_PROTOCOL_BY_CHILD_CONTROLLER
        );
        return Status;
    }

    //
    // Free Private Context Data Structure
    //
    gBS->FreePool (PrivateChild);

    //
    // Decrease number of children created
    //
    Private->NumberCreated--;

    return EFI_SUCCESS;

```

## 11.7 EFI Platform to Driver Configuration Protocol

This section provides a detailed description of the **EFI\_PLATFORM\_TO\_DRIVER\_CONFIGURATION\_PROTOCOL**. This is a protocol that is

optionally produced by the platform and optionally consumed by a UEFI Driver in its **Start()** function. This protocol allows the driver to receive configuration information as part of being started.

## EFI\_PLATFORM\_TO\_DRIVER\_CONFIGURATION\_PROTOCOL

### Summary

Used to retrieve configuration information for a device that a UEFI driver is about to start.

### GUID

```
#define EFI_PLATFORM_TO_DRIVER_CONFIGURATION_PROTOCOL_GUID \
  { 0x642cd590, 0x8059, 0x4c0a, \
    { 0xa9, 0x58, 0xc5, 0xec, 0x07, 0xd2, 0x3c, 0x4b } }
```

### Protocol Interface Structure

```
typedef struct _EFI_PLATFORM_TO_DRIVER_CONFIGURATION_PROTOCOL {
  EFI_PLATFORM_TO_DRIVER_CONFIGURATION_QUERY Query;
  EFI_PLATFORM_TO_DRIVER_CONFIGURATION_RESPONSE Response;
} EFI_PLATFORM_TO_DRIVER_CONFIGURATION_PROTOCOL;
```

### Parameters

<i>Query</i>	Called by the UEFI Driver <b>Start()</b> function to get configuration information from the platform.
<i>Response</i>	Called by the UEFI Driver <b>Start()</b> function to let the platform know how UEFI driver processed the data return from <i>Query</i> .

### Description

The **EFI\_PLATFORM\_TO\_DRIVER\_CONFIGURATION\_PROTOCOL** is used by the UEFI driver to query the platform for configuration information. The UEFI driver calls [Query\(\)](#) multiple times to get configuration information from the platform. For every call to [Query\(\)](#) there must be a matching call to [Response\(\)](#) so the UEFI driver can inform the platform how it used the information passed in from [Query\(\)](#).

It's legal for a UEFI driver to use [Response\(\)](#) to inform the platform it does not understand the data returned via [Query\(\)](#) and thus no action was taken.

## EFI\_PLATFORM\_TO\_DRIVER\_CONFIGURATION\_PROTOCOL.Query()

### Summary

Allows the UEFI driver to query the platform for configuration information needed to complete the drivers **Start()** operation.

### Prototype

```
typedef
EFI_STATUS
(EFI_API *EFI_PLATFORM_TO_DRIVER_CONFIGURATION_QUERY) (
  IN EFI_PLATFORM_TO_DRIVER_CONFIGURATION_PROTOCOL *This,
  IN EFI_HANDLE      ControllerHandle,
  IN EFI_HANDLE      ChildHandle OPTIONAL,
  IN UINTN           *Instance,
  OUT EFI_GUID       **ParameterTypeGuid,
  OUT VOID           **ParameterBlock,
  OUT UINTN          *ParameterBlockSize
);
```

### Parameters

<i>This</i>	A pointer to the <b>EFI_PLATFORM_TO_DRIVER_CONFIGURATION_PROTOCOL</b> instance.
<i>ControllerHandle</i>	The handle the platform will return configuration information about.
<i>ChildHandle</i>	The handle of the child controller to return information on. This is an optional parameter that may be <b>NULL</b> . It will be <b>NULL</b> for device drivers, and for bus drivers that attempt to get options for the bus controller. It will not be <b>NULL</b> for a bus driver that attempts to get options for one of its child controllers.
<i>Instance</i>	Pointer to the Instance value. Zero means return the first query data. The caller should increment this value by one each time to retrieve successive data.
<i>ParameterTypeGuid</i>	An <b>EFI_GUID</b> that defines the contents of <i>ParameterBlock</i> . UEFI drivers must use the <i>ParameterTypeGuid</i> to determine how to parse the <i>ParameterBlock</i> . The caller should not attempt to free <i>ParameterTypeGuid</i> .
<i>ParameterBlock</i>	The platform returns a pointer to the <i>ParameterBlock</i> structure which contains details about the configuration parameters specific to the <i>ParameterTypeGuid</i> . This structure is defined based on the protocol and may be different for different protocols. UEFI driver decodes this structure and its contents based on <i>ParameterTypeGuid</i> . <i>ParameterBlock</i> is allocated by the platform and the

platform is responsible for freeing the *ParameterBlock* after **Response** is called.

*ParameterBlockSize*

The platform returns the size of the *ParameterBlock* in bytes.

## Description

The UEFI driver must call *Query* early in the **Start()** function before any time consuming operations are performed. If *ChildHandle* is **NULL** the driver is requesting information from the platform about the *ControllerHandle* that is being started. Information returned from *Query* may lead to the drivers **Start()** function failing.

If the UEFI driver is a bus driver and producing a *ChildHandle* the driver must call *Query* after the child handle has been created and an **EFI\_DEVICE\_PATH\_PROTOCOL** has been placed on that handle, but before any time consuming operation is performed. If information return by *Query* may lead the driver to decide to not create the *ChildHandle*. The driver must then cleanup and remove the *ChildHandle* from the system.

The UEFI driver repeatedly calls *Query*, processes the information returned by the platform, and calls *Response* passing in the arguments returned from *Query*. The *Instance* value passed into *Response* must be the same value passed to the corresponding call to *Query*. The UEFI driver must continuously call *Query* and *Response* until **EFI\_NOT\_FOUND** is returned by *Query*.

If the UEFI driver does not recognize the *ParameterTypeGuid*, it calls *Response* with a *ConfigurationAction* of **EfiPlatformConfigurationActionUnsupportedGuid**. The UEFI driver must then continue calling *Query* and *Response* until **EFI\_NOT\_FOUND** is returned by *Query*. This gives the platform an opportunity to pass additional configuration settings using a different *ParameterTypeGuid* that may be supported by the driver.

An *Instance* value of zero means return the first *ParameterBlock* in the set of unprocessed parameter blocks. The driver should increment the *Instance* value by one for each successive call to *Query*.

## Status Codes Returned

EFI_SUCCESS	The platform return parameter information for <i>ControllerHandle</i> .
EFI_NOT_FOUND	No more unread <i>Instance</i> exists.
EFI_INVALID_PARAMETER	<i>ControllerHandle</i> is <b>NULL</b> .
EFI_INVALID_PARAMETER	<i>Instance</i> is <b>NULL</b> .
EFI_DEVICE_ERROR	A device error occurred while attempting to return parameter block information for the controller specified by <i>ControllerHandle</i> and <i>ChildHandle</i> .
EFI_OUT_RESOURCES	There are not enough resources available to set the configuration options for the controller specified by <i>ControllerHandle</i> and <i>ChildHandle</i> .

## EFI\_PLATFORM\_TO\_DRIVER\_CONFIGURATION\_PROTOCOL.Response()

### Summary

Tell the platform what actions were taken by the driver after processing the data returned from *Query*.

### Prototype

```
typedef
EFI_STATUS
(EFIAPI *EFI_PLATFORM_TO_DRIVER_CONFIGURATION_RESPONSE) (
  IN EFI_PLATFORM_TO_DRIVER_CONFIGURATION_PROTOCOL *This,
  IN EFI_HANDLE      ControllerHandle,
  IN EFI_HANDLE      ChildHandle OPTIONAL,
  IN UINTN           *Instance,
  IN EFI_GUID        *ParameterTypeGuid,
  IN VOID            *ParameterBlock,
  IN UINTN           ParameterBlockSize,
  IN EFI_PLATFORM_CONFIGURATION_ACTION ConfigurationAction
);
```

### Parameters

<i>This</i>	A pointer to the <b>EFI_PLATFORM_TO_DRIVER_CONFIGURATION_PROTOCOL</b> instance.
<i>ControllerHandle</i>	The handle the driver is returning configuration information about.
<i>ChildHandle</i>	The handle of the child controller to return information on. This is an optional parameter that may be <b>NULL</b> . It will be <b>NULL</b> for device drivers, and for bus drivers that attempt to get options for the bus controller. It will not be <b>NULL</b> for a bus driver that attempts to get options for one of its child controllers.
<i>Instance</i>	Instance data passed to <a href="#">Query()</a> .
<i>ParameterTypeGuid</i>	<i>ParameterTypeGuid</i> returned from <i>Query</i> .
<i>ParameterBlock</i>	<i>ParameterBlock</i> returned from <i>Query</i> .
<i>ParameterBlockSize</i>	The <i>ParameterBlock</i> size returned from <i>Query</i> .
<i>ConfigurationAction</i>	The driver tells the platform what action is required for <i>ParameterBlock</i> to take effect. See "Related Definitions" for a list of actions.

### Description

The UEFI driver repeatedly calls *Query*, processes the information returned by the platform, and calls *Response* passing in the arguments returned from *Query*. The UEFI driver must continuously call *Query* until **EFI\_NOT\_FOUND** is returned. For every call to *Query* that returns **EFI\_SUCCESS** a corresponding call to *Response* is required passing in

the same *ControllerHandle*, *ChildHandle*, Instance, *ParameterTypeGuid*, *ParameterBlock*, and *ParameterBlockSize*. The UEFI driver may update values in *ParameterBlock* based on rules defined by *ParameterTypeGuid*.

The platform is responsible for freeing *ParameterBlock* and the UEFI driver must not try to free it.

## Related Definitions

```
typedef enum {
  EfiPlatformConfigurationActionNone      = 0,
  EfiPlatformConfigurationActionStopController = 1,
  EfiPlatformConfigurationActionRestartController = 2,
  EfiPlatformConfigurationActionRestartPlatform = 3,
  EfiPlatformConfigurationActionNvramFailed = 4,
  EfiPlatformConfigurationActionUnsupportedGuid = 5,
  EfiPlatformConfigurationActionMaximum
} EFI_PLATFORM_CONFIGURATION_ACTION;
```

### *EfiPlatformConfigurationActionNone*

The controller specified by *ControllerHandle* is still in a usable state, it's configuration has been updated via parsing the *ParameterBlock*. If required by the parameter block and the module supports an NVRAM store the configuration information from *ParameterBlock* was successfully saved to the NVRAM. No actions are required before this controller can be used again with the updated configuration settings

### *EfiPlatformConfigurationStopController*

The driver has detected that the controller specified by *ControllerHandle* is not in a usable state, and it needs to be stopped. The calling agent can use the [EFI\\_BOOT\\_SERVICES.DisconnectController\(\)](#) service to perform this operation, and it should be performed as soon as possible.

### *EfiPlatformConfigurationRestartController*

This controller specified by *ControllerHandle* needs to be stopped and restarted before it can be used again. The calling agent can use the [DisconnectController\(\)](#) and [EFI\\_BOOT\\_SERVICES.ConnectController\(\)](#) services to perform this operation. The restart operation can be delayed until all of the configuration options have been set.

### *EfiPlatformConfigurationRestartPlatform*

A configuration change has been made that requires the platform to be restarted before the controller specified by *ControllerHandle* can be used again. The calling agent can use the [ResetSystem\(\)](#) services to perform this operation.

The restart operation can be delayed until all of the configuration options have been set.

#### *EfiPlatformConfigurationActionNvramFailed*

The controller specified by *ControllerHandle* is still in a usable state; its configuration has been updated via parsing the *ParameterBlock*. The driver tried to update the driver's private NVRAM store with information from *ParameterBlock* and failed. No actions are required before this controller can be used again with the updated configuration settings, but these configuration settings are not guaranteed to persist after *ControllerHandle* is stopped.

#### *EfiPlatformConfigurationActionUnsupportedGuid*

The controller specified by *ControllerHandle* is still in a usable state; its configuration has not been updated via parsing the *ParameterBlock*. The driver did not support the *ParameterBlock* format identified by *ParameterTypeGuid*. No actions are required before this controller can be used again. On additional *Query* calls from this *ControllerHandle*, the platform should stop returning a *ParameterBlock* qualified by this same *ParameterTypeGuid*. If no other *ParameterTypeGuid* is supported by the platform, *Query* should return *EFI\_NOT\_FOUND*.

### Status Codes Returned

EFI_SUCCESS	The platform return parameter information for <i>ControllerHandle</i> .
EFI_NOT_FOUND	<i>Instance</i> was not found.
EFI_INVALID_PARAMETER	<i>ControllerHandle</i> is <b>NULL</b> .

### 11.7.1 DMTF SM CLP ParameterTypeGuid

The following parameter protocol *ParameterTypeGuid* provides the support for parameters communicated through the DMTF SM CLP Specification 1.0 Final Standard to be used to configure the UEFI driver.

In this section the producer of the **EFI\_PLATFORM\_TO\_DRIVER\_CONFIGURATION\_PROTOCOL** is platform firmware and the consumer is the UEFI driver.

**Note:** *If future versions of the DMTF SM CLP Specification require changes to the parameter block definition, newer `ParameterTypeGuid` will be used.*

## GUID

```
#define EFI_PLATFORM_TO_DRIVER_CONFIGURATION_CLP_GUID \
{0x345ecc0e, 0xcb6, 0x4b75, \
{0xbb, 0x57, 0x1b, 0x12, 0x9c, 0x47, 0x33, 0x3e}}
```

## Parameter Block

```
typedef struct {
    CHAR8 *CLPCommand;
    UINT32 CLPCommandLength;
    CHAR8 *CLPReturnString;
    UINT32 CLPReturnStringLength;
    UINT8 CLPCmdStatus;
    UINT8 CLPErrorValue;
    UINT16 CLPMsgCode;
} EFI_CONFIGURE_CLP_PARAMETER_BLK;
```

## Structure Member Definitions

<i>CLPCommand</i>	A pointer to the null-terminated UTF-8 string that specifies the DMTF SM CLP command line that the driver is required to parse and process when this function is called. See the <i>DMTF SM CLP Specification 1.0 Final Standard</i> for details on the format and syntax of the CLP command line string.  <i>CLPCommand</i> buffer is allocated by the producer of the <b>EFI_PLATFORM_TO_DRIVER_CONFIGURATION_PROTOCOL</b> .
<i>CLPCommandLength</i>	The length of the CLP Command in bytes.
<i>CLPReturnString</i>	A pointer to the null-terminated UTF-8 string that indicates the CLP return status that the driver is required to provide to the calling agent. The calling agent may parse and/or pass this for processing and user feedback. The SM CLP Command Response string buffer is filled in by the UEFI driver in the “keyword=value” format described in the <i>SM CLP Specification</i> (see section 3.table 101, “Output Data”), unless otherwise requested via the SM CLP -output option in the Command Line string buffer. UEFI driver’s support for this default “keyword=value” output format is required if the UEFI driver supports this protocol, while support for other SM CLP output formats is optional. (The UEFI Driver should set CLPCmdStatus=2 (COMMAND PROCESSING FAILED) and CLPErrorValue=249 (OUTPUT FORMAT NOT SUPPORTED) if the SM CLP -output option requested by the caller is not supported by the UEFI Driver.)



	<i>CLPReturnString</i> buffer is allocated by the consumer of the <b>EFI_PLATFORM_TO_DRIVER_CONFIGURATION_PROTOCOL</b> and undefined prior to the call to <i>Response()</i> .
<i>CLPReturnStringLength</i>	The length of the CLP return status string in bytes.
<i>CLPCmdStatus</i>	SM CLP Command Status (see <i>DMTF SM CLP Specification 1.0</i> Final Standard - Table 4)
<i>CLPErrorValue</i>	SM CLP Processing Error Value (see <i>DMTF SM CLP Specification 1.0</i> Final Standard - Table 6). This field is filled in by the consumer of the <b>EFI_PLATFORM_TO_DRIVER_CONFIGURATION_PROTOCOL</b> and undefined prior to the call to <i>Response()</i> .
<i>CLPMsgCode</i>	Bit 15: OEM Message Code Flag 0 = Message Code is an SM CLP Probable Cause Value. (see SM CLP Specification Table 11) 1 = Message Code is OEM Specific Bits 14-0: Message Code This field is filled in by the consumer of the <b>EFI_PLATFORM_TO_DRIVER_CONFIGURATION_PROTOCOL</b> and undefined prior to the call to <i>Response()</i> .

## 11.8 EFI Driver Supported EFI Version Protocol

### EFI\_DRIVER\_SUPPORTED\_EFI\_VERSION\_PROTOCOL

#### Summary

Provides information about the version of the EFI specification that a driver is following. This protocol is required for EFI drivers that are on PCI and other plug in cards.

#### GUID

```
#define EFI_DRIVER_SUPPORTED_EFI_VERSION_PROTOCOL_GUID \
{ 0x5c198761, 0x16a8, 0x4e69, \
  { 0x97, 0x2c, 0x89, 0xd6, 0x79, 0x54, 0xf8, 0x1d } }
```

#### Protocol Interface Structure

```
typedef struct _EFI_DRIVER_SUPPORTED_EFI_VERSION_PROTOCOL {
  UINT32 Length;
  UINT32 FirmwareVersion;
} EFI_DRIVER_SUPPORTED_EFI_VERSION_PROTOCOL;
```

#### Parameters

*Length* The size, in bytes, of the entire structure. Future versions of this specification may grow the size of the structure.

*FirmwareVersion*

The latest version of the UEFI Specification that this driver conforms to. Refer to the **EFI\_SPECIFICATION\_VERSION** definition in [Section 4.3](#).

**Description**

The **EFI\_DRIVER\_SUPPORTED\_EFI\_VERSION\_PROTOCOL** provides a mechanism for an EFI driver to publish the version of the EFI specification it conforms to. This protocol must be placed on the driver's image handle when the driver's entry point is called.

## 11.9 EFI Driver Family Override Protocol

### 11.9.1 Overview

This section defines the Driver Family Override Protocol, and contains the following:

- Description and code definitions of the Driver Family Override Protocol.
- Required updates to the EFI Boot Services `ConnectController()`.
- Typical production of the Driver Family Override Protocol by an EFI Driver that follows the EFI Driver Model.

The Driver Family Override Protocol provides a method for an EFI Driver to opt-in to a higher priority rule for connecting drivers to controllers in the EFI Boot Service **ConnectController()**. This new rule is higher priority than the Bus Specific Driver Override Protocol rule and lower priority than the Platform Driver Override Rule.

The Driver Family Override Protocol is a backwards compatible extension to the EFI Driver Model and is only available during boot time. The Driver Family Override Protocol may be optionally produced by a driver that follows the EFI Driver Model. If this protocol is produced, it must be installed onto the Driver Image Handle. Drivers that follow the EFI Driver Model typically install the EFI Driver Binding Protocol onto the driver's image handle. In this case, the Driver Family Override Protocol must also be installed onto the driver's image handle. If a single EFI Driver produces more than one instance of the EFI Driver Binding Protocol, then the Driver Family Override Protocol must be installed onto the same handle as the EFI Driver Binding Protocol that is associated with the Driver Family Override Protocol. Since it is legal for a single EFI Driver to produce multiple EFI Driver Binding Protocol instances, it is also legal for a single EFI Driver to produce multiple Driver Family Override Protocol instances.

## EFI\_DRIVER\_FAMILY\_OVERRIDE\_PROTOCOL

### Summary

When installed, the Driver Family Override Protocol informs the UEFI Boot Service **ConnectController()** that this driver is higher priority than the list of drivers returned by the Bus Specific Driver Override Protocol.

## GUID

```
#define EFI_DRIVER_FAMILY_OVERRIDE_PROTOCOL_GUID \
{0xb1ee129e,0xda36,0x4181,\
{0x91,0xf8,0x04,0xa4,0x92,0x37,0x66,0xa7}}
```

## Protocol Interface Structure

```
typedef struct _EFI_DRIVER_FAMILY_OVERRIDE_PROTOCOL {
    EFI_DRIVER_FAMILY_OVERRIDE_GET_VERSION GetVersion;
} EFI_DRIVER_FAMILY_OVERRIDE_PROTOCOL;
```

## Parameters

*GetVersion*

Retrieves the version of the driver that is used by the EFI Boot Service **ConnectController()** to sort the set of Driver Binding Protocols in order from highest priority to lowest priority. For drivers that support the Driver Family Override Protocol, those drivers are sorted so that the drivers with higher values returned by **GetVersion()** are high priority that drivers that return lower values from **GetVersion()**.

## Description

This protocol contains a single service that returns a version value for the driver that produces this protocol. High values are higher priority than lower values when evaluated by the EFI Boot Service **ConnectController()**. This is an optional protocol that may be produced by an EFI Driver that follows the EFI Driver Model. If this protocol is produced, it must be installed onto a handle that also contains the EFI Driver Binding Protocol.

If this protocol is not produced by an EFI Driver, then the rules used to connect a driver to a controller from highest priority to lowest priority are as follows:

- Context Override
- Platform Driver Override
- Bus Specific Driver Override Protocol
- Driver Binding Search

If this protocol is produced by an EFI Driver, then the rules used to connect a driver to a controller from highest priority to lowest priority are as follows:

- Context Override
- Platform Driver Override
- Driver Family Override
- Bus Specific Driver Override
- Driver Binding Search

## EFI\_DRIVER\_FAMILY\_OVERRIDE\_PROTOCOL.GetVersion ()

### Summary

Retrieves the version of the driver that is used by the EFI Boot Service **ConnectController()** to sort the set of Driver Binding Protocols in order from highest priority to lowest priority. For drivers that support the Driver Family Override Protocol, those drivers are sorted so that the drivers with higher values returned by **GetVersion()** are high priority that drivers that return lower values from **GetVersion()**.

### Prototype

```
typedef
UINT32
(EFI_API *EFI_DRIVER_FAMILY_OVERRIDE_GET_VERSION) (
  IN EFI_DRIVER_FAMILY_OVERRIDE_PROTOCOL *This
);
```

### Parameters

*This*

A pointer to the **EFI\_DRIVER\_FAMILY\_OVERRIDE\_PROTOCOL** instance.

### Description

This function returns the version value associated with the driver specified by *This*.

## 11.10 EFI Driver Health Protocol

This section contains the basic definitions of the Driver Health Protocol.

### EFI\_DRIVER\_HEALTH\_PROTOCOL

#### Summary

When installed, the Driver Health Protocol produces a collection of services that allow the health status for a controller to be retrieved. If a controller is not in a usable state, status messages may be reported to the user, repair operations can be invoked, and the user may be asked to make software and/or hardware configuration changes. All display, as well as interaction, with the user must be handled by the consumer of the Driver Health Protocol.

#### GUID

```
#define EFI_DRIVER_HEALTH_PROTOCOL_GUID \
  {0x2a534210,0x9280,0x41d8,\
   {0xae,0x79,0xca,0xda,0x01,0xa2,0xb1,0x27 }}
```

## Protocol Interface Structure

```
typedef struct _EFI_DRIVER_HEALTH_PROTOCOL {  
    EFI_DRIVER_HEALTH_GET_HEALTH_STATUS GetHealthStatus;  
    EFI_DRIVER_HEALTH_REPAIR Repair;  
} EFI_DRIVER_HEALTH_PROTOCOL;
```

## Parameters

<i>GetHealthStatus</i>	Retrieves the health status of a controller in the platform. This function can also optionally return warning messages, error messages, and an HII Form that may be used to repair a controller that is not properly configured.
<i>Repair</i>	Performs a repair operation on a controller in the platform. This function can optionally report repair progress information back to the platform.

## Description

The Driver Health Protocol is optionally produced by a driver that follows the EFI Driver Model. If an EFI Driver needs to report health status to the platform, provide warning or error messages to the user, perform length repair operations, or request the user to make hardware or software configuration changes, then the Driver Health Protocol must be produced.

A controller that is managed by driver that follows the EFI Driver Model and produces the Driver Health Protocol must report the current health of the controllers that the driver is currently managing. The controller can initially be healthy, failed, require repair, or require configuration. If a controller requires configuration, and the user make configuration changes, the controller may then need to be reconnected or the system may need to be rebooted for the configuration changes to take effect. Figure 2-1 below shows all the possible health states of a controller, the set of initial states, the set of terminal states, and the legal transitions between the health states.

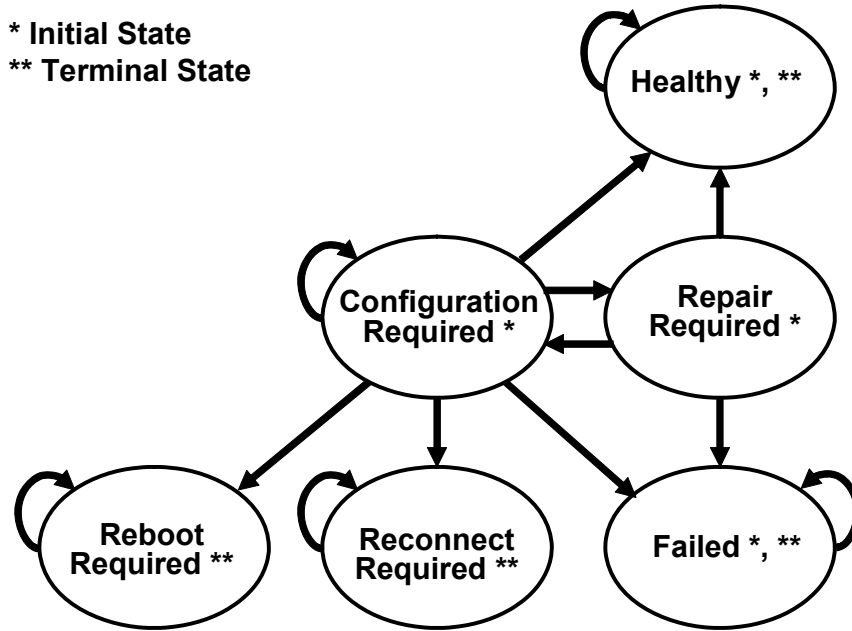

Figure 33. Driver Health Status States

## EFI\_DRIVER\_HEALTH\_PROTOCOL.GetHealthStatus()

### Summary

Retrieves the health status of a controller in the platform. This function can also optionally return warning messages, error messages, and an HII Form that may be used to repair a controller that is not proper configured.

### Prototype

```
typedef
EFI_STATUS
(EFIAPI *EFI_DRIVER_HEALTH_GET_HEALTH_STATUS) (
  IN EFI_DRIVER_HEALTH_PROTOCOL *This,
  IN EFI_HANDLE      ControllerHandle, OPTIONAL
  IN EFI_HANDLE      ChildHandle,  OPTIONAL
  OUT EFI_DRIVER_HEALTH_STATUS *HealthStatus,
  OUT EFI_DRIVER_HEALTH_HII_MESSAGE **MessageList, OPTIONAL
  OUT EFI_HII_HANDLE *FormHiiHandle OPTIONAL
);
```

### Parameters

<i>This</i>	A pointer to the <b>EFI_DRIVER_HEALTH_PROTOCOL</b> instance.
<i>ControllerHandle</i>	The handle of the controller to retrieve the health status on. This is an optional parameter that may be <b>NULL</b> . If this parameter is <b>NULL</b> , then the value of <i>ChildHandle</i> is ignored, and the combined health status of all the devices that the driver is managing is returned.
<i>ChildHandle</i>	The handle of the child controller to retrieve the health status on. This is an optional parameter that may be <b>NULL</b> . It will be <b>NULL</b> for device drivers. It will also be <b>NULL</b> for bus drivers when an attempt is made to collect the health status of the bus controller. It will not be <b>NULL</b> when an attempt is made to collect the health status for a child controller produced by the driver. If <i>ControllerHandle</i> is <b>NULL</b> , then this parameter is ignored.
<i>HealthStatus</i>	A pointer to the health status that is returned by this function. The health status for the controller specified by <i>ControllerHandle</i> and <i>ChildHandle</i> is returned.
<i>MessageList</i>	A pointer to an array of warning or error messages associated with the controller specified by <i>ControllerHandle</i> and <i>ChildHandle</i> . This is an optional parameter that may be <b>NULL</b> . <i>MessageList</i> is allocated by this function with the EFI Boot Service <b>AllocatePool()</b> , and it is the caller's responsibility to free <i>MessageList</i> with the EFI Boot Service <b>FreePool()</b> . Each message is specified by tuple of an <b>EFI_HII_HANDLE</b> and an <b>EFI_STRING_ID</b> . The array of messages is terminated by tuple containing a

**EFI\_HII\_HANDLE** with a value of **NULL**. The **EFI\_HII\_STRING\_PROTOCOL.GetString()** function can be used to retrieve the warning or error message as a Null-terminated string in a specific language. Messages may be returned for any of the *HealthStatus* values except **EfiDriverHealthStatusReconnectRequired** and **EfiDriverHealthStatusRebootRequired**.

*FormHiiHandle*

A pointer to the HII handle containing the HII form used when configuration is required. The HII handle is associated with the controller specified by *ControllerHandle* and *ChildHandle*. If this is **NULL**, then no HII form is available. An HII handle will only be returned with a *HealthStatus* value of **EfiDriverHealthStatusConfigurationRequired**.

**Description**

This function returns the health status associated with the controller specified by *ControllerHandle* and *ChildHandle*. If *ControllerHandle* is not **NULL** and the driver specified by *This* is not currently managing the controller specified by *ControllerHandle* and *ChildHandle*, then **EFI\_UNSUPPORTED** is returned. If *HealthStatus* is **NULL**, then **EFI\_INVALID\_PARAMETER** is returned.

If *ControllerHandle* is **NULL**, then the cumulative health status of all the controllers managed by the EFI driver is returned. If all the controller manages by the driver are healthy, then **EfiDriverHealthStatusHealthy** must be returned in *HealthStatus*. If one or more of the controllers managed by the EFI Driver is not healthy, then **EfiDriverHealthStatusFailed** must be returned.

If *ControllerHandle* is not **NULL** and *ChildHandle* is **NULL**, then the health status of the controller specified by *ControllerHandle* is returned in *HealthStatus* and **EFI\_SUCCESS** is returned.

If *ControllerHandle* is not **NULL** and *ChildHandle* is not **NULL**, then the health status of the child controller specified by *ControllerHandle* and *ChildHandle* is returned in *HealthStatus* and **EFI\_SUCCESS** is returned.

If *MessageList* is **NULL**, then no messages are returned from this function.

If *MessageList* is not **NULL**, and *HealthStatus* is **EfiDriverHealthStatusReconnectRequired** or **EfiDriverHealthStatusRebootRequired** then no messages are returned and *\*MessageList* must be set to **NULL**.

If *MessageList* is not **NULL**, and there are no warning or error messages associated with the controller specified by *ControllerHandle* and *ChildHandle*, then *\*MessageList* must be set to **NULL**.

If *MessageList* is not **NULL**, and there are one or more warning or error messages associated with the controller specified by *ControllerHandle* and *ChildHandle*, then *\*MessageList* must point to a buffer allocated with the EFI Boot Service **AllocatePool()**. The number of **EFI\_DRIVER\_HEALTH\_HII\_MESSAGE** structures allocated in the buffer must be one more than the total number of warning or error messages, and the *HiiHandle* field of the last **EFI\_DRIVER\_HEALTH\_HII\_MESSAGE** structure must be set to **NULL** to



terminate the list of messages. It is the caller's responsibility to free the buffer returned in *\*MessageList* using the EFI Boot Service **FreePool()**. Each message is specified by an **EFI\_HII\_HANDLE** and an **EFI\_STRING\_ID**. The caller may use the **EFI\_HII\_STRING\_PROTOCOL.GetString()** function to convert each message into a Null-terminated string that can may be displayed on a console device.

If *FormHiiHandle* is **NULL**, then no forms are returned from this function.

If *FormHiiHandle* is not **NULL**, and *HealthStatus* is not **EfiDriverHealthStatusConfigurationRequired**, then no forms are returned and *\*FormHiiHandle* must be set to **NULL**.

If *FormHiiHandle* is not **NULL**, and *FormSetGuid* is not **NULL**, and *HealthStatus* is **EfiDriverHealthStatusConfigurationRequired**, then *FormHiiHandle* is assigned to the HII handle which contains the HII form required to perform the configuration operation.

## Related Definitions

```

//*****
// EFI_DRIVER_HEALTH_STATUS
//*****
typedef enum {
  EfiDriverHealthStatusHealthy,
  EfiDriverHealthStatusRepairRequired,
  EfiDriverHealthStatusConfigurationRequired,
  EfiDriverHealthStatusFailed,
  EfiDriverHealthStatusReconnectRequired,
  EfiDriverHealthStatusRebootRequired
} EFI_DRIVER_HEALTH_STATUS;

```

### EfiDriverHealthStatusHealthy

The controller is in a healthy state.

### EfiDriverHealthStatusRepairRequired

The controller requires a repair operation that will take an extended period of time to perform. The EFI Boot Manager is required to call the **Repair()** function when this state is detected. After the **Repair()** function completed, the health status may be **EfiDriverHealthStatusHealthy**, **EfiDriverHealthStatusConfigurationRequired**, or **EfiDriverHealthStatusFailed**.

### EfiDriverHealthStatusConfigurationRequired

The controller requires the user to make software or hardware configuration changes in order to put the controller into a healthy state. The set of software configuration changes are specified by the *FormHiiHandle* and *FormSetGuid* parameters. The EFI Boot Manager may call the **EFI\_FORM\_BROWSER2\_PROTOCOL.SendForm()** function to display configuration information and allow the user to make the required configuration changes. The HII form is the first enabled form in the form set class **EFI\_HII\_DRIVER\_HEALTH\_FORMSET\_GUID**, which is installed on the

returned HII handle *FormHiiHandle*. The *MessageList* parameter may be used to identify additional user configuration operations required to place the controller in a healthy state. After the *FormHiiHandle* and *MessageList* have been processed by the EFI Boot Manager, the health status may be **EfiDriverHealthStatusHealthy**, **EfiDriverHealthStatusConfigurationRequired**, **EfiDriverHealthStatusRepairRequired**, **EfiDriverHealthStatusFailed**, **EfiDriverHealthStatusReconnectRequired**, or **EfiDriverHealthStatusRebootRequired**.

**EfiDriverHealthStatusFailed**

The controller is in a failed state, and there no actions that can place the controller into a healthy state. This controller can not be used as a boot device and no boot devices behind this controller can be used as a boot device.

**EfiDriverHealthStatusReconnectRequired**

A hardware and/or software configuration change was performed by the user, and the controller needs to be reconnected before the controller can be placed in a healthy state. The EFI Boot Manager is required to call the EFI Boot Service **DisconnectController()** followed by the EFI Boot Service **ConnectController()** to reconnect the controller.

**EfiDriverHealthStatusRebootRequired**

A hardware and/or software configuration change was performed by the user, and the controller requires the entire platform to be rebooted before the controller can be placed in a healthy state. The EFI Boot Manager should complete the configuration and repair operations on all the controllers that are not in a healthy state before rebooting the system.

```

//*****
// EFI_DRIVER_HEALTH_HII_MESSAGE
//*****
typedef struct {
    EFI_HII_HANDLE HiiHandle;
    EFI_STRING_ID StringId;
    UINT64 MessageCode;
} EFI_DRIVER_HEALTH_HII_MESSAGE;
    
```

- HiiHandle*                    The **EFI\_HII\_HANDLE** that was returned by **EFI\_HII\_DATABASE\_PROTOCOL.NewPackageList()** when the string pack containing *StringId* was registered with the HII Database.
- StringId*                    The identifier for a single string token in the string pack associated with *HiiHandle*.
- MessageCode*                64-bit numeric value of the warning/error specified by this message. A value of **0x0000000000000000** is used to indicate that *MessageCode* is not specified.

The values **0x0000000000000001** to **0x0fffffffffffffff** are reserved for allocation by the UEFI Specification.

The values **0x1000000000000000** to **0x1fffffffffffffff** are reserved for IHV-developed drivers.

The values **0x8000000000000000** to **0x8fffffffffffffff** is reserved for platform/OEM drivers.

All other values are reserved and should not be used.

## Status Codes Returned

EFI_SUCCESS	The health status of the controller specified by <i>ControllerHandle</i> and <i>ChildHandle</i> was returned in <i>HealthStatus</i> . A list of warning and error messages may be optionally returned in <i>MessageList</i> , and an HII Form may be optionally specified by <i>FormHiHandle</i> .
EFI_UNSUPPORTED	<i>ControllerHandle</i> is not <b>NULL</b> , and the controller specified by <i>ControllerHandle</i> and <i>ChildHandle</i> is not currently being managed by the driver specified by <i>This</i> .
EFI_INVALID_PARAMETER	<i>HealthStatus</i> is <b>NULL</b> .
EFI_OUT_OF_RESOURCES	<i>MessageList</i> is not <b>NULL</b> , and there are not enough resource available to allocate memory for <i>MessageList</i> .

## EFI\_DRIVER\_HEALTH\_PROTOCOL.Repair ()

### Summary

Performs a repair operation on a controller in the platform. This function can optionally report repair progress information back to the platform.

### Prototype

```
typedef
EFI_STATUS
(EFI_API *EFI_DRIVER_HEALTH_REPAIR) (
    IN EFI_DRIVER_HEALTH_PROTOCOL *This,
    IN EFI_HANDLE ControllerHandle,
    IN EFI_HANDLE ChildHandle OPTIONAL,
    IN EFI_DRIVER_HEALTH_REPAIR_NOTIFY RepairNotify OPTIONAL
);
```

### Parameters

<i>This</i>	A pointer to the <b>EFI_DRIVER_HEALTH_PROTOCOL</b> instance.
<i>ControllerHandle</i>	The handle of the controller to repair.
<i>ChildHandle</i>	The handle of the child controller to repair. This is an optional parameter that may be <b>NULL</b> . It will be <b>NULL</b> for device drivers. It will also be <b>NULL</b> for bus drivers when an attempt is made to repair a bus controller. It will not be <b>NULL</b> when an attempt is made to repair a child controller produced by the driver.
<i>RepairNotify</i>	A notification function that may be used by a driver to report the progress of the repair operation. This is an optional parameter that may be <b>NULL</b> .

### Description

This function repairs the controller specified by *ControllerHandle* and *ChildHandle*. If the driver specified by *This* is not currently managing the controller specified by *ControllerHandle* and *ChildHandle*, then **EFI\_UNSUPPORTED** is returned. If there are not enough resource available to complete the repair operation, then **EFI\_OUT\_OF\_RESOURCES** is returned. Otherwise, **EFI\_SUCCESS** is returned. A return value of **EFI\_SUCCESS** does not guarantee that the controller is in a healthy state. The EFI Boot Manager must call the **GetHealthStatus()** function to determine the result of the repair operation.

If *RepairNotify* is not **NULL**, and the repair operation requires an extended period of time to execute, then the driver performing the repair operation may intermittently call the *RepairNotify* function to inform the EFI Boot Manager of the progress of the repair operation. The *RepairNotify* function take two parameters to specify the current progress value and the limit value. These two values may be used by the EFI Boot Manager to present status information for the current repair operation.

### Related Definitions

```

//*****
// EFI_DRIVER_HEALTH_REPAIR_NOTIFY
//*****
typedef
EFI_STATUS
(EFIAPI *EFI_DRIVER_HEALTH_REPAIR_NOTIFY) (
    IN UINTN Value,
    IN UINTN Limit
);
    
```

*Value* A value between 0 and Limit that identifies the current progress of the repair operation.

*Limit* The maximum value of Value for the current repair operation. If Limit is 0, then the completion progress is indeterminate. For example, a driver that wants to specify progress in percent would use a Limit value of 100.

### Status Codes Returned

EFI_SUCCESS	An attempt to repair the controller specified by <i>ControllerHandle</i> and <i>ChildHandle</i> was performed. The result of the repair operation can be determined by calling <b>GetHealthStatus()</b> .
EFI_UNSUPPORTED	The driver specified by This is not currently managing the controller specified by <i>ControllerHandle</i> and <i>ChildHandle</i> .
EFI_OUT_OF_RESOURCES	There are not enough resources to perform the repair operation.

## 11.10.1 UEFI Boot Manager Algorithms

This section contains example algorithms that a UEFI Boot Manager or UEFI Application could use to interact with one or more instances of the EFI Driver Health Protocol present in the platform.

### 11.10.1.1 All Controllers Healthy

This section contains example algorithms that a UEFI Boot Manager or UEFI Application could use to interact with one or more instances of the EFI Driver Health Protocol present in the platform.

The following algorithm collects all the EFI Driver Health Protocols currently present in the EFI Handle Database, and queries each EFI Driver Health Protocol to determine if one or more of the controllers managed by each EFI Driver Health Protocol instance are not healthy. The variable **AllHealthy** is **TRUE** if all the controllers in the platform are healthy. **AllHealthy** is **FALSE** if one or more of the controllers in the platform are not healthy.

```

EFI_STATUS      Status;
UINTN          NoHandles;
EFI_HANDLE     *Handles;
UINTN          Index;
EFI_DRIVER_HEALTH_PROTOCOL *DriverHealth;
BOOLEAN        AllHealthy;

Status = gBS->LocateHandleBuffer (
    ByProtocol,
    &gEfiDriverHealthProtocolGuid,
    NULL,
    &NoHandles,
    &Handles
);
if (EFI_ERROR (Status)) {
    return;
}

AllHealthy = TRUE;
for (Index = 0; Index < NoHandles; Index++) {
    Status = gBS->HandleProtocol (
        Handles[Index],
        &gEfiDriverHealthProtocolGuid,
        (VOID **)&DriverHealth
    );
    if (!EFI_ERROR (Status)) {
        Status = DriverHealth->GetHealthStatus (
            DriverHealth,
            NULL,
            NULL,
            NULL,
            NULL,
            NULL,
            NULL
        );
        if (EFI_ERROR (Status)) {
            AllHealthy = FALSE;
        }
    }
}
}

```

### 11.10.1.2 Process a Controller Until Terminal State Reached

The following algorithm processes a single controller using the EFI Driver Health Protocol associated with that controller. This algorithm continues to query the **GetHealthStatus()** service until one of the legal terminal states of the EFI Driver Health Protocol is reached.

This may require the processing of HII Messages, HII Form, and invocation of repair operations.

```

EFI_STATUS      Status;
EFI_DRIVER_HEALTH_PROTOCOL *DriverHealth;
EFI_HANDLE      ControllerHandle;
EFI_HANDLE      ChildHandle;
EFI_DRIVER_HEALTH_HEALTH_STATUS HealthStatus;
EFI_DRIVER_HEALTH_HII_MESSAGE *MessageList;
EFI_HII_HANDLE  FormHiiHandle;

do {
    HealthStatus = EfiDriverHealthStatusHealthy;
    Status = DriverHealth->GetHealthStatus (
        DriverHealth,
        ControllerHandle,
        ChildHandle,
        &HealthStatus,
        &MessageList,
        &FormHiiHandle
    );
    ProcessMessages (MessageList);
    if (HealthStatus == EfiDriverHealthStatusRepairRequired) {
        Status = DriverHealth->Repair (
            DriverHealth,
            ControllerHandle,
            ChildHandle,
            RepairNotify
        );
    }
    if (HealthStatus == EfiDriverHealthStatusConfigurationRequired) {
        ProcessForm (FormHiiHandle);
    }
} while (HealthStatus == EfiDriverHealthStatusConfigurationRequired ||
    HealthStatus == EfiDriverHealthStatusRepairRequired);
//
// Check for RebootRequired or ReconnectRequired
//

```

### 11.10.1.3 Repair Notification Function

The following is an example repair notification function.

```
VOID
RepairNotify (
    UINTN Value,
    UINTN Limit
)
{
    UINTN Percent;

    if (Limit == 0) {
        Print (L"Repair Progress Undefined\n\r");
    } else {
        Percent = Value * 100 / Limit;
        Print (L"Repair Progress = %3d%%", Percent);
    }
}
```

### 11.10.1.4 Process Message List

The following algorithm processes a set of messages returned by the **GetHealthStatus()** service of the EFI Driver Health Protocol.



```

EFI_STATUS      Status;
EFI_DRIVER_HEALTH_HII_MESSAGE *MessageList;
UINTN          MessageIndex;
EFI_HII_STRING_PROTOCOL *HiiString;
EFI_STRING     MessageString[200];

for (MessageIndex = 0;
     MessageList[MessageIndex].HiiHandle != 0;
     MessageIndex++) {
    MessageLength = sizeof (MessageString);
    Status = HiiString->GetString (
        HiiString,
        NULL,
        MessageList[MessageIndex].HiiHandle,
        MessageList[MessageIndex].StringId,
        MessageString
        &MessageLength,
        NULL
    );
    if (!EFI_ERROR (Status)) {
        // Log or Print or Display MessageString
    }
}

```

### 11.10.1.5 Process HII Form

The following algorithm processes an HII Form returned by the **GetHealthStatus()** service of the EFI Driver Health Protocol.

```

EFI_STATUS      Status;
EFI_FORM_BROWSER2_PROTOCOL *FormBrowser;
EFI_HII_HANDLE  FormHiiHandle;

```

```

Status = FormBrowser->SendForm (
    FormBrowser,
    &FormHiiHandle,
    1,
    &gEfiHiiDriverHealthFormsetGuid,
    ,
    0,
    NULL,
    NULL
);

```

## 11.10.2 UEFI Driver Algorithms

A UEFI Driver that supports the EFI Driver Health Protocol will typically make the following changes:

### 11.10.2.1 Driver Entry Point Updates

Install Driver Health Protocol on the driver image handle.

Register HII String/IFR packs with the HII Database

- HII String/IFR packs can also be carried in a PE/COFF image extension eliminating the need for the driver to perform the registration
- The HII String and HII Forms may be produced dynamically when the GetHealthStatus() service is called.

### 11.10.2.2 Add global variable

Add global variable to track combined health status of all controllers managed by the driver. The variable is TRUE if all the controllers managed by the driver are healthy. The variable is FALSE if one or more controllers managed by the drover are not healthy.

### 11.10.2.3 Update private context structure

Update private context structure to track health status of each controller managed by the driver. This may also include the current set of HII Strings and HII Forms associated with the controllers that are not healthy.

### 11.10.2.4 Implement GetHealthStatus() service

Implement GetHealthStatus() service of the EFI Driver Health Protocol

- Make sure only legal state transitions are implemented

- Evaluate configuration data and repair status
- Return HII Strings for message(s) associated with the current state
- If configuration required, return HII Form to be processed

#### 11.10.2.5 Implement Repair() service

Implement Repair() service of the EFI Driver Health Protocol

- Calling Repair Notification callback is optional, but recommended.
- Update health status in private context structure before returning
- Make sure only legal state transitions are implemented

### 11.11 EFI Adapter Information Protocol

This section provides a detailed description of the **EFI\_ADAPTER\_INFORMATION\_PROTOCOL**. The EFI Adapter Information Protocol is used to dynamically and quickly discover or set device information for an adapter. The discovery of information and state of an adapter should be quick and only return dynamic information. The information should never be cached or stale. The setting information for the adapter should also be fast and simple. The only information that should be set is operating state information, like setting a speed. This protocol is meant to be light weight and non-blocking.

## EFI\_ADAPTER\_INFORMATION\_PROTOCOL

### SUMMARY

Since this protocol will return and set information for the adapter, the adapter device driver must publish the **EFI\_ADAPTER\_INFORMATION\_PROTOCOL**.

There are many kinds of adapters. The set and get adapter information functions should be used to determine the current state of the adapter, or to set a state for an adapter, like device speed.

## GUID

```
#define EFI_ADAPTER_INFORMATION_PROTOCOL_GUID \
{ 0xE5DD1403, 0xD622, 0xC24E, \
  { 0x84, 0x88, 0xC7, 0x1B, 0x17, 0xF5, 0xE8, 0x02 } }
```

## Protocol Interface Structure

```
typedef struct _EFI_ADAPTER_INFORMATION_PROTOCOL {
  EFI_ADAPTER_INFO_GET_INFO    GetInformation;
  EFI_ADAPTER_INFO_SET_INFO    SetInformation;
  EFI_ADAPTER_INFO_GET_SUPPORTED_TYPES GetSupportedTypes;
} EFI_ADAPTER_INFORMATION_PROTOCOL;
```

## Parameters

<i>GetInformation</i>	Gets device state information from adapter. See <b>GetInformation()</b> for more function description.
<i>SetInformation</i>	Sets device information for adapter. See <b>SetInformation()</b> for more function description.
<i>GetSupportedTypes</i>	Gets a list of supported information types for this instance of the protocol.

## Description

The **EFI\_ADAPTER\_INFORMATION\_PROTOCOL** is used to get or set the state for an adapter.

## EFI\_ADAPTER\_INFORMATION\_PROTOCOL. EFI\_ADAPTER\_GET\_INFO()

### Summary

Returns the current state information for the adapter.

### Prototype

```
typedef
EFI_STATUS
(EFIAPI *EFI_ADAPTER_INFO_GET_INFO) (
    IN EFI_ADAPTER_INFORMATION_PROTOCOL *This,
    IN EFI_GUID          *InformationType,
    OUT VOID             **InformationBlock,
    OUT UINTN           *InformationBlockSize
);
```

### Parameters

<i>This</i>	A pointer to the <b>EFI_ADAPTER_INFORMATION_PROTOCOL</b> instance.
<i>InformationType</i>	A pointer to an <b>EFI_GUID</b> that defines the contents of <i>InformationBlock</i> . The caller must use the <i>InformationType</i> to specify the information it needs to retrieve from this service and to determine how to parse the <i>InformationBlock</i> . The driver should not attempt to free <i>InformationType</i> .
<i>InformationBlock</i>	This service returns a pointer to the buffer with the <i>InformationBlock</i> structure which contains details about the data specific to <i>InformationType</i> . This structure is defined based on the type of data returned, and will be different for different data types. This service and caller decode this structure and its contents based on <i>InformationType</i> . This buffer is allocated by this service, and it is the responsibility of the caller to free it after using it.
<i>InformationBlockSize</i>	The driver returns the size of the <i>InformationBlock</i> in bytes.

### Description

The **GetInformation()** function returns information of type *InformationType* from the adapter. If an adapter does not support the requested informational type, then **EFI\_UNSUPPORTED** is returned.

### Status Codes Returned

EFI_SUCCESS	The <i>InformationType</i> information was retrieved.
EFI_UNSUPPORTED	The <i>InformationType</i> is not known.

EFI_DEVICE_ERROR	The device reported an error.
EFI_OUT_OF_RESOURCES	The request could not be completed due to a lack of resources
EFI_INVALID_PARAMETER	<i>This</i> is <b>NULL</b>
EFI_INVALID_PARAMETER	<i>InformationBlock</i> is <b>NULL</b>
EFI_INVALID_PARAMETER	<i>InformationBlockSize</i> is <b>NULL</b>

## EFI\_ADAPTER\_INFORMATION\_PROTOCOL. EFI\_ADAPTER\_INFO\_SET\_INFO()

### Summary

Sets state information for an adapter.

### Prototype

```
typedef
EFI_STATUS
(EFIAPI *EFI_ADAPTER_INFO_SET_INFO) (
  IN EFI_ADAPTER_INFORMATION_PROTOCOL *This,
  IN EFI_GUID          *InformationType,
  IN VOID              *InformationBlock,
  IN UINTN             InformationBlockSize
);
```

### Parameters

<i>This</i>	A pointer to the <b>EFI_ADAPTER_INFORMATION_PROTOCOL</b> instance.
<i>InformationType</i>	A pointer to an <b>EFI_GUID</b> that defines the contents of <i>InformationBlock</i> . The caller must use the <i>InformationType</i> to specify the information it wants the service.
<i>InformationBlock</i>	A pointer to the <i>InformationBlock</i> structure which contains details about the data specific to <i>InformationType</i> . This structure is defined based on the type of data sent, and will be different for different data types. The driver and caller decode this structure and its contents based on <i>InformationType</i> . This buffer is allocated by the caller. It is the responsibility of the caller to free it after the caller has set the requested parameters.
<i>InformationBlockSize</i>	The size of the <i>InformationBlock</i> in bytes.

### Description

The **SetInformation()** function sends information of type *InformationType* for an adapter. If an adapter does not support the requested informational type, then **EFI\_UNSUPPORTED** is returned.

### Related Definitions

### Status Codes Returned

EFI_SUCCESS	The information was received and interpreted successfully.
EFI_UNSUPPORTED	The <i>InformationType</i> is not known.
EFI_DEVICE_ERROR	The device reported an error.

EFI_INVALID_PARAMETER	<i>This is NULL</i>
EFI_INVALID_PARAMETER	<i>InformationBlock is NULL</i>
EFI_WRITE_PROTECTED	The <i>InformationType</i> cannot be modified using <b>EFI_ADAPTER_INFO_SET_INFO()</b>



## EFI\_ADAPTER\_INFORMATION\_PROTOCOL. EFI\_ADAPTER\_INFO\_GET\_SUPPORTED\_TYPES()

### Summary

Get a list of supported information types for this instance of the protocol.

### Prototype

```
typedef
EFI_STATUS
(EFIAPI *EFI_ADAPTER_INFO_GET_SUPPORTED_TYPES) (
    IN EFI_ADAPTER_INFORMATION_PROTOCOL *This,
    OUT EFI_GUID          **InfoTypesBuffer,
    OUT UINTN             *InfoTypesBufferCount
);
```

### Parameters

<i>This</i>	A pointer to the <b>EFI_ADAPTER_INFORMATION_PROTOCOL</b> instance.
<i>InfoTypesBuffer</i>	A pointer to the array of <i>InformationType</i> GUIDs that are supported by <i>This</i> . This buffer is allocated by this service, and it is the responsibility of the caller to free it after using it
<i>InfoTypesBufferCount</i>	A pointer to the number of GUIDs present in <i>InfoTypesBuffer</i> .

### Description

The **GetSupportedTypes()** function returns a list of *InformationType* GUIDs that are supported on an adapter with this instance of **EFI\_ADAPTER\_INFORMATION\_PROTOCOL**. The list is returned in *InfoTypesBuffer*, and the number of GUID pointers in *InfoTypesBuffer* is returned in *InfoTypesBufferCount*.

## Status Codes Returned

EFI_SUCCESS	The list of information type GUIDs that are supported on this adapter was returned in <i>InfoTypesBuffer</i> . The number of information type GUIDs was returned in <i>InfoTypesBufferCount</i> .
EFI_INVALID_PARAMETER	<i>This is NULL</i>
EFI_INVALID_PARAMETER	<i>InfoTypesBuffer is NULL</i>
EFI_INVALID_PARAMETER	<i>InfoTypesBufferCount is NULL</i>
EFI_OUT_OF_RESOURCES	There is not enough pool memory to store the results

## 11.12 EFI Adapter Information Protocol Information Types

**Note:** In addition to the information block types defined in this section, driver writers may define additional information type blocks for their own use provided all such blocks are each identified by a unique GUID created by the definer.

Clients of the protocol should ignore any unrecognized block types returned by **GetSupportedTypes()**.

### 11.12.1 Network Media State

For network adapters, the **EFI\_ADAPTER\_INFORMATION\_PROTOCOL** must be installed on the same handle as the UEFI protocol. If SNP or MNP protocol, instead of the UEFI protocol, is installed on adapter handle, then the **EFI\_ADAPTER\_INFORMATION\_PROTOCOL** must be installed on the same handle as the SNP or MNP protocol.

#### InformationType

```
#define EFI_ADAPTER_INFO_MEDIA_STATE_GUID \
{0xD7C74207, 0xA831, 0x4A26 \
{0xB1,0xF5,0xD1,0x93,0x06,0x5C,0xE8,0xB6}}
```

Corresponding *InformationBlock*:

```
typedef struct {
    EFI_STATUS MediaState;
} EFI_ADAPTER_INFO_MEDIA_STATE;
```

*MediaState*

Returns the current media state status. *MediaState* can have any of the following values:

**EFI\_SUCCESS:** There is media attached to the network adapter.

**EFI\_NOT\_READY:** This detects a bounced state. There was media attached to the network adapter, but it was removed and is trying to attach to the network adapter again. If re-attached, the status will be updated to **EFI\_SUCCESS** later.

**EFI\_NO\_MEDIA:** There is not any media attached to the network adapter.

## 11.12.2 Network Boot

For iSCSI and FCoE HBA adapters, the **EFI\_ADAPTER\_INFORMATION\_PROTOCOL** must be installed on the same handle as the **EFI\_EXT\_SCSI\_PASS\_THRU\_PROTOCOL**.

### InformationType

```
#define EFI_ADAPTER_INFO_NETWORK_BOOT_GUID \
  {0x1FBD2960, 0x4130, 0x41E5, \
   {0x94,0xAC,0xD2, 0xCF, 0x03, 0x7F, 0xB3, 0x7C}}
```

Corresponding *InformationBlock*:

```
typedef struct {
  BOOLEAN      iScsilpv4BootCapablity;
  BOOLEAN      iScsilpv6BootCapablity;
  BOOLEAN      FCoeBootCapablity;
  BOOLEAN      OffloadCapability;
  BOOLEAN      iScsiMpioCapability
  BOOLEAN      iScsilpv4Boot;
  BOOLEAN      iScsilpv6Boot;
  BOOLEAN      FCoeBoot;
} EFI_ADAPTER_INFO_NETWORK_BOOT;
```

*iScsilpv4BootCapablity*

TRUE if the adapter supports booting from iSCSI IPv4 targets.

*iScsilpv6BootCapablity*

TRUE if the adapter supports booting from iSCSI IPv6 targets.

*FCoeBootCapablity*

TRUE if the adapter supports booting from FCoE targets.

*OffloadCapability*

TRUE if the adapter supports an offload engine (such as TCP Offload Engine (TOE) for its iSCSI or FCoE boot operations.

*iScsiMpioCapability*

TRUE if the adapter supports multipath I/O (MPIO) for its iSCSI boot operations.

*iScsilpv4Boot*

TRUE if the adapter is currently configured to boot from iSCSI IPv4 targets.

*iScsilpv6Boot*

TRUE if the adapter is currently configured to boot from iSCSI IPv6 targets.

*FCoeBoot* TRUE if the adapter is currently configured to boot from FCoE targets.

**Note:** *The adapter should set the **iScsilpv4BootCapability**, **iScsilpv6BootCapability**, or **FCoeBootCapability** fields to TRUE if it supports that boot capability, even if that capability is currently disabled or not configured.*

### 11.12.3 SAN MAC Address

#### SUMMARY

Since this instance of a data blocks for a **EFI\_ADAPTER\_INFORMATION\_PROTOCOL** support additional information for ascertaining the SAN MAC address for an FCOE-aware network interface controller. Details on the **Get()** method.

#### SAN MAC Address - Get

**Note:** *An instance of the **EFI\_ADAPTER\_INFORMATION\_PROTOCOL** supporting this GUID must be installed on the same handle as the NII protocol.*

#### SAN MAC address information

*InformationType*

```
#define EFI_ADAPTER_INFO_SAN_MAC_ADDRESS_GUID \
{0x114da5ef, 0x2cf1, 0x4e12, \
{0x9b, 0xbb, 0xc4, 0x70, 0xb5, 0x52, 0x05, 0xd9}}
```

Corresponding *InformationBlock*:

```
typedef struct {
    EFI_MAC_ADDRESS SanMacAddress;
} EFI_ADAPTER_INFO_SAN_MAC_ADDRESS;
```

*SanMacAddress* Returns the SAN MAC address for the adapter.

For adapters that support today's 802.3 ethernet networking and Fibre-Channel Over Ethernet (FCOE), this conveys the FCOE SAN MAC address from the adapter

### 11.12.4 IPV6 Support from UNDI

For network adapters, the **EFI\_ADAPTER\_INFORMATION\_PROTOCOL** must be installed on the same handle as the UNDI protocol.

- *Ipv6Support* returns capability of UNDI to support IPV6 traffic.
- *Ipv6Support* can have any of the following values:
  - TRUE*: The UNDI supports IPV6.
  - FALSE*: This UNDI does not support IPV6 traffic.

**InformationType**

```
#define EFI_ADAPTER_INFO_UNDI_IPV6_SUPPORT_GUID \
{ 0x4bd56be3, 0x4975, 0x4d8a, \
{ 0xa0, 0xad, 0xc4, 0x91, 0x20, 0x4b, 0x5d, 0x4d}}
```

**Corresponding *InformationBlock*:**

```
typedef struct {
    BOOLEAN Ipv6Support;
} EFI_ADAPTER_INFO_UNDI_IPV6_SUPPORT;
```

**11.12.5 Network Media Type**

For network adapters, the `EFI_ADAPTER_INFORMATION_PROTOCOL` must be installed on the same handle as the UNDI protocol. If SNP or MNP protocol, instead of the UNDI protocol, is installed on adapter handle, then the `EFI_ADAPTER_INFORMATION_PROTOCOL` must be installed on the same handle as the SNP or MNP protocol.

**Information Type**

```
#define EFI_ADAPTER_INFO_MEDIA_TYPE_GUID \
{ 0x8484472f, 0x71ec, 0x411a, \
{ 0xb3, 0x9c, 0x62, 0xcd, 0x94, 0xd9, 0x91, 0x6e }}
```

**Corresponding *InformationBlock*:**

```
typedef struct {
    UINT8 MediaType;
} EFI_ADAPTER_INFO_MEDIA_TYPE;
```

**MediaType** indicates the current media type, and can have any of the following values:

- 1: Ethernet Network Adapter
- 2: Ethernet Wireless Network Adapter
- 3~255: Reserved



## 12 Protocols — Console Support

---

This section explores console support protocols, including Simple Text Input, Simple Text Output, Simple Pointer, Serial IO, and Graphics Output protocols.

### 12.1 Console I/O Protocol

This section defines the Console I/O protocol. This protocol is used to handle input and output of text-based information intended for the system user during the operation of code in the boot services environment. Also included here are the definitions of three console devices: one for input and one each for normal output and errors.

These interfaces are specified by function call definitions to allow maximum flexibility in implementation. For example, there is no requirement for compliant systems to have a keyboard or screen directly connected to the system. Implementations may choose to direct information passed using these interfaces in arbitrary ways provided that the semantics of the functions are preserved (in other words, provided that the information is passed to and from the system user).

#### 12.1.1 Overview

The UEFI console is built out of the [EFI\\_SIMPLE\\_TEXT\\_INPUT\\_PROTOCOL](#) and the [EFI\\_SIMPLE\\_TEXT\\_OUTPUT\\_PROTOCOL](#). These two protocols implement a basic text-based console that allows platform firmware, applications written to this specification, and UEFI OS loaders to present information to and receive input from a system administrator. The UEFI console supported 16-bit Unicode character codes, a simple set of input control characters (Scan Codes), and a set of output-oriented programmatic interfaces that give functionality equivalent to an intelligent terminal. The console does not support pointing devices on input or bitmaps on output.

This specification requires that the [EFI\\_SIMPLE\\_TEXT\\_INPUT\\_PROTOCOL](#) support the same languages as the corresponding [EFI\\_SIMPLE\\_TEXT\\_OUTPUT\\_PROTOCOL](#). The [EFI\\_SIMPLE\\_TEXT\\_OUTPUT\\_PROTOCOL](#) is recommended to support at least the printable Basic Latin Unicode character set to enable standard terminal emulation software to be used with an EFI console. The Basic Latin Unicode character set implements a superset of ASCII that has been extended to 16-bit characters. Any number of other Unicode character sets may be optionally supported.

#### 12.1.2 ConsoleIn Definition

The [EFI\\_SIMPLE\\_TEXT\\_INPUT\\_PROTOCOL](#) defines an input stream that contains Unicode characters and required EFI scan codes. Only the control characters defined in [Table 100](#) have meaning in the Unicode input or output streams. The control characters are defined to be characters U+0000 through U+001F. The input stream does not support any software flow control.

**Table 100. Supported Unicode Control Characters**

Mnemonic	Unicode	Description
Null	U+0000	Null character ignored when received.
BS	U+0008	Backspace. Moves cursor left one column. If the cursor is at the left margin, no action is taken.
TAB	U+0x0009	Tab.
LF	U+000A	Linefeed. Moves cursor to the next line.
CR	U+000D	Carriage Return. Moves cursor to left margin of the current line.

The input stream supports Scan Codes in addition to Unicode characters. If the Scan Code is set to 0x00 then the Unicode character is valid and should be used. If the Scan Code is set to a non-0x00 value it represents a special key as defined by [Table 101](#).

**Table 101. EFI Scan Codes for `EFI_SIMPLE_TEXT_INPUT_PROTOCOL`**

EFI Scan Code	Description
0x00	Null scan code.
0x01	Move cursor up 1 row.
0x02	Move cursor down 1 row.
0x03	Move cursor right 1 column.
0x04	Move cursor left 1 column.
0x05	Home.
0x06	End.
0x07	Insert.
0x08	Delete.
0x09	Page Up.
0x0a	Page Down.
0x0b	Function 1.
0x0c	Function 2.
0x0d	Function 3.
0x0e	Function 4.
0x0f	Function 5.
0x10	Function 6.
0x11	Function 7.
0x12	Function 8.
0x13	Function 9.
0x14	Function 10.
0x17	Escape.



Table 102. EFI Scan Codes for **EFI\_SIMPLE\_TEXT\_INPUT\_EX\_PROTOCOL**

EFI Scan Code	Description
0x15	Function 11
0x16	Function 12
0x68	Function 13
0x69	Function 14
0x6A	Function 15
0x6B	Function 16
0x6C	Function 17
0x6D	Function 18
0x6E	Function 19
0x6F	Function 20
0x70	Function 21
0x71	Function 22
0x72	Function 23
0x73	Function 24
0x7F	Mute
0x80	Volume Up
0x81	Volume Down
0x100	Brightness Up
0x101	Brightness Down
0x102	Suspend
0x103	Hibernate
0x104	Toggle Display
0x105	Recovery
0x106	Eject
0x8000-0xFFFF	OEM Reserved

## 12.2 Simple Text Input Ex Protocol

The Simple Text Input Ex protocol defines an extension to the Simple Text Input protocol which enables various new capabilities described in this section.

## EFI\_SIMPLE\_TEXT\_INPUT\_EX\_PROTOCOL

### Summary

This protocol is used to obtain input from the *ConsoleIn* device. The EFI specification requires that the **EFI\_SIMPLE\_TEXT\_INPUT\_PROTOCOL** supports the same languages as the corresponding **EFI\_SIMPLE\_TEXT\_OUTPUT\_PROTOCOL**.

### GUID

```
#define EFI_SIMPLE_TEXT_INPUT_EX_PROTOCOL_GUID \
{0xdd9e7534, 0x7762, 0x4698, \
 0x8c, 0x14, 0xf5, 0x85, 0x17, 0xa6, 0x25, 0xaa}
```

### Protocol Interface Structure

```
typedef struct _EFI_SIMPLE_TEXT_INPUT_EX_PROTOCOL{
  EFI_INPUT_RESET_EX           Reset;
  EFI_INPUT_READ_KEY_EX        ReadKeyStrokeEx;
  EFI_EVENT                    WaitForKeyEx;
  EFI_SET_STATE                SetState;
  EFI_REGISTER_KEYSTROKE_NOTIFY RegisterKeyNotify;
  EFI_UNREGISTER_KEYSTROKE_NOTIFY UnregisterKeyNotify;
} EFI_SIMPLE_TEXT_INPUT_EX_PROTOCOL;
```

### Parameters

<i>Reset</i>	Reset the <i>ConsoleIn</i> device. See <b>Reset()</b> .
<i>ReadKeyStrokeEx</i>	Returns the next input character. See <i>ReadKeyStrokeEx()</i> .
<i>WaitForKeyEx</i>	Event to use with <i>WaitForEvent()</i> to wait for a key to be available. An Event will only be triggered if <i>KeyData.Key</i> has information contained within it.
<i>SetState</i>	Set the <b>EFI_KEY_TOGGLE_STATE</b> state settings for the input device.
<i>RegisterKeyNotify</i>	Register a notification function to be called when a given key sequence is hit.
<i>UnregisterKeyNotify</i>	Removes a specific notification function.

### Description

The **EFI\_SIMPLE\_TEXT\_INPUT\_EX\_PROTOCOL** is used on the *ConsoleIn* device. It is an extension to the Simple Text Input protocol which allows a variety of extended shift state information to be returned.

## EFI\_SIMPLE\_TEXT\_INPUT\_EX\_PROTOCOL.Reset()

### Summary

Resets the input device hardware.

### Prototype

```
typedef
EFI_STATUS
(EFIAPI *EFI_INPUT_RESET_EX) (
    IN EFI_SIMPLE_TEXT_INPUT_EX_PROTOCOL *This,
    IN BOOLEAN ExtendedVerification
);
```

### Parameters

*This*

A pointer to the **EFI\_SIMPLE\_TEXT\_INPUT\_EX\_PROTOCOL** instance. Type **EFI\_SIMPLE\_TEXT\_INPUT\_EX\_PROTOCOL** is defined in this section.

*ExtendedVerification*

Indicates that the driver may perform a more exhaustive verification operation of the device during reset.

### Description

The **Reset()** function resets the input device hardware.

The implementation of Reset is required to clear the contents of any input queues resident in memory used for buffering keystroke data and put the input stream in a known empty state.

As part of initialization process, the firmware/device will make a quick but reasonable attempt to verify that the device is functioning. If the *ExtendedVerification* flag is **TRUE** the firmware may take an extended amount of time to verify the device is operating on reset. Otherwise the reset operation is to occur as quickly as possible.

The hardware verification process is not defined by this specification and is left up to the platform firmware or driver to implement.

### Status Codes Returned

EFI_SUCCESS	The device was reset.
EFI_DEVICE_ERROR	The device is not functioning correctly and could not be reset.

## EFI\_SIMPLE\_TEXT\_INPUT\_EX\_PROTOCOL.ReadKeyStrokeEx()

### Summary

Reads the next keystroke from the input device.

#### Prototype

```
typedef
EFI_STATUS
(EFI_API *EFI_INPUT_READ_KEY_EX) (
    IN EFI_SIMPLE_TEXT_INPUT_EX_PROTOCOL *This,
    OUT EFI_KEY_DATA *KeyData
);
```

### Parameters

- This* A pointer to the **EFI\_SIMPLE\_TEXT\_INPUT\_EX\_PROTOCOL** instance. Type **EFI\_SIMPLE\_TEXT\_INPUT\_EX\_PROTOCOL** is defined in this section.
- KeyData* A pointer to a buffer that is filled in with the keystroke state data for the key that was pressed. Type **EFI\_KEY\_DATA** is defined in "Related Definitions" below.

### Related Definitions

```
//*****
// EFI_KEY_DATA
//*****
typedef struct {
    EFI_INPUT_KEY Key;
    EFI_KEY_STATE KeyState;
} EFI_KEY_DATA
```

- Key* The EFI scan code and Unicode value returned from the input device.
- KeyState* The current state of various toggled attributes as well as input modifier values.

```

//*****
// EFI_KEY_STATE
//*****
//
// Any Shift or Toggle State that is valid should have
// high order bit set.
//
typedef struct EFI_KEY_STATE {
    UINT32      KeyShiftState;
    EFI_KEY_TOGGLE_STATE KeyToggleState;
} EFI_KEY_STATE;

```

*KeyShiftState*                      Reflects the currently pressed shift modifiers for the input device. The returned value is valid only if the high order bit has been set.

*KeyToggleState*                    Reflects the current internal state of various toggled attributes. The returned value is valid only if the high order bit has been set.

```

#define EFI_SHIFT_STATE_VALID          0x80000000
#define EFI_RIGHT_SHIFT_PRESSED       0x00000001
#define EFI_LEFT_SHIFT_PRESSED        0x00000002
#define EFI_RIGHT_CONTROL_PRESSED     0x00000004
#define EFI_LEFT_CONTROL_PRESSED      0x00000008
#define EFI_RIGHT_ALT_PRESSED         0x00000010
#define EFI_LEFT_ALT_PRESSED          0x00000020
#define EFI_RIGHT_LOGO_PRESSED        0x00000040
#define EFI_LEFT_LOGO_PRESSED         0x00000080
#define EFI_MENU_KEY_PRESSED          0x00000100
#define EFI_SYS_REQ_PRESSED           0x00000200

```

```

//*****
// EFI_KEY_TOGGLE_STATE
//*****
typedef UINT8      EFI_KEY_TOGGLE_STATE;

```

```

#define EFI_TOGGLE_STATE_VALID        0x80
#define EFI_KEY_STATE_EXPOSED        0x40
#define EFI_SCROLL_LOCK_ACTIVE       0x01
#define EFI_NUM_LOCK_ACTIVE          0x02
#define EFI_CAPS_LOCK_ACTIVE         0x04

```

## Description

The **ReadKeyStrokeEx()** function reads the next keystroke from the input device. If there is no pending keystroke the function returns **EFI\_NOT\_READY**. If there is a pending keystroke, then *KeyData.Key.ScanCode* is the EFI scan code defined in [Table 101](#). The

*KeyData.Key.UnicodeChar* is the actual printable character or is zero if the key does not represent a printable character (control key, function key, etc.). The *KeyData.KeyState* is the modifier shift state for the character reflected in *KeyData.Key.UnicodeChar* or *KeyData.Key.ScanCode*. This function mirrors the behavior of **ReadKeyStroke**( in the Simple Input Protocol in that a keystroke will only be returned when *KeyData.Key* has data within it.

When interpreting the data from this function, it should be noted that if a class of printable characters that are normally adjusted by shift modifiers (e.g. Shift Key + "f" key) would be presented solely as a *KeyData.Key.UnicodeChar* without the associated shift state. So in the previous example of a Shift Key + "f" key being pressed, the only pertinent data returned would be *KeyData.Key.UnicodeChar* with the value of "F". This of course would not typically be the case for non-printable characters such as the pressing of the Right Shift Key + F10 key since the corresponding returned data would be reflected both in the *KeyData.KeyState.KeyShiftState* and *KeyData.Key.ScanCode* values.

UEFI drivers which implement the **EFI\_SIMPLE\_TEXT\_INPUT\_EX** protocol are required to return *KeyData.Key* and *KeyData.KeyState* values. These drivers must always return the most current state of *KeyData.KeyState.KeyShiftState* and *KeyData.KeyState.KeyToggleState*. It should also be noted that certain input devices may not be able to produce shift or toggle state information, and in those cases the high order bit in the respective Toggle and Shift state fields should not be active.

If the **EFI\_KEY\_STATE\_EXPOSED** bit is turned on, then this instance of the **EFI\_SIMPLE\_INPUT\_EX\_PROTOCOL** supports the ability to return partial keystrokes. With **EFI\_KEY\_STATE\_EXPOSED** bit enabled, the **ReadKeyStrokeEx** function will allow the return of incomplete keystrokes such as the holding down of certain keys which are expressed as a part of *KeyState* when there is no *Key* data.

### Status Codes Returned

EFI_SUCCESS	The keystroke information was returned.
EFI_NOT_READY	There was no keystroke data available.
EFI_DEVICE_ERROR	The keystroke information was not returned due to hardware errors.

## EFI\_SIMPLE\_TEXT\_INPUT\_EX\_PROTOCOL.SetState()

### Summary

Set certain state for the input device.

### Prototype

```
typedef
    EFI_STATUS
    (EFIAPI *EFI_SET_STATE) (
        IN EFI_SIMPLE_TEXT_INPUT_EX_PROTOCOL *This,
        IN EFI_KEY_TOGGLE_STATE *KeyToggleState
    );
```

### Parameters

*This*

A pointer to the **EFI\_SIMPLE\_TEXT\_INPUT\_EX\_PROTOCOL** instance. Type **EFI\_SIMPLE\_TEXT\_INPUT\_EX\_PROTOCOL** is defined in this section.

*KeyToggleState*

Pointer to the **EFI\_KEY\_TOGGLE\_STATE** to set the state for the input device. Type **EFI\_KEY\_TOGGLE\_STATE** is defined in "Related Definitions" for **EFI\_SIMPLE\_TEXT\_INPUT\_EX\_PROTOCOL.ReadKeyStrokeEx()**, above.

The SetState() function allows the input device hardware to have state settings adjusted. By calling the SetState() function with the **EFI\_KEY\_STATE\_EXPOSED** bit active in the *KeyToggleState* parameter, this will enable the **ReadKeyStrokeEx** function to return incomplete keystrokes such as the holding down of certain keys which are expressed as a part of KeyState when there is no Key data.

### Status Codes Returned

EFI_SUCCESS	The device state was set appropriately.
EFI_DEVICE_ERROR	The device is not functioning correctly and could not have the setting adjusted.
EFI_UNSUPPORTED	The device does not support the ability to have its state set or the requested state change was not supported.

## EFI\_SIMPLE\_TEXT\_INPUT\_EX\_PROTOCOL.RegisterKeyNotify()

### Summary

Register a notification function for a particular keystroke for the input device.

### Prototype

```
typedef
EFI_STATUS
(EFI_API *EFI_REGISTER_KEYSTROKE_NOTIFY) (
    IN EFI_SIMPLE_TEXT_INPUT_EX_PROTOCOL *This,
    IN EFI_KEY_DATA *KeyData,
    IN EFI_KEY_NOTIFY_FUNCTION KeyNotificationFunction,
    OUT VOID **NotifyHandle
);
```

### Parameters

<i>This</i>	A pointer to the <b>EFI_SIMPLE_TEXT_INPUT_EX_PROTOCOL</b> instance. Type <b>EFI_SIMPLE_TEXT_INPUT_EX_PROTOCOL</b> is defined in this section.
<i>KeyData</i>	A pointer to a buffer that is filled in with the keystroke information for the key that was pressed. If <i>KeyData.Key</i> , <i>KeyData.KeyState.KeyToggleState</i> and <i>KeyData.KeyState.KeyShiftState</i> are 0, then any incomplete keystroke will trigger a notification of the <i>KeyNotificationFunction</i> .
<i>KeyNotificationFunction</i>	Points to the function to be called when the key sequence is typed specified by <i>KeyData</i> . This notification function should be called at <= <b>TPL_CALLBACK</b> . See <b>EFI_KEY_NOTIFY_FUNCTION</b> below.
<i>NotifyHandle</i>	Points to the unique handle assigned to the registered notification.

### Description

The **RegisterKeystrokeNotify()** function registers a function which will be called when a specified keystroke will occur. The keystroke being specified can be for any combination of *KeyData.Key* or *KeyData.KeyState* information.



### Related Definitions

```

//*****
// EFI_KEY_NOTIFY
//*****
typedef
EFI_STATUS
(EFIAPI *EFI_KEY_NOTIFY_FUNCTION) (
    IN EFI_KEY_DATA                *KeyData
);
    
```

### Status Codes Returned

EFI_SUCCESS	Key notify was registered successfully.
EFI_OUT_OF_RESOURCES	Unable to allocate necessary data structures.

## EFI\_SIMPLE\_TEXT\_INPUT\_EX\_PROTOCOL.UnregisterKeyNotify()

### Summary

Remove the notification that was previously registered.

### Prototype

```
typedef
EFI_STATUS
(EFI_API *EFI_UNREGISTER_KEYSTROKE_NOTIFY) (
    IN EFI_SIMPLE_TEXT_INPUT_EX_PROTOCOL *This,
    IN VOID          *NotificationHandle
);
```

### Parameters

<i>This</i>	A pointer to the <b>EFI_SIMPLE_TEXT_INPUT_EX_PROTOCOL</b> instance. Type <b>EFI_SIMPLE_TEXT_INPUT_EX_PROTOCOL</b> is defined in this section.
<i>NotificationHandle</i>	The handle of the notification function being unregistered.

### Description

The **UnregisterKeystrokeNotify()** function removes the notification which was previously registered.

### Status Codes Returned

EFI_SUCCESS	Key notify was unregistered successfully.
EFI_INVALID_PARAMETER	The NotificationHandle is invalid.

## 12.3 Simple Text Input Protocol

The Simple Text Input protocol defines the minimum input required to support the *ConsoleIn* device.

### EFI\_SIMPLE\_TEXT\_INPUT\_PROTOCOL

#### Summary

This protocol is used to obtain input from the *ConsoleIn* device. The EFI specification requires that the **EFI\_SIMPLE\_TEXT\_INPUT\_PROTOCOL** supports the same languages as the corresponding [EFI\\_SIMPLE\\_TEXT\\_OUTPUT\\_PROTOCOL](#).

## GUID

```
#define EFI_SIMPLE_TEXT_INPUT_PROTOCOL_GUID \
{0x387477c1,0x69c7,0x11d2,\
 {0x8e,0x39,0x00,0xa0,0xc9,0x69,0x72,0x3b}}
```

## Protocol Interface Structure

```
typedef struct _EFI_SIMPLE_TEXT_INPUT_PROTOCOL {
  EFI_INPUT_RESET  Reset;
  EFI_INPUT_READ_KEY  ReadKeyStroke;
  EFI_EVENT  WaitForKey;
} EFI_SIMPLE_TEXT_INPUT_PROTOCOL;
```

## Parameters

<i>Reset</i>	Reset the <i>ConsoleIn</i> device. See <a href="#">Reset()</a> .
<i>ReadKeyStroke</i>	Returns the next input character. See <a href="#">ReadKeyStroke()</a> .
<i>WaitForKey</i>	Event to use with <a href="#">EFI_BOOT_SERVICES.WaitForEvent()</a> to wait for a key to be available.

## Description

The **EFI\_SIMPLE\_TEXT\_INPUT\_PROTOCOL** is used on the *ConsoleIn* device. It is the minimum required protocol for *ConsoleIn*.

## EFI\_SIMPLE\_TEXT\_INPUT\_PROTOCOL.Reset()

### Summary

Resets the input device hardware.

### Prototype

```
typedef
EFI_STATUS
(EFI_API *EFI_INPUT_RESET) (
    IN EFI_SIMPLE_TEXT_INPUT_PROTOCOL *This,
    IN BOOLEAN ExtendedVerification
);
```

### Parameters

*This*

A pointer to the [EFI\\_SIMPLE\\_TEXT\\_INPUT\\_PROTOCOL](#) instance. Type [EFI\\_SIMPLE\\_TEXT\\_INPUT\\_PROTOCOL](#) is defined in [Section 12.3](#)

*ExtendedVerification*

Indicates that the driver may perform a more exhaustive verification operation of the device during reset.

### Description

The **Reset()** function resets the input device hardware.

The implementation of Reset is required to clear the contents of any input queues resident in memory used for buffering keystroke data and put the input stream in a known empty state.

As part of initialization process, the firmware/device will make a quick but reasonable attempt to verify that the device is functioning. If the *ExtendedVerification* flag is **TRUE** the firmware may take an extended amount of time to verify the device is operating on reset. Otherwise the reset operation is to occur as quickly as possible.

The hardware verification process is not defined by this specification and is left up to the platform firmware or driver to implement.

### Status Codes Returned

EFI_SUCCESS	The device was reset.
EFI_DEVICE_ERROR	The device is not functioning correctly and could not be reset.

## EFI\_SIMPLE\_TEXT\_INPUT\_PROTOCOL.ReadKeyStroke()

### Summary

Reads the next keystroke from the input device.

### Prototype

```
typedef
EFI_STATUS
(EFIAPI *EFI_INPUT_READ_KEY) (
    IN EFI_SIMPLE_TEXT_INPUT_PROTOCOL *This,
    OUT EFI_INPUT_KEY      *Key
);
```

### Parameters

- This*                      A pointer to the [EFI SIMPLE TEXT INPUT PROTOCOL](#) instance. Type [EFI\\_SIMPLE\\_TEXT\\_INPUT\\_PROTOCOL](#) is defined in [Section 12.3](#).
- Key*                        A pointer to a buffer that is filled in with the keystroke information for the key that was pressed. Type [EFI\\_INPUT\\_KEY](#) is defined in "Related Definitions" below.

### Related Definitions

```
/**
//*****
// EFI_INPUT_KEY
//*****
typedef struct {
    UINT16  ScanCode;
    CHAR16  UnicodeChar;
} EFI_INPUT_KEY;
```

### Description

The **ReadKeyStroke()** function reads the next keystroke from the input device. If there is no pending keystroke the function returns **EFI\_NOT\_READY**. If there is a pending keystroke, then *ScanCode* is the EFI scan code defined in [Table 101](#). The *UnicodeChar* is the actual printable character or is zero if the key does not represent a printable character (control key, function key, etc.).

### Status Codes Returned

EFI_SUCCESS	The keystroke information was returned.
EFI_NOT_READY	There was no keystroke data available.
EFI_DEVICE_ERROR	The keystroke information was not returned due to hardware errors.

## 12.3.1 ConsoleOut or StandardError

The **EFI\_SIMPLE\_TEXT\_OUTPUT\_PROTOCOL** must implement the same Unicode code pages as the **EFI\_SIMPLE\_TEXT\_INPUT\_PROTOCOL**. The protocol must also support the

Unicode control characters defined in [Table 100](#). The **EFI\_SIMPLE\_TEXT\_OUTPUT\_PROTOCOL** supports special manipulation of the screen by programmatic methods and therefore does not support the EFI scan codes defined in [Table 101](#).

## 12.4 Simple Text Output Protocol

The Simple Text Output protocol defines the minimum requirements for a text-based *ConsoleOut* device. The EFI specification requires that the **EFI\_SIMPLE\_TEXT\_INPUT\_PROTOCOL** support the same languages as the corresponding **EFI\_SIMPLE\_TEXT\_OUTPUT\_PROTOCOL**.

### EFI\_SIMPLE\_TEXT\_OUTPUT\_PROTOCOL

#### Summary

This protocol is used to control text-based output devices.

#### GUID

```
#define EFI_SIMPLE_TEXT_OUTPUT_PROTOCOL_GUID \
  {0x387477c2,0x69c7,0x11d2,\
   {0x8e,0x39,0x00,0xa0,0xc9,0x69,0x72,0x3b}}
```

#### Protocol Interface Structure

```
typedef struct _EFI_SIMPLE_TEXT_OUTPUT_PROTOCOL {
  EFI_TEXT_RESET      Reset;
  EFI_TEXT_STRING     OutputString;
  EFI_TEXT_TEST_STRING TestString;
  EFI_TEXT_QUERY_MODE QueryMode;
  EFI_TEXT_SET_MODE   SetMode;
  EFI_TEXT_SET_ATTRIBUTE SetAttribute;
  EFI_TEXT_CLEAR_SCREEN ClearScreen;
  EFI_TEXT_SET_CURSOR_POSITION SetCursorPosition;
  EFI_TEXT_ENABLE_CURSOR EnableCursor;
  SIMPLE_TEXT_OUTPUT_MODE *Mode;
} EFI_SIMPLE_TEXT_OUTPUT_PROTOCOL;
```

#### Parameters

<i>Reset</i>	Reset the <i>ConsoleOut</i> device. See <a href="#">Reset()</a> .
<i>OutputString</i>	Displays the string on the device at the current cursor location. See <a href="#">OutputString()</a> .
<i>TestString</i>	Tests to see if the <i>ConsoleOut</i> device supports this string. See <a href="#">TestString()</a> .
<i>QueryMode</i>	Queries information concerning the output device's supported text mode. See <a href="#">QueryMode()</a> .

<i>SetMode</i>	Sets the current mode of the output device. See <a href="#">SetMode()</a> .
<i>SetAttribute</i>	Sets the foreground and background color of the text that is output. See <a href="#">SetAttribute()</a> .
<i>ClearScreen</i>	Clears the screen with the currently set background color. See <a href="#">ClearScreen()</a> .
<i>SetCursorPosition</i>	Sets the current cursor position. See <a href="#">SetCursorPosition()</a> .
<i>EnableCursor</i>	Turns the visibility of the cursor on/off. See <a href="#">EnableCursor()</a> .
<i>Mode</i>	Pointer to <a href="#">SIMPLE_TEXT_OUTPUT_MODE</a> data. Type <b>SIMPLE_TEXT_OUTPUT_MODE</b> is defined in “Related Definitions” below.

The following data values in the **SIMPLE\_TEXT\_OUTPUT\_MODE** interface are read-only and are changed by using the appropriate interface functions:

<i>MaxMode</i>	The number of modes supported by <a href="#">QueryMode()</a> and <a href="#">SetMode()</a> .
<i>Mode</i>	The text mode of the output device(s).
<i>Attribute</i>	The current character output attribute.
<i>CursorColumn</i>	The cursor’s column.
<i>CursorRow</i>	The cursor’s row.
<i>CursorVisible</i>	The cursor is currently visible or not.

## Related Definitions

```

//*****
// SIMPLE_TEXT_OUTPUT_MODE
//*****
typedef struct {
    INT32      MaxMode;
    // current settings
    INT32      Mode;
    INT32      Attribute;
    INT32      CursorColumn;
    INT32      CursorRow;
    BOOLEAN    CursorVisible;
} SIMPLE_TEXT_OUTPUT_MODE;

```

## Description

The **SIMPLE\_TEXT\_OUTPUT** protocol is used to control text-based output devices. It is the minimum required protocol for any handle supplied as the *ConsoleOut* or *StandardError* device. In addition, the minimum supported text mode of such devices is at least 80 x 25 characters.

A video device that only supports graphics mode is required to emulate text mode functionality. Output strings themselves are not allowed to contain any control codes

other than those defined in [Table 100](#). Positional cursor placement is done only via the [SetCursorPosition\(\)](#) function. It is highly recommended that text output to the *StandardError* device be limited to sequential string outputs. (That is, it is not recommended to use [ClearScreen\(\)](#) or [SetCursorPosition\(\)](#) on output messages to *StandardError*.)

If the output device is not in a valid text mode at the time of the [EFI\\_BOOT\\_SERVICES.HandleProtocol\(\)](#) call, the device is to indicate that its *CurrentMode* is -1. On connecting to the output device the caller is required to verify the mode of the output device, and if it is not acceptable to set it to something it can use.



## EFI\_SIMPLE\_TEXT\_OUTPUT\_PROTOCOL.Reset()

### Summary

Resets the text output device hardware.

### Prototype

```
typedef
EFI_STATUS
(EFIAPI *EFI_TEXT_RESET) (
    IN EFI_SIMPLE_TEXT_OUTPUT_PROTOCOL *This,
    IN BOOLEAN ExtendedVerification
);
```

### Parameters

*This*

A pointer to the [EFI SIMPLE TEXT OUTPUT PROTOCOL](#) instance. Type [EFI\\_SIMPLE\\_TEXT\\_OUTPUT\\_PROTOCOL](#) is defined in the “Related Definitions” of [Section 12.4](#).

*ExtendedVerification*

Indicates that the driver may perform a more exhaustive verification operation of the device during reset.

### Description

The **Reset()** function resets the text output device hardware. The cursor position is set to (0, 0), and the screen is cleared to the default background color for the output device.

As part of initialization process, the firmware/device will make a quick but reasonable attempt to verify that the device is functioning. If the *ExtendedVerification* flag is **TRUE** the firmware may take an extended amount of time to verify the device is operating on reset. Otherwise the reset operation is to occur as quickly as possible.

The hardware verification process is not defined by this specification and is left up to the platform firmware or driver to implement.

### Status Codes Returned

EFI_SUCCESS	The text output device was reset.
EFI_DEVICE_ERROR	The text output device is not functioning correctly and could not be reset.

## EFI\_SIMPLE\_TEXT\_OUTPUT\_PROTOCOL.OutputString()

### Summary

Writes a string to the output device.

### Prototype

```
typedef
EFI_STATUS
(EFI_API *EFI_TEXT_STRING) (
    IN EFI_SIMPLE_TEXT_OUTPUT_PROTOCOL *This,
    IN CHAR16 *String
);
```

### Parameters

*This*

A pointer to the [EFI SIMPLE TEXT OUTPUT PROTOCOL](#) instance. Type [EFI\\_SIMPLE\\_TEXT\\_OUTPUT\\_PROTOCOL](#) is defined in the “Related Definitions” of [Section 12.4](#).

*String*

The Null-terminated string to be displayed on the output device(s). All output devices must also support the Unicode drawing character codes defined in “Related Definitions.”

## Related Definitions

```

//*****
// UNICODE DRAWING CHARACTERS
//*****

#define BOXDRAW_HORIZONTAL      0x2500
#define BOXDRAW_VERTICAL       0x2502
#define BOXDRAW_DOWN_RIGHT     0x250c
#define BOXDRAW_DOWN_LEFT      0x2510
#define BOXDRAW_UP_RIGHT       0x2514
#define BOXDRAW_UP_LEFT        0x2518
#define BOXDRAW_VERTICAL_RIGHT  0x251c
#define BOXDRAW_VERTICAL_LEFT  0x2524
#define BOXDRAW_DOWN_HORIZONTAL 0x252c
#define BOXDRAW_UP_HORIZONTAL   0x2534
#define BOXDRAW_VERTICAL_HORIZONTAL 0x253c

#define BOXDRAW_DOUBLE_HORIZONTAL 0x2550
#define BOXDRAW_DOUBLE_VERTICAL   0x2551
#define BOXDRAW_DOWN_RIGHT_DOUBLE 0x2552
#define BOXDRAW_DOWN_DOUBLE_RIGHT 0x2553
#define BOXDRAW_DOUBLE_DOWN_RIGHT 0x2554
#define BOXDRAW_DOWN_LEFT_DOUBLE  0x2555
#define BOXDRAW_DOWN_DOUBLE_LEFT   0x2556
#define BOXDRAW_DOUBLE_DOWN_LEFT   0x2557

#define BOXDRAW_UP_RIGHT_DOUBLE    0x2558
#define BOXDRAW_UP_DOUBLE_RIGHT    0x2559
#define BOXDRAW_DOUBLE_UP_RIGHT    0x255a

#define BOXDRAW_UP_LEFT_DOUBLE     0x255b
#define BOXDRAW_UP_DOUBLE_LEFT     0x255c
#define BOXDRAW_DOUBLE_UP_LEFT     0x255d

#define BOXDRAW_VERTICAL_RIGHT_DOUBLE 0x255e
#define BOXDRAW_VERTICAL_DOUBLE_RIGHT 0x255f
#define BOXDRAW_DOUBLE_VERTICAL_RIGHT 0x2560

#define BOXDRAW_VERTICAL_LEFT_DOUBLE 0x2561
#define BOXDRAW_VERTICAL_DOUBLE_LEFT 0x2562
#define BOXDRAW_DOUBLE_VERTICAL_LEFT 0x2563

#define BOXDRAW_DOWN_HORIZONTAL_DOUBLE 0x2564
#define BOXDRAW_DOWN_DOUBLE_HORIZONTAL 0x2565
#define BOXDRAW_DOUBLE_DOWN_HORIZONTAL 0x2566

```

```

#define BOXDRAW_UP_HORIZONTAL_DOUBLE 0x2567
#define BOXDRAW_UP_DOUBLE_HORIZONTAL 0x2568
#define BOXDRAW_DOUBLE_UP_HORIZONTAL 0x2569

#define BOXDRAW_VERTICAL_HORIZONTAL_DOUBLE 0x256a
#define BOXDRAW_VERTICAL_DOUBLE_HORIZONTAL 0x256b
#define BOXDRAW_DOUBLE_VERTICAL_HORIZONTAL 0x256c

//*****
// EFI Required Block Elements Code Chart
//*****

#define BLOCKELEMENT_FULL_BLOCK 0x2588
#define BLOCKELEMENT_LIGHT_SHADE 0x2591

//*****
// EFI Required Geometric Shapes Code Chart
//*****

#define GEOMETRICSHAPE_UP_TRIANGLE 0x25b2
#define GEOMETRICSHAPE_RIGHT_TRIANGLE 0x25ba
#define GEOMETRICSHAPE_DOWN_TRIANGLE 0x25bc
#define GEOMETRICSHAPE_LEFT_TRIANGLE 0x25c4

//*****
// EFI Required Arrow shapes
//*****

#define ARROW_UP 0x2191
#define ARROW_DOWN 0x2193

```

## Description

The [OutputString\(\)](#) function writes a string to the output device. This is the most basic output mechanism on an output device. The *String* is displayed at the current cursor location on the output device(s) and the cursor is advanced according to the rules listed in [Table 103](#).

**Table 103. EFI Cursor Location/Advance Rules**

Mnemonic	Unicode	Description
Null	U+0000	Ignore the character, and do not move the cursor.
BS	U+0008	If the cursor is not at the left edge of the display, then move the cursor left one column.
LF	U+000A	If the cursor is at the bottom of the display, then scroll the display one row, and do not update the cursor position. Otherwise, move the cursor down one row.
CR	U+000D	Move the cursor to the beginning of the current row.
Other	U+XXXX	Print the character at the current cursor position and move the cursor right one column. If this moves the cursor past the right edge of the display, then the line should wrap to the beginning of the next line. This is equivalent to inserting a CR and an LF. Note that if the cursor is at the bottom of the display, and the line wraps, then the display will be scrolled one line.

**Note:** *If desired, the system's NVRAM environment variables may be used at install time to determine the configured locale of the system or the installation procedure can query the user for the proper language support. This is then used to either install the proper EFI image/loader or to configure the installed image's strings to use the proper text for the selected locale.*

### Status Codes Returned

EFI_SUCCESS	The string was output to the device.
EFI_DEVICE_ERROR	The device reported an error while attempting to output the text.
EFI_UNSUPPORTED	The output device's mode is not currently in a defined text mode.
EFI_WARN_UNKNOWN_GLYPH	This warning code indicates that some of the characters in the string could not be rendered and were skipped.

## EFI\_SIMPLE\_TEXT\_OUTPUT\_PROTOCOL.TestString()

### Summary

Verifies that all characters in a string can be output to the target device.

### Prototype

```
typedef
EFI_STATUS
(EFI_API *EFI_TEXT_TEST_STRING) (
    IN EFI_SIMPLE_TEXT_OUTPUT_PROTOCOL *This,
    IN CHAR16 *String
);
```

### Parameters

<i>This</i>	A pointer to the <a href="#">EFI SIMPLE TEXT OUTPUT PROTOCOL</a> instance. Type <a href="#">EFI_SIMPLE_TEXT_OUTPUT_PROTOCOL</a> is defined in the “Related Definitions” of <a href="#">Section 12.4</a> .
<i>String</i>	The Null-terminated string to be examined for the output device(s).

### Description

The **TestString()** function verifies that all characters in a string can be output to the target device.

This function provides a way to know if the desired character codes are supported for rendering on the output device(s). This allows the installation procedure (or EFI image) to at least select character codes that the output devices are capable of displaying. Since the output device(s) may be changed between boots, if the loader cannot adapt to such changes it is recommended that the loader call [OutputString\(\)](#) with the text it has and ignore any “unsupported” error codes. Devices that are capable of displaying the Unicode character codes will do so.

### Status Codes Returned

EFI_SUCCESS	The device(s) are capable of rendering the output string.
EFI_UNSUPPORTED	Some of the characters in the string cannot be rendered by one or more of the output devices mapped by the EFI handle.

## EFI\_SIMPLE\_TEXT\_OUTPUT\_PROTOCOL.QueryMode()

### Summary

Returns information for an available text mode that the output device(s) supports.

### Prototype

```
typedef
EFI_STATUS
(EFI_API *EFI_TEXT_QUERY_MODE) (
  IN EFI_SIMPLE_TEXT_OUTPUT_PROTOCOL *This,
  IN UINTN      ModeNumber,
  OUT UINTN     *Columns,
  OUT UINTN     *Rows
);
```

### Parameters

<i>This</i>	A pointer to the <a href="#">EFI_SIMPLE_TEXT_OUTPUT_PROTOCOL</a> instance. Type <a href="#">EFI_SIMPLE_TEXT_OUTPUT_PROTOCOL</a> is defined in the "Related Definitions" of <a href="#">Section 12.4</a> .
<i>ModeNumber</i>	The mode number to return information on.
<i>Columns, Rows</i>	Returns the geometry of the text output device for the request <i>ModeNumber</i> .

### Description

The **QueryMode()** function returns information for an available text mode that the output device(s) supports.

It is required that all output devices support at least 80x25 text mode. This mode is defined to be mode 0. If the output devices support 80x50, that is defined to be mode 1. All other text dimensions supported by the device will follow as modes 2 and above. If an output device supports modes 2 and above, but does not support 80x50, then querying for mode 1 will return **EFI\_UNSUPPORTED**.

### Status Codes Returned

EFI_SUCCESS	The requested mode information was returned.
EFI_DEVICE_ERROR	The device had an error and could not complete the request.
EFI_UNSUPPORTED	The mode number was not valid.

## EFI\_SIMPLE\_TEXT\_OUTPUT\_PROTOCOL.SetMode()

### Summary

Sets the output device(s) to a specified mode.

### Prototype

```
typedef
EFI_STATUS
(* EFI_API EFI_TEXT_SET_MODE) (
    IN EFI_SIMPLE_TEXT_OUTPUT_PROTOCOL *This,
    IN UINTN ModeNumber
);
```

### Parameters

*This*

A pointer to the [EFI SIMPLE TEXT OUTPUT PROTOCOL](#) instance. Type [EFI\\_SIMPLE\\_TEXT\\_OUTPUT\\_PROTOCOL](#) is defined in the “Related Definitions” of [Section 12.4](#).

*ModeNumber*

The text mode to set.

### Description

The **SetMode()** function sets the output device(s) to the requested mode. On success the device is in the geometry for the requested mode, and the device has been cleared to the current background color with the cursor at (0,0).

### Status Codes Returned

EFI_SUCCESS	The requested text mode was set.
EFI_DEVICE_ERROR	The device had an error and could not complete the request.
EFI_UNSUPPORTED	The mode number was not valid.



## EFI\_SIMPLE\_TEXT\_OUTPUT\_PROTOCOL.SetAttribute()

### Summary

Sets the background and foreground colors for the [OutputString\(\)](#) and [ClearScreen\(\)](#) functions.

### Prototype

```
typedef
EFI_STATUS
(EFI_API *EFI_TEXT_SET_ATTRIBUTE) (
    IN EFI_SIMPLE_TEXT_OUTPUT_PROTOCOL *This,
    IN UINTN Attribute
);
```

### Parameters

*This*

A pointer to the [EFI\\_SIMPLE\\_TEXT\\_OUTPUT\\_PROTOCOL](#) instance. Type [EFI\\_SIMPLE\\_TEXT\\_OUTPUT\\_PROTOCOL](#) is defined in the “Related Definitions” of [Section 12.4](#).

*Attribute*

The attribute to set. Bits 0..3 are the foreground color, and bits 4..6 are the background color. All other bits are reserved. See “Related Definitions” below.

### Related Definitions

```

//*****
// Attributes
//*****
#define EFI_BLACK      0x00
#define EFI_BLUE      0x01
#define EFI_GREEN     0x02
#define EFI_CYAN      0x03
#define EFI_RED       0x04
#define EFI_MAGENTA   0x05
#define EFI_BROWN     0x06
#define EFI_LIGHTGRAY 0x07
#define EFI_BRIGHT    0x08
#define EFI_DARKGRAY(EFI_BLACK | EFI_BRIGHT) 0x08
#define EFI_LIGHTBLUE 0x09
#define EFI_LIGHTGREEN 0x0A
#define EFI_LIGHTCYAN 0x0B
#define EFI_LIGHTRED   0x0C
#define EFI_LIGHTMAGENTA 0x0D
#define EFI_YELLOW     0x0E
#define EFI_WHITE      0x0F

#define EFI_BACKGROUND_BLACK 0x00
#define EFI_BACKGROUND_BLUE  0x10
#define EFI_BACKGROUND_GREEN 0x20
#define EFI_BACKGROUND_CYAN  0x30
#define EFI_BACKGROUND_RED    0x40
#define EFI_BACKGROUND_MAGENTA 0x50
#define EFI_BACKGROUND_BROWN  0x60
#define EFI_BACKGROUND_LIGHTGRAY 0x70
//
// Macro to accept color values in their raw form to create
// a value that represents both a foreground and background
// color in a single byte.
// For Foreground, and EFI_* value is valid from EFI_BLACK(0x00)
// to EFI_WHITE (0x0F).
// For Background, only EFI_BLACK, EFI_BLUE, EFI_GREEN,
// EFI_CYAN, EFI_RED, EFI_MAGENTA, EFI_BROWN, and EFI_LIGHTGRAY
// are acceptable.
//
// Do not use EFI_BACKGROUND_xxx values with this macro.
// #define EFI_TEXT_ATTR(Foreground,Background) \
((Foreground) | ((Background) << 4))

```

## Description

The [SetAttribute\(\)](#) function sets the background and foreground colors for the [OutputString\(\)](#) and [ClearScreen\(\)](#) functions.

The color mask can be set even when the device is in an invalid text mode.

Devices supporting a different number of text colors are required to emulate the above colors to the best of the device's capabilities.

### Status Codes Returned

EFI_SUCCESS	The requested attributes were set.
EFI_DEVICE_ERROR	The device had an error and could not complete the request.

## EFI\_SIMPLE\_TEXT\_OUTPUT\_PROTOCOL.ClearScreen()

### Summary

Clears the output device(s) display to the currently selected background color.

### Prototype

```
typedef
EFI_STATUS
(EFI_API *EFI_TEXT_CLEAR_SCREEN) (
    IN EFI_SIMPLE_TEXT_OUTPUT_PROTOCOL *This
);
```

### Parameters

*This*

A pointer to the [EFI\\_SIMPLE\\_TEXT\\_OUTPUT\\_PROTOCOL](#) instance. Type [EFI\\_SIMPLE\\_TEXT\\_OUTPUT\\_PROTOCOL](#) is defined in the “Related Definitions” of [Section 12.4](#).

### Description

The **ClearScreen()** function clears the output device(s) display to the currently selected background color. The cursor position is set to (0, 0).

### Status Codes Returned

EFI_SUCCESS	The operation completed successfully.
EFI_DEVICE_ERROR	The device had an error and could not complete the request.
EFI_UNSUPPORTED	The output device is not in a valid text mode.

## EFI\_SIMPLE\_TEXT\_OUTPUT\_PROTOCOL.SetCursorPosition()

### Summary

Sets the current coordinates of the cursor position.

### Prototype

```
typedef
EFI_STATUS
(EFIAPI *EFI_TEXT_SET_CURSOR_POSITION) (
  IN EFI_SIMPLE_TEXT_OUTPUT_PROTOCOL *This,
  IN UINTN      Column,
  IN UINTN      Row
);
```

### Parameters

*This*

A pointer to the [EFI\\_SIMPLE\\_TEXT\\_OUTPUT\\_PROTOCOL](#) instance. Type [EFI\\_SIMPLE\\_TEXT\\_OUTPUT\\_PROTOCOL](#) is defined in the “Related Definitions” of [Section 12.4](#).

*Column, Row*

The position to set the cursor to. Must be greater than or equal to zero and less than the number of columns and rows returned by [QueryMode\(\)](#).

### Description

The [SetCursorPosition\(\)](#) function sets the current coordinates of the cursor position. The upper left corner of the screen is defined as coordinate (0, 0).

### Status Codes Returned

EFI_SUCCESS	The operation completed successfully.
EFI_DEVICE_ERROR	The device had an error and could not complete the request.
EFI_UNSUPPORTED	The output device is not in a valid text mode, or the cursor position is invalid for the current mode.

## EFI\_SIMPLE\_TEXT\_OUTPUT\_PROTOCOL.EnableCursor()

### Summary

Makes the cursor visible or invisible.

### Prototype

```
typedef
EFI_STATUS
(EFIAPI *EFI_TEXT_ENABLE_CURSOR) (
    IN EFI_SIMPLE_TEXT_OUTPUT_PROTOCOL *This,
    IN BOOLEAN Visible
);
```

### Parameters

*This*

A pointer to the [EFI SIMPLE TEXT OUTPUT PROTOCOL](#) instance. Type [EFI\\_SIMPLE\\_TEXT\\_OUTPUT\\_PROTOCOL](#) is defined in the “Related Definitions” of [Section 12.4](#).

*Visible*

If **TRUE**, the cursor is set to be visible. If **FALSE**, the cursor is set to be invisible.

### Description

The **EnableCursor()** function makes the cursor visible or invisible.

### Status Codes Returned

EFI_SUCCESS	The operation completed successfully.
EFI_DEVICE_ERROR	The device had an error and could not complete the request or the device does not support changing the cursor mode.
EFI_UNSUPPORTED	The output device does not support visibility control of the cursor.

## 12.5 Simple Pointer Protocol

This section defines the Simple Pointer Protocol and a detailed description of the [EFI\\_SIMPLE\\_POINTER\\_PROTOCOL](#). The intent of this section is to specify a simple method for accessing pointer devices. This would include devices such as mice and trackballs.

The [EFI\\_SIMPLE\\_POINTER\\_PROTOCOL](#) allows information about a pointer device to be retrieved. This would include the status of buttons and the motion of the pointer device since the last time it was accessed. This protocol is attached the device handle of a pointer device, and can be used for input from the user in the preboot environment.

## EFI\_SIMPLE\_POINTER\_PROTOCOL

### Summary

Provides services that allow information about a pointer device to be retrieved.

## GUID

```
#define EFI_SIMPLE_POINTER_PROTOCOL_GUID \
  {0x31878c87,0xb75,0x11d5,\
   {0x9a,0x4f,0x00,0x90,0x27,0x3f,0xc1,0x4d}}
```

## Protocol Interface Structure

```
typedef struct _EFI_SIMPLE_POINTER_PROTOCOL {
  EFI_SIMPLE_POINTER_RESET  Reset;
  EFI_SIMPLE_POINTER_GET_STATE  GetState;
  EFI_EVENT                 WaitForInput;
  EFI_SIMPLE_INPUT_MODE     *Mode;
} EFI_SIMPLE_POINTER_PROTOCOL;
```

## Parameters

<i>Reset</i>	Resets the pointer device. See the <a href="#">Reset()</a> function description.
<i>GetState</i>	Retrieves the current state of the pointer device. See the <a href="#">GetState()</a> function description.
<i>WaitForInput</i>	Event to use with <a href="#">EFI_BOOT_SERVICES.WaitForEvent()</a> to wait for input from the pointer device.
<i>Mode</i>	Pointer to <a href="#">EFI_SIMPLE_POINTER_MODE</a> data. The type <a href="#">EFI_SIMPLE_POINTER_MODE</a> is defined in “Related Definitions” below.

## Related Definitions

```
/**
//*****
// EFI_SIMPLE_POINTER_MODE
//*****
typedef struct {
  UINT64  ResolutionX;
  UINT64  ResolutionY;
  UINT64  ResolutionZ;
  BOOLEAN LeftButton;
  BOOLEAN RightButton;
} EFI_SIMPLE_POINTER_MODE;
```

The following data values in the [EFI\\_SIMPLE\\_POINTER\\_MODE](#) interface are read-only and are changed by using the appropriate interface functions:

<i>ResolutionX</i>	The resolution of the pointer device on the x-axis in counts/mm. If 0, then the pointer device does not support an x-axis.
<i>ResolutionY</i>	The resolution of the pointer device on the y-axis in counts/mm. If 0, then the pointer device does not support a y-axis.

<i>ResolutionZ</i>	The resolution of the pointer device on the z-axis in counts/mm. If 0, then the pointer device does not support a z-axis.
<i>LeftButton</i>	<b>TRUE</b> if a left button is present on the pointer device. Otherwise <b>FALSE</b> .
<i>RightButton</i>	<b>TRUE</b> if a right button is present on the pointer device. Otherwise <b>FALSE</b> .

## Description

The **EFI\_SIMPLE\_POINTER\_PROTOCOL** provides a set of services for a pointer device that can be used as an input device from an application written to this specification. The services include the ability to reset the pointer device, retrieve the state of the pointer device, and retrieve the capabilities of the pointer device.



## EFI\_SIMPLE\_POINTER\_PROTOCOL.Reset()

### Summary

Resets the pointer device hardware.

### Prototype

```
typedef
EFI_STATUS
(EFIAPI *EFI_SIMPLE_POINTER_RESET) (
    IN EFI_SIMPLE_POINTER_PROTOCOL *This,
    IN BOOLEAN ExtendedVerification
);
```

### Parameters

*This*

A pointer to the **EFI\_SIMPLE\_POINTER\_PROTOCOL** instance. Type **EFI\_SIMPLE\_POINTER\_PROTOCOL** is defined in [Section 12.5](#).

*ExtendedVerification*

Indicates that the driver may perform a more exhaustive verification operation of the device during reset.

### Description

This **Reset()** function resets the pointer device hardware.

As part of initialization process, the firmware/device will make a quick but reasonable attempt to verify that the device is functioning. If the *ExtendedVerification* flag is **TRUE** the firmware may take an extended amount of time to verify the device is operating on reset. Otherwise the reset operation is to occur as quickly as possible.

The hardware verification process is not defined by this specification and is left up to the platform firmware or driver to implement.

### Status Codes Returned

EFI_SUCCESS	The device was reset.
EFI_DEVICE_ERROR	The device is not functioning correctly and could not be reset.

## EFI\_SIMPLE\_POINTER\_PROTOCOL.GetState()

### Summary

Retrieves the current state of a pointer device.

### Prototype

```
typedef
EFI_STATUS
(EFIAPI *EFI_SIMPLE_POINTER_GET_STATE)
IN EFI_SIMPLE_POINTER_PROTOCOL *This,
IN OUT EFI_SIMPLE_POINTER_STATE *State
);
```

### Parameters

<i>This</i>	A pointer to the <b>EFI_SIMPLE_POINTER_PROTOCOL</b> instance. Type <b>EFI_SIMPLE_POINTER_PROTOCOL</b> is defined in <a href="#">Section 12.5</a> .
<i>State</i>	A pointer to the state information on the pointer device. Type <b>EFI_SIMPLE_POINTER_STATE</b> is defined in “Related Definitions” below.

### Related Definitions

```
/**
//*****
// EFI_SIMPLE_POINTER_STATE
//*****
typedef struct {
  INT32   RelativeMovementX;
  INT32   RelativeMovementY;
  INT32   RelativeMovementZ;
  BOOLEAN LeftButton;
  BOOLEAN RightButton;
} EFI_SIMPLE_POINTER_STATE;
```

<i>RelativeMovementX</i>	The signed distance in counts that the pointer device has been moved along the x-axis. The actual distance moved is <i>RelativeMovementX</i> / <i>ResolutionX</i> millimeters. If the <i>ResolutionX</i> field of the <a href="#">EFI_SIMPLE_POINTER_MODE</a> structure is 0, then this pointer device does not support an x-axis, and this field must be ignored.
--------------------------	--

<i>RelativeMovementY</i>	The signed distance in counts that the pointer device has been moved along the y-axis. The actual distance moved is <i>RelativeMovementY</i> / <i>ResolutionY</i> millimeters. If the <i>ResolutionY</i> field of the <a href="#">EFI_SIMPLE_POINTER_MODE</a> structure is 0, then this pointer device does not support a y-axis, and this field must be ignored.
--------------------------	---

<i>RelativeMovementZ</i>	The signed distance in counts that the pointer device has been moved along the z-axis. The actual distance moved is <i>RelativeMovementZ</i> / <i>ResolutionZ</i> millimeters. If the <i>ResolutionZ</i> field of the <b>EFI_SIMPLE_POINTER_MODE</b> structure is 0, then this pointer device does not support a z-axis, and this field must be ignored.
<i>LeftButton</i>	If <b>TRUE</b> , then the left button of the pointer device is being pressed. If <b>FALSE</b> , then the left button of the pointer device is not being pressed. If the <i>LeftButton</i> field of the <b>EFI_SIMPLE_POINTER_MODE</b> structure is <b>FALSE</b> , then this field is not valid, and must be ignored.
<i>RightButton</i>	If <b>TRUE</b> , then the right button of the pointer device is being pressed. If <b>FALSE</b> , then the right button of the pointer device is not being pressed. If the <i>RightButton</i> field of the <b>EFI_SIMPLE_POINTER_MODE</b> structure is <b>FALSE</b> , then this field is not valid, and must be ignored.

## Description

The **GetState()** function retrieves the current state of a pointer device. This includes information on the buttons associated with the pointer device and the distance that each of the axes associated with the pointer device has been moved. If the state of the pointer device has not changed since the last call to **GetState()**, then **EFI\_NOT\_READY** is returned. If the state of the pointer device has changed since the last call to **GetState()**, then the state information is placed in *State*, and **EFI\_SUCCESS** is returned. If a device error occurs while attempting to retrieve the state information, then **EFI\_DEVICE\_ERROR** is returned.

## Status Codes Returned

EFI_SUCCESS	The state of the pointer device was returned in <i>State</i> .
EFI_NOT_READY	The state of the pointer device has not changed since the last call to <b>GetState()</b> .
EFI_DEVICE_ERROR	A device error occurred while attempting to retrieve the pointer device's current state.

## 12.6 EFI Simple Pointer Device Paths

An **EFI\_SIMPLE\_POINTER\_PROTOCOL** must be installed on a handle for its services to be available to drivers and applications written to this specification. In addition to the **EFI\_SIMPLE\_POINTER\_PROTOCOL**, an **EFI\_DEVICE\_PATH\_PROTOCOL** must also be installed on the same handle. See [Section 10.2](#) for a detailed description of the **EFI\_DEVICE\_PATH\_PROTOCOL**.

A device path describes the location of a hardware component in a system from the processor's point of view. This includes the list of busses that lie between the processor and the pointer controller. The *UEFI Specification* takes advantage of the *ACPI*

*Specification* to name system components. The following set of examples shows sample device paths for a PS/2\* mouse, a serial mouse, and a USB mouse.

[Table 104](#) shows an example device path for a PS/2 mouse that is located behind a PCI to ISA bridge that is located at PCI device number 0x07 and PCI function 0x00, and is directly attached to a PCI root bridge. This device path consists of an ACPI Device Path Node for the PCI Root Bridge, a PCI Device Path Node for the PCI to ISA bridge, an ACPI Device Path Node for the PS/2 mouse, and a Device Path End Structure. The `_HID` and `_UID` of the first ACPI Device Path Node must match the ACPI table description of the PCI Root Bridge. The shorthand notation for this device path is:

**ACPI(PNPOA03,0)/PCI(7,0)/ACPI(PNPOF03,0)**

**Table 104. PS/2 Mouse Device Path**

Byte Offset	Byte Length	Data	Description
0x00	0x01	0x02	<b>Generic Device Path Header</b> – Type ACPI Device Path
0x01	0x01	0x01	Sub type – ACPI Device Path
0x02	0x02	0x0C	Length – 0x0C bytes
0x04	0x04	0x41D0, 0x0A03	<code>_HID</code> PNPOA03 – 0x41D0 represents a compressed string ‘PNP’ and is in the low order bytes. The compression method is described in the ACPI Specification.
0x08	0x04	0x0000	<code>_UID</code>
0x0C	0x01	0x01	<b>Generic Device Path Header</b> – Type Hardware Device Path
0x0D	0x01	0x01	Sub type – PCI
0x0E	0x02	0x06	Length – 0x06 bytes
0x10	0x01	0x00	PCI Function
0x11	0x01	0x07	PCI Device
0x12	0x01	0x02	<b>Generic Device Path Header</b> – Type ACPI Device Path
0x13	0x01	0x01	Sub type – ACPI Device Path
0x14	0x02	0x0C	Length – 0x0C bytes
0x16	0x04	0x41D0, 0x0F03	<code>_HID</code> PNPOA03 – 0x41D0 represents a compressed string ‘PNP’ and is in the low order bytes. The compression method is described in the ACPI Specification.
0x1A	0x04	0x0000	<code>_UID</code>
0x1E	0x01	0xFF	<b>Generic Device Path Header</b> – Type End of Hardware Device Path
0x1F	0x01	0xFF	Sub type – End of Entire Device Path
0x20	0x02	0x04	Length – 0x04 bytes

[Table 105](#) shows an example device path for a serial mouse that is located on COM 1 behind a PCI to ISA bridge that is located at PCI device number 0x07 and PCI function 0x00. The PCI to ISA bridge is directly attached to a PCI root bridge, and the communications parameters for COM 1 are 1200 baud, no parity, 8 data bits, and 1 stop bit. This device path consists of an ACPI Device Path Node for the PCI Root Bridge, a PCI Device Path Node for the PCI to ISA bridge, an ACPI Device Path Node for COM 1, a UART

Device Path Node for the communications parameters, an ACPI Device Path Node for the serial mouse, and a Device Path End Structure. The `_HID` and `_UID` of the first ACPI Device Path Node must match the ACPI table description of the PCI Root Bridge. The shorthand notation for this device path is:

**ACPI(PNP0A03,0)/PCI(7,0)/ACPI(PNP0501,0)/UART(1200,N,8,1)/ACPI(PNP0F01,0)**

**Table 105. Serial Mouse Device Path**

Byte Offset	Byte Length	Data	Description
0x00	0x01	0x02	<b>Generic Device Path Header</b> – Type ACPI Device Path
0x01	0x01	0x01	Sub type – ACPI Device Path
0x02	0x02	0x0C	Length – 0x0C bytes
0x04	0x04	0x41D0, 0x0A03	_HID PNP0A03 – 0x41D0 represents the compressed string ‘PNP’ and is encoded in the low order bytes. The compression method is described in the ACPI Specification.
0x08	0x04	0x0000	_UID
0x0C	0x01	0x01	<b>Generic Device Path Header</b> – Type Hardware Device Path
0x0D	0x01	0x01	Sub type – PCI
0x0E	0x02	0x06	Length – 0x06 bytes
0x10	0x01	0x00	PCI Function
0x11	0x01	0x07	PCI Device
0x12	0x01	0x02	<b>Generic Device Path Header</b> – Type ACPI Device Path
0x13	0x01	0x01	Sub type – ACPI Device Path
0x14	0x02	0x0C	Length – 0x0C bytes
0x16	0x04	0x41D0, 0x0501	_HID PNP0501 – 0x41D0 represents the compressed string ‘PNP’ and is encoded in the low order bytes. The compression method is described in the ACPI Specification.
0x1A	0x04	0x0000	_UID
0x1E	0x01	0x03	<b>Generic Device Path Header</b> – Messaging Device Path
0x1F	0x01	0x0E	Sub type – UART Device Path
0x20	0x02	0x13	Length – 0x13 bytes
0x22	0x04	0x00	Reserved
0x26	0x08	1200	Baud Rate
0x2E	0x01	0x08	Data Bits
0x2F	0x01	0x01	Parity
0x30	0x01	0x01	Stop Bits
0x31	0x01	0x02	<b>Generic Device Path Header</b> – Type ACPI Device Path
0x32	0x01	0x01	Sub type – ACPI Device Path
0x33	0x02	0x0C	Length – 0x0C bytes
0x35	0x04	0x41D0, 0x0F01	_HID PNP0F01 – 0x41D0 represents the compressed string ‘PNP’ and is encoded in the low order bytes. The compression method is described in the ACPI Specification.
0x39	0x04	0x0000	_UID
0x3D	0x01	0xFF	<b>Generic Device Path Header</b> – Type End of Hardware Device Path
0x3E	0x01	0xFF	Sub type – End of Entire Device Path
0x3F	0x02	0x04	Length – 0x04 bytes

[Table 106](#) shows an example device path for a USB mouse that is behind a PCI to USB host controller that is located at PCI device number 0x07 and PCI function 0x02. The PCI to USB host controller is directly attached to a PCI root bridge. This device path consists of an ACPI Device Path Node for the PCI Root Bridge, a PCI Device Path Node for the PCI to USB controller, a USB Device Path Node, and a Device Path End Structure. The `_HID` and `_UID` of the first ACPI Device Path Node must match the ACPI table description of the PCI Root Bridge. The shorthand notation for this device path is:

**ACPI(PNPOA03,0)/PCI(7,2)/USB(0,0)**

**Table 106. USB Mouse Device Path**

Byte Offset	Byte Length	Data	Description
0x00	0x01	0x02	<b>Generic Device Path Header</b> – Type ACPI Device Path
0x01	0x01	0x01	Sub type – ACPI Device Path
0x02	0x02	0x0C	Length – 0x0C bytes
0x04	0x04	0x41D0, 0x0A03	<code>_HID</code> PNPOA03 – 0x41D0 represents a compressed string ‘PNP’ and is in the low order bytes.
0x08	0x04	0x0000	<code>_UID</code>
0x0C	0x01	0x01	<b>Generic Device Path Header</b> – Type Hardware Device Path
0x0D	0x01	0x01	Sub type – PCI
0x0E	0x02	0x06	Length – 0x06 bytes
0x10	0x01	0x02	PCI Function
0x11	0x01	0x07	PCI Device
0x12	0x01	0x03	<b>Generic Device Path Header</b> – Type Messaging Device Path
0x13	0x01	0x05	Sub type – USB
0x14	0x02	0x06	Length – 0x06 bytes
0x16	0x01	0x00	USB Port Number
0x17	0x01	0x00	USB Endpoint Number
0x18	0x01	0xFF	<b>Generic Device Path Header</b> – Type End of Hardware Device Path
0x19	0x01	0xFF	Sub type – End of Entire Device Path
0x1A	0x02	0x04	Length – 0x04 bytes

## 12.7 Absolute Pointer Protocol

This section defines the Absolute Pointer Protocol and a detailed description of the **EFI\_ABSOLUTE\_POINTER\_PROTOCOL**. The intent of this section is to specify a simple method

for accessing absolute pointer devices. This would include devices like touch screens, and digitizers.

The **EFI\_ABSOLUTE\_POINTER\_PROTOCOL** allows information about a pointer device to be

retrieved. This would include the status of buttons and the coordinates of the pointer device on the last time it was activated. This protocol is attached to the device handle of an absolute pointer device, and can be used for input from the user in the preboot environment.

Supported devices may return 1, 2, or 3 axis of information. The Z axis may optionally be used to return pressure data measurements derived from user pen force.

All supported devices must support a touch-active status. Supported devices may optionally support a second input button, for example a pen side-button.

## EFI\_ABSOLUTE\_POINTER\_PROTOCOL

### Summary

Provides services that allow information about an absolute pointer device to be retrieved.

### GUID

```
#define EFI_ABSOLUTE_POINTER_PROTOCOL_GUID \
  {0x8D59D32B, 0xC655, 0x4AE9, \
   {0x9B, 0x15, 0xF2, 0x59, 0x04, 0x99, 0x2A, 0x43}}
```

### Protocol Interface Structure

```
typedef struct _EFI_ABSOLUTE_POINTER_PROTOCOL {
  EFI_ABSOLUTE_POINTER_RESET  Reset;
  EFI_ABSOLUTE_POINTER_GET_STATE  GetState;
  EFI_EVENT  WaitForInput;
  EFI_ABSOLUTE_POINTER_MODE  *Mode;
} EFI_ABSOLUTE_POINTER_PROTOCOL;
```

### Parameters

<i>Reset</i>	Resets the pointer device. See the <b>Reset()</b> function description.
<i>GetState</i>	Retrieves the current state of the pointer device. See the <b>GetState()</b> function description.
<i>WaitForInput</i>	Event to use with <b>WaitForEvent()</b> to wait for input from the pointer device.
<i>*Mode</i>	Pointer to <b>EFI_ABSOLUTE_POINTER_MODE</b> data. The type <b>EFI_ABSOLUTE_POINTER_MODE</b> is defined in "Related Definitions" below.



## Related Definitions

```

//*****
// EFI_ABSOLUTE_POINTER_MODE
//*****
typedef struct {
    UINT64 AbsoluteMinX;
    UINT64 AbsoluteMinY;
    UINT64 AbsoluteMinZ;
    UINT64 AbsoluteMaxX;
    UINT64 AbsoluteMaxY;
    UINT64 AbsoluteMaxZ;
    UINT32 Attributes;
} EFI_ABSOLUTE_POINTER_MODE;

```

The following data values in the **EFI\_ABSOLUTE\_POINTER\_MODE** interface are read-only and are changed by using the appropriate interface functions:

<i>AbsoluteMinX</i>	The Absolute Minimum of the device on the x-axis
<i>AbsoluteMinY</i>	The Absolute Minimum of the device on the y -axis.
<i>AbsoluteMinZ</i>	The Absolute Minimum of the device on the z-axis.
<i>AbsoluteMaxX</i>	The Absolute Maximum of the device on the x-axis. If 0, and the AbsoluteMinX is 0, then the pointer device does not support a x-axis.
<i>AbsoluteMaxY</i>	The Absolute Maximum of the device on the y -axis. If 0, and the AbsoluteMinY is 0, then the pointer device does not support a y-axis.
<i>AbsoluteMaxZ</i>	The Absolute Maximum of the device on the z-axis. If 0, and the AbsoluteMinZ is 0, then the pointer device does not support a z-axis.
<i>Attributes</i>	The following bits are set as needed (or'd together) to indicate the capabilities of the device supported. The remaining bits are undefined and should be returned as 0.

```

#define EFI_ABSP_SupportsAltActive 0x00000001
#define EFI_ABSP_SupportsPressureAsZ 0x00000002

```

### **EFI\_ABSP\_SupportsAltActive**

If set, indicates this device supports an alternate button input.

### **EFI\_ABSP\_SupportsPressureAsZ**

If set, indicates this device returns pressure data in parameter CurrentZ.

The driver is not permitted to return all zeros for all three pairs of Min and Max as this would indicate no axis supported.

## Description

The **EFI\_ABSOLUTE\_POINTER\_PROTOCOL** provides a set of services for a pointer device that can be used as an input device from an application written to this specification. The services include the ability to reset the pointer device, retrieve the state of the pointer device, and retrieve the capabilities of the pointer device. In addition certain data items describing the device are provided.

## EFI\_ABSOLUTE\_POINTER\_PROTOCOL.Reset()

### Summary

Resets the pointer device hardware.

### Prototype

```
typedef
EFI_STATUS
(EFIAPI *EFI_ABSOLUTE_POINTER_RESET) (
  IN EFI_ABSOLUTE_POINTER_PROTOCOL *This,
  IN BOOLEAN ExtendedVerification
);
```

### Parameters

*This*

A pointer to the **EFI\_ABSOLUTE\_POINTER\_PROTOCOL** instance. Type **EFI\_ABSOLUTE\_POINTER\_PROTOCOL** is defined in this section.

*ExtendedVerification*

Indicates that the driver may perform a more exhaustive verification operation of the device during reset.

### Description

This Reset() function resets the pointer device hardware. As part of initialization process, the firmware/device will make a quick but reasonable attempt to verify that the device is functioning. If the ExtendedVerification flag is TRUE the firmware may take an extended amount of time to verify the device is operating on reset. Otherwise the reset operation is to occur as quickly as possible.

The hardware verification process is not defined by this specification and is left up to the platform firmware or driver to implement.

### Codes Returned

EFI_SUCCESS	The device was reset.
EFI_DEVICE_ERROR	The device is not functioning correctly and could not be reset.

## EFI\_ABSOLUTE\_POINTER\_PROTOCOL.GetState()

### Summary

Retrieves the current state of a pointer device.

### Prototype

```
typedef
EFI_STATUS
(EFIAPI *EFI_ABSOLUTE_POINTER_GET_STATE) (
    IN EFI_ABSOLUTE_POINTER_PROTOCOL *This,
    IN OUT EFI_ABSOLUTE_POINTER_STATE *State
);
```

### Parameters

<i>This</i>	A pointer to the <b>EFI_ABSOLUTE_POINTER_PROTOCOL</b> instance. Type <b>EFI_ABSOLUTE_POINTER_PROTOCOL</b> is defined in <a href="#">Section 12.7</a> .
<i>State</i>	A pointer to the state information on the pointer device. Type <b>EFI_ABSOLUTE_POINTER_STATE</b> is defined in "Related Definitions" below.

### Related Definitions

```
//*****
// EFI_ABSOLUTE_POINTER_STATE
//*****
typedef struct {
    UINT64 CurrentX;
    UINT64 CurrentY;
    UINT64 CurrentZ;
    UINT32 ActiveButtons;
} EFI_ABSOLUTE_POINTER_STATE;
```

<i>CurrentX</i>	The unsigned position of the activation on the x axis If the AbsoluteMinX and the AbsoluteMaxX fields of the <b>EFI_ABSOLUTE_POINTER_MODE</b> structure are both 0, then this pointer device does not support an x-axis, and this field must be ignored.
<i>CurrentY</i>	The unsigned position of the activation on the y axis If the AbsoluteMinY and the AbsoluteMaxY fields of the <b>EFI_ABSOLUTE_POINTER_MODE</b> structure are both 0, then this pointer device does not support a y-axis, and this field must be ignored.
<i>CurrentZ</i>	The unsigned position of the activation on the z axis, or the pressure measurement. If the AbsoluteMinZ and the AbsoluteMaxZ fields of the <b>EFI_ABSOLUTE_POINTER_MODE</b> structure are both 0,

then this pointer device does not support a z-axis, and this field must be ignored.

### *ActiveButtons*

Bits are set to 1 in this structure item to indicate that device buttons are active.

## Related Definitions

```

//*****
//definitions of bits within ActiveButtons
//*****
#define EFI_ABSP_TouchActive 0x00000001
#define EFI_ABS_AltActive 0x00000002

```

**EFI\_ABSP\_TouchActive** This bit is set if the touch sensor is active

**EFI\_ABS\_AltActive** This bit is set if the alt sensor, such as pen-side button, is active.

## Description

The `GetState()` function retrieves the current state of a pointer device. This includes information on the active state associated with the pointer device and the current position of the axes associated with the pointer device. If the state of the pointer device has not changed since the last call to `GetState()`, then **EFI\_NOT\_READY** is returned. If the state of the pointer device has changed since the last call to `GetState()`, then the state information is placed in `State`, and **EFI\_SUCCESS** is returned. If a device error occurs while attempting to retrieve the state information, then **EFI\_DEVICE\_ERROR** is returned.

## Status Codes Returned

EFI_SUCCESS	The state of the pointer device was returned in <i>State</i> .
EFI_NOT_READY	The state of the pointer device has not changed since the last call to <b>GetState()</b> .
EFI_DEVICE_ERROR	A device error occurred while attempting to retrieve the pointer device's current state.

## 12.8 Serial I/O Protocol

This section defines the Serial I/O protocol. This protocol is used to abstract byte stream devices.

### EFI\_SERIAL\_IO\_PROTOCOL

#### Summary

This protocol is used to communicate with any type of character-based I/O device.

## GUID

```
#define EFI_SERIAL_IO_PROTOCOL_GUID \
{0xBB25CF6F,0xF1D4,0x11D2,\
{0x9a,0x0c,0x00,0x90,0x27,0x3f,0xc1,0xfd}}
```

## Revision Number

```
#define EFI_SERIAL_IO_PROTOCOL_REVISION 0x00010000
```

## Protocol Interface Structure

```
typedef struct {
    UINT32      Revision;
    EFI_SERIAL_RESET Reset;
    EFI_SERIAL_SET_ATTRIBUTES SetAttributes;
    EFI_SERIAL_SET_CONTROL_BITS SetControl;
    EFI_SERIAL_GET_CONTROL_BITS GetControl;
    EFI_SERIAL_WRITE Write;
    EFI_SERIAL_READ Read;
    SERIAL_IO_MODE *Mode;
} EFI_SERIAL_IO_PROTOCOL;
```

## Parameters

<i>Revision</i>	The revision to which the <b>EFI_SERIAL_IO_PROTOCOL</b> adheres. All future revisions must be backwards compatible. If a future version is not backwards compatible, it is not the same GUID.
<i>Reset</i>	Resets the hardware device.
<i>SetAttributes</i>	Sets communication parameters for a serial device. These include the baud rate, receive FIFO depth, transmit/receive time out, parity, data bits, and stop bit attributes.
<i>SetControl</i>	Sets the control bits on a serial device. These include Request to Send and Data Terminal Ready.
<i>GetControl</i>	Reads the status of the control bits on a serial device. These include Clear to Send, Data Set Ready, Ring Indicator, and Carrier Detect.
<i>Write</i>	Sends a buffer of characters to a serial device.
<i>Read</i>	Receives a buffer of characters from a serial device.
<i>Mode</i>	Pointer to <b>SERIAL_IO_MODE</b> data. Type <b>SERIAL_IO_MODE</b> is defined in “Related Definitions” below.

## Related Definitions

```

//*****
// SERIAL_IO_MODE
//*****
typedef struct {
    UINT32    ControlMask;

    // current Attributes
    UINT32    Timeout;
    UINT64    BaudRate;
    UINT32    ReceiveFifoDepth;
    UINT32    DataBits;
    UINT32    Parity;
    UINT32    StopBits;
} SERIAL_IO_MODE;

```

The data values in the **SERIAL\_IO\_MODE** are read-only and are updated by the code that produces the **EFI\_SERIAL\_IO\_PROTOCOL** functions:

<i>ControlMask</i>	A mask of the Control bits that the device supports. The device must always support the Input Buffer Empty control bit.
<i>Timeout</i>	If applicable, the number of microseconds to wait before timing out a Read or Write operation.
<i>BaudRate</i>	If applicable, the current baud rate setting of the device; otherwise, baud rate has the value of zero to indicate that device runs at the device's designed speed.
<i>ReceiveFifoDepth</i>	The number of characters the device will buffer on input.
<i>DataBits</i>	The number of data bits in each character.
<i>Parity</i>	If applicable, this is the <b>EFI_PARITY_TYPE</b> that is computed or checked as each character is transmitted or received. If the device does not support parity the value is the default parity value.
<i>StopBits</i>	If applicable, the <b>EFI_STOP_BITS_TYPE</b> number of stop bits per character. If the device does not support stop bits the value is the default stop bit value.

```

//*****
// EFI_PARITY_TYPE
//*****
typedef enum {
    DefaultParity,
    NoParity,
    EvenParity,
    OddParity,
    MarkParity,
    SpaceParity
} EFI_PARITY_TYPE;

//*****
// EFI_STOP_BITS_TYPE
//*****
typedef enum {
    DefaultStopBits,
    OneStopBit, // 1 stop bit
    OneFiveStopBits, // 1.5 stop bits
    TwoStopBits // 2 stop bits
} EFI_STOP_BITS_TYPE;

```

## Description

The Serial I/O protocol is used to communicate with UART-style serial devices. These can be standard UART serial ports in PC-AT systems, serial ports attached to a USB interface, or potentially any character-based I/O device.

The Serial I/O protocol can control byte I/O style devices from a generic device, to a device with features such as a UART. As such many of the serial I/O features are optional to allow for the case of devices that do not have UART controls. Each of these options is called out in the specific serial I/O functions.

The default attributes for all UART-style serial device interfaces are: 115,200 baud, a 1 byte receive FIFO, a 1,000,000 microsecond timeout per character, no parity, 8 data bits, and 1 stop bit. Flow control is the responsibility of the software that uses the protocol. Hardware flow control can be implemented through the use of the [GetControl\(\)](#) and [SetControl\(\)](#) functions (described below) to monitor and assert the flow control signals. The XON/XOFF flow control algorithm can be implemented in software by inserting XON and XOFF characters into the serial data stream as required.

Special care must be taken if a significant amount of data is going to be read from a serial device. Since UEFI drivers are polled mode drivers, characters received on a serial device might be missed. It is the responsibility of the software that uses the protocol to check for new data often enough to guarantee that no characters will be missed. The required polling frequency depends on the baud rate of the connection and the depth of the receive FIFO.



## EFI\_SERIAL\_IO\_PROTOCOL.Reset()

### Summary

Resets the serial device.

### Prototype

```
typedef
EFI_STATUS
(EFIAPI *EFI_SERIAL_RESET) (
    IN EFI_SERIAL_IO_PROTOCOL *This
);
```

### Parameters

*This*

A pointer to the **EFI\_SERIAL\_IO\_PROTOCOL** instance. Type **EFI\_SERIAL\_IO\_PROTOCOL** is defined in [Section 12.8](#).

### Description

The **Reset()** function resets the hardware of a serial device.

### Status Codes Returned

EFI_SUCCESS	The serial device was reset.
EFI_DEVICE_ERROR	The serial device could not be reset.

## EFI\_SERIAL\_IO\_PROTOCOL.SetAttributes()

### Summary

Sets the baud rate, receive FIFO depth, transmit/receive time out, parity, data bits, and stop bits on a serial device.

```

EFI_STATUS
(EFI_API *EFI_SERIAL_SET_ATTRIBUTES) (
    IN EFI_SERIAL_IO_PROTOCOL *This,
    IN UINT64      BaudRate,
    IN UINT32      ReceiveFifoDepth,
    IN UINT32      Timeout,
    IN EFI_PARITY_TYPE Parity,
    IN UINT8      DataBits,
    IN EFI_STOP_BITS_TYPE StopBits
);
    
```

### Parameters

<i>This</i>	A pointer to the <b>EFI_SERIAL_IO_PROTOCOL</b> instance. Type <b>EFI_SERIAL_IO_PROTOCOL</b> is defined in <a href="#">Section 12.8</a> .
<i>BaudRate</i>	The requested baud rate. A <i>BaudRate</i> value of 0 will use the device's default interface speed.
<i>ReceiveFifoDepth</i>	The requested depth of the FIFO on the receive side of the serial interface. A <i>ReceiveFifoDepth</i> value of 0 will use the device's default FIFO depth.
<i>Timeout</i>	The requested time out for a single character in microseconds. This timeout applies to both the transmit and receive side of the interface. A <i>Timeout</i> value of 0 will use the device's default time out value.
<i>Parity</i>	The type of parity to use on this serial device. A <i>Parity</i> value of <b>DefaultParity</b> will use the device's default parity value. Type <a href="#">EFI_PARITY_TYPE</a> is defined in "Related Definitions" in <a href="#">Section 12.8</a> .
<i>DataBits</i>	The number of data bits to use on this serial device. A <i>DataBits</i> value of 0 will use the device's default data bit setting.
<i>StopBits</i>	The number of stop bits to use on this serial device. A <i>StopBits</i> value of <b>DefaultStopBits</b> will use the device's default number of stop bits. Type <a href="#">EFI_STOP_BITS_TYPE</a> is defined in "Related Definitions" in <a href="#">Section 12.8</a> .

### Description

The **SetAttributes()** function sets the baud rate, receive-FIFO depth, transmit/receive time out, parity, data bits, and stop bits on a serial device.

The controller for a serial device is programmed with the specified attributes. If the *Parity*, *DataBits*, or *StopBits* values are not valid, then an error will be returned. If the specified *BaudRate* is below the minimum baud rate supported by the serial device, an error will be returned. The nearest baud rate supported by the serial device will be selected without exceeding the *BaudRate* parameter. If the specified *ReceiveFifoDepth* is below the smallest FIFO size supported by the serial device, an error will be returned. The nearest FIFO size supported by the serial device will be selected without exceeding the *ReceiveFifoDepth* parameter.

### Status Codes Returned

EFI_SUCCESS	The new attributes were set on the serial device.
EFI_INVALID_PARAMETER	One or more of the attributes has an unsupported value.
EFI_DEVICE_ERROR	The serial device is not functioning correctly.

## EFI\_SERIAL\_IO\_PROTOCOL.SetControl()

### Summary

Sets the control bits on a serial device.

### Prototype

```
typedef
EFI_STATUS
(EFIAPI *EFI_SERIAL_SET_CONTROL_BITS) (
    IN EFI_SERIAL_IO_PROTOCOL *This,
    IN UINT32    Control
);
```

### Parameters

<i>This</i>	A pointer to the <b>EFI_SERIAL_IO_PROTOCOL</b> instance. Type <b>EFI_SERIAL_IO_PROTOCOL</b> is defined in <a href="#">Section 12.8</a> .
<i>Control</i>	Sets the bits of <i>Control</i> that are settable. See “Related Definitions” below.

### Related Definitions

```

//*****
// CONTROL BITS
//*****

#define EFI_SERIAL_CLEAR_TO_SEND    0x0010
#define EFI_SERIAL_DATA_SET_READY   0x0020
#define EFI_SERIAL_RING_INDICATE    0x0040
#define EFI_SERIAL_CARRIER_DETECT  0x0080
#define EFI_SERIAL_REQUEST_TO_SEND  0x0002
#define EFI_SERIAL_DATA_TERMINAL_READY  0x0001
#define EFI_SERIAL_INPUT_BUFFER_EMPTY  0x0100
#define EFI_SERIAL_OUTPUT_BUFFER_EMPTY  0x0200
#define EFI_SERIAL_HARDWARE_LOOPBACK_ENABLE  0x1000
#define EFI_SERIAL_SOFTWARE_LOOPBACK_ENABLE  0x2000
#define EFI_SERIAL_HARDWARE_FLOW_CONTROL_ENABLE 0x4000
    
```

### Description

The **SetControl()** function is used to assert or deassert the control signals on a serial device. The following signals are set according their bit settings:

- Request to Send
- Data Terminal Ready

Only the **REQUEST\_TO\_SEND**, **DATA\_TERMINAL\_READY**, **HARDWARE\_LOOPBACK\_ENABLE**, **SOFTWARE\_LOOPBACK\_ENABLE**, and

**HARDWARE\_FLOW\_CONTROL\_ENABLE** bits can be set with **SetControl()**. All the bits can be read with [GetControl\(\)](#).

### Status Codes Returned

EFI_SUCCESS	The new control bits were set on the serial device.
EFI_UNSUPPORTED	The serial device does not support this operation.
EFI_DEVICE_ERROR	The serial device is not functioning correctly.

## EFI\_SERIAL\_IO\_PROTOCOL.GetControl()

### Summary

Retrieves the status of the control bits on a serial device.

### Prototype

```
typedef
EFI_STATUS
(EFIAPI *EFI_SERIAL_GET_CONTROL_BITS) (
    IN EFI_SERIAL_IO_PROTOCOL *This,
    OUT UINT32 *Control
);
```

### Parameters

<i>This</i>	A pointer to the <b>EFI_SERIAL_IO_PROTOCOL</b> instance. Type <b>EFI_SERIAL_IO_PROTOCOL</b> is defined in <a href="#">Section 12.8</a> .
<i>Control</i>	A pointer to return the current control signals from the serial device. See “Related Definitions” below.

### Related Definitions

```
//*****
// CONTROL BITS
//*****

#define EFI_SERIAL_CLEAR_TO_SEND      0x0010
#define EFI_SERIAL_DATA_SET_READY    0x0020
#define EFI_SERIAL_RING_INDICATE     0x0040
#define EFI_SERIAL_CARRIER_DETECT   0x0080
#define EFI_SERIAL_REQUEST_TO_SEND   0x0002
#define EFI_SERIAL_DATA_TERMINAL_READY 0x0001
#define EFI_SERIAL_INPUT_BUFFER_EMPTY 0x0100
#define EFI_SERIAL_OUTPUT_BUFFER_EMPTY 0x0200
#define EFI_SERIAL_HARDWARE_LOOPBACK_ENABLE 0x1000
#define EFI_SERIAL_SOFTWARE_LOOPBACK_ENABLE 0x2000
#define EFI_SERIAL_HARDWARE_FLOW_CONTROL_ENABLE 0x4000
```

### Description

The **GetControl()** function retrieves the status of the control bits on a serial device.

### Status Codes Returned

EFI_SUCCESS	The control bits were read from the serial device.
EFI_DEVICE_ERROR	The serial device is not functioning correctly.

## EFI\_SERIAL\_IO\_PROTOCOL.Write()

### Summary

Writes data to a serial device.

### Prototype

```
typedef
EFI_STATUS
(EFI_API *EFI_SERIAL_WRITE) (
  IN EFI_SERIAL_IO_PROTOCOL *This,
  IN OUT UINTN *BufferSize,
  IN VOID *Buffer
);
```

### Parameters

<i>This</i>	A pointer to the <b>EFI_SERIAL_IO_PROTOCOL</b> instance. Type <b>EFI_SERIAL_IO_PROTOCOL</b> is defined in <a href="#">Section 12.8</a> .
<i>BufferSize</i>	On input, the size of the <i>Buffer</i> . On output, the amount of data actually written.
<i>Buffer</i>	The buffer of data to write.

### Description

The **Write()** function writes the specified number of bytes to a serial device. If a time out error occurs while data is being sent to the serial port, transmission of this buffer will terminate, and **EFI\_TIMEOUT** will be returned. In all cases the number of bytes actually written to the serial device is returned in *BufferSize*.

### Status Codes Returned

EFI_SUCCESS	The data was written.
EFI_DEVICE_ERROR	The device reported an error.
EFI_TIMEOUT	The data write was stopped due to a timeout.

## EFI\_SERIAL\_IO\_PROTOCOL.Read()

### Summary

Reads data from a serial device.

### Prototype

```
typedef
EFI_STATUS
(EFI_API *EFI_SERIAL_READ) (
    IN EFI_SERIAL_IO_PROTOCOL *This,
    IN OUT UINTN *BufferSize,
    OUT VOID *Buffer
);
```

### Parameters

<i>This</i>	A pointer to the <b>EFI_SERIAL_IO_PROTOCOL</b> instance. Type <b>EFI_SERIAL_IO_PROTOCOL</b> is defined in <a href="#">Section 12.8</a> .
<i>BufferSize</i>	On input, the size of the <i>Buffer</i> . On output, the amount of data returned in <i>Buffer</i> .
<i>Buffer</i>	The buffer to return the data into.

### Description

The **Read()** function reads a specified number of bytes from a serial device. If a time out error or an overrun error is detected while data is being read from the serial device, then no more characters will be read, and an error will be returned. In all cases the number of bytes actually read is returned in *BufferSize*.

### Status Codes Returned

EFI_SUCCESS	The data was read.
EFI_DEVICE_ERROR	The serial device reported an error.
EFI_TIMEOUT	The operation was stopped due to a timeout or overrun.

## 12.9 Graphics Output Protocol

The goal of this section is to replace the functionality that currently exists with VGA hardware and its corresponding video BIOS. The Graphics Output Protocol is a software abstraction and its goal is to support any foreseeable graphics hardware and not require VGA hardware, while at the same time also lending itself to implementation on the current generation of VGA hardware.

Graphics output is important in the pre-boot space to support modern firmware features. These features include the display of logos, the localization of output to any language, and setup and configuration screens.



Graphics output may also be required as part of the startup of an operating system. There are potentially times in modern operating systems prior to the loading of a high performance OS graphics driver where access to graphics output device is required. The Graphics Output Protocol supports this capability by providing the EFI OS loader access to a hardware frame buffer and enough information to allow the OS to draw directly to the graphics output device.

The [EFI\\_GRAPHICS\\_OUTPUT\\_PROTOCOL](#) supports three member functions to support the limited graphics needs of the pre-boot environment. These member functions allow the caller to draw to a virtualized frame buffer, retrieve the supported video modes, and to set a video mode. These simple primitives are sufficient to support the general needs of pre-OS firmware code.

The [EFI\\_GRAPHICS\\_OUTPUT\\_PROTOCOL](#) also exports enough information about the current mode for operating system startup software to access the linear frame buffer directly.

The interface structure for the Graphics Output protocol is defined in this section. A unique Graphics Output protocol must represent each video frame buffer in the system that is driven out to one or more video output devices.

### 12.9.1 Blt Buffer

The basic graphics operation in the [EFI\\_GRAPHICS\\_OUTPUT\\_PROTOCOL](#) is the Block Transfer or Blt. The Blt operation allows data to be read or written to the video adapter's video memory. The Blt operation abstracts the video adapters hardware implementation by introducing the concept of a software Blt buffer.

The frame buffer abstracts the video display as an array of pixels. Each pixels location on the video display is defined by its X and Y coordinates. The X coordinate represents a scan line. A scan line is a horizontal line of pixels on the display. The Y coordinate represents a vertical line on the display. The upper left hand corner of the video display is defined as (0, 0) where the notation (X, Y) represents the X and Y coordinate of the pixel. The lower right corner of the video display is represented by (Width - 1, Height - 1).

The software Blt buffer is structured as an array of pixels. Pixel (0, 0) is the first element of the software Blt buffer. The Blt buffer can be thought of as a set of scan lines. It is possible to convert a pixel location on the video display to the Blt buffer using the following algorithm: Blt buffer array index = Y \* Width + X.

Each software Blt buffer entry represents a pixel that is comprised of a 32-bit quantity. Byte zero of the Blt buffer entry represents the Red component of the pixel. Byte one of the Blt buffer entry represents the Green component of the pixel. Byte two of the Blt buffer entry represents the Blue component of the pixel. Byte three of the Blt buffer entry is reserved and must be zero. The byte values for the red, green, and blue components represent the color intensity. This color intensity value range from a minimum intensity of 0 to maximum intensity of 255.

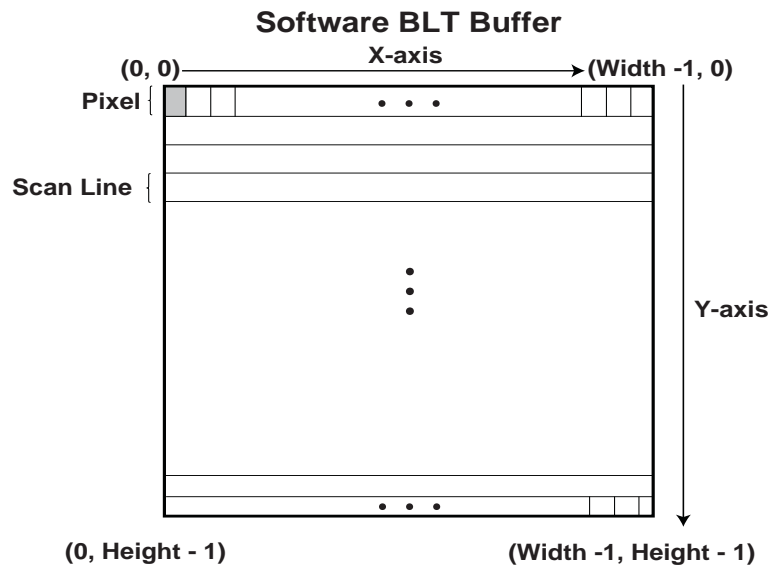

OM13157

Figure 34. Software BLT Buffer

## EFI\_GRAPHICS\_OUTPUT\_PROTOCOL

### Summary

Provides a basic abstraction to set video modes and copy pixels to and from the graphics controller's frame buffer. The linear address of the hardware frame buffer is also exposed so software can write directly to the video hardware.

### GUID

```
#define EFI_GRAPHICS_OUTPUT_PROTOCOL_GUID \
{0x9042a9de,0x23dc,0x4a38,\
{0x96,0xfb,0x7a,0xde,0xd0,0x80,0x51,0x6a}}
```

### Protocol Interface Structure

```
typedef struct EFI_GRAPHICS_OUTPUT_PROTOCOL {
EFI_GRAPHICS_OUTPUT_PROTOCOL_QUERY_MODE QueryMode;
EFI_GRAPHICS_OUTPUT_PROTOCOL_SET_MODE SetMode;
EFI_GRAPHICS_OUTPUT_PROTOCOL_BLT Blt;
EFI_GRAPHICS_OUTPUT_PROTOCOL_MODE *Mode;
} EFI_GRAPHICS_OUTPUT_PROTOCOL;
```

### Parameters

*QueryMode*

Returns information for an available graphics mode that the graphics device and the set of active video output devices supports.

<i>SetMode</i>	Set the video device into the specified mode and clears the visible portions of the output display to black.
<i>Blt</i>	Software abstraction to draw on the video device's frame buffer.
<i>Mode</i>	Pointer to <b>EFI_GRAPHICS_OUTPUT_PROTOCOL_MODE</b> data. Type <b>EFI_GRAPHICS_OUTPUT_PROTOCOL_MODE</b> is defined in "Related Definitions" below.

## Related Definitions

```
typedef struct {
    UINT32 RedMask;
    UINT32 GreenMask;
    UINT32 BlueMask;
    UINT32 ReservedMask;
} EFI_PIXEL_BITMASK;
```

If a bit is set in *RedMask*, *GreenMask*, or *BlueMask* then those bits of the pixel represent the corresponding color. Bits in *RedMask*, *GreenMask*, *BlueMask*, and *ReservedMask* must not overlap bit positions. The values for the red, green, and blue components in the bit mask represent the color intensity. The color intensities must increase as the color values for each color mask increase with a minimum intensity of all bits in a color mask clear to a maximum intensity of all bits in a color mask set.

```
typedef enum {
    PixelRedGreenBlueReserved8BitPerColor,
    PixelBlueGreenRedReserved8BitPerColor,
    PixelBitMask,
    PixelBitOnly,
    PixelFormatMax
} EFI_GRAPHICS_PIXEL_FORMAT;
```

### *PixelRedGreenBlueReserved8BitPerColor*

A pixel is 32-bits and byte zero represents red, byte one represents green, byte two represents blue, and byte three is reserved. This is the definition for the physical frame buffer. The byte values for the red, green, and blue components represent the color intensity. This color intensity value range from a minimum intensity of 0 to maximum intensity of 255.

### *PixelBlueGreenRedReserved8BitPerColor*

A pixel is 32-bits and byte zero represents blue, byte one represents green, byte two represents red, and byte three is reserved. This is the definition for the physical frame buffer. The byte values for the red, green, and blue components represent the color intensity. This color intensity value range from a minimum intensity of 0 to maximum intensity of 255.

*PixelBitMask* The pixel definition of the physical frame buffer is defined by **EFI\_PIXEL\_BITMASK**.

*PixelBltOnly* This mode does not support a physical frame buffer.

*PixelFormatMax* Valid **EFI\_GRAPHICS\_PIXEL\_FORMAT** enum values are less than this value.

```
typedef struct {
    UINT32      Version;
    UINT32      HorizontalResolution;
    UINT32      VerticalResolution;
    EFI_GRAPHICS_PIXEL_FORMAT PixelFormat;
    EFI_PIXEL_BITMASK PixelInformation;
    UINT32      PixelsPerScanLine;
} EFI_GRAPHICS_OUTPUT_MODE_INFORMATION;
```

*Version* The version of this data structure. A value of zero represents the **EFI\_GRAPHICS\_OUTPUT\_MODE\_INFORMATION** structure as defined in this specification. Future version of this specification may extend this data structure in a backwards compatible way and increase the value of *Version*.

*HorizontalResolution* The size of video screen in pixels in the X dimension.

*VerticalResolution* The size of video screen in pixels in the Y dimension.

*PixelFormat* Enumeration that defines the physical format of the pixel. A value of *PixelBltOnly* implies that a linear frame buffer is not available for this mode.

*PixelInformation* This bit-mask is only valid if *PixelFormat* is set to *PixelPixelBitMask*. A bit being set defines what bits are used for what purpose such as Red, Green, Blue, or Reserved.

*PixelsPerScanLine* Defines the number of pixel elements per video memory line. For performance reasons, or due to hardware restrictions, scan lines may be padded to an amount of memory alignment. These padding pixel elements are outside the area covered by *HorizontalResolution* and are not visible. For direct frame buffer access, this number is used as a span between starts of pixel lines in video memory. Based on the size of an individual pixel element and *PixelsPerScanline*, the offset in video memory from pixel element (x, y) to pixel element (x, y+1) has to be calculated as "sizeof( PixelElement ) \* PixelsPerScanLine", not "sizeof( PixelElement ) \* HorizontalResolution", though in many cases those values can coincide. This value can depend on video hardware and mode resolution. GOP implementation is responsible for providing accurate value for this field.

**Note:** The following code sample is an example of the intended field usage:

```

INTN
GetPixelElementSize (
  IN EFI_PIXEL_BITMASK *PixelBits
)
{
  INTN HighestPixel = -1;

  INTN BluePixel;
  INTN RedPixel;
  INTN GreenPixel;
  INTN RsvdPixel;

  BluePixel = FindHighestSetBit (PixelBits->BlueMask);
  RedPixel = FindHighestSetBit (PixelBits->RedMask);
  GreenPixel = FindHighestSetBit (PixelBits->GreenMask);
  RsvdPixel = FindHighestSetBit (PixelBits->ReservedMask);

  HighestPixel = max (BluePixel, RedPixel);
  HighestPixel = max (HighestPixel, GreenPixel);
  HighestPixel = max (HighestPixel, RsvdPixel);

  return HighestPixel;
}

EFI_PHYSICAL_ADDRESS      NewPixelAddress;
EFI_PHYSICAL_ADDRESS      CurrentPixelAddress;
EFI_GRAPHICS_OUTPUT_MODE_INFORMATION OutputInfo;
INTN                      PixelElementSize;

switch (OutputInfo.PixelFormat) {
case PixelBitMask:
  PixelElementSize =
    GetPixelElementSize (&OutputInfo.PixelInformation);
  break;

case PixelBlueGreenRedReserved8BitPerColor:
case PixelRedGreenBlueReserved8BitPerColor:
  PixelElementSize =
    sizeof (EFI_GRAPHICS_OUTPUT_BLT_PIXEL);
  break;
}

//
// NewPixelAddress after execution points to the pixel
// positioned one line below the one pointed by

```

```
// CurrentPixelAddress
//
NewPixelAddress = CurrentPixelAddress +
    (PixelElementSize *
    OutputInfo.PixelsPerScanLine);
```

End of note code sample.

```
typedef struct {
    UINT32      MaxMode;
    UINT32      Mode;
    EFI_GRAPHICS_OUTPUT_MODE_INFORMATION *Info;
    UINTN       SizeOfInfo;
    EFI_PHYSICAL_ADDRESS FrameBufferBase;
    UINTN       FrameBufferSize;
} EFI_GRAPHICS_OUTPUT_PROTOCOL_MODE;
```

The **EFI\_GRAPHICS\_OUTPUT\_PROTOCOL\_MODE** is read-only and values are only changed by using the appropriate interface functions:

<i>MaxMode</i>	The number of modes supported by <b>QueryMode()</b> and <b>SetMode()</b> .
<i>Mode</i>	Current Mode of the graphics device. Valid mode numbers are 0 to <i>MaxMode</i> - 1.
<i>Info</i>	Pointer to read-only <b>EFI_GRAPHICS_OUTPUT_MODE_INFORMATION</b> data.
<i>SizeOfInfo</i>	Size of <i>Info</i> structure in bytes. Future versions of this specification may increase the size of the <b>EFI_GRAPHICS_OUTPUT_MODE_INFORMATION</b> data.
<i>FrameBufferBase</i>	Base address of graphics linear frame buffer. <i>Info</i> contains information required to allow software to draw directly to the frame buffer without using <b>Bit()</b> . Offset zero in <i>FrameBufferBase</i> represents the upper left pixel of the display.
<i>FrameBufferSize</i>	Amount of frame buffer needed to support the active mode as defined by <i>PixelsPerScanLine</i> x <i>VerticalResolution</i> x <i>PixelElementSize</i> .

## Description

The **EFI\_GRAPHICS\_OUTPUT\_PROTOCOL** provides a software abstraction to allow pixels to be drawn directly to the frame buffer. The **EFI\_GRAPHICS\_OUTPUT\_PROTOCOL** is designed to be lightweight and to support the basic needs of graphics output prior to Operating System boot.

## EFI\_GRAPHICS\_OUTPUT\_PROTOCOL.QueryMode()

### Summary

Returns information for an available graphics mode that the graphics device and the set of active video output devices supports.

### Prototype

```
typedef
EFI_STATUS
(EFIAPI *EFI_GRAPHICS_OUTPUT_PROTOCOL_QUERY_MODE) (
  IN EFI_GRAPHICS_OUTPUT_PROTOCOL  *This,
  IN UINT32          ModeNumber,
  OUT UINTN          *SizeOfInfo
  OUT EFI_GRAPHICS_OUTPUT_MODE_INFORMATION **Info
);
```

### Parameters

<i>This</i>	The <a href="#">EFI_GRAPHICS_OUTPUT_PROTOCOL</a> instance. Type <a href="#">EFI_GRAPHICS_OUTPUT_PROTOCOL</a> is defined in this section.
<i>ModeNumber</i>	The mode number to return information on. The current mode and valid modes are read-only values in the <i>Mode</i> structure of the <a href="#">EFI_GRAPHICS_OUTPUT_PROTOCOL</a> .
<i>SizeOfInfo</i>	A pointer to the size, in bytes, of the <i>Info</i> buffer.
<i>Info</i>	A pointer to a callee allocated buffer that returns information about <i>ModeNumber</i> .

### Description

The [QueryMode\(\)](#) function returns information for an available graphics mode that the graphics device and the set of active video output devices supports. If *ModeNumber* is not between 0 and *MaxMode* – 1, then [EFI\\_INVALID\\_PARAMETER](#) is returned. *MaxMode* is available from the *Mode* structure of the [EFI\\_GRAPHICS\\_OUTPUT\\_PROTOCOL](#).

The size of the *Info* structure should never be assumed and the value of *SizeOfInfo* is the only valid way to know the size of *Info*.

If the [EFI\\_GRAPHICS\\_OUTPUT\\_PROTOCOL](#) is installed on the handle that represents a single video output device, then the set of modes returned by this service is the subset of modes supported by both the graphics controller and the video output device.

If the [EFI\\_GRAPHICS\\_OUTPUT\\_PROTOCOL](#) is installed on the handle that represents a combination of video output devices, then the set of modes returned by this service is the subset of modes supported by the graphics controller and the all of the video output devices represented by the handle.

### Status Codes Returned

EFI_SUCCESS	Valid mode information was returned.
-------------	--------------------------------------

EFI_DEVICE_ERROR	A hardware error occurred trying to retrieve the video mode.
EFI_INVALID_PARAMETER	<i>ModeNumber</i> is not valid.



## EFI\_GRAPHICS\_OUTPUT\_PROTOCOL.SetMode()

### Summary

Set the video device into the specified mode and clears the visible portions of the output display to black.

### Prototype

```
typedef
EFI_STATUS
(EFIAPI *EFI_GRAPHICS_OUTPUT_PROTOCOL_SET_MODE) (
  IN EFI_GRAPHICS_OUTPUT_PROTOCOL *This,
  IN UINT32      ModeNumber
);
```

### Parameters

*This*

The [EFI\\_GRAPHICS\\_OUTPUT\\_PROTOCOL](#) instance. Type [EFI\\_GRAPHICS\\_OUTPUT\\_PROTOCOL](#) is defined in this section.

*ModeNumber*

Abstraction that defines the current video mode. The current mode and valid modes are read-only values in the *Mode* structure of the [EFI\\_GRAPHICS\\_OUTPUT\\_PROTOCOL](#).

### Description

This [SetMode\(\)](#) function sets the graphics device and the set of active video output devices to the video mode specified by *ModeNumber*. If *ModeNumber* is not supported [EFI\\_UNSUPPORTED](#) is returned.

If a device error occurs while attempting to set the video mode, then [EFI\\_DEVICE\\_ERROR](#) is returned. Otherwise, the graphics device is set to the requested geometry, the set of active output devices are set to the requested geometry, the visible portion of the hardware frame buffer is cleared to black, and [EFI\\_SUCCESS](#) is returned.

### Status Codes Returned

EFI_SUCCESS	The graphics mode specified by <i>ModeNumber</i> was selected.
EFI_DEVICE_ERROR	The device had an error and could not complete the request.
EFI_UNSUPPORTED	<i>ModeNumber</i> is not supported by this device.

## EFI\_GRAPHICS\_OUTPUT\_PROTOCOL.Blit()

### Summary

Blit a rectangle of pixels on the graphics screen. Blit stands for BLock Transfer.

### Prototype

```
typedef struct {
    UINT8 Blue;
    UINT8 Green;
    UINT8 Red;
    UINT8 Reserved;
} EFI_GRAPHICS_OUTPUT_BLT_PIXEL;

typedef enum {
    EfiBlitVideoFill,
    EfiBlitVideoToBltBuffer,
    EfiBlitBufferToVideo,
    EfiBlitVideoToVideo,
    EfiGraphicsOutputBlitOperationMax
} EFI_GRAPHICS_OUTPUT_BLT_OPERATION;

typedef
EFI_STATUS
(EFI_API *EFI_GRAPHICS_OUTPUT_PROTOCOL_BLT) (
    IN EFI_GRAPHICS_OUTPUT_PROTOCOL *This,
    IN OUT EFI_GRAPHICS_OUTPUT_BLT_PIXEL *BltBuffer, OPTIONAL
    IN EFI_GRAPHICS_OUTPUT_BLT_OPERATION BltOperation,
    IN UINTN SourceX,
    IN UINTN SourceY,
    IN UINTN DestinationX,
    IN UINTN DestinationY,
    IN UINTN Width,
    IN UINTN Height,
    IN UINTN Delta OPTIONAL
);
```

### Parameters

<i>This</i>	The <a href="#">EFI_GRAPHICS_OUTPUT_PROTOCOL</a> instance.
<i>BltBuffer</i>	The data to transfer to the graphics screen. Size is at least <i>Width*Height* sizeof(EFI_GRAPHICS_OUTPUT_BLT_PIXEL)</i> .
<i>BltOperation</i>	The operation to perform when copying <i>BltBuffer</i> on to the graphics screen.
<i>SourceX</i>	The X coordinate of the source for the <i>BltOperation</i> . The origin of the screen is 0, 0 and that is the upper left-hand corner of the screen.

<i>SourceY</i>	The Y coordinate of the source for the <i>BlitOperation</i> . The origin of the screen is 0, 0 and that is the upper left-hand corner of the screen.
<i>DestinationX</i>	The X coordinate of the destination for the <i>BlitOperation</i> . The origin of the screen is 0, 0 and that is the upper left-hand corner of the screen.
<i>DestinationY</i>	The Y coordinate of the destination for the <i>BlitOperation</i> . The origin of the screen is 0, 0 and that is the upper left-hand corner of the screen.
<i>Width</i>	The width of a rectangle in the blt rectangle in pixels. Each pixel is represented by an <b>EFI_GRAPHICS_OUTPUT_BLT_PIXEL</b> element.
<i>Height</i>	The height of a rectangle in the blt rectangle in pixels. Each pixel is represented by an <b>EFI_GRAPHICS_OUTPUT_BLT_PIXEL</b> element.
<i>Delta</i>	Not used for <i>EfiBlitVideoFill</i> or the <i>EfiBlitVideoToVideo</i> operation. If a <i>Delta</i> of zero is used, the entire <i>BlitBuffer</i> is being operated on. If a subrectangle of the <i>BlitBuffer</i> is being used then <i>Delta</i> represents the number of bytes in a row of the <i>BlitBuffer</i> .

## Description

The **Blit()** function is used to draw the *BlitBuffer* rectangle onto the video screen.

The *BlitBuffer* represents a rectangle of *Height* by *Width* pixels that will be drawn on the graphics screen using the operation specified by *BlitOperation*. The *Delta* value can be used to enable the *BlitOperation* to be performed on a sub-rectangle of the *BlitBuffer*.

[Table 107](#) describes the *BlitOperations* that are supported on rectangles. Rectangles have coordinates (left, upper) (right, bottom):

Table 107. Blt Operation Table

Blt Operation	Operation
<b>EfiBltVideoFill</b>	Write data from the <i>BltBuffer</i> pixel (0,0) directly to every pixel of the video display rectangle ( <i>DestinationX, DestinationY</i> ) ( <i>DestinationX + Width, DestinationY + Height</i> ). Only one pixel will be used from the <i>BltBuffer</i> . <i>Delta</i> is NOT used.
<b>EfiBltVideoToBltBuffer</b>	Read data from the video display rectangle ( <i>SourceX, SourceY</i> ) ( <i>SourceX + Width, SourceY + Height</i> ) and place it in the <i>BltBuffer</i> rectangle ( <i>DestinationX, DestinationY</i> ) ( <i>DestinationX + Width, DestinationY + Height</i> ). If <i>DestinationX</i> or <i>DestinationY</i> is not zero then <i>Delta</i> must be set to the length in bytes of a row in the <i>BltBuffer</i> .
<b>EfiBltBufferToVideo</b>	Write data from the <i>BltBuffer</i> rectangle ( <i>SourceX, SourceY</i> ) ( <i>SourceX + Width, SourceY + Height</i> ) directly to the video display rectangle ( <i>DestinationX, DestinationY</i> ) ( <i>DestinationX + Width, DestinationY + Height</i> ). If <i>SourceX</i> or <i>SourceY</i> is not zero then <i>Delta</i> must be set to the length in bytes of a row in the <i>BltBuffer</i> .
<b>EfiBltVideoToVideo</b>	Copy from the video display rectangle ( <i>SourceX, SourceY</i> ) ( <i>SourceX + Width, SourceY + Height</i> ) to the video display rectangle ( <i>DestinationX, DestinationY</i> ) ( <i>DestinationX + Width, DestinationY + Height</i> ). The <i>BltBuffer</i> and <i>Delta</i> are not used in this mode. There is no limitation on the overlapping of the source and destination rectangles.

### Status Codes Returned

EFI_SUCCESS	<i>BltBuffer</i> was drawn to the graphics screen.
EFI_INVALID_PARAMETER	<i>BltOperation</i> is not valid.
EFI_DEVICE_ERROR	The device had an error and could not complete the request.

## EFI\_EDID\_DISCOVERED\_PROTOCOL

### Summary

This protocol contains the EDID information retrieved from a video output device.

## GUID

```
#define EFI_EDID_DISCOVERED_PROTOCOL_GUID \
{0x1c0c34f6,0xd380,0x41fa,\
{0xa0,0x49,0x8a,0xd0,0x6c,0x1a,0x66,0xaa}}
```

## Protocol Interface Structure

```
typedef struct {
    UINT32 SizeOfEdid;
    UINT8 *Edid;
} EFI_EDID_DISCOVERED_PROTOCOL;
```

## Parameter

<i>SizeOfEdid</i>	The size, in bytes, of the <i>Edid</i> buffer. 0 if no EDID information is available from the video output device. Otherwise, it must be a minimum of 128 bytes.
<i>Edid</i>	A pointer to a read-only array of bytes that contains the EDID information for a video output device. This pointer is <b>NULL</b> if no EDID information is available from the video output device. The minimum size of a valid <i>Edid</i> buffer is 128 bytes. EDID information is defined in the E-EDID EEPROM specification published by VESA ( <a href="http://www.vesa.org">www.vesa.org</a> ).

## Description

**EFI\_EDID\_DISCOVERED\_PROTOCOL** represents the EDID information that is returned from a video output device. If the video output device does not contain any EDID information, then the *SizeOfEdid* field must set to zero and the *Edid* field must be set to **NULL**. The **EFI\_EDID\_DISCOVERED\_PROTOCOL** must be placed on every child handle that represents a possible video output device. The **EFI\_EDID\_DISCOVERED\_PROTOCOL** is never placed on child handles that represent combinations of two or more video output devices.

## EFI\_EDID\_ACTIVE\_PROTOCOL

### Summary

This protocol contains the EDID information for an active video output device. This is either the EDID information retrieved from the **EFI\_EDID\_OVERRIDE\_PROTOCOL** if an override is available, or an identical copy of the EDID information from the **EFI\_EDID\_DISCOVERED\_PROTOCOL** if no overrides are available.

## GUID

```
#define EFI_EDID_ACTIVE_PROTOCOL_GUID \
  {0xbd8c1056,0x9f36,0x44ec,\
   {0x92,0xa8,0xa6,0x33,0x7f,0x81,0x79,0x86}}
```

## Protocol Interface Structure

```
typedef struct {
  UINT32 SizeOfEdid;
  UINT8 *Edid;
} EFI_EDID_ACTIVE_PROTOCOL;
```

## Parameter

<i>SizeOfEdid</i>	The size, in bytes, of the <i>Edid</i> buffer. 0 if no EDID information is available from the video output device. Otherwise, it must be a minimum of 128 bytes.
<i>Edid</i>	A pointer to a read-only array of bytes that contains the EDID information for an active video output device. This pointer is <b>NULL</b> if no EDID information is available for the video output device. The minimum size of a valid <i>Edid</i> buffer is 128 bytes. EDID information is defined in the E-EDID EEPROM specification published by VESA ( <a href="http://www.vesa.org">www.vesa.org</a> ).

## Description

When the set of active video output devices attached to a frame buffer are selected, the **EFI\_EDID\_ACTIVE\_PROTOCOL** must be installed onto the handles that represent the each of those active video output devices. If the **EFI\_EDID\_OVERRIDE\_PROTOCOL** has override EDID information for an active video output device, then the EDID information specified by **GetEdid()** is used for the **EFI\_EDID\_ACTIVE\_PROTOCOL**. Otherwise, the EDID information from the **EFI\_EDID\_DISCOVERED\_PROTOCOL** is used for the **EFI\_EDID\_ACTIVE\_PROTOCOL**. Since all EDID information is read-only, it is legal for the pointer associated with the **EFI\_EDID\_ACTIVE\_PROTOCOL** to be the same as the pointer associated with the **EFI\_EDID\_DISCOVERED\_PROTOCOL** when no overrides are present.

## EFI\_EDID\_OVERRIDE\_PROTOCOL

### Summary

This protocol is produced by the platform to allow the platform to provide EDID information to the producer of the Graphics Output protocol.

## GUID

```
#define EFI_EDID_OVERRIDE_PROTOCOL_GUID \
{0x48ecb431,0xfb72,0x45c0,\
{0xa9,0x22,0xf4,0x58,0xfe,0x04,0x0b,0xd5}}
```

## Protocol Interface Structure

```
typedef struct _EFI_EDID_OVERRIDE_PROTOCOL {
    EFI_EDID_OVERRIDE_PROTOCOL_GET_EDID GetEdid;
} EFI_EDID_OVERRIDE_PROTOCOL;
```

## Parameter

*GetEdid*

Returns EDID values and attributes that the Video BIOS must use

## Description

This protocol is produced by the platform to allow the platform to provide EDID information to the producer of the Graphics Output protocol.

## EFI\_EDID\_OVERRIDE\_PROTOCOL.GetEdid()

### Summary

Returns policy information and potentially a replacement EDID for the specified video output device.

### Prototype

```
typedef
EFI_STATUS
(EFI_API *EFI_EDID_OVERRIDE_PROTOCOL_GET_EDID) (
  IN EFI_EDID_OVERRIDE_PROTOCOL *This,
  IN EFI_HANDLE *ChildHandle,
  OUT UINT32 *Attributes,
  IN OUT UINTN *EdidSize,
  IN OUT UINT8 **Edid
);
```

### Parameters

<i>This</i>	The <a href="#">EFI_EDID_OVERRIDE_PROTOCOL</a> instance. Type <a href="#">EFI_EDID_OVERRIDE_PROTOCOL</a> is defined in <a href="#">Section 12.10</a> .
<i>ChildHandle</i>	A child handle that represents a possible video output device.
<i>Attributes</i>	A pointer to the attributes associated with <i>ChildHandle</i> video output device.
<i>EdidSize</i>	A pointer to the size, in bytes, of the <i>Edid</i> buffer.
<i>Edid</i>	A pointer to the callee allocated buffer that contains the EDID information associated with <i>ChildHandle</i> . If <i>EdidSize</i> is 0, then a pointer to <b>NULL</b> is returned.



## Related Definitions

```
#define EFI_EDID_OVERRIDE_DONT_OVERRIDE 0x01
#define EFI_EDID_OVERRIDE_ENABLE_HOT_PLUG 0x02
```

Table 108. Attributes Definition Table

Attribute Bit	EdidSize	Operation
<code>EFI_EDID_OVERRIDE_DONT_OVERRIDE=0</code>	0	No override support for the display device.
<code>EFI_EDID_OVERRIDE_DONT_OVERRIDE=0</code>	<code>!= 0</code>	Always use returned override EDID for the display device.
<code>EFI_EDID_OVERRIDE_DONT_OVERRIDE!=0</code>	0	No override support for the display device.
<code>EFI_EDID_OVERRIDE_DONT_OVERRIDE!=0</code>	<code>!= 0</code>	Only use returned override EDID if the display device has no EDID or the EDID is incorrect. Otherwise, use the EDID from the display device.
<code>EFI_EDID_OVERRIDE_ENABLE_HOT_PLUG=0</code>	0	No hot plug support for the display device. A Graphics Output protocol will not be installed if no display device is not present.
<code>EFI_EDID_OVERRIDE_ENABLE_HOT_PLUG=0</code>	<code>!= 0</code>	No hot plug support for the display device. The returned override EDID should be used according to the <code>EFI_EDID_OVERRIDE_DONT_OVERRIDE</code> attribute bit if the display device is present.
<code>EFI_EDID_OVERRIDE_ENABLE_HOT_PLUG!=0</code>	0	Invalid. The client of this protocol will not enable hot plug for the display device, and a Graphics Output protocol will not be installed if no other display is present.
<code>EFI_EDID_OVERRIDE_ENABLE_HOT_PLUG!=0</code>	<code>!= 0</code>	Enable hot plug for the display device. A Graphics Output protocol will be installed even if the display device is not present.

## Description

This protocol is optionally provided by the platform to override or provide EDID information and/or output device display properties to the producer of the Graphics Output protocol. If *ChildHandle* does not represent a video output device, or there are no override for the video output device specified by *ChildHandle*, then **EFI\_UNSUPPORTED** is returned. Otherwise, the *Attributes*, *EdidSize*, and *Edid* parameters are returned along with a status of **EFI\_SUCCESS**. [Table 108](#) defines the behavior for the combinations of the *Attribute* and *EdidSize* parameters when **EFI\_SUCCESS** is returned.

## Status Codes Returned

EFI_SUCCESS	Valid over rides returned for <i>ChildHandle</i> .
EFI_UNSUPPORTED	<i>ChildHandle</i> has no over rides.

## 12.10 Rules for PCI/AGP Devices

A UEFI driver that produces the Graphics Output Protocol must follow the UEFI driver model, produce an [EFI\\_DRIVER\\_BINDING\\_PROTOCOL](#), and follow the rules on implementing the [Supported\(\)](#), [Start\(\)](#), and [Stop\(\)](#). The [Start\(\)](#) function must not update the video output device in any way that is visible to the user. The [Start\(\)](#) function must create child handle for each physical video output device and each supported combination of video output devices. The driver must retrieve the EDID information from each physical video output device and produce a [EFI\\_EDID\\_DISCOVERED\\_PROTOCOL](#) on the child handle that corresponds each physical video output device. The following summary describes the common initialization steps for a driver that produces the [EFI\\_GRAPHICS\\_OUTPUT\\_PROTOCOL](#). This summary assumes the graphics controller supports a single frame buffer. If a graphics device supports multiple frame buffers, then handles for the frame buffers must be created first, and then the handles for the video output devices can be created as children of the frame buffer handles.

Summary of Initialization Steps:

- "If *RemainingDevicePath* is **NULL** or the first Device Path Node is the End of Device Path Node, then [Supported\(\)](#) returns **EFI\_SUCCESS**. Otherwise, if the first node of *RemainingDevicePath* is not an ACPI \_ADR node or the first two nodes of *RemainingDevicePath* are not a Controller node followed by an ACPI \_ADR node, then [Supported\(\)](#) returns **EFI\_UNSUPPORTED**.
- "If [Supported\(\)](#) returned **EFI\_SUCCESS**, system calls [Start\(\)](#).
- "If *RemainingDevicePath* is **NULL**, then a default set of active video output devices are selected by the driver.
- "If the first Device Path Node of *RemainingDevicePath* is the End of Device Path Node, then skip to the "The EFI Driver must provide [EFI\\_COMPONENT\\_NAME2\\_PROTOCOL](#)" step.
- [Start\(\)](#) function creates a *ChildHandle* for each physical video output device and installs the [EFI\\_DEVICE\\_PATH\\_PROTOCOL](#) onto the created *ChildHandle*. The [EFI\\_DEVICE\\_PATH\\_PROTOCOL](#) is constructed by appending an ACPI \_ADR device path node describing the physical video output device to the end of the device path installed on the *ControllerHandle* passed into [Start\(\)](#).
- [Start\(\)](#)function retrieves EDID information for each physical video output device and installs the [EFI\\_EDID\\_DISCOVERED\\_PROTOCOL](#) onto the *ChildHandle* for each physical video output device. If no EDID data is available from the video output device, then *SizeOfEdid* is set to zero, and *Edid* is set to **NULL**.
- [Start\(\)](#)function create a *ChildHandle* for each valid combination of two or more video output devices, and installs the [EFI\\_DEVICE\\_PATH\\_PROTOCOL](#) onto the created *ChildHandle*. The [EFI\\_DEVICE\\_PATH\\_PROTOCOL](#) is constructed by appending an

ACPI \_ADR device path node describing the combination of video output devices to the end of the device path installed on the *ControllerHandle* passed into **Start()**. The ACPI \_ADR entry can represent complex topologies of devices and it is possible to have more than one ACPI \_ADR entry in a single device path node. Support of complex video output device topologies is an optional feature.

- **Start()** function evaluates the *RemainingDevicePath* to select the set of active video output devices. If *RemainingDevicePath* is **NULL**, then **Start()** selects a default set of video output devices. If *RemainingDevicePath* is not **NULL**, and ACPI \_ADR device path node of *RemainingDevicePath* does not match any of the created *ChildHandles*, then **Start()** must destroy all its *ChildHandles* and return **EFI\_UNSUPPORTED**. Otherwise, **Start()** selects the set of active video output devices specified by the ACPI \_ADR device path node in *RemainingDevicePath*.
- **Start()** retrieves the *ChildHandle* associated with each active video output device. Only *ChildHandles* that represent a physical video output device are considered. **Start()** calls the **EFI\_EDID\_OVERRIDE\_PROTOCOL.GetEdid()** service passing in *ChildHandle*. Depending on the return values from **GetEdid()**, either the override EDID information or the EDID information from the **EFI\_EDID\_DISCOVERED\_PROTOCOL** on *ChildHandle* is selected. See **GetEdid()** for a detailed description of this decision. The selected EDID information is used to produce the **EFI\_EDID\_ACTIVE\_PROTOCOL**, and that protocol is installed onto *ChildHandle*.
- **Start()** retrieves the one *ChildHandle* that represents the entire set of active video output devices. If this set is a single video output device, then this *ChildHandle* will be the same as the one used in the previous step. If this set is a combination of video output devices, then this will not be one of the *ChildHandles* used in the previous two steps. The **EFI\_GRAPHICS\_OUTPUT\_PROTOCOL** is installed onto this *ChildHandle*.
- The **QueryMode()** service of the **EFI\_GRAPHICS\_OUTPUT\_PROTOCOL** returns the set of modes that both the graphics controller and the set of active video output devices all support. If a different set of active video output device is selected, then a different set of modes will likely be produced by **QueryMode()**.
- **Start()** function optionally initializes video frame buffer hardware. The EFI driver has the option of delaying this operation until **SetMode()** is called.
- The EFI Driver must provide **EFI\_COMPONENT\_NAME2\_PROTOCOL** **GetControllerName()** support for *ControllerHandle* and all the *ChildHandles* created by this driver. The name returned for *ControllerHandle* must return the name of the graphics device. The name returned for each of the *ChildHandles* allow the user to pick output display settings and should be constructed with this in mind.
- The EFI Driver's **Stop()** function must cleanly undo what the **Start()** function created.
- An **EFI\_GRAPHICS\_OUTPUT\_PROTOCOL** must be implemented for every video frame buffer that exists on a video adapter. In most cases there will be a single **EFI\_GRAPHICS\_OUTPUT\_PROTOCOL** placed on one of the children of the *ControllerHandle* passed into the **EFI\_DRIVER\_BINDING.Start()** function.

If a single PCI device/function contains multiple frame buffers the **EFI\_GRAPHICS\_OUTPUT\_PROTOCOL** must create child handles of the PCI handle that

inherit its PCI device path and appends a controller device path node. The handles for the video output devices are children of the handles that represent the frame buffers.

A video device can support an arbitrary number of geometries, but it must support one or more of the following modes to conform to this specification:

Onboard graphics device

- A mode required in a platform design guide
- Native mode of the display

Plug in graphics device

- A mode required in a platform design guide
- 800 x 600 with 32-bit color depth or 640 x 480 with 32-bit color depth and a pixel format described by **PixelRedGreenBlueReserved8BitPerColor** or **PixelBlueGreenRedReserved8BitPerColor**.

If graphics output device supports both landscape and portrait mode displays it must return a different mode via **QueryMode()**. For example landscape mode could be 800 horizontal and 600 vertical while the equivalent portrait mode would be 600 horizontal and 800 vertical.

## 13 Protocols — Media Access

---

### 13.1 Load File Protocol

The Load File protocol is designed to allow code running in the boot services environment to find and load other modules of code.

#### EFI\_LOAD\_FILE\_PROTOCOL

##### Summary

Used to obtain files from arbitrary devices.

##### GUID

```
#define EFI_LOAD_FILE_PROTOCOL_GUID \
{0x56EC3091,0x954C,0x11d2,\
{0x8e,0x3f,0x00,0xa0, 0xc9,0x69,0x72,0x3b}}
```

##### Protocol Interface Structure

```
typedef struct _EFI_LOAD_FILE_PROTOCOL {
    EFI_LOAD_FILE LoadFile;
} EFI_LOAD_FILE_PROTOCOL;
```

##### Parameters

*LoadFile*

Causes the driver to load the requested file. See the [LoadFile\(\)](#) function description.

##### Description

The **EFI\_LOAD\_FILE\_PROTOCOL** is a simple protocol used to obtain files from arbitrary devices.

When the firmware is attempting to load a file, it first attempts to use the device's Simple File System protocol to read the file. If the file system protocol is found, the firmware implements the policy of interpreting the File Path value of the file being loaded. If the device does not support the file system protocol, the firmware then attempts to read the file via the **EFI\_LOAD\_FILE\_PROTOCOL** and the **LoadFile()** function. In this case the **LoadFile()** function implements the policy of interpreting the File Path value.

## EFI\_LOAD\_FILE\_PROTOCOL.LoadFile()

### Summary

Causes the driver to load a specified file.

### Prototype

```
typedef
EFI_STATUS
(EFIAPI *EFI_LOAD_FILE) (
    IN EFI_LOAD_FILE_PROTOCOL *This,
    IN EFI_DEVICE_PATH_PROTOCOL *FilePath,
    IN BOOLEAN      BootPolicy,
    IN OUT UINTN    *BufferSize,
    IN VOID         *Buffer OPTIONAL
);
```

### Parameters

<i>This</i>	Indicates a pointer to the calling context. Type <a href="#">EFI_LOAD_FILE_PROTOCOL</a> is defined in <a href="#">Section 13.1</a> .
<i>FilePath</i>	The device specific path of the file to load. Type <a href="#">EFI_DEVICE_PATH_PROTOCOL</a> is defined in <a href="#">Section 10.2</a> .
<i>BootPolicy</i>	If <b>TRUE</b> , indicates that the request originates from the boot manager, and that the boot manager is attempting to load <i>FilePath</i> as a boot selection. If <b>FALSE</b> , then <i>FilePath</i> must match an exact file to be loaded.
<i>BufferSize</i>	On input the size of <i>Buffer</i> in bytes. On output with a return code of <b>EFI_SUCCESS</b> , the amount of data transferred to <i>Buffer</i> . On output with a return code of <b>EFI_BUFFER_TOO_SMALL</b> , the size of <i>Buffer</i> required to retrieve the requested file.
<i>Buffer</i>	The memory buffer to transfer the file to. If <i>Buffer</i> is <b>NULL</b> , then the size of the requested file is returned in <i>BufferSize</i> .

### Description

The **LoadFile()** function interprets the device-specific *FilePath* parameter, returns the entire file into *Buffer*, and sets *BufferSize* to the amount of data returned. If *Buffer* is **NULL**, then the size of the file is returned in *BufferSize*. If *Buffer* is not **NULL**, and *BufferSize* is not large enough to hold the entire file, then **EFI\_BUFFER\_TOO\_SMALL** is returned, and *BufferSize* is updated to indicate the size of the buffer needed to obtain the file. In this case, no data is returned in *Buffer*.

If *BootPolicy* is **FALSE** the *FilePath* must match an exact file to be loaded. If no such file exists, **EFI\_NOT\_FOUND** is returned. If *BootPolicy* is **FALSE**, and an attempt is being made to perform a network boot through the PXE Base Code protocol, **EFI\_UNSUPPORTED** is returned.

If *BootPolicy* is **TRUE** the firmware's boot manager is attempting to load an EFI image that is a boot selection. In this case, *FilePath* contains the file path value in the boot selection option. Normally the firmware would implement the policy on how to handle an inexact boot file path; however, since in this case the firmware cannot interpret the file path, the **LoadFile()** function is responsible for implementing the policy. For example, in the case of a network boot through the PXE Base Code protocol, *FilePath* merely points to the root of the device, and the firmware interprets this as wanting to boot from the first valid loader. The following is a list of events that **LoadFile()** will implement for a PXE boot:

- Perform DHCP.
- Optionally prompt the user with a menu of boot selections.
- Discover the boot server and the boot file.
- Download the boot file into *Buffer* and update *BufferSize* with the size of the boot file.

If the boot file downloaded from boot server is not a UEFI-formatted executable, but a binary image which contains a UEFI-compliant file system, then **EFI\_WARN\_FILE\_SYSTEM** is returned, and a new RAM disk mapped on the returned *Buffer* is registered.

### Status Codes Returned

EFI_SUCCESS	The file was loaded.
EFI_UNSUPPORTED	The device does not support the provided <i>BootPolicy</i> .
EFI_INVALID_PARAMETER	<i>FilePath</i> is not a valid device path, or <i>BufferSize</i> is <b>NULL</b> .
EFI_NO_MEDIA	No medium was present to load the file.
EFI_DEVICE_ERROR	The file was not loaded due to a device error.
EFI_NO_RESPONSE	The remote system did not respond.
EFI_NOT_FOUND	The file was not found.
EFI_ABORTED	The file load process was manually cancelled.
EFI_BUFFER_TOO_SMALL	The <i>BufferSize</i> is too small to read the current directory entry. <i>BufferSize</i> has been updated with the size needed to complete the request.
EFI_WARN_FILE_SYSTEM	The resulting <i>Buffer</i> contains UEFI-compliant file system.

## 13.2 Load File 2 Protocol

The Load File 2 protocol is used to obtain files from arbitrary devices that are not boot options.

### EFI\_LOAD\_FILE2\_PROTOCOL

#### Summary

Used to obtain files from arbitrary devices but are not used as boot options.

## GUID

```
#define EFI_LOAD_FILE2_PROTOCOL_GUID \
{ 0x4006c0c1, 0xfcb3, 0x403e, \
  { 0x99, 0x6d, 0x4a, 0x6c, 0x87, 0x24, 0xe0, 0x6d } }
```

## Protocol Interface Structure

```
typedef EFI_LOAD_FILE_PROTOCOL EFI_LOAD_FILE2_PROTOCOL;
```

## Parameters

### *LoadFile*

Causes the driver to load the requested file. See the **LoadFile()** functional description.

## Description

The **EFI\_LOAD\_FILE2\_PROTOCOL** is a simple protocol used to obtain files from arbitrary devices that are not boot options. It is used by **LoadImage()** when its *BootOption* parameter is **FALSE** and the *FilePath* does not have an instance of the **EFI\_SIMPLE\_FILE\_SYSTEM\_PROTOCOL**.



## EFI\_LOAD\_FILE2\_PROTOCOL.LoadFile()

### Summary

Causes the driver to load a specified file.

### Prototype

The same prototype as **EFI\_LOAD\_FILE\_PROTOCOL.LoadFile()**.

### Parameters

#### *This*

Indicates a pointer to the calling context.

#### *FilePath*

The device specific path of the file to load.

#### *BootPolicy*

Should always be **FALSE**.

#### *BufferSize*

On input the size of *Buffer* in bytes. On output with a return code of **EFI\_SUCCESS**, the amount of data transferred to *Buffer*. On output with a return code of **EFI\_BUFFER\_TOO\_SMALL**, the size of *Buffer* required to retrieve the requested file.

#### *Buffer*

The memory buffer to transfer the file to. If *Buffer* is **NULL**, then no the size of the requested file is returned in *BufferSize*.

### Description

The **LoadFile()** function interprets the device-specific *FilePath* parameter, returns the entire file into *Buffer*, and sets *BufferSize* to the amount of data returned. If *Buffer* is **NULL**, then the size of the file is returned in *BufferSize*. If *Buffer* is not **NULL**, and *BufferSize* is not large enough to hold the entire file, then **EFI\_BUFFER\_TOO\_SMALL** is returned, and *BufferSize* is updated to indicate the size of the buffer needed to obtain the file. In this case, no data is returned in *Buffer*.

*FilePath* contains the file path value in the boot selection option. Normally the firmware would implement the policy on how to handle an inexact boot file path; however, since in this case the firmware cannot interpret the file path, the **LoadFile()** function is responsible for implementing the policy.

## Status Codes Returned

EFI_SUCCESS	The file was loaded.
EFI_UNSUPPORTED	BootPolicy is TRUE.
EFI_INVALID_PARAMETER	FilePath is not a valid device path, or BufferSize is NULL.
EFI_NO_MEDIA	No medium was present to load the file.
EFI_DEVICE_ERROR	The file was not loaded due to a device error.
EFI_NO_RESPONSE	The remote system did not respond.
EFI_NOT_FOUND	The file was not found.
EFI_ABORTED	The file load process was manually cancelled.
EFI_BUFFER_TOO_SMALL	The BufferSize is too small to read the current directory entry. BufferSize has been updated with the size needed to complete the request.

## 13.3 File System Format

The file system supported by the Extensible Firmware Interface is based on the FAT file system. EFI defines a specific version of FAT that is explicitly documented and testable. Conformance to the EFI specification and its associate reference documents is the only definition of FAT that needs to be implemented to support EFI. To differentiate the EFI file system from pure FAT, a new partition file system type has been defined.

EFI encompasses the use of FAT32 for a system partition, and FAT12 or FAT16 for removable media. The FAT32 system partition is identified by an OSType value other than that used to identify previous versions of FAT. This unique partition type distinguishes an EFI defined file system from a normal FAT file system. The file system supported by EFI includes support for long file names.

The definition of the EFI file system will be maintained by specification and will not evolve over time to deal with errata or variant interpretations in OS file system drivers or file system utilities. Future enhancements and compatibility enhancements to FAT will not be automatically included in EFI file systems. The EFI file system is a target that is fixed by the EFI specification, and other specifications explicitly referenced by the EFI specification.

For more information about the EFI file system and file image format, visit the web site from which this document was obtained.

### 13.3.1 System Partition

A System Partition is a partition in the conventional sense of a partition on a legacy system. For a hard disk, a partition is a contiguous grouping of sectors on the disk where the starting sector and size are defined by the Master Boot Record (MBR), which resides on LBA 0 (i.e., the first sector of the hard disk) (see [Section 5.2](#)), or the GUID Partition Table (GPT), which resides on logical block 1 (the second sector of the hard disk) (see [Section 5.3.1](#)). For a diskette (floppy) drive, a partition is defined to be the entire media. A System Partition can reside on any media that is supported by EFI Boot Services.

A System Partition supports backward compatibility with legacy systems by reserving the first block (sector) of the partition for compatibility code. On legacy systems, the first block (sector) of a partition is loaded into memory and execution is transferred to this code. EFI firmware does not execute the code in the MBR. The EFI firmware contains knowledge about the partition structure of various devices, and can understand legacy MBR, GPT, and “El Torito.”

The System Partition contains directories, data files, and UEFI Images. UEFI Images can contain a OS Loader, an driver to extend platform firmware capability, or an application that provides a transient service to the system. Applications written to this specification could include things such as a utility to create partitions or extended diagnostics. A System Partition can also support data files, such as error logs, that can be defined and used by various OS or system firmware software components.

### 13.3.1.1 File System Format

The first block (sector) of a partition contains a data structure called the BIOS Parameter Block (BPB) that defines the type and location of FAT file system on the drive. The BPB contains a data structure that defines the size of the media, the size of reserved space, the number of FAT tables, and the location and size of the root directory (not used in FAT32). The first block (sector) also contains code that will be executed as part of the boot process on a legacy system. This code in the first block (sector) usually contains code that can read a file from the root directory into memory and transfer control to it. Since EFI firmware contains a file system driver, EFI firmware can load any file from the file system with out needing to execute any code from the media.

The EFI firmware must support the FAT32, FAT16, and FAT12 variants of the EFI file system. What variant of EFI FAT to use is defined by the size of the media. The rules defining the relationship between media size and FAT variants is defined in the specification for the EFI file system.

The UEFI system partition FAT32 Data region should be aligned to the physical block boundary and optimal transfer length granularity of the device(see [Section 5.3.1](#)). This is controlled by the BPB\_RsvdSecCnt field and the applicable BPB\_FATSz field (e.g., formatting software may set the BPB\_RsvdSecCnt field to a value that results in alignment and/or may set the BPB\_FATSz field to a value that ensures alignment).

### 13.3.1.2 File Names

FAT stores file names in two formats. The original FAT format limited file names to eight characters with three extension characters. This type of file name is called an 8.3, pronounced eight dot three, file name. FAT was extended to include support for long file names (LFN).

FAT 8.3 file names are always stored as uppercase ASCII characters. LFN can either be stored as ASCII or UCS-2 characters and are stored case sensitive. The string that was used to open or create the file is stored directly into LFN. FAT defines that all files in a directory must have a unique name, and unique is defined as a case insensitive match. The following are examples of names that are considered to be the same and cannot exist in a single directory:

- “ThisIsAnExampleDirectory.Dir”

- "thisisanexamppledirectory.dir"
- THISISANEXAMPLEDIRECTORY.DIR
- ThisIsAnExampleDirectory.DIR

**Note:** *Although the FAT32 specification allows file names to be encoded using UTF-16, this specification only recognizes the UCS-2 subset for the purposes of sorting or collation.*

### 13.3.1.3 Directory Structure

An EFI system partition that is present on a hard disk must contain an EFI defined directory in the root directory. This directory is named **EFI**. All OS loaders and applications will be stored in subdirectories below **EFI**. Applications that are loaded by other applications or drivers are not required to be stored in any specific location in the EFI system partition. The choice of the subdirectory name is up to the vendor, but all vendors must pick names that do not collide with any other vendor's subdirectory name. This applies to system manufacturers, operating system vendors, BIOS vendors, and third party tool vendors, or any other vendor that wishes to install files on an EFI system partition. There must also only be one executable EFI image for each supported processor architecture in each vendor subdirectory. This guarantees that there is only one image that can be loaded from a vendor subdirectory by the EFI Boot Manager. If more than one executable EFI image is present, then the boot behavior for the system will not be deterministic. There may also be an optional vendor subdirectory called **BOOT**.

This directory contains EFI images that aide in recovery if the boot selections for the software installed on the EFI system partition are ever lost. Any additional UEFI-compliant executables must be in subdirectories below the vendor subdirectory. The following is a sample directory structure for an EFI system partition present on a hard disk.

```

\EFI
  \<OS Vendor 1 Directory>
    <OS Loader Image>
  \<OS Vendor 2 Directory>
    <OS Loader Image>
  ...
  \<OS Vendor N Directory>
    <OS Loader Image>
  \<OEM Directory>
    <OEM Application Image>
  \<BIOS Vendor Directory>
    <BIOS Vendor Application Image>
  \<Third Party Tool Vendor Directory>
    <Third Party Tool Vendor Application Image>
\BOOT
  BOOT{machine type short name}.EFI
    
```

For removable media devices there must be only one UEFI-compliant system partition, and that partition must contain an UEFI-defined directory in the root directory. The directory will be named **EFI**. All OS loaders and applications will be stored in a subdirectory below **EFI** called **BOOT**. There must only be one executable EFI image for

each supported processor architecture in the **BOOT** directory. For removable media to be bootable under EFI, it must be built in accordance with the rules laid out in [Section 3.5.1.1](#). This guarantees that there is only one image that can be automatically loaded from a removable media device by the EFI Boot Manager. Any additional EFI executables must be in directories other than **BOOT**. The following is a sample directory structure for an EFI system partition present on a removable media device.

```

\EFI
  \BOOT
    BOOT{machine type short name}.EFI
  
```

### 13.3.2 Partition Discovery

This specification requires the firmware to be able to parse the legacy master boot record (MBR) (see [Section 5.2.1](#)), GUID Partition Table (GPT) (see [Section 5.3.1](#)), and El Torito (see [Section 13.3.2.1](#)) logical device volumes. The EFI firmware produces a logical **EFI\_BLOCK\_IO\_PROTOCOL** device for:

- each GUID Partition Entry (see table 16 in 5.3.3) with bit 1 set to zero;
- each El Torito logical device volume; and
- if no GPT is present, each partition found in the legacy MBR partition tables.

LBA zero of the **EFI\_BLOCK\_IO\_PROTOCOL** device will correspond to the first logical block of the partition. See [Figure 35](#). If a GPT Partition Entry has Attribute bit 1 set then a logical **EFI\_BLOCK\_IO\_PROTOCOL** device must not be created.

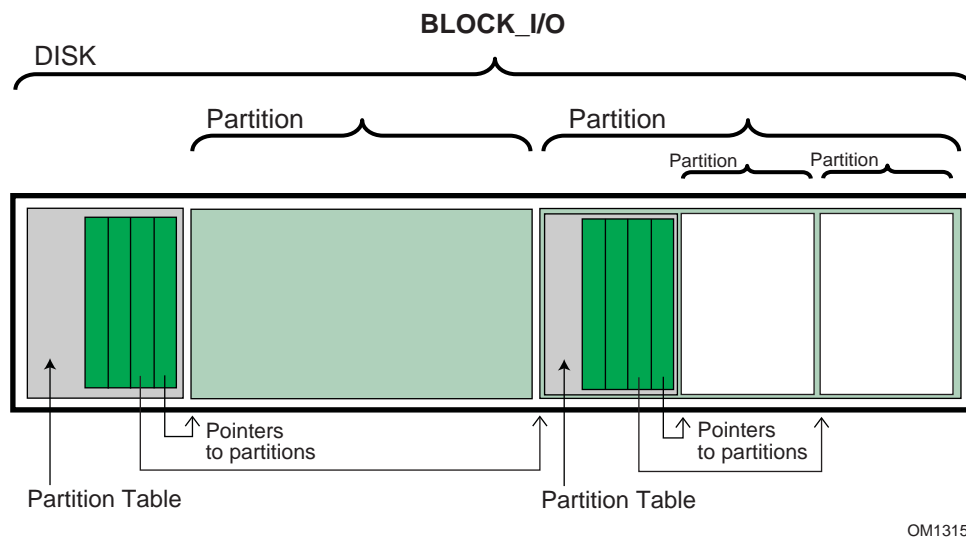

**Figure 35. Nesting of Legacy MBR Partition Records**

The following is the order in which a block device must be scanned to determine if it contains partitions. When a check for a valid partitioning scheme succeeds, the search terminates.

1. Check for GUID Partition Table Headers.

2. Follow ISO-9660 specification to search for ISO-9660 volume structures on the magic LBA.
3. Check for an “El Torito” volume extension and follow the “El Torito” CD-ROM specification.
4. If none of the above, check LBA 0 for a legacy MBR partition table.
5. No partition found on device.

If a disk contains a recognized RAID structure (e.g. DDF structure as defined in *The Storage Networking Industry Association Common RAID Disk Data Format Specification*—see Glossary), the data on the disk must be ignored, unless the driver is using the RAID structure to produce a logical RAID volume.

EFI supports the nesting of legacy MBR partitions, by allowing any legacy MBR partition to contain more legacy MBR partitions. This is accomplished by supporting the same partition discovery algorithm on every logical block device. It should be noted that the GUID Partition Table does not allow nesting of GUID Partition Table Headers. Nesting is not needed since a GUID Partition Table Header can support an arbitrary number of partitions (the addressability limits of a 64-bit LBA are the limiting factor).

### 13.3.2.1 ISO-9660 and El Torito

ISO-9660 is the industry standard low level format used on CD-ROM and DVD-ROM. The CD-ROM format is completely described by the “El Torito” Bootable CD-ROM Format Specification Version 1.0. To boot from a CD-ROM or DVD-ROM in the boot services environment, an EFI System partition is stored in a “no emulation” mode as defined by the “El Torito” specification. A Platform ID of 0xEF indicates an EFI System Partition. The Platform ID is in either the Section Header Entry or the Validation Entry of the Booting Catalog as defined by the “El Torito” specification. EFI differs from “El Torito” “no emulation” mode in that it does not load the “no emulation” image into memory and jump to it. EFI interprets the “no emulation” image as an EFI system partition. EFI interprets the Sector Count in the Initial/Default Entry or the Section Header Entry to be the size of the EFI system partition. If the value of Sector Count is set to 0 or 1, EFI will assume the system partition consumes the space from the beginning of the “no emulation” image to the end of the CD-ROM.

DVD-ROM images formatted as required by the UDF 2.0 specification (*OSTA Universal Disk Format Specification*, Revision 2.0) can be booted by EFI. EFI supports booting from an ISO-9660 file system that conforms to the “El Torito” Bootable CD-ROM Format Specification on a DVD-ROM. A DVD-ROM that contains an ISO-9660 file system is defined as a “UDF Bridge” disk. Booting from CD-ROM and DVD-ROM is accomplished using the same methods.

Since the EFI file system definition does not use the same Initial/Default entry as a legacy CD-ROM it is possible to boot personal computers using an EFI CD-ROM or DVD-ROM. The inclusion of boot code for personal computers is optional and not required by EFI.

### 13.3.3 Number and Location of System Partitions

UEFI does not impose a restriction on the number or location of System Partitions that can exist on a system. System Partitions are discovered when required by UEFI firmware

by examining the partition GUID and verifying that the contents of the partition conform to the FAT file system as defined in [Section 13.3.1.1](#). Further, UEFI implementations may allow the use of conforming FAT partitions which do not use the ESP GUID. Partition creators may prevent UEFI firmware from examining and using a specific partition by setting bit 1 of the Partition Attributes (see 5.3.3) which will exclude the partition as a potential ESP.

Software installation may choose to create and locate an ESP on each target OS boot disk, or may choose to create a single ESP independent of the location of OS boot disks and OS partitions. It is outside of the scope of this specification to attempt to coordinate the specification of size and location of an ESP that can be shared by multiple OS or Diagnostics installations, or to manage potential namespace collisions in directory naming in a single (central) ESP.

### 13.3.4 Media Formats

This section describes how booting from different types of removable media is handled. In general the rules are consistent regardless of a media's physical type and whether it is removable or not.

#### 13.3.4.1 Removable Media

Removable media may contain a standard FAT12, FAT16, or FAT32 file system.

Booting from a removable media device can be accomplished the same way as any other boot. The boot file path provided to the boot manager can consist of a UEFI application image to load, or can merely be the path to a removable media device. In the first case, the path clearly indicates the image that is to be loaded. In the later case, the boot manager implements the policy to load the default application image from the device.

For removable media to be bootable under EFI, it must be built in accordance with the rules laid out in [Section 3.5.1.1](#)

#### 13.3.4.2 Diskette

EFI bootable diskettes follow the standard formatting conventions used on personal computers. The diskette contains only a single partition that complies to the EFI file system type. For diskettes to be bootable under EFI, it must be built in accordance with the rules laid out in [Section 3.5.1.1](#).

Since the EFI file system definition does not use the code in the first block of the diskette, it is possible to boot personal computers using a diskette that is also formatted as an EFI bootable removable media device. The inclusion of boot code for personal computers is optional and not required by EFI.

Diskettes include the legacy 3.5-inch diskette drives as well as the newer larger capacity removable media drives such as an Iomega\* Zip\*, Fujitsu MO, or MKE LS-120/SuperDisk\*.

#### 13.3.4.3 Hard Drive

Hard drives may contain multiple partitions as defined in [Section 13.3.2](#) on partition discovery. Any partition on the hard drive may contain a file system that the EFI firmware

recognizes. Images that are to be booted must be stored under the EFI subdirectory as defined in [Section 13.3.1](#) and [Section 13.3.2](#).

EFI code does not assume a fixed block size.

Since EFI firmware does not execute the MBR code and does not depend on the *BootIndicator* field in the legacy MBR partition records, the hard disk can still boot and function normally.

#### 13.3.4.4 CD-ROM and DVD-ROM

A CD-ROM or DVD-ROM may contain multiple partitions as defined [Section 13.3.1](#) and [Section 13.3.2](#) and in the “El Torito” specification.

EFI code does not assume a fixed block size.

Since the EFI file system definition does not use the same Initial/Default entry as a legacy CD-ROM, it is possible to boot personal computers using an EFI CD-ROM or DVD-ROM. The inclusion of boot code for personal computers is optional and not required by EFI.

#### 13.3.4.5 Network

To boot from a network device, the Boot Manager uses the Load File Protocol to perform a [LoadFile\(\)](#) on the network device. This uses the PXE Base Code Protocol to perform DHCP and Discovery. This may result in a list of possible boot servers along with the boot files available on each server. The Load File Protocol for a network boot may then optionally produce a menu of these selections for the user to choose from. If this menu is presented, it will always have a timeout, so the Load File Protocol can automatically boot the default boot selection. If there is only one possible boot file, then the Load File Protocol can automatically attempt to load the one boot file.

The Load File Protocol will download the boot file using the MFTFTP service in the PXE Base Code Protocol. The downloaded image must be an EFI image that the platform supports.

## 13.4 Simple File System Protocol

The Simple File System protocol allows code running in the EFI boot services environment to obtain file based access to a device.

**EFI\_SIMPLE\_FILE\_SYSTEM\_PROTOCOL** is used to open a device volume and return an [EFI\\_FILE\\_PROTOCOL](#) that provides interfaces to access files on a device volume.

### EFI\_SIMPLE\_FILE\_SYSTEM\_PROTOCOL

#### Summary

Provides a minimal interface for file-type access to a device.



## GUID

```
#define EFI_SIMPLE_FILE_SYSTEM_PROTOCOL_GUID \
{0x0964e5b22,0x6459,0x11d2,\
{0x8e,0x39,0x00,0xa0,0xc9,0x69,0x72,0x3b}}
```

## Revision Number

```
#define EFI_SIMPLE_FILE_SYSTEM_PROTOCOL_REVISION 0x00010000
```

## Protocol Interface Structure

```
typedef struct _EFI_SIMPLE_FILE_SYSTEM_PROTOCOL {
    UINT64          Revision;
    EFI_SIMPLE_FILE_SYSTEM_PROTOCOL_OPEN_VOLUME OpenVolume;
} EFI_SIMPLE_FILE_SYSTEM_PROTOCOL;
```

## Parameters

*Revision*

The version of the **EFI\_FILE\_PROTOCOL**. The version specified by this specification is 0x00010000. All future revisions must be backwards compatible. If a future version is not backwards compatible, it is not the same GUID.

*OpenVolume*

Opens the volume for file I/O access. See the [OpenVolume\(\)](#) function description.

## Description

The **EFI\_SIMPLE\_FILE\_SYSTEM\_PROTOCOL** provides a minimal interface for file-type access to a device. This protocol is only supported on some devices.

Devices that support the Simple File System protocol return an **EFI\_FILE\_PROTOCOL**. The only function of this interface is to open a handle to the root directory of the file system on the volume. Once opened, all accesses to the volume are performed through the volume's file handles, using the [EFI FILE PROTOCOL](#) protocol. The volume is closed by closing all the open file handles.

The firmware automatically creates handles for any block device that supports the following file system formats:

- FAT12
- FAT16
- FAT32

## EFI\_SIMPLE\_FILE\_SYSTEM\_PROTOCOL.OpenVolume()

### Summary

Opens the root directory on a volume.

### Prototype

```
typedef
EFI_STATUS
(EFIAPI *EFI_SIMPLE_FILE_SYSTEM_PROTOCOL_OPEN_VOLUME) (
    IN EFI_SIMPLE_FILE_SYSTEM_PROTOCOL      *This,
    OUT EFI_FILE_PROTOCOL                   **Root
);
```

### Parameters

<i>This</i>	A pointer to the volume to open the root directory of. See the type <a href="#">EFI_SIMPLE_FILE_SYSTEM_PROTOCOL</a> description.
<i>Root</i>	A pointer to the location to return the opened file handle for the root directory. See the type <a href="#">EFI_FILE_PROTOCOL</a> description.

### Description

The **OpenVolume()** function opens a volume, and returns a file handle to the volume's root directory. This handle is used to perform all other file I/O operations. The volume remains open until all the file handles to it are closed.

If the medium is changed while there are open file handles to the volume, all file handles to the volume will return **EFI\_MEDIA\_CHANGED**. To access the files on the new medium, the volume must be reopened with **OpenVolume()**. If the new medium is a different file system than the one supplied in the **EFI\_HANDLE**'s **DevicePath** for the **EFI\_SIMPLE\_FILE\_SYSTEM\_PROTOCOL**, **OpenVolume()** will return **EFI\_UNSUPPORTED**.

## Status Codes Returned

EFI_SUCCESS	The file volume was opened.
EFI_UNSUPPORTED	The volume does not support the requested file system type.
EFI_NO_MEDIA	The device has no medium.
EFI_DEVICE_ERROR	The device reported an error.
EFI_VOLUME_CORRUPTED	The file system structures are corrupted.
EFI_ACCESS_DENIED	The service denied access to the file.
EFI_OUT_OF_RESOURCES	The file volume was not opened.
EFI_MEDIA_CHANGED	The device has a different medium in it or the medium is no longer supported. Any existing file handles for this volume are no longer valid. To access the files on the new medium, the volume must be reopened with <b>OpenVolume ( )</b> .

## 13.5 File Protocol

The protocol and functions described in this section support access to EFI-supported file systems.

### EFI\_FILE\_PROTOCOL

#### Summary

Provides file based access to supported file systems.

## Revision Number

```
#define EFI_FILE_PROTOCOL_REVISION  0x00010000
#define EFI_FILE_PROTOCOL_REVISION2 0x00020000
#define EFI_FILE_PROTOCOL_LATEST_REVISION
EFI_FILE_PROTOCOL_REVISION2
```

## Protocol Interface Structure

```
typedef struct _EFI_FILE_PROTOCOL {
  UINT64      Revision;
  EFI_FILE_OPEN  Open;
  EFI_FILE_CLOSE Close;
  EFI_FILE_DELETE Delete;
  EFI_FILE_READ  Read;
  EFI_FILE_WRITE Write;
  EFI_FILE_GET_POSITION GetPosition;
  EFI_FILE_SET_POSITION SetPosition;
  EFI_FILE_GET_INFO GetInfo;
  EFI_FILE_SET_INFO SetInfo;
  EFI_FILE_FLUSH Flush;
  EFI_FILE_OPEN_EX  OpenEx; // Added for revision 2
  EFI_FILE_READ_EX  ReadEx; // Added for revision 2
  EFI_FILE_WRITE_EX WriteEx; // Added for revision 2
  EFI_FILE_FLUSH_EX FlushEx; // Added for revision 2
} EFI_FILE_PROTOCOL;
```

## Parameters

<i>Revision</i>	The version of the <b>EFI_FILE_PROTOCOL</b> interface. The version specified by this specification is <b>EFI_FILE_PROTOCOL_LATEST_REVISION</b> . Future versions are required to be backward compatible to version 1.0.
<i>Open</i>	Opens or creates a new file. See the <a href="#">Open()</a> function description.
<i>Close</i>	Closes the current file handle. See the <a href="#">Close()</a> function description.
<i>Delete</i>	Deletes a file. See the <a href="#">Delete()</a> function description.
<i>Read</i>	Reads bytes from a file. See the <a href="#">Read()</a> function description.
<i>Write</i>	Writes bytes to a file. See the <a href="#">Write()</a> function description.
<i>GetPosition</i>	Returns the current file position. See the <a href="#">GetPosition()</a> function description.
<i>SetPosition</i>	Sets the current file position. See the <a href="#">SetPosition()</a> function description.

<i>GetInfo</i>	Gets the requested file or volume information. See the <a href="#">GetInfo()</a> function description.
<i>SetInfo</i>	Sets the requested file information. See the <a href="#">SetInfo()</a> function description.
<i>Flush</i>	Flushes all modified data associated with the file to the device. See the <a href="#">Flush()</a> function description.
<i>OpenEx</i>	Opens a new file relative to the source directory's location.
<i>ReadEx</i>	Reads data from a file.
<i>WriteEx</i>	Writes data to a file.
<i>FlushEx</i>	Flushes all modified data associated with a file to a device.

## Description

The **EFI\_FILE\_PROTOCOL** provides file IO access to supported file systems.

An **EFI\_FILE\_PROTOCOL** provides access to a file's or directory's contents, and is also a reference to a location in the directory tree of the file system in which the file resides. With any given file handle, other files may be opened relative to this file's location, yielding new file handles.

On requesting the file system protocol on a device, the caller gets the **EFI\_FILE\_PROTOCOL** to the volume. This interface is used to open the root directory of the file system when needed. The caller must [Close\(\)](#) the file handle to the root directory, and any other opened file handles before exiting. While there are open files on the device, usage of underlying device protocol(s) that the file system is abstracting must be avoided. For example, when a file system that is layered on a [EFI\\_DISK\\_IO\\_PROTOCOL](#) / [EFI\\_BLOCK\\_IO\\_PROTOCOL](#), direct block access to the device for the blocks that comprise the file system must be avoided while there are open file handles to the same device.

A file system driver may cache data relating to an open file. A [Flush\(\)](#) function is provided that flushes all dirty data in the file system, relative to the requested file, to the physical medium. If the underlying device may cache data, the file system must inform the device to flush as well.

Implementations must account for cases where there is pending queued asynchronous I/O when a call is received on a blocking protocol interface. In these cases the pending I/O will be processed and completed before the blocking function is executed so that operation are carried out in the order they were requested.

## EFI\_FILE\_PROTOCOL.Open()

### Summary

Opens a new file relative to the source file's location.

### Prototype

```
typedef
EFI_STATUS
(EFI_API *EFI_FILE_OPEN) (
  IN EFI_FILE_PROTOCOL *This,
  OUT EFI_FILE_PROTOCOL **NewHandle,
  IN CHAR16 *FileName,
  IN UINT64 OpenMode,
  IN UINT64 Attributes
);
```

### Parameters

<i>This</i>	A pointer to the <a href="#">EFI_FILE_PROTOCOL</a> instance that is the file handle to the source location. This would typically be an open handle to a directory. See the type <a href="#">EFI_FILE_PROTOCOL</a> description.
<i>NewHandle</i>	A pointer to the location to return the opened handle for the new file. See the type <a href="#">EFI_FILE_PROTOCOL</a> description.
<i>FileName</i>	The Null-terminated string of the name of the file to be opened. The file name may contain the following path modifiers: "\", ".", and "..".
<i>OpenMode</i>	The mode to open the file. The only valid combinations that the file may be opened with are: Read, Read/Write, or Create/Read/Write. See "Related Definitions" below.
<i>Attributes</i>	Only valid for <a href="#">EFI_FILE_MODE_CREATE</a> , in which case these are the attribute bits for the newly created file. See "Related Definitions" below.

## Related Definitions

```

//*****
// Open Modes
//*****
#define EFI_FILE_MODE_READ  0x0000000000000001
#define EFI_FILE_MODE_WRITE 0x0000000000000002
#define EFI_FILE_MODE_CREATE 0x8000000000000000

//*****
// File Attributes
//*****
#define EFI_FILE_READ_ONLY  0x0000000000000001
#define EFI_FILE_HIDDEN     0x0000000000000002
#define EFI_FILE_SYSTEM     0x0000000000000004
#define EFI_FILE_RESERVED  0x0000000000000008
#define EFI_FILE_DIRECTORY 0x0000000000000010
#define EFI_FILE_ARCHIVE   0x0000000000000020
#define EFI_FILE_VALID_ATTR 0x0000000000000037

```

## Description

The **Open()** function opens the file or directory referred to by *FileName* relative to the location of *This* and returns a *NewHandle*. The *FileName* may include the following path modifiers:

“\”	If the filename starts with a “\” the relative location is the root directory that <i>This</i> resides on; otherwise “\” separates name components. Each name component is opened in turn, and the handle to the last file opened is returned.
“.”	Opens the current location.
“..”	Opens the parent directory for the current location. If the location is the root directory the request will return an error, as there is no parent directory for the root directory.

If **EFI\_FILE\_MODE\_CREATE** is set, then the file is created in the directory. If the final location of *FileName* does not refer to a directory, then the operation fails. If the file does not exist in the directory, then a new file is created. If the file already exists in the directory, then the existing file is opened.

If the medium of the device changes, all accesses (including the File handle) will result in **EFI\_MEDIA\_CHANGED**. To access the new medium, the volume must be reopened.

## Status Codes Returned

EFI_SUCCESS	The file was opened.
EFI_NOT_FOUND	The specified file could not be found on the device.
EFI_NO_MEDIA	The device has no medium.
EFI_MEDIA_CHANGED	The device has a different medium in it or the medium is no longer supported.

EFI_DEVICE_ERROR	The device reported an error.
EFI_VOLUME_CORRUPTED	The file system structures are corrupted.
EFI_WRITE_PROTECTED	An attempt was made to create a file, or open a file for write when the media is write-protected.
EFI_ACCESS_DENIED	The service denied access to the file.
EFI_OUT_OF_RESOURCES	Not enough resources were available to open the file.
EFI_VOLUME_FULL	The volume is full.



## EFI\_FILE\_PROTOCOL.Close()

### Summary

Closes a specified file handle.

### Prototype

```
typedef
EFI_STATUS
(EFIAPI *EFI_FILE_CLOSE) (
  IN EFI_FILE_PROTOCOL *This
);
```

### Parameters

*This*

A pointer to the [EFI\\_FILE\\_PROTOCOL](#) instance that is the file handle to close. See the type [EFI\\_FILE\\_PROTOCOL](#) description.

### Description

The **Close()** function closes a specified file handle. All “dirty” cached file data is flushed to the device, and the file is closed. In all cases the handle is closed. The operation will wait for all pending asynchronous I/O requests to complete before completing.

### Status Codes Returned

EFI_SUCCESS	The file was closed.
-------------	----------------------

## EFI\_FILE\_PROTOCOL.Delete()

### Summary

Closes and deletes a file.

### Prototype

```
typedef
EFI_STATUS
(EFI_API *EFI_FILE_DELETE) (
    IN EFI_FILE_PROTOCOL *This
);
```

### Parameters

*This*

A pointer to the [EFI\\_FILE\\_PROTOCOL](#) instance that is the handle to the file to delete. See the type [EFI\\_FILE\\_PROTOCOL](#) description.

### Description

The **Delete()** function closes and deletes a file. In all cases the file handle is closed. If the file cannot be deleted, the warning code **EFI\_WARN\_DELETE\_FAILURE** is returned, but the handle is still closed.

### Status Codes Returned

EFI_SUCCESS	The file was closed and deleted, and the handle was closed.
EFI_WARN_DELETE_FAILURE	The handle was closed, but the file was not deleted.

## EFI\_FILE\_PROTOCOL.Read()

### Summary

Reads data from a file.

### Prototype

```
typedef
EFI_STATUS
(EFIAPI *EFI_FILE_READ) (
  IN EFI_FILE_PROTOCOL *This,
  IN OUT UINTN *BufferSize,
  OUT VOID *Buffer
);
```

### Parameters

<i>This</i>	A pointer to the <a href="#">EFI_FILE_PROTOCOL</a> instance that is the file handle to read data from. See the type <a href="#">EFI_FILE_PROTOCOL</a> description.
<i>BufferSize</i>	On input, the size of the <i>Buffer</i> . On output, the amount of data returned in <i>Buffer</i> . In both cases, the size is measured in bytes.
<i>Buffer</i>	The buffer into which the data is read.

### Description

The [Read\(\)](#) function reads data from a file.

If *This* is not a directory, the function reads the requested number of bytes from the file at the file's current position and returns them in *Buffer*. If the read goes beyond the end of the file, the read length is truncated to the end of the file. The file's current position is increased by the number of bytes returned.

If *This* is a directory, the function reads the directory entry at the file's current position and returns the entry in *Buffer*. If the *Buffer* is not large enough to hold the current directory entry, then [EFI\\_BUFFER\\_TOO\\_SMALL](#) is returned and the current file position is *not* updated. *BufferSize* is set to be the size of the buffer needed to read the entry. On success, the current position is updated to the next directory entry. If there are no more directory entries, the read returns a zero-length buffer. [EFI\\_FILE\\_INFO](#) is the structure returned as the directory entry.

### Status Codes Returned

EFI_SUCCESS	The data was read.
EFI_NO_MEDIA	The device has no medium.
EFI_DEVICE_ERROR	The device reported an error.
EFI_DEVICE_ERROR	An attempt was made to read from a deleted file.
EFI_DEVICE_ERROR	On entry, the current file position is beyond the end of the file.

EFI_VOLUME_CORRUPTED	The file system structures are corrupted.
EFI_BUFFER_TOO_SMALL	The <i>BufferSize</i> is too small to read the current directory entry. <i>BufferSize</i> has been updated with the size needed to complete the request.

## EFI\_FILE\_PROTOCOL.Write()

### Summary

Writes data to a file.

### Prototype

```
typedef
EFI_STATUS
(EFIAPI *EFI_FILE_WRITE) (
  IN EFI_FILE_PROTOCOL *This,
  IN OUT UINTN *BufferSize,
  IN VOID *Buffer
);
```

### Parameters

<i>This</i>	A pointer to the <a href="#">EFI_FILE_PROTOCOL</a> instance that is the file handle to write data to. See the type <a href="#">EFI_FILE_PROTOCOL</a> description.
<i>BufferSize</i>	On input, the size of the <i>Buffer</i> . On output, the amount of data actually written. In both cases, the size is measured in bytes.
<i>Buffer</i>	The buffer of data to write.

### Description

The **Write()** function writes the specified number of bytes to the file at the current file position. The current file position is advanced the actual number of bytes written, which is returned in *BufferSize*. Partial writes only occur when there has been a data error during the write attempt (such as “file space full”). The file is automatically grown to hold the data if required.

Direct writes to opened directories are not supported.

### Status Codes Returned

EFI_SUCCESS	The data was written.
EFI_UNSUPPORTED	Writes to open directory files are not supported.
EFI_NO_MEDIA	The device has no medium.
EFI_DEVICE_ERROR	The device reported an error.
EFI_DEVICE_ERROR	An attempt was made to write to a deleted file.
EFI_VOLUME_CORRUPTED	The file system structures are corrupted.
EFI_WRITE_PROTECTED	The file or medium is write-protected.
EFI_ACCESS_DENIED	The file was opened read only.
EFI_VOLUME_FULL	The volume is full.

## EFI\_FILE\_PROTOCOL.OpenEx()

### Summary

Opens a new file relative to the source directory's location.

### Prototype

```
typedef
EFI_STATUS
(EFIAPI *EFI_FILE_OPEN) (
  IN EFI_FILE_PROTOCOL  *This,
  OUT EFI_FILE_PROTOCOL **NewHandle,
  IN CHAR16             *FileName,
  IN UINT64             OpenMode,
  IN UINT64             Attributes,
  IN OUT EFI_FILE_IO_TOKEN *Token
);
```

### Parameters

<i>This</i>	A pointer to the <b>EFI_FILE_PROTOCOL</b> instance that is the file handle to read data from. See the type <b>EFI_FILE_PROTOCOL</b> description.
<i>NewHandle</i>	A pointer to the location to return the opened handle for the new file. See the type <b>EFI_FILE_PROTOCOL</b> description. For asynchronous I/O, this pointer must remain valid for the duration of the asynchronous operation.
<i>FileName</i>	The Null-terminated string of the name of the file to be opened. The file name may contain the following path modifiers: "\", ".", and "..".
<i>OpenMode</i>	The mode to open the file. The only valid combinations that the file may be opened with are: Read, Read/Write, or Create/Read/Write. See "Related Definitions" below.
<i>Attributes</i>	Only valid for <b>EFI_FILE_MODE_CREATE</b> , in which case these are the attribute bits for the
<i>Token</i>	A pointer to the token associated with the transaction. Type <b>EFI_FILE_IO_TOKEN</b> is defined in "Related Definitions" below.

### Description

The **OpenEx()** function opens the file or directory referred to by *FileName* relative to the location of *This* and returns a *NewHandle*. The *FileName* may include the path modifiers described previously in **Open()**.

If **EFI\_FILE\_MODE\_CREATE** is set, then the file is created in the directory. If the final location of *FileName* does not refer to a directory, then the operation fails. If the file does

not exist in the directory, then a new file is created. If the file already exists in the directory, then the existing file is opened.

If the medium of the device changes, all accesses (including the *File* handle) will result in **EFI\_MEDIA\_CHANGED**. To access the new medium, the volume must be reopened.

If an error is returned from the call to **OpenEx()** and non-blocking I/O is being requested, the *Event* associated with this request will not be signaled. If the call to **OpenEx()** succeeds then the *Event* will be signaled upon completion of the open or if an error occurs during the processing of the request. The status of the read request can be determined from the Status field of the Token once the event is signaled.

## Related Definitions

```
typedef struct {
    EFI_EVENT  Event;
    EFI_STATUS Status;
    UINTN     BufferSize;
    VOID      *Buffer;
} EFI_FILE_IO_TOKEN;
```

*Event*

If *Event* is NULL, then blocking I/O is performed. If *Event* is not NULL and non-blocking I/O is supported, then non-blocking I/O is performed, and *Event* will be signaled when the read request is completed. The caller must be prepared to handle the case where the callback associated with *Event* occurs before the original asynchronous I/O request call returns.

*Status*

Defines whether or not the signaled event encountered an error.

*BufferSize*

For **OpenEx()**: Not Used, ignored

For **ReadEx()**: On input, the size of the *Buffer*. On output, the amount of data returned in *Buffer*. In both cases, the size is measured in bytes.

For **WriteEx()**: On input, the size of the *Buffer*. On output, the amount of data actually written. In both cases, the size is measured in bytes.

*Buffer*

For **FlushEx()**: Not used, ignored

For **OpenEx()**: Not Used, ignored

For **ReadEx()**: The buffer into which the data is read.

For **WriteEx()**: The buffer of data to write.

For **FlushEx()**: Not Used, ignored

### Status Codes Returned

EFI_SUCCESS	<p>Returned from the call <i>OpenEx()</i></p> <p>If <i>Event</i> is NULL (blocking I/O): The file was opened successfully.</p> <p>If <i>Event</i> is not NULL (asynchronous I/O): The request was successfully queued for processing. <i>Event</i> will be signaled upon completion.</p> <p>Returned in the token after signaling <i>Event</i> The file was opened successfully.</p>
EFI_NOT_FOUND	The device has no medium.
EFI_NO_MEDIA	The specified file could not be found on the device.
EFI_VOLUME_CORRUPTED	The file system structures are corrupted.
EFI_WRITE_PROTECTED	An attempt was made to create a file, or open a file for write when the media is write-protected.
EFI_ACCESS_DENIED	The service denied access to the file.
EFI_OUT_OF_RESOURCES	Unable to queue the request or open the file due to lack of resources.
EFI_VOLUME_FULL	The volume is full.



## EFI\_FILE\_PROTOCOL.ReadEx()

### Summary

Reads data from a file.

### Prototype

```
typedef
EFI_STATUS
(EFIAPI *EFI_FILE_READ_EX) (
  IN EFI_FILE_PROTOCOL *This,
  IN OUT EFI_FILE_IO_TOKEN *Token
);
```

### Parameters

*This*

A pointer to the **EFI\_FILE\_PROTOCOL** instance that is the file handle to read data from. See the type **EFI\_FILE\_PROTOCOL** description.

*Token*

A pointer to the token associated with the transaction. Type **EFI\_FILE\_IO\_TOKEN** is defined in "Related Definitions" below.

### Description

The **ReadEx()** function reads data from a file.

If *This* is not a directory, the function reads the requested number of bytes from the file at the file's current position and returns them in *Buffer*. If the read goes beyond the end of the file, the read length is truncated to the end of the file. The file's current position is increased by the number of bytes returned.

If *This* is a directory, the function reads the directory entry at the file's current position and returns the entry in *Buffer*. If the *Buffer* is not large enough to hold the current directory entry, then **EFI\_BUFFER\_TOO\_SMALL** is returned and the current file position is *not* updated. *BufferSize* is set to be the size of the buffer needed to read the entry. On success, the current position is updated to the next directory entry. If there are no more directory entries, the read returns a zero-length buffer. **EFI\_FILE\_INFO** is the structure returned as the directory entry.

If non-blocking I/O is used the file pointer will be advanced based on the order that read requests were submitted.

If an error is returned from the call to *ReadEx()* and non-blocking I/O is being requested, the *Event* associated with this request will not be signaled. If the call to *ReadEx()* succeeds then the *Event* will be signaled upon completion of the read or if an error occurs during the processing of the request. The status of the read request can be determined from the *Status* field of the *Token* once the event is signaled.

### Status Codes Returned

EFI_SUCCESS	<p>Returned from the call <b>ReadEx()</b></p> <p>If <i>Event</i> is NULL (blocking I/O): The data was read successfully.</p> <p>If <i>Event</i> is not NULL (asynchronous I/O): The request was successfully queued for processing. Event will be signaled upon completion. Returned in the token after signaling <i>Event</i> The data was read successfully.</p>
EFI_NO_MEDIA	The device has no medium.
EFI_DEVICE_ERROR	The device reported an error.
EFI_DEVICE_ERROR	An attempt was made to read from a deleted file.
EFI_DEVICE_ERROR	On entry, the current file position is beyond the end of the file.
EFI_VOLUME_CORRUPTED	The file system structures are corrupted.
EFI_OUT_OF_RESOURCES	Unable to queue the request due to lack of resources.

## EFI\_FILE\_PROTOCOL.WriteEx()

### Summary

Writes data to a file.

### Prototype

```
typedef
EFI_STATUS
(EFIAPI *EFI_FILE_WRITE_EX) (
    IN EFI_FILE_PROTOCOL          *This,
    IN OUT EFI_FILE_IO_TOKEN     *Token
);
```

### Parameters

<i>This</i>	A pointer to the <b>EFI_FILE_PROTOCOL</b> instance that is the file handle to write data to. See the type <b>EFI_FILE_PROTOCOL</b> description.
<i>Token</i>	A pointer to the token associated with the transaction. Type <b>EFI_FILE_IO_TOKEN</b> is defined in "Related Definitions" above.

### Description

The **WriteEx()** function writes the specified number of bytes to the file at the current file position. The current file position is advanced the actual number of bytes written, which is returned in *BufferSize*. Partial writes only occur when there has been a data error during the write attempt (such as "file space full"). The file is automatically grown to hold the data if required.

Direct writes to opened directories are not supported.

If non-blocking I/O is used the file pointer will be advanced based on the order that write requests were submitted.

If an error is returned from the call to **WriteEx()** and non-blocking I/O is being requested, the *Event* associated with this request will not be signaled. If the call to **WriteEx()** succeeds then the *Event* will be signaled upon completion of the write or if an error occurs during the processing of the request. The status of the write request can be determined from the *Status* field of the *Token* once the event is signaled.

### Status Codes Returned

EFI_SUCCESS	Returned from the call <b>WriteEx()</b> If <i>Event</i> is NULL (blocking I/O): The data was written successfully. If <i>Event</i> is not NULL (asynchronous I/O): The request was successfully queued for processing. <i>Event</i> will be signaled upon completion. Returned in the token after signaling <i>Event</i> The data was written successfully.
EFI_UNSUPPORTED	Writes to open directory files are not supported.
EFI_NO_MEDIA	The device has no medium.
EFI_DEVICE_ERROR	The device reported an error.
EFI_DEVICE_ERROR	An attempt was made to write to a deleted file.
EFI_VOLUME_CORRUPTED	The file system structures are corrupted.
EFI_WRITE_PROTECTED	The file or medium is write-protected.
EFI_ACCESS_DENIED	The file was opened read only.
EFI_VOLUME_FULL	The volume is full.
EFI_OUT_OF_RESOURCES	Unable to queue the request due to lack of resources.

## EFI\_FILE\_PROTOCOL.FlushEx()

### Summary

Flushes all modified data associated with a file to a device.

### Prototype

```
typedef
EFI_STATUS
(EFIAPI *EFI_FILE_FLUSH_EX) (
  IN EFI_FILE_PROTOCOL  *This,
  IN OUT EFI_FILE_IO_TOKEN  *Token
);
```

### Parameters

*This*

A pointer to the **EFI\_FILE\_PROTOCOL** instance that is the file handle to flush. See the type **EFI\_FILE\_PROTOCOL** description.

*Token*

A pointer to the token associated with the transaction. Type **EFI\_FILE\_IO\_TOKEN** is defined in "Related Definitions" above. The *BufferSize* and *Buffer* fields are not used for a *FlushEx* operation.

### Description

The **FlushEx()** function flushes all modified data associated with a file to a device.

For non-blocking I/O all writes submitted before the flush request will be flushed.

If an error is returned from the call to **FlushEx()** and non-blocking I/O is being requested, the *Event* associated with this request will not be signaled.

### Status Codes Returned

EFI_SUCCESS	Returned from the call <i>FlushEx()</i> If <i>Event</i> is NULL (blocking I/O): The data was flushed successfully. If <i>Event</i> is not NULL (asynchronous I/O): The request was successfully queued for processing. Event will be signaled upon completion. Returned in the token after signaling <i>Event</i> The data was flushed successfully.
EFI_NO_MEDIA	The device has no medium.
EFI_DEVICE_ERROR	The device reported an error.
EFI_VOLUME_CORRUPTED	The file system structures are corrupted.
EFI_WRITE_PROTECTED	The file or medium is write-protected.
EFI_ACCESS_DENIED	The file was opened read-only.
EFI_VOLUME_FULL	The volume is full.

EFI_OUT_OF_RESOURCES	Unable to queue the request due to lack of resources.
----------------------	---

## EFI\_FILE\_PROTOCOL.SetPosition()

### Summary

Sets a file's current position.

### Prototype

```
typedef
EFI_STATUS
(EFIAPI *EFI_FILE_SET_POSITION) (
  IN EFI_FILE_PROTOCOL *This,
  IN UINT64    Position
);
```

### Parameters

*This*

A pointer to the [EFI FILE PROTOCOL](#) instance that is the file handle to set the requested position on. See the type [EFI\\_FILE\\_PROTOCOL](#) description.

*Position*

The byte position from the start of the file to set.

### Description

The **SetPosition()** function sets the current file position for the handle to the position supplied. With the exception of seeking to position 0xFFFFFFFFFFFFFFFF, only absolute positioning is supported, and seeking past the end of the file is allowed (a subsequent write would grow the file). Seeking to position 0xFFFFFFFFFFFFFFFF causes the current position to be set to the end of the file.

If *This* is a directory, the only position that may be set is zero. This has the effect of starting the read process of the directory entries over.

### Status Codes Returned

EFI_SUCCESS	The position was set.
EFI_UNSUPPORTED	The seek request for nonzero is not valid on open directories.
EFI_DEVICE_ERROR	An attempt was made to set the position of a deleted file.

## EFI\_FILE\_PROTOCOL.GetPosition()

### Summary

Returns a file's current position.

### Prototype

```
typedef
EFI_STATUS
(EFIAPI *EFI_FILE_GET_POSITION) (
    IN EFI_FILE_PROTOCOL *This,
    OUT UINT64 *Position
);
```

### Parameters

*This*

A pointer to the [EFI FILE PROTOCOL](#) instance that is the file handle to get the current position on. See the type [EFI\\_FILE\\_PROTOCOL](#) description.

*Position*

The address to return the file's current position value.

### Description

The **GetPosition()** function returns the current file position for the file handle. For directories, the current file position has no meaning outside of the file system driver and as such the operation is not supported. An error is returned if *This* is a directory.

### Status Codes Returned

EFI_SUCCESS	The position was returned.
EFI_UNSUPPORTED	The request is not valid on open directories.
EFI_DEVICE_ERROR	An attempt was made to get the position from a deleted file.



## EFI\_FILE\_PROTOCOL.GetInfo()

### Summary

Returns information about a file.

### Prototype

```
typedef
EFI_STATUS
(EFIAPI *EFI_FILE_GET_INFO) (
  IN EFI_FILE_PROTOCOL *This,
  IN EFI_GUID *InformationType,
  IN OUT UINTN *BufferSize,
  OUT VOID *Buffer
);
```

### Parameters

<i>This</i>	A pointer to the <a href="#">EFI_FILE_PROTOCOL</a> instance that is the file handle the requested information is for. See the type <a href="#">EFI_FILE_PROTOCOL</a> description.
<i>InformationType</i>	The type identifier for the information being requested. Type <a href="#">EFI_GUID</a> is defined on page 201. See the <a href="#">EFI_FILE_INFO</a> and <a href="#">EFI_FILE_SYSTEM_INFO</a> descriptions for the related GUID definitions.
<i>BufferSize</i>	On input, the size of <i>Buffer</i> . On output, the amount of data returned in <i>Buffer</i> . In both cases, the size is measured in bytes.
<i>Buffer</i>	A pointer to the data buffer to return. The buffer's type is indicated by <i>InformationType</i> .

### Description

The **GetInfo()** function returns information of type *InformationType* for the requested file. If the file does not support the requested information type, then **EFI\_UNSUPPORTED** is returned. If the buffer is not large enough to fit the requested structure, **EFI\_BUFFER\_TOO\_SMALL** is returned and the *BufferSize* is set to the size of buffer that is required to make the request.

The information types defined by this specification are required information types that all file systems must support.

### Status Codes Returned

EFI_SUCCESS	The information was set.
EFI_UNSUPPORTED	The <i>InformationType</i> is not known.
EFI_NO_MEDIA	The device has no medium.
EFI_DEVICE_ERROR	The device reported an error.
EFI_VOLUME_CORRUPTED	The file system structures are corrupted.

EFI_BUFFER_TOO_SMALL	The <i>BufferSize</i> is too small to read the current directory entry. <i>BufferSize</i> has been updated with the size needed to complete the request.
----------------------	--

## EFI\_FILE\_PROTOCOL.SetInfo()

### Summary

Sets information about a file.

### Prototype

```
typedef
EFI_STATUS
(EFIAPI *EFI_FILE_SET_INFO) (
  IN EFI_FILE_PROTOCOL *This,
  IN EFI_GUID *InformationType,
  IN UINTN BufferSize,
  IN VOID *Buffer
);
```

### Parameters

<i>This</i>	A pointer to the <a href="#">EFI_FILE_PROTOCOL</a> instance that is the file handle the information is for. See the type <a href="#">EFI_FILE_PROTOCOL</a> description.
<i>InformationType</i>	The type identifier for the information being set. Type <a href="#">EFI_GUID</a> is defined in page 201. See the <a href="#">EFI_FILE_INFO</a> and <a href="#">EFI_FILE_SYSTEM_INFO</a> descriptions in this section for the related GUID definitions.
<i>BufferSize</i>	The size, in bytes, of <i>Buffer</i> .
<i>Buffer</i>	A pointer to the data buffer to write. The buffer's type is indicated by <i>InformationType</i> .

### Description

The **SetInfo()** function sets information of type *InformationType* on the requested file. Because a read-only file can be opened only in read-only mode, an *InformationType* of [EFI\\_FILE\\_INFO\\_ID](#) can be used with a read-only file because this method is the only one that can be used to convert a read-only file to a read-write file. In this circumstance, only the *Attribute* field of the [EFI\\_FILE\\_INFO](#) structure may be modified. One or more calls to **SetInfo()** to change the *Attribute* field are permitted before it is closed. The file attributes will be valid the next time the file is opened with **Open()**.

An *InformationType* of [EFI\\_FILE\\_SYSTEM\\_INFO\\_ID](#) or [EFI\\_FILE\\_SYSTEM\\_VOLUME\\_LABEL\\_ID](#) may not be used on read-only media.

### Status Codes Returned

EFI_SUCCESS	The information was set.
EFI_UNSUPPORTED	The <i>InformationType</i> is not known.
EFI_NO_MEDIA	The device has no medium.
EFI_DEVICE_ERROR	The device reported an error.
EFI_VOLUME_CORRUPTED	The file system structures are corrupted.

EFI_WRITE_PROTECTED	<i>InformationType</i> is <b>EFI_FILE_INFO_ID</b> and the media is read-only.
EFI_WRITE_PROTECTED	<i>InformationType</i> is <b>EFI_FILE_PROTOCOL_SYSTEM_INFO_ID</b> and the media is read only.
EFI_WRITE_PROTECTED	<i>InformationType</i> is <b>EFI_FILE_SYSTEM_VOLUME_LABEL_ID</b> and the media is read-only.
EFI_ACCESS_DENIED	An attempt is made to change the name of a file to a file that is already present.
EFI_ACCESS_DENIED	An attempt is being made to change the <b>EFI_FILE_DIRECTORY Attribute</b> .
EFI_ACCESS_DENIED	An attempt is being made to change the size of a directory.
EFI_ACCESS_DENIED	<i>InformationType</i> is <b>EFI_FILE_INFO_ID</b> and the file was opened read-only and an attempt is being made to modify a field other than <i>Attribute</i> .
EFI_VOLUME_FULL	The volume is full.
EFI_BAD_BUFFER_SIZE	<i>BufferSize</i> is smaller than the size of the type indicated by <i>InformationType</i> .

## EFI\_FILE\_PROTOCOL.Flush()

### Summary

Flushes all modified data associated with a file to a device.

### Prototype

```
typedef
EFI_STATUS
(EFIAPI *EFI_FILE_FLUSH) (
    IN EFI_FILE_PROTOCOL *This
);
```

### Parameters

*This*

A pointer to the [EFI\\_FILE\\_PROTOCOL](#) instance that is the file handle to flush. See the type [EFI\\_FILE\\_PROTOCOL](#) description.

### Description

The **Flush()** function flushes all modified data associated with a file to a device.

### Status Codes Returned

EFI_SUCCESS	The data was flushed.
EFI_NO_MEDIA	The device has no medium.
EFI_DEVICE_ERROR	The device reported an error.
EFI_VOLUME_CORRUPTED	The file system structures are corrupted.
EFI_WRITE_PROTECTED	The file or medium is write-protected.
EFI_ACCESS_DENIED	The file was opened read-only.
EFI_VOLUME_FULL	The volume is full.

## EFI\_FILE\_INFO

### Summary

Provides a GUID and a data structure that can be used with [EFI\\_FILE\\_PROTOCOL.SetInfo\(\)](#) and [EFI\\_FILE\\_PROTOCOL.GetInfo\(\)](#) to set or get generic file information.

## GUID

```
#define EFI_FILE_INFO_ID \
{0x09576e92,0x6d3f,0x11d2,\
{0x8e39,0x00,0xa0,0xc9,0x69,0x72,0x3b}}
```

## Related Definitions

```
typedef struct {
    UINT64 Size;
    UINT64 FileSize;
    UINT64 PhysicalSize;
    EFI_TIME CreateTime;
    EFI_TIME LastAccessTime;
    EFI_TIME ModificationTime;
    UINT64 Attribute;
    CHAR16 FileName[];
} EFI_FILE_INFO;

//*****
// File Attribute Bits
//*****

#define EFI_FILE_READ_ONLY 0x0000000000000001
#define EFI_FILE_HIDDEN 0x0000000000000002
#define EFI_FILE_SYSTEM 0x0000000000000004
#define EFI_FILE_RESERVED 0x0000000000000008
#define EFI_FILE_DIRECTORY 0x0000000000000010
#define EFI_FILE_ARCHIVE 0x0000000000000020
#define EFI_FILE_VALID_ATTR 0x0000000000000037
```

## Parameters

<i>Size</i>	Size of the <b>EFI_FILE_INFO</b> structure, including the Null-terminated <i>FileName</i> string.
<i>FileSize</i>	The size of the file in bytes.
<i>PhysicalSize</i>	The amount of physical space the file consumes on the file system volume.
<i>CreateTime</i>	The time the file was created.
<i>LastAccessTime</i>	The time when the file was last accessed.
<i>ModificationTime</i>	The time when the file's contents were last modified.
<i>Attribute</i>	The attribute bits for the file. See "Related Definitions" above.
<i>FileName</i>	The Null-terminated name of the file.

## Description

The **EFI\_FILE\_INFO** data structure supports [GetInfo\(\)](#) and [SetInfo\(\)](#) requests. In the case of [SetInfo\(\)](#), the following additional rules apply:

- On directories, the file size is determined by the contents of the directory and cannot be changed by setting *FileSize*. On directories, *FileSize* is ignored during a **SetInfo()**.
- The *PhysicalSize* is determined by the *FileSize* and cannot be changed. This value is ignored during a **SetInfo()** request.
- The **EFI\_FILE\_DIRECTORY** attribute bit cannot be changed. It must match the file's actual type.
- A value of zero in *CreateTime*, *LastAccess*, or *ModificationTime* causes the fields to be ignored (and not updated).

## EFI\_FILE\_SYSTEM\_INFO

### Summary

Provides a GUID and a data structure that can be used with [EFI\\_FILE\\_PROTOCOL.GetInfo\(\)](#) to get information about the system volume, and [EFI\\_FILE\\_PROTOCOL.SetInfo\(\)](#) to set the system volume's volume label.

### GUID

```
#define EFI_FILE_SYSTEM_INFO_ID \
{0x09576e93,0x6d3f,0x11d2,0x8e39,0x00,0xa0,0xc9,0x69,0x72,\
0x3b}
```

### Related Definitions

```
typedef struct {
    UINT64 Size;
    BOOLEAN ReadOnly;
    UINT64 VolumeSize;
    UINT64 FreeSpace;
    UINT32 BlockSize;
    CHAR16 VolumeLabel[];
} EFI_FILE_SYSTEM_INFO;
```

### Parameters

<i>Size</i>	Size of the <b>EFI_FILE_SYSTEM_INFO</b> structure, including the Null-terminated <i>VolumeLabel</i> string.
<i>ReadOnly</i>	<b>TRUE</b> if the volume only supports read access.
<i>VolumeSize</i>	The number of bytes managed by the file system.
<i>FreeSpace</i>	The number of available bytes for use by the file system.
<i>BlockSize</i>	The nominal block size by which files are typically grown.
<i>VolumeLabel</i>	The Null-terminated string that is the volume's label.

### Description

The **EFI\_FILE\_SYSTEM\_INFO** data structure is an information structure that can be obtained on the root directory file handle. The root directory file handle is the file handle

first obtained on the initial call to the [EFI\\_BOOT\\_SERVICES.HandleProtocol\(\)](#) function to open the file system interface. All of the fields are read-only except for *VolumeLabel*. The system volume's *VolumeLabel* can be created or modified by calling [EFI\\_FILE\\_PROTOCOL.SetInfo\(\)](#) with an updated *VolumeLabel* field.

## EFI\_FILE\_SYSTEM\_VOLUME\_LABEL

### Summary

Provides a GUID and a data structure that can be used with [EFI\\_FILE\\_PROTOCOL.GetInfo\(\)](#) or [EFI\\_FILE\\_PROTOCOL.SetInfo\(\)](#) to get or set information about the system's volume label.

### GUID

```
#define EFI_FILE_SYSTEM_VOLUME_LABEL_ID \
{0xdb47d7d3,0xfe81,0x11d3,0x9a35,\
{0x00,0x90,0x27,0x3f,0xC1,0x4d}}
```

### Related Definitions

```
typedef struct {
    CHAR16 VolumeLabel[];
} EFI_FILE_SYSTEM_VOLUME_LABEL;
```

### Parameters

*VolumeLabel*                      The Null-terminated string that is the volume's label.

### Description

The [EFI\\_FILE\\_SYSTEM\\_VOLUME\\_LABEL](#) data structure is an information structure that can be obtained on the root directory file handle. The root directory file handle is the file handle first obtained on the initial call to the [EFI\\_BOOT\\_SERVICES.HandleProtocol\(\)](#) function to open the file system interface. The system volume's *VolumeLabel* can be created or modified by calling [EFI\\_FILE\\_PROTOCOL.SetInfo\(\)](#) with an updated *VolumeLabel* field.

## 13.6 Tape Boot Support

### 13.6.1 Tape I/O Support

This section defines the Tape I/O Protocol and standard tape header format. These enable the support of booting from tape on UEFI systems. This protocol is used to abstract the tape drive operations to support applications written to this specification.



## 13.6.2 Tape I/O Protocol

This section defines the Tape I/O Protocol and its functions. This protocol is used to abstract the tape drive operations to support applications written to this specification.

### EFI\_TAPE\_IO\_PROTOCOL

#### Summary

The EFI Tape IO protocol provides services to control and access a tape device.

#### GUID

```
#define EFI_TAPE_IO_PROTOCOL_GUID \
  {0x1e93e633,0xd65a,0x459e, \
   {0xab,0x84,0x93,0xd9,0xec,0x26,0x6d,0x18}}
```

#### Protocol Interface Structure

```
typedef struct _EFI_TAPE_IO_PROTOCOL {
  EFI_TAPE_READ  TapeRead;
  EFI_TAPE_WRITE TapeWrite;
  EFI_TAPE_REWIND TapeRewind;
  EFI_TAPE_SPACE TapeSpace;
  EFI_TAPE_WRITEFM TapeWriteFM;
  EFI_TAPE_RESET TapeReset;
} EFI_TAPE_IO_PROTOCOL;
```

#### Parameters

<i>TapeRead</i>	Read a block of data from the tape. See the <a href="#">TapeRead()</a> description.
<i>TapeWrite</i>	Write a block of data to the tape. See the <a href="#">TapeWrite()</a> description.
<i>TapeRewind</i>	Rewind the tape. See the <a href="#">TapeRewind()</a> description.
<i>TapeSpace</i>	Position the tape. See the <a href="#">TapeSpace()</a> description.
<i>TapeWriteFM</i>	Write filemarks to the tape. See the <a href="#">TapeWriteFM()</a> description.
<i>TapeReset</i>	Reset the tape device or its parent bus. See the <a href="#">TapeReset()</a> description.

#### Description

The **EFI\_TAPE\_IO\_PROTOCOL** provides basic sequential operations for tape devices. These include read, write, rewind, space, write filemarks and reset functions. Per this specification, a boot application uses the services of this protocol to load the bootloader image from tape.

No provision is made for controlling or determining media density or compression settings. The protocol relies on devices to behave normally and select settings appropriate for the media loaded. No support is included for tape partition support,

setmarks or other tapemarks such as End of Data. Boot tapes are expected to use normal variable or fixed block size formatting and filemarks.

## EFI\_TAPE\_IO\_PROTOCOL.TapeRead()

### Summary

Reads from the tape.

### Prototype

```
typedef
EFI_STATUS
(EFIAPI *EFI_TAPE_READ) (
  IN EFI_TAPE_IO_PROTOCOL *This,
  IN OUT UINTN *BufferSize,
  OUT VOID *Buffer
);
```

### Parameters

<i>This</i>	A pointer to the <b>EFI_TAPE_IO_PROTOCOL</b> instance.
<i>BufferSize</i>	Size of the buffer in bytes pointed to by <i>Buffer</i> .
<i>Buffer</i>	Pointer to the buffer for data to be read into.

### Description

This function will read up to *BufferSize* bytes from media into the buffer pointed to by *Buffer* using an implementation-specific timeout. *BufferSize* will be updated with the number of bytes transferred.

Each read operation for a device that operates in variable block size mode reads one media data block. Unread bytes which do not fit in the buffer will be skipped by the next read operation. The number of bytes transferred will be limited by the actual media block size. Best practice is for the buffer size to match the media data block size. When a filemark is encountered in variable block size mode the read operation will indicate that 0 bytes were transferred and the function will return an **EFI\_END\_OF\_FILE** error condition.

In fixed block mode the buffer is expected to be a multiple of the data block size. Each read operation for a device that operates in fixed block size mode may read multiple media data blocks. The number of bytes transferred will be limited to an integral number of complete media data blocks. *BufferSize* should be evenly divisible by the device's fixed block size. When a filemark is encountered in fixed block size mode the read operation will indicate that the number of bytes transferred is less than the number of blocks that would fit in the provided buffer (possibly 0 bytes transferred) and the function will return an **EFI\_END\_OF\_FILE** error condition.

Two consecutive filemarks are normally used to indicate the end of the last file on the media.

The value specified for *BufferSize* should correspond to the actual block size used on the media. If necessary, the value for *BufferSize* may be larger than the actual media block size.

Specifying a *BufferSize* of 0 is valid but requests the function to provide read-related status information instead of actual media data transfer. No data will be attempted to be

read from the device however this operation is classified as an access for status handling. The status code returned may be used to determine if a filemark has been encountered by the last read request with a non-zero size, and to determine if media is loaded and the device is ready for reading. A **NULL** value for *Buffer* is valid when *BufferSize* is zero.

### Status Codes Returned

EFI_SUCCESS	Data was successfully transferred from the media.
EFI_END_OF_FILE	A filemark was encountered which limited the data transferred by the read operation or the head is positioned just after a filemark.
EFI_NO_MEDIA	No media is loaded in the device.
EFI_MEDIA_CHANGED	The media in the device was changed since the last access. The transfer was aborted since the current position of the media may be incorrect.
EFI_DEVICE_ERROR	A device error occurred while attempting to transfer data from the media.
EFI_INVALID_PARAMETER	A <b>NULL</b> <i>Buffer</i> was specified with a non-zero <i>BufferSize</i> or the device is operating in fixed block size mode and the <i>BufferSize</i> was not a multiple of device's fixed block size
EFI_NOT_READY	The transfer failed since the device was not ready (e.g. not online). The transfer may be retried at a later time.
EFI_UNSUPPORTED	The device does not support this type of transfer.
EFI_TIMEOUT	The transfer failed to complete within the timeout specified.

## EFI\_TAPE\_IO\_PROTOCOL.TapeWrite()

### Summary

Write to the tape.

### Prototype

```

Typedef EFI_STATUS
(EFIAPI *EFI_TAPE_WRITE) (
IN EFI_TAPE_IO_PROTOCOL *This,
IN UINTN *BufferSize,
IN VOID *Buffer
);

```

### Parameters

<i>This</i>	A pointer to the <b>EFI_TAPE_IO_PROTOCOL</b> instance.
<i>BufferSize</i>	Size of the buffer in bytes pointed to by <i>Buffer</i> .
<i>Buffer</i>	Pointer to the buffer for data to be written from.

### Description

This function will write *BufferSize* bytes from the buffer pointed to by *Buffer* to media using an implementation-specific timeout.

Each write operation for a device that operates in variable block size mode writes one media data block of *BufferSize* bytes.

Each write operation for a device that operates in fixed block size mode writes one or more media data blocks of the device's fixed block size. *BufferSize* must be evenly divisible by the device's fixed block size.

Although sequential devices in variable block size mode support a wide variety of block sizes, many issues may be avoided in I/O software, adapters, hardware and firmware if common block sizes are used such as: 32768, 16384, 8192, 4096, 2048, 1024, 512, and 80.

*BufferSize* will be updated with the number of bytes transferred.

When a write operation occurs beyond the logical end of media an **EFI\_END\_OF\_MEDIA** error condition will occur. Normally data will be successfully written and *BufferSize* will be updated with the number of bytes transferred. Additional write operations will continue to fail in the same manner. Excessive writing beyond the logical end of media should be avoided since the physical end of media may be reached.

Specifying a *BufferSize* of 0 is valid but requests the function to provide write-related status information instead of actual media data transfer. No data will be attempted to be written to the device however this operation is classified as an access for status handling. The status code returned may be used to determine if media is loaded, writable and if the logical end of media point has been reached. A **NULL** value for *Buffer* is valid when *BufferSize* is zero.

### Status Codes Returned

EFI_SUCCESS	Data was successfully transferred to the media.
EFI_END_OF_MEDIA	The logical end of media has been reached. Data may have been successfully transferred to the media.
EFI_NO_MEDIA	No media is loaded in the device.
EFI_MEDIA_CHANGED	The media in the device was changed since the last access. The transfer was aborted since the current position of the media may be incorrect.
EFI_WRITE_PROTECTED	The media in the device is write-protected. The transfer was aborted since a write cannot be completed.
EFI_DEVICE_ERROR	A device error occurred while attempting to transfer data from the media.
EFI_INVALID_PARAMETER	A <b>NULL Buffer</b> was specified with a non-zero <i>BufferSize</i> or the device is operating in fixed block size mode and <i>BufferSize</i> was not a multiple of device's fixed block size.
EFI_NOT_READY	The transfer failed since the device was not ready (e.g. not online). The transfer may be retried at a later time.
EFI_UNSUPPORTED	The device does not support this type of transfer.
EFI_TIMEOUT	The transfer failed to complete within the timeout specified.

## EFI\_TAPE\_IO\_PROTOCOL.TapeRewind()

### Summary

Rewinds the tape.

### Prototype

```
typedef
EFI_STATUS
(EFIAPI *EFI_TAPE_REWIND) (
  IN EFI_TAPE_IO_PROTOCOL *This,
  );
```

### Parameters

*This* A pointer to the **EFI\_TAPE\_IO\_PROTOCOL** instance.

### Description

This function will rewind the media using an implementation-specific timeout. The function will check if the media was changed since the last access and reinstall the **EFI\_TAPE\_IO\_PROTOCOL** interface for the device handle if needed.

### Status Codes Returned

EFI_SUCCESS	The media was successfully repositioned.
EFI_NO_MEDIA	No media is loaded in the device.
EFI_DEVICE_ERROR	A device error occurred while attempting to reposition the media.
EFI_NOT_READY	Repositioning the media failed since the device was not ready (e.g. not online). The transfer may be retried at a later time.
EFI_UNSUPPORTED	The device does not support this type of media repositioning.
EFI_TIMEOUT	Repositioning of the media did not complete within the timeout specified.





## Status Codes Returned

EFI_SUCCESS	The media was successfully repositioned.
EFI_END_OF_MEDIA	Beginning or end of media was reached before the indicated number of data blocks or filemarks were found.
EFI_NO_MEDIA	No media is loaded in the device.
EFI_MEDIA_CHANGED	The media in the device was changed since the last access. Repositioning the media was aborted since the current position of the media may be incorrect.
EFI_DEVICE_ERROR	A device error occurred while attempting to reposition the media.
EFI_NOT_READY	Repositioning the media failed since the device was not ready (e.g. not online). The transfer may be retried at a later time.
EFI_UNSUPPORTED	The device does not support this type of media repositioning.
EFI_TIMEOUT	Repositioning of the media did not complete within the timeout specified.



## EFI\_TAPE\_IO\_PROTOCOL.TapeReset()

### Summary

Resets the tape device.

### Prototype

```
typedef
EFI_STATUS
(EFIAPI *EFI_TAPE_RESET) (
  IN EFI_TAPE_IO_PROTOCOL *This,
  IN BOOLEAN ExtendedVerification
);
```

### Parameters

*This* A pointer to the **EFI\_TAPE\_IO\_PROTOCOL** instance.

*ExtendedVerification* Indicates whether the parent bus should also be reset.

### Description

This function will reset the tape device. If *ExtendedVerification* is set to true, the function will reset the parent bus (e.g., SCSI bus). The function will check if the media was changed since the last access and reinstall the **EFI\_TAPE\_IO\_PROTOCOL** interface for the device handle if needed. Note media needs to be loaded and device online for the reset, otherwise, **EFI\_DEVICE\_ERROR** is returned.

### Status Codes Returned

EFI_SUCCESS	The bus and/or device were successfully reset.
EFI_NO_MEDIA	No media is loaded in the device.
EFI_DEVICE_ERROR	A device error occurred while attempting to reset the bus and/or device.
EFI_NOT_READY	The reset failed since the device and/or bus was not ready. The reset may be retried at a later time.
EFI_UNSUPPORTED	The device does not support this type of reset.
EFI_TIMEOUT	The reset did not complete within the timeout allowed.

## 13.6.3 Tape Header Format

The boot tape will contain a Boot Tape Header to indicate it is a valid boot tape. The Boot Tape Header must be located within the first 20 blocks on the tape. One or more tape filemarks may appear prior to the Boot Tape Header so that boot tapes may include tape label files. The Boot Tape Header must begin on a block boundary and be contained completely within a block. The Boot Tape Header will have the following format:

**Table 109. Tape Header Formats**

Bytes (Dec)	Value	Purpose
0-7	0x544f4f4220494645	Signature ('EFI BOOT' in ASCII)
8-11	1	Revision
12-15	1024	Tape Header Size in bytes
16-19	calculated	Tape Header CRC
20-35	{ 0x8befa29a, 0x3511, 0x4cf7, { 0xa2, 0xeb, 0x5f, 0xe3, 0x7c, 0x3b, 0xf5, 0x5b } }	EFI Boot Tape GUID (same for all EFI Boot Tapes, like EFI Disk GUID)
36-51	User Defined	EFI Boot Tape Type GUID (bootloader / OS specific, like EFI Partition Type GUID)
52-67	User Defined	EFI Boot Tape Unique GUID (unique for every EFI Boot Tape)
68-71	e.g. 2	File Number of EFI Bootloader relative to the Boot Tape Header (first file immediately after the Boot Tape Header is file number 1, ANSI labels are counted)
72-75	e.g. 0x400	EFI Bootloader Block Size in bytes
76-79	e.g. 0x20000	EFI Bootloader Total Size in bytes
80-119	e.g. HPUX 11.23	OS Version (ASCII)
120-159	e.g. Ignite-UX C.6.2.241	Application Version (ASCII)
160-169	e.g. 1993-02-28	EFI Boot Tape creation date (UTC) (yyyy-mm-dd ASCII)
170-179	e.g. 13:24:55	EFI Boot Tape creation time (UTC) (hh:mm:ss in ASCII)
180-435	e.g. testsys1 (alt e.g. testsys1.xyzcorp.com)	Computer System Name (UTF-8, ref: RFC 2044)
436-555	e.g. Primary Disaster Recovery	Boot Tape Title / Comment (UTF-8, ref: RFC 2044)
556-1023	reserved	

All numeric values will be specified in binary format. Note that all values are specified in Little Endian byte ordering.

The Boot Tape Header can also be represented as the following data structure:

```
typedef struct EFI_TAPE_HEADER {
    UINT64  Signature;
    UINT32  Revision;
    UINT32  BootDescSize;
    UINT32  BootDescCRC;
    EFI_GUID TapeGUID;
    EFI_GUID TapeType;
    EFI_GUID TapeUnique;
    UINT32  BLLocation;
    UINT32  BLBlocksize;
    UINT32  BLFilesize;
    CHAR8  OSVersion[40];
    CHAR8  AppVersion[40];
    CHAR8  CreationDate[10];
    CHAR8  CreationTime[10];
    CHAR8  SystemName[256]; // UTF-8
    CHAR8  TapeTitle[120]; // UTF-8
    CHAR8  pad[468]; // pad to 1024
} EFI_TAPE_HEADER;
```

## 13.7 Disk I/O Protocol

This section defines the Disk I/O protocol. This protocol is used to abstract the block accesses of the Block I/O protocol to a more general offset-length protocol. The firmware is responsible for adding this protocol to any Block I/O interface that appears in the system that does not already have a Disk I/O protocol. File systems and other disk access code utilize the Disk I/O protocol.

### EFI\_DISK\_IO\_PROTOCOL

#### Summary

This protocol is used to abstract Block I/O interfaces.

## GUID

```
#define EFI_DISK_IO_PROTOCOL_GUID \
{0xCE345171,0xBA0B,0x11d2,\
{0x8e,0x4F,0x00,0xa0,0xc9,0x69,0x72,0x3b}}
```

## Revision Number

```
#define EFI_DISK_IO_PROTOCOL_REVISION 0x00010000
```

## Protocol Interface Structure

```
typedef struct _EFI_DISK_IO_PROTOCOL {
    UINT64  Revision;
    EFI_DISK_READ  ReadDisk;
    EFI_DISK_WRITE WriteDisk;
} EFI_DISK_IO_PROTOCOL;
```

## Parameters

<i>Revision</i>	The revision to which the disk I/O interface adheres. All future revisions must be backwards compatible. If a future version is not backwards compatible, it is not the same GUID.
<i>ReadDisk</i>	Reads data from the disk. See the <a href="#">ReadDisk()</a> function description.
<i>WriteDisk</i>	Writes data to the disk. See the <a href="#">WriteDisk()</a> function description.

## Description

The **EFI\_DISK\_IO\_PROTOCOL** is used to control block I/O interfaces.

The disk I/O functions allow I/O operations that need not be on the underlying device's block boundaries or alignment requirements. This is done by copying the data to/from internal buffers as needed to provide the proper requests to the block I/O device. Outstanding write buffer data is flushed by using the [FlushBlocks\(\)](#) function of the [EFI\\_BLOCK\\_IO\\_PROTOCOL](#) on the device handle.

The firmware automatically adds an **EFI\_DISK\_IO\_PROTOCOL** interface to any **EFI\_BLOCK\_IO\_PROTOCOL** interface that is produced. It also adds file system, or logical block I/O, interfaces to any [EFI\\_DISK\\_IO\\_PROTOCOL](#) interface that contains any recognized file system or logical block I/O devices. The firmware must automatically support the following required formats:

- The EFI FAT12, FAT16, and FAT32 file system type.
- The legacy master boot record partition block. (The presence of this on any block I/O device is optional, but if it is present the firmware is responsible for allocating a logical device for each partition).
- The extended partition record partition block.
- The El Torito logical block devices.

## EFI\_DISK\_IO\_PROTOCOL.ReadDisk()

### Summary

Reads a specified number of bytes from a device.

### Prototype

```
typedef
EFI_STATUS
(EFIAPI *EFI_DISK_READ) (
  IN EFI_DISK_IO_PROTOCOL *This,
  IN UINT32      MediaId,
  IN UINT64      Offset,
  IN UINTN      BufferSize,
  OUT VOID      *Buffer
);
```

### Parameters

<i>This</i>	Indicates a pointer to the calling context. Type <b>EFI_DISK_IO_PROTOCOL</b> is defined in the <a href="#">EFI_DISK_IO_PROTOCOL</a> description.
<i>MediaId</i>	ID of the medium to be read.
<i>Offset</i>	The starting byte offset on the logical block I/O device to read from.
<i>BufferSize</i>	The size in bytes of <i>Buffer</i> . The number of bytes to read from the device.
<i>Buffer</i>	A pointer to the destination buffer for the data. The caller is responsible for either having implicit or explicit ownership of the buffer.

### Description

The **ReadDisk()** function reads the number of bytes specified by *BufferSize* from the device. All the bytes are read, or an error is returned. If there is no medium in the device, the function returns **EFI\_NO\_MEDIA**. If the *MediaId* is not the ID of the medium currently in the device, the function returns **EFI\_MEDIA\_CHANGED**.

### Status Codes Returned

EFI_SUCCESS	The data was read correctly from the device.
EFI_DEVICE_ERROR	The device reported an error while performing the read operation.
EFI_NO_MEDIA	There is no medium in the device.
EFI_MEDIA_CHANGED	The <i>MediaId</i> is not for the current medium.
EFI_INVALID_PARAMETER	The read request contains device addresses that are not valid for the device.

## EFI\_DISK\_IO\_PROTOCOL.WriteDisk()

### Summary

Writes a specified number of bytes to a device.

### Prototype

```
typedef
EFI_STATUS
(EFI_API *EFI_DISK_WRITE) (
    IN EFI_DISK_IO_PROTOCOL *This,
    IN UINT32      MediaId,
    IN UINT64      Offset,
    IN UINTN       BufferSize,
    IN VOID        *Buffer
);
```

### Parameters

<i>This</i>	Indicates a pointer to the calling context. Type <b>EFI_DISK_IO_PROTOCOL</b> is defined in the <a href="#">EFI_DISK_IO_PROTOCOL</a> protocol description.
<i>MediaId</i>	ID of the medium to be written.
<i>Offset</i>	The starting byte offset on the logical block I/O device to write.
<i>BufferSize</i>	The size in bytes of <i>Buffer</i> . The number of bytes to write to the device.
<i>Buffer</i>	A pointer to the buffer containing the data to be written.

### Description

The **WriteDisk()** function writes the number of bytes specified by *BufferSize* to the device. All bytes are written, or an error is returned. If there is no medium in the device, the function returns **EFI\_NO\_MEDIA**. If the *MediaId* is not the ID of the medium currently in the device, the function returns **EFI\_MEDIA\_CHANGED**.

### Status Codes Returned

EFI_SUCCESS	The data was written correctly to the device.
EFI_WRITE_PROTECTED	The device cannot be written to.
EFI_NO_MEDIA	There is no medium in the device.
EFI_MEDIA_CHANGED	The <i>MediaId</i> is not for the current medium.
EFI_DEVICE_ERROR	The device reported an error while performing the write operation.
EFI_INVALID_PARAMETER	The write request contains device addresses that are not valid for the device.



## 13.8 Disk I/O 2 Protocol

The Disk I/O 2 protocol defines an extension to the Disk I/O protocol to enable non-blocking / asynchronous byte-oriented disk operation.

### EFI\_DISK\_IO2\_PROTOCOL

#### Summary

This protocol is used to abstract Block I/O interfaces in a non-blocking manner.

#### GUID

```
#define EFI_DISK_IO2_PROTOCOL_GUID \
  { 0x151c8eae, 0x7f2c, 0x472c, \
    { 0x9e, 0x54, 0x98, 0x28, 0x19, 0x4f, 0x6a, 0x88 } }
```

#### Revision Number

```
#define EFI_DISK_IO2_PROTOCOL_REVISION 0x00020000
```

#### Protocol Interface Structure

```
typedef struct _EFI_DISK_IO2_PROTOCOL {
  UINT64      Revision;
  EFI_DISK_CANCEL_EX Cancel;
  EFI_DISK_READ_EX ReadDiskEx;
  EFI_DISK_WRITE_EX WriteDiskEx;
  EFI_DISK_FLUSH_EX FlushDiskEx;
} EFI_DISK_IO2_PROTOCOL;
```

#### Parameters

<i>Revision</i>	The revision to which the disk I/O interface adheres. All future revisions must be backwards compatible.
<i>Cancel</i>	Terminate outstanding requests. See the <b>Cancel()</b> function description.
<i>ReadDiskEx</i>	Reads data from the disk. See the <b>ReadDiskEx()</b> function description.
<i>WriteDiskEx</i>	Writes data to the disk. See the <b>WriteDiskEx()</b> function description.
<i>FlushDiskEx</i>	Flushes all modified data to the physical device. See the <b>FlushDiskEx()</b> function description.

#### Description

The **EFI\_DISK\_IO2\_PROTOCOL** is used to control block I/O interfaces.

The disk I/O functions allow I/O operations that need not be on the underlying device's block boundaries or alignment requirements. This is done by copying the data to/from

internal buffers as needed to provide the proper requests to the block I/O device. Outstanding write buffer data is flushed by using the **FlushBlocksEx()** function of the **EFI\_BLOCK\_IO2\_PROTOCOL** on the device handle.

The firmware automatically adds an **EFI\_DISK\_IO2\_PROTOCOL** interface to any **EFI\_BLOCK\_IO2\_PROTOCOL** interface that is produced. It also adds file system, or logical block I/O, interfaces to any **EFI\_DISK\_IO2\_PROTOCOL** interface that contains any recognized file system or logical block I/O devices.

Implementations must account for cases where there is pending queued asynchronous I/O when a call is received on a blocking protocol interface. In these cases the pending I/O will be processed and completed before the blocking function is executed so that operation are carried out in the order they were requested.

## EFI\_DISK\_IO2\_PROTOCOL.Cancel()

### Summary

Terminate outstanding asynchronous requests to a device.

### Prototype

```
typedef
EFI_STATUS
(EFIAPI *EFI_DISK_CANCEL_EX) (
  IN EFI_DISK_IO2_PROTOCOL *This
);
```

### Parameters

*This*

Indicates a pointer to the calling context. Type **EFI\_DISK\_IO2\_PROTOCOL** is defined in the **EFI\_DISK\_IO2\_PROTOCOL** description.

### Description

The **Cancel()** function will terminate any in-flight non-blocking I/O requests by signaling the **EFI\_DISK\_IO2\_TOKEN** Event and with *TransactionStatus* set to **EFI\_ABORTED**. After the **Cancel()** function returns it is safe to free any *Token* or *Buffer* data structures that were allocated as part of the non-blocking I/O operation.

### Status Codes Returned

EFI_SUCCESS	All outstanding requests were successfully terminated.
EFI_DEVICE_ERROR	The device reported an error while performing the cancel operation.

## EFI\_DISK\_IO2\_PROTOCOL.ReadDiskEx()

### Summary

Reads a specified number of bytes from a device.

### Prototype

```
typedef
EFI_STATUS
(EFI_API *EFI_DISK_READ_EX) (
  IN EFI_DISK_IO2_PROTOCOL *This,
  IN UINT32      MediaId,
  IN UINT64      Offset,
  IN OUT EFI_DISK_IO2_TOKEN *Token,
  IN UINTN      BufferSize,
  OUT VOID      *Buffer
);
```

### Parameters

<i>This</i>	Indicates a pointer to the calling context. Type <b>EFI_DISK_IO2_PROTOCOL</b> is defined in the <b>EFI_DISK_IO2_PROTOCOL</b> description.
<i>MediaId</i>	ID of the medium to be read.
<i>Offset</i>	The starting byte offset on the logical block I/O device to read from.
<i>Token</i>	A pointer to the token associated with the transaction. Type <b>EFI_DISK_IO2_TOKEN</b> is defined in "Related Definitions" below. If this field is NULL, synchronous/blocking IO is performed.
<i>BufferSize</i>	The size in bytes of <i>Buffer</i> . The number of bytes to read from the device.
<i>Buffer</i>	A pointer to the destination buffer for the data. The caller is responsible either having implicit or explicit ownership of the buffer.

### Description

The **ReadDiskEx()** function reads the number of bytes specified by *BufferSize* from the device. All the bytes are read, or an error is returned. If there is no medium in the device, the function returns **EFI\_NO\_MEDIA**. If the *MediaId* is not the ID of the medium currently in the device, the function returns **EFI\_MEDIA\_CHANGED**.

If an error is returned from the call to **ReadDiskEx()** and non-blocking I/O is being requested, the *Event* associated with this request will not be signaled. If the call to **ReadDiskEx()** succeeds then the *Event* will be signaled upon completion of the read or if an error occurs during the processing of the request. The status of the read request can be determined from the *Status* field of the *Token* once the event is signaled.

## Related Definitions

```
typedef struct {
    EFI_EVENT Event;
    EFI_STATUS TransactionStatus;
} EFI_DISK_IO2_TOKEN;
```

### *Event*

If *Event* is NULL, then blocking I/O is performed. If *Event* is not NULL and non-blocking I/O is supported, then non-blocking I/O is performed, and *Event* will be signaled when the I/O request is completed. The caller must be prepared to handle the case where the callback associated with *Event* occurs before the original asynchronous I/O request call returns.

### *TransactionStatus*

Defines whether or not the signaled event encountered an error.

## Status Codes Returned

EFI_SUCCESS	Returned from the call <code>ReadDiskEx()</code> If <i>Event</i> is NULL (blocking I/O): The data was read correctly from the device. If <i>Event</i> is not NULL (asynchronous I/O): The request was successfully queued for processing. Event will be signaled upon completion. Returned in the token after signaling <i>Event</i> The data was read correctly from the device.
EFI_DEVICE_ERROR	The device reported an error while performing the read operation.
EFI_NO_MEDIA	There is no medium in the device.
EFI_MEDIA_CHANGED	The <i>MediaId</i> is not for the current medium.
EFI_INVALID_PARAMETER	The read request contains device addresses that are not valid for the device.
EFI_OUT_OF_RESOURCES	The request could not be completed due to a lack of resources

## EFI\_DISK\_IO2\_PROTOCOL.WriteDiskEx()

### Summary

Writes a specified number of bytes to a device.

### Prototype

```
typedef
EFI_STATUS
(EFIAPI *EFI_DISK_WRITE_EX) (
  IN EFI_DISK_IO2_PROTOCOL *This,
  IN UINT32      MediaId,
  IN UINT64      Offset,
  IN OUT EFI_DISK_IO2_TOKEN *Token,
  IN UINTN      BufferSize,
  IN VOID       *Buffer
);
```

### Parameters

<i>This</i>	Indicates a pointer to the calling context. Type <b>EFI_DISK_IO2_PROTOCOL</b> is defined in the <b>EFI_DISK_IO2_PROTOCOL</b> description.
<i>MediaId</i>	ID of the medium to be written.
<i>Offset</i>	The starting byte offset on the logical block I/O device to write to.
<i>Token</i>	A pointer to the token associated with the transaction. Type <b>EFI_DISK_IO2_TOKEN</b> is defined in "Related Definitions" below. If this field is NULL, synchronous/blocking IO is performed.
<i>BufferSize</i>	The size in bytes of <i>Buffer</i> . The number of bytes to write to the device.
<i>Buffer</i>	A pointer to the source buffer for the data. The caller is responsible.

### Description

The **WriteDiskEx()** function writes the number of bytes specified by *BufferSize* to the device. All bytes are written, or an error is returned. If there is no medium in the device, the function returns **EFI\_NO\_MEDIA**. If the *MediaId* is not the ID of the medium currently in the device, the function returns **EFI\_MEDIA\_CHANGED**.

If an error is returned from the call to **WriteDiskEx()** and non-blocking I/O is being requested, the *Event* associated with this request will not be signaled. If the call to **WriteDiskEx()** succeeds then the *Event* will be signaled upon completion of the write or if an error occurs during the processing of the request. The status of the write request can be determined from the *Status* field of the *Token* once the event is signaled.

## Status Codes Returned

EFI_SUCCESS	<p>Returned from the call <b>WriteDiskEx()</b></p> <p>If <i>Event</i> is NULL (blocking I/O):</p> <ul style="list-style-type: none"> <li>The data was written correctly to the device.</li> </ul> <p>If <i>Event</i> is not NULL (asynchronous I/O):</p> <ul style="list-style-type: none"> <li>The request was successfully queued for processing. <i>Event</i> will be signaled upon completion.</li> </ul> <p>Returned in the token after signaling <i>Event</i></p> <ul style="list-style-type: none"> <li>The data was written correctly to the device.</li> </ul>
EFI_WRITE_PROTECTED	The device cannot be written to.
EFI_DEVICE_ERROR	The device reported an error while performing the write operation.
EFI_NO_MEDIA	There is no medium in the device.
EFI_MEDIA_CHANGED	The <i>MediaId</i> is not for the current medium.
EFI_INVALID_PARAMETER	The read request contains device addresses that are not valid for the device.
EFI_OUT_OF_RESOURCES	The request could not be completed due to a lack of resources

## EFI\_DISK\_IO2\_PROTOCOL.FlushDiskEx()

### Summary

Flushes all modified data to the physical device.

### Prototype

```
typedef
EFI_STATUS
(EFI_API *EFI_DISK_FLUSH_EX) (
    IN EFI_DISK_IO2_PROTOCOL *This,
    IN OUT EFI_DISK_IO2_TOKEN *Token
);
```

### Parameters

*This*

Indicates a pointer to the calling context. Type **EFI\_DISK\_IO2\_PROTOCOL** is defined in the **EFI\_DISK\_IO2\_PROTOCOL** description.

*Token*

A pointer to the token associated with the transaction. Type **EFI\_DISK\_IO2\_TOKEN** is defined in "Related Definitions" below. If this field is NULL, synchronous/ blocking IO is performed.

### Description

The **FlushDiskEx()** function flushes all modified data to the physical device. If an error is returned from the call to **FlushDiskEx()** and non-blocking I/O is being requested, the *Event* associated with this request will not be signaled. If the call to **FlushDiskEx()** succeeds then the *Event* will be signaled upon completion of the flush or if an error occurs during the processing of the request. The status of the flush request can be determined from the *Status* field of the *Token* once the event is signaled.



## Status Codes Returned

EFI_SUCCESS	<p>Returned from the call <i>FlushDiskEx()</i></p> <p>If <i>Event</i> is NULL (blocking I/O):</p> <ul style="list-style-type: none"> <li>The data was flushed successfully to the device.</li> </ul> <p>If <i>Event</i> is not NULL (asynchronous I/O):</p> <ul style="list-style-type: none"> <li>The request was successfully queued for processing. <i>Event</i> will be signaled upon completion.</li> </ul> <p>Returned in the token after signaling <i>Event</i> The data was flushed successfully to the device.</p>
EFI_WRITE_PROTECTED	The device cannot be written to.
EFI_DEVICE_ERROR	The device reported an error while performing the flush operation.
EFI_NO_MEDIA	There is no medium in the device.
EFI_MEDIA_CHANGED	The medium in the device has changed since the last access.
EFI_INVALID_PARAMETER	Token is NULL.
EFI_OUT_OF_RESOURCES	The request could not be completed due to a lack of resources

## 13.9 Block I/O Protocol

This section defines the Block I/O protocol. This protocol is used to abstract mass storage devices to allow code running in the EFI boot services environment to access them without specific knowledge of the type of device or controller that manages the device. Functions are defined to read and write data at a block level from mass storage devices as well as to manage such devices in the EFI boot services environment.

### EFI\_BLOCK\_IO\_PROTOCOL

#### Summary

This protocol provides control over block devices.

## GUID

```
#define EFI_BLOCK_IO_PROTOCOL_GUID \
{0x964e5b21,0x6459,0x11d2,\
{0x8e,0x39,0x00,0xa0,0xc9,0x69,0x72,0x3b}}
```

## Revision Number

```
#define EFI_BLOCK_IO_PROTOCOL_REVISION2 0x00020001
#define EFI_BLOCK_IO_PROTOCOL_REVISION3 ((2<<16) | (31))
```

## Protocol Interface Structure

```
typedef struct _EFI_BLOCK_IO_PROTOCOL {
    UINT64      Revision;
    EFI_BLOCK_IO_MEDIA *Media;
    EFI_BLOCK_RESET Reset;
    EFI_BLOCK_READ ReadBlocks;
    EFI_BLOCK_WRITE WriteBlocks;
    EFI_BLOCK_FLUSH FlushBlocks;
} EFI_BLOCK_IO_PROTOCOL;
```

## Parameters

<i>Revision</i>	The revision to which the block IO interface adheres. All future revisions must be backwards compatible. If a future version is not backwards compatible it is not the same GUID.
<i>Media</i>	A pointer to the <b>EFI_BLOCK_IO_MEDIA</b> data for this device. Type <b>EFI_BLOCK_IO_MEDIA</b> is defined in “Related Definitions” below.
<i>Reset</i>	Resets the block device hardware. See the <a href="#">Reset()</a> function description.
<i>ReadBlocks</i>	Reads the requested number of blocks from the device. See the <a href="#">ReadBlocks()</a> function description.
<i>WriteBlocks</i>	Writes the requested number of blocks to the device. See the <a href="#">WriteBlocks()</a> function description.
<i>FlushBlocks</i>	Flushes any cache blocks. This function is optional and only needs to be supported on block devices that cache writes. See the <a href="#">FlushBlocks()</a> function description.

## Related Definitions

```

//*****
// EFI_BLOCK_IO_MEDIA
//*****

typedef struct {
    UINT32  MediaId;
    BOOLEAN RemovableMedia;
    BOOLEAN MediaPresent;
    BOOLEAN LogicalPartition;
    BOOLEAN ReadOnly;
    BOOLEAN WriteCaching;
    UINT32  BlockSize;
    UINT32  IoAlign;
    EFI_LBA LastBlock;

    EFI_LBA LowestAlignedLba; //added in Revision 2
    UINT32  LogicalBlocksPerPhysicalBlock;
//added in Revision 2
    UINT32 OptimalTransferLengthGranularity;
// added in Revision 3
} EFI_BLOCK_IO_MEDIA;

//*****
// EFI_LBA
//*****
typedef UINT64  EFI_LBA;

```

The following data values in **EFI\_BLOCK\_IO\_MEDIA** are read-only and are updated by the code that produces the **EFI\_BLOCK\_IO\_PROTOCOL** functions:

<i>MediaId</i>	The current media ID. If the media changes, this value is changed.
<i>RemovableMedia</i>	<b>TRUE</b> if the media is removable; otherwise, <b>FALSE</b> .
<i>MediaPresent</i>	<b>TRUE</b> if there is a media currently present in the device; otherwise, <b>FALSE</b> . This field shows the media present status as of the most recent <a href="#">ReadBlocks()</a> or <a href="#">WriteBlocks()</a> call.
<i>LogicalPartition</i>	<b>TRUE</b> if the <b>EFI_BLOCK_IO_PROTOCOL</b> was produced to abstract partition structures on the disk. <b>FALSE</b> if the <b>BLOCK_IO</b> protocol was produced to abstract the logical blocks on a hardware device.
<i>ReadOnly</i>	<b>TRUE</b> if the media is marked read-only otherwise, <b>FALSE</b> . This field shows the read-only status as of the most recent <a href="#">WriteBlocks()</a> call.
<i>WriteCaching</i>	<b>TRUE</b> if the <a href="#">WriteBlocks()</a> function caches write data.

<i>BlockSize</i>	The intrinsic block size of the device. If the media changes, then this field is updated. Returns the number of bytes per logical block. For ATA devices, this is reported in IDENTIFY DEVICE data words 117-118 (i.e., Words per Logical Sector) (see ATA8-ACS). For SCSI devices, this is reported in the READ CAPACITY (16) parameter data Logical Block Length In Bytes field (see SBC-3).
<i>IoAlign</i>	Supplies the alignment requirement for any buffer used in a data transfer. <i>IoAlign</i> values of 0 and 1 mean that the buffer can be placed anywhere in memory. Otherwise, <i>IoAlign</i> must be a power of 2, and the requirement is that the start address of a buffer must be evenly divisible by <i>IoAlign</i> with no remainder.
<i>LastBlock</i>	The last LBA on the device. If the media changes, then this field is updated. For ATA devices, this is reported in IDENTIFY DEVICE data words 60-61 (i.e., Total number of user addressable logical sectors) (see ATA8-ACS) minus one. For SCSI devices, this is reported in the READ CAPACITY (16) parameter data Returned Logical Block Address field (see SBC-3) minus one.
<i>LowestAlignedLba</i>	Only present if <b>EFI_BLOCK_IO_PROTOCOL.Revision</b> is greater than or equal to <b>EFI_BLOCK_IO_PROTOCOL_REVISION2</b> . Returns the first LBA that is aligned to a physical block boundary (see <a href="#">Section 5.3.1</a> ). Note that this field follows the SCSI definition, not the ATA definition. If <i>LogicalPartition</i> is <b>TRUE</b> this value will be zero.
<i>LogicalBlocksPerPhysicalBlock</i>	Only present if <b>EFI_BLOCK_IO_PROTOCOL.Revision</b> is greater than or equal to <b>EFI_BLOCK_IO_PROTOCOL_REVISION2</b> . Returns the number of logical blocks per physical block (see <a href="#">Section 5.3.1</a> ). Unlike the ATA and SCSI fields that provide the information for this field, this field does not contain an exponential value. A value of 0 means there is either one logical block per physical block, or there are more than one physical block per logical block. If <i>LogicalPartition</i> is <b>TRUE</b> this value will be zero.
<i>OptimalTransferLengthGranularity</i>	Only present if <b>EFI_BLOCK_IO_PROTOCOL.Revision</b> is greater than or equal to <b>EFI_BLOCK_IO_PROTOCOL_REVISION3</b> . Returns the optimal transfer length granularity as a number of logical blocks (see <a href="#">Section 5.3.1</a> ). A value of 0 means there is no reported optimal transfer length granularity. If <i>LogicalPartition</i> is <b>TRUE</b> this value will be zero.

## Description

The *LogicalPartition* is **TRUE** if the device handle is for a partition. For media that have only one partition, the value will always be **TRUE**. For media that have multiple partitions, this value is **FALSE** for the handle that accesses the entire device. The firmware is responsible for adding device handles for each partition on such media.

The firmware is responsible for adding an [EFI\\_DISK\\_IO\\_PROTOCOL](#) interface to every [EFI\\_BLOCK\\_IO\\_PROTOCOL](#) interface in the system. The **EFI\_DISK\_IO\_PROTOCOL** interface allows byte-level access to devices.

## EFI\_BLOCK\_IO\_PROTOCOL.Reset()

### Summary

Resets the block device hardware.

### Prototype

```
typedef
EFI_STATUS
(EFIAPI *EFI_BLOCK_RESET) (
    IN EFI_BLOCK_IO_PROTOCOL *This,
    IN BOOLEAN ExtendedVerification
);
```

### Parameters

*This*

Indicates a pointer to the calling context. Type **EFI\_BLOCK\_IO\_PROTOCOL** is defined in the [EFI\\_BLOCK\\_IO\\_PROTOCOL](#) description.

*ExtendedVerification*

Indicates that the driver may perform a more exhaustive verification operation of the device during reset.

### Description

The **Reset()** function resets the block device hardware.

As part of the initialization process, the firmware/device will make a quick but reasonable attempt to verify that the device is functioning. If the *ExtendedVerification* flag is **TRUE** the firmware may take an extended amount of time to verify the device is operating on reset. Otherwise the reset operation is to occur as quickly as possible.

The hardware verification process is not defined by this specification and is left up to the platform firmware or driver to implement.

### Status Codes Returned

EFI_SUCCESS	The block device was reset.
EFI_DEVICE_ERROR	The block device is not functioning correctly and could not be reset.

## EFI\_BLOCK\_IO\_PROTOCOL.ReadBlocks()

### Summary

Reads the requested number of blocks from the device.

### Prototype

```
typedef
EFI_STATUS
(EFIAPI *EFI_BLOCK_READ) (
  IN EFI_BLOCK_IO_PROTOCOL *This,
  IN UINT32      MediaId,
  IN EFI_LBA     LBA,
  IN UINTN      BufferSize,
  OUT VOID      *Buffer
);
```

### Parameters

<i>This</i>	Indicates a pointer to the calling context. Type <b>EFI_BLOCK_IO_PROTOCOL</b> is defined in the <a href="#">EFI_BLOCK_IO_PROTOCOL</a> description.
<i>MediaId</i>	The media ID that the read request is for.
<i>LBA</i>	The starting logical block address to read from on the device. Type <b>EFI_LBA</b> is defined in the <b>EFI_BLOCK_IO_PROTOCOL</b> description.
<i>BufferSize</i>	The size of the <i>Buffer</i> in bytes. This must be a multiple of the intrinsic block size of the device.
<i>Buffer</i>	A pointer to the destination buffer for the data. The caller is responsible for either having implicit or explicit ownership of the buffer.

### Description

The **ReadBlocks()** function reads the requested number of blocks from the device. All the blocks are read, or an error is returned.

If there is no media in the device, the function returns **EFI\_NO\_MEDIA**. If the *MediaId* is not the ID for the current media in the device, the function returns **EFI\_MEDIA\_CHANGED**. The function must return **EFI\_NO\_MEDIA** or **EFI\_MEDIA\_CHANGED** even if *LBA*, *BufferSize*, or *Buffer* are invalid so the caller can probe for changes in media state.

### Status Codes Returned

EFI_SUCCESS	The data was read correctly from the device.
EFI_DEVICE_ERROR	The device reported an error while attempting to perform the read operation.
EFI_NO_MEDIA	There is no media in the device.

EFI_MEDIA_CHANGED	The <i>MediaId</i> is not for the current media.
EFI_BAD_BUFFER_SIZE	The <i>BufferSize</i> parameter is not a multiple of the intrinsic block size of the device.
EFI_INVALID_PARAMETER	The read request contains LBAs that are not valid, or the buffer is not on proper alignment.



## EFI\_BLOCK\_IO\_PROTOCOL.WriteBlocks()

### Summary

Writes a specified number of blocks to the device.

### Prototype

```
typedef
EFI_STATUS
(EFIAPI *EFI_BLOCK_WRITE) (
  IN EFI_BLOCK_IO_PROTOCOL *This,
  IN UINT32      MediaId,
  IN EFI_LBA     LBA,
  IN UINTN      BufferSize,
  IN VOID        *Buffer
);
```

### Parameters

<i>This</i>	Indicates a pointer to the calling context. Type is defined in the <a href="#">EFI_BLOCK_IO_PROTOCOL</a> description.
<i>MediaId</i>	The media ID that the write request is for.
<i>LBA</i>	The starting logical block address to be written. The caller is responsible for writing to only legitimate locations. Type <b>EFI_LBA</b> is defined in the <a href="#">EFI_BLOCK_IO_PROTOCOL</a> description.
<i>BufferSize</i>	The size in bytes of <i>Buffer</i> . This must be a multiple of the intrinsic block size of the device.
<i>Buffer</i>	A pointer to the source buffer for the data.

### Description

The **WriteBlocks()** function writes the requested number of blocks to the device. All blocks are written, or an error is returned.

If there is no media in the device, the function returns **EFI\_NO\_MEDIA**. If the *MediaId* is not the ID for the current media in the device, the function returns **EFI\_MEDIA\_CHANGED**. The function must return **EFI\_NO\_MEDIA** or **EFI\_MEDIA\_CHANGED** even if *LBA*, *BufferSize*, or *Buffer* are invalid so the caller can probe for changes in media state.

### Status Codes Returned

EFI_SUCCESS	The data were written correctly to the device.
EFI_WRITE_PROTECTED	The device cannot be written to.
EFI_NO_MEDIA	There is no media in the device.
EFI_MEDIA_CHANGED	The <i>MediaId</i> is not for the current media.
EFI_DEVICE_ERROR	The device reported an error while attempting to perform the write operation.

EFI_BAD_BUFFER_SIZE	The <i>BufferSize</i> parameter is not a multiple of the intrinsic block size of the device.
EFI_INVALID_PARAMETER	The write request contains LBAs that are not valid, or the buffer is not on proper alignment.

## EFI\_BLOCK\_IO\_PROTOCOL.FlushBlocks()

### Summary

Flushes all modified data to a physical block device.

### Prototype

```
typedef
EFI_STATUS
(EFIAPI *EFI_BLOCK_FLUSH) (
  IN EFI_BLOCK_IO_PROTOCOL *This
);
```

### Parameters

*This*

Indicates a pointer to the calling context. Type **EFI\_BLOCK\_IO\_PROTOCOL** is defined in the [EFI\\_BLOCK\\_IO\\_PROTOCOL](#) protocol description.

### Description

The **FlushBlocks()** function flushes all modified data to the physical block device.

All data written to the device prior to the flush must be physically written before returning **EFI\_SUCCESS** from this function. This would include any cached data the driver may have cached, and cached data the device may have cached. A flush may cause a read request following the flush to force a device access.

### Status Codes Returned

EFI_SUCCESS	All outstanding data were written correctly to the device.
EFI_DEVICE_ERROR	The device reported an error while attempting to write data.
EFI_NO_MEDIA	There is no media in the device.

## 13.10 Block I/O 2 Protocol

The Block I/O 2 protocol defines an extension to the Block I/O protocol which enables the ability to read and write data at a block level in a non-blocking manner.

### EFI\_BLOCK\_IO2\_PROTOCOL

#### Summary

This protocol provides control over block devices.

## GUID

```
#define EFI_BLOCK_IO2_PROTOCOL_GUID \
{0xa77b2472, 0xe282, 0x4e9f, \
{0xa2, 0x45, 0xc2, 0xc0, 0xe2, 0x7b, 0xbc, 0xc1}}
```

## Protocol Interface Structure

```
typedef struct _EFI_BLOCK_IO2_PROTOCOL {
  EFI_BLOCK_IO_MEDIA *Media;
  EFI_BLOCK_RESET_EX Reset;
  EFI_BLOCK_READ_EX ReadBlocksEx;
  EFI_BLOCK_WRITE_EX WriteBlocksEx;
  EFI_BLOCK_FLUSH_EX FlushBlocksEx;
} EFI_BLOCK_IO2_PROTOCOL;
```

## Parameters

<i>Media</i>	A pointer to the <b>EFI_BLOCK_IO_MEDIA</b> data for this device. Type <b>EFI_BLOCK_IO_MEDIA</b> is defined in the <b>EFI_BLOCK_IO_PROTOCOL</b> section.
<i>Reset</i>	Resets the block device hardware. See the <b>Reset()</b> function description following below.
<i>ReadBlocksEx</i>	Reads the requested number of blocks from the device. See the <b>EFI_BLOCK_IO2_PROTOCOL.ReadBlocksEx()</b> function description.
<i>WriteBlocksEx</i>	Writes the requested number of blocks to the device. See the <b>WriteBlocksEx()</b> function description.
<i>FlushBlocksEx</i>	Flushes any cache blocks. This function is optional and only needs to be supported on block devices that cache writes. See the <b>FlushBlocksEx()</b> function description.

## EFI\_BLOCK\_IO2\_PROTOCOL.Reset()

### Summary

Resets the block device hardware.

### Prototype

```
typedef
EFI_STATUS
(EFIAPI *EFI_BLOCK_RESET_EX) (
  IN EFI_BLOCK_IO2_PROTOCOL *This,
  IN BOOLEAN ExtendedVerification
);
```

### Parameters

*This*

Indicates a pointer to the calling context. Type **EFI\_BLOCK\_IO2\_PROTOCOL** is defined in the **EFI\_BLOCK\_IO2\_PROTOCOL** description.

*ExtendedVerification*

Indicates that the driver may perform a more exhaustive verification operation of the device during reset.

### Description

The **Reset()** function resets the block device hardware.

As part of the initialization process, the firmware/device will make a quick but reasonable attempt to verify that the device is functioning. If the *ExtendedVerification* flag is **TRUE** the firmware may take an extended amount of time to verify the device is operating on reset. Otherwise the reset operation is to occur as quickly as possible.

The hardware verification process is not defined by this specification and is left up to the platform firmware or driver to implement.

The **Reset()** function will terminate any in-flight non-blocking I/O requests by signaling an **EFI\_ABORTED** in the *TransactionStatus* member of the **EFI\_BLOCK\_IO2\_TOKEN** for the non-blocking I/O. After the **Reset()** function returns it is safe to free any *Token* or *Buffer* data structures that were allocated to initiate the non-blocking I/O requests that were in-flight for this device.

### Status Codes Returned

EFI_SUCCESS	The block device was reset.
EFI_DEVICE_ERROR	The block device is not functioning correctly and could not be reset.

## EFI\_BLOCK\_IO2\_PROTOCOL.ReadBlocksEx()

### Summary

Reads the requested number of blocks from the device.

### Prototype

```
typedef
EFI_STATUS
(EFIAPI *EFI_BLOCK_READ_EX) (
    IN EFI_BLOCK_IO2_PROTOCOL *This,
    IN UINT32      MediaId,
    IN EFI_LBA     LBA,
    IN OUT EFI_BLOCK_IO2_TOKEN *Token,
    IN UINTN      BufferSize,
    OUT VOID      *Buffer
);
```

### Parameters

<i>This</i>	Indicates a pointer to the calling context. Type <b>EFI_BLOCK_IO2_PROTOCOL</b> is defined in the <b>EFI_BLOCK_IO2_PROTOCOL</b> description.
<i>MediaId</i>	The media ID that the read request is for.
<i>LBA</i>	The starting logical block address to read from on the device. Type <b>EFI_LBA</b> is defined in the <b>EFI_BLOCK_IO_PROTOCOL</b> description.
<i>Token</i>	A pointer to the token associated with the transaction. Type <b>EFI_BLOCK_IO2_TOKEN</b> is defined in "Related Definitions" below.
<i>BufferSize</i>	The size of the <i>Buffer</i> in bytes. This must be a multiple of the intrinsic block size of the device.
<i>Buffer</i>	A pointer to the destination buffer for the data. The caller is responsible for either having implicit or explicit ownership of the buffer.

### Description

The **ReadBlocksEx()** function reads the requested number of blocks from the device. All the blocks are read, or an error is returned.

If there is no media in the device, the function returns **EFI\_NO\_MEDIA**. If the *MediaId* is not the ID for the current media in the device, the function returns **EFI\_MEDIA\_CHANGED**. The function must return **EFI\_NO\_MEDIA** or **EFI\_MEDIA\_CHANGED** even if *LBA*, *BufferSize*, or *Buffer* are invalid so the caller can probe for changes in media state.

If **EFI\_DEVICE\_ERROR**, **EFI\_NO\_MEDIA**, or **EFI\_MEDIA\_CHANGED** is returned and non-blocking I/O is being used, the *Event* associated with this request will not be signaled.

## Related Definitions

```
typedef struct {
    EFI_EVENT      Event;
    EFI_STATUS     TransactionStatus;
} EFI_BLOCK_IO2_TOKEN;
```

### *Event*

If *Event* is NULL, then blocking I/O is performed. If *Event* is not NULL and non-blocking I/O is supported, then non-blocking I/O is performed, and *Event* will be signaled when the read request is completed.

### *TransactionStatus*

Defines whether the signaled event encountered an error.

## Status Codes Returned

EFI_SUCCESS	The read request was queued if Token-> Event is not NULL. The data was read correctly from the device if theToken-> Event is NULL.
EFI_DEVICE_ERROR	The device reported an error while attempting to perform the read operation.
EFI_NO_MEDIA	There is no media in the device.
EFI_MEDIA_CHANGED	The <i>MediaId</i> is not for the current media.
EFI_BAD_BUFFER_SIZE	The <i>BufferSize</i> parameter is not a multiple of the intrinsic block size of the device.
EFI_INVALID_PARAMETER	The read request contains LBAs that are not valid, or the buffer is not on proper alignment.
EFI_OUT_OF_RESOURCES	The request could not be completed due to a lack of resources

## EFI\_BLOCK\_IO2\_PROTOCOL.WriteBlocksEx()

### Summary

Writes a specified number of blocks to the device.

### Prototype

```
typedef
EFI_STATUS
(EFIAPI *EFI_BLOCK_WRITE_EX) (
    IN EFI_BLOCK_IO2_PROTOCOL *This,
    IN UINT32      MediaId,
    IN EFI_LBA     LBA,
    IN OUT EFI_BLOCK_IO2_TOKEN *Token,
    IN UINTN      BufferSize,
    IN VOID        *Buffer
);
```

### Parameters

<i>This</i>	Indicates a pointer to the calling context. Type <b>EFI_BLOCK_IO2_PROTOCOL</b> is defined in the <b>EFI_BLOCK_IO2_PROTOCOL</b> description.
<i>MediaId</i>	The media ID that the write request is for.
<i>LBA</i>	The starting logical block address to be written. The caller is responsible for writing to only legitimate locations. Type <b>EFI_LBA</b> is defined in the <b>EFI_BLOCK_IO2_PROTOCOL</b> description.
<i>Token</i>	A pointer to the token associated with the transaction. Type <b>EFI_BLOCK_IO2_TOKEN</b> is defined in <b>EFI_BLOCK_IO2_PROTOCOL.ReadBlocksEx()</b> "Related Definitions".
<i>BufferSize</i>	The size in bytes of <i>Buffer</i> . This must be a multiple of the intrinsic block size of the device.
<i>Buffer</i>	A pointer to the source buffer for the data.

### Description

The **WriteBlocksEx()** function writes the requested number of blocks to the device. All blocks are written, or an error is returned.

If there is no media in the device, the function returns **EFI\_NO\_MEDIA**. If the *MediaId* is not the ID for the current media in the device, the function returns **EFI\_MEDIA\_CHANGED**. The function must return **EFI\_NO\_MEDIA** or **EFI\_MEDIA\_CHANGED** even if *LBA*, *BufferSize*, or *Buffer* are invalid so the caller can probe for changes in media state.

If **EFI\_DEVICE\_ERROR**, **EFI\_NO\_MEDIA**, **EFI\_WRITE\_PROTECTED** or **EFI\_MEDIA\_CHANGED** is returned and non-blocking I/O is being used, the *Event* associated with this request will not be signaled.



## Related Definitions

```
typedef struct {
    EFI_EVENT    Event;
    EFI_STATUS   TransactionStatus;
} EFI_BLOCK_IO2_TOKEN;
```

*Event* If *Event* is NULL, then blocking I/O is performed. If *Event* is not NULL and non-blocking I/O is supported, then non-blocking I/O is performed, and *Event* will be signaled when the write request is completed.

*TransactionStatus* Defines whether the signaled event encountered an error.

## Status Codes Returned

EFI_SUCCESS	The write request was queued if Event is not NULL. The data was written correctly to the device if the Event is NULL.
EFI_WRITE_PROTECTED	The device cannot be written to.
EFI_NO_MEDIA	There is no media in the device.
EFI_MEDIA_CHANGED	The <i>MediaId</i> is not for the current media.
EFI_DEVICE_ERROR	The device reported an error while attempting to perform the write operation.
EFI_BAD_BUFFER_SIZE	The <i>BufferSize</i> parameter is not a multiple of the intrinsic block size of the device.
EFI_INVALID_PARAMETER	The write request contains LBAs that are not valid, or the buffer is not on proper alignment.
EFI_OUT_OF_RESOURCES	The request could not be completed due to a lack of resources

## EFI\_BLOCK\_IO2\_PROTOCOL.FlushBlocksEx()

### Summary

Flushes all modified data to a physical block device.

### Prototype

```
typedef
EFI_STATUS
(EFIAPI *EFI_BLOCK_FLUSH_EX) (
  IN EFI_BLOCK_IO2_PROTOCOL *This,
  IN OUT EFI_BLOCK_IO2_TOKEN *Token,
);
```

### Parameters

<i>This</i>	Indicates a pointer to the calling context. Type <b>EFI_BLOCK_IO2_PROTOCOL</b> is defined in the <b>EFI_BLOCK_IO2_PROTOCOL</b> protocol description.
<i>Token</i>	A pointer to the token associated with the transaction. Type <b>EFI_BLOCK_IO2_TOKEN</b> is defined in <b>EFI_BLOCK_IO2_PROTOCOL.ReadBlocksEx()</b> , "Related Definitions" .

### Related Definitions

```
typedef struct {
  EFI_EVENT      Event;
  EFI_STATUS     TransactionStatus;
} EFI_BLOCK_IO2_TOKEN;
```

<i>Event</i>	If <i>Event</i> is NULL, then blocking I/O is performed. If <i>Event</i> is not NULL and non-blocking I/O is supported, then non-blocking I/O is performed, and <i>Event</i> will be signaled when the flush request is completed.
<i>TransactionStatus</i>	Defines whether the signaled event encountered an error.

### Description

The **FlushBlocksEx()** function flushes all modified data to the physical block device.

All data written to the device prior to the flush must be physically written before returning **EFI\_SUCCESS** from this function. This would include any cached data the driver may have cached, and cached data the device may have cached. A flush may cause a read request following the flush to force a device access.

If **EFI\_DEVICE\_ERROR**, **EFI\_NO\_MEDIA**, **EFI\_WRITE\_PROTECTED** or **EFI\_MEDIA\_CHANGED** is returned and non-blocking I/O is being used, the *Event* associated with this request will not be signaled.

## Status Codes Returned

EFI_SUCCESS	The flush request was queued if Event is not NULL. All outstanding data was written correctly to the device if the Event is NULL.
EFI_DEVICE_ERROR	The device reported an error while attempting to write data.
EFI_WRITE_PROTECTED	The device cannot be written to.
EFI_NO_MEDIA	There is no media in the device.
EFI_MEDIA_CHANGED	The <i>MediaId</i> is not for the current media.
EFI_OUT_OF_RESOURCES	The request could not be completed due to a lack of resources

## 13.11 Inline Cryptographic Interface Protocol

### EFI\_BLOCK\_IO\_CRYPTOPROTOCOL

#### Summary

The UEFI Inline Cryptographic Interface protocol provides services to abstract access to inline cryptographic capabilities.

The usage model of this protocol is similar to the one of the **EFI\_STORAGE\_SECURITY\_COMMAND\_PROTOCOL** where FDE (Full Disk Encryption) solutions leave ESP partition unprotected (unencrypted) allowing storage clients to continue using **EFI\_BLOCK\_IO\_PROTOCOL** or **EFI\_BLOCK\_IO2\_PROTOCOL** protocol interfaces to load OS boot components from ESP partition. For other partitions boot apps (including OS boot app) that are enlightened to take advantage of inline cryptographic capability will be empowered to use this new protocol.

## GUID

```
#define EFI_BLOCK_IO_CRYPTOPROTOCOL_GUID \
{0xa00490ba,0x3f1a,0x4b4c,\
 {0xab,0x90,0x4f,0xa9,0x97,0x26,0xa1,0xe8}}
```

## Protocol Interface Structure

```
typedef struct _EFI_BLOCK_IO_CRYPTOPROTOCOL {
    EFI_BLOCK_IO_MEDIA *Media;
    EFI_BLOCK_IO_CRYPTORESET Reset;
    EFI_BLOCK_IO_CRYPTOGETCAPABILITIES GetCapabilities;
    EFI_BLOCK_IO_CRYPTOSETCONFIGURATION SetConfiguration;
    EFI_BLOCK_IO_CRYPTOGETCONFIGURATION GetConfiguration;
    EFI_BLOCK_IO_CRYPTOREADDEVICEEXTENDED ReadExtended;
    EFI_BLOCK_IO_CRYPTOWRITEDEVICEEXTENDED WriteExtended;
    EFI_BLOCK_IO_CRYPTOFLUSH FlushBlocks;
} EFI_BLOCK_IO_CRYPTOPROTOCOL;
```

## Parameters

<i>Media</i>	A pointer to the <b>EFI_BLOCK_IO_MEDIA</b> data for this device. Type <b>EFI_BLOCK_IO_MEDIA</b> is defined in the <b>EFI_BLOCK_IO_PROTOCOL</b> section.
<i>Reset</i>	Reset the block device hardware.
<i>GetCapabilities</i>	Get the current capabilities of the ICI.
<i>SetConfiguration</i>	Set the configuration for the ICI instance.
<i>GetConfiguration</i>	Get the configuration for the ICI instance.
<i>ReadExtended</i>	Provide an extended version of the storage device read command.
<i>WriteExtended</i>	Provide an extended version of the storage device write command.
<i>FlushBlocks</i>	Flushes any cache blocks. This function is optional and only needs to be supported on block devices that cache writes.

## Related Definitions

Some functions defined for this protocol require the caller to specify the device capabilities, keys and/or attributes of the keys to be used. These parameters must be consistent with the supported capabilities as reported by the device.

```
typedef struct {
    EFI_GUID Algorithm;
    UINT64 KeySize;
    UINT64 CryptoBlockSizeBitMask;
} EFI_BLOCK_IO_CRYPTOCAPABILITY;
```

<i>Algorithm</i>	GUID of the algorithm.
------------------	------------------------

*KeySize* Specifies *KeySize* in bits used with this Algorithm.

*CryptoBlockSizeBitMask*

Specifies bitmask of block sizes supported by this algorithm. Bit *j* being set means that  $2^j$  bytes crypto block size is supported.

```
#define EFI_BLOCK_IO_CRYPTIO_ALGO_GUID_AES_XTS \
{0x2f87ba6a,\
 0x5c04,0x4385,0xa7,0x80,0xf3,0xbf,0x78,0xa9,0x7b,0xec}
```

**EFI\_BLOCK\_IO\_CRYPTIO\_ALGO\_GUID\_AES\_XTS** GUID represents Inline Cryptographic Interface capability supporting AES XTS crypto algorithm as described in *IEEE Std 1619-2007: IEEE Standard for Cryptographic Protection of Data on Block-Oriented Storage Devices*.

```
typedef struct {
  EFI_BLOCK_IO_CRYPTIO_IV_INPUT Header;
  UINT64      CryptoBlockNumber;
  UINT64      CryptoBlockSize;
} EFI_BLOCK_IO_CRYPTIO_IV_INPUT_AES_XTS;
```

**EFI\_BLOCK\_IO\_CRYPTIO\_IV\_INPUT\_AES\_XTS** structure is used as *CryptoIvInput* parameter to the *ReadExtended* and *WriteExtended* methods for Inline Cryptographic Interface supporting and using AES XTS algorithm with IV input as defined for AES XTS algorithm. IO operation (read or write) range should consist of one or more blocks of *CryptoBlockSize* size. *CryptoBlockNumber* is used as the AES XTS IV for the first crypto block and is incremented by one for each consecutive crypto block in the IO operation range.

```
#define EFI_BLOCK_IO_CRYPTIO_ALGO_GUID_AES_CBC_MICROSOFT_BITLOCKER \
{0x689e4c62,\
 0x70bf,0x4cf3,0x88,0xbb,0x33,0xb3,0x18,0x26,0x86,0x70}
```

**EFI\_BLOCK\_IO\_CRYPTIO\_ALGO\_GUID\_AES\_CBC\_MICROSOFT\_BITLOCKER** GUID represents Inline Cryptographic Interface capability supporting AES CBC crypto algorithm in the *non-diffuser* mode as described in following Microsoft white paper, section 4: See “Links to UEFI-Related Documents” (<http://uefi.org/uefi>) under the heading “Inline Cryptographic Interface--Bit Locker Cipher”. It is important to note that when excluding diffuser operations (A diffuser and B diffuser) described in the above document one should also exclude derivation of sector key and XOR-ing it with plaintext as that operation is part of the diffuser part of the algorithm and does not belong to the AES-CBC Microsoft BitLocker algorithm being referred to here.

```
typedef struct {
  EFI_BLOCK_IO_CRYPTIO_IV_INPUT Header;
  UINT64      CryptoBlockByteOffset;
  UINT64      CryptoBlockSize;
} EFI_BLOCK_IO_CRYPTIO_IV_INPUT_AES_CBC_MICROSOFT_BITLOCKER;
```

**EFI\_BLOCK\_IO\_CRYPTIO\_IV\_INPUT\_AES\_CBC\_MICROSOFT\_BITLOCKER** structure is used to pass as *CryptoIvInput* parameter to the *ReadExtended* and *WriteExtended* methods for Inline Cryptographic Interface supporting and using AES CBC algorithm with IV input as defined for

Microsoft BitLocker Drive Encryption. IO operation (read or write) range should consist of one or more blocks of *CryptoBlockByteSize* size. *CryptoBlockByteOffset* is used as the AES CBC Microsoft Bitlocker algorithm IV for the first crypto block and is incremented by *CryptoBlockByteSize* for each consecutive crypto block in the IO operation range.

```
typedef struct {
    UINT64    InputSize;
} EFI_BLOCK_IO_CRYPTO_IV_INPUT;
```

**EFI\_BLOCK\_IO\_CRYPTO\_IV\_INPUT** structure is used as a common header in *CryptolvlInput* parameters passed to the ReadExtended and WriteExtended methods for Inline Cryptographic Interface. Its purpose is to pass size of the entire *CryptolvlInput* parameter memory buffer to the Inline Cryptographic Interface.

Further extensions of crypto algorithm support by Inline Cryptographic Interface should follow the same pattern established above for the AES XTS and AES CBC Microsoft BitLocker algorithms. In particular each added crypto algorithm should:

- Define its crypto algorithm GUID using following pattern:  
**#define EFI\_BLOCK\_IO\_CRYPTO\_ALGO\_GUID\_<algo-name> {<algo-guid>}**
- Define its corresponding *CryptolvlInput* parameter structure and describe how it is populated for each IO operation (read / write):

```
typedef struct {
    EFI_BLOCK_IO_CRYPTO_IV_INPUT    Header;
    <TBD>                            <TBD>;
} EFI_BLOCK_IO_CRYPTO_IV_INPUT_<algo-name>;
```

```
#define EFI_BLOCK_IO_CRYPTO_INDEX_ANY 0xFFFFFFFFFFFFFFFF
typedef struct {
    BOOLEAN        Supported;
    UINT64        KeyCount;
    UINT64        CapabilityCount;
    EFI_BLOCK_IO_CRYPTO_CAPABILITY    Capabilities[1];
} EFI_BLOCK_IO_CRYPTO_CAPABILITIES;
```

<i>Supported</i>	Is inline cryptographic capability supported on this device.
<i>KeyCount</i>	Maximum number of keys that can be configured at the same time.
<i>CapabilityCount</i>	Number of supported capabilities.
<i>Capabilities</i>	Array of supported capabilities.

```
typedef struct {
    UINT64      Index;
    EFI_GUID    KeyOwnerGuid;
    EFI_BLOCK_IO_CRYPTO_CAPABILITY Capability;
    VOID        *CryptoKey;
} EFI_BLOCK_IO_CRYPTO_CONFIGURATION_TABLE_ENTRY;
```

<i>Index</i>	Configuration table index. A special <b>EFI_BLOCK_IO_CRYPTO_INDEX_ANY</b> can be used to set any available entry in the configuration table.
<i>KeyOwnerGuid</i>	Identifies the owner of the configuration table entry. Entry can also be used with the Nil value to clear key from the configuration table index.
<i>Capability</i>	A supported capability to be used. The <i>CryptoBlockSizeBitMask</i> field of the structure should have only one bit set from the supported mask.
<i>CryptoKey</i>	Pointer to the key. The size of the key is defined by the <i>KeySize</i> field of the capability specified by the Capability parameter.

```
typedef struct {
    UINT64      Index;
    EFI_GUID    KeyOwnerGuid;
    EFI_BLOCK_IO_CRYPTO_CAPABILITY Capability;
} EFI_BLOCK_IO_CRYPTO_RESPONSE_CONFIGURATION_ENTRY;
```

<i>Index</i>	Configuration table index.
<i>KeyOwnerGuid</i>	Identifies the current owner of the entry.
<i>Capability</i>	The capability to be used. The <i>CryptoBlockSizeBitMask</i> field of the structure has only one bit set from the supported mask.

## Description

The **EFI\_BLOCK\_IO\_CRYPTO\_PROTOCOL** defines a UEFI protocol that can be used by UEFI drivers and applications to perform block encryption on a storage device, such as UFS.

The **EFI\_BLOCK\_IO\_CRYPTO\_PROTOCOL** instance will be on the same handle as the device path of the inline encryption device.

While this protocol is intended to abstract the encryption process for block device access, the protocol user does not have to be aware of the specific underlying encryption hardware.

## EFI\_BLOCK\_IO\_CRYPTOPROTOCOL.Reset()

### Summary

Resets the block device hardware.

### Prototype

```
typedef
EFI_STATUS
(EFIAPI *EFI_BLOCK_IO_CRYPTORESET) (
    IN EFI_BLOCK_IO_CRYPTOPROTOCOL *This,
    IN BOOLEAN ExtendedVerification
);
```

### Parameters

*This* Pointer to the **EFI\_BLOCK\_IO\_CRYPTOPROTOCOL** instance.

*ExtendedVerification* Indicates that the driver may perform a more exhaustive verification operation of the device during reset.

### Description

The **Reset()** function resets the block device hardware.

As part of the initialization process, the firmware/device will make a quick but reasonable attempt to verify that the device is functioning. If the *ExtendedVerification* flag is TRUE the firmware may take an extended amount of time to verify the device is operating on reset. Otherwise the reset operation is to occur as quickly as possible.

The hardware verification process is not defined by this specification and is left up to the platform firmware or driver to implement.

### Status Codes Returned

EFI_SUCCESS	The block device was reset.
EFI_DEVICE_ERROR	The block device is not functioning correctly and could not be reset.
EFI_INVALID_PARAMETER	<i>This</i> is NULL.



## EFI\_BLOCK\_IO\_CRYPTOPROTOCOL.GetCapabilities()

### Summary

Get the capabilities of the underlying inline cryptographic interface.

### Prototype

```
typedef EFI_STATUS
(EFI_API *EFI_BLOCK_IO_CRYPTOPROTOCOL_GET_CAPABILITIES) (
    IN EFI_BLOCK_IO_CRYPTOPROTOCOL *This,
    OUT EFI_BLOCK_IO_CRYPTOPROTOCOL_CAPABILITIES *Capabilities
);
```

### Parameters

<i>This</i>	Pointer to the <b>EFI_BLOCK_IO_CRYPTOPROTOCOL</b> instance.
<i>Capabilities</i>	Pointer to the <b>EFI_BLOCK_IO_CRYPTOPROTOCOL_CAPABILITIES</b> structure.

### Description

The **GetCapabilities()** function determines whether pre-OS controllable inline crypto is supported by the system for the current disk and, if so, returns the capabilities of the crypto engine.

The caller is responsible for providing the Capabilities structure with a sufficient number of entries. If the structure is too small, the **EFI\_BUFFER\_TOO\_SMALL** error code is returned and the CapabilityCount field contains the number of entries needed to contain the capabilities.

### Status Codes Returned

EFI_SUCCESS	The ICI is ready for use.
EFI_BUFFER_TOO_SMALL	The Capabilities structure was too small. The number of entries needed is returned in the CapabilityCount field of the structure.
EFI_NO_RESPONSE	No response was received from the ICI
EFI_DEVICE_ERROR	An error occurred when attempting to access the ICI
EFI_INVALID_PARAMETER	<i>This</i> is <b>NULL</b> .
EFI_INVALID_PARAMETER	Capabilities is NULL

## EFI\_BLOCK\_IO\_CRYPTOPROTOCOL.SetConfiguration()

### Summary

Set the configuration of the underlying inline cryptographic interface.

### Prototype

```
typedef EFI_STATUS
(EFI_API *EFI_BLOCK_IO_CRYPTOPROTOCOL_SET_CONFIGURATION) (
    IN EFI_BLOCK_IO_CRYPTOPROTOCOL *This,
    IN UINT64 ConfigurationCount,
    IN EFI_BLOCK_IO_CRYPTOPROTOCOL_CONFIGURATION_TABLE_ENTRY
    *ConfigurationTable,
    OUT EFI_BLOCK_IO_CRYPTOPROTOCOL_RESPONSE_CONFIGURATION_ENTRY
    *ResultingTable OPTIONAL
);
```

### Parameters

<i>This</i>	Pointer to the <b>EFI_BLOCK_IO_CRYPTOPROTOCOL</b> instance.
<i>ConfigurationCount</i>	Number of entries being configured with this call.
<i>ConfigurationTable</i>	Pointer to a table used to populate the configuration table.
<i>ResultingTable</i>	Optional pointer to a table that receives the newly configured entries.

### Description

The **SetConfiguration()** function allows the user to set the current configuration of the inline cryptographic interface and should be called before attempting any crypto operations.

This configures the configuration table entries with algorithms, key sizes and keys. Each configured entry can later be referred to by index at the time of storage transaction.

The configuration table index will refer to the combination of KeyOwnerGuid, Algorithm, and CryptoKey.

KeyOwnerGuid identifies the component taking ownership of the entry. It helps components to identify their own entries, cooperate with other owner components, and avoid conflicts. This Guid identifier is there to help coordination between cooperating components and not a security or synchronization feature. The Nil GUID can be used by a component to release use of entry owned. It is also used to identify potentially available entries (see GetConfiguration).

CryptoKey specifies algorithm-specific key material to use within parameters of selected crypto capability.

This function is called infrequently – typically once, on device start, before IO starts. It can be called at later times in cases the number of keys used on the drive is higher than what can be configured at a time or a new key has to be added.

Components setting or changing an entry or entries for a given index or indices must ensure that IO referencing affected indices is temporarily blocked (run-down) at the time of change.

Indices parameters in each parameter table entry allow to set only a portion of the available table entries in the crypto module anywhere from single entry to entire table supported.

If corresponding table entry or entries being set are already in use by another owner the call should be failed and none of the entries should be modified. The interface implementation must enforce atomicity of this operation (should either succeed fully or fail completely without modifying state). Note that components using GetConfiguration command to discover available entries should be prepared that by the time of calling SetConfiguration the previously available entry may have become occupied. Such components should be prepared to re-try the sequence of operations. Alternatively **EFI\_BLOCK\_IO\_CRYPT0\_INDEX\_ANY** can be used to have the implementation discover and allocate available, if any, indices atomically.

An optional ResultingTable pointer can be provided by the caller to receive the newly configured entries. The array provided by the caller must have at least ConfigurationCount of entries.

## Status Codes Returned

EFI_SUCCESS	The ICI is ready for use.
EFI_NO_RESPONSE	No response was received from the ICI
EFI_DEVICE_ERROR	An error occurred when attempting to access the ICI
EFI_INVALID_PARAMETER	<i>This is <b>NULL</b>.</i>
EFI_INVALID_PARAMETER	<i>ConfigurationTable is NULL</i>
EFI_INVALID_PARAMETER	<i>ConfigurationCount is 0</i>
EFI_OUT_OF_RESOURCES	Could not find the requested number of available entries in the configuration table.

## EFI\_BLOCK\_IO\_CRYPTOPROTOCOL.GetConfiguration()

### Summary

Get the configuration of the underlying inline cryptographic interface.

### Prototype

```
typedef EFI_STATUS
(EFI_API *EFI_BLOCK_IO_CRYPTOPROTOCOL_GET_CONFIGURATION) (
    IN EFI_BLOCK_IO_CRYPTOPROTOCOL *This,
    IN UINT64 StartIndex,
    IN UINT64 ConfigurationCount,
    IN EFI_GUID *KeyOwnerGuid OPTIONAL,
    OUT EFI_BLOCK_IO_CRYPTOPROTOCOL_RESPONSE_CONFIGURATION_ENTRY
    *ConfigurationTable
);
```

### Parameters

<i>This</i>	Pointer to the <b>EFI_BLOCK_IO_CRYPTOPROTOCOL</b> instance.
<i>StartIndex</i>	Configuration table index at which to start the configuration query.
<i>ConfigurationCount</i>	Number of entries to return in the response table.
<i>KeyOwnerGuid</i>	Optional parameter to filter response down to entries with a given owner. A pointer to the Nil value can be used to return available entries. Set to NULL when no owner filtering is required.
<i>ConfigurationTable</i>	Table of configured configuration table entries (with no CryptoKey returned): configuration table index, <i>KeyOwnerGuid</i> , Capability. Should have sufficient space to store up to <i>ConfigurationCount</i> entries.

### Description

The **GetConfiguration()** function allows the user to get the configuration of the inline cryptographic interface.

Retrieves, entirely or partially, the currently configured key table. Note that the keys themselves are not retrieved, but rather just indices, owner GUIDs and capabilities.

If fewer entries than specified by *ConfigurationCount* are returned, the Index field of the unused entries is set to **EFI\_BLOCK\_IO\_CRYPTOPROTOCOL\_INDEX\_ANY**.

### Status Codes Returned

EFI_SUCCESS	The ICI is ready for use.
EFI_NO_RESPONSE	No response was received from the ICI
EFI_DEVICE_ERROR	An error occurred when attempting to access the ICI

EFI_INVALID_PARAMETER	<i>This</i> is <b>NULL</b> .
EFI_INVALID_PARAMETER	Configuration table is NULL
EFI_INVALID_PARAMETER	<i>StartIndex</i> is out of bounds

## EFI\_BLOCK\_IO\_CRYPTO\_PROTOCOL.ReadExtended()

### Summary

Reads the requested number of blocks from the device and optionally decrypts them inline.

### Prototype

```
typedef EFI_STATUS
(EFIAPI *EFI_BLOCK_IO_CRYPTO_READ_EXTENDED) (
    IN EFI_BLOCK_IO_CRYPTO_PROTOCOL *This,
    IN UINT32          MediaId,
    IN EFI_LBA        LBA,
    IN OUT EFI_BLOCK_IO_CRYPTO_TOKEN *Token,
    IN UINT64         BufferSize,
    OUT VOID          *Buffer,
    IN UINT64         *Index OPTIONAL,
    IN VOID           *CryptolvlInput OPTIONAL
);
```

### Parameters

<i>This</i>	Pointer to the <b>EFI_BLOCK_IO_CRYPTO_PROTOCOL</b> instance.
<i>MediaId</i>	The media ID that the read request is for.
<i>LBA</i>	The starting logical block address to read from on the device. Type <b>EFI_LBA</b> is defined in the <b>EFI_BLOCK_IO_PROTOCOL</b> description.
<i>Token</i>	A pointer to the token associated with the transaction. Type <b>EFI_BLOCK_IO_CRYPTO_TOKEN</b> is defined in “Related Definitions” below.
<i>BufferSize</i>	The size of the <i>Buffer</i> in bytes. This must be a multiple of the intrinsic block size of the device.
<i>Buffer</i>	A pointer to the destination buffer for the data. The caller is responsible for either having implicit or explicit ownership of the buffer.
<i>Index</i>	A pointer to the configuration table index. This is optional.
<i>CryptolvlInput</i>	A pointer to a buffer that contains additional cryptographic parameters as required by the capability referenced by the configuration table index, such as cryptographic initialization vector.

### Description

The **ReadExtended()** function allows the caller to perform a storage device read operation. The function reads the requested number of blocks from the device and then if *Indexis*

specified decrypts them inline. All the blocks are read and decrypted (if decryption requested), or an error is returned.

If there is no media in the device, the function returns **EFI\_NO\_MEDIA**. If the *MediaId* is not the ID for the current media in the device, the function returns **EFI\_MEDIA\_CHANGED**.

If **EFI\_DEVICE\_ERROR**, **EFI\_NO\_MEDIA**, or **EFI\_MEDIA\_CHANGED** is returned and non-blocking I/O is being used, the *Event* associated with this request will not be signaled.

In addition to standard storage transaction parameters (LBA, IO size, and buffer), this command will also specify a configuration table *Index* and *CryptovInput* when data has to be decrypted inline by the controller after being read from the storage device. If an *Index* parameter is not specified, no decryption is performed.

## Related Definitions

```
typedef struct {
    EFI_EVENT    Event;
    EFI_STATUS    TransactionStatus;
} EFI_BLOCK_IO_CRYPTO_TOKEN;
```

*Event* If *Event* is NULL, then blocking I/O is performed. If *Event* is not NULL and non-blocking I/O is supported, then non-blocking I/O is performed, and *Event* will be signaled when the read request is completed and data was decrypted (when *Index* was specified).

*TransactionStatus* Defines whether or not the signaled event encountered an error.

## Status Codes Returned

EFI_SUCCESS	The read request was queued if Token-> Event is not NULL. The data was read correctly from the device if the Token-> Event is NULL.
EFI_DEVICE_ERROR	The device reported an error while attempting to perform the read operation and/or decryption operation.
EFI_NO_MEDIA	There is no media in the device.
EFI_MEDIA_CHANGED	The <i>MediaId</i> is not for the current media.
EFI_BAD_BUFFER_SIZE	The <i>BufferSize</i> parameter is not a multiple of the intrinsic block size of the device.
EFI_INVALID_PARAMETER	<i>This</i> is NULL, or the read request contains LBAs that are not valid, or the buffer is not on proper alignment
EFI_INVALID_PARAMETER	<i>CryptovInput</i> is incorrect.
EFI_OUT_OF_RESOURCES	The request could not be completed due to a lack of resources.

## EFI\_BLOCK\_IO\_CRYPTOPROTOCOL.WriteExtended()

### Summary

Optionally encrypts a specified number of blocks inline and then writes to the device.

### Prototype

```
typedef EFI_STATUS
(EFI_API *EFI_BLOCK_IO_CRYPTOWRITE_EXTENDED) (
    IN EFI_BLOCK_IO_CRYPTOPROTOCOL *This,
    IN UINT32          MediaId,
    IN EFI_LBA        LBA,
    IN OUT EFI_BLOCK_IO_CRYPTOTOKEN *Token,
    IN UINT64         BufferSize,
    IN VOID            *Buffer,
    IN UINT64         *Index, OPTIONAL
    IN VOID            *CryptoInput OPTIONAL
);
```

### Parameters

<i>This</i>	Pointer to the <b>EFI_BLOCK_IO_CRYPTOPROTOCOL</b> instance.
<i>MediaId</i>	The media ID that the read request is for.
<i>LBA</i>	The starting logical block address to read from on the device. Type <b>EFI_LBA</b> is defined in the <b>EFI_BLOCK_IO_PROTOCOL</b> description.
<i>Token</i>	A pointer to the token associated with the transaction. Type <b>EFI_BLOCK_IO_CRYPTOTOKEN</b> is defined in “Related Definitions” section for <b>ReadExtended()</b> function above.
<i>BufferSize</i>	The size of the <i>Buffer</i> in bytes. This must be a multiple of the intrinsic block size of the device.
<i>Buffer</i>	A pointer to the source buffer for the data.
<i>Index</i>	A pointer to the configuration table index. This is optional.
<i>CryptoInput</i>	A pointer to a buffer that contains additional cryptographic parameters as required by the capability referenced by the configuration table index, such as cryptographic initialization vector.

### Description

The **WriteExtended()** function allows the caller to perform a storage device write operation. The function encrypts the requested number of blocks inline if *Index* is specified



and then writes them to the device. All the blocks are encrypted (if encryption requested) and written, or an error is returned.

If there is no media in the device, the function returns **EFI\_NO\_MEDIA**. If the *MediaId* is not the ID for the current media in the device, the function returns **EFI\_MEDIA\_CHANGED**.

If **EFI\_DEVICE\_ERROR**, **EFI\_NO\_MEDIA**, **EFI\_WRITE\_PROTECTED** or **EFI\_MEDIA\_CHANGED** is returned and non-blocking I/O is being used, the *Event* associated with this request will not be signaled.

In addition to standard storage transaction parameters (LBA, IO size, and buffer), this command will also specify a configuration table *Index* and a *CryptoIvInput* when data has to be encrypted inline by the controller before being written to the storage device. If no *Index* parameter is specified, no encryption is performed.

### Status Codes Returned

EFI_SUCCESS	The request to encrypt (optionally) and write was queued if Event is not NULL. The data was encrypted (optionally) and written correctly to the device if the Event is NULL.
EFI_WRITE_PROTECTED	The device cannot be written to.
EFI_NO_MEDIA	There is no media in the device.
EFI_MEDIA_CHANGED	The <i>MediaId</i> is not for the current media.
EFI_DEVICE_ERROR	The device reported an error while attempting to encrypt blocks or to perform the write operation.
EFI_BAD_BUFFER_SIZE	The <i>BufferSize</i> parameter is not a multiple of the intrinsic block size of the device.
EFI_INVALID_PARAMETER	<i>This</i> is <b>NULL</b> , or the write request contains LBAs that are not valid, or the buffer is not on proper alignment.
EFI_INVALID_PARAMETER	<i>CryptoIvInput</i> is incorrect.
EFI_OUT_OF_RESOURCES	The request could not be completed due to a lack of resources.

## EFI\_BLOCK\_IO\_CRYPTOPROTOCOL.FlushBlocks()

### Summary

Flushes all modified data to a physical block device.

### Prototype

```
typedef EFI_STATUS
(EFI_API *EFI_BLOCK_IO_CRYPTOPROTOCOL_FLUSH) (
  IN EFI_BLOCK_IO_CRYPTOPROTOCOL *This,
  IN OUT EFI_BLOCK_IO_CRYPTOPROTOCOL_TOKEN *Token
);
```

### Parameters

<i>This</i>	Pointer to the <b>EFI_BLOCK_IO_CRYPTOPROTOCOL</b> instance.
<i>Token</i>	A pointer to the token associated with the transaction. Type <b>EFI_BLOCK_IO_CRYPTOPROTOCOL_TOKEN</b> is defined in “Related Definitions” section for <b>ReadExtended()</b> function above.

### Description

The **FlushBlocks()** function flushes all modified data to the physical block device. Any modified data that has to be encrypted must have been already encrypted as a part of **WriteExtended()** operation – inline crypto operation cannot be a part of flush operation.

All data written to the device prior to the flush must be physically written before returning **EFI\_SUCCESS** from this function. This would include any cached data the driver may have cached, and cached data the device may have cached. A flush may cause a read request following the flush to force a device access.

If **EFI\_DEVICE\_ERROR**, **EFI\_NO\_MEDIA**, **EFI\_WRITE\_PROTECTED** or **EFI\_MEDIA\_CHANGED** is returned and non-blocking I/O is being used, the *Event* associated with this request will not be signaled.

## Status Codes Returned

EFI_SUCCESS	The flush request was queued if <i>Event</i> is not NULL. All outstanding data was written correctly to the device if the <i>Event</i> is NULL.
EFI_DEVICE_ERROR	The device reported an error while attempting to write data.
EFI_WRITE_PROTECTED	The device cannot be written to.
EFI_NO_MEDIA	There is no media in the device.
EFI_MEDIA_CHANGED	The <i>MediaId</i> is not for the current media.
EFI_INVALID_PARAMETER	<i>This is NULL.</i>
EFI_OUT_OF_RESOURCES	The request could not be completed due to a lack of resources.

## 13.12 Erase Block Protocol

### EFI\_ERASE\_BLOCK\_PROTOCOL

#### Summary

This protocol provides the ability for a device to expose erase functionality. This optional protocol is installed on the same handle as the **EFI\_BLOCK\_IO\_PROTOCOL** or **EFI\_BLOCK\_IO2\_PROTOCOL**.

#### GUID

```
#define EFI_ERASE_BLOCK_PROTOCOL_GUID \
{0x95A9A93E, 0x A86E, 0x4926, \
{0xaa, 0xef, 0x99, 0x18, 0xe7, 0x72, 0xd9, 0x87}}
```

#### Revision Number

```
#define EFI_ERASE_BLOCK_PROTOCOL_REVISION ((2<<16) | (60))
```

#### Protocol Interface Structure

```
typedef struct _EFI_ERASE_BLOCK_PROTOCOL {
    UINT64      Revision;
    UINT32      EraseLengthGranularity;
    EFI_BLOCK_ERASE EraseBlocks;
} EFI_ERASE_BLOCK_PROTOCOL;
```

#### Parameters

*Revision*

The revision to which the **EFI\_ERASE\_BLOCK\_PROTOCOL** adheres. All future revisions must be backwards compatible. If a future version is not backwards compatible, it is not the same GUID.

*EraseLengthGranularity*

*EraseBlocks*

Returns the erase length granularity as a number of logical blocks. A value of 1 means the erase granularity is one logical block.

Erase the requested number of blocks from the device. See the **EraseBlocks()** function description.

## EFI\_ERASE\_BLOCK\_PROTOCOL.EraseBlocks()

### Summary

Erase a specified number of device blocks.

### Prototype

```

Typedef
EFI_STATUS
(EFI_API *EFI_BLOCK_ERASE)
IN EFI_BLOCK_IO_PROTOCOL *This,
IN UINT32      MediaId,
IN EFI_LBA     LBA,
IN OUT EFI_ERASE_BLOCK_TOKEN *Token,
IN UINTN      Size
);

```

### Parameters

<i>This</i>	Indicates a pointer to the calling context. Type is defined in the <b>EFI_ERASE_BLOCK_PROTOCOL</b> description.
<i>MediaId</i>	The media ID that the erase request is for.
<i>LBA</i>	The starting logical block address to be erased. The caller is responsible for erasing only legitimate locations. Type <b>EFI_LBA</b> is defined in the <b>EFI_BLOCK_IO_PROTOCOL</b> description.
<i>Token</i>	A pointer to the token associated with the transaction. Type <b>EFI_ERASE_BLOCK_TOKEN</b> is defined in "Related Definitions" below.
<i>Size</i>	The size in bytes to be erased. This must be a multiple of the physical block size of the device.

### Description

The **EraseBlocks()** function erases the requested number of device blocks. Upon the successful execution of **EraseBlocks()** with an **EFI\_SUCCESS** return code, any subsequent reads of the same LBA range would return an initialized/formatted value.

If there is no media in the device, the function returns **EFI\_NO\_MEDIA**. If the *MediaId* is not the ID for the current media in the device, the function returns **EFI\_MEDIA\_CHANGED**. The function must return **EFI\_NO\_MEDIA** or **EFI\_MEDIA\_CHANGED** even if *LBA* or *Size* are invalid so the caller can probe for changes in media state.

It is the intention of the **EraseBlocks()** operation to be at least as performant as writing zeroes to each of the specified LBA locations while ensuring the equivalent security.

On some devices, the granularity of the erasable units is defined by *EraseLengthGranularity* which is the smallest number of consecutive blocks which can be addressed for erase. The size of the *EraseLengthGranularity* is device specific and can be

obtained from **EFI\_ERASE\_BLOCK\_MEDIA** structure. The fields of **EFI\_ERASE\_MEDIA** are not the same as **EFI\_BLOCK\_IO\_MEDIA**, so look at the **EFI\_BLOCK\_IO\_PROTOCOL** and/or **EFI\_BLOCK\_IO2\_PROTOCOL** on the handle for the complete list of fields, if needed. For optimal performance, the starting **LBA** to be erased shall be *EraseLengthGranularity* aligned and the Size shall be an integer multiple of an *EraseLengthGranularity*.

### Related Definitions

```
typedef struct {
    EFI_EVENT Event;
    EFI_STATUS TransactionStatus;
} EFI_ERASE_BLOCK_TOKEN;
```

*Event* If *Event* is **NULL**, then blocking I/O is performed. If *Event* is not **NULL** and non-blocking I/O is supported, then non-blocking I/O is performed, and *Event* will be signaled when the erase request is completed.

*TransactionStatus* Defines whether the signaled event encountered an error.

### Status Codes Returned

EFI_SUCCESS	The erase request was queued if <i>Event</i> is not NULL. The data was erased correctly to the device if the <i>Event</i> is NULL to the device.
EFI_WRITE_PROTECTED	The device cannot be erased due to write protection.
EFI_DEVICE_ERROR	The device reported an error while attempting to perform the erase operation.
EFI_INVALID_PARAMETER	The erase request contains LBAs that are not valid.
EFI_NO_MEDIA	There is no media in the device.
EFI_MEDIA_CHANGED	The <i>MediaId</i> is not for the current media.

## 13.13 ATA Pass Thru Protocol

### EFI\_ATA\_PASS\_THRU\_PROTOCOL

This section provides a detailed description of the **EFI\_ATA\_PASS\_THRU\_PROTOCOL**.

#### Summary

Provides services that allow ATA commands to be sent to ATA Devices attached to an ATA controller. Packet-based commands would be sent to ATAPI devices only through the Extended SCSI Pass Thru Protocol. While the **ATA\_PASS\_THRU** interface would expose an interface to the underlying ATA devices on an ATA controller, **EXT\_SCSI\_PASS\_THRU** is responsible for exposing a packet-based command interface for the ATAPI devices on the same ATA controller.

## GUID

```
#define EFI_ATA_PASS_THRU_PROTOCOL_GUID \
{0x1d3de7f0,0x807,0x424f,\
{0xaa,0x69,0x11,0xa5,0x4e,0x19,0xa4,0x6f}}
```

## Protocol Interface Structure

```
typedef struct _EFI_ATA_PASS_THRU_PROTOCOL {
  EFI_ATA_PASS_THRU_MODE      *Mode;
  EFI_ATA_PASS_THRU_PASSTHRU  PassThru;
  EFI_ATA_PASS_THRU_GET_NEXT_PORT  GetNextPort;
  EFI_ATA_PASS_THRU_GET_NEXT_DEVICE  GetNextDevice;
  EFI_ATA_PASS_THRU_BUILD_DEVICE_PATH  BuildDevicePath;
  EFI_ATA_PASS_THRU_GET_DEVICE  GetDevice;
  EFI_ATA_PASS_THRU_RESET_PORT  ResetPort;
  EFI_ATA_PASS_THRU_RESET_DEVICE  ResetDevice;
} EFI_ATA_PASS_THRU_PROTOCOL;
```

## Parameters

### *Mode*

A pointer to the **EFI\_ATA\_PASS\_THRU\_MODE** data for this ATA controller. **EFI\_ATA\_PASS\_THRU\_MODE** is defined in “Related Definitions” below.

### *PassThru*

Sends an ATA command to an ATA device that is connected to the ATA controller. See the **PassThru()** function description.

### *GetNextPort*

Retrieves the list of legal ports for ATA devices on an ATA controller. See the **GetNextPort()** function description.

### *GetNextDevice*

Retrieves the list of legal ATA devices on a specific port of an ATA controller. See the **GetNextDevice()** function description.

### *BuildDevicePath*

Allocates and builds a device path node for an ATA Device on an ATA controller. See the **BuildDevicePath()** function description.

### *GetDevice*

Translates a device path node to a port and port multiplier port. See the **GetDevice()** function description.

### *ResetPort*

Resets an ATA port or channel (PATA). This operation resets all the ATA devices connected to the ATA port or channel. See the **ResetPort()** function description.

*ResetDevice*

Resets an ATA device that is connected to the ATA controller. See the **ResetDevice()** function description.

**Note:** The following data values in the **EFI\_ATA\_PASS\_THRU\_MODE** interface are read-only.

*Attributes*

Additional information on the attributes of the ATA controller. See “Related Definitions” below for the list of possible attributes.

*IoAlign*

Supplies the alignment requirement for any buffer used in a data transfer. *IoAlign* values of 0 and 1 mean that the buffer can be placed anywhere in memory. Otherwise, *IoAlign* must be a power of 2, and the requirement is that the start address of a buffer must be evenly divisible by *IoAlign* with no remainder.

**Related Definitions**

```
typedef struct {
    UINT32 Attributes;
    UINT32 IoAlign;
} EFI_ATA_PASS_THRU_MODE;
```

```
#define EFI_ATA_PASS_THRU_ATTRIBUTES_PHYSICAL 0x0001
#define EFI_ATA_PASS_THRU_ATTRIBUTES_LOGICAL 0x0002
#define EFI_ATA_PASS_THRU_ATTRIBUTES_NONBLOCKIO 0x0004
```

**EFI\_ATA\_PASS\_THRU\_ATTRIBUTES\_PHYSICAL**

If this bit is set, then the **EFI\_ATA\_PASS\_THRU\_PROTOCOL** interface is for physical devices on the ATA controller.

**EFI\_ATA\_PASS\_THRU\_ATTRIBUTES\_LOGICAL**

If this bit is set, then the **EFI\_ATA\_PASS\_THRU\_PROTOCOL** interface is for logical devices on the ATA controller.

**EFI\_ATA\_PASS\_THRU\_ATTRIBUTES\_NONBLOCKIO**

If this bit is set, then the **EFI\_ATA\_PASS\_THRU\_PROTOCOL** interface supports non blocking I/O. Every **EFI\_ATA\_PASS\_THRU\_PROTOCOL** must support blocking I/O. The support of non-blocking I/O is optional.



## Description

The **EFI\_ATA\_PASS\_THRU\_PROTOCOL** provides information about an ATA controller and the ability to send ATA Command Blocks to any ATA device attached to that ATA controller. To send ATAPI command blocks to ATAPI device attached to that ATA controller, use the **EXT\_SCSI\_PASS\_THRU\_PROTOCOL** interface.

The ATAPI devices support a small set of the non-packet-based ATA commands. The **EFI\_ATA\_PASS\_THRU\_PROTOCOL** may be used to send such ATA commands to ATAPI devices.

The printable name for the controller can be provided through the **EFI\_COMPONENT\_NAME2\_PROTOCOL** for multiple languages.

The *Attributes* field of the Mode member of the **EFI\_ATA\_PASS\_THRU\_PROTOCOL** interface tells if the interface is for physical ATA devices or logical ATA devices. Drivers for non-RAID ATA controllers will set both the **EFI\_ATA\_PASS\_THRU\_ATTRIBUTES\_PHYSICAL**, and the **EFI\_ATA\_PASS\_THRU\_ATTRIBUTES\_LOGICAL** bits.

Drivers for RAID controllers that allow access to the physical devices and logical devices will produce two **EFI\_ATA\_PASS\_THRU\_PROTOCOL** interfaces: one with the just the **EFI\_ATA\_PASS\_THRU\_ATTRIBUTES\_PHYSICAL** bit set and another with just the **EFI\_ATA\_PASS\_THRU\_ATTRIBUTES\_LOGICAL** bit set. One interface can be used to access the physical devices attached to the RAID controller, and the other can be used to access the logical devices attached to the RAID controller for its current configuration.

Drivers for RAID controllers that do not allow access to the physical devices will produce one **EFI\_ATA\_PASS\_THROUGH\_PROTOCOL** interface with just the **EFI\_ATA\_PASS\_THRU\_ATTRIBUTES\_LOGICAL** bit set. The interface for logical devices can also be used by a file system driver to mount the RAID volumes. An **EFI\_ATA\_PASS\_THRU\_PROTOCOL** with neither **EFI\_ATA\_PASS\_THRU\_ATTRIBUTES\_LOGICAL** nor **EFI\_ATA\_PASS\_THRU\_ATTRIBUTES\_PHYSICAL** set is an illegal configuration.

The Attributes field also contains the **EFI\_ATA\_PASS\_THRU\_ATTRIBUTES\_NONBLOCKIO** bit. All **EFI\_ATA\_PASS\_THRU\_PROTOCOL** interfaces must support blocking I/O. If this bit is set, then the interface supports both blocking I/O and non-blocking I/O.

Each **EFI\_ATA\_PASS\_THRU\_PROTOCOL** instance must have an associated device path. Typically this will have an ACPI device path node and a PCI device path node, although variation will exist.

Additional information about the ATA controller can be obtained from protocols attached to the same handle as the **EFI\_ATA\_PASS\_THRU\_PROTOCOL**, or one of its parent handles. This would include the device I/O abstraction used to access the internal registers and functions of the ATA controller.

This protocol may also be used for PATA devices (or devices in a PATA-compatible mode). PATA devices are mapped to ports and port multiplier ports using the following table:

**Table 110. PATA device mapping to ports and port multiplier ports**

PATA Device Connection	Emulated Port Number	Emulated Port Multiplier Port Number
Primary Master	0	0
Primary Slave	0	1
Secondary Master	1	0
Secondary Slave	1	1

## EFI\_ATA\_PASS\_THRU\_PROTOCOL.PassThru()

### Summary

Sends an ATA command to an ATA device that is attached to the ATA controller. This function supports both blocking I/O and non-blocking I/O. The blocking I/O functionality is required, and the non-blocking I/O functionality is optional.

### Prototype

```
typedef
EFI_STATUS
(EFI_API *EFI_ATA_PASS_THRU_PASSTHRU) (
  IN EFI_ATA_PASS_THRU_PROTOCOL *This,
  IN UINT16 Port,
  IN UINT16 PortMultiplierPort,
  IN OUT EFI_ATA_PASS_THRU_COMMAND_PACKET *Packet,
  IN EFI_EVENT Event OPTIONAL
);
```

### Parameters

#### *This*

A pointer to the **EFI\_ATA\_PASS\_THRU\_PROTOCOL** instance.

#### *Port*

The port number of the ATA device to send the command.

#### *PortMultiplierPort*

The port multiplier port number of the ATA device to send the command. If there is no port multiplier, then specify 0xFFFF.

#### *Packet*

A pointer to the ATA command to send to the ATA device specified by *Port* and *PortMultiplierPort*. See “Related Definitions” below for a description of **EFI\_ATA\_PASS\_THRU\_COMMAND\_PACKET**.

#### *Event*

If non-blocking I/O is not supported then *Event* is ignored, and blocking I/O is performed. If *Event* is **NULL**, then blocking I/O is performed. If *Event* is not **NULL** and non blocking I/O is supported, then non-blocking I/O is performed, and *Event* will be signaled when the ATA command completes.

## Related Definitions

```
typedef struct {
  EFI_ATA_STATUS_BLOCK   *Asb;
  EFI_ATA_COMMAND_BLOCK *Acb;
  UINT64                 Timeout;
  VOID                   *InDataBuffer;
  VOID                   *OutDataBuffer;
  UINT32                 InTransferLength;
  UINT32                 OutTransferLength;
  EFI_ATA_PASS_THRU_CMD_PROTOCOL Protocol;
  EFI_ATA_PASS_THRU_LENGTH Length;
} EFI_ATA_PASS_THRU_COMMAND_PACKET;
```

### *Timeout*

The timeout, in 100 ns units, to use for the execution of this ATA command. A *Timeout* value of 0 means that this function will wait indefinitely for the ATA command to execute. If *Timeout* is greater than zero, then this function will return **EFI\_TIMEOUT** if the time required to execute the ATA command is greater than *Timeout*.

### *InDataBuffer*

A pointer to the data buffer to transfer between the ATA controller and the ATA device for read and bidirectional commands. For all write and non data commands where *InTransferLength* is 0 this field is optional and may be **NULL**. If this field is not **NULL**, then it must be aligned on the boundary specified by the *IoAlign* field in the **EFI\_ATA\_PASS\_THRU\_MODE** structure.

### *OutDataBuffer*

A pointer to the data buffer to transfer between the ATA controller and the ATA device for write or bidirectional commands. For all read and non data commands where *OutTransferLength* is 0 this field is optional and may be **NULL**. If this field is not **NULL**, then it must be aligned on the boundary specified by the *IoAlign* field in the **EFI\_ATA\_PASS\_THRU\_MODE** structure.

### *InTransferLength*

On input, the size, in bytes, of *InDataBuffer*. On output, the number of bytes transferred between the ATA controller and the ATA device. If *InTransferLength* is larger than the ATA controller can handle, no data will be transferred, *InTransferLength* will be updated to contain the number of bytes that the ATA controller is able to transfer, and **EFI\_BAD\_BUFFER\_SIZE** will be returned.

### *OutTransferLength*

On Input, the size, in bytes of *OutDataBuffer*. On Output, the Number of bytes transferred between ATA Controller and the ATA device. If *OutTransferLength* is larger than the ATA controller can handle, no data will be transferred, *OutTransferLength* will be updated to contain the number of

bytes that the ATA controller is able to transfer, and **EFI\_BAD\_BUFFER\_SIZE** will be returned.

*Asb*

A pointer to the sense data that was generated by the execution of the ATA command. It must be aligned to the boundary specified in the *IoAlign* field in the **EFI\_ATA\_PASS\_THRU\_MODE** structure.

*Acb*

A pointer to buffer that contains the Command Data Block to send to the ATA device specified by *Port* and *PortMultiplierPort*.

*Protocol*

Specifies the protocol used when the ATA device executes the command. Type **EFI\_ATA\_PASS\_THRU\_CMD\_PROTOCOL** is defined below.

*Length*

Specifies the way in which the ATA command length is encoded. Type **EFI\_ATA\_PASS\_THRU\_LENGTH** is defined below.

```
typedef struct _EFI_ATA_COMMAND_BLOCK {
  UINT8 Reserved1[2];
  UINT8 AtaCommand;
  UINT8 AtaFeatures;
  UINT8 AtaSectorNumber;
  UINT8 AtaCylinderLow;
  UINT8 AtaCylinderHigh;
  UINT8 AtaDeviceHead;
  UINT8 AtaSectorNumberExp;
  UINT8 AtaCylinderLowExp;
  UINT8 AtaCylinderHighExp;
  UINT8 AtaFeaturesExp;
  UINT8 AtaSectorCount;
  UINT8 AtaSectorCountExp;
  UINT8 Reserved2[6];
} EFI_ATA_COMMAND_BLOCK;
```

```
typedef struct _EFI_ATA_STATUS_BLOCK {
  UINT8 Reserved1[2];
  UINT8 AtaStatus;
  UINT8 AtaError;
  UINT8 AtaSectorNumber;
  UINT8 AtaCylinderLow;
  UINT8 AtaCylinderHigh;
  UINT8 AtaDeviceHead;
  UINT8 AtaSectorNumberExp;
  UINT8 AtaCylinderLowExp;
  UINT8 AtaCylinderHighExp;
```

```

    UINT8 Reserved2;
    UINT8 AtaSectorCount;
    UINT8 AtaSectorCountExp;
    UINT8 Reserved3[6];
} EFI_ATA_STATUS_BLOCK;

typedef UINT8 EFI_ATA_PASS_THRU_CMD_PROTOCOL;

#define EFI_ATA_PASS_THRU_PROTOCOL_ATA_HARDWARE_RESET 0x00
#define EFI_ATA_PASS_THRU_PROTOCOL_ATA_SOFTWARE_RESET 0x01
#define EFI_ATA_PASS_THRU_PROTOCOL_ATA_NON_DATA 0x02
#define EFI_ATA_PASS_THRU_PROTOCOL_PIO_DATA_IN 0x04
#define EFI_ATA_PASS_THRU_PROTOCOL_PIO_DATA_OUT 0x05
#define EFI_ATA_PASS_THRU_PROTOCOL_DMA 0x06
#define EFI_ATA_PASS_THRU_PROTOCOL_DMA_QUEUED 0x07
#define EFI_ATA_PASS_THRU_PROTOCOL_DEVICE_DIAGNOSTIC 0x08
#define EFI_ATA_PASS_THRU_PROTOCOL_DEVICE_RESET 0x09
#define EFI_ATA_PASS_THRU_PROTOCOL_UDMA_DATA_IN 0x0A
#define EFI_ATA_PASS_THRU_PROTOCOL_UDMA_DATA_OUT 0x0B
#define EFI_ATA_PASS_THRU_PROTOCOL_FPDMA 0x0C
#define EFI_ATA_PASS_THRU_PROTOCOL_RETURN_RESPONSE 0xFF

typedef UINT8 EFI_ATA_PASS_THRU_LENGTH;

#define EFI_ATA_PASS_THRU_LENGTH_BYTES 0x80

#define EFI_ATA_PASS_THRU_LENGTH_MASK 0x70
#define EFI_ATA_PASS_THRU_LENGTH_NO_DATA_TRANSFER 0x00
#define EFI_ATA_PASS_THRU_LENGTH_FEATURES 0x10
#define EFI_ATA_PASS_THRU_LENGTH_SECTOR_COUNT 0x20
#define EFI_ATA_PASS_THRU_LENGTH_TPSIU 0x30

#define EFI_ATA_PASS_THRU_LENGTH_COUNT 0x0F

```

## Description

The **PassThru()** function sends the ATA command specified by *Packet* to the ATA device specified by *Port* and *PortMultiplierPort*. If the driver supports non-blocking I/O and *Event* is not **NULL**, then the driver will return immediately after the command is sent to the selected device, and will later signal *Event* when the command has completed.

If the driver supports non-blocking I/O and *Event* is **NULL**, then the driver will send the command to the selected device and block until it is complete. If the driver does not support non-blocking I/O, then the *Event* parameter is ignored, and the driver will send the command to the selected device and block until it is complete.

If *Packet* is successfully sent to the ATA device, then **EFI\_SUCCESS** is returned. If *Packet* cannot be sent because there are too many packets already queued up, then **EFI\_NOT\_READY** is returned. The caller may retry *Packet* at a later time. If a device error occurs while sending the *Packet*, then **EFI\_DEVICE\_ERROR** is returned. If a timeout occurs during the execution of *Packet*, then **EFI\_TIMEOUT** is returned.

If *Port* or *PortMultiplierPort* are not in a valid range for the ATA controller, then **EFI\_INVALID\_PARAMETER** is returned. If *InDataBuffer*, *OutDataBuffer* or *Asb* do not meet the alignment requirement specified by the *IoAlign* field of the **EFI\_ATA\_PASS\_THRU\_MODE** structure, then **EFI\_INVALID\_PARAMETER** is returned. If any of the other fields of *Packet* are invalid, then **EFI\_INVALID\_PARAMETER** is returned.

If the data buffer described by *InDataBuffer* and *InTransferLength* is too big to be transferred in a single command, then no data is transferred and **EFI\_BAD\_BUFFER\_SIZE** is returned. The number of bytes that can be transferred in a single command are returned in *InTransferLength*. If the data buffer described by *OutDataBuffer* and *OutTransferLength* is too big to be transferred in a single command, then no data is transferred and **EFI\_BAD\_BUFFER\_SIZE** is returned. The number of bytes that can be transferred in a single command are returned in *OutTransferLength*.

If the command described in *Packet* is not supported by the host adapter, then **EFI\_UNSUPPORTED** is returned.

If **EFI\_SUCCESS**, **EFI\_BAD\_BUFFER\_SIZE**, **EFI\_DEVICE\_ERROR**, or **EFI\_TIMEOUT** is returned, then the caller must examine *Asb*.

If non-blocking I/O is being used, then the status fields in *Packet* will not be valid until the *Event* associated with *Packet* is signaled.

If **EFI\_NOT\_READY**, **EFI\_INVALID\_PARAMETER** or **EFI\_UNSUPPORTED** is returned, then *Packet* was never sent, so the status fields in *Packet* are not valid. If non-blocking I/O is being used, the *Event* associated with *Packet* will not be signaled.

This function will determine if data transfer is necessary based on the *Acb->Protocol* and *Acb->Length* fields. The *Acb->AtaCommand* field is ignored except to copy it into the ATA Command register. The following table describes special programming considerations based on the protocol specified by *Acb->Protocol*.

Table 111. Special programming considerations

Protocol Value	Description
<b>EFI_ATA_PASS_THRU_PROTOCOL_ATA_HARDWARE_RESET</b>	For PATA devices, then <b>RST-</b> is asserted. For SATA devices, then <b>COMRESET</b> will be issued.
<b>EFI_ATA_PASS_THRU_PROTOCOL_ATA_SOFTWARE_RESET</b>	A software reset will be issued to the ATA device.
<b>EFI_ATA_PASS_THRU_PROTOCOL_PIO_DATA_IN - EFI_ATA_PASS_THRU_PROTOCOL_FPDMA</b>	The command is sent to the ATA device. If the value is inappropriate for the command specified by <i>Acb-&gt;AtaCommand</i> , the results are undefined.
<b>EFI_ATA_PASS_THRU_RETURN_RESPONSE</b>	This command will only return the contents of the ATA status block.

The ATA host and the ATA device should already be configured for the PIO, DMA, and UDMA transfer rates that are supported by the ATA controller and the ATA device. The results of changing the device’s timings using this function are undefined.

If *Packet->Length* is not set to **EFI\_ATA\_PASS\_THRU\_LENGTH\_NO\_DATA\_TRANSFER**, then if **EFI\_ATA\_PASS\_THRU\_LENGTH\_BYTES** is set in *Packet->Length*, then *Packet->InTransferLength* and *Packet->OutTransferLength* are interpreted as bytes.

If *Packet->Length* is not set to **EFI\_ATA\_PASS\_THRU\_LENGTH\_NO\_DATA\_TRANSFER**, then if **EFI\_ATA\_PASS\_THRU\_LENGTH\_BYTES** is clear in *Packet->Length*, then *Packet->InTransferLength* and *Packet->OutTransferLength* are interpreted as blocks.

If *Packet->Length* is set to **EFI\_ATA\_PASS\_THRU\_LENGTH\_SECTOR\_COUNT**, then the transfer length will be programmed into *Acb->AtaSectorCount*.

If *Packet->Length* is set to **EFI\_ATA\_PASS\_THRU\_LENGTH\_TPSIU**, then the transfer length will be programmed into the TPSIU.

- For PIO data transfers, the number of sectors to transfer is  $2^{(Packet->Length \& \text{EFI\_ATA\_PASS\_THRU\_LENGTH\_COUNT})}$ .

For all commands, the contents of the ATA status block will be returned in *Asb*.



## Status Codes Returned

EFI_SUCCESS	The ATA command was sent by the host. For bi-directional commands, <i>InTransferLength</i> bytes were transferred from <i>InDataBuffer</i> . For write and bi-directional commands, <i>OutTransferLength</i> bytes were transferred by <i>OutDataBuffer</i> . See <i>Asb</i> for additional status information.
EFI_BAD_BUFFER_SIZE	The ATA command was not executed. The number of bytes that could be transferred is returned in <i>InTransferLength</i> . For write and bi-directional commands, <i>OutTransferLength</i> bytes were transferred by <i>OutDataBuffer</i> . See <i>Asb</i> for additional status information.
EFI_NOT_READY	The ATA command could not be sent because there are too many ATA commands already queued. The caller may retry again later.
EFI_DEVICE_ERROR	A device error occurred while attempting to send the ATA command. See <i>Asb</i> for additional status information.
EFI_INVALID_PARAMETER	<i>Port</i> , <i>PortMultiplierPort</i> , or the contents of <i>Acb</i> are invalid. The ATA command was not sent, so no additional status information is available.
EFI_UNSUPPORTED	The command described by the ATA command is not supported by the host adapter. The ATA command was not sent, so no additional status information is available.
EFI_TIMEOUT	A timeout occurred while waiting for the ATA command to execute. See <i>Asb</i> for additional status information.

## EFI\_ATA\_PASS\_THRU\_PROTOCOL.GetNextPort()

### Summary

Used to retrieve the list of legal port numbers for ATA devices on an ATA controller. These can either be the list of ports where ATA devices are actually present or the list of legal port numbers for the ATA controller. Regardless, the caller of this function must probe the port number returned to see if an ATA device is actually present at that location on the ATA controller.

### Prototype

```
typedef
EFI_STATUS
(EFI_API *EFI_ATA_PASS_THRU_GET_NEXT_PORT) (
    IN EFI_ATA_PASS_THRU_PROTOCOL *This,
    IN OUT UINT16 *Port
);
```

### Parameters

*This*

A pointer to the **EFI\_ATA\_PASS\_THRU\_PROTOCOL** instance.

*Port*

On input, a pointer to the port number on the ATA controller. On output, a pointer to the next port number on the ATA controller. An input value of **0xFFFF** retrieves the first port number on the ATA controller.

### Description

The **GetNextPort()** function retrieves the port number on an ATA controller. If on input *Port* is **0xFFFF**, then the port number of the first port on the ATA controller is returned in *Port* and **EFI\_SUCCESS** is returned.

If *Port* is the port number that was returned on the previous call to **GetNextPort()**, then the port number of the next port on the ATA controller is returned in *Port*, and **EFI\_SUCCESS** is returned.

If *Port* is not **0xFFFF** and *Port* was not returned on the previous call to **GetNextPort()**, then **EFI\_INVALID\_PARAMETER** is returned.

If *Port* is the port number of the last port on the ATA controller, then **EFI\_NOT\_FOUND** is returned.

### Status Codes Returned

EFI_SUCCESS	The next port number on the ATA controller was returned in <i>Port</i> .
EFI_NOT_FOUND	There are no more ports on this ATA controller.
EFI_INVALID_PARAMETER	<i>Port</i> is not <b>0xFFFF</b> and <i>Port</i> was not returned on a previous call to <b>GetNextPort()</b> .

## EFI\_ATA\_PASS\_THRU\_PROTOCOL.GetNextDevice()

### Summary

Used to retrieve the list of legal port multiplier port numbers for ATA devices on a port of an ATA controller. These can either be the list of port multiplier ports where ATA devices are actually present on port or the list of legal port multiplier ports on that port. Regardless, the caller of this function must probe the port number and port multiplier port number returned to see if an ATA device is actually present.

### Prototype

```
typedef
EFI_STATUS
(EFI_API *EFI_ATA_PASS_THRU_GET_NEXT_DEVICE) (
  IN EFI_ATA_PASS_THRU_PROTOCOL *This,
  IN UINT16      Port,
  IN OUT UINT16  *PortMultiplierPort
);
```

### Parameters

*This*

A pointer to the **EFI\_ATA\_PASS\_THRU\_PROTOCOL** instance.

*Port*

The port number present on the ATA controller.

*PortMultiplierPort*

On input, a pointer to the port multiplier port number of an ATA device present on the ATA controller. If on input a *PortMultiplierPort* of **0xFFFF** is specified, then the port multiplier port number of the first ATA device is returned. On output, a pointer to the port multiplier port number of the next ATA device present on an ATA controller.

### Description

The **GetNextDevice()** function retrieves the port multiplier port number of an ATA device present on a port of an ATA controller.

If *PortMultiplierPort* points to a port multiplier port number value that was returned on a previous call to **GetNextDevice()**, then the port multiplier port number of the next ATA device on the port of the ATA controller is returned in *PortMultiplierPort*, and **EFI\_SUCCESS** is returned.

If *PortMultiplierPort* points to **0xFFFF**, then the port multiplier port number of the first ATA device on port of the ATA controller is returned in *PortMultiplierPort* and **EFI\_SUCCESS** is returned.

If *PortMultiplierPort* is not **0xFFFF** and the value pointed to by *PortMultiplierPort* was not returned on a previous call to **GetNextDevice()**, then **EFI\_INVALID\_PARAMETER** is returned.

If *PortMultiplierPort* is the port multiplier port number of the last ATA device on the port of the ATA controller, then **EFI\_NOT\_FOUND** is returned.

### Status Codes Returned

EFI_SUCCESS	The port multiplier port number of the next ATA device on the port of the ATA controller was returned in <i>PortMultiplierPort</i> .
EFI_NOT_FOUND	There are no more ATA devices on this port of the ATA controller.
EFI_INVALID_PARAMETER	<i>PortMultiplierPort</i> is not <b>0xFFFF</b> , and <i>PortMultiplierPort</i> was not returned on a previous call to <b>GetNextDevice()</b> .

## EFI\_ATA\_PASS\_THRU\_PROTOCOL.BuildDevicePath()

### Summary

Used to allocate and build a device path node for an ATA device on an ATA controller.

### Prototype

```
typedef
EFI_STATUS
(EFI_API *EFI_ATA_PASS_THRU_BUILD_DEVICE_PATH) (
  IN EFI_ATA_PASS_THRU_PROTOCOL *This,
  IN UINT16      Port,
  IN UINT16      PortMultiplierPort,
  IN OUT EFI_DEVICE_PATH_PROTOCOL **DevicePath
);
```

### Parameters

*This*

A pointer to the **EFI\_ATA\_PASS\_THRU\_PROTOCOL** instance.

*Port*

Port specifies the port number of the ATA device for which a device path node is to be allocated and built.

*PortMultiplierPort*

The port multiplier port number of the ATA device for which a device path node is to be allocated and built. If there is no port multiplier, then specify 0xFFFF.

*DevicePath*

A pointer to a single device path node that describes the ATA device specified by *Port* and *PortMultiplierPort*. This function is responsible for allocating the buffer *DevicePath* with the boot service **AllocatePool()**. It is the caller's responsibility to free *DevicePath* when the caller is finished with *DevicePath*.

### Description

The **BuildDevicePath()** function allocates and builds a single device node for the ATA device specified by *Port* and *PortMultiplierPort*. If the ATA device specified by *Port* and *PortMultiplierPort* is not present on the ATA controller, then **EFI\_NOT\_FOUND** is returned. If *DevicePath* is **NULL**, then **EFI\_INVALID\_PARAMETER** is returned. If there are not enough resources to allocate the device path node, then **EFI\_OUT\_OF\_RESOURCES** is returned.

Otherwise, *DevicePath* is allocated with the boot service **AllocatePool()**, the contents of *DevicePath* are initialized to describe the ATA device specified by *Port* and *PortMultiplierPort*, and **EFI\_SUCCESS** is returned.

## Status Codes Returned

EFI_SUCCESS	The device path node that describes the ATA device specified by <i>Port</i> and <i>PortMultiplierPort</i> was allocated and returned in <i>DevicePath</i> .
EFI_NOT_FOUND	The ATA device specified by <i>Port</i> and <i>PortMultiplierPort</i> does not exist on the ATA controller.
EFI_INVALID_PARAMETER	<i>DevicePath</i> is <b>NULL</b> .
EFI_OUT_OF_RESOURCES	There are not enough resources to allocate <i>DevicePath</i> .

## EFI\_ATA\_PASS\_THRU\_PROTOCOL.GetDevice()

### Summary

Used to translate a device path node to a port number and port multiplier port number.

### Prototype

```
typedef
EFI_STATUS
(EFI_API *EFI_ATA_PASS_THRU_GET_DEVICE) (
  IN EFI_ATA_PASS_THRU_PROTOCOL *This,
  IN EFI_DEVICE_PATH_PROTOCOL *DevicePath,
  OUT UINT16 *Port,
  OUT UINT16 *PortMultiplierPort
);
```

### Parameters

*This*

A pointer to the **EFI\_ATA\_PASS\_THRU\_PROTOCOL** instance.

*DevicePath*

A pointer to the device path node that describes an ATA device on the ATA controller.

*Port*

On return, points to the port number of an ATA device on the ATA controller.

*PortMultiplierPort*

On return, points to the port multiplier port number of an ATA device on the ATA controller.

### Description

The **GetDevice()** function determines the port and port multiplier port number associated with the ATA device described by *DevicePath*. If *DevicePath* is a device path node type that the ATA Pass Thru driver supports, then the ATA Pass Thru driver will attempt to translate the contents *DevicePath* into a port number and port multiplier port number.

If this translation is successful, then that port number and port multiplier port number are returned in *Port* and *PortMultiplierPort*, and **EFI\_SUCCESS** is returned.

If *DevicePath*, *Port*, or *PortMultiplierPort* are **NULL**, then **EFI\_INVALID\_PARAMETER** is returned.

If *DevicePath* is not a device path node type that the ATA Pass Thru driver supports, then **EFI\_UNSUPPORTED** is returned.

If *DevicePath* is a device path node type that the ATA Pass Thru driver supports, but there is not a valid translation from *DevicePath* to a port number and port multiplier port number, then **EFI\_NOT\_FOUND** is returned.

### Status Codes Returned

EFI_SUCCESS	<i>DevicePath</i> was successfully translated to a port number and port multiplier port number, and they were returned in <i>Port</i> and <i>PortMultiplierPort</i> .
EFI_INVALID_PARAMETER	<i>DevicePath</i> is <b>NULL</b> .
EFI_INVALID_PARAMETER	<i>Port</i> is <b>NULL</b> .
EFI_INVALID_PARAMETER	<i>PortMultiplierPort</i> is <b>NULL</b> .
EFI_UNSUPPORTED	This driver does not support the device path node type in <i>DevicePath</i> .
EFI_NOT_FOUND	A valid translation from <i>DevicePath</i> to a port number and port multiplier port number does not exist.



## EFI\_ATA\_PASS\_THRU\_PROTOCOL.ResetPort()

### Summary

Resets a specific port on the ATA controller. This operation also resets all the ATA devices connected to the port.

### Prototype

```
typedef
EFI_STATUS
(EFIAPI *EFI_ATA_PASS_THRU_RESET_PORT) (
  IN EFI_ATA_PASS_THRU_PROTOCOL *This,
  IN UINT16      Port
);
```

### Parameters

*This*

A pointer to the **EFI\_ATA\_PASS\_THRU\_PROTOCOL** instance.

*Port*

The port number on the ATA controller.

### Description

The **ResetChannel()** function resets an a specific port on an ATA controller. This operation resets all the ATA devices connected to that port. If this ATA controller does not support a reset port operation, then **EFI\_UNSUPPORTED** is returned.

If a device error occurs while executing that port reset operation, then **EFI\_DEVICE\_ERROR** is returned.

If a timeout occurs during the execution of the port reset operation, then **EFI\_TIMEOUT** is returned. If the port reset operation is completed, then **EFI\_SUCCESS** is returned.

### Status Codes Returned

EFI_SUCCESS	The ATA controller port was reset.
EFI_UNSUPPORTED	The ATA controller does not support a port reset operation.
EFI_DEVICE_ERROR	A device error occurred while attempting to reset the ATA port.
EFI_TIMEOUT	A timeout occurred while attempting to reset the ATA port.

## EFI\_ATA\_PASS\_THRU\_PROTOCOL.ResetDevice()

### Summary

Resets an ATA device that is connected to an ATA controller.

### Prototype

```
typedef
EFI_STATUS
(EFIAPI *EFI_ATA_PASS_THRU_RESET_DEVICE) (
  IN EFI_ATA_PASS_THRU_PROTOCOL *This,
  IN UINT16      Port,
  IN UINT16      PortMultiplierPort
);
```

### Parameters

*This*

A pointer to the **EFI\_ATA\_PASS\_THRU\_PROTOCOL** instance.

*Port*

Port represents the port number of the ATA device to be reset.

*PortMultiplierPort*

The port multiplier port number of the ATA device to reset. If there is no port multiplier, then specify 0xFFFF.

### Description

The **ResetDevice()** function resets the ATA device specified by *Port* and *PortMultiplierPort*. If this ATA controller does not support a device reset operation, then **EFI\_UNSUPPORTED** is returned.

If *Port* or *PortMultiplierPort* are not in a valid range for this ATA controller, then **EFI\_INVALID\_PARAMETER** is returned.

If a device error occurs while executing that device reset operation, then **EFI\_DEVICE\_ERROR** is returned.

If a timeout occurs during the execution of the device reset operation, then **EFI\_TIMEOUT** is returned.

If the device reset operation is completed, then **EFI\_SUCCESS** is returned.

## Status Codes Returned

EFI_SUCCESS	The ATA device specified by <i>Port</i> and <i>PortMultiplierPort</i> was reset
EFI_UNSUPPORTED	The ATA controller does not support a device reset operation.
EFI_INVALID_PARAMETER	<i>Port</i> or <i>PortMultiplierPort</i> are invalid.
EFI_DEVICE_ERROR	A device error occurred while attempting to reset the ATA device specified by <i>Port</i> and <i>PortMultiplierPort</i> .
EFI_TIMEOUT	A timeout occurred while attempting to reset the ATA device specified by <i>Port</i> and <i>PortMultiplierPort</i> .

## 13.14 Storage Security Command Protocol

This section defines the storage security command protocol. This protocol is used to abstract mass storage devices to allow code running in the EFI boot services environment to send security protocol commands to mass storage devices without specific knowledge of the type of device or controller that manages the device. Functions are defined to send or retrieve security protocol defined data to and from mass storage devices. This protocol shall be supported on all physical and logical storage devices supporting the **EFI\_BLOCK\_IO\_PROTOCOL** in the EFI boot services environment and one of the following command sets (or their alternative) at the bus level:

- TRUSTED SEND/RECEIVE commands of the ATA8-ACS command set or its successor
- SECURITY PROTOCOL IN/OUT commands of the SPC-4 command set or its successor.

### EFI\_STORAGE\_SECURITY\_COMMAND\_PROTOCOL

#### Summary

This protocol provides ability to send security protocol commands to mass storage devices.

#### GUID

```
#define EFI_STORAGE_SECURITY_COMMAND_PROTOCOL_GUID \
  {0xc88b0b6d, 0x0dfc, 0x49a7, \
   0x9c, 0xb4, 0x49, 0x7, 0x4b, 0x4c, 0x3a, 0x78}}
```

#### Protocol Interface Structure

```
typedef struct _EFI_STORAGE_SECURITY_COMMAND_PROTOCOL {
  EFI_STORAGE_SECURITY_RECEIVE_DATA ReceiveData;
  EFI_STORAGE_SECURITY_SEND_DATA SendData;
} EFI_STORAGE_SECURITY_COMMAND_PROTOCOL;
```

#### Parameters

*ReceiveData*

Issues a security protocol command to the requested device that receives data and/or the result of one or more

commands sent by *SendData*. See the **ReceiveData()** function description.

### *SendData*

Issues a security protocol command to the requested device. See the **SendData()** function description.

## Description

The **EFI\_STORAGE\_SECURITY\_COMMAND\_PROTOCOL** is used to send security protocol commands to a mass storage device. Two types of security protocol commands are supported. *SendData* sends a command with data to a device. *ReceiveData* sends a command that receives data and/or the result of one or more commands sent by *SendData*.

The security protocol command formats supported shall be based on the definition of the SECURITY PROTOCOL IN and SECURITY PROTOCOL OUT commands defined in SPC-4. If the device uses the SCSI command set, no translation is needed in the firmware and the firmware can package the parameters into a SECURITY PROTOCOL IN or SECURITY PROTOCOL OUT command and send the command to the device. If the device uses a non-SCSI command set, the firmware shall map the command and data payload to the corresponding command and payload format defined in the non-SCSI command set (for example, TRUSTED RECEIVE and TRUSTED SEND in ATA8-ACS).

The firmware shall automatically add an **EFI\_STORAGE\_SECURITY\_COMMAND\_PROTOCOL** for any storage devices detected during system boot that support SPC-4, ATA8-ACS or their successors.

## EFI\_STORAGE\_SECURITY\_COMMAND\_PROTOCOL.ReceiveData()

### Summary

Send a security protocol command to a device that receives data and/or the result of one or more commands sent by *SendData*.

### Prototype

```
typedef
EFI_STATUS
(EFIAPI *EFI_STORAGE_SECURITY_RECEIVE_DATA) (
  IN EFI_STORAGE_SECURITY_COMMAND_PROTOCOL *This,
  IN UINT32 MediaId,
  IN UINT64 Timeout,
  IN UINT8 SecurityProtocol,
  IN UINT16 SecurityProtocolSpecificData,
  IN UINTN PayloadBufferSize,
  OUT VOID *PayloadBuffer,
  OUT UINTN *PayloadTransferSize
);
```

### Parameters

<i>This</i>	Indicates a pointer to the calling context. Type <b>EFI_STORAGE_SECURITY_COMMAND_PROTOCOL</b> is defined in the <b>EFI_STORAGE_SECURITY_COMMAND_PROTOCOL</b> description.
<i>MediaId</i>	ID of the medium to receive data from.
<i>Timeout</i>	The timeout, in 100ns units, to use for the execution of the security protocol command. A <i>Timeout</i> value of 0 means that this function will wait indefinitely for the security protocol command to execute. If <i>Timeout</i> is greater than zero, then this function will return <b>EFI_TIMEOUT</b> if the time required to execute the receive data command is greater than <i>Timeout</i> .
<i>SecurityProtocolId</i>	The value of the “Security Protocol” parameter of the security protocol command to be sent.
<i>SecurityProtocolSpecificData</i>	The value of the “Security Protocol Specific” parameter of the security protocol command to be sent. This value is in big-endian format.
<i>PayloadBufferSize</i>	Size in bytes of the payload data buffer.
<i>PayloadBuffer</i>	A pointer to a destination buffer to store the security protocol command specific payload data for the security

protocol command. The caller is responsible for having either implicit or explicit ownership of the buffer.

*PayloadTransferSize*

A pointer to a buffer to store the size in bytes of the data written to the payload data buffer.

### Description

The *ReceiveData* function sends a security protocol command to the given *MediaId*. The security protocol command sent is defined by *SecurityProtocolId* and contains the security protocol specific data *SecurityProtocolSpecificData*. The function returns the data from the security protocol command in *PayloadBuffer*.

For devices supporting the SCSI command set, the security protocol command is sent using the SECURITY PROTOCOL IN command defined in SPC-4.

For devices supporting the ATA command set, the security protocol command is sent using one of the TRUSTED RECEIVE commands defined in ATA8-ACS if

*PayloadBufferSize* is non-zero. If the *PayloadBufferSize* is zero, the security protocol command is sent using the Trusted Non-Data command defined in ATA8-ACS.

If *PayloadBufferSize* is too small to store the available data from the security protocol command, the function shall copy *PayloadBufferSize* bytes into the *PayloadBuffer* and return **EFI\_WARN\_BUFFER\_TOO\_SMALL**.

If *PayloadBuffer* or *PayloadTransferSize* is **NULL** and *PayloadBufferSize* is non-zero, the function shall return **EFI\_INVALID\_PARAMETER**.

If the given *MediaId* does not support security protocol commands, the function shall return **EFI\_UNSUPPORTED**. If there is no media in the device, the function returns **EFI\_NO\_MEDIA**. If the *MediaId* is not the ID for the current media in the device, the function returns **EFI\_MEDIA\_CHANGED**.

If the security protocol fails to complete within the *Timeout* period, the function shall return **EFI\_TIMEOUT**.

If the security protocol command completes without an error, the function shall return **EFI\_SUCCESS**. If the security protocol command completes with an error, the function shall return **EFI\_DEVICE\_ERROR**.

### Status Codes Returned

EFI_SUCCESS	The security protocol command completed successfully.
EFI_WARN_BUFFER_TOO_SMALL	The <i>PayloadBufferSize</i> was too small to store the available data from the device. The <i>PayloadBuffer</i> contains the truncated data.
EFI_UNSUPPORTED	The given <i>MediaId</i> does not support security protocol commands.
EFI_DEVICE_ERROR	The security protocol command completed with an error.
EFI_NO_MEDIA	There is no media in the device.
EFI_MEDIA_CHANGED	The <i>MediaId</i> is not for the current media.
EFI_INVALID_PARAMETER	The <i>PayloadBuffer</i> or <i>PayloadTransferSize</i> is <b>NULL</b> and <i>PayloadBufferSize</i> is non-zero.

EFI_TIMEOUT	A timeout occurred while waiting for the security protocol command to execute.
-------------	--

## EFI\_STORAGE\_SECURITY\_COMMAND\_PROTOCOL.SendData()

### Summary

Send a security protocol command to a device.

### Prototype

```
typedef
EFI_STATUS
(EFIAPI *EFI_STORAGE_SECURITY_SEND_DATA) (
    IN EFI_STORAGE_SECURITY_COMMAND_PROTOCOL *This,
    IN UINT32     MediaId,
    IN UINT64     Timeout,
    IN UINT8      SecurityProtocolId,
    IN UINT16     SecurityProtocolSpecificData,
    IN UINTN      PayloadBufferSize,
    IN VOID       *PayloadBuffer
);
```

### Parameters

<i>This</i>	Indicates a pointer to the calling context. Type <b>EFI_STORAGE_SECURITY_COMMAND_PROTOCOL</b> is defined in the <b>EFI_STORAGE_SECURITY_COMMAND_PROTOCOL</b> description.
<i>MediaId</i>	ID of the medium to send data to.
<i>Timeout</i>	The timeout, in 100ns units, to use for the execution of the security protocol command. A <i>Timeout</i> value of 0 means that this function will wait indefinitely for the security protocol command to execute. If <i>Timeout</i> is greater than zero, then this function will return <b>EFI_TIMEOUT</b> if the time required to execute the receive data command is greater than <i>Timeout</i> .
<i>SecurityProtocolId</i>	The value of the “Security Protocol” parameter of the security protocol command to be sent.
<i>SecurityProtocolSpecificData</i>	The value of the “Security Protocol Specific” parameter of the security protocol command to be sent.
<i>PayloadBufferSize</i>	Size in bytes of the payload data buffer.
<i>PayloadBuffer</i>	A pointer to a buffer containing the security protocol command specific payload data for the security protocol command.



## Description

The *SendData* function sends a security protocol command containing the payload *PayloadBuffer* to the given *MediaId*. The security protocol command sent is defined by *SecurityProtocolId* and contains the security protocol specific data *SecurityProtocolSpecificData*. If the underlying protocol command requires a specific padding for the command payload, the *SendData* function shall add padding bytes to the command payload to satisfy the padding requirements.

For devices supporting the SCSI command set, the security protocol command is sent using the SECURITY PROTOCOL OUT command defined in SPC-4.

For devices supporting the ATA command set, the security protocol command is sent using one of the TRUSTED SEND commands defined in ATA8-ACS if *PayloadBufferSize* is non-zero. If the *PayloadBufferSize* is zero, the security protocol command is sent using the Trusted Non-Data command defined in ATA8-ACS.

If *PayloadBuffer* is **NULL** and *PayloadBufferSize* is non-zero, the function shall return **EFI\_INVALID\_PARAMETER**.

If the given *MediaId* does not support security protocol commands, the function shall return **EFI\_UNSUPPORTED**. If there is no media in the device, the function returns **EFI\_NO\_MEDIA**. If the *MediaId* is not the ID for the current media in the device, the function returns **EFI\_MEDIA\_CHANGED**.

If the security protocol fails to complete within the *Timeout* period, the function shall return **EFI\_TIMEOUT**.

If the security protocol command completes without an error, the function shall return **EFI\_SUCCESS**. If the security protocol command completes with an error, the function shall return **EFI\_DEVICE\_ERROR**.

## Status Codes Returned

EFI_SUCCESS	The security protocol command completed successfully.
EFI_UNSUPPORTED	The given <i>MediaId</i> does not support security protocol commands.
EFI_DEVICE_ERROR	The security protocol command completed with an error.
EFI_NO_MEDIA	There is no media in the device.
EFI_MEDIA_CHANGED	The <i>MediaId</i> is not for the current media.
EFI_INVALID_PARAMETER	The <i>PayloadBuffer</i> is <b>NULL</b> and <i>PayloadBufferSize</i> is non-zero.
EFI_TIMEOUT	A timeout occurred while waiting for the security protocol command to execute.

## 13.15 NVM Express Pass Through Protocol

### EFI\_NVM\_EXPRESS\_PASS\_THRU\_PROTOCOL

This section provides a detailed description of the **EFI\_NVM\_EXPRESS\_PASS\_THRU\_PROTOCOL**.

## Summary

This protocol provides services that allow NVM Express commands to be sent to an NVM Express controller or to a specific namespace in a NVM Express controller. This protocol interface is optimized for storage.

## GUID

```
#define EFI_NVM_EXPRESS_PASS_THRU_PROTOCOL_GUID \
{ 0x52c78312, 0x8edc, 0x4233, \
  { 0x98, 0xf2, 0x1a, 0x1a, 0xa5, 0xe3, 0x88, 0xa5 } };
```

## Protocol Interface Structure

```
typedef struct _EFI_NVM_EXPRESS_PASS_THRU_PROTOCOL {
  EFI_NVM_EXPRESS_PASS_THRU_MODE *Mode;
  EFI_NVM_EXPRESS_PASS_THRU_PASSTHRU PassThru;
  EFI_NVM_EXPRESS_PASS_THRU_GET_NEXT_NAMESPACE GetNextNamespace;
  EFI_NVM_EXPRESS_PASS_THRU_BUILD_DEVICE_PATH BuildDevicePath;
  EFI_NVM_EXPRESS_PASS_THRU_GET_NAMESPACE GetNamespace;
} EFI_NVM_EXPRESS_PASS_THRU_PROTOCOL;
```

## Parameters

<i>Mode</i>	A pointer to the <b>EFI_NVM_EXPRESS_PASS_THRU_MODE</b> data for this NVM Express controller. <b>EFI_NVM_EXPRESS_PASS_THRU_MODE</b> is defined in “Related Definitions” below.
<i>PassThru</i>	Sends an NVM Express Command Packet to an NVM Express controller. See the <a href="#">EFI_NVM_EXPRESS_PASS_THRU_PROTOCOL.PassThru()</a> function description.
<i>GetNextNamespace</i>	Retrieves the next namespace ID for this NVM Express controller. See the <a href="#">EFI_NVM_EXPRESS_PASS_THRU_PROTOCOL.GetNextNamespace()</a> function description.
<i>BuildDevicePath</i>	Allocates and builds a device path node for a namespace on an NVM Express controller. See the <a href="#">EFI_NVM_EXPRESS_PASS_THRU_PROTOCOL.BuildDevicePath()</a> function description.
<i>GetNamespace</i>	Translates a device path node to a namespace ID. See the <a href="#">EFI_NVM_EXPRESS_PASS_THRU_PROTOCOL.GetNamespace()</a> function description.

The following data values in the **EFI\_NVM\_EXPRESS\_PASS\_THRU\_MODE** interface are read-only.

<i>Attributes</i>	Additional information on the attributes of the NVM Express controller. See “Related Definitions” below for the list of possible attributes.
<i>IoAlign</i>	Supplies the alignment requirement for any buffer used in a data transfer. <i>IoAlign</i> values of 0 and 1 mean that the

buffer can be placed anywhere in memory. Otherwise, *IoAlign* must be a power of 2, and the requirement is that the start address of a buffer must be evenly divisible by *IoAlign* with no remainder.

### *NvmeVersion*

Indicates the version of the NVM Express specification that the controller implementation supports. The format of this field is defined in the Version field of the Controller Registers in the *NVM Express Specification*.

## Related Definitions

```
typedef struct {
    UINT32 Attributes;
    UINT32 IoAlign;
    UINT32 NvmeVersion;
} EFI_NVM_EXPRESS_PASS_THRU_MODE;
```

```
#define EFI_NVM_EXPRESS_PASS_THRU_ATTRIBUTES_PHYSICAL 0x0001
#define EFI_NVM_EXPRESS_PASS_THRU_ATTRIBUTES_LOGICAL 0x0002
#define EFI_NVM_EXPRESS_PASS_THRU_ATTRIBUTES_NONBLOCKIO 0x0004
#define EFI_NVM_EXPRESS_PASS_THRU_ATTRIBUTES_CMD_SET_NVM 0x0008
```

### **EFI\_NVM\_EXPRESS\_PASS\_THRU\_ATTRIBUTES\_PHYSICAL**

If this bit is set, then the **EFI\_NVM\_EXPRESS\_PASS\_THRU\_PROTOCOL** interface is for directly addressable namespaces.

### **EFI\_NVM\_EXPRESS\_PASS\_THRU\_ATTRIBUTES\_LOGICAL**

If this bit is set, then the **EFI\_NVM\_EXPRESS\_PASS\_THRU\_PROTOCOL** interface is for a single volume logical namespace comprised of multiple namespaces.

### **EFI\_NVM\_EXPRESS\_PASS\_THRU\_ATTRIBUTES\_NONBLOCKIO**

If this bit is set, then the **EFI\_NVM\_EXPRESS\_PASS\_THRU\_PROTOCOL** interface supports non-blocking I/O.

### **EFI\_NVM\_EXPRESS\_PASS\_THRU\_ATTRIBUTES\_CMD\_SET\_NVM**

If this bit is set, then the **EFI\_NVM\_EXPRESS\_PASS\_THRU\_PROTOCOL** interface supports NVM command set.

## Description

The **EFI\_NVM\_EXPRESS\_PASS\_THRU\_PROTOCOL** provides information about an NVM Express controller and the ability to send NVM Express commands to an NVM Express controller or to a specific namespace in a NVM Express controller.

The printable name for the NVM Express controller can be provided through the **EFI\_COMPONENT\_NAME\_PROTOCOL** and the **EFI\_COMPONENT\_NAME2\_PROTOCOL** for multiple languages.

The *Attributes* field of the **EFI\_NVM\_EXPRESS\_PASS\_THRU\_PROTOCOL** interface tells if the interface is for physical NVM Express controllers or logical NVM Express controllers. Drivers for non-RAID NVM Express controllers will set both the **EFI\_NVM\_EXPRESS\_PASS\_THRU\_ATTRIBUTES\_PHYSICAL**, and the **EFI\_NVM\_EXPRESS\_PASS\_THRU\_ATTRIBUTES\_LOGICAL** bits.

Drivers for RAID controllers that allow access to the physical controllers and logical controllers will produce two **EFI\_NVM\_EXPRESS\_PASS\_THRU\_PROTOCOL** interfaces: one with just the **EFI\_NVM\_EXPRESS\_PASS\_THRU\_ATTRIBUTES\_PHYSICAL** bit set and another with just the **EFI\_NVM\_EXPRESS\_PASS\_THRU\_ATTRIBUTES\_LOGICAL** bit set. One interface can be used to access the physical controllers attached to the RAID controller, and the other can be used to access the logical controllers attached to the RAID controller for its current configuration.

Drivers for RAID controllers that do not allow access to the physical controllers will produce one **EFI\_NVM\_EXPRESS\_PASS\_THROUGH\_PROTOCOL** interface with just the **EFI\_NVM\_EXPRESS\_PASS\_THRU\_ATTRIBUTES\_LOGICAL** bit set. The interface for logical controllers can also be used by a file system driver to mount the RAID volumes. An **EFI\_NVM\_EXPRESS\_PASS\_THRU\_PROTOCOL** with neither **EFI\_NVM\_EXPRESS\_PASS\_THRU\_ATTRIBUTES\_LOGICAL** nor **EFI\_NVM\_EXPRESS\_PASS\_THRU\_ATTRIBUTES\_PHYSICAL** set is an illegal configuration.

The *Attributes* field also contains the **EFI\_NVM\_EXPRESS\_PASS\_THRU\_ATTRIBUTES\_NONBLOCKIO** bit. All **EFI\_NVM\_EXPRESS\_PASS\_THRU\_PROTOCOL** interfaces must support blocking I/O. If this bit is set, then the interface supports both blocking I/O and non-blocking I/O.

The *Attributes* field also contains the **EFI\_NVM\_EXPRESS\_PASS\_THRU\_ATTRIBUTES\_CMD\_SET\_NVM** bit. If this bit is set, the controller supports the NVM Express command set.

Each **EFI\_NVM\_EXPRESS\_PASS\_THRU\_PROTOCOL** instance must have an associated device path. Typically this will have an *ACPI* device path node and a *PCI* device path node, although variation will exist.

## EFI\_NVM\_EXPRESS\_PASS\_THRU\_PROTOCOL.PassThru()

### Summary

Sends an NVM Express Command Packet to an NVM Express controller or namespace. This function supports both blocking I/O and non-blocking I/O. The blocking I/O functionality is required, and the non-blocking I/O functionality is optional.

### Prototype

```
typedef EFI_STATUS
(EFIAPI *EFI_NVM_EXPRESS_PASS_THRU_PASSTHRU) (
  IN EFI_NVM_EXPRESS_PASS_THRU_PROTOCOL *This,
  IN UINT32 NamespaceId,
  IN OUT EFI_NVM_EXPRESS_PASS_THRU_COMMAND_PACKET *Packet,
  IN EFI_EVENT Event OPTIONAL
);
```

### Parameters

<i>This</i>	A pointer to the <b>EFI_NVM_EXPRESS_PASS_THRU_PROTOCOL</b> instance. Type <b>EFI_NVM_EXPRESS_PASS_THRU_PROTOCOL</b> is defined in <a href="#">Section 13.15</a> , above.
<i>NamespaceId</i>	A 32 bit namespace ID as defined in the NVMe specification to which the NVM Express Command Packet will be sent. A value of 0 denotes the NVM Express controller, a value of all <b>0xFF</b> 's (all bytes are <b>0xFF</b> ) in the namespace ID specifies that the command packet should be sent to all valid namespaces.
<i>Packet</i>	A pointer to the NVM Express Command Packet. See "Related Definitions" below for a description of <b>EFI_NVM_EXPRESS_PASS_THRU_COMMAND_PACKET</b> .
<i>Event</i>	If non-blocking I/O is not supported then <i>Event</i> is ignored, and blocking I/O is performed. If <i>Event</i> is NULL, then blocking I/O is performed. If <i>Event</i> is not NULL and non-blocking I/O is supported, then non-blocking I/O is performed, and <i>Event</i> will be signaled when the NVM Express Command Packet completes.

## Related Definitions

```
typedef struct {
    UINT64      CommandTimeout;
    VOID        *TransferBuffer OPTIONAL;
    UINT32      TransferLength OPTIONAL;
    VOID        *MetaDataBuffer OPTIONAL;
    UINT32      MetadataLength OPTIONAL;
    UINT8       QueueType;
    EFI_NVM_EXPRESS_COMMAND *NvmeCmd;
    EFI_NVM_EXPRESS_COMPLETION *NvmeCompletion;
} EFI_NVM_EXPRESS_PASS_THRU_COMMAND_PACKET;
```

<i>CommandTimeout</i>	The timeout in 100 ns units to use for the execution of this NVM Express Command Packet. A <i>Timeout</i> value of 0 means that this function will wait indefinitely for the command to execute. If <i>Timeout</i> is greater than zero, then this function will return <b>EFI_TIMEOUT</b> if the time required to execute the NVM Express command is greater than <i>Timeout</i> .
<i>TransferBuffer</i>	A pointer to the data buffer to transfer between the host and the NVM Express controller for read, write, and bi-directional commands. For all write and non-data commands where <i>TransferLength</i> is 0 this field is optional and may be NULL. If this field is not NULL, then it must be aligned on the boundary specified by the <i>IoAlign</i> field in the <b>EFI_NVM_EXPRESS_PASS_THRU_MODE</b> structure.
<i>TransferLength</i>	On input, the size in bytes of <i>TransferBuffer</i> . On output, the number of bytes transferred to or from the NVM Express controller or namespace.
<i>MetaDataBuffer</i>	A pointer to the optional metadata buffer to transfer between the host and the NVM Express controller. For all commands where no metadata is transferred between the host and the controller, this field is optional and may be NULL. If this field is not NULL, then it must be aligned on the boundary specified by the <i>IoAlign</i> field in the <b>EFI_NVM_EXPRESS_PASS_THRU_MODE</b> structure.
<i>MetadataLength</i>	On input, the size in bytes of <i>MetaDataBuffer</i> . On output, the number of bytes transferred to or from the NVM Express controller or namespace.
<i>QueueType</i>	The type of the queue that the NVMe command should be posted to. A value of 0 indicates it should be posted to the Admin Submission Queue. A value of 1 indicates it should be posted to an I/O Submission Queue.
<i>NvmeCmd</i>	A pointer to an NVM Express Command Packet.
<i>NvmeCompletion</i>	The raw NVM Express completion queue entry as defined in the <i>NVM Express Specification</i> .

## Description

The **PassThru()** function sends the NVM Express Command Packet specified by *Packet* to the NVM Express controller. If the driver supports non-blocking I/O and *Event* is not NULL, then the driver will return immediately after the command is sent to the selected controller, and will later signal Event when the command has completed.

If the driver supports non-blocking I/O and *Event* is NULL, then the driver will send the command to the selected device and block until it is complete.

If the driver does not support non-blocking I/O, then the *Event* parameter is ignored, and the driver will send the command to the selected device and block until it is complete.

If *Packet* is successfully sent to the NVM Express controller, then **EFI\_SUCCESS** is returned.

If a device error occurs while sending the *Packet*, then **EFI\_DEVICE\_ERROR** is returned.

If a timeout occurs during the execution of *Packet*, then **EFI\_TIMEOUT** is returned.

If *NamespaceId* is invalid for the NVM Express controller, then **EFI\_INVALID\_PARAMETER** is returned.

If *TransferBuffer* or *MetadataBuffer* do not meet the alignment requirement specified by the *IoAlign* field of the **EFI\_NVM\_EXPRESS\_PASS\_THRU\_MODE** structure, then **EFI\_INVALID\_PARAMETER** is returned. If the *QueueType* is not 0 (Admin Submission Queue) or 1 (I/O Submission Queue), then **EFI\_INVALID\_PARAMETER** is returned. If any of the other fields of *Packet* are invalid, then **EFI\_INVALID\_PARAMETER** is returned.

If the data buffer described by *TransferBuffer* and *TransferLength* is too big to be transferred in a single command, then no data is transferred and **EFI\_BAD\_BUFFER\_SIZE** is returned. The number of bytes that can be transferred in a single command are returned in *TransferLength*.

If **EFI\_SUCCESS**, **EFI\_DEVICE\_ERROR**, or **EFI\_TIMEOUT** is returned, then the caller must examine the *NvmeCompletion* field in *Packet*.

If non-blocking I/O is being used, then the *NvmeCompletion* field in *Packet* will not be valid until the *Event* associated with *Packet* is signaled.

If **EFI\_NOT\_READY**, **EFI\_INVALID\_PARAMETER**, **EFI\_BAD\_BUFFER\_SIZE**, or **EFI\_UNSUPPORTED** is returned, then *Packet* was never sent, so the *NvmeCompletion* field in *Packet* is not valid. If non-blocking I/O is being used, the *Event* associated with *Packet* will not be signaled.

### Status Codes Returned

EFI_SUCCESS	The NVM Express Command Packet was sent by the host. <i>TransferLength</i> bytes were transferred to or from <i>TransferBuffer</i> . See <i>NvmeCompletion</i> (above) for additional status information.
EFI_BAD_BUFFER_SIZE	The NVM Express Command Packet was not executed. The number of bytes that could be transferred is returned in <i>TransferLength</i> .
EFI_NOT_READY	The NVM Express Command Packet could not be sent because the controller is not ready. The caller may retry again later.
EFI_DEVICE_ERROR	A device error occurred while attempting to send the NVM Express Command Packet. See <i>NvmeCompletion</i> (above) for additional status information.
EFI_INVALID_PARAMETER	<i>NamespaceId</i> or the contents of <b>EFI_NVM_EXPRESS_PASS_THRU_COMMAND_PACKET</b> are invalid. The NVM Express Command Packet was not sent, so no additional status information is available.
EFI_UNSUPPORTED	The command described by the NVM Express Command Packet is not supported by the NVM Express controller. The NVM Express Command Packet was not sent so no additional status information is available.
EFI_TIMEOUT	A timeout occurred while waiting for the NVM Express Command Packet to execute. See <i>NvmeCompletion</i> (above) for additional status information.

### Related Definitions

```

typedef struct {
    UINT32 OpCode : 8;
    UINT32 FusedOperation : 2;
    UINT32 Reserved : 22;
} NVME_CDWO;

//*****
// FusedOperation
//*****
#define NORMAL_CMD 0x00
#define FUSED_FIRST_CMD 0x01
#define FUSED_SECOND_CMD 0x02

typedef struct {
    NVME_CDWO Cdw0;
    UINT8 Flags;
    UINT32 Nsid;
    UINT32 Cdw2;
    UINT32 Cdw3;
    UINT32 Cdw10;
    UINT32 Cdw11;
    
```



```
    UINT32 Cdw12;
    UINT32 Cdw13;
    UINT32 Cdw14;
    UINT32 Cdw15;
} EFI_NVM_EXPRESS_COMMAND;

//*****
// Flags
//*****
#define CDW2_VALID0x01
#define CDW3_VALID0x02
#define CDW10_VALID0x04
#define CDW11_VALID0x08
#define CDW12_VALID0x10
#define CDW13_VALID0x20
#define CDW14_VALID0x40
#define CDW15_VALID0x80

//
// This structure maps to the NVM Express specification Completion Queue Entry
//
typedef struct {
    UINT32 DW0;
    UINT32 DW1;
    UINT32 DW2;
    UINT32 DW3;
} EFI_NVM_EXPRESS_COMPLETION;
```

## EFI\_NVM\_EXPRESS\_PASS\_THRU\_PROTOCOL.GetNextNamespace()

### Summary

Used to retrieve the next namespace ID for this NVM Express controller.

### Prototype

```
typedef
EFI_STATUS
(EFIAPI *EFI_NVM_EXPRESS_PASS_THRU_GET_NEXT_NAMESPACE) (
    IN EFI_NVM_EXPRESS_PASS_THRU_PROTOCOL *This,
    IN OUT UINT32      *NamespaceId
);
```

### Parameters

<i>This</i>	A pointer to the <b>EFI_NVM_EXPRESS_PASS_THRU_PROTOCOL</b> instance.
<i>NamespaceId</i>	On input, a pointer to a valid namespace ID on this NVM Express controller or a pointer to the value <b>0xFFFFFFFF</b> . A pointer to the value <b>0xFFFFFFFF</b> retrieves the first valid namespace ID on this NVM Express controller.

### Description

The **EFI\_NVM\_EXPRESS\_PASS\_THRU\_PROTOCOL.GetNextNamespace()** function retrieves the next valid namespace ID on this NVM Express controller. If on input the value pointed to by *NamespaceId* is **0xFFFFFFFF**, then the first valid namespace ID defined on the NVM Express controller is returned in the location pointed to by *NamespaceId* and a status of **EFI\_SUCCESS** is returned.

If on input the value pointed to by *NamespaceId* is an invalid namespace ID other than **0xFFFFFFFF**, then **EFI\_INVALID\_PARAMETER** is returned.

If on input the value pointed to by *NamespaceId* is a valid namespace ID, then the next valid namespace ID on the NVM Express controller is returned in the location pointed to by *NamespaceId*, and **EFI\_SUCCESS** is returned.

If the value pointed to by *NamespaceId* is the namespace ID of the last namespace on the NVM Express controller, then **EFI\_NOT\_FOUND** is returned.

### Status Codes Returned

EFI_SUCCESS	The Namespace ID of the next <i>Namespace</i> was returned.
EFI_NOT_FOUND	There are no more namespaces defined on this controller.
EFI_INVALID_PARAMETER	<i>NamespaceId</i> is an invalid value other than <b>0xFFFFFFFF</b> .

## EFI\_NVM\_EXPRESS\_PASS\_THRU\_PROTOCOL.BuildDevicePath()

### Summary

Used to allocate and build a device path node for an NVM Express namespace on an NVM Express controller.

### Prototype

```
typedef
EFI_STATUS
(EFI_API *EFI_NVM_EXPRESS_PASS_THRU_BUILD_DEVICE_PATH) (
  IN EFI_NVM_EXPRESS_PASS_THRU_PROTOCOL *This,
  IN UINT32      NamespaceId,
  IN OUT EFI_DEVICE_PATH_PROTOCOL **DevicePath
);
```

### Parameters

This	A pointer to the <b>EFI_NVM_EXPRESS_PASS_THRU_PROTOCOL</b> instance. Type <b>EFI_NVM_EXPRESS_PASS_THRU_PROTOCOL</b> is defined in <a href="#">Section 13.15</a> .
NamespaceId	The NVM Express namespace ID for which a device path node is to be allocated and built.
DevicePath	A pointer to a single device path node that describes the NVM Express namespace specified by <i>NamespaceId</i> . This function is responsible for allocating the buffer <i>DevicePath</i> with the boot service <b>AllocatePool()</b> . It is the caller's responsibility to free <i>DevicePath</i> when the caller is finished with <i>DevicePath</i> .

### Description

The **EFI\_NVM\_EXPRESS\_PASS\_THRU\_PROTOCOL.BuildDevicePath()** function allocates and builds a single device path node for the NVM Express namespace specified by *NamespaceId*. If the *NamespaceId* is not valid, then **EFI\_NOT\_FOUND** is returned. If *DevicePath* is NULL, then **EFI\_INVALID\_PARAMETER** is returned. If there are not enough resources to allocate the device path node, then **EFI\_OUT\_OF\_RESOURCES** is returned. Otherwise, *DevicePath* is allocated with the boot service **AllocatePool()**, the contents of *DevicePath* are initialized to describe the NVM Express namespace specified by *NamespaceId*, and **EFI\_SUCCESS** is returned.

### Status Codes Returned

EFI_SUCCESS	The device path node that describes the NVM Express namespace specified by <i>NamespaceId</i> was allocated and returned in <i>DevicePath</i> .
EFI_NOT_FOUND	The <i>NamespaceId</i> is not valid.
EFI_INVALID_PARAMETER	<i>DevicePath</i> is <b>NULL</b> .

EFI_OUT_OF_RESOURCES	There are not enough resources to allocate the <i>DevicePath</i> node.
----------------------	--

## EFI\_NVM\_EXPRESS\_PASS\_THRU\_PROTOCOL.GetNamespace()

### Summary

Used to translate a device path node to a namespace ID.

### Prototype

```
typedef
EFI_STATUS
(EFI_API *EFI_NVM_EXPRESS_PASS_THRU_GET_NAMESPACE) (
  IN EFI_NVM_EXPRESS_PASS_THRU_PROTOCOL *This,
  IN EFI_DEVICE_PATH_PROTOCOL *DevicePath,
  OUT UINT32 *Namespaceld
);
```

### Parameters

<i>This</i>	A pointer to the <b>EFI_NVM_EXPRESS_PASS_THRU_PROTOCOL</b> instance. Type <b>EFI_NVM_EXPRESS_PASS_THRU_PROTOCOL</b> is defined in <a href="#">Section 13.15</a> .
<i>DevicePath</i>	A pointer to the device path node that describes an NVM Express namespace on the NVM Express controller.
<i>Namespaceld</i>	The NVM Express namespace ID contained in the device path node.

### Description

The **EFI\_NVM\_EXPRESS\_PASS\_THRU\_PROTOCOL.GetNamespace()** function determines the namespace ID associated with the namespace described by *DevicePath*. If *DevicePath* is a device path node type that the NVM Express Pass Thru driver supports, then the NVM Express Pass Thru driver will attempt to translate the contents *DevicePath* into a namespace ID. If this translation is successful, then that namespace ID is returned in *Namespaceld*, and **EFI\_SUCCESS** is returned.

### Status Codes Returned

EFI_INVALID_PARAMETER	If <i>DevicePath</i> or <i>NamespaceId</i> are <b>NULL</b> , then <b>EFI_INVALID_PARAMETER</b> is returned.
EFI_UNSUPPORTED	If <i>DevicePath</i> is not a device path node type that the NVM Express Pass Thru driver supports, then <b>EFI_UNSUPPORTED</b> is returned.
EFI_NOT_FOUND	If <i>DevicePath</i> is a device path node type that the NVM Express Pass Thru driver supports, but there is not a valid translation from <i>DevicePath</i> to a namespace ID, then <b>EFI_NOT_FOUND</b> is returned.

## 13.16 SD MMC Pass Thru Protocol

### EFI\_SD\_MMC\_PASS\_THRU\_PROTOCOL

This section provides a detailed description of the **EFI\_SD\_MMC\_PASS\_THRU\_PROTOCOL**.

The protocol provides services that allow SD/eMMC commands to be sent to an SD/eMMC controller. All interfaces and definitions from this section apply equally to SD and eMMC controllers.

For the sake of brevity, the rest of this section refers only to SD devices and controllers and does not specifically mention eMMC devices and controllers.

#### GUID

```
#define EFI_SD_MMC_PASS_THRU_PROTOCOL_GUID \
{ 0x716ef0d9, 0xff83, 0x4f69, \
  { 0x81, 0xe9, 0x51, 0x8b, 0xd3, 0x9a, 0x8e, 0x70 } }
```

#### Protocol Interface Structure

```
typedef struct _EFI_SD_MMC_PASS_THRU_PROTOCOL {
    UINTN          IoAlign;
    EFI_SD_MMC_PASS_THRU_PASSTHRU    PassThru;
    EFI_SD_MMC_PASS_THRU_GET_NEXT_SLOT    GetNextSlot;
    EFI_SD_MMC_PASS_THRU_BUILD_DEVICE_PATH    BuildDevicePath;
    EFI_SD_MMC_PASS_THRU_GET_SLOT_NUMBER    GetSlotNumber;
    EFI_SD_MMC_PASS_THRU_RESET_DEVICE    ResetDevice;
} EFI_SD_MMC_PASS_THRU_PROTOCOL;
```

#### Parameters

*IoAlign*

Supplies the alignment requirement for any buffer used in a data transfer. *IoAlign* values of 0 and 1 mean that the buffer can be placed anywhere in memory. Otherwise, *IoAlign* must be a power of 2, and the requirement is that the start address of a buffer must be evenly divisible by *IoAlign* with no remainder.

<i>PassThru</i>	Sends SD command to the SD controller. See the <b>PassThru()</b> function description.
<i>GetNextSlot</i>	Retrieves a next slot on an SD controller. See the <b>GetNextSlot()</b> function description.
<i>BuildDevicePath</i>	Allocates and builds a device path node for an SD card on the SD controller. See the <b>BuildDevicePath()</b> function description.
<i>GetSlotNumber</i>	Retrieves the SD card slot number based on the input device path. See the <b>GetSlotNumber()</b> function description.
<i>ResetDevice</i>	Resets an SD card connected to the SD controller. See the <b>ResetDevice()</b> function description.

## EFI\_SD\_MMC\_PASS\_THRU\_PROTOCOL.PassThru()

### Summary

Sends SD command to an SD card that is attached to the SD controller.

### Prototype

```
typedef
EFI_STATUS
(EFI_API *EFI_SD_MMC_PASS_THRU_PASSTHRU) (
    IN EFI_SD_MMC_PASS_THRU_PROTOCOL    *This,
    IN UINT8                            Slot,
    IN OUT EFI_SD_MMC_PASS_THRU_COMMAND_PACKET *Packet,
    IN EFI_EVENT                        Event OPTIONAL
);
```

### Parameters

<i>This</i>	A pointer to the <b>EFI_SD_MMC_PASS_THRU_PROTOCOL</b> instance.
<i>Slot</i>	The slot number of the SD card to send the command to.
<i>Packet</i>	A pointer to the SD command data structure. See “Related Definitions” below for a description of <b>EFI_SD_MMC_PASS_THRU_COMMAND_PACKET</b> .
<i>Event</i>	If non-blocking I/O is not supported then <i>Event</i> is ignored, and blocking I/O is performed. If <i>Event</i> is <b>NULL</b> , then blocking I/O is performed. If <i>Event</i> is not <b>NULL</b> and non-blocking I/O is supported, then non-blocking I/O is performed, and <i>Event</i> will be signaled when the SD command completes.

### Related Definitions

```
typedef struct {
    EFI_SD_MMC_COMMAND_BLOCK    *SdMmcCmdBlk;
    EFI_SD_MMC_STATUS_BLOCK    *SdMmcStatusBlk;
    UINT64                      Timeout;
    VOID                        *InDataBuffer;
    VOID                        *OutDataBuffer;
    UINT32                      InTransferLength;
    UINT32                      OutTransferLength;
    EFI_STATUS                  TransactionStatus;
} EFI_SD_MMC_PASS_THRU_COMMAND_PACKET;
```

<i>SdMmcCmdBlk</i>	A pointer to a command specific data buffer allocated and filled by the caller. See “Related Definitions” below for a description of <b>EFI_SD_MMC_COMMAND_BLOCK</b> .
<i>SdMmcStatusBlk</i>	A pointer to a command specific response data buffer allocated by the caller and filled by the PassThru function.



See “Related Definitions” below for a description of **EFI\_SD\_MMC\_STATUS\_BLOCK**.

<i>Timeout</i>	The timeout, in 100 ns units, to use for the execution of this SDcommand. A <i>Timeout</i> value of 0 means that this function will wait indefinitely for the SDcommand to execute. If <i>Timeout</i> is greater than zero, then this function will return <b>EFI_TIMEOUT</b> if the time required to execute the SDcommand is greater than <i>Timeout</i> .
<i>InDataBuffer</i>	A pointer to a buffer for the data transferred from the SD card during processing of read and bidirectional commands. For all write and non-data commands this field is optional and may be <b>NULL</b> .
<i>OutDataBuffer</i>	A pointer to a buffer for the data to be transferred to the SD card during processing of write or bidirectional commands. For all read and non-data commands this field is optional and may be <b>NULL</b> .
<i>InTransferLength</i>	On input, the size, in bytes, of <i>InDataBuffer</i> . On output, the number of bytes transferred between the SD controller and the SD device. If <i>InTransferLength</i> is larger than the SD controller can handle, no data will be transferred, <i>InTransferLength</i> will be updated to contain the number of bytes that the SD controller is able to transfer, and <b>EFI_BAD_BUFFER_SIZE</b> will be returned.
<i>OutTransferLength</i>	On Input, the size, in bytes of <i>OutDataBuffer</i> . On Output, the Number of bytes transferred between SD Controller and the SD device. If <i>OutTransferLength</i> is larger than the SD controller can handle, no data will be transferred. <i>OutTransferLength</i> will be updated to contain the number of bytes that the SD controller is able to transfer, and <b>EFI_BAD_BUFFER_SIZE</b> will be returned.
<i>TransactionStatus</i>	Transaction status. When <b>PathThru()</b> function is used in a blocking mode, the status must be the same as the status returned by the <b>PathThru()</b> function. When <b>PathThru()</b> function is used in a non-blocking mode, the field is updated with the transaction status once transaction is completed.

## Related Definitions

```

typedef struct {
    UNIT16    CommandIndex;
    UINT32    CommandArgument;
    UINT32    CommandType; // One of the EFI_SD_MMC_COMMAND_TYPE values
    UINT32    ResponseType; // One of the EFI_SD_MMC_RESPONSE_TYPE values
} EFI_SD_MMC_COMMAND_BLOCK;

typedef struct {
    UINT32    Resp0;
    UINT32    Resp1;
    UINT32    Resp2;
    UINT32    Resp3;
} EFI_SD_MMC_STATUS_BLOCK;

typedef enum {
    SdMmcCommandTypeBc, // Broadcast commands, no response
    SdMmcCommandTypeBcr, // Broadcast commands with response
    SdMmcCommandTypeAc, // Addressed(point-to-point) commands
    SdMmcCommandTypeAdtc // Addressed(point-to-point) data transfer
                        // commands
} EFI_SD_MMC_COMMAND_TYPE;

typedef enum {
    SdMmcResponseR1,
    SdMmcResponseR1b,
    SdMmcResponseR2,
    SdMmcResponseR3,
    SdMmcResponseR4,
    SdMmcResponseR5,
    SdMmcResponseR5b,
    SdMmcResponseR6,
    SdMmcResponseR7
} EFI_SD_MMC_RESPONSE_TYPE;

```

## Description

The **PassThru()** function sends the SD command specified by *Packet* to the SD card specified by *Slot*.

If *Packet* is successfully sent to the SD card, then **EFI\_SUCCESS** is returned. If a device error occurs while sending the *Packet*, then **EFI\_DEVICE\_ERROR** is returned. If *Slot* is not in a valid range for the SD controller, then **EFI\_INVALID\_PARAMETER** is returned. If *Packet* defines a data command but both *InDataBuffer* and *OutDataBuffer* are **NULL**, **EFI\_INVALID\_PARAMETER** is returned.

## Status Codes Returned

EFI_SUCCESS	The SD Command Packet was sent by the host.
EFI_DEVICE_ERROR	A device error occurred while attempting to send the SD command Packet.
EFI_INVALID_PARAMETER	<i>Packet</i> , <i>Slot</i> , or the contents of the <i>Packet</i> is invalid.
EFI_INVALID_PARAMETER	<i>Packet</i> defines a data command but both <i>InDataBuffer</i> and <i>OutDataBuffer</i> are <b>NULL</b> .
EFI_NO_MEDIA	SD Device not present in the <i>Slot</i> .
EFI_UNSUPPORTED	The command described by the SD Command Packet is not supported by the host controller.
EFI_BAD_BUFFER_SIZE	The <i>InTransferLength</i> or <i>OutTransferLength</i> exceeds the limit supported by SD card (i.e. if the number of bytes exceed the Last LBA).
EFI_DEVICE_ERROR	The command was not sent due to a device error

## EFI\_SD\_MMC\_PASS\_THRU\_PROTOCOL.GetNextSlot()

### Summary

Used to retrieve next slot numbers supported by the SD controller. The function returns information about all available slots (populated or not-populated).

### Prototype

```
typedef
EFI_STATUS
(EFI_API *EFI_SD_MMC_PASS_THRU_GET_NEXT_SLOT) (
    IN EFI_SD_MMC_PASS_THRU_PROTOCOL *This,
    IN OUT UINT8 *Slot
);
```

### Parameters

*This*

A pointer to the **EFI\_SD\_MMMC\_PASS\_THRU\_PROTOCOL** instance.

*Slot*

On input, a pointer to a slot number on the SD controller. On output, a pointer to the next slot number on the SD controller. An input value of **0xFF** retrieves the first slot number on the SD controller.

### Description

The **GetNextSlot()** function retrieves the next slot number on an SD controller. If on input *Slot* is **0xFF**, then the slot number of the first slot on the SD controller is returned.

If *Slot* is a slot number that was returned on a previous call to **GetNextSlot()**, then the slot number of the next slot on the SD controller is returned.

If *Slot* is not **0xFF** and *Slot* was not returned on a previous call to **GetNextSlot()**, **EFI\_INVALID\_PARAMETER** is returned.

If *Slot* is the slot number of the last slot on the SD controller, then **EFI\_NOT\_FOUND** is returned.

### Status Codes Returned

EFI_SUCCESS	The next slot number on the SD controller was returned in <i>Slot</i> .
EFI_NOT_FOUND	There are no more slots on this SD controller
EFI_INVALID_PARAMETER	<i>Slot</i> is not <b>0xFF</b> and <i>Slot</i> was not returned on a previous call to <b>GetNextSlot()</b> .

## EFI\_SD\_MMC\_PASS\_THRU\_PROTOCOL.BuildDevicePath()

### Summary

Used to allocate and build a device path node for an SD card on the SD controller.

### Prototype

```
typedef
EFI_STATUS
(EFI_API *EFI_SD_MMC_PASS_THRU_BUILD_DEVICE_PATH) (
    IN EFI_SD_MMC_PASS_THRU_PROTOCOL *This,
    IN UINT8 Slot,
    IN OUT EFI_DEVICE_PATH_PROTOCOL **DevicePath
);
```

### Parameters

<i>This</i>	A pointer to the <b>EFI_SD_MMC_PASS_THRU_PROTOCOL</b> instance.
<i>Slot</i>	Specifies the slot number of the SD card for which a device path node is to be allocated and built.
<i>DevicePath</i>	A pointer to a single device path node that describes the SD card specified by <i>Slot</i> . This function is responsible for allocating the buffer <i>DevicePath</i> with the boot service <b>AllocatePool()</b> . It is the caller's responsibility to free <i>DevicePath</i> when the caller is finished with <i>DevicePath</i> .

### Description

The **BuildDevicePath()** function allocates and builds a single device node for the SD card specified by *Slot*. If the SD card specified by *Slot* is not present on the SD controller, then **EFI\_NOT\_FOUND** is returned. If *DevicePath* is **NULL**, then **EFI\_INVALID\_PARAMETER** is returned. If there are not enough resources to allocate the device path node, then **EFI\_OUT\_OF\_RESOURCES** is returned.

Otherwise, *DevicePath* is allocated with the boot service **AllocatePool()**, the contents of *DevicePath* are initialized to describe the SD card specified by *Slot*, and **EFI\_SUCCESS** is returned.

### Status Codes Returned

EFI_SUCCESS	The device path node that describes the SD card specified by Slot was allocated and returned in DevicePath.
EFI_NOT_FOUND	The SD card specified by Slot does not exist on the SD controller
EFI_INVALID_PARAMETER	DevicePath is NULL
EFI_OUT_OF_RESOURCES	There are not enough resources to allocate DevicePath

## EFI\_SD\_MMC\_PASS\_THRU\_PROTOCOL.GetSlotNumber()

### Summary

This function retrieves an SD card slot number based on the input device path.

### Prototype

```
typedef
EFI_STATUS
(EFIAPI *EFI_SD_MMC_PASS_THRU_GET_SLOT_NUMBER) (
    IN EFI_SD_MMC_PASS_THRU_PROTOCOL    *This,
    IN EFI_DEVICE_PATH_PROTOCOL        *DevicePath,
    OUT UINT8                          *Slot
);
```

### Parameters

- This* A pointer to the **EFI\_SD\_MMC\_PASS\_THRU\_PROTOCOL** instance.
- DevicePath* A pointer to the device path node that describes a SD card on the SD controller.
- Slot* On return, points to the slot number of an SD card on the SD controller.

### Description

The **GetSlotNumber()** function retrieves slot number for the SD card specified by the *DevicePath* node. If *DevicePath* is **NULL**, **EFI\_INVALID\_PARAMETER** is returned. If *DevicePath* is not a device path node type that the SD Pass Thru driver supports, **EFI\_UNSUPPORTED** is returned

### Status Codes Returned

EFI_SUCCESS	SD card slot number is returned in <i>Slot</i> .
EFI_INVALID_PARAMETER	<i>Slot</i> or <i>DevicePath</i> is NULL.
EFI_UNSUPPORTED	<i>DevicePath</i> is not a device path node type that the SD Pass Thru driver supports.

## EFI\_SD\_MMC\_PASS\_THRU\_PROTOCOL.ResetDevice()

### Summary

Resets an SD card that is connected to the SD controller.

### Prototype

```
typedef
EFI_STATUS
(EFI_API *EFI_SD_MMC_PASS_THRU_RESET_DEVICE) (
    IN EFI_SD_MMC_PASS_THRU_PROTOCOL *This,
    IN UINT8 Slot
);
```

### Parameters

*This* A pointer to the **EFI\_SD\_MMC\_PASS\_THRU\_PROTOCOL** instance.

*Slot* Specifies the slot number of the SD card to be reset.

### Description

The **ResetDevice()** function resets the SD card specified by *Slot*. If this SD controller does not support a device reset operation, **EFI\_UNSUPPORTED** is returned. If *Slot* is not in a valid slot number for this SD controller, **EFI\_INVALID\_PARAMETER** is returned.

If the device reset operation is completed, **EFI\_SUCCESS** is returned.

### Status Codes Returned

EFI_SUCCESS	The SD card specified by Slot was reset.
EFI_UNSUPPORTED	The SD controller does not support a device reset operation.
EFI_INVALID_PARAMETER	Slot number is invalid.
EFI_NO_MEDIA	SD Device not present in the <i>Slot</i> .
EFI_DEVICE_ERROR	The reset command failed due to a device error

## 13.17 RAM Disk Protocol

### EFI\_RAM\_DISK\_PROTOCOL

#### Summary

RAM disk aware application invokes this protocol to register/unregister a specified RAM disk.

#### GUID

```
#define EFI_RAM_DISK_PROTOCOL_GUID \
  { 0xab38a0df, 0x6873, 0x44a9, \
    { 0x87, 0xe6, 0xd4, 0xeb, 0x56, 0x14, 0x84, 0x49 } }
```

#### Protocol Interface Structure

```
typedef struct _EFI_RAM_DISK_PROTOCOL {
  EFI_RAM_DISK_REGISTER_RAMDISK Register;
  EFI_RAM_DISK_UNREGISTER_RAMDISK Unregister;
} EFI_RAM_DISK_PROTOCOL;
```

#### Members

<i>Register</i>	Register a RAM disk with specified buffer address, size and type.
<i>Unregister</i>	Unregister the RAM disk specified by a device path.

#### Description

This protocol defines a standard interface for UEFI applications, drivers and OS loaders to register/unregister a RAM disk.

The key points are:

- The consumer of this protocol is responsible for allocating/freeing memory used by RAM Disk if needed and deciding the initial content, as in most scenarios only the consumer knows which type and how much memory should be used.



## EFI\_RAM\_DISK\_PROTOCOL.Register()

### Summary

This function is used to register a RAM disk with specified address, size and type.

### Prototype

```
typedef
EFI_STATUS
(EFIAPI *EFI_RAM_DISK_REGISTER_RAMDISK) (
    IN UINT64      RamDiskBase,
    IN UINT64      RamDiskSize,
    IN EFI_GUID     *RamDiskType,
    IN EFI_DEVICE_PATH *ParentDevicePath OPTIONAL,
    OUT EFI_DEVICE_PATH_PROTOCOL **DevicePath
);
```

### Parameters

<i>RamDiskBase</i>	The base address of registered RAM disk.
<i>RamDiskSize</i>	The size of registered RAM disk.
<i>RamDiskType</i>	The type of registered RAM disk. The GUID can be any of the values defined in <a href="#">Section 10.3.6.9</a> , or a vendor defined GUID.
<i>ParentDevicePath</i>	Pointer to the parent device path. If there is no parent device path then <i>ParentDevicePath</i> is <b>NULL</b> .
<i>DevicePath</i>	On return, points to a pointer to the device path of the RAM disk device. If <i>ParentDevicePath</i> is not <b>NULL</b> , the returned <i>DevicePath</i> is created by appending a RAM disk node to the parent device path. If <i>ParentDevicePath</i> is <b>NULL</b> , the returned <i>DevicePath</i> is a RAM disk device path without appending. This function is responsible for allocating the buffer <i>DevicePath</i> with the boot service <b>AllocatePool()</b> .

### Description

The *Register* function is used to register a specified RAM Disk. The consumer of this API is responsible for allocating the space of the RAM disk and deciding the initial content of the RAM disk. The producer of this API is responsible for installing the RAM disk device path and block I/O related protocols on the RAM disk device handle.

*RamDiskBase*, *RamDiskSize* and *RamDiskType* are used to fill RAM disk device node. If *RamDiskSize* is 0, then **EFI\_INVALID\_PARAMETER** is returned. If *RamDiskType* is **NULL**, then **EFI\_INVALID\_PARAMETER** is returned.

*DevicePath* returns the device path of the registered RAM disk. If *DevicePath* is **NULL**, then **EFI\_INVALID\_PARAMETER** is returned. If there are not enough resources to allocate

the device path node, then **EFI\_OUT\_OF\_RESOURCES** is returned. Otherwise, *DevicePath* is allocated with the boot service **AllocatePool()**. If *ParentDevicePath* is not **NULL** the *DevicePath* instance is created by appending a RAM disk device node to the *ParentDevicePath*. If *ParentDevicePath* is **NULL** the *DevicePath* instance is a pure RAM disk device path. If the created *DevicePath* instance is already present in the handle database, then **EFI\_ALREADY\_STARTED** is returned.

### Status Codes Returned

EFI_SUCCESS	The RAM disk is registered successfully.
EFI_INVALID_PARAMETER	<i>DevicePath</i> or <i>RamDiskType</i> is <b>NULL</b> .
EFI_INVALID_PARAMETER	<i>RamDiskSize</i> is 0.
EFI_ALREADY_STARTED	A Device Path Protocol instance to be created is already present in the handle database.
EFI_OUT_OF_RESOURCES	The RAM disk register operation fails due to resource limitation.

## EFI\_RAM\_DISK\_PROTOCOL.Unregister()

### Summary

This function is used to unregister a RAM disk specified by *DevicePath*.

### Prototype

```
typedef
EFI_STATUS
(EFIAPI *EFI_RAM_DISK_UNREGISTER_RAMDISK) (
    IN EFI_DEVICE_PATH_PROTOCOL    *DevicePath
);
```

### Parameters

*DevicePath*                      A pointer to the device path that describes a RAM Disk device.

### Description

The *Unregister* function is used to unregister a specified RAM Disk. The producer of this protocol is responsible for uninstalling the RAM disk device path and block I/O related protocols and freeing the RAM disk device handle. It is the consumer of this protocol's responsibility to free the memory used by this RAM disk.

### Status Codes Returned

EFI_SUCCESS	The RAM disk is unregistered successfully.
EFI_INVALID_PARAMETER	<i>DevicePath</i> is NULL.
EFI_UNSUPPORTED	The device specified by <i>DevicePath</i> is not a valid ramdisk device path and not supported by the driver.
EFI_NOT_FOUND	The RAM disk pointed by <i>DevicePath</i> doesn't exist.

## 13.18 Partition Information Protocol

### Summary

Installed along with EFI\_BLOCK\_IO\_PROTOCOL for logical partitions. The PARTITION\_INFORMATION\_PROTOCOL provides cached partition information for MBR and GPT partition types.

Set System to 1 for partition identified as EFI\_SYSTEM\_PARTITIONS, otherwise set System to 0.

Set Type to PARTITION\_TYPE\_OTHER for partitions that are not GPT or MBR to indicate no cached data.

## GUID

```
#define EFI_PARTITION_INFO_PROTOCOL_GUID \
{ \
  0x8cf2f62c, 0xbc9b, 0x4821, {0x80, 0x8d, 0xec, 0x9e, \
    0xc4, 0x21, 0xa1, 0xa0} \
}
```

## Protocol Interface Structure

```
#define EFI_PARTITION_INFO_PROTOCOL_REVISION 0x0001000
#define PARTITION_TYPE_OTHER 0x00
#define PARTITION_TYPE_MBR 0x01
#define PARTITION_TYPE_GPT 0x02

#pragma pack(1)

typedef struct {

  UINT32  Revision;
  UINT32  Type;
  UINT8   System;
  UINT8   Reserved[7];
  union {
    ///
    /// MBR data
    ///
    MBR_PARTITION_RECORD Mbr;

    ///
    /// GPT data
    ///
    EFI_PARTITION_ENTRY Gpt;
  } Info;
} EFI_PARTITION_INFO_PROTOCOL;

#pragma pack()
```

See [Section 5.2.1](#) for the definition of MBR\_PARTITION\_RECORD.

See [Section 5.3.3](#) for the definition of EFI\_PARTITION\_ENTRY.

## Parameters

*Revision* Set to EFI\_PARTITION\_INFO\_PROTOCOL\_REVISION

*Type* Partition info type (MBR, GPT, or Other).

*System* If 1, partition describes an EFI System Partition.

*Mbr* MBR information, if type is MBR.

*Gpt* GPT information, if type is GPT

## Description

The **EFI\_PARTITION\_INFO\_PROTOCOL** is a simple protocol used to cache the partition information for potential File System Drivers.

Care must be taken by UEFI utilities that manipulate partitions. The utility must gain exclusive access to the physical disk to cause the partition driver to be stopped before it changes the partition information. If the exclusive request is not granted, then the utility must reset the system after changing the partition information.

When Type is set to **PARTITION\_TYPE\_OTHER**, data in the **union** Info is undefined.

## 13.19 NVDIMM Label Protocol

### EFI\_NVDIMM\_LABEL\_PROTOCOL

This section provides a detailed description of the **EFI\_NVDIMM\_LABEL\_PROTOCOL**. For a high-level overview of the NVDIMM Label protocol see the **Label Storage Area Description** section.

#### Summary

Provides services that allow management of labels contained in a Label Storage Area that are associated with a specific NVDIMM Device Path. The labels describe how the data on the NVDIMM is organized in to namespaces, the layout being utilized, logical block size, unique label identifier, label state, etc.

#### GUID

```
#define EFI_NVDIMM_LABEL_PROTOCOL_GUID \
  {0xd40b6b80,0x97d5,0x4282, \
   {0xbb,0x1d,0x22,0x3a,0x16,0x91,0x80,0x58}}
```

#### Protocol Interface Structure

```
typedef struct _EFI_NVDIMM_LABEL_PROTOCOL {
  EFI_NVDIMM_LABEL_STORAGE_INFORMATION    LabelStorageInformation;
  EFI_NVDIMM_LABEL_STORAGE_READ           LabelStorageRead;
  EFI_NVDIMM_LABEL_STORAGE_WRITE         LabelStorageWrite;
}
```

#### Parameters

<b>LabelStorageInformation</b>	Reports the size of the Label Storage Area and the maximum amount of label data that can be read in a single call to <b>LabelStorageRead</b> or written in a single call to <b>LabelStorageWrite</b> .
<b>LabelStorageRead</b>	Returns the label data stored for the NVDIMM at the requested offset and length in the Label Storage Area.
<b>LabelStorageWrite</b>	Writes the label data stored for the NVDIMM at the requested offset and length in the Label Storage Area.

## EFI\_NVDIMM\_LABEL\_PROTOCOL.LabelStorageInformation()

### Summary

Retrieves the Label Storage Area size and the maximum transfer size for the LabelStorageRead and LabelStorageWrite methods that are associated with a specific NVDIMM Device Path.

### Prototype

```
typedef
EFI_STATUS
(EFI_API *EFI_NVDIMM_LABEL_STORAGE_INFORMATION) (
    IN EFI_NVDIMM_LABEL_PROTOCOL      *This,
    OUT UINT32                        *SizeOfLabelStorageArea,
    OUT UINT32                        *MaxTransferLength
);
```

### Parameters

- This** A pointer to the EFI\_NVDIMM\_LABEL\_PROTOCOL instance.
- SizeOfLabelStorageArea** The size of the Label Storage Area for the NVDIMM in bytes.
- MaxTransferLength** The maximum number of bytes that can be transferred in a single call to LabelStorageRead or LabelStorageWrite.

### Description

Retrieves the Label Storage Area size and the maximum transfer size for the LabelStorageRead and LabelStorageWrite methods.

### Status Codes Returned

EFI_SUCCESS	The size of the Label Storage Area and maximum transfer size returned are valid.
EFI_ACCESS_DENIED	The Label Storage Area for the NVDIMM device is not currently accessible
EFI_DEVICE_ERROR	A physical device error occurred and the data transfer failed to complete

## EFI\_NVDIMM\_LABEL\_PROTOCOL.LabelStorageRead()

### Summary

Retrieves label data for the NVDIMM for the requested byte offset and length from within the Label Storage Area that are associated with a specific NVDIMM Device Path.

### Prototype

```

typedef
EFI_STATUS
(EFI_API *EFI_NVDIMM_LABEL_STORAGE_READ) (
    IN CONST EFI_NVDIMM_LABEL_PROTOCOL    *This,
    IN UINT32                             Offset,
    IN UINT32                             TransferLength,
    OUT UINT8                             *LabelData
);

```

## Parameters

<b>This</b>	A pointer to the EFI_NVDIMM_LABEL_PROTOCOL instance.
<b>Offset</b>	The byte offset within the Label Storage Area to read from.
<b>TransferLength</b>	Number of bytes to read from the Label Storage Area beginning at the byte <b>Offset</b> specified. A <b>TransferLength</b> of 0 reads no data.
<b>LabelData</b>	The return label data read at the requested offset and length from within the Label Storage Area.

## Description

Retrieves the label data for the requested offset and length from within the Label Storage Area for the NVDIMM. See the **Label Index Block** and **Label Definitions** sections below for details on the contents of the label data.

## Status Codes Returned

EFI_SUCCESS	The label data from the Label Storage Area for the NVDIMM was read successfully at the specified <b>Offset</b> and <b>TransferLength</b> and <b>LabelData</b> contains valid data.
EFI_INVALID_PARAMETER	Returned if any of the following are true: - <b>Offset</b> > <b>SizeOfLabelStorageArea</b> reported in the <b>LabelStorageInformation</b> return data. - <b>Offset</b> + <b>TransferLength</b> is > <b>SizeOfLabelStorageArea</b> reported in the <b>LabelStorageInformation</b> return data. - <b>TransferLength</b> is > <b>MaxTransferLength</b> reported in the <b>LabelStorageInformation</b> return data.
EFI_ACCESS_DENIED	The Label Storage Area for the NVDIMM device is not currently accessible and labels cannot be read at this time.
EFI_DEVICE_ERROR	A physical device error occurred and the data transfer failed to complete

## EFI\_NVDIMM\_LABEL\_PROTOCOL.LabelStorageWrite()

## Summary

Writes label data for the NVDIMM for the requested byte offset and length to the Label Storage Area that are associated with a specific NVDIMM Device Path.

## Prototype

```
typedef
EFI_STATUS
(EFIAPI *EFI_NVDIMM_LABEL_STORAGE_WRITE) (
    IN CONSTEFI_NVDIMM_LABEL_PROTOCOL    *This,
    IN UINT32                            Offset,
    IN UINT32                            TransferLength,
    IN UINT8                              *LabelData
);
```

## Parameters

<b>This</b>	A pointer to the EFI_NVDIMM_LABEL_PROTOCOL instance.
<b>Offset</b>	The byte offset within the Label Storage Area to write to.
<b>TransferLength</b>	Number of bytes to write to the Label Storage Area beginning at the byte <b>Offset</b> specified. A <b>TransferLength</b> of 0 writes no data.
<b>LabelBuffer</b>	The label data to write at the requested offset and length from within the Label Storage Area.

## Description

Writes the label data for the requested offset and length in to the Label Storage Area for the NVDIMM. See the **Label Index Block** and **Label Definitions** sections below for details on the contents of the label data.

## Status Codes Returned

EFI_SUCCESS	The <b>LabelData</b> for the Label Storage Area for the NVDIMM was written successfully at the specified <b>Offset</b> and <b>TransferLength</b> .
EFI_INVALID_PARAMETER	Returned this status if any of the following are true: - <b>Offset</b> > <b>SizeOfLabelStorageArea</b> reported in the <b>LabelStorageInformation</b> return data. - <b>Offset</b> + <b>LabelBufferLength</b> is > <b>SizeOfLabelStorageArea</b> reported in the <b>LabelStorageInformation</b> return data. - <b>TransferLength</b> is > <b>MaxTransferLength</b> reported in the <b>LabelStorageInformation</b> return data.
EFI_ACCESS_DENIED	The Label Storage Area for the NVDIMM device is not currently accessible and labels cannot be written at this time.
EFI_DEVICE_ERROR	A physical device error occurred and the data transfer failed to complete



## Label Index Block Definitions

```
#define EFI_NVDIMM_LABEL_INDEX_SIG_LEN 16
#define EFI_NVDIMM_LABEL_INDEX_ALIGN 256

typedef struct EFI_NVDIMM_LABEL_INDEX_BLOCK {
    CHAR8 Sig[EFI_NVDIMM_LABEL_INDEX_SIG_LEN];
    UINT8 Flags[3];
    UINT8 LabelSize;
    UINT32 Seq;
    UINT64 MyOff;
    UINT64 MySize;
    UINT64 OtherOff;
    UINT64 LabelOff;
    UINT32 NSlot;
    UINT16 Major;
    UINT16 Minor;
    UINT64 Checksum;
    UINT8 Free[];
};
```

### Sig

Signature of the Index Block data structure. Must be "NAMESPACE\_INDEX\0".

### Flags

Boolean attributes of this Label Storage Area. There are no flag bits defined at this time, so this field must be zero.

### LabelSize

Size of each label in bytes, *128 bytes << LabelSize*. 1 means 256 bytes, 2 means 512 bytes, etc. Shall be 1 or greater.

### Seq

Sequence number used to identify which of the two Index Blocks is current. Only the least-significant two bits of this field are used in the current definition, rotating through the values depicted in **Figure Z: Cyclic Sequence Numbers in Label Index Block** below. The other bits must be zero.

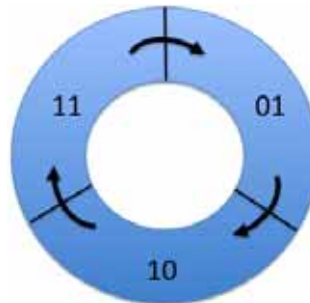

**Figure 36. Cyclic Sequence Numbers in Label Index Block**

Each time an Index Block is written, the sequence number of the current Index Block is “incremented” by moving to the next value clockwise as shown.

Since there are two Index Blocks, written alternatively with successive sequence numbers, the older Index Block’s sequence number will be immediately behind (counter-clockwise to) the current Index Block’s sequence number. This property is used during software initialization to identify the current Index Block.

The sequence number 00 is used to indicate an uninitialized or invalid Index Block. Software never writes the sequence number 00, so a correctly check-summed Index Block with this sequence number probably indicates a critical error. When software discovers this case it treats it as an invalid Index Block indication. If two Index Blocks with identical sequence numbers are found, software shall treat the Index Block at the higher offset as the valid Index Block.

**MyOff**

The offset of this Index Block in the Label Storage Area.

**MySize**

The size of this Index Block in bytes. This field must be a multiple of the `EFI_NVDIMM_LABEL_INDEX_ALIGN`.

**OtherOff**

The offset of the other Index Block paired with this one.

**LabelOff**

The offset of the first slot where labels are stored in this Label Storage Area.

**NSlot**

The total number of slots for storing labels in this Label Storage Area. The **NSlot** field is typically calculated once at Label Storage Area initialization as described in the **Initial Label Storage Area Configuration** description.

**Major**

Major version number. Value shall be 1.

**Minor**

Minor version number. Value shall be 2.

**Checksum**

64-bit *Fletcher64* checksum of all fields in this Index Block. This field is considered zero when the checksum is computed. For references to the Fletcher64 algorithm see “Links to UEFI-Related Documents” (<http://uefi.org/uefi>) under the heading “Fletcher64 Checksum Algorithm”

## Free

Array of unsigned bytes implementing a bitmask that tracks which label slots are free. A bit value of 0 indicates in use, 1 indicates free. The size of this field is the number of bytes required to hold the bitmask with **NSlot** bits, padded with additional zero bytes to make the Index Block size a multiple of `EFI_NVDIMM_LABEL_INDEX_ALIGN`. Any bits allocated beyond **NSlot** bits must be zero.

The bitmask is organized where the label slot with the lowest offset in the Label Storage Area is tracked by the least significant bit of the first byte of the free array. Missing from the above layout is a total count of free slots. Since the common use case for the Label Storage Area is to read all labels during software initialization, it is recommended that software create a total free count (or in use count, or both), maintained at run-time. Rules for maintaining the Index Blocks are described in the **Label Rules Description** and **Validating Index Blocks Description** below. See the **Initial Label Storage Area Configuration** section for a more details on how the total number of slots are calculated.

## Label Definitions

```
#define EFI_NVDIMM_LABEL_NAME_LEN 64

// Constants for Flags field
#define EFI_NVDIMM_LABEL_FLAGS_ROLABEL      0x00000001
#define EFI_NVDIMM_LABEL_FLAGS_LOCAL       0x00000002

// This reserved flag is utilized on older implementations
// and has been deprecated. Do not use
#define EFI_NVDIMM_LABEL_FLAGS_RESERVED    0x00000004

typedef struct EFI_NVDIMM_LABEL{
    EFI_GUID Uuid;
    CHAR8 Name[EFI_NVDIMM_LABEL_NAME_LEN];
    UINT32 Flags;
    UINT16 NLabel;
    UINT16 Position;
    UINT64 SetCookie;
    UINT64 LbaSize;
    UINT64 Dpa;
    UINT64 RawSize;
    UINT32 Slot;
    UINT8 Alignment;
    UINT8 Reserved[3];
    EFI_GUID TypeGuid;
    EFI_GUID AddressAbstractionGuid;
    UINT8 Reserved1[88];
    UINT64 Checksum;
};
```

## Uuid

Unique Label Identifier UUID per RFC 4122. This field provides two functions. First, the namespace is associated with a UUID that software can use to uniquely identify it and providing a way for the namespace to be matched up with applications using it. Second, when multiple labels are required to describe a namespace, the UUID is the mechanism used to group the labels together. See the additional descriptions below describing the process for grouping the labels together by UUID, checking for missing labels, recovering from partial label changes, etc.

### Name

NULL-terminated string using UTF-8 character formatting. The **Name** field is optionally used by software to store a more friendly name for the namespace. When this field is unused, it contains zeros.

If there is a name for a Local Namespace, as indicated by the **EFI\_NVDIMM\_LABEL\_FLAGS\_LOCAL** Flags, the name shall be stored in the first label of the set. All **Name** fields in subsequent labels for that Local Namespace are ignored.

The **Name** field can be set at label creation time, or updated by following the rules in the additional descriptions below.

### Flags

Boolean attributes of this namespace. See the additional description below on the use of the flags. The following values are defined:

**EFI\_NVDIMM\_LABEL\_FLAGS\_ROLABEL** – The label is read-only. This indicates the namespace is exported to a domain where configuration changes to the label are not allowed, such as a virtual machine. This indicates that device software and manageability software should refuse to make changes to the labels. This is a not a security mechanism, but a usability feature instead. In cases where **EFI\_NVDIMM\_LABEL\_FLAGS\_ROLABEL** is set, such as virtual machine guests, attempting to make configuration changes that affect the labels will fail (i.e. because the VM guest is not in a position to make the change correctly). For these cases, the VMM can set the **EFI\_NVDIMM\_LABEL\_FLAGS\_ROLABEL** bit on the label exposed to the guest to provide a better user experience where manageability refuses to make changes with a friendlier error message.

**EFI\_NVDIMM\_LABEL\_FLAGS\_LOCAL** – When set, the complete label set is local to a single NVDIMM Label Storage Area. When clear, the complete label set is contained on multiple NVDIMM Label Storage Areas.

**EFI\_NVDIMM\_LABEL\_FLAGS\_UPDATING** – When set, the label set is being updated. During an operation that may require updating multiple Label Storage Areas, the **EFI\_NVDIMM\_LABEL\_FLAGS\_UPDATING** flag is used to make the update atomic across interruptions. Updates happen in two phases, first writing the label with the **EFI\_NVDIMM\_LABEL\_FLAGS\_UPDATING** flag set, second writing the updated label without the **EFI\_NVDIMM\_LABEL\_FLAGS\_UPDATING** flag. As described in **Recovery Steps for a Non-Local Label Set Description**, this allows recovery actions during software initialization to either *roll back* or *roll forward* the multiple Label Storage Area changes. If **EFI\_NVDIMM\_LABEL\_FLAGS\_LOCAL** is set, the labels are contained in a single Label Storage Area and there is no need to set **EFI\_NVDIMM\_LABEL\_FLAGS\_UPDATING**, since the label can be written in one atomic operation.

## NLabel

Total number of labels describing this namespace. The **NLabel** field contains the number of labels required to describe a namespace.

## Position

Position of this label in list of labels for this namespace. See **NLabel** description above. In the non-local case, each label is numbered as to its position in the list of labels using the **Position** field. For example, the common case where a namespace requires exactly one label, **NLabel** will be 1 and **Position** will be 0. If a namespace is built on an Interleave Set that spans multiple Label Storage Areas, each Label Storage Area will contain a label with increasing **Position** values to show each labels position in the set. For Local Namespaces, **NLabel** is valid only for the first label (lowest DPA) and position shall be 0 for that label. As part of organizing and validating the labels, SW shall have organized the labels from lowest to highest DPA so the first label in that ordered list of labels will have the lowest DPA. **Position** and **NLabel** for all subsequent labels in that namespace shall be set to 0xFF. See the Local Namespace description in the **Validating Labels Description** section for details.

## SetCookie

Interleave Sets and the NVDIMMs they contain are defined in the NFIT and the Uuid in the label is used to uniquely identify each interleave set. The SetCookie is utilized by SW to perform consistency checks on the Interleave Set to verify the current physical device configuration matches the original physical configuration when the labels were created for the set. The label is considered invalid if the actual label set cookie doesn't match the cookie stored here. The **SetCookie** field in each label for that namespace is derived from data in the NVDIMM's Serial Presence Detect (SPD). See the **SetCookie Description** section below for **SetCookie** details. For references to the JEDEC SPD annex see "Links to UEFI-Related Documents" (<http://uefi.org/uefi>) under the heading "JEDEC SPD Annex"

## LbaSize

This is the default logical block size in bytes and may be superseded by a block size that is specified in the AbstractionGuid.

-A non-zero value indicates the logical block size that is being emulated.

-A value of zero indicates an unspecified size and its meaning is implementation specific

## Dpa

The *DPA* is the DIMM Physical address where the NVM contributing to this namespace begins on this NVDIMM.

## RawSize

The extent of the DPA contributed by this label.

## Slot

Current slot in the Label Storage Area where this label is stored.

## Alignment

Alignment hint used to advertise the preferred alignment of the data from within the namespace defined by this label.

### Reserved

Shall be 0

### TypeGuid

Range Type GUID that describes the access mechanism for the specified DPA range. The GUIDs utilized for the type are defined in the ACPI 6.0 specification in the NVDIMM FW Interface Table (NFIT) chapter. Those values are utilized here to describe the Type of namespace the label is describing. See the Address Range Type GUID field described in the System Physical Address (SPA) Range Structure table.

### AddressAbstractionGuid

Identifies the address abstraction mechanism for this namespace. A value of 0 indicates no mechanism used.

### Reserved1

Shall be 0

### Checksum

64-bit *Fletcher64* checksum of all fields in this Label. This field is considered zero when the checksum is computed. For references to the Fletcher64 algorithm see "Links to UEFI-Related Documents" (<http://uefi.org/uefi>) under the heading "Fletcher64 Checksum Algorithm"

### SetCookie Definition

```
typedef struct EFI_NVDIMM_LABEL_SET_COOKIE_INFO {
    typedef struct EFI_NVDIMM_LABEL_SET_COOKIE_MAP {
        UINT64 RegionOffset;
        UINT64 SerialNumber;
        UINT16 VendorId;
        UINT16 ManufacturingDate;
        UINT8 ManufacturingLocation;
        UINT8 Reserved[31];
    } Mapping[NumberOfNvdimmInInterleaveSet];
};
```

### NumberOfNvdimmInInterleaveSet

The number of NVDIMMs in the interleave set. This is 1 if **EFI\_NVDIMM\_LABEL\_FLAGS\_LOCAL** Flags is set indicating a Local Namespaces.

### RegionOffset

The Region Offset field from the ACPI NFIT NVDIMM Region Mapping Structure for a given entry. This determines the entry's position in the set. Region offset is 0 for Local Namespaces.

### SerialNumber

The serial number of the NVDIMM, assigned by the module vendor. This field shall be set to the value of the NVDIMM Serial Presence Detect (SPD) Module Serial Number field defined by JEDEC with byte 0 set to SPD byte 325, byte 1 set to SPD byte 326, byte 2 set to SPD byte 327, and byte 3 set to SPD byte 328. For references to the JEDEC SPD annex see “Links to UEFI-Related Documents” (<http://uefi.org/uefi>) under the heading “JEDEC SPD Annex”

### VendorId

The identifier indicating the vendor of the NVDIMM. This field shall be set to the value of the NVDIMM SPD Module Manufacturer ID Code field with byte 0 set to DDR4 SPD byte 320 and byte 1 set to DDR4 SPD byte 321. For references to the JEDEC SPD annex see “Links to UEFI-Related Documents” (<http://uefi.org/uefi>) under the heading “JEDEC SPD Annex”

### ManufacturingDate

The manufacturing date of the NVDIMM, assigned by the module vendor. This field shall be set to the value of the NVDIMM SPD Module Manufacturing Date field with byte 0 set to SPD byte 323 and byte 1 set to SPD byte 324. For references to the JEDEC SPD annex see “Links to UEFI-Related Documents” (<http://uefi.org/uefi>) under the heading “JEDEC SPD Annex”

### ManufacturingLocation

The manufacturing location from for the NVDIMM, assigned by the module vendor. This field shall be set to the value of the NVDIMM SPD Module Manufacturing Location field (SPD byte 322). For references to the JEDEC SPD annex see “Links to UEFI-Related Documents” (<http://uefi.org/uefi>) under the heading “JEDEC SPD Annex”

### Reserved

Shall be 0

### SetCookie Description

This value is used to detect a change in the set configuration that has rendered existing data invalid and otherwise validates that the namespace belongs to a given NVDIMM. For each set create a data structure of the form `EFI_NVDIMM_LABEL_SET_COOKIE_INFO`. The **SetCookie** is then calculated by sorting the **Mapping[]** array by **RegionOffset** and then taking the Fletcher64 sum of the total `EFI_NVDIMM_LABEL_SET_COOKIE_INFO` structure. For references to the Fletcher64 algorithm see “Links to UEFI-Related Documents” (<http://uefi.org/uefi>) under the heading “Fletcher64 Checksum Algorithm”

### Label Storage Area Description

Namespaces are defined by Labels which are stored in the *Label Storage Area(s)* and accessed via means described in the **Label Rules Description**.

The figure below shows the organization of the Label Storage Area. A header called the *Index Block* appears twice at the top of the Label Storage Area. This provides a powerfail-

safe method for updating the information in the Label Storage Area by alternating between the two Index Blocks when writing (more details on this mechanism below).

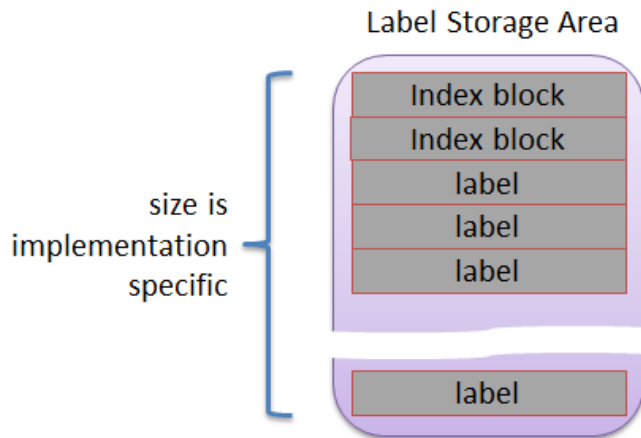

Following the Index Blocks, an array for storing labels takes up the remainder of the Label Storage Area. The size of the Label Storage Area is NVDIMM implementation specific. The Index Blocks contain a bitmap which indicates which label slots are currently free and which are in use. The same powerfail-safe mechanism used for updating the Index Blocks covers the update of labels in the Label Storage Area.

The powerfail-safe update mechanism uses the principle of avoiding writes to active metadata. Instead, a shadow copy is updated and checksums and sequence numbers are used to make the last written copy active (a complete description of this mechanism is in **Updating an Existing Label Description**).

### Initial Label Storage Area Configuration

The size of an Index Block depends on how many label slots fit into the Label Storage Area. The minimum size of an Index Block is 256 bytes and the size must be a multiple of `EFI_NVDIMM_LABEL_INDEX_ALIGN` bytes. As necessary, padding with zero bytes at the end of the structure is used to meet these size requirements. The minimum size of the Label Storage Area is large enough to hold 2 index blocks and 2 labels. As an example, for Label Storage Areas of 128KB and 256KB, the corresponding Index Block size is 256 or 512 bytes:

Example: <= 256 bytes		Example: > 256 bytes	
Size of the Index Block field up to the <b>free</b> field	72 bytes	Size of the Index Block field up to the <b>free</b> field	72 bytes



Bytes required for a bitmask of 1024 labels (the number of labels that fit into a 128KB Label Storage Area)	128 bytes	Bytes required for a bitmask of 2048 labels (the number of labels that fit into a 256KB Label Storage Area)	256 bytes
Padding to meet next increment of 256 bytes	56 bytes	Padding to meet next increment of 256 bytes	184
<b>Total size of the Index Block</b>	<b>256 bytes</b>		<b>512 bytes</b>

Before Index Blocks and labels can be utilized, the software managing the Label Storage Area must determine the total number of labels that will be supported and utilizing the description above, calculate the size of the Index Blocks required. Once the initial Label Storage Area is written with the first Index Blocks (typically done when the first Label needs to be written), the total number of slots is fixed and this initial calculation is not performed again.

## Label Description

Each slot in the Label Storage Area is either free or contains an active label.

In the cases where multiple labels are used to describe a namespace, the label fields **NLabel** and **Position** provide an ordering (“label one of two, label two of two”) so that incomplete label sets can be detected.

A namespace is described by one or more labels. Local namespaces describe one or more device physical address ranges from a single NVDIMM while non-Local namespaces describe a single SPA range that may have contributions from 2 or more NVDIMMs. The number of labels needed to describe a non-Local namespace is equal to the number of NVDIMMs contributing to the SPA range, 1 per-NVDIMM. For a Local namespace any number, up to the max number of labels supported by the Index Block / Label Storage Area, of device physical address ranges in the given NVDIMM can be described.

## Label Rules Description

All the algorithms related to labels in this specification assume single-threaded / non-reentrant execution. The algorithm for updating labels guarantees that at least one slot in the Label Storage Area will be free, ensuring it is always possible to update labels using this method.

Software shall maintain the following invariants to use the on-media data structures correctly and to inter-operate with other software components.

At all times, the following must be true:

- The size of the Label Storage Area is known (this must be true even if no namespace metadata has been written yet). The Label Storage Area size is queried from the NVDIMM.
- The Label Storage Area either contains no valid Index Blocks, indicating there are no labels on the NVDIMM (all slots free), or the validation rules below produce a single, valid, Index Block.
- 2 free slots are required in order to add a Label. Having only a single free slot indicates that no more labels can be added. Only fully written, active labels, and full-written labels with the **EFI\_NVDIMM\_LABEL\_FLAGS\_UPDATING** flag are marked in-use by the Index Block.
- Write to active label slots are not allowed; all updates to labels must be done by writing to free slots and then updating the Index Block to make them active.

### Validating Index Blocks Description

The following tests shall pass before software considers Index Blocks valid:

- Both Index Blocks must be read successfully from the Label Storage Area.
- Any Index Block with an incorrect **Sig** field is invalid.
- Any Index Block with an incorrect **Checksum** is invalid.
- Any Index Block with an incorrect **MyOff**, **MySize**, or **OtherOff** field is invalid.
- Any Index Block with a sequence number **Seq** of zero is invalid.
- If two valid Index Blocks remain, after passing all the above tests, and their sequence numbers match, the Index Block at the lower offset in the Label Storage Area is invalid.
- If two Index Blocks remain, after passing all the above tests, their sequence numbers are compared and the block whose sequence number is the predecessor of the other (immediately counter-clockwise to it, as shown in **Figure Z: Cyclic Sequence Numbers in Label Index Block** in the **Seq** description) is invalid.
- If one Index Block remains, that is the current, valid block and software should make note that the next update to the Index Block will write the other Index Block. However, if no valid Index Blocks remain, all slots are considered free and the next update to the index will write to the lower-addressed block location (i.e. the start of the Label Storage Area).

### Validating Labels Description

The following tests shall pass before software considers individual Labels slots valid:

- The corresponding free bit for the label **Slot** in the Index Block **Free** array must be clear (i.e. label slot is active).
- The label **Checksum** shall validate.
- The **Slot** value in the Label shall match the logical slot location of the Label.

- The **SetCookie** field in the label matches the expected value as described in **SetCookie Definition**.
- The address range type GUID **TypeGuid** shall match the System Physical Address Range Structure that describes the access mechanism for this namespace. For Hardware Block Namespaces it shall match the GUID for the NVDIMM Block Data Window Region.

#### For Local Namespaces:

- If 2 or more labels share the same **Dpa** value, all labels with the duplicated value are considered invalid.
- The count of all valid labels for a given namespace **Uuid** shall match the **NLabel** value in the first label.
- The first label, the label with the lowest **Dpa** value, shall have **Position** 0 and non-zero **NLabel** value.
- All labels other than the first have **Position** and **NLabel** set to 0xff.

### Reading Labels Description

For a given NVDIMM, the following steps are used to read one or more labels for validation and namespace assembly:

Pre-condition: both Index Blocks have been read and the rules in **Validating Index Blocks Description** have been followed to determine the current valid Index Block.

- Check that the label at a given slot is active. Specifically bit N is clear in the **Free** bitmask field where N corresponds to the logical slot number label.
- Read the label in that slot at the offset given by:  
 $(2 * \text{sizeof}(\text{EFI\_NVDIMM\_LABEL\_INDEX\_BLOCK}) + \text{slot} * \text{sizeof}(\text{EFI\_NVDIMM\_LABEL}))$

### Recovery Steps for a Non-Local Label Set Description

Given that a non-Local Label set potentially spans multiple Label Storage Areas for multiple NVDIMMs it is not possible to guarantee that the set is updated atomically with respect to unexpected system interruption. Recovery shall be performed before validating the set to roll the set forward to a consistent state or invalidate / free the label slots corresponding to an inconsistent state. Note that individual Index Block updates are safe with respect to unexpected system interruption given the sequence number mechanism for indicating the currently active Index Block.

The sequence below describes how the **EFI\_NVDIMM\_LABEL\_FLAGS\_UPDATING** flag is used when validating a non-Local Label Set.

- Pre-condition: The labels have been read.
- For each set of labels with the same UUID, if no labels in the set are found with the **EFI\_NVDIMM\_LABEL\_FLAGS\_UPDATING** flag set, then no recovery is required for that set.
- For the sets where **EFI\_NVDIMM\_LABEL\_FLAGS\_UPDATING** appear at least once, if the set is incomplete (some NVDIMMs in the set do not contain a label in the Label Storage Area

with the UUID), the recovery action is to roll back the interrupted create operation that left this state. I.e. for each NVDIMM in the set containing a label with the given UUID, delete the label.

- For a set where **EFI\_NVDIMM\_LABEL\_FLAGS\_UPDATING** appears at least once and the set is otherwise complete (each NVDIMM in the Interleave Set contains a label with the UUID, some with **EFI\_NVDIMM\_LABEL\_FLAGS\_UPDATING** set, some with **EFI\_NVDIMM\_LABEL\_FLAGS\_UPDATING** clear), the recovery action is to roll forward the change that was interrupted. I.e. for each NVDIMM in the set If **EFI\_NVDIMM\_LABEL\_FLAGS\_UPDATING** is set, write an updated label with **EFI\_NVDIMM\_LABEL\_FLAGS\_UPDATING** clear and with the name field copied from the first label in the set (the label with a **Position** field of **0**).

### Recovery Steps for a Local Label Set Description

Given that a Local Label set is always contained in a single Label Storage Area for a single NVDIMM, labels are added/updated atomically, as long as there is a free Label available as outlined in **Label Storage Area Description** and **Label Description**.

**EFI\_NVDIMM\_LABEL\_FLAGS\_UPDATING** should not be set for Local sets and no additional recovery is required.

### Assembling Labels into Complete Sets Description

After collecting a set of labels corresponding to a given UUID and performing the recovery actions on the set, software shall follow the steps in this section to assemble complete sets of labels representing usable namespaces:

1. Precondition: Labels have been read and the recovery actions have been taken.
2. For each set of labels with the same **Uuid**
  - a. If the set describes a non-Local namespace, it is considered complete if labels with unique **Position** fields are found for every position from **0** to **NLabel - 1**.
  - b. If the set describes a Local namespace, it is considered complete if a valid first label is found, according to the validation rules, and the number of labels in the set matches
  - c. **NLabel**.

The recovery action for the case where software finds incomplete namespaces is implementation specific.

### Updating an Existing Label Description

Updating an existing label in the Label Storage Area requires the software to follow these steps:

1. Pre-conditions: the software has an updated label constructed to be written to a specific NVDIMM's Label Storage Area. There is at least 1 free slot in the Label Storage Area **Free** bitmask..
2. The software chooses a free slot from the Index Block, fills in that slot number in the label's **Slot** field
3. The software writes the updated label to that slot in the Label Storage Area

4. The software updates the Index Block by taking the current Index Block, setting the appropriate bit in the **Free** field to make the old version of the label inactive and clearing the appropriate bit in the **Free** field to make the new version active, incrementing the sequence number as shown in **Figure Z: Cyclic Sequence Numbers in Label Index Block** in the **Seq** description, and then writing the Index Block over the inactive Index Block location (making this location the new active Index Block if the write succeeds)

### Deleting a Label Description

The software updates the Index Block by taking the current active Index Block, setting the appropriate bit in the **Free** field to make the deleted label inactive, incrementing the sequence number as shown in **Figure Z: Cyclic Sequence Numbers in Label Index Block** in the **Seq** description, and then writing the new Index Block over the inactive Index Block location (making this location the new active Index Block if the write succeeds)

### Creating Namespaces Description

Namespace creation procedures are different for Local vs non-Local namespaces. A Local namespace is created from 1 or more DPA ranges of a single NVDIMM, while a non-Local namespace is created from a single range contributed from multiple NVDIMMs. Both procedures share a common flow for establishing new labels in an Index Block.

### Writing New Labels Description

Transitioning a label slot from free to active shall follow this sequence:

1. Pre-conditions: the software has a new label constructed to be written to a specific NVDIMM's Label Storage Area. Because of the free Label rules outlined in **Label Storage Area Description** and **Label Description**, there are at least 2 free slots in the Label Storage Area as described in the **Label Rules Description** and **Label Description** sections. Choose a free slot from the Index Block, fills in that slot number in the label's **Slot** field
2. Write the new label to that slot in the Label Storage Area
3. Update the Index Block by taking the current Index Block, clearing the appropriate bit in the **Free** field, incrementing the sequence number as shown in **Figure Z: Cyclic Sequence Numbers in Label Index Block** in the **Seq** description, and then writing the Index Block over the inactive Index Block location (making this location the new active Index Block if the write succeeds)

### Creating a Non-Local Namespace

When creating a new Non-Local Namespace, the software shall follow these steps:

1. Pre-conditions: the labels to be written to each NVDIMM contributing to the namespace have been constructed, each with a unique **Position** field from **0** to **NLabel - 1**, and all labels with the same new UUID. All Index Blocks involved have at least 2 label slots free as described in the **Label Rules Description** and **Label Description** sections.
2. For each label in the set, the label is written with the **EFI\_NVDIMM\_LABEL\_FLAGS\_UPDATING** flag set, using the flow outlined in **Writing New Labels Description** to its corresponding NVDIMM / Label Storage Area.

3. For each label in the set, the label is updated with the same contents as the previous step, but with the **EFI\_NVDIMM\_LABEL\_FLAGS\_UPDATING** flag clear, using the flow outlined in **Updating an Existing Label Description**.

In the case of an unexpected system interruption, the above flows leave either a partial set of labels, all with the new UUID, with the **EFI\_NVDIMM\_LABEL\_FLAGS\_UPDATING** flag set, or a complete set of labels is left where some of them have the **EFI\_NVDIMM\_LABEL\_FLAGS\_UPDATING** flag set. The recovery steps in **Recovery Steps for a Non-Local Label Set Description** comprehend these two cases so that software can determine whether the set is consistent or needs to be invalidated.

### Creating a Local Namespace

Updating labels that are all on the same NVDIMM is atomic with respect to system interruption by nature of the Index Block update rules. Since Local namespaces reside on a single NVDIMM, the **EFI\_NVDIMM\_LABEL\_FLAGS\_UPDATING** flag and multi-pass update described in the previous section are not used. Software creating new Local namespaces shall follow these steps:

1. Pre-conditions: the labels to be written to the NVDIMM Label Storage Area have been constructed, whereby **Position**, **NLabel** and **SetCookie** adhere to the validation rules described earlier, and all labels share the same UUID. The Index Blocks involved have at least **NLabel** + 1 label slots free, so that after the new labels are written, it will have at least 1 free label slot left.

All labels are written to free slots and made active in one step using steps similar to the flow described above in **Writing New Labels Description**:

- a Free slots are identified using the current Index Block, the **Slot** field in each label is updated accordingly
- b All new labels are written into their free slots
- c The new Index Block is constructed so the new label slots are no longer marked free, the sequence number is advanced as shown in **Figure Z: Cyclic Sequence Numbers in Label Index Block** in the **Seq** description, and then the new Index Block is written over the inactive Index Block location (making this location the new active Index Block if the write succeeds)

## Updating the Name of a Namespace Description

### Updating Local Labels

When updating the name on a Local set the sequence outlined in **Writing New Labels Description** must be followed where the Name is updated before writing the updated Label.

### Updating Non Local Labels

To update the **Name** field associated with a non-Local Namespace, the software must follow these steps:

1. Pre-conditions: the namespace must already exist. Each NVDIMM in the namespace must have at least 1 free slot.
2. For each NVDIMM in the namespace, the label on that NVDIMM is updated with a label with the new **Name** field and the **EFI\_NVDIMM\_LABEL\_FLAGS\_UPDATING** flag set.

The “for each NVDIMM ” operation in this step must start with the NVDIMM containing the label whose **Position** field is zero.

3. For each NVDIMM in the namespace, the label is updated with the same contents as the previous step, but with the `EFI_NVDIMM_LABEL_FLAGS_UPDATING` flag clear, using the updating an existing label flow described above in Updating an Existing Label Description.

If the above steps are interrupted unexpectedly, the recovery steps in **Recovery Steps for a Non-Local Label Set Description** handle the case where a **Name** update is incomplete and finish the update.

## 13.20 EFI UFS Device Config Protocol

### EFI\_UFS\_DEVICE\_CONFIG\_PROTOCOL

#### Summary

User invokes this protocol to access the UFS device descriptors/flags/attributes and configure UFS device behavior.

#### GUID

```
#define EFI_UFS_DEVICE_CONFIG_GUID \
{ 0xb81bfab0, 0xeb3, 0x4cf9, \
  { 0x84, 0x65, 0x7f, 0xa9, 0x86, 0x36, 0x16, 0x64}}
```

#### Protocol Interface Structure

```
typedef struct _EFI_UFS_DEVICE_CONFIG_PROTOCOL {
  EFI_UFS_DEVICE_CONFIG_RW_DESCRIPTOR RwUfsDescriptor;
  EFI_UFS_DEVICE_CONFIG_RW_FLAG   RwUfsFlag;
  EFI_UFS_DEVICE_CONFIG_RW_ATTRIBUTE RwUfsAttribute;
} EFI_UFS_DEVICE_CONFIG_PROTOCOL;
```

#### Members

*RwUfsDescriptor*

Read or write specified device descriptor of a UFS device.

*RwUfsFlag*

Read or write specified flag of a UFS device.

*RwUfsAttribute*

Read or write specified attribute of a UFS device.

## Description

This protocol aims at defining a standard interface for UEFI drivers and applications to access UFS device descriptors/flags/attributes and configure the UFS device behavior.

## EFI\_UFS\_DEVICE\_CONFIG\_PROTOCOL.RwUfsDescriptor()

### Summary

This function is used to read or write specified device descriptor of a UFS device.

### Prototype

```
typedef
EFI_STATUS
(EFIAPI *EFI_UFS_DEVICE_CONFIG_RW_DESCRIPTOR) (
    IN EFI_UFS_DEVICE_CONFIG_PROTOCOL *This,
    IN BOOLEAN                      Read,
    IN UINT8                        DescId,
    IN UINT8                        Index,
    IN UINT8                        Selector,
    IN OUT UINT8                    *Descriptor,
    IN OUT UINT32                   *DescSize,
);
```

### Parameters

<i>This</i>	<i>The pointer to the EFI_UFS_DEVICE_CONFIG_PROTOCOL instance.</i>
<i>Read</i>	<i>The boolean variable to show r/w direction.</i>
<i>DescId</i>	<i>The ID of device descriptor.</i>
<i>Index</i>	<i>The Index of device descriptor.</i>
<i>Selector</i>	<i>The Selector of device descriptor.</i>
<i>Descriptor</i>	<i>The buffer of device descriptor to be read or written.</i>
<i>DescSize</i>	<i>The size of device descriptor buffer. On input, the size, in bytes, of the data buffer specified by Descriptor. On output, the number of bytes that were actually transferred.</i>

### Description

The *RwUfsDescriptor* function is used to read/write UFS device descriptors. The consumer of this API is responsible for allocating the data buffer pointed by *Descriptor*.



## Status Codes Returned

EFI_SUCCESS	The device descriptor is read/written successfully.
EFI_INVALID_PARAMETER	<i>This is NULL or Descriptor is NULL or DescSize is NULL.</i>
EFI_INVALID_PARAMETER	<i>DescId, Index and Selector are invalid combination to point to a type of UFS device descriptor.</i>
EFI_DEVICE_ERROR	The device descriptor is not read/written successfully.

## EFI\_UFS\_DEVICE\_CONFIG\_PROTOCOL.RwUfsFlag()

### Summary

This function is used to read or write specified flag of a UFS device.

### Prototype

```
typedef
EFI_STATUS
(EFI_API *EFI_UFS_DEVICE_CONFIG_RW_FLAG) (
  IN EFI_UFS_DEVICE_CONFIG_PROTOCOL *This,
  IN BOOLEAN                      Read,
  IN UINT8                        FlagId,
  IN OUT UINT8                    *Flag,
);
```

### Parameters

<i>This</i>	<i>The pointer to the EFI_UFS_DEVICE_CONFIG_PROTOCOL instance.</i>
<i>Read</i>	<i>The boolean variable to show r/w direction.</i>
<i>FlagId</i>	<i>The ID of flag to be read or written.</i>
<i>Flag</i>	<i>The buffer to set or clear flag.</i>

### Description

The *RwUfsFlag* function is used to read/write UFS flag descriptors. The consumer of this API is responsible for allocating the buffer pointed by *Flag*. The buffer size is 1 byte as UFS flag descriptor is just a single Boolean value that represents a TRUE or FALSE, '0' or '1', ON or OFF type of value.

### Status Codes Returned

EFI_SUCCESS	The flag descriptor is set/clear successfully.
EFI_INVALID_PARAMETER	<i>This</i> is NULL or <i>Flag</i> is NULL.
EFI_INVALID_PARAMETER	<i>FlagId</i> is an invalid UFS flag ID.
EFI_DEVICE_ERROR	The flag is not set/clear successfully.

## EFI\_UFS\_DEVICE\_CONFIG\_PROTOCOL.RwUfsAttribute()

### Summary

This function is used to read or write specified attribute of a UFS device.

### Prototype

```

typedef
EFI_STATUS
(EFI_API *EFI_UFS_DEVICE_CONFIG_RW_ATTRIBUTE) (
    IN EFI_UFS_DEVICE_CONFIG_PROTOCOL *This,
    IN BOOLEAN                        Read,
    IN UINT8                          AttrId,
    IN UINT8                          Index,
    IN UINT8                          Selector,
    IN OUT UINT8                      *Attribute,
    IN OUT UINT32                     *AttrSize,
);
    
```

### Parameters

<i>This</i>	<i>The pointer to the EFI_UFS_DEVICE_CONFIG_PROTOCOL instance.</i>
<i>Read</i>	<i>The boolean variable to show r/w direction.</i>
<i>AttrId</i>	<i>The ID of Attribute.</i>
<i>Index</i>	<i>The Index of Attribute.</i>
<i>Selector</i>	<i>The Selector of Attribute.</i>
<i>Attribute</i>	<i>The buffer of Attribute to be read or written.</i>
<i>AttrSize</i>	<i>The size of Attribute buffer. On input, the size, in bytes, of the data buffer specified by Attribute. On output, the number of bytes that were actually transferred.</i>

### Description

The *RwUfsAttribute* function is used to read/write UFS attributes. The consumer of this API is responsible for allocating the data buffer pointed by *Attribute*.

## Status Codes Returned

EFI_SUCCESS	The attribute is read/written successfully.
EFI_INVALID_PARAMETER	<i>This is NULL or Attribute is NULL or AttrSize is NULL.</i>
EFI_INVALID_PARAMETER	<i>AttrId, Index and Selector are invalid combination to point to a type of UFS attribute.</i>
EFI_DEVICE_ERROR	The attribute is not read/written successfully.



# 14 Protocols — PCI Bus Support

---

## 14.1 PCI Root Bridge I/O Support

[Section 14.1](#) and [Section 14.2](#) describe the PCI Root Bridge I/O Protocol. This protocol provides an I/O abstraction for a PCI Root Bridge that is produced by a PCI Host Bus Controller. A PCI Host Bus Controller is a hardware component that allows access to a group of PCI devices that share a common pool of PCI I/O and PCI Memory resources. This protocol is used by a PCI Bus Driver to perform PCI Memory, PCI I/O, and PCI Configuration cycles on a PCI Bus. It also provides services to perform different types of bus mastering DMA on a PCI bus. PCI device drivers will not directly use this protocol. Instead, they will use the I/O abstraction produced by the PCI Bus Driver. Only drivers that require direct access to the entire PCI bus should use this protocol. In particular, this chapter defines functions for managing PCI buses, although other bus types may be supported in a similar fashion as extensions to this specification.

All the services described in this chapter that generate PCI transactions follow the ordering rules defined in the *PCI Specification*. If the processor is performing a combination of PCI transactions and system memory transactions, then there is no guarantee that the system memory transactions will be strongly ordered with respect to the PCI transactions. If strong ordering is required, then processor-specific mechanisms may be required to guarantee strong ordering. Some 64-bit systems may require the use of memory fences to guarantee ordering.

### 14.1.1 PCI Root Bridge I/O Overview

The interfaces provided in the [EFI\\_PCI\\_ROOT\\_BRIDGE\\_IO\\_PROTOCOL](#) are for performing basic operations to memory, I/O, and PCI configuration space. The system provides abstracted access to basic system resources to allow a driver to have a programmatic method to access these basic system resources.

The [EFI\\_PCI\\_ROOT\\_BRIDGE\\_IO\\_PROTOCOL](#) allows for future innovation of the platform. It abstracts device-specific code from the system memory map. This allows system designers to make changes to the system memory map without impacting platform independent code that is consuming basic system resources.

A platform can be viewed as a set of processors and a set of core chipset components that may produce one or more host buses. [Figure 37](#) shows a platform with  $n$  processors (*CPUs* in the figure), and a set of core chipset components that produce  $m$  host bridges.

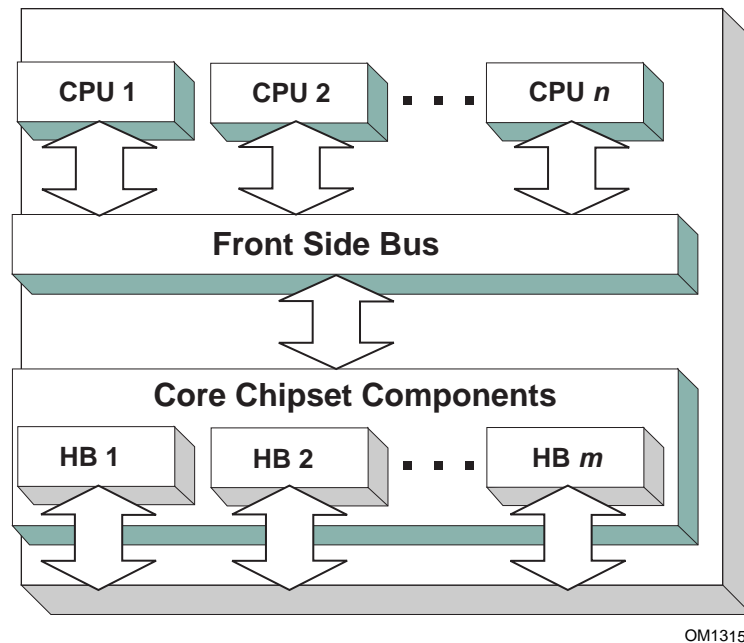

OM13150

Figure 37. Host Bus Controllers

Simple systems with one PCI Host Bus Controller will contain a single instance of the [EFI\\_PCI\\_ROOT\\_BRIDGE\\_IO\\_PROTOCOL](#). More complex system may contain multiple instances of this protocol. It is important to note that there is no relationship between the number of chipset components in a platform and the number of [EFI\\_PCI\\_ROOT\\_BRIDGE\\_IO\\_PROTOCOL](#) instances. This protocol abstracts access to a PCI Root Bridge from a software point of view, and it is attached to a device handle that represents a PCI Root Bridge. A PCI Root Bridge is a chipset component(s) that produces a physical PCI Bus. It is also the parent to a set of PCI devices that share common PCI I/O, PCI Memory, and PCI Prefetchable Memory regions. A PCI Host Bus Controller is composed of one or more PCI Root Bridges.

A PCI Host Bridge and PCI Root Bridge are different than a PCI Segment. A PCI Segment is a collection of up to 256 PCI busses that share the same PCI Configuration Space. Depending on the chipset, a single [EFI\\_PCI\\_ROOT\\_BRIDGE\\_IO\\_PROTOCOL](#) may abstract a portion of a PCI Segment, or an entire PCI Segment. A PCI Host Bridge may produce one or more PCI Root Bridges. When a PCI Host Bridge produces multiple PCI Root Bridges, it is possible to have more than one PCI Segment.

PCI Root Bridge I/O Protocol instances are either produced by the system firmware or by a UEFI driver. When a PCI Root Bridge I/O Protocol is produced, it is placed on a device handle along with an EFI Device Path Protocol instance. [Figure 38](#) shows a sample device handle for a PCI Root Bridge Controller that includes an instance of the [EFI\\_DEVICE\\_PATH\\_PROTOCOL](#) and the [EFI\\_PCI\\_ROOT\\_BRIDGE\\_IO\\_PROTOCOL](#). [Section 14.2](#) describes the PCI Root Bridge I/O Protocol in detail, and [Section 14.2.1](#) describes how to build device paths for PCI Root Bridges. The [EFI\\_PCI\\_ROOT\\_BRIDGE\\_IO\\_PROTOCOL](#) does not abstract access to the chipset-specific

registers that are used to manage a PCI Root Bridge. This functionality is hidden within the system firmware or the driver that produces the handles that represent the PCI Root Bridges.

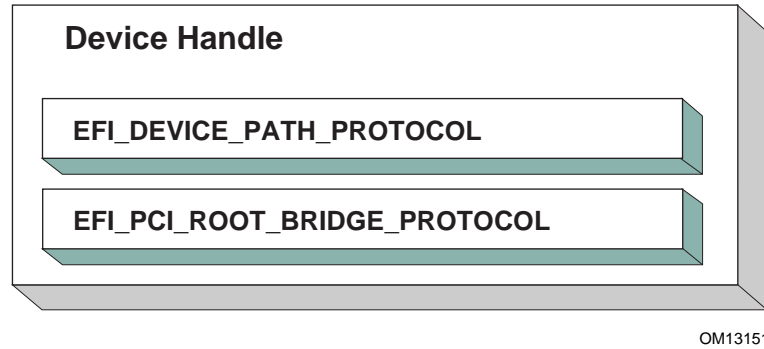
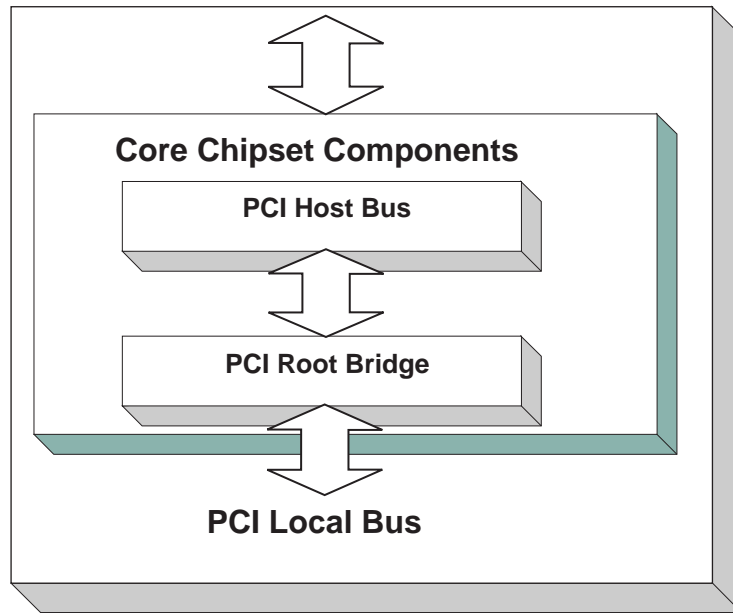

Figure 38. Device Handle for a PCI Root Bridge Controller

#### 14.1.1.1 Sample PCI Architectures

The PCI Root Bridge I/O Protocol is designed to provide a software abstraction for a wide variety of PCI architectures including the ones described in this section. This section is not intended to be an exhaustive list of the PCI architectures that the PCI Root Bridge I/O Protocol can support. Instead, it is intended to show the flexibility of this protocol to adapt to current and future platform designs.

[Figure 39](#) shows an example of a PCI Host Bus with one PCI Root Bridge. This PCI Root Bridge produces one PCI Local Bus that can contain PCI Devices on the motherboard and/or PCI slots. This would be typical of a desktop system. A higher end desktop system might contain a second PCI Root Bridge for AGP devices. The firmware for this platform would produce one instance of the PCI Root Bridge I/O Protocol.



OM13161

**Figure 39. Desktop System with One PCI Root Bridge**

[Figure 40](#) shows an example of a larger server with one PCI Host Bus and four PCI Root Bridges. The PCI devices attached to the PCI Root Bridges are all part of the same coherency domain. This means they share a common PCI I/O Space, a common PCI Memory Space, and a common PCI Prefetchable Memory Space. Each PCI Root Bridge produces one PCI Local Bus that can contain PCI Devices on the motherboard or PCI slots. The firmware for this platform would produce four instances of the PCI Root Bridge I/O Protocol.



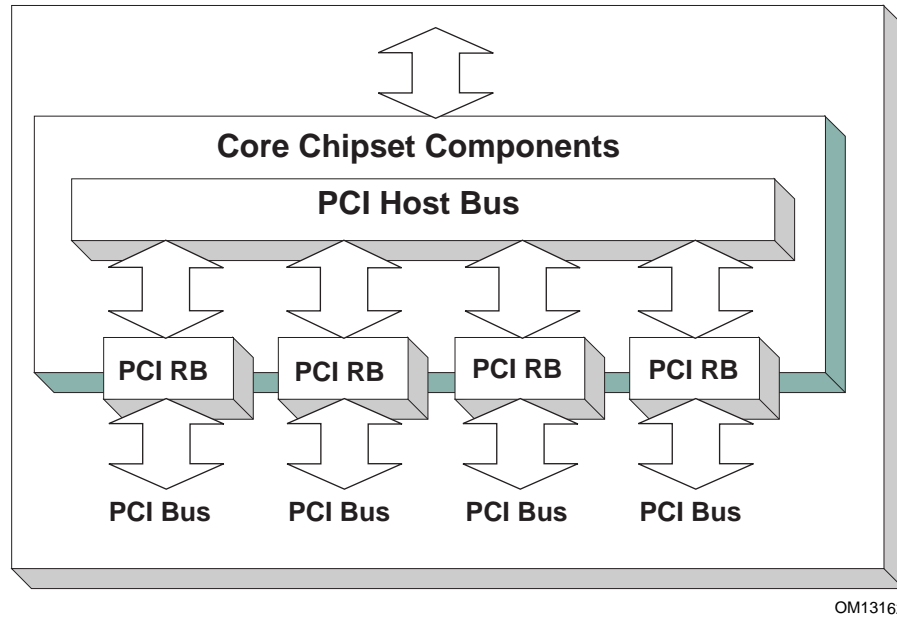
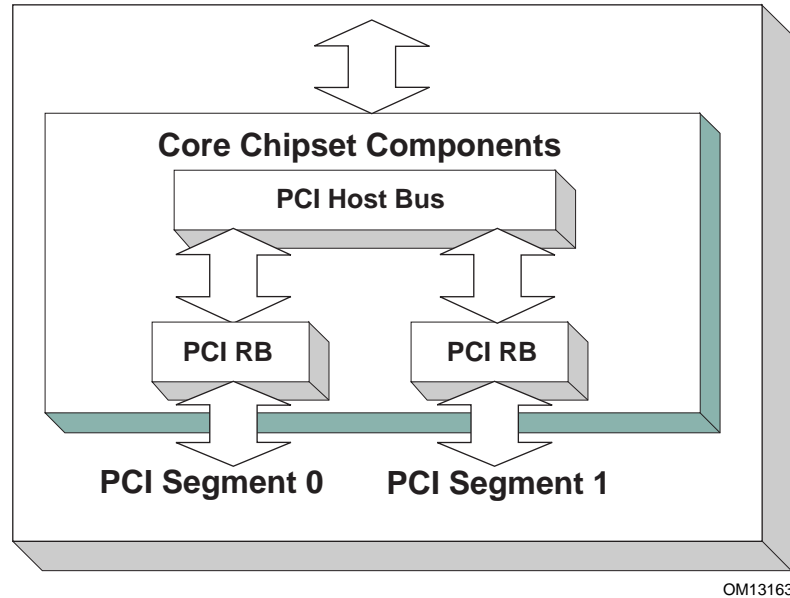

Figure 40. Server System with Four PCI Root Bridges

[Figure 41](#) shows an example of a server with one PCI Host Bus and two PCI Root Bridges. Each of these PCI Root Bridges is a different PCI Segment which allows the system to have up to 512 PCI Buses. A single PCI Segment is limited to 256 PCI Buses. These two segments do not share the same PCI Configuration Space, but they do share the same PCI I/O, PCI Memory, and PCI Prefetchable Memory Space. This is why it can be described by a single PCI Host Bus. The firmware for this platform would produce two instances of the PCI Root Bridge I/O Protocol.



OM13163

Figure 41. Server System with Two PCI Segments

[Figure 42](#) shows a server system with two PCI Host Buses and one PCI Root Bridge per PCI Host Bus. This system supports up to 512 PCI Buses, but the PCI I/O, PCI Memory Space, and PCI Prefetchable Memory Space are not shared between the two PCI Root Bridges. The firmware for this platform would produce two instances of the PCI Root Bridge I/O Protocol.

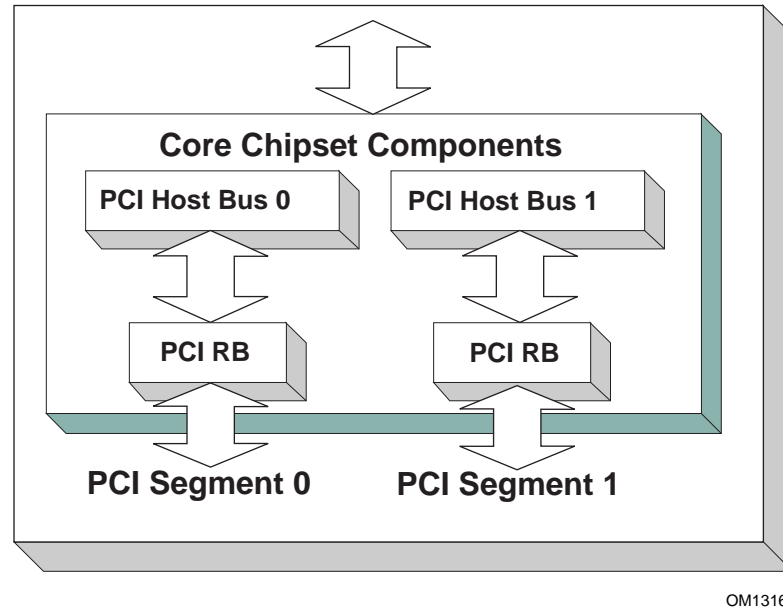

Figure 42. Server System with Two PCI Host Buses

## 14.2 PCI Root Bridge I/O Protocol

This section provides detailed information on the PCI Root Bridge I/O Protocol and its functions.

### EFI\_PCI\_ROOT\_BRIDGE\_IO\_PROTOCOL

#### Summary

Provides the basic Memory, I/O, PCI configuration, and DMA interfaces that are used to abstract accesses to PCI controllers behind a PCI Root Bridge Controller.

#### GUID

```
#define EFI_PCI_ROOT_BRIDGE_IO_PROTOCOL_GUID \
  {0x2F707EBB,0x4A1A,0x11d4,\
   {0x9A,0x38,0x00,0x90,0x27,0x3F,0xC1,0x4D}}
```

#### Protocol Interface Structure

```
typedef struct _EFI_PCI_ROOT_BRIDGE_IO_PROTOCOL {
  EFI_HANDLE      ParentHandle;
  EFI_PCI_ROOT_BRIDGE_IO_PROTOCOL_POLL_IO_MEM PollMem;
  EFI_PCI_ROOT_BRIDGE_IO_PROTOCOL_POLL_IO_MEM PollIo;
  EFI_PCI_ROOT_BRIDGE_IO_PROTOCOL_ACCESS Mem;
  EFI_PCI_ROOT_BRIDGE_IO_PROTOCOL_ACCESS Io;
  EFI_PCI_ROOT_BRIDGE_IO_PROTOCOL_ACCESS Pci;
```

```

EFI_PCI_ROOT_BRIDGE_IO_PROTOCOL_COPY_MEM  CopyMem;
EFI_PCI_ROOT_BRIDGE_IO_PROTOCOL_MAP      Map;
EFI_PCI_ROOT_BRIDGE_IO_PROTOCOL_UNMAP    Unmap;
EFI_PCI_ROOT_BRIDGE_IO_PROTOCOL_ALLOCATE_BUFFER AllocateBuffer;
EFI_PCI_ROOT_BRIDGE_IO_PROTOCOL_FREE_BUFFER FreeBuffer;
EFI_PCI_ROOT_BRIDGE_IO_PROTOCOL_FLUSH    Flush;
EFI_PCI_ROOT_BRIDGE_IO_PROTOCOL_GET_ATTRIBUTES GetAttributes;
EFI_PCI_ROOT_BRIDGE_IO_PROTOCOL_SET_ATTRIBUTES SetAttributes;
EFI_PCI_ROOT_BRIDGE_IO_PROTOCOL_CONFIGURATION Configuration;
UINT32      SegmentNumber;
} EFI_PCI_ROOT_BRIDGE_IO_PROTOCOL;
    
```

## Parameters

<i>ParentHandle</i>	The <b>EFI_HANDLE</b> of the PCI Host Bridge of which this PCI Root Bridge is a member.
<i>PollMem</i>	Polls an address in memory mapped I/O space until an exit condition is met, or a timeout occurs. See the <a href="#">PollMem()</a> function description.
<i>PollIo</i>	Polls an address in I/O space until an exit condition is met, or a timeout occurs. See the <a href="#">PollIo()</a> function description.
<i>Mem.Read</i>	Allows reads from memory mapped I/O space. See the <a href="#">Mem.Read()</a> function description.
<i>Mem.Write</i>	Allows writes to memory mapped I/O space. See the <a href="#">Mem.Write()</a> function description.
<i>Io.Read</i>	Allows reads from I/O space. See the <a href="#">Io.Read()</a> function description.
<i>Io.Write</i>	Allows writes to I/O space. See the <a href="#">Io.Write()</a> function description.
<i>Pci.Read</i>	Allows reads from PCI configuration space. See the <a href="#">Pci.Read()</a> function description.
<i>Pci.Write</i>	Allows writes to PCI configuration space. See the <a href="#">Pci.Write()</a> function description.
<i>CopyMem</i>	Allows one region of PCI root bridge memory space to be copied to another region of PCI root bridge memory space. See the <a href="#">CopyMem()</a> function description.
<i>Map</i>	Provides the PCI controller-specific addresses needed to access system memory for DMA. See the <a href="#">Map()</a> function description.
<i>Unmap</i>	Releases any resources allocated by <b>Map()</b> . See the <a href="#">Unmap()</a> function description.
<i>AllocateBuffer</i>	Allocates pages that are suitable for a common buffer mapping. See the <a href="#">AllocateBuffer()</a> function description.
<i>FreeBuffer</i>	Free pages that were allocated with <b>AllocateBuffer()</b> . See the <a href="#">FreeBuffer()</a> function description.

<i>Flush</i>	Flushes all PCI posted write transactions to system memory. See the <a href="#">Flush()</a> function description.
<i>GetAttributes</i>	Gets the attributes that a PCI root bridge supports setting with <a href="#">SetAttributes()</a> , and the attributes that a PCI root bridge is currently using. See the <a href="#">GetAttributes()</a> function description.
<i>SetAttributes</i>	Sets attributes for a resource range on a PCI root bridge. See the <a href="#">SetAttributes()</a> function description.
<i>Configuration</i>	Gets the current resource settings for this PCI root bridge. See the <a href="#">Configuration()</a> function description.
<i>SegmentNumber</i>	The segment number that this PCI root bridge resides.

## Related Definitions

```

//*****
// EFI_PCI_ROOT_BRIDGE_IO_PROTOCOL_WIDTH
//*****
typedef enum {
  EfiPciWidthUint8,
  EfiPciWidthUint16,
  EfiPciWidthUint32,
  EfiPciWidthUint64,
  EfiPciWidthFifoUint8,
  EfiPciWidthFifoUint16,
  EfiPciWidthFifoUint32,
  EfiPciWidthFifoUint64,
  EfiPciWidthFillUint8,
  EfiPciWidthFillUint16,
  EfiPciWidthFillUint32,
  EfiPciWidthFillUint64,
  EfiPciWidthMaximum
} EFI_PCI_ROOT_BRIDGE_IO_PROTOCOL_WIDTH;

//*****
// EFI_PCI_ROOT_BRIDGE_IO_PROTOCOL_POLL_IO_MEM
//*****
typedef
EFI_STATUS
(EFI_API *EFI_PCI_ROOT_BRIDGE_IO_PROTOCOL_POLL_IO_MEM) (
  IN struct EFI_PCI_ROOT_BRIDGE_IO_PROTOCOL *This,
  IN EFI_PCI_ROOT_BRIDGE_IO_PROTOCOL_WIDTH Width,
  IN UINT64 Address,
  IN UINT64 Mask,
  IN UINT64 Value,
  IN UINT64 Delay,
  OUT UINT64 *Result
);

```

```

//*****
// EFI_PCI_ROOT_BRIDGE_IO_PROTOCOL_IO_MEM
//*****
typedef
EFI_STATUS
(EFI_API *EFI_PCI_ROOT_BRIDGE_IO_PROTOCOL_IO_MEM) (
    IN EFI_PCI_ROOT_BRIDGE_IO_PROTOCOL *This,
    IN EFI_PCI_ROOT_BRIDGE_IO_PROTOCOL_WIDTH Width,
    IN UINT64 Address,
    IN UINTN Count,
    IN OUT VOID *Buffer
);

//*****
// EFI_PCI_ROOT_BRIDGE_IO_PROTOCOL_ACCESS
//*****
typedef struct {
    EFI_PCI_ROOT_BRIDGE_IO_PROTOCOL_IO_MEM Read;
    EFI_PCI_ROOT_BRIDGE_IO_PROTOCOL_IO_MEM Write;
} EFI_PCI_ROOT_BRIDGE_IO_PROTOCOL_ACCESS;

//*****
// EFI PCI Root Bridge I/O Protocol Attribute bits
//*****
#define EFI_PCI_ATTRIBUTE_ISA_MOTHERBOARD_IO 0x0001
#define EFI_PCI_ATTRIBUTE_ISA_IO 0x0002
#define EFI_PCI_ATTRIBUTE_VGA_PALETTE_IO 0x0004
#define EFI_PCI_ATTRIBUTE_VGA_MEMORY 0x0008
#define EFI_PCI_ATTRIBUTE_VGA_IO 0x0010
#define EFI_PCI_ATTRIBUTE_IDE_PRIMARY_IO 0x0020
#define EFI_PCI_ATTRIBUTE_IDE_SECONDARY_IO 0x0040
#define EFI_PCI_ATTRIBUTE_MEMORY_WRITE_COMBINE 0x0080
#define EFI_PCI_ATTRIBUTE_MEMORY_CACHED 0x0800
#define EFI_PCI_ATTRIBUTE_MEMORY_DISABLE 0x1000
#define EFI_PCI_ATTRIBUTE_DUAL_ADDRESS_CYCLE 0x8000
#define EFI_PCI_ATTRIBUTE_ISA_IO_16 0x10000
#define EFI_PCI_ATTRIBUTE_VGA_PALETTE_IO_16 0x20000
#define EFI_PCI_ATTRIBUTE_VGA_IO_16 0x40000

```

**EFI\_PCI\_ATTRIBUTE\_ISA\_IO\_16**

If this bit is set, then the PCI I/O cycles between 0x100 and 0x3FF are forwarded onto a PCI root bridge using a 16-bit address decoder on address bits 0..15. Address bits 16..31 must be zero. This bit is used to forward I/O cycles for

legacy ISA devices onto a PCI root bridge. This bit may not be combined with **EFI\_PCI\_ATTRIBUTE\_ISA\_IO**.

#### **EFI\_PCI\_ATTRIBUTE\_VGA\_PALETTE\_IO\_16**

If this bit is set, then the PCI I/O write cycles for 0x3C6, 0x3C8, and 0x3C9 are forwarded onto a PCI root bridge using a 16-bit address decoder on address bits 0..15. Address bits 16..31 must be zero. This bit is used to forward I/O write cycles to the VGA palette registers onto a PCI root bridge. This bit may not be combined with **EFI\_PCI\_ATTRIBUTE\_VGA\_IO** or **EFI\_PCI\_ATTRIBUTE\_VGA\_PALETTE\_IO**.

#### **EFI\_PCI\_ATTRIBUTE\_VGA\_IO\_16**

If this bit is set, then the PCI I/O cycles in the ranges 0x3B0–0x3BB and 0x3C0–0x3DF are forwarded onto a PCI root bridge using a 16-bit address decoder on address bits 0..15. Address bits 16..31 must be zero. This bit is used to forward I/O cycles for a VGA controller onto a PCI root bridge. This bit may not be combined with **EFI\_PCI\_ATTRIBUTE\_VGA\_IO** or **EFI\_PCI\_ATTRIBUTE\_VGA\_PALETTE\_IO**. Because **EFI\_PCI\_ATTRIBUTE\_VGA\_IO\_16** also includes the I/O range described by **EFI\_PCI\_ATTRIBUTE\_VGA\_PALETTE\_IO\_16**, the **EFI\_PCI\_ATTRIBUTE\_VGA\_PALETTE\_IO\_16** bit is ignored if **EFI\_PCI\_ATTRIBUTE\_VGA\_IO\_16** is set.

#### **EFI\_PCI\_ATTRIBUTE\_ISA\_MOTHERBOARD\_IO**

If this bit is set, then the PCI I/O cycles between 0x00000000 and 0x000000FF are forwarded onto a PCI root bridge. This bit is used to forward I/O cycles for ISA motherboard devices onto a PCI root bridge.

#### **EFI\_PCI\_ATTRIBUTE\_ISA\_IO**

If this bit is set, then the PCI I/O cycles between 0x100 and 0x3FF are forwarded onto a PCI root bridge using a 10-bit address decoder on address bits 0..9. Address bits 10..15 are not decoded, and address bits 16..31 must be zero. This bit is used to forward I/O cycles for legacy ISA devices onto a PCI root bridge.

#### **EFI\_PCI\_ATTRIBUTE\_VGA\_PALETTE\_IO**

If this bit is set, then the PCI I/O write cycles for 0x3C6, 0x3C8, and 0x3C9 are forwarded onto a PCI root bridge using a 10 bit address decoder on address bits 0..9. Address bits 10..15 are not decoded, and address bits 16..31 must be zero. This bit is used to forward I/O write cycles to the VGA palette registers onto a PCI root bridge.

#### **EFI\_PCI\_ATTRIBUTE\_VGA\_MEMORY**

If this bit is set, then the PCI memory cycles between 0xA0000 and 0xBFFFF are forwarded onto a PCI root bridge. This bit is used to forward memory cycles for a VGA frame buffer onto a PCI root bridge.

**EFI\_PCI\_ATTRIBUTE\_VGA\_IO**

If this bit is set, then the PCI I/O cycles in the ranges 0x3B0-0x3BB and 0x3C0-0x3DF are forwarded onto a PCI root bridge using a 10-bit address decoder on address bits 0..9. Address bits 10..15 are not decoded, and the address bits 16..31 must be zero. This bit is used to forward I/O cycles for a VGA controller onto a PCI root bridge. Since **EFI\_PCI\_ATTRIBUTE\_ENABLE\_VGA\_IO** also includes the I/O range described by **EFI\_PCI\_ATTRIBUTE\_ENABLE\_VGA\_PALETTE\_IO**, the **EFI\_PCI\_ATTRIBUTE\_ENABLE\_VGA\_PALETTE\_IO** bit is ignored if **EFI\_PCI\_ATTRIBUTE\_ENABLE\_VGA\_IO** is set.

**EFI\_PCI\_ATTRIBUTE\_IDE\_PRIMARY\_IO**

If this bit is set, then the PCI I/O cycles in the ranges 0x1F0-0x1F7 and 0x3F6-0x3F7 are forwarded onto a PCI root bridge using a 16-bit address decoder on address bits 0..15. Address bits 16..31 must be zero. This bit is used to forward I/O cycles for a Primary IDE controller onto a PCI root bridge.

**EFI\_PCI\_ATTRIBUTE\_IDE\_SECONDARY\_IO**

If this bit is set, then the PCI I/O cycles in the ranges 0x170-0x177 and 0x376-0x377 are forwarded onto a PCI root bridge using a 16-bit address decoder on address bits 0..15. Address bits 16..31 must be zero. This bit is used to forward I/O cycles for a Secondary IDE controller onto a PCI root bridge.

**EFI\_PCI\_ATTRIBUTE\_MEMORY\_WRITE\_COMBINE**

If this bit is set, then this platform supports changing the attributes of a PCI memory range so that the memory range is accessed in a write combining mode. By default, PCI memory ranges are not accessed in a write combining mode.

**EFI\_PCI\_ATTRIBUTE\_MEMORY\_CACHED**

If this bit is set, then this platform supports changing the attributes of a PCI memory range so that the memory range is accessed in a cached mode. By default, PCI memory ranges are accessed noncached.

**EFI\_PCI\_ATTRIBUTE\_MEMORY\_DISABLE**

If this bit is set, then this platform supports changing the attributes of a PCI memory range so that the memory range is disabled, and can no longer be accessed. By default, all PCI memory ranges are enabled.

**EFI\_PCI\_ATTRIBUTE\_DUAL\_ADDRESS\_CYCLE**

This bit may only be used in the *Attributes* parameter to [AllocateBuffer\(\)](#). If this bit is set, then the PCI controller that is requesting a buffer through [AllocateBuffer\(\)](#) is capable of producing PCI Dual Address Cycles, so it is able to access a 64-bit address space. If this bit is not set, then the PCI controller that is requesting a buffer through



**AllocateBuffer()** is not capable of producing PCI Dual Address Cycles, so it is only able to access a 32-bit address space.

```

//*****
// EFI_PCI_ROOT_BRIDGE_IO_PROTOCOL_OPERATION
//*****
typedef enum {
  EfiPciOperationBusMasterRead,
  EfiPciOperationBusMasterWrite,
  EfiPciOperationBusMasterCommonBuffer,
  EfiPciOperationBusMasterRead64,
  EfiPciOperationBusMasterWrite64,
  EfiPciOperationBusMasterCommonBuffer64,
  EfiPciOperationMaximum
} EFI_PCI_ROOT_BRIDGE_IO_PROTOCOL_OPERATION;

```

#### **EfiPciOperationBusMasterRead**

A read operation from system memory by a bus master that is not capable of producing PCI dual address cycles.

#### **EfiPciOperationBusMasterWrite**

A write operation to system memory by a bus master that is not capable of producing PCI dual address cycles.

#### **EfiPciOperationBusMasterCommonBuffer**

Provides both read and write access to system memory by both the processor and a bus master that is not capable of producing PCI dual address cycles. The buffer is coherent from both the processor's and the bus master's point of view.

#### **EfiPciOperationBusMasterRead64**

A read operation from system memory by a bus master that is capable of producing PCI dual address cycles.

#### **EfiPciOperationBusMasterWrite64**

A write operation to system memory by a bus master that is capable of producing PCI dual address cycles.

#### **EfiPciOperationBusMasterCommonBuffer64**

Provides both read and write access to system memory by both the processor and a bus master that is capable of producing PCI dual address cycles. The buffer is coherent from both the processor's and the bus master's point of view.

## Description

The **EFI\_PCI\_ROOT\_BRIDGE\_IO\_PROTOCOL** provides the basic Memory, I/O, PCI configuration, and DMA interfaces that are used to abstract accesses to PCI controllers. There is one **EFI\_PCI\_ROOT\_BRIDGE\_IO\_PROTOCOL** instance for each PCI root bridge in

a system. Embedded systems, desktops, and workstations will typically only have one PCI root bridge. High-end servers may have multiple PCI root bridges. A device driver that wishes to manage a PCI bus in a system will have to retrieve the **EFI\_PCI\_ROOT\_BRIDGE\_IO\_PROTOCOL** instance that is associated with the PCI bus to be managed. A device handle for a PCI Root Bridge will minimally contain an **EFI\_DEVICE\_PATH\_PROTOCOL** instance and an **EFI\_PCI\_ROOT\_BRIDGE\_IO\_PROTOCOL** instance. The PCI bus driver can look at the **EFI\_DEVICE\_PATH\_PROTOCOL** instances to determine which **EFI\_PCI\_ROOT\_BRIDGE\_IO\_PROTOCOL** instance to use.

Bus mastering PCI controllers can use the DMA services for DMA operations. There are three basic types of bus mastering DMA that is supported by this protocol. These are DMA reads by a bus master, DMA writes by a bus master, and common buffer DMA. The DMA read and write operations may need to be broken into smaller chunks. The caller of **Map()** must pay attention to the number of bytes that were mapped, and if required, loop until the entire buffer has been transferred. The following is a list of the different bus mastering DMA operations that are supported, and the sequence of **EFI\_PCI\_ROOT\_BRIDGE\_IO\_PROTOCOL** APIs that are used for each DMA operation type. See “Related Definitions” above for the definition of the different DMA operation types.

#### DMA Bus Master Read Operation

- Call **Map()** for **EfiPciOperationBusMasterRead** or **EfiPciOperationBusMasterRead64**.
- Program the DMA Bus Master with the *DeviceAddress* returned by **Map()**.
- Start the DMA Bus Master.
- Wait for DMA Bus Master to complete the read operation.
- Call **Unmap()**.

#### DMA Bus Master Write Operation

- Call **Map()** for **EfiPciOperationBusMasterWrite** or **EfiPciOperationBusMasterRead64**.
- Program the DMA Bus Master with the *DeviceAddress* returned by **Map()**.
- Start the DMA Bus Master.
- Wait for DMA Bus Master to complete the write operation.
- Perform a PCI controller specific read transaction to flush all PCI write buffers (See *PCI Specification* Section 3.2.5.2) .
- Call **Flush()**.
- Call **Unmap()**.

#### DMA Bus Master Common Buffer Operation

- Call **AllocateBuffer()** to allocate a common buffer.
- Call **Map()** for **EfiPciOperationBusMasterCommonBuffer** or **EfiPciOperationBusMasterCommonBuffer64**.
- Program the DMA Bus Master with the *DeviceAddress* returned by **Map()**.
- The common buffer can now be accessed equally by the processor and the DMA bus master.

- Call **Unmap()**.
- Call [FreeBuffer\(\)](#).

## EFI\_PCI\_ROOT\_BRIDGE\_IO\_PROTOCOL.PollMem()

### Summary

Reads from the memory space of a PCI Root Bridge. Returns when either the polling exit criteria is satisfied or after a defined duration.

### Prototype

```
typedef
EFI_STATUS
(EFIAPI *EFI_PCI_ROOT_BRIDGE_IO_PROTOCOL_POLL_IO_MEM) (
    IN EFI_PCI_ROOT_BRIDGE_IO_PROTOCOL *This,
    IN EFI_PCI_ROOT_BRIDGE_IO_PROTOCOL_WIDTH Width,
    IN UINT64 Address,
    IN UINT64 Mask,
    IN UINT64 Value,
    IN UINT64 Delay,
    OUT UINT64 *Result
);
```

### Parameters

<i>This</i>	A pointer to the <a href="#">EFI PCI ROOT BRIDGE IO PROTOCOL</a> . Type <code>EFI_PCI_ROOT_BRIDGE_IO_PROTOCOL</code> is defined in <a href="#">Section 14.2</a> .
<i>Width</i>	Signifies the width of the memory operations. Type <a href="#">EFI PCI ROOT BRIDGE IO PROTOCOL WIDTH</a> is defined in <a href="#">Section 14.2</a> .
<i>Address</i>	The base address of the memory operations. The caller is responsible for aligning <i>Address</i> if required.
<i>Mask</i>	Mask used for the polling criteria. Bytes above <i>Width</i> in <i>Mask</i> are ignored. The bits in the bytes below <i>Width</i> which are zero in <i>Mask</i> are ignored when polling the memory address.
<i>Value</i>	The comparison value used for the polling exit criteria.
<i>Delay</i>	The number of 100 ns units to poll. Note that timer available may be of poorer granularity.
<i>Result</i>	Pointer to the last value read from the memory location.

### Description

This function provides a standard way to poll a PCI memory location. A PCI memory read operation is performed at the PCI memory address specified by *Address* for the width specified by *Width*. The result of this PCI memory read operation is stored in *Result*. This PCI memory read operation is repeated until either a timeout of *Delay* 100 ns units has expired, or  $(Result \& Mask)$  is equal to *Value*.

This function will always perform at least one PCI memory read access no matter how small *Delay* may be. If *Delay* is zero, then *Result* will be returned with a status of

**EFI\_SUCCESS** even if *Result* does not match the exit criteria. If *Delay* expires, then **EFI\_TIMEOUT** is returned.

If *Width* is not **EfiPciWidthUint8**, **EfiPciWidthUint16**, **EfiPciWidthUint32**, or **EfiPciWidthUint64**, then **EFI\_INVALID\_PARAMETER** is returned.

The memory operations are carried out exactly as requested. The caller is responsible for satisfying any alignment and memory width restrictions that a PCI Root Bridge on a platform might require. For example on some platforms, width requests of **EfiPciWidthUint64** are not supported.

All the PCI transactions generated by this function are guaranteed to be completed before this function returns. However, if the memory mapped I/O region being accessed by this function has the **EFI\_PCI\_ATTRIBUTE\_MEMORY\_CACHED** attribute set, then the transactions will follow the ordering rules defined by the processor architecture.

### Status Codes Returned

EFI_SUCCESS	The last data returned from the access matched the poll exit criteria.
EFI_INVALID_PARAMETER	<i>Width</i> is invalid.
EFI_INVALID_PARAMETER	<i>Result</i> is <b>NULL</b> .
EFI_TIMEOUT	<i>Delay</i> expired before a match occurred.
EFI_OUT_OF_RESOURCES	The request could not be completed due to a lack of resources.

## EFI\_PCI\_ROOT\_BRIDGE\_IO\_PROTOCOL.PollIo()

### Summary

Reads from the I/O space of a PCI Root Bridge. Returns when either the polling exit criteria is satisfied or after a defined duration.

### Prototype

```
typedef
EFI_STATUS
(EFIAPI *EFI_PCI_ROOT_BRIDGE_IO_PROTOCOL_POLL_IO_MEM) (
    IN EFI_PCI_ROOT_BRIDGE_IO_PROTOCOL *This,
    IN EFI_PCI_ROOT_BRIDGE_IO_PROTOCOL_WIDTH Width,
    IN UINT64 Address,
    IN UINT64 Mask,
    IN UINT64 Value,
    IN UINT64 Delay,
    OUT UINT64 *Result
);
```

### Parameters

<i>This</i>	A pointer to the <a href="#">EFI PCI ROOT BRIDGE IO PROTOCOL</a> . Type <a href="#">EFI_PCI_ROOT_BRIDGE_IO_PROTOCOL</a> is defined in <a href="#">Section 14.2</a> .
<i>Width</i>	Signifies the width of the I/O operations. Type <a href="#">EFI_PCI_ROOT_BRIDGE_IO_PROTOCOL_WIDTH</a> is defined in <a href="#">Section 14.2</a> .
<i>Address</i>	The base address of the I/O operations. The caller is responsible for aligning <i>Address</i> if required.
<i>Mask</i>	Mask used for the polling criteria. Bytes above <i>Width</i> in <i>Mask</i> are ignored. The bits in the bytes below <i>Width</i> which are zero in <i>Mask</i> are ignored when polling the I/O address.
<i>Value</i>	The comparison value used for the polling exit criteria.
<i>Delay</i>	The number of 100 ns units to poll. Note that timer available may be of poorer granularity.
<i>Result</i>	Pointer to the last value read from the memory location.

### Description

This function provides a standard way to poll a PCI I/O location. A PCI I/O read operation is performed at the PCI I/O address specified by *Address* for the width specified by *Width*. The result of this PCI I/O read operation is stored in *Result*. This PCI I/O read operation is repeated until either a timeout of *Delay* 100 ns units has expired, or (*Result & Mask*) is equal to *Value*.

This function will always perform at least one I/O access no matter how small *Delay* may be. If *Delay* is zero, then *Result* will be returned with a status of **EFI\_SUCCESS** even if *Result* does not match the exit criteria. If *Delay* expires, then **EFI\_TIMEOUT** is returned.

If *Width* is not **EfiPciWidthUint8**, **EfiPciWidthUint16**, **EfiPciWidthUint32**, or **EfiPciWidthUint64**, then **EFI\_INVALID\_PARAMETER** is returned.

The I/O operations are carried out exactly as requested. The caller is responsible satisfying any alignment and I/O width restrictions that the PCI Root Bridge on a platform might require. For example on some platforms, width requests of **EfiPciWidthUint64** do not work.

All the PCI transactions generated by this function are guaranteed to be completed before this function returns.

### Status Codes Returned

EFI_SUCCESS	The last data returned from the access matched the poll exit criteria.
EFI_INVALID_PARAMETER	<i>Width</i> is invalid.
EFI_INVALID_PARAMETER	<i>Result</i> is <b>NULL</b> .
EFI_TIMEOUT	<i>Delay</i> expired before a match occurred.
EFI_OUT_OF_RESOURCES	The request could not be completed due to a lack of resources.

## EFI\_PCI\_ROOT\_BRIDGE\_IO\_PROTOCOL.Mem.Read() EFI\_PCI\_ROOT\_BRIDGE\_IO\_PROTOCOL.Mem.Write()

### Summary

Enables a PCI driver to access PCI controller registers in the PCI root bridge memory space.

### Prototype

```
typedef
EFI_STATUS
(EFIAPI *EFI_PCI_ROOT_BRIDGE_IO_PROTOCOL_IO_MEM) (
    IN EFI_PCI_ROOT_BRIDGE_IO_PROTOCOL *This,
    IN EFI_PCI_ROOT_BRIDGE_IO_PROTOCOL_WIDTH Width,
    IN UINT64 Address,
    IN UINTN Count,
    IN OUT VOID *Buffer
);
```

### Parameters

<i>This</i>	A pointer to the <a href="#">EFI_PCI_ROOT_BRIDGE_IO_PROTOCOL</a> . Type <a href="#">EFI_PCI_ROOT_BRIDGE_IO_PROTOCOL</a> is defined in <a href="#">Section 14.2</a> .
<i>Width</i>	Signifies the width of the memory operation. Type <a href="#">EFI_PCI_ROOT_BRIDGE_IO_PROTOCOL_WIDTH</a> is defined in <a href="#">Section 14.2</a> .
<i>Address</i>	The base address of the memory operation. The caller is responsible for aligning the <i>Address</i> if required.
<i>Count</i>	The number of memory operations to perform. Bytes moved is <i>Width</i> size * <i>Count</i> , starting at <i>Address</i> .
<i>Buffer</i>	For read operations, the destination buffer to store the results. For write operations, the source buffer to write data from.

### Description

The **Mem.Read()**, and **Mem.Write()** functions enable a driver to access PCI controller registers in the PCI root bridge memory space.

The memory operations are carried out exactly as requested. The caller is responsible for satisfying any alignment and memory width restrictions that a PCI Root Bridge on a platform might require. For example on some platforms, width requests of **EfiPciWidthUint64** do not work.

If *Width* is **EfiPciWidthUint8**, **EfiPciWidthUint16**, **EfiPciWidthUint32**, or **EfiPciWidthUint64**, then both *Address* and *Buffer* are incremented for each of the *Count* operations performed.



If *Width* is **EfiPciWidthFifoUint8**, **EfiPciWidthFifoUint16**, **EfiPciWidthFifoUint32**, or **EfiPciWidthFifoUint64**, then only *Buffer* is incremented for each of the *Count* operations performed. The read or write operation is performed *Count* times on the same *Address*.

If *Width* is **EfiPciWidthFillUint8**, **EfiPciWidthFillUint16**, **EfiPciWidthFillUint32**, or **EfiPciWidthFillUint64**, then only *Address* is incremented for each of the *Count* operations performed. The read or write operation is performed *Count* times from the first element of *Buffer*.

All the PCI read transactions generated by this function are guaranteed to be completed before this function returns. All the PCI write transactions generated by this function will follow the write ordering and completion rules defined in the *PCI Specification*. However, if the memory-mapped I/O region being accessed by this function has the **EFI\_PCI\_ATTRIBUTE\_MEMORY\_CACHED** attribute set, then the transactions will follow the ordering rules defined by the processor architecture.

### Status Codes Returned

EFI_SUCCESS	The data was read from or written to the PCI root bridge.
EFI_INVALID_PARAMETER	<i>Width</i> is invalid for this PCI root bridge.
EFI_INVALID_PARAMETER	<i>Buffer</i> is <b>NULL</b> .
EFI_OUT_OF_RESOURCES	The request could not be completed due to a lack of resources.

## EFI\_PCI\_ROOT\_BRIDGE\_IO\_PROTOCOL Io.Read() EFI\_PCI\_ROOT\_BRIDGE\_IO\_PROTOCOL Io.Write()

### Summary

Enables a PCI driver to access PCI controller registers in the PCI root bridge I/O space.

### Prototype

```
typedef
EFI_STATUS
(EFI_API *EFI_PCI_ROOT_BRIDGE_IO_PROTOCOL_IO_MEM) (
    IN EFI_PCI_ROOT_BRIDGE_IO_PROTOCOL *This,
    IN EFI_PCI_ROOT_BRIDGE_IO_PROTOCOL_WIDTH Width,
    IN UINT64 Address,
    IN UINTN Count,
    IN OUT VOID *Buffer
);
```

### Parameters

<i>This</i>	A pointer to the <a href="#">EFI PCI ROOT BRIDGE IO PROTOCOL</a> . Type <a href="#">EFI_PCI_ROOT_BRIDGE_IO_PROTOCOL</a> is defined in <a href="#">Section 14.2</a> .
<i>Width</i>	Signifies the width of the memory operations. Type <a href="#">EFI_PCI_ROOT_BRIDGE_IO_PROTOCOL_WIDTH</a> is defined in <a href="#">Section 14.2</a> .
<i>Address</i>	The base address of the I/O operation. The caller is responsible for aligning the <i>Address</i> if required.
<i>Count</i>	The number of I/O operations to perform. Bytes moved is <i>Width</i> size * <i>Count</i> , starting at <i>Address</i> .
<i>Buffer</i>	For read operations, the destination buffer to store the results. For write operations, the source buffer to write data from.

### Description

The **Io.Read()**, and **Io.Write()** functions enable a driver to access PCI controller registers in the PCI root bridge I/O space.

The I/O operations are carried out exactly as requested. The caller is responsible for satisfying any alignment and I/O width restrictions that a PCI root bridge on a platform might require. For example on some platforms, width requests of **EfiPciWidthUint64** do not work.

If *Width* is **EfiPciWidthUint8**, **EfiPciWidthUint16**, **EfiPciWidthUint32**, or **EfiPciWidthUint64**, then both *Address* and *Buffer* are incremented for each of the *Count* operations performed.

If *Width* is **EfiPciWidthFifoUint8**, **EfiPciWidthFifoUint16**, **EfiPciWidthFifoUint32**, or **EfiPciWidthFifoUint64**, then only *Buffer* is incremented for each of the *Count* operations performed. The read or write operation is performed *Count* times on the same *Address*.

If *Width* is **EfiPciWidthFillUint8**, **EfiPciWidthFillUint16**, **EfiPciWidthFillUint32**, or **EfiPciWidthFillUint64**, then only *Address* is incremented for each of the *Count* operations performed. The read or write operation is performed *Count* times from the first element of *Buffer*.

All the PCI transactions generated by this function are guaranteed to be completed before this function returns.

## Status Codes Returned

EFI_SUCCESS	The data was read from or written to the PCI root bridge.
EFI_INVALID_PARAMETER	<i>Width</i> is invalid for this PCI root bridge.
EFI_INVALID_PARAMETER	<i>Buffer</i> is <b>NULL</b> .
EFI_OUT_OF_RESOURCES	The request could not be completed due to a lack of resources.

## EFI\_PCI\_ROOT\_BRIDGE\_IO\_PROTOCOL.Pci.Read() EFI\_PCI\_ROOT\_BRIDGE\_IO\_PROTOCOL.Pci.Write()

### Summary

Enables a PCI driver to access PCI controller registers in a PCI root bridge's configuration space.

### Prototype

```
typedef
EFI_STATUS
(EFI_API *EFI_PCI_ROOT_BRIDGE_IO_PROTOCOL_IO_MEM) (
    IN EFI_PCI_ROOT_BRIDGE_IO_PROTOCOL *This,
    IN EFI_PCI_ROOT_BRIDGE_IO_PROTOCOL_WIDTH Width,
    IN UINT64 Address,
    IN UINTN Count,
    IN OUT VOID *Buffer
);
```

### Parameters

<i>This</i>	A pointer to the <a href="#">EFI_PCI_ROOT_BRIDGE_IO_PROTOCOL</a> . Type <a href="#">EFI_PCI_ROOT_BRIDGE_IO_PROTOCOL</a> is defined in <a href="#">Section 14.2</a> .
<i>Width</i>	Signifies the width of the memory operations. Type <a href="#">EFI_PCI_ROOT_BRIDGE_IO_PROTOCOL_WIDTH</a> is defined in <a href="#">Section 14.2</a> .
<i>Address</i>	The address within the PCI configuration space for the PCI controller. See <a href="#">Table 112</a> for the format of <i>Address</i> .
<i>Count</i>	The number of PCI configuration operations to perform. Bytes moved is <i>Width</i> size * <i>Count</i> , starting at <i>Address</i> .
<i>Buffer</i>	For read operations, the destination buffer to store the results. For write operations, the source buffer to write data from.

### Description

The **Pci.Read()** and **Pci.Write()** functions enable a driver to access PCI configuration registers for a PCI controller.

The PCI Configuration operations are carried out exactly as requested. The caller is responsible for any alignment and PCI configuration width issues that a PCI Root Bridge on a platform might require. For example on some platforms, width requests of **EfiPciWidthUint64** do not work.

If *Width* is **EfiPciWidthUint8**, **EfiPciWidthUint16**, **EfiPciWidthUint32**, or **EfiPciWidthUint64**, then both *Address* and *Buffer* are incremented for each of the *Count* operations performed.

If *Width* is **EfiPciWidthFifoUint8**, **EfiPciWidthFifoUint16**, **EfiPciWidthFifoUint32**, or **EfiPciWidthFifoUint64**, then only *Buffer* is incremented for each of the *Count* operations performed. The read or write operation is performed *Count* times on the same *Address*.

If *Width* is **EfiPciWidthFillUint8**, **EfiPciWidthFillUint16**, **EfiPciWidthFillUint32**, or **EfiPciWidthFillUint64**, then only *Address* is incremented for each of the *Count* operations performed. The read or write operation is performed *Count* times from the first element of *Buffer*.

All the PCI transactions generated by this function are guaranteed to be completed before this function returns.

**Table 112. PCI Configuration Address**

Mnemonic	Byte Offset	Byte Length	Description
Register	0	1	The register number on the PCI Function.
Function	1	1	The PCI Function number on the PCI Device.
Device	2	1	The PCI Device number on the PCI Bus.
Bus	3	1	The PCI Bus number.
ExtendedRegister	4	4	The register number on the PCI Function. If this field is zero, then the Register field is used for the register number. If this field is nonzero, then the Register field is ignored, and the ExtendedRegister field is used for the register number.

## Status Codes Returned

EFI_SUCCESS	The data was read from or written to the PCI root bridge.
EFI_INVALID_PARAMETER	<i>Width</i> is invalid for this PCI root bridge.
EFI_INVALID_PARAMETER	<i>Buffer</i> is <b>NULL</b> .
EFI_OUT_OF_RESOURCES	The request could not be completed due to a lack of resources.

## EFI\_PCI\_ROOT\_BRIDGE\_IO\_PROTOCOL.CopyMem()

### Summary

Enables a PCI driver to copy one region of PCI root bridge memory space to another region of PCI root bridge memory space.

### Prototype

```
typedef
EFI_STATUS
(EFIAPI *EFI_PCI_ROOT_BRIDGE_IO_PROTOCOL_COPY_MEM) (
    IN EFI_PCI_ROOT_BRIDGE_IO_PROTOCOL *This,
    IN EFI_PCI_ROOT_BRIDGE_IO_PROTOCOL_WIDTH Width,
    IN UINT64 DestAddress,
    IN UINT64 SrcAddress,
    IN UINTN Count
);
```

### Parameters

<i>This</i>	A pointer to the <a href="#">EFI_PCI_ROOT_BRIDGE_IO_PROTOCOL</a> instance. Type <a href="#">EFI_PCI_ROOT_BRIDGE_IO_PROTOCOL</a> is defined in <a href="#">Section 14.2</a> .
<i>Width</i>	Signifies the width of the memory operations. Type <a href="#">EFI_PCI_ROOT_BRIDGE_IO_PROTOCOL_WIDTH</a> is defined in <a href="#">Section 14.2</a> .
<i>DestAddress</i>	The destination address of the memory operation. The caller is responsible for aligning the <i>DestAddress</i> if required.
<i>SrcAddress</i>	The source address of the memory operation. The caller is responsible for aligning the <i>SrcAddress</i> if required.
<i>Count</i>	The number of memory operations to perform. Bytes moved is <i>Width</i> size * <i>Count</i> , starting at <i>DestAddress</i> and <i>SrcAddress</i> .

### Description

The **CopyMem()** function enables a PCI driver to copy one region of PCI root bridge memory space to another region of PCI root bridge memory space. This is especially useful for video scroll operation on a memory mapped video buffer.

The memory operations are carried out exactly as requested. The caller is responsible for satisfying any alignment and memory width restrictions that a PCI root bridge on a platform might require. For example on some platforms, width requests of **EfiPciWidthUint64** do not work.

If *Width* is **EfiPciIoWidthUint8**, **EfiPciIoWidthUint16**, **EfiPciIoWidthUint32**, or **EfiPciIoWidthUint64**, then *Count* read/write transactions are performed to move the contents of the *SrcAddress* buffer to the *DestAddress* buffer. The implementation must be reentrant, and it must handle overlapping *SrcAddress* and *DestAddress* buffers. This

means that the implementation of **CopyMem()** must choose the correct direction of the copy operation based on the type of overlap that exists between the *SrcAddress* and *DestAddress* buffers. If either the *SrcAddress* buffer or the *DestAddress* buffer crosses the top of the processor's address space, then the result of the copy operation is unpredictable.

The contents of the *DestAddress* buffer on exit from this service must match the contents of the *SrcAddress* buffer on entry to this service. Due to potential overlaps, the contents of the *SrcAddress* buffer may be modified by this service. The following rules can be used to guarantee the correct behavior:

- If  $DestAddress > SrcAddress$  and  $DestAddress < (SrcAddress + Width\ size * Count)$ , then the data should be copied from the *SrcAddress* buffer to the *DestAddress* buffer starting from the end of buffers and working toward the beginning of the buffers.
- Otherwise, the data should be copied from the *SrcAddress* buffer to the *DestAddress* buffer starting from the beginning of the buffers and working toward the end of the buffers.

All the PCI transactions generated by this function are guaranteed to be completed before this function returns. All the PCI write transactions generated by this function will follow the write ordering and completion rules defined in the *PCI Specification*. However, if the memory-mapped I/O region being accessed by this function has the **EFI\_PCI\_ATTRIBUTE\_MEMORY\_CACHED** attribute set, then the transactions will follow the ordering rules defined by the processor architecture.

## Status Codes Returned

EFI_SUCCESS	The data was copied from one memory region to another memory region.
EFI_INVALID_PARAMETER	<i>Width</i> is invalid for this PCI root bridge.
EFI_OUT_OF_RESOURCES	The request could not be completed due to a lack of resources.

## EFI\_PCI\_ROOT\_BRIDGE\_IO\_PROTOCOL.Map()

### Summary

Provides the PCI controller-specific addresses required to access system memory from a DMA bus master.

### Prototype

```
typedef
EFI_STATUS
(EFIAPI *EFI_PCI_ROOT_BRIDGE_IO_PROTOCOL_MAP) (
    IN EFI_PCI_ROOT_BRIDGE_IO_PROTOCOL *This,
    IN EFI_PCI_ROOT_BRIDGE_IO_PROTOCOL_OPERATION Operation,
    IN VOID *HostAddress,
    IN OUT UINTN *NumberOfBytes,
    OUT EFI_PHYSICAL_ADDRESS *DeviceAddress,
    OUT VOID **Mapping
);
```

### Parameters

<i>This</i>	A pointer to the <a href="#">EFI_PCI_ROOT_BRIDGE_IO_PROTOCOL</a> . Type <a href="#">EFI_PCI_ROOT_BRIDGE_IO_PROTOCOL</a> is defined in <a href="#">Section 14.2</a> .
<i>Operation</i>	Indicates if the bus master is going to read or write to system memory. Type <a href="#">EFI_PCI_ROOT_BRIDGE_IO_PROTOCOL_OPERATION</a> is defined in <a href="#">Section 14.2</a> .
<i>HostAddress</i>	The system memory address to map to the PCI controller.
<i>NumberOfBytes</i>	On input the number of bytes to map. On output the number of bytes that were mapped.
<i>DeviceAddress</i>	The resulting map address for the bus master PCI controller to use to access the system memory's <i>HostAddress</i> . Type <a href="#">EFI_PHYSICAL_ADDRESS</a> is defined in <a href="#">EFI_BOOT_SERVICES.AllocatePages()</a> . This address cannot be used by the processor to access the contents of the buffer specified by <i>HostAddress</i> .
<i>Mapping</i>	The value to pass to <a href="#">Unmap()</a> when the bus master DMA operation is complete.

### Description

The **Map()** function provides the PCI controller specific addresses needed to access system memory. This function is used to map system memory for PCI bus master DMA accesses.

All PCI bus master accesses must be performed through their mapped addresses and such mappings must be freed with [Unmap\(\)](#) when complete. If the bus master access is a single read or single write data transfer, then **EfiPciOperationBusMasterRead**,



**EfiPciOperationBusMasterRead64**, **EfiPciOperationBusMasterWrite**, or **EfiPciOperationBusMasterWrite64** is used and the range is unmapped to complete the operation. If performing an **EfiPciOperationBusMasterRead** or **EfiPciOperationBusMasterRead64** operation, all the data must be present in system memory before **Map()** is performed. Similarly, if performing an **EfiPciOperationBusMasterWrite** or **EfiPciOperationBusMasterWrite64** the data cannot be properly accessed in system memory until **Unmap()** is performed.

Bus master operations that require both read and write access or require multiple host device interactions within the same mapped region must use **EfiPciOperationBusMasterCommonBuffer** or **EfiPciOperationBusMasterCommonBuffer64**. However, only memory allocated via the **AllocateBuffer()** interface can be mapped for this type of operation.

In all mapping requests the resulting *NumberOfBytes* actually mapped may be less than the requested amount. In this case, the DMA operation will have to be broken up into smaller chunks. The **Map()** function will map as much of the DMA operation as it can at one time. The caller may have to loop on **Map()** and **Unmap()** in order to complete a large DMA transfer.

## Status Codes Returned

EFI_SUCCESS	The range was mapped for the returned <i>NumberOfBytes</i> .
EFI_INVALID_PARAMETER	<i>Operation</i> is invalid.
EFI_INVALID_PARAMETER	<i>HostAddress</i> is <b>NULL</b> .
EFI_INVALID_PARAMETER	<i>NumberOfBytes</i> is <b>NULL</b> .
EFI_INVALID_PARAMETER	<i>DeviceAddress</i> is <b>NULL</b> .
EFI_INVALID_PARAMETER	<i>Mapping</i> is <b>NULL</b> .
EFI_UNSUPPORTED	The <i>HostAddress</i> cannot be mapped as a common buffer.
EFI_DEVICE_ERROR	The system hardware could not map the requested address.
EFI_OUT_OF_RESOURCES	The request could not be completed due to a lack of resources.

## EFI\_PCI\_ROOT\_BRIDGE\_IO\_PROTOCOL.Unmap()

### Summary

Completes the [Map\(\)](#) operation and releases any corresponding resources.

### Prototype

```
typedef
EFI_STATUS
(EFIAPI *EFI_PCI_ROOT_BRIDGE_IO_PROTOCOL_UNMAP) (
    IN EFI_PCI_ROOT_BRIDGE_IO_PROTOCOL *This,
    IN VOID *Mapping
);
```

### Parameters

<i>This</i>	A pointer to the <a href="#">EFI PCI ROOT BRIDGE IO PROTOCOL</a> . Type <a href="#">EFI_PCI_ROOT_BRIDGE_IO_PROTOCOL</a> is defined in <a href="#">Section 14.2</a> .
<i>Mapping</i>	The mapping value returned from <a href="#">Map()</a> .

### Description

The [Unmap\(\)](#) function completes the [Map\(\)](#) operation and releases any corresponding resources. If the operation was an [EfiPciOperationBusMasterWrite](#) or [EfiPciOperationBusMasterWrite64](#), the data is committed to the target system memory. Any resources used for the mapping are freed.

### Status Codes Returned

EFI_SUCCESS	The range was unmapped.
EFI_INVALID_PARAMETER	<i>Mapping</i> is not a value that was returned by <a href="#">Map()</a> .
EFI_DEVICE_ERROR	The data was not committed to the target system memory.

## EFI\_PCI\_ROOT\_BRIDGE\_IO\_PROTOCOL.AllocateBuffer()

### Summary

Allocates pages that are suitable for an **EfiPciOperationBusMasterCommonBuffer** or **EfiPciOperationBusMasterCommonBuffer64** mapping.

### Prototype

```
typedef
EFI_STATUS
(EFIAPI *EFI_PCI_ROOT_BRIDGE_IO_PROTOCOL_ALLOCATE_BUFFER) (
  IN EFI_PCI_ROOT_BRIDGE_IO_PROTOCOL *This,
  IN EFI_ALLOCATE_TYPE      Type,
  IN EFI_MEMORY_TYPE      MemoryType,
  IN UINTN      Pages,
  OUT VOID      **HostAddress,
  IN UINT64     Attributes
);
```

### Parameters

<i>This</i>	A pointer to the <a href="#">EFI_PCI_ROOT_BRIDGE_IO_PROTOCOL</a> . Type <b>EFI_PCI_ROOT_BRIDGE_IO_PROTOCOL</b> is defined in <a href="#">Section 14.2.1</a> .
<i>Type</i>	This parameter is not used and must be ignored.
<i>MemoryType</i>	The type of memory to allocate, <b>EfiBootServicesData</b> or <b>EfiRuntimeServicesData</b> . Type <a href="#">EFI_MEMORY_TYPE</a> is defined in <a href="#">EFI_BOOT_SERVICES.AllocatePages()</a> .
<i>Pages</i>	The number of pages to allocate.
<i>HostAddress</i>	A pointer to store the base system memory address of the allocated range.
<i>Attributes</i>	The requested bit mask of attributes for the allocated range. Only the attributes <b>EFI_PCI_ATTRIBUTE_MEMORY_WRITE_COMBINE</b> , <b>EFI_PCI_ATTRIBUTE_MEMORY_CACHED</b> , and <b>EFI_PCI_ATTRIBUTE_DUAL_ADDRESS_CYCLE</b> may be used with this function. If any other bits are set, then <b>EFI_UNSUPPORTED</b> is returned. This function may choose to ignore this bit mask. The <b>EFI_PCI_ATTRIBUTE_MEMORY_WRITE_COMBINE</b> , and <b>EFI_PCI_ATTRIBUTE_MEMORY_CACHED</b> attributes provide a hint to the implementation that may improve the performance of the calling driver. The implementation may choose any default for the memory attributes including write combining, cached, both, or neither as long as the allocated buffer can be seen equally by both the processor and the PCI bus master.

## Description

The **AllocateBuffer()** function allocates pages that are suitable for an **EfiPciOperationBusMasterCommonBuffer** or **EfiPciOperationBusMasterCommonBuffer64** mapping. This means that the buffer allocated by this function must support simultaneous access by both the processor and a PCI Bus Master. The device address that the PCI Bus Master uses to access the buffer can be retrieved with a call to **Map()**.

If the **EFI\_PCI\_ATTRIBUTE\_DUAL\_ADDRESS\_CYCLE** bit of *Attributes* is set, then when the buffer allocated by this function is mapped with a call to **Map()**, the device address that is returned by **Map()** must be within the 64-bit device address space of the PCI Bus Master.

If the **EFI\_PCI\_ATTRIBUTE\_DUAL\_ADDRESS\_CYCLE** bit of *Attributes* is clear, then when the buffer allocated by this function is mapped with a call to **Map()**, the device address that is returned by **Map()** must be within the 32-bit device address space of the PCI Bus Master.

If the memory allocation specified by *MemoryType* and *Pages* cannot be satisfied, then **EFI\_OUT\_OF\_RESOURCES** is returned.

## Status Codes Returned

EFI_SUCCESS	The requested memory pages were allocated.
EFI_INVALID_PARAMETER	<i>MemoryType</i> is invalid.
EFI_INVALID_PARAMETER	<i>HostAddress</i> is <b>NULL</b> .
EFI_UNSUPPORTED	<i>Attributes</i> is unsupported. The only legal attribute bits are <b>EFI_PCI_ATTRIBUTE_MEMORY_WRITE_COMBINE</b> , <b>EFI_PCI_ATTRIBUTE_MEMORY_CACHED</b> , and <b>EFI_PCI_ATTRIBUTE_DUAL_ADDRESS_CYCLE</b> .
EFI_OUT_OF_RESOURCES	The memory pages could not be allocated.

## EFI\_PCI\_ROOT\_BRIDGE\_IO\_PROTOCOL.FreeBuffer()

### Summary

Frees memory that was allocated with [AllocateBuffer\(\)](#).

### Prototype

```
typedef
EFI_STATUS
(EFI_API *EFI_PCI_ROOT_BRIDGE_IO_PROTOCOL_FREE_BUFFER) (
  IN EFI_PCI_ROOT_BRIDGE_IO_PROTOCOL *This,
  IN UINTN          Pages,
  IN VOID          *HostAddress
);
```

### Parameters

<i>This</i>	A pointer to the <a href="#">EFI_PCI_ROOT_BRIDGE_IO_PROTOCOL</a> . Type <a href="#">EFI_PCI_ROOT_BRIDGE_IO_PROTOCOL</a> is defined in <a href="#">Section 14.2</a> .
<i>Pages</i>	The number of pages to free.
<i>HostAddress</i>	The base system memory address of the allocated range.

### Description

The [FreeBuffer\(\)](#) function frees memory that was allocated with [AllocateBuffer\(\)](#).

### Status Codes Returned

EFI_SUCCESS	The requested memory pages were freed.
EFI_INVALID_PARAMETER	The memory range specified by <i>HostAddress</i> and <i>Pages</i> was not allocated with <a href="#">AllocateBuffer()</a> .

## EFI\_PCI\_ROOT\_BRIDGE\_IO\_PROTOCOL.Flush()

### Summary

Flushes all PCI posted write transactions from a PCI host bridge to system memory.

### Prototype

```
typedef
EFI_STATUS
(EFIAPI *EFI_PCI_ROOT_BRIDGE_IO_PROTOCOL_FLUSH) (
    IN EFI_PCI_ROOT_BRIDGE_IO_PROTOCOL *This
);
```

### Parameters

*This*

A pointer to the [EFI\\_PCI\\_ROOT\\_BRIDGE\\_IO\\_PROTOCOL](#). Type [EFI\\_PCI\\_ROOT\\_BRIDGE\\_IO\\_PROTOCOL](#) is defined in [Section 14.2.1](#).

### Description

The **Flush()** function flushes any PCI posted write transactions from a PCI host bridge to system memory. Posted write transactions are generated by PCI bus masters when they perform write transactions to target addresses in system memory.

This function does not flush posted write transactions from any PCI bridges. A PCI controller specific action must be taken to guarantee that the posted write transactions have been flushed from the PCI controller and from all the PCI bridges into the PCI host bridge. This is typically done with a PCI read transaction from the PCI controller prior to calling **Flush()**.

If the PCI controller specific action required to flush the PCI posted write transactions has been performed, and this function returns **EFI\_SUCCESS**, then the PCI bus master's view and the processor's view of system memory are guaranteed to be coherent. If the PCI posted write transactions cannot be flushed from the PCI host bridge, then the PCI bus master and processor are not guaranteed to have a coherent view of system memory, and **EFI\_DEVICE\_ERROR** is returned.

### Status Codes Returned

EFI_SUCCESS	The PCI posted write transactions were flushed from the PCI host bridge to system memory.
EFI_DEVICE_ERROR	The PCI posted write transactions were not flushed from the PCI host bridge due to a hardware error.

## EFI\_PCI\_ROOT\_BRIDGE\_IO\_PROTOCOL.GetAttributes()

### Summary

Gets the attributes that a PCI root bridge supports setting with [SetAttributes\(\)](#), and the attributes that a PCI root bridge is currently using.

### Prototype

```
typedef
EFI_STATUS
(EFI_API *EFI_PCI_ROOT_BRIDGE_IO_PROTOCOL_GET_ATTRIBUTES) (
    IN EFI_PCI_ROOT_BRIDGE_IO_PROTOCOL *This,
    OUT UINT64 *Supports OPTIONAL,
    OUT UINT64 *Attributes OPTIONAL
);
```

### Parameters

<i>This</i>	A pointer to the <a href="#">EFI_PCI_ROOT_BRIDGE_IO_PROTOCOL</a> . Type <a href="#">EFI_PCI_ROOT_BRIDGE_IO_PROTOCOL</a> is defined in <a href="#">Section 14.2</a> .
<i>Supports</i>	A pointer to the mask of attributes that this PCI root bridge supports setting with <a href="#">SetAttributes()</a> . The available attributes are listed in <a href="#">Section 14.2</a> . This is an optional parameter that may be <b>NULL</b> .
<i>Attributes</i>	A pointer to the mask of attributes that this PCI root bridge is currently using. The available attributes are listed in <a href="#">Section 14.2</a> . This is an optional parameter that may be <b>NULL</b> .

### Description

The [GetAttributes\(\)](#) function returns the mask of attributes that this PCI root bridge supports and the mask of attributes that the PCI root bridge is currently using. If *Supports* is not **NULL**, then *Supports* is set to the mask of attributes that the PCI root bridge supports. If *Attributes* is not **NULL**, then *Attributes* is set to the mask of attributes that the PCI root bridge is currently using. If both *Supports* and *Attributes* are **NULL**, then **EFI\_INVALID\_PARAMETER** is returned. Otherwise, **EFI\_SUCCESS** is returned.

If a bit is set in *Supports*, then the PCI root bridge supports this attribute type, and a call can be made to [SetAttributes\(\)](#) using that attribute type. If a bit is set in *Attributes*, then the PCI root bridge is currently using that attribute type. Since a PCI host bus may be composed of more than one PCI root bridge, different *Attributes* values may be returned by different PCI root bridges.

## Status Codes Returned

EFI_SUCCESS	If <i>Supports</i> is not <b>NULL</b> , then the attributes that the PCI root bridge supports is returned in <i>Supports</i> . If <i>Attributes</i> is not <b>NULL</b> , then the attributes that the PCI root bridge is currently using is returned in <i>Attributes</i> .
EFI_INVALID_PARAMETER	Both <i>Supports</i> and <i>Attributes</i> are <b>NULL</b> .



## EFI\_PCI\_ROOT\_BRIDGE\_IO\_PROTOCOL.SetAttributes()

### Summary

Sets attributes for a resource range on a PCI root bridge.

### Prototype

```
typedef
EFI_STATUS
(EFIAPI *EFI_PCI_ROOT_BRIDGE_IO_PROTOCOL_SET_ATTRIBUTES) (
  IN EFI_PCI_ROOT_BRIDGE_IO_PROTOCOL *This,
  IN UINT64      Attributes,
  IN OUT UINT64  *ResourceBase OPTIONAL,
  IN OUT UINT64  *ResourceLength OPTIONAL
);
```

### Parameters

<i>This</i>	A pointer to the <a href="#">EFI_PCI_ROOT_BRIDGE_IO_PROTOCOL</a> . Type <a href="#">EFI_PCI_ROOT_BRIDGE_IO_PROTOCOL</a> is defined in <a href="#">Section 14.2</a> .
<i>Attributes</i>	The mask of attributes to set. If the attribute bit <a href="#">MEMORY_WRITE_COMBINE</a> , <a href="#">MEMORY_CACHED</a> , or <a href="#">MEMORY_DISABLE</a> is set, then the resource range is specified by <i>ResourceBase</i> and <i>ResourceLength</i> . If <a href="#">MEMORY_WRITE_COMBINE</a> , <a href="#">MEMORY_CACHED</a> , and <a href="#">MEMORY_DISABLE</a> are not set, then <i>ResourceBase</i> and <i>ResourceLength</i> are ignored, and may be <b>NULL</b> . The available attributes are listed in <a href="#">Section 14.2</a> .
<i>ResourceBase</i>	A pointer to the base address of the resource range to be modified by the attributes specified by <i>Attributes</i> . On return, <i>*ResourceBase</i> will be set the actual base address of the resource range. Not all resources can be set to a byte boundary, so the actual base address may differ from the one passed in by the caller. This parameter is only used if the <a href="#">MEMORY_WRITE_COMBINE</a> bit, the <a href="#">MEMORY_CACHED</a> bit, or the <a href="#">MEMORY_DISABLE</a> bit of <i>Attributes</i> is set. Otherwise, it is ignored, and may be <b>NULL</b> .
<i>ResourceLength</i>	A pointer to the length of the resource range to be modified by the attributes specified by <i>Attributes</i> . On return, <i>*ResourceLength</i> will be set the actual length of the resource range. Not all resources can be set to a byte boundary, so the actual length may differ from the one passed in by the caller. This parameter is only used if the <a href="#">MEMORY_WRITE_COMBINE</a> bit, the <a href="#">MEMORY_CACHED</a> bit, or the <a href="#">MEMORY_DISABLE</a> bit of <i>Attributes</i> is set. Otherwise, it is ignored, and may be <b>NULL</b> .

## Description

The **SetAttributes()** function sets the attributes specified in *Attributes* for the PCI root bridge on the resource range specified by *ResourceBase* and *ResourceLength*. Since the granularity of setting these attributes may vary from resource type to resource type, and from platform to platform, the actual resource range and the one passed in by the caller may differ. As a result, this function may set the attributes specified by *Attributes* on a larger resource range than the caller requested. The actual range is returned in *ResourceBase* and *ResourceLength*. The caller is responsible for verifying that the actual range for which the attributes were set is acceptable.

If the attributes are set on the PCI root bridge, then the actual resource range is returned in *ResourceBase* and *ResourceLength*, and **EFI\_SUCCESS** is returned.

If the attributes specified by *Attributes* are not supported by the PCI root bridge, then **EFI\_UNSUPPORTED** is returned. The set of supported attributes for a PCI root bridge can be found by calling [GetAttributes\(\)](#).

If either *ResourceBase* or *ResourceLength* are **NULL**, and a resource range is required for the attributes specified in *Attributes*, then **EFI\_INVALID\_PARAMETER** is returned.

If more than one resource range is required for the set of attributes specified by *Attributes*, then **EFI\_INVALID\_PARAMETER** is returned.

If there are not enough resources available to set the attributes, then **EFI\_OUT\_OF\_RESOURCES** is returned.

## Status Codes Returned

EFI_SUCCESS	The set of attributes specified by <i>Attributes</i> for the resource range specified by <i>ResourceBase</i> and <i>ResourceLength</i> were set on the PCI root bridge, and the actual resource range is returned in <i>ResourceBase</i> and <i>ResourceLength</i> .
EFI_UNSUPPORTED	A bit is set in <i>Attributes</i> that is not supported by the PCI Root Bridge. The supported attribute bits are reported by <a href="#">GetAttributes()</a> .
EFI_INVALID_PARAMETER	More than one attribute bit is set in <i>Attributes</i> that requires a resource range.
EFI_INVALID_PARAMETER	A resource range is required, and <i>ResourceBase</i> is <b>NULL</b> .
EFI_INVALID_PARAMETER	A resource range is required, and <i>ResourceLength</i> is <b>NULL</b> .
EFI_OUT_OF_RESOURCES	There are not enough resources to set the attributes on the resource range specified by <i>BaseAddress</i> and <i>Length</i> .

## EFI\_PCI\_ROOT\_BRIDGE\_IO\_PROTOCOL.Configuration()

### Summary

Retrieves the current resource settings of this PCI root bridge in the form of a set of ACPI resource descriptors.

### Prototype

```
typedef
EFI_STATUS
(EFI_API *EFI_PCI_ROOT_BRIDGE_IO_PROTOCOL_CONFIGURATION) (
    IN EFI_PCI_ROOT_BRIDGE_IO_PROTOCOL *This,
    OUT VOID **Resources
);
```

### Parameters

*This*

A pointer to the [EFI\\_PCI\\_ROOT\\_BRIDGE\\_IO\\_PROTOCOL](#). Type [EFI\\_PCI\\_ROOT\\_BRIDGE\\_IO\\_PROTOCOL](#) is defined in [Section 14.2](#).

*Resources*

A pointer to the resource descriptors that describe the current configuration of this PCI root bridge. The storage for the resource descriptors is allocated by this function. The caller must treat the return buffer as read-only data, and the buffer must not be freed by the caller. See “Related Definitions” for the resource descriptors that may be used.

### Related Definitions

There are only two resource descriptor types from the ACPI Specification that may be used to describe the current resources allocated to a PCI root bridge. These are the QWORD Address Space Descriptor, and the End Tag. The QWORD Address Space Descriptor can describe memory, I/O, and bus number ranges for dynamic or fixed resources. The configuration of a PCI root bridge is described with one or more QWORD Address Space Descriptors followed by an End Tag. [Table 114](#) and [Table 113](#) contain these two descriptor types.

Please see the ACPI Specification for details on the field values. The definition of the Address Space Granularity field in the QWORD Address Space Descriptor differs from the ACPI Specification, and the definition in [Table 113](#) is the one that must be used.

**Table 113. QWORD Address Space Descriptor**

Byte Offset	Byte Length	Data	Description
0x00	0x01	0x8A	QWORD Address Space Descriptor
0x01	0x02	0x2B	Length of this descriptor in bytes not including the first two fields
0x03	0x01		Resource Type 0 – Memory Range 1 – I/O Range 2 – Bus Number Range
0x04	0x01		General Flags
0x05	0x01		Type Specific Flags
0x06	0x08		Address Space Granularity. Used to differentiate between a 32-bit memory request and a 64-bit memory request. For a 32-bit memory request, this field should be set to 32. For a 64-bit memory request, this field should be set to 64.
0x0E	0x08		Address Range Minimum
0x16	0x08		Address Range Maximum
0x1E	0x08		Address Translation Offset. Offset to apply to the Starting address to convert it to a PCI address. This value is zero unless the HostAddress and DeviceAddress for the root bridge are different.
0x26	0x08		Address Length

**Table 114. End Tag**

Byte Offset	Byte Length	Data	Description
0x00	0x01	0x79	End Tag
0x01	0x01	0x00	Checksum. If 0, then checksum is assumed to be valid.

### Description

The **Configuration()** function retrieves a set of resource descriptors that contains the current configuration of this PCI root bridge. If the current configuration can be retrieved, then it is returned in *Resources* and **EFI\_SUCCESS** is returned. See “Related Definitions” below for the resource descriptor types that are supported by this function. If the current configuration cannot be retrieved, then **EFI\_UNSUPPORTED** is returned.

## Status Codes Returned

EFI_SUCCESS	The current configuration of this PCI root bridge was returned in <i>Resources</i> .
EFI_UNSUPPORTED	The current configuration of this PCI root bridge could not be retrieved.

### 14.2.1 PCI Root Bridge Device Paths

An [EFI\\_PCI\\_ROOT\\_BRIDGE\\_IO\\_PROTOCOL](#) must be installed on a handle for its services to be available to drivers. In addition to the [EFI\\_PCI\\_ROOT\\_BRIDGE\\_IO\\_PROTOCOL](#), an [EFI\\_DEVICE\\_PATH\\_PROTOCOL](#) must also be installed on the same handle.

Typically, an ACPI Device Path Node is used to describe a PCI Root Bridge. Depending on the bus hierarchy in the system, additional device path nodes may precede this ACPI Device Path Node. A desktop system will typically contain only one PCI Root Bridge, so there would be one handle with a [EFI\\_PCI\\_ROOT\\_BRIDGE\\_IO\\_PROTOCOL](#) and an [EFI\\_DEVICE\\_PATH\\_PROTOCOL](#). A server system may contain multiple PCI Root Bridges, so it would contain a handle for each PCI Root Bridge present, and on each of those handles would be an [EFI\\_PCI\\_ROOT\\_BRIDGE\\_IO\\_PROTOCOL](#) and an [EFI\\_DEVICE\\_PATH\\_PROTOCOL](#). In all cases, the contents of the ACPI Device Path Nodes for PCI Root Bridges must match the information present in the ACPI tables for that system.

[Table 115](#) shows an example device path for a PCI Root Bridge in a desktop system. Today, a desktop system typically contains one PCI Root Bridge. This device path consists of an ACPI Device Path Node, and a Device Path End Structure. The `_HID` and `_UID` must match the ACPI table description of the PCI Root Bridge. For a system with only one PCI Root Bridge, the `_UID` value is usually `0x0000`. The shorthand notation for this device path is [ACPI\(PNP0A03,0\)](#).

**Table 115. PCI Root Bridge Device Path for a Desktop System**

Byte Offset	Byte Length	Data	Description
0x00	0x01	0x02	Generic Device Path Header – Type ACPI Device Path
0x01	0x01	0x01	Sub type – ACPI Device Path
0x02	0x02	0x0C	Length – 0x0C bytes
0x04	0x04	0x41D0, 0x0A03	<code>_HID PNP0A03</code> – 0x41D0 represents the compressed string ‘PNP’ and is encoded in the low order bytes. The compression method is described in the ACPI Specification.
0x08	0x04	0x0000	<code>_UID</code>
0x0C	0x01	0xFF	<b>Generic Device Path Header</b> – Type End of Hardware Device Path
0x0D	0x01	0xFF	Sub type – End of Entire Device Path
0x0E	0x02	0x04	Length – 0x04 bytes

[Table 116](#) through [Table 119](#) show example device paths for the PCI Root Bridges in a server system with four PCI Root Bridges. Each of these device paths consists of an ACPI

Device Path Node, and a Device Path End Structure. The `_HID` and `_UID` must match the ACPI table description of the PCI Root Bridges. The only difference between each of these device paths is the `_UID` field. The shorthand notation for these four device paths is **`ACPI(PNP0A03,0)`**, **`ACPI(PNP0A03,1)`**, **`ACPI(PNP0A03,2)`**, and **`ACPI(PNP0A03,3)`**.

**Table 116. PCI Root Bridge Device Path for Bridge #0 in a Server System**

Byte Offset	Byte Length	Data	Description
0x00	0x01	0x02	Generic Device Path Header – Type ACPI Device Path
0x01	0x01	0x01	Sub type – ACPI Device Path
0x02	0x02	0x0C	Length – 0x0C bytes
0x04	0x04	0x41D0, 0x0A03	_HID PNPOA03 – 0x41D0 represents the compressed string 'PNP' and is encoded in the low order bytes. The compression method is described in the ACPI Specification.
0x08	0x04	0x0000	_UID
0x0C	0x01	0xFF	<b>Generic Device Path Header</b> – Type End of Hardware Device Path
0x0D	0x01	0xFF	Sub type – End of Entire Device Path
0x0E	0x02	0x04	Length – 0x04 bytes

**Table 117. PCI Root Bridge Device Path for Bridge #1 in a Server System**

Byte Offset	Byte Length	Data	Description
0x00	0x01	0x02	Generic Device Path Header – Type ACPI Device Path
0x01	0x01	0x01	Sub type – ACPI Device Path
0x02	0x02	0x0C	Length – 0x0C bytes
0x04	0x04	0x41D0, 0x0A03	_HID PNPOA03 – 0x41D0 represents the compressed string 'PNP' and is encoded in the low order bytes. The compression method is described in the ACPI Specification.
0x08	0x04	0x0001	_UID
0x0C	0x01	0xFF	<b>Generic Device Path Header</b> – Type End of Hardware Device Path
0x0D	0x01	0xFF	Sub type – End of Entire Device Path
0x0E	0x02	0x04	Length – 0x04 bytes

**Table 118. PCI Root Bridge Device Path for Bridge #2 in a Server System**

Byte Offset	Byte Length	Data	Description
0x00	0x01	0x02	Generic Device Path Header – Type ACPI Device Path
0x01	0x01	0x01	Sub type – ACPI Device Path
0x02	0x02	0x0C	Length – 0x0C bytes
0x04	0x04	0x41D0, 0x0A03	_HID PNPOA03 – 0x41D0 represents the compressed string 'PNP' and is encoded in the low order bytes. The compression method is described in the ACPI Specification.
0x08	0x04	0x0002	_UID
0x0C	0x01	0xFF	<b>Generic Device Path Header</b> – Type End of Hardware Device Path
0x0D	0x01	0xFF	Sub type – End of Entire Device Path
0x0E	0x02	0x04	Length – 0x04 bytes

**Table 119. PCI Root Bridge Device Path for Bridge #3 in a Server System**

Byte Offset	Byte Length	Data	Description
0x00	0x01	0x02	Generic Device Path Header – Type ACPI Device Path
0x01	0x01	0x01	Sub type – ACPI Device Path
0x02	0x02	0x0C	Length – 0x0C bytes
0x04	0x04	0x41D0, 0x0A03	_HID PNP0A03 – 0x41D0 represents the compressed string ‘PNP’ and is encoded in the low order bytes. The compression method is described in the ACPI Specification.
0x08	0x04	0x0003	_UID
0x0C	0x01	0xFF	<b>Generic Device Path Header</b> – Type End of Hardware Device Path
0x0D	0x01	0xFF	Sub type – End of Entire Device Path
0x0E	0x02	0x04	Length – 0x04 bytes

[Table 120](#) shows an example device path for a PCI Root Bridge using an Expanded ACPI Device Path. This device path consists of an Expanded ACPI Device Path Node, and a Device Path End Structure. The \_UID and \_CID fields must match the ACPI table description of the PCI Root Bridge. For a system with only one PCI Root Bridge, the \_UID value is usually 0x0000. The shorthand notation for this device path is **ACPI(12345678,0,PNP0A03)**.

**Table 120. PCI Root Bridge Device Path Using Expanded ACPI Device Path**

Byte Offset	Byte Length	Data	Description
0x00	0x01	0x02	Generic Device Path Header – Type ACPI Device Path
0x01	0x01	0x02	Sub type – Expanded ACPI Device Path
0x02	0x02	0x10	Length – 0x10 bytes
0x04	0x04	0x1234, 0x5678	_HID-device specific
0x08	0x04	0x0000	_UID
0x0C	0x04	0x41D0, 0x0A03	_CID PNP0A03 – 0x41D0 represents the compressed string ‘PNP’ and is encoded in the low order bytes. The compression method is described in the ACPI Specification.
0x10	0x01	0xFF	Generic Device Path Header – Type End of Hardware Device Path
0x11	0x01	0xFF	Sub type – End of Entire Device Path
0x12	0x02	0x04	Length – 0x04 bytes

### 14.3 PCI Driver Model

[Section 14.3](#) and [Section 14.4](#) describe the PCI Driver Model. This includes the behavior of PCI Bus Drivers, the behavior of a PCI Device Drivers, and a detailed description of the PCI I/O Protocol. The PCI Bus Driver manages PCI buses present in a system, and PCI



Device Drivers manage PCI controllers present on PCI buses. The PCI Device Drivers produce an I/O abstraction that can be used to boot an EFI compliant operating system. This document provides enough material to implement a PCI Bus Driver, and the tools required to design and implement a PCI Device Drivers. It does not provide any information on specific PCI devices.

The material contained in this section is designed to extend this specification and the *UEFI Driver Model* in a way that supports PCI device drivers and PCI bus drivers. These extensions are provided in the form of PCI-specific protocols. This section provides the information required to implement a PCI Bus Driver in system firmware. The section also contains the information required by driver writers to design and implement PCI Device Drivers that a platform may need to boot a UEFI-compliant OS.

The PCI Driver Model described here is intended to be a foundation on which a PCI Bus Driver and a wide variety of PCI Device Drivers can be created.

### 14.3.1 PCI Driver Initialization

There are very few differences between a PCI Bus Driver and PCI Device Driver in the entry point of the driver. The file for a driver image must be loaded from some type of media. This could include ROM, FLASH, hard drives, floppy drives, CD-ROM, or even a network connection. Once a driver image has been found, it can be loaded into system memory with the Boot Service [EFI\\_BOOT\\_SERVICES.LoadImage\(\)](#). [LoadImage\(\)](#) loads a PE/COFF formatted image into system memory. A handle is created for the driver, and a Loaded Image Protocol instance is placed on that handle. A handle that contains a Loaded Image Protocol instance is called an *Image Handle*. At this point, the driver has not been started. It is just sitting in memory waiting to be started. [Figure 43](#) shows the state of an image handle for a driver after [LoadImage\(\)](#) has been called.

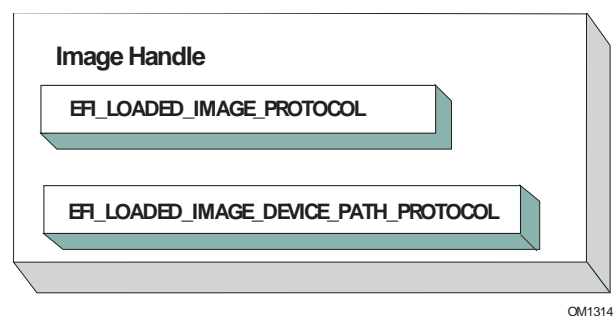

Figure 43. Image Handle

After a driver has been loaded with the Boot Service [EFI\\_BOOT\\_SERVICES.LoadImage\(\)](#), it must be started with the Boot Service [EFI\\_BOOT\\_SERVICES.StartImage\(\)](#). This is true of all types of applications and drivers that can be loaded and started on an UEFI compliant system. The entry point for a driver that follows the UEFI Driver Model must follow some strict rules. First, it is not allowed to touch any hardware. Instead, it is only allowed to install protocol instances onto its own *Image Handle*. A driver that follows the UEFI Driver Model is *required* to install an instance of the Driver Binding Protocol onto its

own *Image Handle*. It may optionally install the Driver Diagnostics Protocol or the Component Name Protocol. In addition, if a driver wishes to be unloadable it may optionally update the Loaded Image Protocol to provide its own `Unload()` function. Finally, if a driver needs to perform any special operations when the Boot Service `EFI_BOOT_SERVICES` is called (see [Services — Boot Services](#)), the driver may optionally create an event with a notification function that is triggered when the Boot Service `ExitBootServices()` is called. An *Image Handle* that contains a Driver Binding Protocol instance is known as a *Driver Image Handle*. [Figure 44](#) shows a possible configuration for the *Image Handle* from [Figure 43](#) after the Boot Service `StartImage()` has been called.

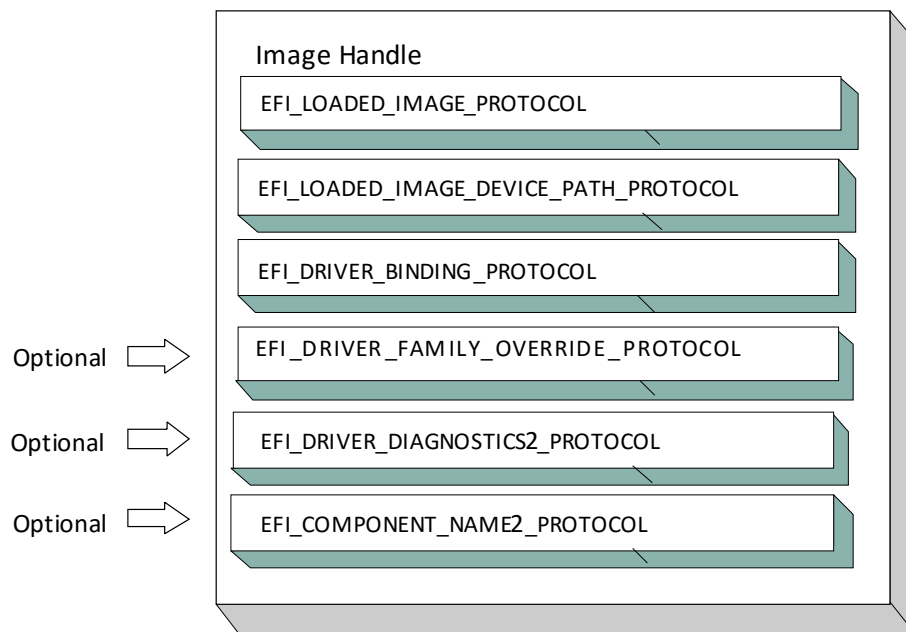

Figure 44. PCI Driver Image Handle

### 14.3.1.1 Driver Diagnostics Protocol

If a PCI Bus Driver or a PCI Device Driver requires diagnostics, then an [EFI\\_DRIVER\\_DIAGNOSTICS2\\_PROTOCOL](#) must be installed on the image handle in the entry point for the driver. This protocol contains functions to perform diagnostics on a controller. The [EFI\\_DRIVER\\_DIAGNOSTICS2\\_PROTOCOL](#) is not allowed to interact with the user. Instead, it must return status information through a buffer. The functions of this protocol will be invoked by a platform management utility.

### 14.3.1.2 Component Name Protocol

Both a PCI Bus Driver and a PCI Device Driver are able to produce user readable names for the PCI drivers and/or the set of PCI controllers that the PCI drivers are managing. This is accomplished by installing an instance of the [EFI\\_COMPONENT\\_NAME2\\_PROTOCOL](#) on the image handle of the driver. This protocol can produce driver and controller names in

the form of a string in one of several languages. This protocol can be used by a platform management utility to display user readable names for the drivers and controllers present in a system. Please see the *EFI Driver Model Specification* for details on the **EFI\_COMPONENT\_NAME2\_PROTOCOL**.

### 14.3.1.3 Driver Family Override Protocol

If a PCI Bus Driver or PCI Device Driver always wants the PCI driver delivered in a PCI Option ROM to manage the PCI controller associated with the PCI Option ROM, then the Driver Family Override Protocol must not be produced.

If a PCI Bus Driver or PCI Device Driver always wants the PCI driver with the highest Version value in the Driver Binding Protocol to manage all the PCI Controllers in the same family of PCI controllers, then the Driver Family Override Protocol must be produced on the same handle as the Driver Binding Protocol.

### 14.3.2 PCI Bus Drivers

A PCI Bus Driver manages PCI Host Bus Controllers that can contain one or more PCI Root Bridges. [Figure 45](#) shows an example of a desktop system that has one PCI Host Bus Controller with one PCI Root Bridge.

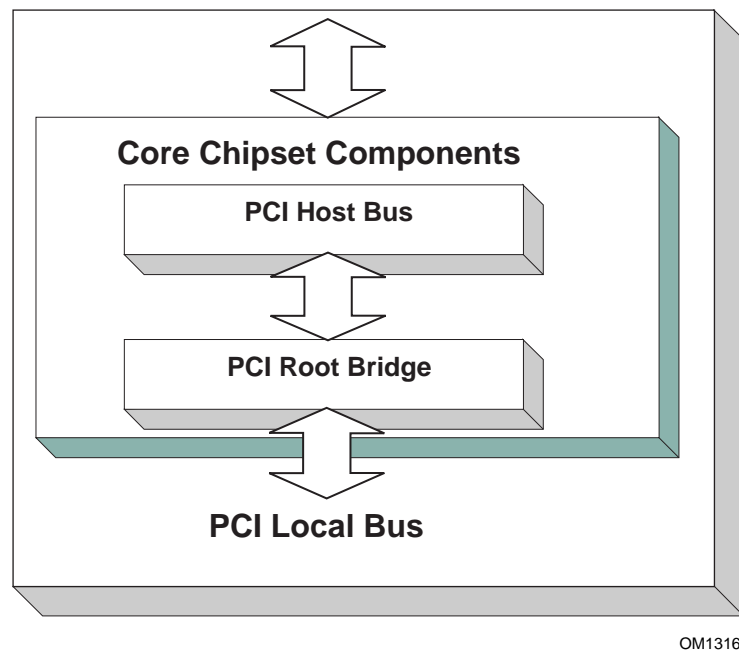
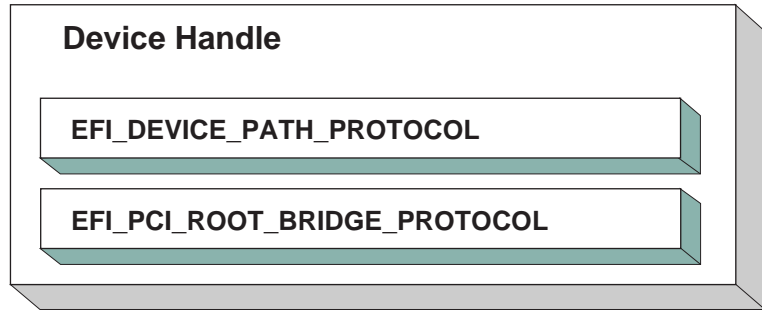

Figure 45. PCI Host Bus Controller

The PCI Host Bus Controller in [Figure 45](#) is abstracted in software with the PCI Root Bridge I/O Protocol. A PCI Bus Driver will manage handles that contain this protocol. [Figure 46](#) shows an example device handle for a PCI Host Bus Controller. It contains a Device Path Protocol instance and a PCI Root Bridge I/O Protocol Instance.



OM13151

Figure 46. Device Handle for a PCI Host Bus Controller

### 14.3.2.1 Driver Binding Protocol for PCI Bus Drivers

The Driver Binding Protocol contains three services. These are [Supported\(\)](#), [Start\(\)](#), and [Stop\(\)](#). **Supported()** tests to see if the PCI Bus Driver can manage a device handle. A PCI Bus Driver can only manage device handles that contain the Device Path Protocol and the PCI Root Bridge I/O Protocol, so a PCI Bus Driver must look for these two protocols on the device handle that is being tested.

The **Start()** function tells the PCI Bus Driver to start managing a device handle. The device handle should support the protocols shown in [Figure 46](#). The PCI Root Bridge I/O Protocols provides access to the PCI I/O, PCI Memory, PCI Prefetchable Memory, and PCI DMA functions. The PCI Controllers behind a PCI Root Bridge may exist on one or more PCI Buses. The standard mechanism for expanding the number of PCI Buses on a single PCI Root Bridge is to use PCI to PCI Bridges. Once a PCI Enumerator configures these bridges, they are invisible to software. As a result, the PCI Bus Driver flattens the PCI Bus hierarchy when it starts managing a device handle that represents a PCI Host Controller. [Figure 47](#) shows the physical tree structure for a set of PCI Device denoted by A, B, C, D, and E. Device A and C are PCI to PCI Bridges.

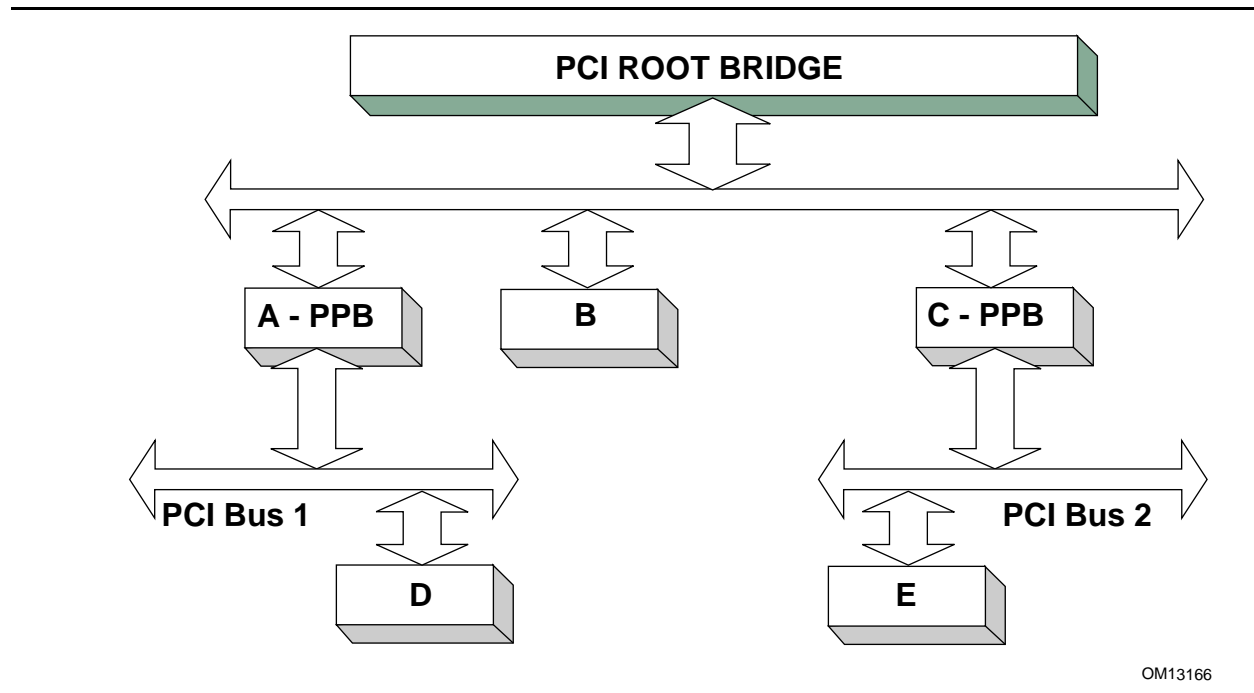

Figure 47. Physical PCI Bus Structure

[Figure 48](#) shows the tree structure generated by a PCI Bus Driver before and after **Start()** is called. This is a logical view of set of PCI controller, and not a physical view. The physical tree is flattened, so any PCI to PCI bridge devices are invisible. In this example, the PCI Bus Driver finds the five child PCI Controllers on the PCI Bus from [Figure 47](#). A device handle is created for every PCI Controller including all the PCI to PCI Bridges. The arrow with the dashed line coming into the PCI Host Bus Controller represents a link to the PCI Host Bus Controller's parent. If the PCI Host Bus Controller is a Root Bus Controller, then it will not have a parent. The PCI Driver Model does not require that a PCI Host Bus Controller be a Root Bus Controller. A PCI Host Bus Controller can be present at any location in the tree, and the PCI Bus Driver should be able to manage the PCI Host Bus Controller.

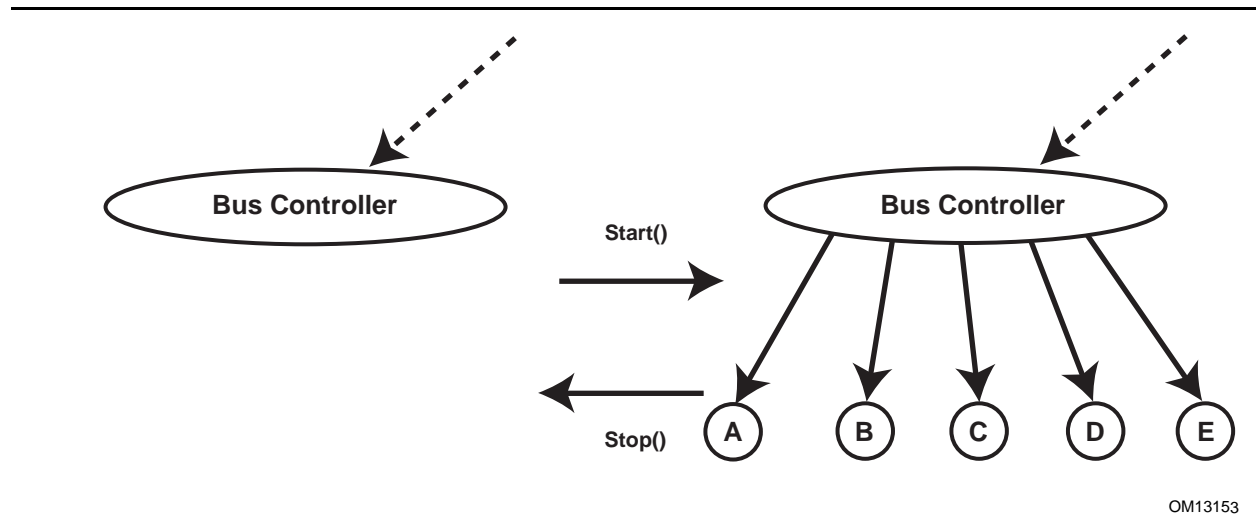

Figure 48. Connecting a PCI Bus Driver

The PCI Bus Driver has the option of creating all of its children in one call to [Start\(\)](#), or spreading it across several calls to [Start\(\)](#). In general, if it is possible to design a bus driver to create one child at a time, it should do so to support the rapid boot capability in the UEFI Driver Model. Each of the child device handles created in [Start\(\)](#) must contain a Device Path Protocol instance, a PCI I/O protocol instance, and optionally a Bus Specific Driver Override Protocol instance. The PCI I/O Protocol is described in [Section 14.4](#). The format of device paths for PCI Controllers is described in [Section 2.6](#), and details on the Bus Specific Driver Override Protocol can be found in the *EFI Driver Model Specification*. [Figure 49](#) shows an example child device handle that is created by a PCI Bus Driver for a PCI Controller.

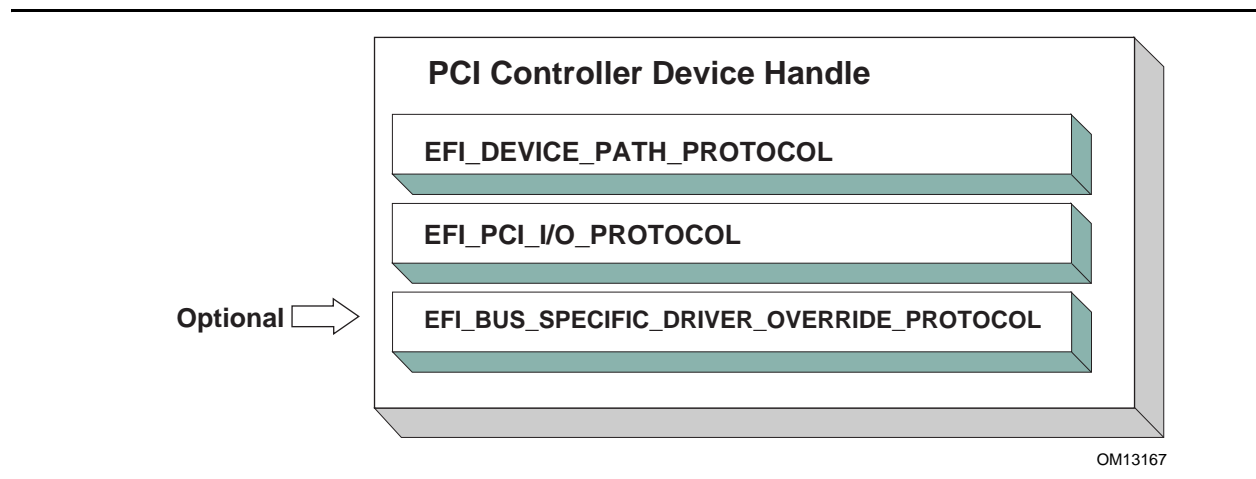

Figure 49. Child Handle Created by a PCI Bus Driver

A PCI Bus Driver must perform several steps to manage a PCI Host Bus Controller, as follows:

- Initialize the PCI Host Bus Controller.
- If the PCI buses have not been initialized by a previous agent, perform PCI Enumeration on all the PCI Root Bridges that the PCI Host Bus Controller contains. This involves assigning a PCI bus number, allocating PCI I/O resources, PCI Memory resources, and PCI Prefetchable Memory resources.
- Discover all the PCI Controllers on all the PCI Root Bridges. If a PCI Controller is a PCI to PCI Bridge, then the I/O, Memory, and Bus Master bits in the Control register of the PCI Configuration Header should be placed in the enabled state. The PCI Bus Driver should disable the I/O, Memory, and Bus Master bits for PCI Controllers that respond to legacy ISA resources (e.g. VGA). It is a PCI Device Driver's responsibility to enable the I/O, Memory, and Bus Master bits (if they are not already enabled by the PCI bus driver) of the Control register as required with a call to the [Attributes\(\)](#) service when the PCI Device Driver is started. A similar call to the [Attributes\(\)](#) service should be made when the PCI Device Driver is stopped to restore original [Attributes\(\)](#) state, including the I/O, Memory, and Bus Master bits of the Control register.
- Create a device handle for each PCI Controller found. If a request is being made to start only one PCI Controller, then only create one device handle.
- Install a Device Path Protocol instance and a PCI I/O Protocol instance on the device handle created for each PCI Controller.
- If the PCI Controller has a PCI Option ROM, then allocate a memory buffer that is the same size as the PCI Option ROM, and copy the PCI Option ROM contents to the memory buffer.
- If the PCI Option ROM contains any UEFI drivers, then attach a Bus Specific Driver Override Protocol to the device handle of the PCI Controller that is associated with the PCI Option ROM.

The [Stop\(\)](#) function tells the PCI Bus Driver to stop managing a PCI Host Bus Controller. The [Stop\(\)](#) function can destroy one or more of the device handles that were created on a previous call to [Start\(\)](#). If all of the child device handles have been destroyed, then [Stop\(\)](#) will place the PCI Host Bus Controller in a quiescent state. The functionality of [Stop\(\)](#) mirrors [Start\(\)](#), as follows:

1. Complete all outstanding transactions to the PCI Host Bus Controller.
2. If the PCI Host Bus Controller is being stopped, then place it in a quiescent state.
3. If one or more child handles are being destroyed, then:
  - a. Uninstall all the protocols from the device handles for the PCI Controllers found in [Start\(\)](#).
  - b. Free any memory buffers allocated for PCI Option ROMs.
  - c. Destroy the device handles for the PCI controllers created in [Start\(\)](#).

### 14.3.2.2 PCI Enumeration

The PCI Enumeration process is a platform-specific operation that depends on the properties of the chipset that produces the PCI bus. As a result, details on PCI Enumeration are outside the scope of this document. A PCI Bus Driver requires that PCI

Enumeration has been performed, so it either needs to have been done prior to the PCI Bus Driver starting, or it must be part of the PCI Bus Driver's implementation.

### 14.3.3 PCI Device Drivers

PCI Device Drivers manage PCI Controllers. Device handles for PCI Controllers are created by PCI Bus Drivers. A PCI Device Driver is not allowed to create any new device handles. Instead, it attaches protocol instance to the device handle of the PCI Controller. These protocol instances are I/O abstractions that allow the PCI Controller to be used in the preboot environment. The most common I/O abstractions are used to boot an EFI compliant OS.

#### 14.3.3.1 Driver Binding Protocol for PCI Device Drivers

The Driver Binding Protocol contains three services. These are [Supported\(\)](#), [Start\(\)](#), and [Stop\(\)](#). [Supported\(\)](#) tests to see if the PCI Device Driver can manage a device handle. A PCI Device Driver can only manage device handles that contain the Device Path Protocol and the PCI I/O Protocol, so a PCI Device Driver must look for these two protocols on the device handle that is being tested. In addition, it needs to check to see if the device handle represents a PCI Controller that the PCI Device Driver knows how to manage. This is typically done by using the services of the PCI I/O Protocol to read the PCI Configuration Header for the PCI Controller, and looking at the *VendorId*, *DeviceId*, and *SubsystemId* fields.

The [Start\(\)](#) function tells the PCI Device Driver to start managing a PCI Controller. A PCI Device Driver is not allowed to create any new device handles. Instead, it installs one or more addition protocol instances on the device handle for the PCI Controller. A PCI Device Driver is not allowed to modify the resources allocated to a PCI Controller. These resource allocations are owned by the PCI Bus Driver or some other firmware component that initialized the PCI Bus prior to the execution of the PCI Bus Driver. This means that the PCI BARs (Base Address Registers) and the configuration of any PCI to PCI bridge controllers must not be modified by a PCI Device Driver. A PCI Bus Driver will leave a PCI Device in a disabled safe initial state. A PCI Device Driver should save the original [Attributes\(\)](#) state. It is a PCI Device Driver's responsibility to call [Attributes\(\)](#) to enable the I/O, Memory, and Bus Master decodes if they are not already enabled by the PCI bus driver.

The [Stop\(\)](#) function mirrors the [Start\(\)](#) function, so the [Stop\(\)](#) function completes any outstanding transactions to the PCI Controller and removes the protocol interfaces that were installed in [Start\(\)](#). [Figure 50](#) shows the device handle for a PCI Controller before and after [Start\(\)](#) is called. In this example, a PCI Device Driver is adding the Block I/O Protocol to the device handle for the PCI Controller. It is also a PCI Device Driver's responsibility to restore original [Attributes\(\)](#) state, including the I/O, Memory, and Bus Master decodes by calling [Attributes\(\)](#).



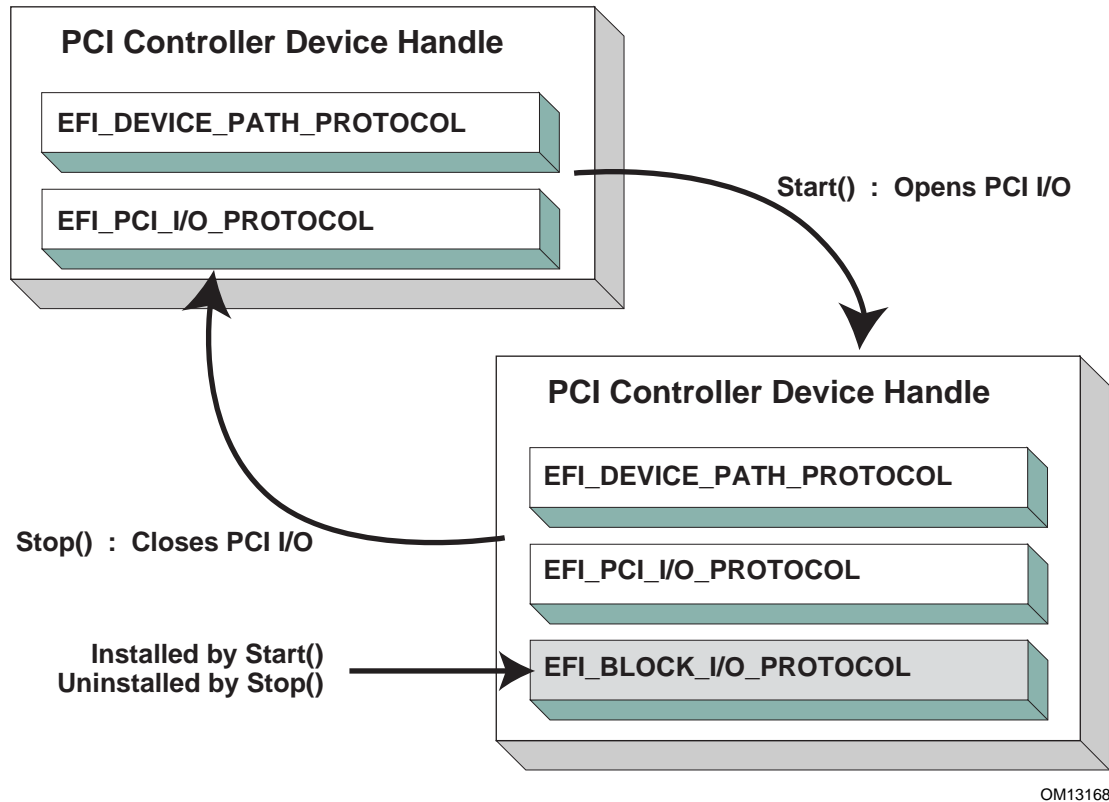

Figure 50. Connecting a PCI Device Driver

## 14.4 EFI PCI I/O Protocol

This section provides a detailed description of the [EFI PCI IO PROTOCOL](#). This protocol is used by code, typically drivers, running in the EFI boot services environment to access memory and I/O on a PCI controller. In particular, functions for managing devices on PCI buses are defined here.

The interfaces provided in the [EFI\\_PCI\\_IO\\_PROTOCOL](#) are for performing basic operations to memory, I/O, and PCI configuration space. The system provides abstracted access to basic system resources to allow a driver to have a programmatic method to access these basic system resources. The main goal of this protocol is to provide an abstraction that simplifies the writing of device drivers for PCI devices. This goal is accomplished by providing the following features:

- A driver model that does not require the driver to search the PCI busses for devices to manage. Instead, drivers are provided the location of the device to manage or have the capability to be notified when a PCI controller is discovered.
- A device driver model that abstracts the I/O addresses, Memory addresses, and PCI Configuration addresses from the PCI device driver. Instead, BAR (Base Address Register) relative addressing is used for I/O and Memory accesses, and device relative

addressing is used for PCI Configuration accesses. The BAR relative addressing is specified in the PCI I/O services as a BAR index. A PCI controller may contain a combination of 32-bit and 64-bit BARs. The BAR index represents the logical BAR number in the standard PCI configuration header starting from the first BAR. The BAR index does not represent an offset into the standard PCI Configuration Header because those offsets will vary depending on the combination and order of 32-bit and 64-bit BARs.

- The Device Path for the PCI device can be obtained from the same device handle that the **EFI\_PCI\_IO\_PROTOCOL** resides.
- The PCI Segment, PCI Bus Number, PCI Device Number, and PCI Function Number of the PCI device if they are required. The general idea is to abstract these details away from the PCI device driver. However, if these details are required, then they are available.
- Details on any nonstandard address decoding that is not covered by the PCI device's Base Address Registers.
- Access to the PCI Root Bridge I/O Protocol for the PCI Host Bus for which the PCI device is a member.
- A copy of the PCI Option ROM if it is present in system memory.
- Functions to perform bus mastering DMA. This includes both packet based DMA and common buffer DMA.

## EFI\_PCI\_IO\_PROTOCOL

### Summary

Provides the basic Memory, I/O, PCI configuration, and DMA interfaces that a driver uses to access its PCI controller.

## GUID

```
#define EFI_PCI_IO_PROTOCOL_GUID \
{0x4cf5b200,0x68b8,0x4ca5,\
{0x9e,0xec,0xb2,0x3e,0x3f,0x50,0x02,0x9a}}
```

## Protocol Interface Structure

```
typedef struct _EFI_PCI_IO_PROTOCOL {
  EFI_PCI_IO_PROTOCOL_POLL_IO_MEM  PollMem;
  EFI_PCI_IO_PROTOCOL_POLL_IO_MEM  PollIo;
  EFI_PCI_IO_PROTOCOL_ACCESS        Mem;
  EFI_PCI_IO_PROTOCOL_ACCESS        Io;
  EFI_PCI_IO_PROTOCOL_CONFIG_ACCESS Pci;
  EFI_PCI_IO_PROTOCOL_COPY_MEM      CopyMem;
  EFI_PCI_IO_PROTOCOL_MAP            Map;
  EFI_PCI_IO_PROTOCOL_UNMAP          Unmap;
  EFI_PCI_IO_PROTOCOL_ALLOCATE_BUFFER AllocateBuffer;
  EFI_PCI_IO_PROTOCOL_FREE_BUFFER    FreeBuffer;
  EFI_PCI_IO_PROTOCOL_FLUSH          Flush;
  EFI_PCI_IO_PROTOCOL_GET_LOCATION   GetLocation;
  EFI_PCI_IO_PROTOCOL_ATTRIBUTES     Attributes;
  EFI_PCI_IO_PROTOCOL_GET_BAR_ATTRIBUTES GetBarAttributes;
  EFI_PCI_IO_PROTOCOL_SET_BAR_ATTRIBUTES SetBarAttributes;
  UINT64                               RomSize;
  VOID                                   *RomImage;
} EFI_PCI_IO_PROTOCOL;
```

## Parameters

<i>PollMem</i>	Polls an address in PCI memory space until an exit condition is met, or a timeout occurs. See the <a href="#">PollMem()</a> function description.
<i>PollIo</i>	Polls an address in PCI I/O space until an exit condition is met, or a timeout occurs. See the <a href="#">PollIo()</a> function description.
<i>Mem.Read</i>	Allows BAR relative reads to PCI memory space. See the <a href="#">Mem.Read()</a> function description.
<i>Mem.Write</i>	Allows BAR relative writes to PCI memory space. See the <a href="#">Mem.Write()</a> function description.
<i>Io.Read</i>	Allows BAR relative reads to PCI I/O space. See the <a href="#">Io.Read()</a> function description.
<i>Io.Write</i>	Allows BAR relative writes to PCI I/O space. See the <a href="#">Io.Write()</a> function description.
<i>Pci.Read</i>	Allows PCI controller relative reads to PCI configuration space. See the <a href="#">Pci.Read()</a> function description.
<i>Pci.Write</i>	Allows PCI controller relative writes to PCI configuration space. See the <a href="#">Pci.Write()</a> function description.

<i>CopyMem</i>	Allows one region of PCI memory space to be copied to another region of PCI memory space. See the <a href="#">CopyMem()</a> function description.
<i>Map</i>	Provides the PCI controller-specific address needed to access system memory for DMA. See the <a href="#">Map()</a> function description.
<i>Unmap</i>	Releases any resources allocated by <a href="#">Map()</a> . See the <a href="#">Unmap()</a> function description.
<i>AllocateBuffer</i>	Allocates pages that are suitable for a common buffer mapping. See the <a href="#">AllocateBuffer()</a> function description.
<i>FreeBuffer</i>	Frees pages that were allocated with <a href="#">AllocateBuffer()</a> . See the <a href="#">FreeBuffer()</a> function description.
<i>Flush</i>	Flushes all PCI posted write transactions to system memory. See the <a href="#">Flush()</a> function description.
<i>GetLocation</i>	Retrieves this PCI controller's current PCI bus number, device number, and function number. See the <a href="#">GetLocation()</a> function description.
<i>Attributes</i>	Performs an operation on the attributes that this PCI controller supports. The operations include getting the set of supported attributes, retrieving the current attributes, setting the current attributes, enabling attributes, and disabling attributes. See the <a href="#">Attributes()</a> function description.
<i>GetBarAttributes</i>	Gets the attributes that this PCI controller supports setting on a BAR using <a href="#">SetBarAttributes()</a> , and retrieves the list of resource descriptors for a BAR. See the <a href="#">GetBarAttributes()</a> function description.
<i>SetBarAttributes</i>	Sets the attributes for a range of a BAR on a PCI controller. See the <a href="#">SetBarAttributes()</a> function description.
<i>RomSize</i>	The size, in bytes, of the ROM image.
<i>RomImage</i>	A pointer to the in memory copy of the ROM image. The PCI Bus Driver is responsible for allocating memory for the ROM image, and copying the contents of the ROM to memory. The contents of this buffer are either from the PCI option ROM that can be accessed through the ROM BAR of the PCI controller, or it is from a platform-specific location. The <a href="#">Attributes()</a> function can be used to determine from which of these two sources the <i>RomImage</i> buffer was initialized.

## Related Definitions

```

//*****
// EFI_PCI_IO_PROTOCOL_WIDTH
//*****
typedef enum {
  EfiPciloWidthUint8,
  EfiPciloWidthUint16,
  EfiPciloWidthUint32,
  EfiPciloWidthUint64,
  EfiPciloWidthFifoUint8,
  EfiPciloWidthFifoUint16,
  EfiPciloWidthFifoUint32,
  EfiPciloWidthFifoUint64,
  EfiPciloWidthFillUint8,
  EfiPciloWidthFillUint16,
  EfiPciloWidthFillUint32,
  EfiPciloWidthFillUint64,
  EfiPciloWidthMaximum
} EFI_PCI_IO_PROTOCOL_WIDTH;

#define EFI_PCI_IO_PASS_THROUGH_BAR 0xff

//*****
// EFI_PCI_IO_PROTOCOL_POLL_IO_MEM
//*****
typedef
EFI_STATUS
(EFIAPI *EFI_PCI_IO_PROTOCOL_POLL_IO_MEM) (
  IN EFI_PCI_IO_PROTOCOL *This,
  IN EFI_PCI_IO_PROTOCOL_WIDTH Width,
  IN UINT8 BarIndex,
  IN UINT64 Offset,
  IN UINT64 Mask,
  IN UINT64 Value,
  IN UINT64 Delay,
  OUT UINT64 *Result
);
//*****
// EFI_PCI_IO_PROTOCOL_IO_MEM
//*****
typedef
EFI_STATUS
(EFIAPI *EFI_PCI_IO_PROTOCOL_IO_MEM) (
  IN EFI_PCI_IO_PROTOCOL *This,
  IN EFI_PCI_IO_PROTOCOL_WIDTH Width,
  IN UINT8 BarIndex,
  IN UINT64 Offset,

```

```

    IN UINTN      Count,
    IN OUT VOID   *Buffer
);

//*****
// EFI_PCI_IO_PROTOCOL_ACCESS
//*****
typedef struct {
    EFI_PCI_IO_PROTOCOL_IO_MEM Read;
    EFI_PCI_IO_PROTOCOL_IO_MEM Write;
} EFI_PCI_IO_PROTOCOL_ACCESS;

//*****
// EFI_PCI_IO_PROTOCOL_CONFIG
//*****
typedef
EFI_STATUS
(EFIAPI *EFI_PCI_IO_PROTOCOL_CONFIG) (
    IN EFI_PCI_IO_PROTOCOL *This,
    IN EFI_PCI_IO_PROTOCOL_WIDTH Width,
    IN UINT32      Offset,
    IN UINTN      Count,
    IN OUT VOID    *Buffer
);

//*****
// EFI_PCI_IO_PROTOCOL_CONFIG_ACCESS
//*****
typedef struct {
    EFI_PCI_IO_PROTOCOL_CONFIG Read;
    EFI_PCI_IO_PROTOCOL_CONFIG Write;
} EFI_PCI_IO_PROTOCOL_CONFIG_ACCESS;
//*****
// EFI PCI I/O Protocol Attribute bits
//*****
#define EFI_PCI_IO_ATTRIBUTE_ISA_MOTHERBOARD_IO 0x0001
#define EFI_PCI_IO_ATTRIBUTE_ISA_IO            0x0002
#define EFI_PCI_IO_ATTRIBUTE_VGA_PALETTE_IO    0x0004
#define EFI_PCI_IO_ATTRIBUTE_VGA_MEMORY        0x0008
#define EFI_PCI_IO_ATTRIBUTE_VGA_IO            0x0010
#define EFI_PCI_IO_ATTRIBUTE_IDE_PRIMARY_IO     0x0020
#define EFI_PCI_IO_ATTRIBUTE_IDE_SECONDARY_IO  0x0040
#define EFI_PCI_IO_ATTRIBUTE_MEMORY_WRITE_COMBINE 0x0080
#define EFI_PCI_IO_ATTRIBUTE_IO                0x0100
#define EFI_PCI_IO_ATTRIBUTE_MEMORY            0x0200
#define EFI_PCI_IO_ATTRIBUTE_BUS_MASTER        0x0400
#define EFI_PCI_IO_ATTRIBUTE_MEMORY_CACHED     0x0800

```

```
#define EFI_PCI_IO_ATTRIBUTE_MEMORY_DISABLE 0x1000
#define EFI_PCI_IO_ATTRIBUTE_EMBEDDED_DEVICE 0x2000
#define EFI_PCI_IO_ATTRIBUTE_EMBEDDED_ROM 0x4000
#define EFI_PCI_IO_ATTRIBUTE_DUAL_ADDRESS_CYCLE 0x8000
#define EFI_PCI_IO_ATTRIBUTE_ISA_IO_16 0x10000
#define EFI_PCI_IO_ATTRIBUTE_VGA_PALETTE_IO_16 0x20000
#define EFI_PCI_IO_ATTRIBUTE_VGA_IO_16 0x40000
```

#### **EFI\_PCI\_IO\_ATTRIBUTE\_ISA\_IO\_16**

If this bit is set, then the PCI I/O cycles between 0x100 and 0x3FF are forwarded to the PCI controller using a 16-bit address decoder on address bits 0..15. Address bits 16..31 must be zero. This bit is used to forward I/O cycles for legacy ISA devices. If this bit is set, then the PCI Host Bus Controller and all the PCI to PCI bridges between the PCI Host Bus Controller and the PCI Controller are configured to forward these PCI I/O cycles. This bit may not be combined with **EFI\_PCI\_IO\_ATTRIBUTE\_ISA\_IO**.

#### **EFI\_PCI\_IO\_ATTRIBUTE\_VGA\_PALETTE\_IO\_16**

If this bit is set, then the PCI I/O write cycles for 0x3C6, 0x3C8, and 0x3C9 are forwarded to the PCI controller using a 16-bit address decoder on address bits 0..15. Address bits 16..31 must be zero. This bit is used to forward I/O write cycles to the VGA palette registers on a PCI controller. If this bit is set, then the PCI Host Bus Controller and all the PCI to PCI bridges between the PCI Host Bus Controller and the PCI Controller are configured to forward these PCI I/O cycles. This bit may not be combined with

**EFI\_PCI\_IO\_ATTRIBUTE\_VGA\_IO** or  
**EFI\_PCI\_IO\_ATTRIBUTE\_VGA\_PALETTE\_IO**.

#### **EFI\_PCI\_IO\_ATTRIBUTE\_VGA\_IO\_16**

If this bit is set, then the PCI I/O cycles in the ranges 0x3B0–0x3BB and 0x3C0–0x3DF are forwarded to the PCI controller using a 16-bit address decoder on address bits 0..15. Address bits 16..31 must be zero. This bit is used to forward I/O cycles for a VGA controller to a PCI controller. If this bit is set, then the PCI Host Bus Controller and all the PCI to PCI bridges between the PCI Host Bus Controller and the PCI Controller are configured to forward these PCI I/O cycles. This bit may not be combined with

**EFI\_PCI\_IO\_ATTRIBUTE\_VGA\_IO** or  
**EFI\_PCI\_IO\_ATTRIBUTE\_VGA\_PALETTE\_IO**. Because  
**EFI\_PCI\_IO\_ATTRIBUTE\_VGA\_IO\_16** also includes the I/O range described by **EFI\_PCI\_IO\_ATTRIBUTE\_VGA\_PALETTE\_IO\_16**, the  
**EFI\_PCI\_IO\_ATTRIBUTE\_VGA\_PALETTE\_IO\_16** bit is ignored if  
**EFI\_PCI\_IO\_ATTRIBUTE\_VGA\_IO\_16** is set.

#### **EFI\_PCI\_IO\_ATTRIBUTE\_ISA\_MOTHERBOARD\_IO**

If this bit is set, then the PCI I/O cycles between 0x00000000 and 0x000000FF are forwarded to the PCI controller. This bit is used to forward I/O cycles for ISA motherboard devices. If this bit is set, then the PCI Host Bus Controller and all the PCI to PCI bridges between the PCI Host Bus

Controller and the PCI Controller are configured to forward these PCI I/O cycles.

#### **EFI\_PCI\_IO\_ATTRIBUTE\_ISA\_IO**

If this bit is set, then the PCI I/O cycles between 0x100 and 0x3FF are forwarded to the PCI controller using a 10-bit address decoder on address bits 0..9. Address bits 10..15 are not decoded, and address bits 16..31 must be zero. This bit is used to forward I/O cycles for legacy ISA devices. If this bit is set, then the PCI Host Bus Controller and all the PCI to PCI bridges between the PCI Host Bus Controller and the PCI Controller are configured to forward these PCI I/O cycles.

#### **EFI\_PCI\_IO\_ATTRIBUTE\_VGA\_PALETTE\_IO**

If this bit is set, then the PCI I/O write cycles for 0x3C6, 0x3C8, and 0x3C9 are forwarded to the PCI controller using a 10-bit address decoder on address bits 0..9. Address bits 10..15 are not decoded, and address bits 16..31 must be zero. This bit is used to forward I/O write cycles to the VGA palette registers on a PCI controller. If this bit is set, then the PCI Host Bus Controller and all the PCI to PCI bridges between the PCI Host Bus Controller and the PCI Controller are configured to forward these PCI I/O cycles.

#### **EFI\_PCI\_IO\_ATTRIBUTE\_VGA\_MEMORY**

If this bit is set, then the PCI memory cycles between 0xA0000 and 0xBFFFF are forwarded to the PCI controller. This bit is used to forward memory cycles for a VGA frame buffer on a PCI controller. If this bit is set, then the PCI Host Bus Controller and all the PCI to PCI bridges between the PCI Host Bus Controller and the PCI Controller are configured to forward these PCI Memory cycles.

#### **EFI\_PCI\_IO\_ATTRIBUTE\_VGA\_IO**

If this bit is set, then the PCI I/O cycles in the ranges 0x3B0-0x3BB and 0x3C0-0x3DF are forwarded to the PCI controller using a 10-bit address decoder on address bits 0..9. Address bits 10..15 are not decoded, and the address bits 16..31 must be zero. This bit is used to forward I/O cycles for a VGA controller to a PCI controller. If this bit is set, then the PCI Host Bus Controller and all the PCI to PCI bridges between the PCI Host Bus Controller and the PCI Controller are configured to forward these PCI I/O cycles. Since **EFI\_PCI\_IO\_ATTRIBUTE\_VGA\_IO** also includes the I/O range described by **EFI\_PCI\_IO\_ATTRIBUTE\_VGA\_PALETTE\_IO**, the **EFI\_PCI\_IO\_ATTRIBUTE\_VGA\_PALETTE\_IO** bit is ignored if **EFI\_PCI\_IO\_ATTRIBUTE\_VGA\_IO** is set.

#### **EFI\_PCI\_IO\_ATTRIBUTE\_IDE\_PRIMARY\_IO**

If this bit is set, then the PCI I/O cycles in the ranges 0x1F0-0x1F7 and 0x3F6-0x3F7 are forwarded to a PCI controller using a 16-bit address decoder on address bits 0..15. Address bits 16..31 must be zero. This bit is used to forward I/O cycles for a Primary IDE controller to a PCI controller. If this bit is set, then the PCI Host Bus Controller and all the PCI to PCI bridges



between the PCI Host Bus Controller and the PCI Controller are configured to forward these PCI I/O cycles.

#### **EFI\_PCI\_IO\_ATTRIBUTE\_IDE\_SECONDARY\_IO**

If this bit is set, then the PCI I/O cycles in the ranges 0x170-0x177 and 0x376-0x377 are forwarded to a PCI controller using a 16-bit address decoder on address bits 0..15. Address bits 16..31 must be zero. This bit is used to forward I/O cycles for a Secondary IDE controller to a PCI controller. If this bit is set, then the PCI Host Bus Controller and all the PCI to PCI bridges between the PCI Host Bus Controller and the PCI Controller are configured to forward these PCI I/O cycles.

#### **EFI\_PCI\_IO\_ATTRIBUTE\_MEMORY\_WRITE\_COMBINE**

If this bit is set, then this platform supports changing the attributes of a PCI memory range so that the memory range is accessed in a write combining mode. This bit is used to improve the write performance to a memory buffer on a PCI controller. By default, PCI memory ranges are not accessed in a write combining mode.

#### **EFI\_PCI\_IO\_ATTRIBUTE\_MEMORY\_CACHED**

If this bit is set, then this platform supports changing the attributes of a PCI memory range so that the memory range is accessed in a cached mode. By default, PCI memory ranges are accessed noncached.

#### **EFI\_PCI\_IO\_ATTRIBUTE\_IO**

If this bit is set, then the PCI device will decode the PCI I/O cycles that the device is configured to decode.

#### **EFI\_PCI\_IO\_ATTRIBUTE\_MEMORY**

If this bit is set, then the PCI device will decode the PCI Memory cycles that the device is configured to decode.

#### **EFI\_PCI\_IO\_ATTRIBUTE\_BUS\_MASTER**

If this bit is set, then the PCI device is allowed to act as a bus master on the PCI bus.

#### **EFI\_PCI\_IO\_ATTRIBUTE\_MEMORY\_DISABLE**

If this bit is set, then this platform supports changing the attributes of a PCI memory range so that the memory range is disabled, and can no longer be accessed. By default, all PCI memory ranges are enabled.

#### **EFI\_PCI\_IO\_ATTRIBUTE\_EMBEDDED\_DEVICE**

If this bit is set, then the PCI controller is an embedded device that is typically a component on the system board. If this bit is clear, then this PCI controller is part of an adapter that is populating one of the systems PCI slots.

#### **EFI\_PCI\_IO\_ATTRIBUTE\_EMBEDDED\_ROM**

If this bit is set, then the PCI option ROM described by the *RomImage* and *RomSize* fields is not from ROM BAR of the PCI controller. If this bit is clear,

then the *RomImage* and *RomSize* fields were initialized based on the PCI option ROM found through the ROM BAR of the PCI controller.

**EFI\_PCI\_IO\_ATTRIBUTE\_DUAL\_ADDRESS\_CYCLE**

If this bit is set, then the PCI controller is capable of producing PCI Dual Address Cycles, so it is able to access a 64-bit address space. If this bit is not set, then the PCI controller is not capable of producing PCI Dual Address Cycles, so it is only able to access a 32-bit address space.

If this bit is set, then the PCI Host Bus Controller and all the PCI to PCI bridges between the PCI Host Bus Controller and the PCI Controller are capable of producing PCI Dual Address Cycles. If any of them is not capable of producing PCI Dual Address Cycles, attempt to perform Set or Enable operation using **Attributes()** function with this bit set will fail with the **EFI\_UNSUPPORTED** error code.

```

//*****
// EFI_PCI_IO_PROTOCOL_OPERATION
//*****
typedef enum {
  EfiPciloOperationBusMasterRead,
  EfiPciloOperationBusMasterWrite,
  EfiPciloOperationBusMasterCommonBuffer,
  EfiPciloOperationMaximum
} EFI_PCI_IO_PROTOCOL_OPERATION;
    
```

**EfiPciloOperationBusMasterRead**

A read operation from system memory by a bus master.

**EfiPciloOperationBusMasterWrite**

A write operation to system memory by a bus master.

**EfiPciloOperationBusMasterCommonBuffer**

Provides both read and write access to system memory by both the processor and a bus master. The buffer is coherent from both the processor’s and the bus master’s point of view.

**Description**

The **EFI\_PCI\_IO\_PROTOCOL** provides the basic Memory, I/O, PCI configuration, and DMA interfaces that are used to abstract accesses to PCI controllers. There is one **EFI\_PCI\_IO\_PROTOCOL** instance for each PCI controller on a PCI bus. A device driver that wishes to manage a PCI controller in a system will have to retrieve the **EFI\_PCI\_IO\_PROTOCOL** instance that is associated with the PCI controller. A device handle for a PCI controller will minimally contain an [EFI\\_DEVICE\\_PATH\\_PROTOCOL](#) instance and an **EFI\_PCI\_IO\_PROTOCOL** instance.

Bus mastering PCI controllers can use the DMA services for DMA operations. There are three basic types of bus mastering DMA that is supported by this protocol. These are DMA reads by a bus master, DMA writes by a bus master, and common buffer DMA. The

DMA read and write operations may need to be broken into smaller chunks. The caller of [Map\(\)](#) must pay attention to the number of bytes that were mapped, and if required, loop until the entire buffer has been transferred. The following is a list of the different bus mastering DMA operations that are supported, and the sequence of **EFI\_PCI\_IO\_PROTOCOL** interfaces that are used for each DMA operation type.

#### DMA Bus Master Read Operation

Call [Map\(\)](#) for `EfiPciIoOperationBusMasterRead`.

Program the DMA Bus Master with the *DeviceAddress* returned by [Map\(\)](#).

Start the DMA Bus Master.

Wait for DMA Bus Master to complete the read operation.

Call [Unmap\(\)](#).

#### DMA Bus Master Write Operation

Call [Map\(\)](#) for `EfiPciIoOperationBusMasterWrite`.

Program the DMA Bus Master with the *DeviceAddress* returned by [Map\(\)](#).

Start the DMA Bus Master.

Wait for DMA Bus Master to complete the write operation.

Perform a PCI controller specific read transaction to flush all PCI write buffers (See *PCI Specification* Section 3.2.5.2) .

Call [Flush\(\)](#).

Call [Unmap\(\)](#).

#### DMA Bus Master Common Buffer Operation

Call [AllocateBuffer\(\)](#) to allocate a common buffer.

Call [Map\(\)](#) for `EfiPciIoOperationBusMasterCommonBuffer`.

Program the DMA Bus Master with the *DeviceAddress* returned by [Map\(\)](#).

The common buffer can now be accessed equally by the processor and the DMA bus master.

Call [Unmap\(\)](#).

Call [FreeBuffer\(\)](#).

## EFI\_PCI\_IO\_PROTOCOL.PollMem()

### Summary

Reads from the memory space of a PCI controller. Returns when either the polling exit criteria is satisfied or after a defined duration.

### Prototype

```
typedef
EFI_STATUS
(EFI_API *EFI_PCI_IO_PROTOCOL_POLL_IO_MEM) (
    IN EFI_PCI_IO_PROTOCOL *This,
    IN EFI_PCI_IO_PROTOCOL_WIDTH Width,
    IN UINT8 BarIndex,
    IN UINT64 Offset,
    IN UINT64 Mask,
    IN UINT64 Value,
    IN UINT64 Delay,
    OUT UINT64 *Result
);
```

### Parameters

<i>This</i>	A pointer to the <a href="#">EFI PCI IO PROTOCOL</a> instance. Type <a href="#">EFI_PCI_IO_PROTOCOL</a> is defined in <a href="#">Section 14.4</a> .
<i>Width</i>	Signifies the width of the memory operations. Type <a href="#">EFI_PCI_IO_PROTOCOL_WIDTH</a> is defined in <a href="#">Section 14.4</a> .
<i>BarIndex</i>	The BAR index of the standard PCI Configuration header to use as the base address for the memory operation to perform. This allows all drivers to use BAR relative addressing. The legal range for this field is 0..5. However, the value <a href="#">EFI_PCI_IO_PASS_THROUGH_BAR</a> can be used to bypass the BAR relative addressing and pass <i>Offset</i> to the PCI Root Bridge I/O Protocol unchanged. Type <a href="#">EFI_PCI_IO_PASS_THROUGH_BAR</a> is defined in <a href="#">Section 14.4</a> .
<i>Offset</i>	The offset within the selected BAR to start the memory operation.
<i>Mask</i>	Mask used for the polling criteria. Bytes above <i>Width</i> in <i>Mask</i> are ignored. The bits in the bytes below <i>Width</i> which are zero in <i>Mask</i> are ignored when polling the memory address.
<i>Value</i>	The comparison value used for the polling exit criteria.
<i>Delay</i>	The number of 100 ns units to poll. Note that timer available may be of poorer granularity.
<i>Result</i>	Pointer to the last value read from the memory location.

## Description

This function provides a standard way to poll a PCI memory location. A PCI memory read operation is performed at the PCI memory address specified by *BarIndex* and *Offset* for the width specified by *Width*. The result of this PCI memory read operation is stored in *Result*. This PCI memory read operation is repeated until either a timeout of *Delay* 100 ns units has expired, or (*Result & Mask*) is equal to *Value*.

This function will always perform at least one memory access no matter how small *Delay* may be. If *Delay* is 0, then *Result* will be returned with a status of **EFI\_SUCCESS** even if *Result* does not match the exit criteria. If *Delay* expires, then **EFI\_TIMEOUT** is returned.

If *Width* is not **EfiPciloWidthUint8**, **EfiPciloWidthUint16**, **EfiPciloWidthUint32**, or **EfiPciloWidthUint64**, then **EFI\_INVALID\_PARAMETER** is returned.

The memory operations are carried out exactly as requested. The caller is responsible for satisfying any alignment and memory width restrictions that a PCI controller on a platform might require. For example on some platforms, width requests of **EfiPciloWidthUint64** do not work.

All the PCI transactions generated by this function are guaranteed to be completed before this function returns. However, if the memory mapped I/O region being accessed by this function has the **EFI\_PCI\_ATTRIBUTE\_MEMORY\_CACHED** attribute set, then the transactions will follow the ordering rules defined by the processor architecture.

## Status Codes Returned

EFI_SUCCESS	The last data returned from the access matched the poll exit criteria.
EFI_INVALID_PARAMETER	<i>Width</i> is invalid.
EFI_INVALID_PARAMETER	<i>Result</i> is <b>NULL</b> .
EFI_UNSUPPORTED	<i>BarIndex</i> not valid for this PCI controller.
EFI_UNSUPPORTED	<i>Offset</i> is not valid for the <i>BarIndex</i> of this PCI controller.
EFI_TIMEOUT	<i>Delay</i> expired before a match occurred.
EFI_OUT_OF_RESOURCES	The request could not be completed due to a lack of resources.

## EFI\_PCI\_IO\_PROTOCOL.PollIo()

### Summary

Reads from the I/O space of a PCI controller. Returns when either the polling exit criteria is satisfied or after a defined duration.

### Prototype

```
typedef
EFI_STATUS
(EFIAPI *EFI_PCI_IO_PROTOCOL_POLL_IO_MEM) (
    IN EFI_PCI_IO_PROTOCOL  *This,
    IN EFI_PCI_IO_PROTOCOL_WIDTH Width,
    IN UINT8                BarIndex,
    IN UINT64                Offset,
    IN UINT64                Mask,
    IN UINT64                Value,
    IN UINT64                Delay,
    OUT UINT64               *Result
);
```

### Parameters

<i>This</i>	A pointer to the <a href="#">EFI_PCI_IO_PROTOCOL</a> instance. Type <a href="#">EFI_PCI_IO_PROTOCOL</a> is defined in <a href="#">Section 14.4</a> .
<i>Width</i>	Signifies the width of the I/O operations. Type <a href="#">EFI_PCI_IO_PROTOCOL_WIDTH</a> is defined in <a href="#">Section 14.4</a> .
<i>BarIndex</i>	The BAR index of the standard PCI Configuration header to use as the base address for the I/O operation to perform. This allows all drivers to use BAR relative addressing. The legal range for this field is 0..5. However, the value <a href="#">EFI_PCI_IO_PASS_THROUGH_BAR</a> can be used to bypass the BAR relative addressing and pass <i>Offset</i> to the PCI Root Bridge I/O Protocol unchanged. Type <a href="#">EFI_PCI_IO_PASS_THROUGH_BAR</a> is defined in <a href="#">Section 14.4</a> .
<i>Offset</i>	The offset within the selected BAR to start the I/O operation.
<i>Mask</i>	Mask used for the polling criteria. Bytes above <i>Width</i> in <i>Mask</i> are ignored. The bits in the bytes below <i>Width</i> which are zero in <i>Mask</i> are ignored when polling the I/O address.
<i>Value</i>	The comparison value used for the polling exit criteria.
<i>Delay</i>	The number of 100 ns units to poll. Note that timer available may be of poorer granularity.
<i>Result</i>	Pointer to the last value read from the memory location.

## Description

This function provides a standard way to poll a PCI I/O location. A PCI I/O read operation is performed at the PCI I/O address specified by *BarIndex* and *Offset* for the width specified by *Width*. The result of this PCI I/O read operation is stored in *Result*. This PCI I/O read operation is repeated until either a timeout of *Delay* 100 ns units has expired, or (*Result & Mask*) is equal to *Value*.

This function will always perform at least one I/O access no matter how small *Delay* may be. If *Delay* is 0, then *Result* will be returned with a status of **EFI\_SUCCESS** even if *Result* does not match the exit criteria. If *Delay* expires, then **EFI\_TIMEOUT** is returned.

If *Width* is not **EfiPciloWidthUint8**, **EfiPciloWidthUint16**, **EfiPciloWidthUint32**, or **EfiPciloWidthUint64**, then **EFI\_INVALID\_PARAMETER** is returned.

The I/O operations are carried out exactly as requested. The caller is responsible satisfying any alignment and I/O width restrictions that the PCI controller on a platform might require. For example on some platforms, width requests of **EfiPciloWidthUint64** do not work.

All the PCI read transactions generated by this function are guaranteed to be completed before this function returns.

## Status Codes Returned

EFI_SUCCESS	The last data returned from the access matched the poll exit criteria.
EFI_INVALID_PARAMETER	<i>Width</i> is invalid.
EFI_INVALID_PARAMETER	<i>Result</i> is <b>NULL</b> .
EFI_UNSUPPORTED	<i>BarIndex</i> not valid for this PCI controller.
EFI_UNSUPPORTED	<i>Offset</i> is not valid for the PCI BAR specified by <i>BarIndex</i> .
EFI_TIMEOUT	<i>Delay</i> expired before a match occurred.
EFI_OUT_OF_RESOURCES	The request could not be completed due to a lack of resources.

## EFI\_PCI\_IO\_PROTOCOL.Mem.Read() EFI\_PCI\_IO\_PROTOCOL.Mem.Write()

### Summary

Enable a PCI driver to access PCI controller registers in the PCI memory space.

### Prototype

```
typedef
EFI_STATUS
(EFI_API *EFI_PCI_IO_PROTOCOL_MEM) (
    IN EFI_PCI_IO_PROTOCOL *This,
    IN EFI_PCI_IO_PROTOCOL_WIDTH Width,
    IN UINT8 BarIndex,
    IN UINT64 Offset,
    IN UINTN Count,
    IN OUT VOID *Buffer
);
```

### Parameters

<i>This</i>	A pointer to the <a href="#">EFI_PCI_IO_PROTOCOL</a> instance. Type <a href="#">EFI_PCI_IO_PROTOCOL</a> is defined in <a href="#">Section 14.4</a> .
<i>Width</i>	Signifies the width of the memory operations. Type <a href="#">EFI_PCI_IO_PROTOCOL_WIDTH</a> is defined in <a href="#">Section 14.4</a> .
<i>BarIndex</i>	The BAR index of the standard PCI Configuration header to use as the base address for the memory operation to perform. This allows all drivers to use BAR relative addressing. The legal range for this field is 0..5. However, the value <a href="#">EFI_PCI_IO_PASS_THROUGH_BAR</a> can be used to bypass the BAR relative addressing and pass <i>Offset</i> to the PCI Root Bridge I/O Protocol unchanged. Type <a href="#">EFI_PCI_IO_PASS_THROUGH_BAR</a> is defined in <a href="#">Section 14.4</a> .
<i>Offset</i>	The offset within the selected BAR to start the memory operation.
<i>Count</i>	The number of memory operations to perform. Bytes moved is <i>Width</i> size * <i>Count</i> , starting at <i>Offset</i> .
<i>Buffer</i>	For read operations, the destination buffer to store the results. For write operations, the source buffer to write data from.

### Description

The [Mem.Read\(\)](#), and [Mem.Write\(\)](#) functions enable a driver to access controller registers in the PCI memory space.



The I/O operations are carried out exactly as requested. The caller is responsible for any alignment and I/O width issues which the bus, device, platform, or type of I/O might require. For example on some platforms, width requests of **EfiPciloWidthUint64** do not work.

If *Width* is **EfiPciloWidthUint8**, **EfiPciloWidthUint16**, **EfiPciloWidthUint32**, or **EfiPciloWidthUint64**, then both *Address* and *Buffer* are incremented for each of the *Count* operations performed.

If *Width* is **EfiPciloWidthFifoUint8**, **EfiPciloWidthFifoUint16**, **EfiPciloWidthFifoUint32**, or **EfiPciloWidthFifoUint64**, then only *Buffer* is incremented for each of the *Count* operations performed. The read or write operation is performed *Count* times on the same *Address*.

If *Width* is **EfiPciloWidthFillUint8**, **EfiPciloWidthFillUint16**, **EfiPciloWidthFillUint32**, or **EfiPciloWidthFillUint64**, then only *Address* is incremented for each of the *Count* operations performed. The read or write operation is performed *Count* times from the first element of *Buffer*.

All the PCI transactions generated by this function are guaranteed to be completed before this function returns. All the PCI write transactions generated by this function will follow the write ordering and completion rules defined in the *PCI Specification*. However, if the memory-mapped I/O region being accessed by this function has the **EFI\_PCI\_ATTRIBUTE\_MEMORY\_CACHED** attribute set, then the transactions will follow the ordering rules defined by the processor architecture.

## Status Codes Returned

EFI_SUCCESS	The data was read from or written to the PCI controller.
EFI_INVALID_PARAMETER	<i>Width</i> is invalid.
EFI_INVALID_PARAMETER	<i>Buffer</i> is <b>NULL</b> .
EFI_UNSUPPORTED	<i>BarIndex</i> not valid for this PCI controller.
EFI_UNSUPPORTED	The address range specified by <i>Offset</i> , <i>Width</i> , and <i>Count</i> is not valid for the PCI BAR specified by <i>BarIndex</i> .
EFI_OUT_OF_RESOURCES	The request could not be completed due to a lack of resources.

## EFI\_PCI\_IO\_PROTOCOL.Io.Read() EFI\_PCI\_IO\_PROTOCOL.Io.Write()

### Summary

Enable a PCI driver to access PCI controller registers in the PCI I/O space.

### Prototype

```
typedef
EFI_STATUS
(EFI_API *EFI_PCI_IO_PROTOCOL_MEM) (
    IN EFI_PCI_IO_PROTOCOL *This,
    IN EFI_PCI_IO_PROTOCOL_WIDTH Width,
    IN UINT8 BarIndex,
    IN UINT64 Offset,
    IN UINTN Count,
    IN OUT VOID *Buffer
);
```

### Parameters

<i>This</i>	A pointer to the <a href="#">EFI_PCI_IO_PROTOCOL</a> instance. Type <a href="#">EFI_PCI_IO_PROTOCOL</a> is defined in <a href="#">Section 14.4</a> .
<i>Width</i>	Signifies the width of the memory operations. Type <a href="#">EFI_PCI_IO_PROTOCOL_WIDTH</a> is defined in <a href="#">Section 14.4</a> .
<i>BarIndex</i>	The BAR index in the standard PCI Configuration header to use as the base address for the I/O operation to perform. This allows all drivers to use BAR relative addressing. The legal range for this field is 0..5. However, the value <a href="#">EFI_PCI_IO_PASS_THROUGH_BAR</a> can be used to bypass the BAR relative addressing and pass <i>Offset</i> to the PCI Root Bridge I/O Protocol unchanged. Type <a href="#">EFI_PCI_IO_PASS_THROUGH_BAR</a> is defined in <a href="#">Section 14.4</a> .
<i>Offset</i>	The offset within the selected BAR to start the I/O operation.
<i>Count</i>	The number of I/O operations to perform. Bytes moved is <i>Width</i> size * <i>Count</i> , starting at <i>Offset</i> .
<i>Buffer</i>	For read operations, the destination buffer to store the results. For write operations, the source buffer to write data from.

### Description

The **Io.Read()**, and **Io.Write()** functions enable a driver to access PCI controller registers in PCI I/O space.

The I/O operations are carried out exactly as requested. The caller is responsible for any alignment and I/O width issues which the bus, device, platform, or type of I/O might require. For example on some platforms, width requests of **EfiPciloWidthUint64** do not work.

If *Width* is **EfiPciloWidthUint8**, **EfiPciloWidthUint16**, **EfiPciloWidthUint32**, or **EfiPciloWidthUint64**, then both *Address* and *Buffer* are incremented for each of the *Count* operations performed.

If *Width* is **EfiPciloWidthFifoUint8**, **EfiPciloWidthFifoUint16**, **EfiPciloWidthFifoUint32**, or **EfiPciloWidthFifoUint64**, then only *Buffer* is incremented for each of the *Count* operations performed. The read or write operation is performed *Count* times on the same *Address*.

If *Width* is **EfiPciloWidthFillUint8**, **EfiPciloWidthFillUint16**, **EfiPciloWidthFillUint32**, or **EfiPciloWidthFillUint64**, then only *Address* is incremented for each of the *Count* operations performed. The read or write operation is performed *Count* times from the first element of *Buffer*.

All the PCI transactions generated by this function are guaranteed to be completed before this function returns.

## Status Codes Returned

EFI_SUCCESS	The data was read from or written to the PCI controller.
EFI_INVALID_PARAMETER	<i>Width</i> is invalid.
EFI_INVALID_PARAMETER	<i>Buffer</i> is <b>NULL</b> .
EFI_UNSUPPORTED	<i>BarIndex</i> not valid for this PCI controller.
EFI_UNSUPPORTED	The address range specified by <i>Offset</i> , <i>Width</i> , and <i>Count</i> is not valid for the PCI BAR specified by <i>BarIndex</i> .
EFI_OUT_OF_RESOURCES	The request could not be completed due to a lack of resources.

## EFI\_PCI\_IO\_PROTOCOL.Pci.Read() EFI\_PCI\_IO\_PROTOCOL.Pci.Write()

### Summary

Enable a PCI driver to access PCI controller registers in PCI configuration space.

### Prototype

```
typedef
EFI_STATUS
(EFIAPI *EFI_PCI_IO_PROTOCOL_CONFIG) (
    IN EFI_PCI_IO_PROTOCOL *This,
    IN EFI_PCI_IO_PROTOCOL_WIDTH Width,
    IN UINT32      Offset,
    IN UINTN      Count,
    IN OUT VOID    *Buffer
);
```

### Parameters

<i>This</i>	A pointer to the <a href="#">EFI_PCI_IO_PROTOCOL</a> instance. Type <a href="#">EFI_PCI_IO_PROTOCOL</a> is defined in <a href="#">Section 14.4</a> .
<i>Width</i>	Signifies the width of the memory operations. Type <a href="#">EFI_PCI_IO_PROTOCOL_WIDTH</a> is defined in <a href="#">Section 14.4</a> .
<i>Offset</i>	The offset within the PCI configuration space for the PCI controller.
<i>Count</i>	The number of PCI configuration operations to perform. Bytes moved is <i>Width</i> size * <i>Count</i> , starting at <i>Offset</i> .
<i>Buffer</i>	For read operations, the destination buffer to store the results. For write operations, the source buffer to write data from.

### Description

The **Pci.Read()** and **Pci.Write()** functions enable a driver to access PCI configuration registers for the PCI controller.

The PCI Configuration operations are carried out exactly as requested. The caller is responsible for any alignment and I/O width issues which the bus, device, platform, or type of I/O might require. For example on some platforms, width requests of **EfiPciloWidthUint64** do not work.

If *Width* is **EfiPciloWidthUint8**, **EfiPciloWidthUint16**, **EfiPciloWidthUint32**, or **EfiPciloWidthUint64**, then both *Address* and *Buffer* are incremented for each of the *Count* operations performed.

If *Width* is **EfiPciloWidthFifoUint8**, **EfiPciloWidthFifoUint16**, **EfiPciloWidthFifoUint32**, or **EfiPciloWidthFifoUint64**, then only *Buffer* is incremented for each of the *Count*

operations performed. The read or write operation is performed *Count* times on the same *Address*.

If *Width* is **EfiPciloWidthFillUint8**, **EfiPciloWidthFillUint16**, **EfiPciloWidthFillUint32**, or **EfiPciloWidthFillUint64**, then only *Address* is incremented for each of the *Count* operations performed. The read or write operation is performed *Count* times from the first element of *Buffer*.

All the PCI transactions generated by this function are guaranteed to be completed before this function returns.

## Status Codes Returned

EFI_SUCCESS	The data was read from or written to the PCI controller.
EFI_INVALID_PARAMETER	<i>Width</i> is invalid.
EFI_INVALID_PARAMETER	<i>Buffer</i> is <b>NULL</b> .
EFI_UNSUPPORTED	The address range specified by <i>Offset</i> , <i>Width</i> , and <i>Count</i> is not valid for the PCI configuration header of the PCI controller.
EFI_OUT_OF_RESOURCES	The request could not be completed due to a lack of resources.

## EFI\_PCI\_IO\_PROTOCOL.CopyMem()

### Summary

Enables a PCI driver to copy one region of PCI memory space to another region of PCI memory space.

### Prototype

```
typedef
EFI_STATUS
(EFI_API *EFI_PCI_IO_PROTOCOL_COPY_MEM) (
    IN EFI_PCI_IO_PROTOCOL *This,
    IN EFI_PCI_IO_PROTOCOL_WIDTH Width,
    IN UINT8 DestBarIndex,
    IN UINT64 DestOffset,
    IN UINT8 SrcBarIndex,
    IN UINT64 SrcOffset,
    IN UINTN Count
);
```

### Parameters

<i>This</i>	A pointer to the <a href="#">EFI_PCI_IO_PROTOCOL</a> instance. Type <a href="#">EFI_PCI_IO_PROTOCOL</a> is defined in <a href="#">Section 14.4</a> .
<i>Width</i>	Signifies the width of the memory operations. Type <a href="#">EFI_PCI_IO_PROTOCOL_WIDTH</a> is defined in <a href="#">Section 14.4</a> .
<i>DestBarIndex</i>	The BAR index in the standard PCI Configuration header to use as the base address for the memory operation to perform. This allows all drivers to use BAR relative addressing. The legal range for this field is 0..5. However, the value <a href="#">EFI_PCI_IO_PASS_THROUGH_BAR</a> can be used to bypass the BAR relative addressing and pass <i>Offset</i> to the PCI Root Bridge I/O Protocol unchanged. Type <a href="#">EFI_PCI_IO_PASS_THROUGH_BAR</a> is defined in <a href="#">Section 14.4</a> .
<i>DestOffset</i>	The destination offset within the BAR specified by <i>DestBarIndex</i> to start the memory writes for the copy operation. The caller is responsible for aligning the <i>DestOffset</i> if required.
<i>SrcBarIndex</i>	The BAR index in the standard PCI Configuration header to use as the base address for the memory operation to perform. This allows all drivers to use BAR relative addressing. The legal range for this field is 0..5. However, the value <a href="#">EFI_PCI_IO_PASS_THROUGH_BAR</a> can be used to bypass the BAR relative addressing and pass <i>Offset</i> to the PCI Root Bridge I/O Protocol unchanged. Type <a href="#">EFI_PCI_IO_PASS_THROUGH_BAR</a> is defined in <a href="#">Section 14.4</a> .

<i>SrcOffset</i>	The source offset within the BAR specified by <i>SrcBarIndex</i> to start the memory reads for the copy operation. The caller is responsible for aligning the <i>SrcOffset</i> if required.
<i>Count</i>	The number of memory operations to perform. Bytes moved is <i>Width</i> size * <i>Count</i> , starting at <i>DestOffset</i> and <i>SrcOffset</i> .

## Description

The **CopyMem()** function enables a PCI driver to copy one region of PCI memory space to another region of PCI memory space on a PCI controller. This is especially useful for video scroll operations on a memory mapped video buffer.

The memory operations are carried out exactly as requested. The caller is responsible for satisfying any alignment and memory width restrictions that a PCI controller on a platform might require. For example on some platforms, width requests of **EfiPciloWidthUint64** do not work.

If *Width* is **EfiPciloWidthUint8**, **EfiPciloWidthUint16**, **EfiPciloWidthUint32**, or **EfiPciloWidthUint64**, then *Count* read/write transactions are performed to move the contents of the *SrcOffset* buffer to the *DestOffset* buffer. The implementation must be reentrant, and it must handle overlapping *SrcOffset* and *DestOffset* buffers. This means that the implementation of **CopyMem()** must choose the correct direction of the copy operation based on the type of overlap that exists between the *SrcOffset* and *DestOffset* buffers. If either the *SrcOffset* buffer or the *DestOffset* buffer crosses the top of the processor's address space, then the result of the copy operation is unpredictable.

The contents of the *DestOffset* buffer on exit from this service must match the contents of the *SrcOffset* buffer on entry to this service. Due to potential overlaps, the contents of the *SrcOffset* buffer may be modified by this service. The following rules can be used to guarantee the correct behavior:

- If  $DestOffset > SrcOffset$  and  $DestOffset < (SrcOffset + Width\ size * Count)$ , then the data should be copied from the *SrcOffset* buffer to the *DestOffset* buffer starting from the end of buffers and working toward the beginning of the buffers.
- Otherwise, the data should be copied from the *SrcOffset* buffer to the *DestOffset* buffer starting from the beginning of the buffers and working toward the end of the buffers.

All the PCI transactions generated by this function are guaranteed to be completed before this function returns. All the PCI write transactions generated by this function will follow the write ordering and completion rules defined in the *PCI Specification*. However, if the memory-mapped I/O region being accessed by this function has the **EFI\_PCI\_ATTRIBUTE\_MEMORY\_CACHED** attribute set, then the transactions will follow the ordering rules defined by the processor architecture.

## Status Codes Returned

EFI_SUCCESS	The data was copied from one memory region to another memory region.
EFI_INVALID_PARAMETER	<i>Width</i> is invalid.

EFI_UNSUPPORTED	<i>DestBarIndex</i> not valid for this PCI controller.
EFI_UNSUPPORTED	<i>SrcBarIndex</i> not valid for this PCI controller.
EFI_UNSUPPORTED	The address range specified by <i>DestOffset</i> , <i>Width</i> , and <i>Count</i> is not valid for the PCI BAR specified by <i>DestBarIndex</i> .
EFI_UNSUPPORTED	The address range specified by <i>SrcOffset</i> , <i>Width</i> , and <i>Count</i> is not valid for the PCI BAR specified by <i>SrcBarIndex</i> .
EFI_OUT_OF_RESOURCES	The request could not be completed due to a lack of resources.



## EFI\_PCI\_IO\_PROTOCOL.Map()

### Summary

Provides the PCI controller-specific addresses needed to access system memory.

### Prototype

```
typedef
EFI_STATUS
(EFI_API *EFI_PCI_IO_PROTOCOL_MAP) (
  IN EFI_PCI_IO_PROTOCOL *This,
  IN EFI_PCI_IO_PROTOCOL_OPERATION Operation,
  IN VOID *HostAddress,
  IN OUT UINTN *NumberOfBytes,
  OUT EFI_PHYSICAL_ADDRESS *DeviceAddress,
  OUT VOID **Mapping
);
```

### Parameters

<i>This</i>	A pointer to the <a href="#">EFI_PCI_IO_PROTOCOL</a> instance. Type <a href="#">EFI_PCI_IO_PROTOCOL</a> is defined in <a href="#">Section 14.4</a> .
<i>Operation</i>	Indicates if the bus master is going to read or write to system memory. Type <a href="#">EFI_PCI_IO_PROTOCOL_OPERATION</a> is defined in <a href="#">Section 14.4</a> .
<i>HostAddress</i>	The system memory address to map to the PCI controller.
<i>NumberOfBytes</i>	On input the number of bytes to map. On output the number of bytes that were mapped.
<i>DeviceAddress</i>	The resulting map address for the bus master PCI controller to use to access the hosts <i>HostAddress</i> . Type <a href="#">EFI_PHYSICAL_ADDRESS</a> is defined in <a href="#">EFI_BOOT_SERVICES.AllocatePool()</a> . This address cannot be used by the processor to access the contents of the buffer specified by <i>HostAddress</i> .
<i>Mapping</i>	A resulting value to pass to <a href="#">Unmap()</a> .

### Description

The [Map\(\)](#) function provides the PCI controller-specific addresses needed to access system memory. This function is used to map system memory for PCI bus master DMA accesses.

All PCI bus master accesses must be performed through their mapped addresses and such mappings must be freed with [Unmap\(\)](#) when complete. If the bus master access is a single read or write data transfer, then [EfiPciloOperationBusMasterRead](#) or [EfiPciloOperation-BusMasterWrite](#) is used and the range is unmapped to complete the operation. If performing an [EfiPciloOperationBusMasterRead](#) operation, all the data must be present in system memory before the [Map\(\)](#) is performed. Similarly, if

performing an **EfiPciloOperation-BusMasterWrite**, the data cannot be properly accessed in system memory until **Unmap()** is performed.

Bus master operations that require both read and write access or require multiple host device interactions within the same mapped region must use **EfiPciloOperation-BusMasterCommonBuffer**. However, only memory allocated via the **AllocateBuffer()** interface can be mapped for this operation type.

In all mapping requests the resulting *NumberOfBytes* actually mapped may be less than the requested amount. In this case, the DMA operation will have to be broken up into smaller chunks. The **Map()** function will map as much of the DMA operation as it can at one time. The caller may have to loop on **Map()** and **Unmap()** in order to complete a large DMA transfer.

### Status Codes Returned

EFI_SUCCESS	The range was mapped for the returned <i>NumberOfBytes</i> .
EFI_INVALID_PARAMETER	<i>Operation</i> is invalid.
EFI_INVALID_PARAMETER	<i>HostAddress</i> is <b>NULL</b> .
EFI_INVALID_PARAMETER	<i>NumberOfBytes</i> is <b>NULL</b> .
EFI_INVALID_PARAMETER	<i>DeviceAddress</i> is <b>NULL</b> .
EFI_INVALID_PARAMETER	<i>Mapping</i> is <b>NULL</b> .
EFI_UNSUPPORTED	The <i>HostAddress</i> cannot be mapped as a common buffer.
EFI_DEVICE_ERROR	The system hardware could not map the requested address.
EFI_OUT_OF_RESOURCES	The request could not be completed due to a lack of resources.

## EFI\_PCI\_IO\_PROTOCOL.Unmap()

### Summary

Completes the [Map\(\)](#) operation and releases any corresponding resources.

### Prototype

```
typedef
EFI_STATUS
(EFI_API *EFI_PCI_IO_PROTOCOL_UNMAP) (
  IN EFI_PCI_IO_PROTOCOL *This,
  IN VOID      *Mapping
);
```

### Parameters

*This*

A pointer to the [EFI PCI IO PROTOCOL](#) instance. Type [EFI\\_PCI\\_IO\\_PROTOCOL](#) is defined in [Section 14.4](#).

*Mapping*

The mapping value returned from [Map\(\)](#).

### Description

The [Unmap\(\)](#) function completes the [Map\(\)](#) operation and releases any corresponding resources. If the operation was an [EfiPciloOperationBusMasterWrite](#), the data is committed to the target system memory. Any resources used for the mapping are freed.

### Status Codes Returned

EFI_SUCCESS	The range was unmapped.
EFI_DEVICE_ERROR	The data was not committed to the target system memory.

## EFI\_PCI\_IO\_PROTOCOL.AllocateBuffer()

### Summary

Allocates pages that are suitable for an **EfiPciIoOperationBusMasterCommonBuffer** mapping.

### Prototype

```
typedef
EFI_STATUS
(EFI_API *EFI_PCI_IO_PROTOCOL_ALLOCATE_BUFFER) (
  IN EFI_PCI_IO_PROTOCOL *This,
  IN EFI_ALLOCATE_TYPE Type,
  IN EFI_MEMORY_TYPE MemoryType,
  IN UINTN Pages,
  OUT VOID **HostAddress,
  IN UINT64 Attributes
);
```

### Parameters

<i>This</i>	A pointer to the <a href="#">EFI_PCI_IO_PROTOCOL</a> instance. Type <b>EFI_PCI_IO_PROTOCOL</b> is defined in <a href="#">Section 14.4</a> .
<i>Type</i>	This parameter is not used and must be ignored.
<i>MemoryType</i>	The type of memory to allocate, <b>EfiBootServicesData</b> or <b>EfiRuntimeServicesData</b> . Type <a href="#">EFI_MEMORY_TYPE</a> is defined in <a href="#">EFI_BOOT_SERVICES.AllocatePages()</a> .
<i>Pages</i>	The number of pages to allocate.
<i>HostAddress</i>	A pointer to store the base system memory address of the allocated range.
<i>Attributes</i>	The requested bit mask of attributes for the allocated range. Only the attributes <b>EFI_PCI_ATTRIBUTE_MEMORY_WRITE_COMBINE</b> , and <b>EFI_PCI_ATTRIBUTE_MEMORY_CACHED</b> may be used with this function. If any other bits are set, then <b>EFI_UNSUPPORTED</b> is returned. This function may choose to ignore this bit mask. The <b>EFI_PCI_ATTRIBUTE_MEMORY_WRITE_COMBINE</b> , and <b>EFI_PCI_ATTRIBUTE_MEMORY_CACHED</b> attributes provide a hint to the implementation that may improve the performance of the calling driver. The implementation may choose any default for the memory attributes including write combining, cached, both, or neither as long as the allocated buffer can be seen equally by both the processor and the PCI bus master.

## Description

The **AllocateBuffer()** function allocates pages that are suitable for an **EfiPciIoOperationBusMasterCommonBuffer** mapping. This means that the buffer allocated by this function must support simultaneous access by both the processor and a PCI Bus Master. The device address that the PCI Bus Master uses to access the buffer can be retrieved with a call to **Map()**.

If the current attributes of the PCI controller has the **EFI\_PCI\_IO\_ATTRIBUTE\_DUAL\_ADDRESS\_CYCLE** bit set, then when the buffer allocated by this function is mapped with a call to **Map()**, the device address that is returned by **Map()** must be within the 64-bit device address space of the PCI Bus Master. The attributes for a PCI controller can be managed by calling **Attributes()**.

If the current attributes for the PCI controller has the **EFI\_PCI\_IO\_ATTRIBUTE\_DUAL\_ADDRESS\_CYCLE** bit clear, then when the buffer allocated by this function is mapped with a call to **Map()**, the device address that is returned by **Map()** must be within the 32-bit device address space of the PCI Bus Master. The attributes for a PCI controller can be managed by calling **Attributes()**.

If the memory allocation specified by *MemoryType* and *Pages* cannot be satisfied, then **EFI\_OUT\_OF\_RESOURCES** is returned.

## Status Codes Returned

EFI_SUCCESS	The requested memory pages were allocated.
EFI_INVALID_PARAMETER	<i>MemoryType</i> is invalid.
EFI_INVALID_PARAMETER	<i>HostAddress</i> is <b>NULL</b> .
EFI_UNSUPPORTED	<i>Attributes</i> is unsupported. The only legal attribute bits are <b>MEMORY_WRITE_COMBINE</b> and <b>MEMORY_CACHED</b> .
EFI_OUT_OF_RESOURCES	The memory pages could not be allocated.

## EFI\_PCI\_IO\_PROTOCOL.FreeBuffer()

### Summary

Frees memory that was allocated with [AllocateBuffer\(\)](#).

### Prototype

```
typedef
EFI_STATUS
(EFI_API *EFI_PCI_IO_PROTOCOL_FREE_BUFFER) (
    IN EFI_PCI_IO_PROTOCOL *This,
    IN UINTN    Pages,
    IN VOID    *HostAddress
);
```

### Parameters

<i>This</i>	A pointer to the <a href="#">EFI_PCI_IO_PROTOCOL</a> instance. Type <a href="#">EFI_PCI_IO_PROTOCOL</a> is defined in <a href="#">Section 14.4</a> .
<i>Pages</i>	The number of pages to free.
<i>HostAddress</i>	The base system memory address of the allocated range.

### Description

The **FreeBuffer()** function frees memory that was allocated with **AllocateBuffer()**.

### Status Codes Returned

EFI_SUCCESS	The requested memory pages were freed.
EFI_INVALID_PARAMETER	The memory range specified by <i>HostAddress</i> and <i>Pages</i> was not allocated with <b>AllocateBuffer()</b> .

## EFI\_PCI\_IO\_PROTOCOL.Flush()

### Summary

Flushes all PCI posted write transactions from a PCI host bridge to system memory.

### Prototype

```
typedef
EFI_STATUS
(EFIAPI *EFI_PCI_IO_PROTOCOL_FLUSH) (
    IN EFI_PCI_IO_PROTOCOL *This
);
```

### Parameters

*This* A pointer to the [EFI\\_PCI\\_IO\\_PROTOCOL](#) instance. Type [EFI\\_PCI\\_IO\\_PROTOCOL](#) is defined in [Section 14.4](#).

### Description

The **Flush()** function flushes any PCI posted write transactions from a PCI host bridge to system memory. Posted write transactions are generated by PCI bus masters when they perform write transactions to target addresses in system memory.

This function does not flush posted write transactions from any PCI bridges. A PCI controller specific action must be taken to guarantee that the posted write transactions have been flushed from the PCI controller and from all the PCI bridges into the PCI host bridge. This is typically done with a PCI read transaction from the PCI controller prior to calling **Flush()**.

If the PCI controller specific action required to flush the PCI posted write transactions has been performed, and this function returns **EFI\_SUCCESS**, then the PCI bus master's view and the processor's view of system memory are guaranteed to be coherent. If the PCI posted write transactions cannot be flushed from the PCI host bridge, then the PCI bus master and processor are not guaranteed to have a coherent view of system memory, and **EFI\_DEVICE\_ERROR** is returned.

### Status Codes Returned

EFI_SUCCESS	The PCI posted write transactions were flushed from the PCI host bridge to system memory.
EFI_DEVICE_ERROR	The PCI posted write transactions were not flushed from the PCI host bridge due to a hardware error.

## EFI\_PCI\_IO\_PROTOCOL.GetLocation()

### Summary

Retrieves this PCI controller’s current PCI bus number, device number, and function number.

### Prototype

```
typedef
EFI_STATUS
(EFIAPI *EFI_PCI_IO_PROTOCOL_GET_LOCATION) (
    IN EFI_PCI_IO_PROTOCOL *This,
    OUT UINTN *SegmentNumber,
    OUT UINTN *BusNumber,
    OUT UINTN *DeviceNumber,
    OUT UINTN *FunctionNumber
);
```

### Parameters

- This* A pointer to the [EFI PCI IO PROTOCOL](#) instance. Type [EFI\\_PCI\\_IO\\_PROTOCOL](#) is defined in [Section 14.4](#).
- SegmentNumber* The PCI controller’s current PCI segment number.
- BusNumber* The PCI controller’s current PCI bus number.
- DeviceNumber* The PCI controller’s current PCI device number.
- FunctionNumber* The PCI controller’s current PCI function number.

### Description

The **GetLocation()** function retrieves a PCI controller’s current location on a PCI Host Bridge. This is specified by a PCI segment number, PCI bus number, PCI device number, and PCI function number. These values can be used with the PCI Root Bridge I/O Protocol to perform PCI configuration cycles on the PCI controller, or any of its peer PCI controller’s on the same PCI Host Bridge.

### Status Codes Returned

EFI_SUCCESS	The PCI controller location was returned.
EFI_INVALID_PARAMETER	SegmentNumber is <b>NULL</b> .
EFI_INVALID_PARAMETER	BusNumber is <b>NULL</b> .
EFI_INVALID_PARAMETER	DeviceNumber is <b>NULL</b> .
EFI_INVALID_PARAMETER	FunctionNumber is <b>NULL</b> .



## EFI\_PCI\_IO\_PROTOCOL.Attributes()

### Summary

Performs an operation on the attributes that this PCI controller supports. The operations include getting the set of supported attributes, retrieving the current attributes, setting the current attributes, enabling attributes, and disabling attributes.

### Prototype

```
typedef
EFI_STATUS
(EFIAPI *EFI_PCI_IO_PROTOCOL_ATTRIBUTES) (
    IN EFI_PCI_IO_PROTOCOL      *This,
    IN EFI_PCI_IO_PROTOCOL_ATTRIBUTE_OPERATION Operation,
    IN UINT64                   Attributes,
    OUT UINT64                  *Result OPTIONAL
);
```

### Parameters

<i>This</i>	A pointer to the <a href="#">EFI_PCI_IO_PROTOCOL</a> instance. Type <a href="#">EFI_PCI_IO_PROTOCOL</a> is defined in <a href="#">Section 14.4</a> .
<i>Operation</i>	The operation to perform on the attributes for this PCI controller. Type <a href="#">EFI_PCI_IO_PROTOCOL_ATTRIBUTE_OPERATION</a> is defined in “Related Definitions” below.
<i>Attributes</i>	The mask of attributes that are used for <b>Set</b> , <b>Enable</b> , and <b>Disable</b> operations. The available attributes are listed in <a href="#">Section 14.4</a> .
<i>Result</i>	A pointer to the result mask of attributes that are returned for the <b>Get</b> and <b>Supported</b> operations. This is an optional parameter that may be <b>NULL</b> for the <b>Set</b> , <b>Enable</b> , and <b>Disable</b> operations. The available attributes are listed in <a href="#">Section 14.4</a> .

### Related Definitions

```
/**
//*****
// EFI_PCI_IO_PROTOCOL_ATTRIBUTE_OPERATION
//*****
typedef enum {
    EfiPciloAttributeOperationGet,
    EfiPciloAttributeOperationSet,
    EfiPciloAttributeOperationEnable,
    EfiPciloAttributeOperationDisable,
    EfiPciloAttributeOperationSupported,
    EfiPciloAttributeOperationMaximum
} EFI_PCI_IO_PROTOCOL_ATTRIBUTE_OPERATION;
```

**EfiPciloAttributeOperationGet**

Retrieve the PCI controller's current attributes, and return them in *Result*. If *Result* is **NULL**, then **EFI\_INVALID\_PARAMETER** is returned. For this operation, *Attributes* is ignored.

**EfiPciloAttributeOperationSet**

Set the PCI controller's current attributes to *Attributes*. If a bit is set in *Attributes* that is not supported by this PCI controller or one of its parent bridges, then **EFI\_UNSUPPORTED** is returned. For this operation, *Result* is an optional parameter that may be **NULL**.

**EfiPciloAttributeOperationEnable**

Enable the attributes specified by the bits that are set in *Attributes* for this PCI controller. Bits in *Attributes* that are clear are ignored. If a bit is set in *Attributes* that is not supported by this PCI controller or one of its parent bridges, then **EFI\_UNSUPPORTED** is returned. For this operation, *Result* is an optional parameter that may be **NULL**.

**EfiPciloAttributeOperationDisable**

Disable the attributes specified by the bits that are set in *Attributes* for this PCI controller. Bits in *Attributes* that are clear are ignored. If a bit is set in *Attributes* that is not supported by this PCI controller or one of its parent bridges, then **EFI\_UNSUPPORTED** is returned. For this operation, *Result* is an optional parameter that may be **NULL**.

**EfiPciloAttributeOperationSupported**

Retrieve the PCI controller's supported attributes, and return them in *Result*. If *Result* is **NULL**, then **EFI\_INVALID\_PARAMETER** is returned. For this operation, *Attributes* is ignored.

**Description**

The **Attributes()** function performs an operation on the attributes associated with this PCI controller. If *Operation* is greater than or equal to the maximum operation value, then **EFI\_INVALID\_PARAMETER** is returned. If *Operation* is **Get** or **Supported**, and *Result* is **NULL**, then **EFI\_INVALID\_PARAMETER** is returned. If *Operation* is **Set**, **Enable**, or **Disable** for an attribute that is not supported by the PCI controller, then **EFI\_UNSUPPORTED** is returned. Otherwise, the operation is performed as described in "Related Definitions" and **EFI\_SUCCESS** is returned. It is possible for this function to return **EFI\_UNSUPPORTED** even if the PCI controller supports the attribute. This can occur when the PCI root bridge does not support the attribute. For example, if VGA I/O and VGA Memory transactions cannot be forwarded onto PCI root bridge #2, then a request by a PCI VGA driver to enable the **VGA\_IO** and **VGA\_MEMORY** bits will fail even though a PCI VGA controller behind PCI root bridge #2 is able to decode these transactions.

This function will also return **EFI\_UNSUPPORTED** if more than one PCI controller on the same PCI root bridge has already successfully requested one of the ISA addressing attributes. For example, if one PCI VGA controller had already requested the **VGA\_IO** and **VGA\_MEMORY** attributes, then a second PCI VGA controller on the same root bridge

cannot succeed in requesting those same attributes. This restriction applies to the ISA-, VGA-, and IDE-related attributes.

### Status Codes Returned

EFI_SUCCESS	The operation on the PCI controller's attributes was completed. If the operation was <b>Get</b> or <b>Supported</b> , then the attribute mask is returned in <i>Result</i> .
EFI_INVALID_PARAMETER	<i>Operation</i> is greater than or equal to <b>EfiPciloAttributeOperationMaximum</b> .
EFI_INVALID_PARAMETER	<i>Operation</i> is <b>Get</b> and <i>Result</i> is <b>NULL</b> .
EFI_INVALID_PARAMETER	<i>Operation</i> is <b>Supported</b> and <i>Result</i> is <b>NULL</b> .
EFI_UNSUPPORTED	<i>Operation</i> is <b>Set</b> , and one or more of the bits set in <i>Attributes</i> are not supported by this PCI controller or one of its parent bridges.
EFI_UNSUPPORTED	<i>Operation</i> is <b>Enable</b> , and one or more of the bits set in <i>Attributes</i> are not supported by this PCI controller or one of its parent bridges.
EFI_UNSUPPORTED	<i>Operation</i> is <b>Disable</b> , and one or more of the bits set in <i>Attributes</i> are not supported by this PCI controller or one of its parent bridges.

## EFI\_PCI\_IO\_PROTOCOL.GetBarAttributes()

### Summary

Gets the attributes that this PCI controller supports setting on a BAR using [SetBarAttributes\(\)](#), and retrieves the list of resource descriptors for a BAR.

### Prototype

```
typedef
EFI_STATUS
(EFI_API *EFI_PCI_IO_PROTOCOL_GET_BAR_ATTRIBUTES) (
    IN EFI_PCI_IO_PROTOCOL *This,
    IN UINT8 BarIndex,
    OUT UINT64 *Supports OPTIONAL,
    OUT VOID **Resources OPTIONAL
);
```

### Parameters

<i>This</i>	A pointer to the <a href="#">EFI_PCI_IO_PROTOCOL</a> instance. Type <a href="#">EFI_PCI_IO_PROTOCOL</a> is defined in <a href="#">Section 14.4</a> .
<i>BarIndex</i>	The BAR index of the standard PCI Configuration header to use as the base address for resource range. The legal range for this field is 0..5.
<i>Supports</i>	A pointer to the mask of attributes that this PCI controller supports setting for this BAR with <a href="#">SetBarAttributes()</a> . The list of attributes is listed in <a href="#">Section 14.4</a> . This is an optional parameter that may be <b>NULL</b> .
<i>Resources</i>	A pointer to the resource descriptors that describe the current configuration of this BAR of the PCI controller. This buffer is allocated for the caller with the Boot Service <a href="#">EFI_BOOT_SERVICES.AllocatePool()</a> . It is the caller's responsibility to free the buffer with the Boot Service <a href="#">EFI_BOOT_SERVICES.FreePool()</a> . See "Related Definitions" below for the resource descriptors that may be used. This is an optional parameter that may be <b>NULL</b> .

### Related Definitions

There are only two resource descriptor types from the *ACPI Specification* that may be used to describe the current resources allocated to BAR of a PCI Controller. These are the QWORD Address Space Descriptor, and the End Tag. The QWORD Address Space Descriptor can describe memory, I/O, and bus number ranges for dynamic or fixed resources. The configuration of a BAR of a PCI Controller is described with one or more QWORD Address Space Descriptors followed by an End Tag. [Table 121](#) and [Table 122](#) contain these two descriptor types. Please see the *ACPI Specification* for details on the field values. The *ACPI Specification* does not define how to use the Address Translation Offset for non-bridge devices. The UEFI Specification is extending the definition of Address Translation Offset to support systems that have different mapping

for HostAddress and DeviceAddress. The definition of the Address Space Granularity field in the QWORD Address Space Descriptor differs from the *ACPI Specification* and the definition in [Table 121](#) is the one that must be used.

**Table 121. QWORD Address Space Descriptor**

Byte Offset	Byte Length	Data	Description
0x00	0x01	0x8A	QWORD Address Space Descriptor
0x01	0x02	0x2B	Length of this descriptor in bytes not including the first two fields
0x03	0x01		Resource Type 0 – Memory Range 1 – I/O Range 2 – Bus Number Range
0x04	0x01		General Flags
0x05	0x01		Type Specific Flags
0x06	0x08		Address Space Granularity. Used to differentiate between a 32-bit memory request and a 64-bit memory request. For a 32-bit memory request, this field should be set to 32. For a 64-bit memory request, this field should be set to 64.
0x0E	0x08		Address Range Minimum. Starting address of BAR.
0x16	0x08		Address Range Maximum. Ending address of BAR.
0x1E	0x08		Address Translation Offset. Offset to apply to the Starting address of a BAR to convert it to a PCI address. This value is zero unless the HostAddress and DeviceAddress for the BAR are different.
0x26	0x08		Address Length

**Table 122. End Tag**

Byte Offset	Byte Length	Data	Description
0x00	0x01	0x79	End Tag
0x01	0x01	0x00	Checksum. If 0, then checksum is assumed to be valid.

## Description

The **GetBarAttributes()** function returns in *Supports* the mask of attributes that the PCI controller supports setting for the BAR specified by *BarIndex*. It also returns in *Resources* a list of resource descriptors for the BAR specified by *BarIndex*. Both *Supports* and *Resources* are optional parameters. If both *Supports* and *Resources* are **NULL**, then **EFI\_INVALID\_PARAMETER** is returned. It is the caller's responsibility to free *Resources* with the Boot Service [EFI\\_BOOT\\_SERVICES.FreePool\(\)](#) when the caller is done with the contents of *Resources*. If there are not enough resources to allocate *Resources*, then **EFI\_OUT\_OF\_RESOURCES** is returned.

If a bit is set in *Supports*, then the PCI controller supports this attribute type for the BAR specified by *BarIndex*, and a call can be made to [SetBarAttributes\(\)](#) using that attribute type.

### Status Codes Returned

EFI_SUCCESS	If <i>Supports</i> is not <b>NULL</b> , then the attributes that the PCI controller supports are returned in <i>Supports</i> . If <i>Resources</i> is not <b>NULL</b> , then the resource descriptors that the PCI controller is currently using are returned in <i>Resources</i> .
EFI_OUT_OF_RESOURCES	There are not enough resources available to allocate <i>Resources</i> .
EFI_UNSUPPORTED	<i>BarIndex</i> not valid for this PCI controller.
EFI_INVALID_PARAMETER	Both <i>Supports</i> and <i>Attributes</i> are <b>NULL</b> .

## EFI\_PCI\_IO\_PROTOCOL.SetBarAttributes()

### Summary

Sets the attributes for a range of a BAR on a PCI controller.

### Prototype

```
typedef
EFI_STATUS
(EFIAPI *EFI_PCI_IO_PROTOCOL_SET_BAR_ATTRIBUTES) (
  IN EFI_PCI_IO_PROTOCOL *This,
  IN UINT64   Attributes,
  IN UINT8   BarIndex,
  IN OUT UINT64   *Offset,
  IN OUT UINT64   *Length
);
```

### Parameters

<i>This</i>	A pointer to the <a href="#">EFI PCI IO PROTOCOL</a> instance. Type <a href="#">EFI_PCI_IO_PROTOCOL</a> is defined in <a href="#">Section 14.4</a> .
<i>Attributes</i>	The mask of attributes to set for the resource range specified by <i>BarIndex</i> , <i>Offset</i> , and <i>Length</i> .
<i>BarIndex</i>	The BAR index of the standard PCI Configuration header to use as the base address for the resource range. The legal range for this field is 0..5.
<i>Offset</i>	A pointer to the BAR relative base address of the resource range to be modified by the attributes specified by <i>Attributes</i> . On return, <i>*Offset</i> will be set to the actual base address of the resource range. Not all resources can be set to a byte boundary, so the actual base address may differ from the one passed in by the caller.
<i>Length</i>	A pointer to the length of the resource range to be modified by the attributes specified by <i>Attributes</i> . On return, <i>*Length</i> will be set to the actual length of the resource range. Not all resources can be set to a byte boundary, so the actual length may differ from the one passed in by the caller.

### Description

The **SetBarAttributes()** function sets the attributes specified in *Attributes* for the PCI controller on the resource range specified by *BarIndex*, *Offset*, and *Length*. Since the granularity of setting these attributes may vary from resource type to resource type, and from platform to platform, the actual resource range and the one passed in by the caller may differ. As a result, this function may set the attributes specified by *Attributes* on a larger resource range than the caller requested. The actual range is returned in *Offset* and *Length*. The caller is responsible for verifying that the actual range for which the attributes were set is acceptable.

If the attributes are set on the PCI controller, then the actual resource range is returned in *Offset* and *Length*, and **EFI\_SUCCESS** is returned. Many of the attribute types also require that the state of the PCI Host Bus Controller and the state of any PCI to PCI bridges between the PCI Host Bus Controller and the PCI Controller to be modified. This function will only return **EFI\_SUCCESS** if all of these state changes are made. The PCI Controller may support a combination of attributes, but unless the PCI Host Bus Controller and the PCI to PCI bridges also support that same combination of attributes, then this call will return an error.

If the attributes specified by *Attributes*, or the resource range specified by *BarIndex*, *Offset*, and *Length* are not supported by the PCI controller, then **EFI\_UNSUPPORTED** is returned. The set of supported attributes for the PCI controller can be found by calling [GetBarAttributes\(\)](#).

If either *Offset* or *Length* is **NULL** then **EFI\_INVALID\_PARAMETER** is returned.

If there are not enough resources available to set the attributes, then **EFI\_OUT\_OF\_RESOURCES** is returned.

### Status Codes Returned

EFI_SUCCESS	The set of attributes specified by <i>Attributes</i> for the resource range specified by <i>BarIndex</i> , <i>Offset</i> , and <i>Length</i> were set on the PCI controller, and the actual resource range is returned in <i>Offset</i> and <i>Length</i> .
EFI_UNSUPPORTED	The set of attributes specified by <i>Attributes</i> is not supported by the PCI controller for the resource range specified by <i>BarIndex</i> , <i>Offset</i> , and <i>Length</i> .
EFI_INVALID_PARAMETER	<i>Offset</i> is <b>NULL</b> .
EFI_INVALID_PARAMETER	<i>Length</i> is <b>NULL</b> .
EFI_OUT_OF_RESOURCES	There are not enough resources to set the attributes on the resource range specified by <i>BarIndex</i> , <i>Offset</i> , and <i>Length</i> .

#### 14.4.1 PCI Device Paths

An [EFI\\_PCI\\_IO\\_PROTOCOL](#) must be installed on a handle for its services to be available to PCI device drivers. In addition to the [EFI\\_PCI\\_IO\\_PROTOCOL](#), an [EFI\\_DEVICE\\_PATH\\_PROTOCOL](#) must also be installed on the same handle (see chapter 9).

Typically, an ACPI Device Path Node is used to describe a PCI Root Bridge. Depending on the bus hierarchy in the system, additional device path nodes may precede this ACPI Device Path Node. A PCI device path is described with PCI Device Path Nodes. There will be one PCI Device Path node for the PCI controller itself, and one PCI Device Path Node for each PCI to PCI Bridge that is between the PCI controller and the PCI Root Bridge.

[Table 123](#) shows an example device path for a PCI controller that is located at PCI device number 0x07 and PCI function 0x00, and is directly attached to a PCI root bridge. This



device path consists of an ACPI Device Path Node, a PCI Device Path Node, and a Device Path End Structure. The `_HID` and `_UID` must match the ACPI table description of the PCI Root Bridge. The shorthand notation for this device path is:

**ACPI(PNP0A03,0)/PCI(7,0).**

**Table 123. PCI Device 7, Function 0 on PCI Root Bridge 0**

Byte Offset	Byte Length	Data	Description
0x00	0x01	0x02	Generic Device Path Header – Type ACPI Device Path
0x01	0x01	0x01	Sub type – ACPI Device Path
0x02	0x02	0x0C	Length – 0x0C bytes
0x04	0x04	0x41D0, 0x0A03	<code>_HID</code> PNP0A03 – 0x41D0 represents the compressed string ‘PNP’ and is encoded in the low order bytes. The compression method is described in the ACPI Specification.
0x08	0x04	0x0000	<code>_UID</code>
0x0C	0x01	0x01	<b>Generic Device Path Header</b> – Type Hardware Device Path
0x0D	0x01	0x01	Sub type – PCI
0x0E	0x02	0x06	Length – 0x06 bytes
0x10	0x01	0x00	PCI Function
0x11	0x01	0x07	PCI Device
0x12	0x01	0xFF	<b>Generic Device Path Header</b> – Type End of Hardware Device Path
0x13	0x01	0xFF	Sub type – End of Entire Device Path
0x14	0x02	0x04	Length – 0x04 bytes

[Table 124](#) shows an example device path for a PCI controller that is located behind a PCI to PCI bridge at PCI device number 0x07 and PCI function 0x00. The PCI to PCI bridge is directly attached to a PCI root bridge, and it is at PCI device number 0x05 and PCI function 0x00. This device path consists of an ACPI Device Path Node, two PCI Device Path Nodes, and a Device Path End Structure. The `_HID` and `_UID` must match the ACPI table description of the PCI Root Bridge. The shorthand notation for this device path is:

**ACPI(PNP0A03,0)/PCI(5,0)/PCI(7,0).**

**Table 124. PCI Device 7, Function 0 behind PCI to PCI bridge**

Byte Offset	Byte Length	Data	Description
0x00	0x01	0x02	Generic Device Path Header – Type ACPI Device Path
0x01	0x01	0x01	Sub type – ACPI Device Path
0x02	0x02	0x0C	Length – 0x0C bytes
0x04	0x04	0x41D0, 0x0A03	_HID PNPOA03 – 0x41D0 represents the compressed string ‘PNP’ and is encoded in the low order bytes. The compression method is described in the ACPI Specification.
0x08	0x04	0x0000	_UID
0x0C	0x01	0x01	<b>Generic Device Path Header</b> – Type Hardware Device Path
0x0D	0x01	0x01	Sub type – PCI
0x0E	0x02	0x06	Length – 0x06 bytes
0x10	0x01	0x00	PCI Function
0x11	0x01	0x05	PCI Device
0x12	0x01	0x01	<b>Generic Device Path Header</b> – Type Hardware Device Path
0x13	0x01	0x01	Sub type – PCI
0x14	0x02	0x06	Length – 0x06 bytes
0x16	0x01	0x00	PCI Function
0x17	0x01	0x07	PCI Device
0x18	0x01	0xFF	<b>Generic Device Path Header</b> – Type End of Hardware Device Path
0x19	0x01	0xFF	Sub type – End of Entire Device Path
0x1A	0x02	0x04	Length – 0x04 bytes

### 14.4.2 PCI Option ROMs

EFI takes advantage of both the *PCI Firmware Specification* and the *PE/COFF Specification* to store EFI images in a PCI Option ROM. There are several rules that must be followed when constructing a PCI Option ROM:

- A PCI Option ROM can be no larger than 16 MiB.
- A PCI Option ROM may contain one or more images.
- Each image must be on a 512-byte boundary.
- Each image must be an even multiple of 512 bytes in length. This means that images that are not an even multiple of 512 bytes in length must be padded to the next 512-byte boundary.
- Legacy Option ROM images begin with a Standard PCI Expansion ROM Header ([Table 125](#)).
- EFI Option ROM images begin with an EFI PCI Expansion ROM Header ([Table 129](#)).
- Each image must contain a PCIR data structure in the first 64 KiB of the image.
- The image data for an EFI Option ROM image must begin in the first 64 KiB of the image.

- The image data for an EFI Option ROM image must be a PE/COFF image or a compressed PE/COFF image following the UEFI Compression Algorithm, and referencing [Appendix H](#) for the Compression Source Code.
- The PCIR data structure must begin on a 4-byte boundary.
- If the PCI Option ROM contains a Legacy Option ROM image, it must be the first image.
- The images are placed in the PCI Option ROM in order from highest to lowest priority. This priority is used to build the ordered list of Driver Image Handles that are produced by the Bus Specific Driver Override Protocol for a PCI Controller.
- When PCI device provides an EFI option ROM that is signed in accordance with Chapter 27, use of UEFI Compression Algorithm storage option is preferred. When performing signature validation upon compressed driver, the size returned by **EFI\_DECOMPRESS\_PROTOCOL.GetInfo()** will be used as driver size and input to signature validation process. Thus any post-driver padding required to reach exact multiple of 512 bytes per [Figure 51](#) is ignored by signature validation.
- When PCI device provides an EFI option ROM that is signed in accordance with Chapter 27 and stored uncompressed, the end of the driver for signature validation will be assumed to be the 512-byte boundary indicated by the 'Initialization Size' value in the EFI PCI Expansion ROM Header (see [Table 127](#)). As the signed driver may not exactly fill the indicated 'Initialization Size', it is recommended that the value 'Offset to EFI Image' (also [Table 127](#)) be adjusted to ensure the last byte of the signed, uncompressed driver, coincides with the end of the ROM as indicated by 'Initialization Size'. And any required padding bytes are to be inserted ahead of the signed uncompressed driver image.

There are several options available when building a PCI option ROM for a PCI adapter. A PCI Option ROM can choose to support only a legacy PC-AT platform, only an EFI compliant platform, or both. This flexibility allows a migration path from adapters that support only legacy PC-AT platforms, to adapters that support both PC-AT platforms and EFI compliant platforms, to adapters that support only EFI compliant platforms. The following is a list of the image combinations that may be placed in a PCI option ROM. This is not an exhaustive list. Instead, it provides what will likely be the most common PCI option ROM layouts. EFI compliant system firmware must work with all of these PCI option ROM layouts, plus any other layouts that are possible within the *PCI Firmware Specification*. The format of a Legacy Option ROM image is defined in the *PCI Firmware Specification*.

- Legacy Option ROM image
- Legacy Option ROM image + IA-32 EFI driver
- Legacy Option ROM image + Itanium Processor Family EFI driver
- Legacy Option ROM image + IA-32 EFI driver + Itanium Processor Family EFI driver
- Legacy Option ROM image + IA-32 EFI driver + x64 EFI driver
- Legacy Option ROM image + EBC Driver
- IA-32 UEFI driver
- Itanium Processor Family EFI driver

- IA-32 UEFI driver + Itanium Processor Family EFI driver
- EBC Driver

In addition to combinations of UEFI drivers with different processor binding, it is also possible to include multiple drivers of different function but the same processor binding. When processing option ROM contents, all drivers of appropriate processor binding type must be loaded and added to ordered list of drivers previously mentioned.

It is also possible to place a application written to this specification in a PCI Option ROM. However, the PCI Bus Driver will ignore these images. The exact mechanism by which applications can be loaded and executed from a PCI Option ROM is outside the scope of this document.

**Table 125. Standard PCI Expansion ROM Header (Example from PCI Firmware Specification 3.0)**

Offset	Byte Length	Value	Description
0x00	1	0x55	ROM Signature, byte 1
0x01	1	0xAA	ROM Signature, byte 2
0x02-0x17	22	XX	Reserved per processor architecture unique data
0x18-0x19	2	XX	Pointer to PCIR Data Structure

**Table 126. PCI Expansion ROM Code Types (Example from PCI Firmware Specification 3.0)**

Code Type	Description
0x00	IA-32, PC-AT compatible
0x01	Open Firmware standard for PCI
0x02	Hewlett-Packard PA RISC
0x03	EFI Image
0x04-0xFF	Reserved

**Table 127. EFI PCI Expansion ROM Header**

Offset	Byte Length	Value	Description
0x00	1	0x55	ROM Signature, byte 1
0x01	1	0xAA	ROM Signature, byte 2
0x02	2	XXXX	Initialization Size – size of this image in units of 512 bytes. The size includes this header.
0x04	4	0x0EF1	Signature from EFI image header
0x08	2	XX	Subsystem value for EFI image header
0x0a	2	XX	Machine type from EFI image header
0x0c	2	XX	Compression type 0x0000 - The image is uncompressed 0x0001 - The image is compressed. See the UEFI Compression Algorithm and <a href="#">Appendix H</a> . 0x0002 - 0xFFFF - Reserved
0x0e	8	0x00	Reserved
0x16	2	XX	Offset to EFI Image
0x18	2	XX	Offset to PCIR Data Structure

#### 14.4.2.1 PCI Bus Driver Responsibilities

A PCI Bus Driver must scan a PCI Option ROM for PCI Device Drivers. If a PCI Option ROM is found during PCI Enumeration, then a copy of the PCI Option ROM is placed in a memory buffer. The PCI Bus Driver will use the memory copy of the PCI Option ROM to search for UEFI drivers after PCI Enumeration. The PCI Bus Driver will search the list of

images in a PCI Option ROM for the ones that have a Code Type of 0x03 in the PCIR Data Structure, and a Signature of 0xEF1 in the EFI PCI Expansion ROM Header. Then, it will examine the Subsystem Type of the EFI PCI Expansion ROM Header. If the Subsystem Type is **IMAGE\_SUBSYSTEM\_EFI\_BOOT\_SERVICE\_DRIVER**(11) or **IMAGE\_SUBSYSTEM\_EFI\_RUNTIME\_DRIVER**(12), then the PCI Bus Driver can load the PCI Device Driver from the PCI Option ROM. The Offset to EFI Image Header field of the EFI PCI Expansion ROM Header is used to get a pointer to the beginning of the PE/COFF image in the PCI Option ROM. The PE/COFF image may have been compressed using the UEFI Compression Algorithm. If it has been compressed, then the PCI Bus Driver must decompress the driver to a memory buffer. The Boot Service [EFI\\_BOOT\\_SERVICES.LoadImage\(\)](#) can then be used to load the driver. All UEFI driver images discovered in the PCI Option ROM and meeting these requirements must be processed and loaded via **LoadImage()**. If the platform does not support the Machine Type of the driver, then **LoadImage()** may fail.

It is the PCI Bus Driver's responsibility to verify that the Expansion ROM Header and PCIR Data Structure are valid. It is the responsibility of the Boot Service **LoadImage()** to verify that the PE/COFF image is valid. The Boot Service **LoadImage()** may fail for several reasons including a corrupt PE/COFF image or an unsupported Machine Type.

If a PCI Option ROM contains one or more UEFI images, then the PCI Bus Driver must install an instance of the **EFI\_LOAD\_FILE2\_PROTOCOL** on the PCI controller handle. Then, when the PCI Bus Driver loads a PE/COFF image from a PCI Option ROM using the Boot Service **LoadImage()**, the PCI Bus Driver must provide the device path of the image being loaded. The device path of an image loaded from a PCI Option ROM must be the device path to the PCI Controller to which the PCI Option ROM is attached followed by a Relative Offset Range node. The Starting Offset field of the Relative Offset Range node must be the byte offset from the beginning of the PCI Option ROM to the beginning of the EFI Option ROM image, and the Ending Offset field of the Relative Offset Range node must be the byte offset from the beginning of the PCI Option ROM to the end of the EFI Option ROM image. The table below shows an example device path for an EFI driver loaded from a PCI Option ROM. The EFI Driver starts at offset 0x8000 into the PCI Option ROM and is 0x2000 bytes long. The shorthand notation for this device path is:

**PciRoot(0)/PCI(5,0)/PCI(7,0)/ Offset(0x8000,0x9FFF)****Table 128. Device Path for an EFI Driver loaded from PCI Option ROM**

Byte Offset	Byte Length	Data	Description
0x00	0x01	0x02	<b>Generic Device Path Header</b> – Type ACPI Device Path
0x01	0x01	0x01	Sub type – ACPI Device Path
0x02	0x02	0x0C	Length – 0x0C bytes
0x04	0x04	0x41D0, 0x0A03	_HID PNP0A03 – 0x41D0 represents the compressed string ‘PNP’ and is encoded in the low order bytes. The compression method is described in the ACPI Specification.
0x08	0x04	0x0000	_UID
0x0C	0x01	0x01	<b>Generic Device Path Header</b> – Type Hardware Device Path
0x0D	0x01	0x01	Sub type – PCI
0x0E	0x02	0x06	Length – 0x06 bytes
0x10	0x01	0x00	PCI Function
0x11	0x01	0x05	PCI Device
0x12	0x01	0x01	<b>Generic Device Path Header</b> – Type Hardware Device Path
0x13	0x01	0x01	Sub type – PCI
0x14	0x02	0x06	Length – 0x06 bytes
0x16	0x01	0x00	PCI Function
0x17	0x01	0x07	PCI Device
0x18	0x01	0x04	<b>Generic Device Path Header</b> – Type Media Device Path
0x19	0x01	0x08	Sub type – Relative Offset Range
0x1A	0x02	0x14	Length – 0x14 bytes
0x1C	0x08	0x8000	Start Address – Offset into PCI Option ROM
0x24	0x08	0x9FFF	End Address – Offset into PCI Option ROM
0x2C	0x01	0xFF	<b>Generic Device Path Header</b> – Type End of Hardware Device Path
0x2D	0x01	0xFF	Sub type – End of Entire Device Path
0x2E	0x02	0x04	Length – 0x04 bytes

The PCI Option ROM search may produce one or more Driver Image Handles for the PCI Controller that is associated with the PCI Option ROM. The PCI Bus Driver is responsible for producing a Bus Specific Driver Override Protocol instance for every PCI Controller has a PCI Option ROM that contains one or more UEFI Drivers. The Bus Specific Driver Override Protocol produces an ordered list of Driver Image Handles. The order that the UEFI Drivers are placed in the PCI Option ROM is the order of Driver Image Handles that must be returned by the Bus Specific Driver Override Protocol. This gives the party that builds the PCI Option ROM control over the order that the drivers are used in the Boot Service [EFI\\_BOOT\\_SERVICES.ConnectController\(\)](#).

### 14.4.2.2 PCI Device Driver Responsibilities

A PCI Device Driver should not be designed to care where it is stored. It can reside in a PCI Option ROM, the system's motherboard ROM, a hard drive, a CD-ROM drive, etc. All PCI Device Drivers are compiled and linked to generate a PE/COFF image. When a PE/COFF image is placed in a PCI Option ROM, it must follow the rules outlined in [Section 14.4.2](#). The recommended image layout is to insert an EFI PCI Expansion ROM Header and a PCIR Data Structure in front of the PE/COFF image, and pad the entire image up to the next 512-byte boundary. [Figure 51](#) shows the format of a single PCI Device Driver that can be added to a PCI Option ROM.

Following are recommended layouts and flow charts for various types of driver signage and compression states for PCI device driver images. [Figure 51](#) shows an unsigned layout.

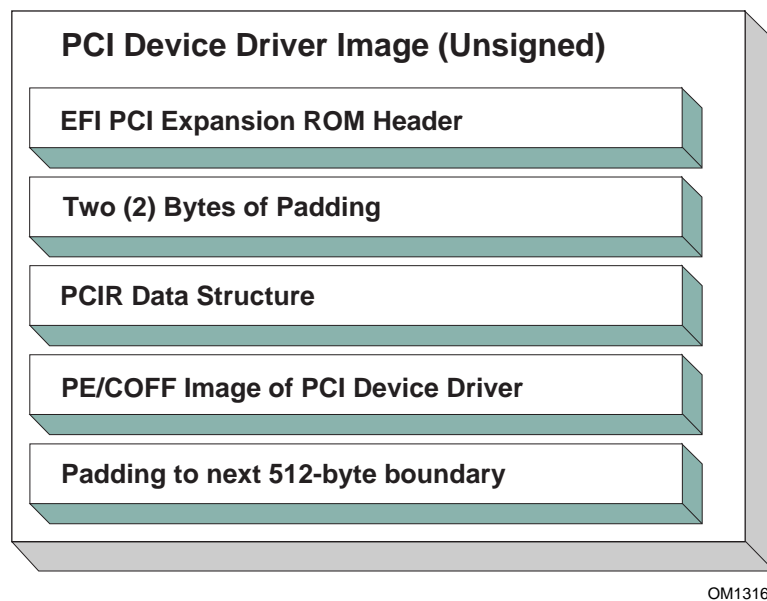

Figure 51. Unsigned PCI Driver Image Layout

[Figure 52](#) and [Figure 53](#) show a signed and compressed PCI device driver image flow chart and layout, respectively.



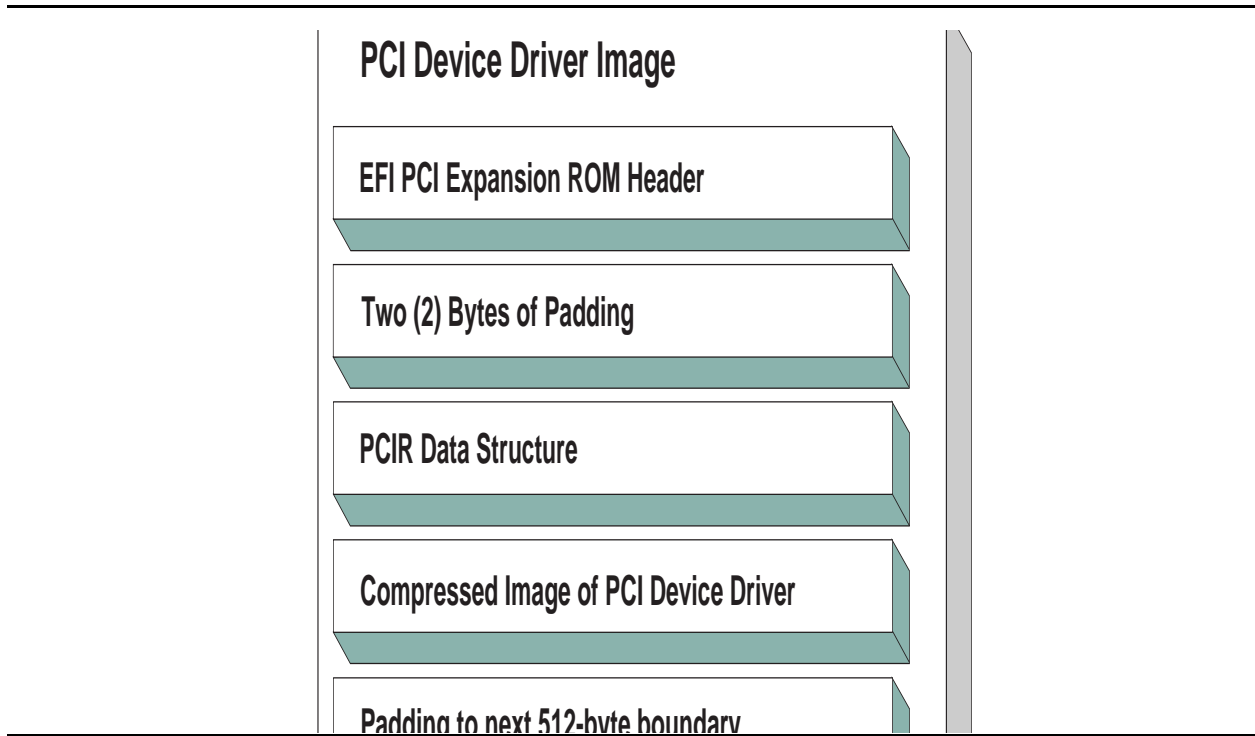

Figure 52. Signed and Compressed PCI Driver Image Flow

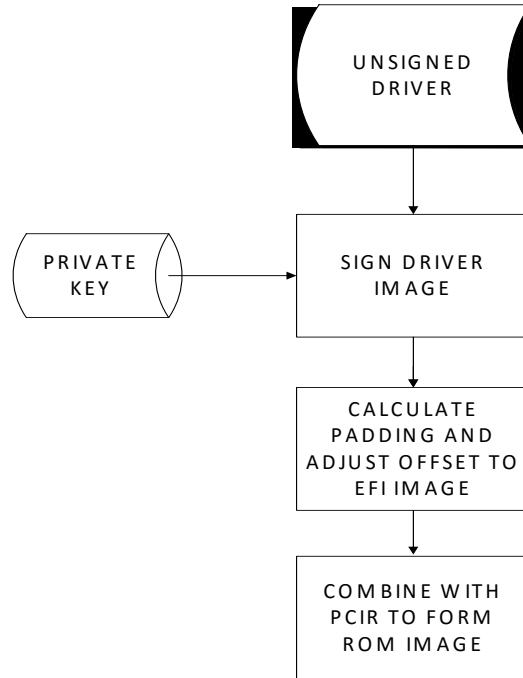

**Figure 53. Signed and Compressed PCI Driver Image Layout**

[Figure 54](#) and [Figure 55](#) show a signed but not compressed flow chart and a signed and uncompressed PCI device driver image layout, respectively.

---

SIGNED BUT NOT COMPRESSED



---

Figure 54. Signed but not Compressed PCI Driver Image Flow

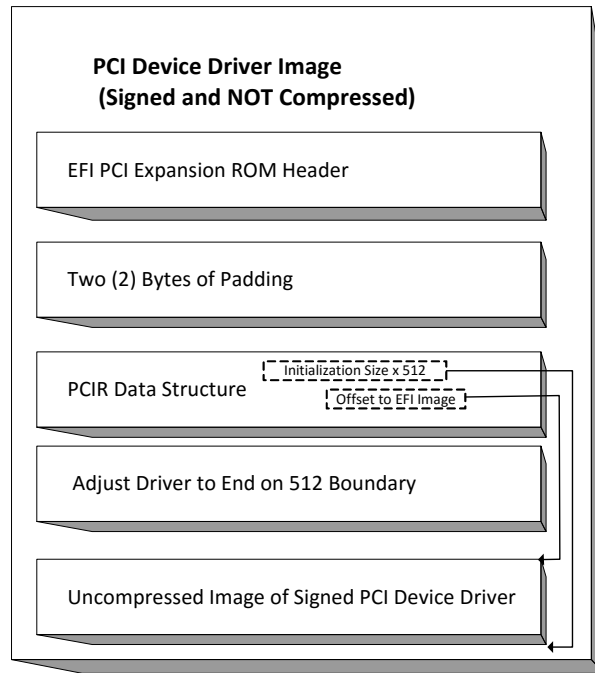

**Figure 55. Signed and Uncompressed PCI Driver Image Layout**

The field values for the EFI PCI Expansion ROM Header and the PCIR Data Structure would be as follows in this recommended PCI Driver image layout. An image must start at a 512-byte boundary, and the end of the image must be padded to the next 512-byte boundary.

Table 129. Recommended PCI Device Driver Layout

Offset	Byte Length	Value	Description
0x00	1	0x55	ROM Signature, byte 1
0x01	1	0xAA	ROM Signature, byte 2
0x02	2	XXXX	Initialization Size – size of this image in units of 512 bytes. The size includes this header
0x04	4	0x0EF1	Signature from EFI image header
0x08	2	XX 0x0B 0x0C	Subsystem Value from the PCI Driver's PE/COFF Image Header Subsystem Value for an EFI Boot Service Driver Subsystem Value for an EFI Runtime Driver
0x0a	2	XX 0x014C 0x0200 0x0EBC 0x8664 0x01c2 0xAA64	Machine type from the PCI Driver's PE/COFF Image Header IA-32 Machine Type Itanium processor type EFI Byte Code (EBC) Machine Type X64 Machine Type ARM Machine Type ARM 64-bit Machine Type
0x0C	2	XXXX 0x0000 0x0001	Compression Type Uncompressed Compressed following the UEFI Compression Algorithm.
0x0E	8	0x00	Reserved
0x16	2	0x0034	Offset to EFI Image
0x18	2	0x001C	Offset to PCIR Data Structure
0x1A	2	0x0000	Padding to align PCIR Data Structure on a 4 byte boundary
0x1C	4	'PCIR'	PCIR Data Structure Signature
0x20	2	XXXX	Vendor ID from the PCI Controller's Configuration Header
0x22	2	XXXX	Device ID from the PCI Controller's Configuration Header
0x24	2	0x0000	Reserved
0x26	2	0x0018	The length if the PCIR Data Structure in bytes
0x28	1	0x00	PCIR Data Structure Revision. Value for PCI 2.2 Option ROM
0x29	3	XXXX	Class Code from the PCI Controller's Configuration Header
0x2C	2	XXXX	Code Image Length in units of 512 bytes. Same as Initialization Size
0x2E	2	XXXX	Revision Level of the Code/Data. This field is ignored
0x30	1	0x03	Code Type
0x31	1	XX	Indicator. Bit 7 clear means another image follows. Bit 7 set means that this image is the last image in the PCI Option ROM. Bits 0–6 are reserved.
		0x00 0x80	Additional images follow this image in the PCI Option ROM This image is the last image in the PCI Option ROM
0x32	2	0x0000	Reserved
0x34	X	XXXX	The beginning of the PCI Device Driver's PE/COFF Image

### 14.4.3 Nonvolatile Storage

A PCI adapter may contain some form of nonvolatile storage. Since there are no standard access mechanisms for nonvolatile storage on PCI adapters, the PCI I/O Protocol does not provide any services for nonvolatile storage. However, a PCI Device Driver may choose to implement its own access mechanisms. If there is a private channel between a PCI Controller and a nonvolatile storage device, a PCI Device Driver can use it for configuration options or vital product data.

**Note:** *The fields **RomImage** and **RomSize** in the PCI I/O Protocol do not provide direct access to the PCI Option ROM on a PCI adapter. Instead, they provide access to a copy of the PCI Option ROM in memory. If the contents of the **RomImage** are modified, only the memory copy is updated. If a vendor wishes to update the contents of a PCI Option ROM, they must provide their own utility or driver to perform this task. There is no guarantee that the BAR for the PCI Option ROM is valid at the time that the utility or driver may execute, so the utility or driver must provide the code required to gain write access to the PCI Option ROM contents. The algorithm for gaining write access to a PCI Option ROM is both platform specific and adapter specific, so it is outside the scope of this document.*

### 14.4.4 PCI Hot-Plug Events

It is possible to design a PCI Bus Driver to work with PCI Bus that conforms to the PCI Hot-Plug Specification. There are two levels of functionality that could be provided in the preboot environment. The first is to initialize the PCI Hot-Plug capable bus so it can be used by an operating system that also conforms to the PCI Hot-Plug Specification. This only affects the PCI Enumeration that is performed in either the PCI Bus Driver's initialization, or a firmware component that executes prior to the PCI Bus Driver's initialization. None of the PCI Device Drivers need to be aware of the fact that a PCI Controller may exist in a slot that is capable of a hot-plug event. Also, the addition, removal, and replacement of PCI adapters in the preboot environment would not be allowed.

The second level of functionality is to actually implement the full hot-plug capability in the PCI Bus Driver. This is not recommended because it adds a great deal of complexity to the PCI Bus Driver design with very little added value. However, there is nothing about the PCI Driver Model that would preclude this implementation. It would require using an event based periodic timer to monitor the hot-plug capable slots, and take advantage of the [EFI\\_BOOT\\_SERVICES.ConnectController\(\)](#) and [EFI\\_BOOT\\_SERVICES.DisconnectController\(\)](#) Boot Services to dynamically start and stop the drivers that manage the PCI controller that is being added, removed, or replaced. If the [EFI\\_BOOT\\_SERVICES.DisconnectController\(\)](#) Boot Service fails it must be retried via a periodic timer.

## 15 Protocols — SCSI Driver Models and Bus Support

---

The intent of this chapter is to specify a method of providing direct access to SCSI devices. These protocols provide services that allow a generic driver to produce the Block I/O protocol for SCSI disk devices, and allows an EFI utility to issue commands to any SCSI device. The main reason to provide such an access is to enable S.M.A.R.T. functionality during POST (i.e., issuing Mode Sense, Mode Select, and Log Sense to SCSI devices). This is accomplished by using a generic API such as SCSI Pass Thru. The use of this method will enable additional functionality in the future without modifying the EFI SCSI Pass Thru driver. SCSI Pass Thru is not limited to SCSI channels. It is applicable to all channel technologies that utilize SCSI commands such as SCSI, ATAPI, and Fibre Channel. This chapter describes the SCSI Driver Model. This includes the behavior of SCSI Bus Drivers, the behavior of SCSI Device Drivers, and a detailed description of the SCSI I/O Protocol. This chapter provides enough material to implement a SCSI Bus Driver, and the tools required to design and implement SCSI Device Drivers. It does not provide any information on specific SCSI devices.

### 15.1 SCSI Driver Model Overview

The EFI SCSI Driver Stack includes the SCSI Pass Thru Driver, SCSI Bus Driver and individual SCSI Device Drivers.

**SCSI Pass Thru Driver:** A SCSI Pass Through Driver manages a SCSI Host Controller that contains one or more SCSI Buses. It creates SCSI Bus Controller Handles for each SCSI Bus, and attaches Extended SCSI Pass Thru Protocol and Device Path Protocol to each handle the driver produced. Please refer to [Section 15.7](#) and [Appendix G](#) for details about the Extended SCSI Pass Thru Protocol.

**SCSI Bus Driver:** A SCSI Bus Driver manages a SCSI Bus Controller Handle that is created by SCSI Pass Thru Driver. It creates SCSI Device Handles for each SCSI Device Controller detected during SCSI Bus Enumeration, and attaches SCSI I/O Protocol and Device Path Protocol to each handle the driver produced.

**SCSI Device Driver:** A SCSI Device Driver manages one kind of SCSI Device. Device handles for SCSI Devices are created by SCSI Bus Drivers. A SCSI Device Driver could be a bus driver itself, and may create child handles. But most SCSI Device Drivers will be device drivers that do not create new handles. For the pure device driver, it attaches protocol instance to the device handle of the SCSI Device. These protocol instances are I/O abstractions that allow the SCSI Device to be used in the pre-boot environment. The most common I/O abstractions are used to boot an EFI compliant OS.

### 15.2 SCSI Bus Drivers

A SCSI Bus Driver manages a SCSI Bus Controller Handle. A SCSI Bus Controller Handle is created by a SCSI Pass Thru Driver and is abstracted in software with the Extended SCSI Pass Thru Protocol. A SCSI Bus Driver will manage handles that contain this protocol.

[Figure 56](#) shows an example device handle for a SCSI Bus handle. It contains a Device Path Protocol instance and a Extended SCSI Pass Thru Protocol Instance.

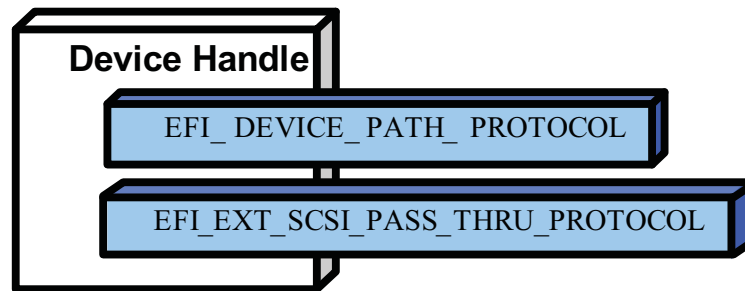

Figure 56. Device Handle for a SCSI Bus Controller

### 15.2.1 Driver Binding Protocol for SCSI Bus Drivers

The Driver Binding Protocol contains three services. These are **Supported()**, **Start()**, and **Stop()**. **Supported()** tests to see if the SCSI Bus Driver can manage a device handle. A SCSI Bus Driver can only manage device handle that contain the Device Path Protocol and the Extended SCSI Pass Thru Protocol, so a SCSI Bus Driver must look for these two protocols on the device handle that is being tested.

The **Start()** function tells the SCSI Bus Driver to start managing a device handle. The device handle should support the protocols shown in [Figure 56](#). The Extended SCSI Pass Thru Protocol provides information about a SCSI Channel and the ability to communicate with any SCSI devices attached to that SCSI Channel.

The SCSI Bus Driver has the option of creating all of its children in one call to **Start()**, or spreading it across several calls to **Start()**. In general, if it is possible to design a bus driver to create one child at a time, it should do so to support the rapid boot capability in the UEFI Driver Model. Each of the child device handles created in **Start()** must contain a Device Path Protocol instance, and a SCSI I/O protocol instance. The SCSI I/O Protocol is described in [Section 15.4](#) and [Section 14.4](#). The format of device paths for SCSI Devices is described in [Section 15.5](#). [Figure 57](#) shows an example child device handle that is created by a SCSI Bus Driver for a SCSI Device.



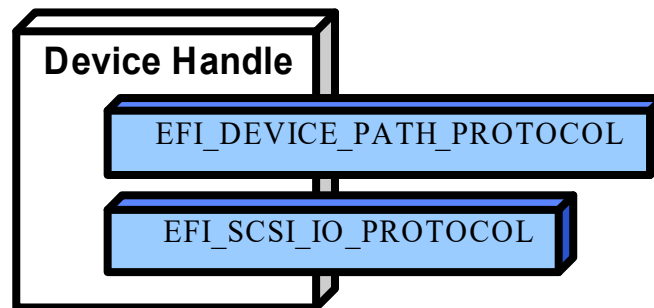

Figure 57. Child Handle Created by a SCSI Bus Driver

A SCSI Bus Driver must perform several steps to manage a SCSI Bus.

1. Scan for the SCSI Devices on the SCSI Channel that connected to the SCSI Bus Controller. If a request is being made to scan only one SCSI Device, then only looks for the one specified. Create a device handle for the SCSI Device found.
2. Install a Device Path Protocol instance and a SCSI I/O Protocol instance on the device handle created for each SCSI Device.

The **Stop()** function tells the SCSI Bus Driver to stop managing a SCSI Bus. The **Stop()** function can destroy one or more of the device handles that were created on a previous call to **Start()**. If all of the child device handles have been destroyed, then **Stop()** will place the SCSI Bus Controller in a quiescent state. The functionality of **Stop()** mirrors **Start()**.

## 15.2.2 SCSI Enumeration

The purpose of the SCSI Enumeration is only to scan for the SCSI Devices attached to the specific SCSI channel. The SCSI Bus driver need not allocate resources for SCSI Devices (like PCI Bus Drivers do), nor need it connect a SCSI Device with its Device Driver (like USB Bus Drivers do). The details of the SCSI Enumeration is implementation specific, thus is out of the scope of this document.

## 15.3 SCSI Device Drivers

SCSI Device Drivers manage SCSI Devices. Device handles for SCSI Devices are created by SCSI Bus Drivers. A SCSI Device Driver could be a bus driver itself, and may create child handles. But most SCSI Device Drivers will be device drivers that do not create new handles. For the pure device driver, it attaches protocol instance to the device handle of the SCSI Device. These protocol instances are I/O abstractions that allow the SCSI Device to be used in the pre-boot environment. The most common I/O abstractions are used to boot an EFI compliant OS.

### 15.3.1 Driver Binding Protocol for SCSI Device Drivers

The Driver Binding Protocol contains three services. These are **Supported()**, **Start()**, and **Stop()**. **Supported()** tests to see if the SCSI Device Driver can manage a device handle. A

SCSI Device Driver can only manage device handle that contain the Device Path Protocol and the SCSI I/O Protocol, so a SCSI Device Driver must look for these two protocols on the device handle that is being tested. In addition, it needs to check to see if the device handle represents a SCSI Device that SCSI Device Driver knows how to manage. This is typically done by using the services of the SCSI I/O Protocol to see whether the device information retrieved is supported by the device driver.

The **Start()** function tells the SCSI Device Driver to start managing a SCSI Device. A SCSI Device Driver could be a bus driver itself, and may create child handles. But most SCSI Device Drivers will be device drivers that do not create new handles. For the pure device driver, it installs one or more addition protocol instances on the device handle for the SCSI Device.

The **Stop()** function mirrors the **Start()** function, so the **Stop()** function completes any outstanding transactions to the SCSI Device and removes the protocol interfaces that were installed in **Start()**.

## 15.4 EFI SCSI I/O Protocol

This section defines the EFI SCSI I/O protocol. This protocol is used by code, typically drivers, running in the EFI boot services environment to access SCSI devices. In particular, functions for managing devices on SCSI buses are defined here.

The interfaces provided in the **EFI\_SCSI\_IO\_PROTOCOL** are for performing basic operations to access SCSI devices.

### EFI\_SCSI\_IO\_PROTOCOL

This section provides a detailed description of the **EFI\_SCSI\_IO\_PROTOCOL**.

#### Summary

Provides services to manage and communicate with SCSI devices.

## GUID

```
#define EFI_SCSI_IO_PROTOCOL_GUID \
{0x932f47e6,0x2362,0x4002,\
{0x80,0x3e,0x3c,0xd5,0x4b,0x13,0x8f,0x85}}
```

## Protocol Interface Structure

```
typedef struct _EFI_SCSI_IO_PROTOCOL {
  EFI_SCSI_IO_PROTOCOL_GET_DEVICE_TYPE  GetDeviceType;
  EFI_SCSI_IO_PROTOCOL_GET_DEVICE_LOCATION  GetDeviceLocation;
  EFI_SCSI_IO_PROTOCOL_RESET_BUS  ResetBus;
  EFI_SCSI_IO_PROTOCOL_RESET_DEVICE  ResetDevice;
  EFI_SCSI_IO_PROTOCOL_EXECUTE_SCSI_COMMAND  ExecuteScsiCommand;
  UINT32  IoAlign;
} EFI_SCSI_IO_PROTOCOL;
```

## Parameters

<i>IoAlign</i>	Supplies the alignment requirement for any buffer used in a data transfer. <i>IoAlign</i> values of 0 and 1 mean that the buffer can be placed anywhere in memory. Otherwise, <i>IoAlign</i> must be a power of 2, and the requirement is that the start address of a buffer must be evenly divisible by <i>IoAlign</i> with no remainder.
<i>GetDeviceType</i>	Retrieves the information of the device type which the SCSI device belongs to. See <a href="#">GetDeviceType()</a> .
<i>GetDeviceLocation</i>	Retrieves the device location information in the SCSI bus. See <a href="#">GetDeviceLocation()</a> .
<i>ResetBus</i>	Resets the entire SCSI bus the SCSI device attaches to. See <a href="#">ResetBus()</a> .
<i>ResetDevice</i>	Resets the SCSI Device that is specified by the device handle the SCSI I/O protocol attaches. See <a href="#">ResetDevice()</a> .
<i>ExecuteScsiCommand</i>	Sends a SCSI command to the SCSI device and waits for the execution completion until an exit condition is met, or a timeout occurs. See <a href="#">ExecuteScsiCommand()</a> .

## Description

The **EFI\_SCSI\_IO\_PROTOCOL** provides the basic functionalities to access and manage a SCSI Device. There is one **EFI\_SCSI\_IO\_PROTOCOL** instance for each SCSI Device on a SCSI Bus. A device driver that wishes to manage a SCSI Device in a system will have to retrieve the **EFI\_SCSI\_IO\_PROTOCOL** instance that is associated with the SCSI Device. A device handle for a SCSI Device will minimally contain an **EFI\_DEVICE\_PATH\_PROTOCOL** instance and an **EFI\_SCSI\_IO\_PROTOCOL** instance.

## EFI\_SCSI\_IO\_PROTOCOL.GetDeviceType()

### Summary

Retrieves the device type information of the SCSI Device.

### Prototype

```
typedef
EFI_STATUS
(EFI_API *EFI_SCSI_IO_PROTOCOL_GET_DEVICE_TYPE) (
  IN EFI_SCSI_IO_PROTOCOL *This,
  OUT UINT8 *DeviceType
);
```

### Parameters

<i>This</i>	A pointer to the <b>EFI_SCSI_IO_PROTOCOL</b> instance. Type <b>EFI_SCSI_IO_PROTOCOL</b> is defined in <a href="#">EFI_SCSI_IO_PROTOCOL</a> .
<i>DeviceType</i>	A pointer to the device type information retrieved from the SCSI Device. See “Related Definitions” for the possible returned values of this parameter.

### Description

This function is used to retrieve the SCSI device type information. This function is typically used for SCSI Device Drivers to quickly recognize whether the SCSI Device could be managed by it.

If *DeviceType* is **NULL**, then **EFI\_INVALID\_PARAMETER** is returned. Otherwise, the device type is returned in *DeviceType* and **EFI\_SUCCESS** is returned.

### Related Definitions

```
//Defined in the SCSI Primary Commands standard (e.g., SPC-4)
//
#define EFI_SCSI_IO_TYPE_DISK 0x00 // Disk device
#define EFI_SCSI_IO_TYPE_TAPE 0x01 // Tape device
#define EFI_SCSI_IO_TYPE_PRINTER 0x02 // Printer
#define EFI_SCSI_IO_TYPE_PROCESSOR 0x03 // Processor
#define EFI_SCSI_IO_TYPE_WORM 0x04 // Write-once read-multiple
#define EFI_SCSI_IO_TYPE_CDROM 0x05 // CD or DVD device
#define EFI_SCSI_IO_TYPE_SCANNER 0x06 // Scanner device
#define EFI_SCSI_IO_TYPE_OPTICAL 0x07 // Optical memory device
#define EFI_SCSI_IO_TYPE_MEDIUMCHANGER 0x08 // Medium Changer device
#define EFI_SCSI_IO_TYPE_COMMUNICATION 0x09 // Communications device
#define MFI_SCSI_IO_TYPE_A 0x0A // Obsolete
#define MFI_SCSI_IO_TYPE_B 0x0B // Obsolete
#define MFI_SCSI_IO_TYPE_RAID 0x0C // Storage array controller
// device (e.g., RAID)
```

```

#define MFI_SCSI_IO_TYPE_SES  0x0D // Enclosure services device
#define MFI_SCSI_IO_TYPE_RBC  0x0E // Simplified direct-access
    // device (e.g., magnetic
    // disk)
#define MFI_SCSI_IO_TYPE_OCRW 0x0F // Optical card reader/
    // writer device
#define MFI_SCSI_IO_TYPE_BRIDGE 0x10 // Bridge Controller
    // Commands
#define MFI_SCSI_IO_TYPE OSD  0x11 // Object-based Storage
    // Device
#define EFI_SCSI_IO_TYPE_RESERVED_LOW 0x12 // Reserved (low)
#define EFI_SCSI_IO_TYPE_RESERVED_HIGH 0x1E // Reserved (high)
#define EFI_SCSI_IO_TYPE_UNKNOWN 0x1F // Unknown no device type

```

### Status Codes Returned

EFI_SUCCESS	Retrieves the device type information successfully.
EFI_INVALID_PARAMETER	The DeviceType is <b>NULL</b> .

## EFI\_SCSI\_IO\_PROTOCOL.GetDeviceLocation()

### Summary

Retrieves the SCSI device location in the SCSI channel.

### Prototype

```
typedef
EFI_STATUS
(EFI_API *EFI_SCSI_IO_PROTOCOL_GET_DEVICE_LOCATION) (
    IN EFI_SCSI_IO_PROTOCOL *This,
    IN OUT UINT8    **Target,
    OUT UINT64     *Lun
);
```

### Parameters

- This* A pointer to the **EFI\_SCSI\_IO\_PROTOCOL** instance. Type **EFI\_SCSI\_IO\_PROTOCOL** is defined in [EFI\\_SCSI\\_IO\\_PROTOCOL](#).
- Target* A pointer to the Target Array which represents the ID of a SCSI device on the SCSI channel.
- Lun* A pointer to the Logical Unit Number of the SCSI device on the SCSI channel.

### Description

This function is used to retrieve the SCSI device location in the SCSI bus. The device location is determined by a (Target, Lun) pair. This function allows a SCSI Device Driver to retrieve its location on the SCSI channel, and may use the Extended SCSI Pass Thru Protocol to access the SCSI device directly.

If *Target* or *Lun* is **NULL**, then **EFI\_INVALID\_PARAMETER** is returned. Otherwise, the device location is returned in *Target* and *Lun*, and **EFI\_SUCCESS** is returned.

### Status Codes Returned

EFI_SUCCESS	Retrieves the device location successfully.
EFI_INVALID_PARAMETER	Target or Lun is <b>NULL</b> .

## EFI\_SCSI\_IO\_PROTOCOL.ResetBus()

### Summary

Resets the SCSI Bus that the SCSI Device is attached to.

### Prototype

```
typedef
EFI_STATUS
(EFIAPI *EFI_SCSI_IO_PROTOCOL_RESET_BUS) (
    IN EFI_SCSI_IO_PROTOCOL *This
);
```

### Parameters

*This*

A pointer to the **EFI\_SCSI\_IO\_PROTOCOL** instance. Type **EFI\_SCSI\_IO\_PROTOCOL** is defined in [EFI\\_SCSI\\_IO\\_PROTOCOL](#).

### Description

This function provides the mechanism to reset the whole SCSI bus that the specified SCSI Device is connected to. Some SCSI Host Controller may not support bus reset, if so, **EFI\_UNSUPPORTED** is returned. If a device error occurs while executing that bus reset operation, then **EFI\_DEVICE\_ERROR** is returned. If a timeout occurs during the execution of the bus reset operation, then **EFI\_TIMEOUT** is returned. If the bus reset operation is completed, then **EFI\_SUCCESS** is returned.

### Status Codes Returned

EFI_SUCCESS	The SCSI bus is reset successfully.
EFI_DEVICE_ERROR	Errors encountered when resetting the SCSI bus.
EFI_UNSUPPORTED	The bus reset operation is not supported by the SCSI Host Controller.
EFI_TIMEOUT	A timeout occurred while attempting to reset the SCSI bus.

## EFI\_SCSI\_IO\_PROTOCOL.ResetDevice()

### Summary

Resets the SCSI Device that is specified by the device handle that the SCSI I/O Protocol is attached.

### Prototype

```
typedef
EFI_STATUS
(EFIAPI *EFI_SCSI_IO_PROTOCOL_RESET_DEVICE) (
    IN EFI_SCSI_IO_PROTOCOL  *This
);
```

### Parameters

*This* A pointer to the **EFI\_SCSI\_IO\_PROTOCOL** instance. Type **EFI\_SCSI\_IO\_PROTOCOL** is defined in [EFI\\_SCSI\\_IO\\_PROTOCOL](#).

### Description

This function provides the mechanism to reset the SCSI Device. If the SCSI bus does not support a device reset operation, then **EFI\_UNSUPPORTED** is returned. If a device error occurs while executing that device reset operation, then **EFI\_DEVICE\_ERROR** is returned. If a timeout occurs during the execution of the device reset operation, then **EFI\_TIMEOUT** is returned. If the device reset operation is completed, then **EFI\_SUCCESS** is returned.

### Status Codes Returned

EFI_SUCCESS	Reset the SCSI Device successfully.
EFI_DEVICE_ERROR	Errors are encountered when resetting the SCSI Device.
EFI_UNSUPPORTED	The SCSI bus does not support a device reset operation.
EFI_TIMEOUT	A timeout occurred while attempting to reset the SCSI Device.



## EFI\_SCSI\_IO\_PROTOCOL.ExecuteScsiCommand()

### Summary

Sends a SCSI Request Packet to the SCSI Device for execution.

### Prototype

```
typedef
EFI_STATUS
(EFI_API *EFI_SCSI_IO_PROTOCOL_EXECUTE_SCSI_COMMAND) (
  IN EFI_SCSI_IO_PROTOCOL      *This,
  IN OUT EFI_SCSI_IO_SCSI_REQUEST_PACKET *Packet,
  IN EFI_EVENT                 Event OPTIONAL
);
```

### Parameters

<i>This</i>	A pointer to the <b>EFI_SCSI_IO_PROTOCOL</b> instance. Type <b>EFI_SCSI_IO_PROTOCOL</b> is defined in <a href="#">EFI SCSI IO PROTOCOL</a> .
<i>Packet</i>	The SCSI request packet to send to the SCSI Device specified by the device handle. See “Related Definitions” for a description of <b>EFI_SCSI_IO_SCSI_REQUEST_PACKET</b> .
<i>Event</i>	If the SCSI bus where the SCSI device is attached does not support non-blocking I/O, then <i>Event</i> is ignored, and blocking I/O is performed. If <i>Event</i> is <b>NULL</b> , then blocking I/O is performed. If <i>Event</i> is not <b>NULL</b> and non-blocking I/O is supported, then non-blocking I/O is performed, and <i>Event</i> will be signaled when the SCSI Request Packet completes.

### Related Definitions

```
typedef struct {
  UINT64 Timeout;
  VOID *InDataBuffer;
  VOID *OutDataBuffer;
  VOID *SenseData;
  VOID *Cdb;
  UINT32 InTransferLength;
  UINT32 OutTransferLength;
  UINT8 CdbLength;
  UINT8 DataDirection;
  UINT8 HostAdapterStatus;
  UINT8 TargetStatus;
  UINT8 SenseDataLength;
} EFI_SCSI_IO_SCSI_REQUEST_PACKET;
```

<i>Timeout</i>	The timeout, in 100 ns units, to use for the execution of this SCSI Request Packet. A <i>Timeout</i> value of 0 means that this function will wait indefinitely for the SCSI Request Packet to execute. If <i>Timeout</i> is greater than zero, then this function will return <b>EFI_TIMEOUT</b> if the time required to execute the SCSI Request Packet is greater than <i>Timeout</i> .
<i>DataBuffer</i>	A pointer to the data buffer to transfer from or to the SCSI device.
<i>InDataBuffer</i>	A pointer to the data buffer to transfer between the SCSI controller and the SCSI device for SCSI READ command. For all SCSI WRITE Commands this must point to <b>NULL</b> .
<i>OutDataBuffer</i>	A pointer to the data buffer to transfer between the SCSI controller and the SCSI device for SCSI WRITE command. For all SCSI READ commands this field must point to <b>NULL</b> .
<i>SenseData</i>	A pointer to the sense data that was generated by the execution of the SCSI Request Packet.
<i>Cdb</i>	A pointer to buffer that contains the Command Data Block to send to the SCSI device.
<i>InTransferLength</i>	On Input, the size, in bytes, of <i>InDataBuffer</i> . On output, the number of bytes transferred between the SCSI controller and the SCSI device. If <i>InTransferLength</i> is larger than the SCSI controller can handle, no data will be transferred, <i>InTransferLength</i> will be updated to contain the number of bytes that the SCSI controller is able to transfer, and <b>EFI_BAD_BUFFER_SIZE</b> will be returned.
<i>OutTransferLength</i>	On Input, the size, in bytes of <i>OutDataBuffer</i> . On Output, the Number of bytes transferred between SCSI Controller and the SCSI device. If <i>OutTransferLength</i> is larger than the SCSI controller can handle, no data will be transferred, <i>OutTransferLength</i> will be updated to contain the number of bytes that the SCSI controller is able to transfer, and <b>EFI_BAD_BUFFER_SIZE</b> will be returned.
<i>CdbLength</i>	The length, in bytes, of the buffer <i>Cdb</i> . The standard values are 6, 10, 12, and 16, but other values are possible if a variable length <i>CDB</i> is used.
<i>DataDirection</i>	The direction of the data transfer. 0 for reads, 1 for writes. A value of 2 is Reserved for Bi-Directional SCSI commands. For example XDREADWRITE. All other values are reserved, and must not be used.
<i>HostAdapterStatus</i>	The status of the SCSI Host Controller that produces the SCSI bus where the SCSI device attached when the SCSI Request Packet was executed on the SCSI Controller. See the possible values listed below.
<i>TargetStatus</i>	The status returned by the SCSI device when the SCSI Request Packet was executed. See the possible values listed below.

*SenseDataLength* On input, the length in bytes of the *SenseData* buffer. On output, the number of bytes written to the *SenseData* buffer.

```
//
// DataDirection
//
#define EFI_SCSI_IO_DATA_DIRECTION_READ    0
#define EFI_SCSI_IO_DATA_DIRECTION_WRITE  1
#define EFI_SCSI_IO_DATA_DIRECTION_BIDIRECTIONAL 2

//
// HostAdapterStatus
//
#define EFI_SCSI_IO_STATUS_HOST_ADAPTER_OK      0x00
#define EFI_SCSI_IO_STATUS_HOST_ADAPTER_TIMEOUT_COMMAND 0x09
#define EFI_SCSI_IO_STATUS_HOST_ADAPTER_TIMEOUT 0x0b
#define EFI_SCSI_IO_STATUS_HOST_ADAPTER_MESSAGE_REJECT 0x0d
#define EFI_SCSI_IO_STATUS_HOST_ADAPTER_BUS_RESET 0x0e
#define EFI_SCSI_IO_STATUS_HOST_ADAPTER_PARITY_ERROR 0x0f
#define EFI_SCSI_IO_STATUS_HOST_ADAPTER_REQUEST_SENSE_FAILED 0x10
#define EFI_SCSI_IO_STATUS_HOST_ADAPTER_SELECTION_TIMEOUT 0x11
#define EFI_SCSI_IO_STATUS_HOST_ADAPTER_DATA_OVERRUN_UNDERRUN 0x12
#define EFI_SCSI_IO_STATUS_HOST_ADAPTER_BUS_FREE 0x13
#define EFI_SCSI_IO_STATUS_HOST_ADAPTER_PHASE_ERROR 0x14
#define EFI_SCSI_IO_STATUS_HOST_ADAPTER_OTHER 0x7f

//
// TargetStatus
//
#define EFI_SCSI_IO_STATUS_TARGET_GOOD      0x00
#define EFI_SCSI_IO_STATUS_TARGET_CHECK_CONDITION 0x02
#define EFI_SCSI_IO_STATUS_TARGET_CONDITION_MET 0x04
#define EFI_SCSI_IO_STATUS_TARGET_BUSY     0x08
#define EFI_SCSI_IO_STATUS_TARGET_INTERMEDIATE 0x10
#define EFI_SCSI_IO_STATUS_TARGET_INTERMEDIATE_CONDITION_MET 0x14
#define EFI_SCSI_IO_STATUS_TARGET_RESERVATION_CONFLICT 0x18
#define EFI_SCSI_IO_STATUS_TARGET_COMMAND_TERMINATED 0x22
#define EFI_SCSI_IO_STATUS_TARGET_QUEUE_FULL 0x28
```

## Description

This function sends the SCSI Request Packet specified by *Packet* to the SCSI Device.

If the SCSI Bus supports non-blocking I/O and *Event* is not **NULL**, then this function will return immediately after the command is sent to the SCSI Device, and will later signal *Event* when the command has completed. If the SCSI Bus supports non-blocking I/O and *Event* is **NULL**, then this function will send the command to the SCSI Device and block until it is complete. If the SCSI Bus does not support non-blocking I/O, the *Event* parameter is ignored, and the function will send the command to the SCSI Device and block until it is complete.

If *Packet* is successfully sent to the SCSI Device, then **EFI\_SUCCESS** is returned.

If *Packet* cannot be sent because there are too many packets already queued up, then **EFI\_NOT\_READY** is returned. The caller may retry *Packet* at a later time.

If a device error occurs while sending the *Packet*, then **EFI\_DEVICE\_ERROR** is returned.

If a timeout occurs during the execution of *Packet*, then **EFI\_TIMEOUT** is returned.

If any field of *Packet* is invalid, then **EFI\_INVALID\_PARAMETER** is returned.

If the data buffer described by *DataBuffer* and *TransferLength* is too big to be transferred in a single command, then **EFI\_BAD\_BUFFER\_SIZE** is returned. The number of bytes actually transferred is returned in *TransferLength*.

If the command described in *Packet* is not supported by the SCSI Host Controller that produces the SCSI bus, then **EFI\_UNSUPPORTED** is returned.

If **EFI\_SUCCESS**, **EFI\_BAD\_BUFFER\_SIZE**, **EFI\_DEVICE\_ERROR**, or **EFI\_TIMEOUT** is returned, then the caller must examine the status fields in *Packet* in the following precedence order: *HostAdapterStatus* followed by *TargetStatus* followed by *SenseDataLength*, followed by *SenseData*. If non-blocking I/O is being used, then the status fields in *Packet* will not be valid until the *Event* associated with *Packet* is signaled.

If **EFI\_NOT\_READY**, **EFI\_INVALID\_PARAMETER** or **EFI\_UNSUPPORTED** is returned, then *Packet* was never sent, so the status fields in *Packet* are not valid. If non-blocking I/O is being used, the *Event* associated with *Packet* will not be signaled.

### Status Codes Returned

<p>EFI_SUCCESS</p>	<p>The SCSI Request Packet was sent by the host. For read and bi-directional commands, <i>InTransferLength</i> bytes were transferred to <i>InDataBuffer</i>. For write and bi-directional commands, <i>OutTransferLength</i> bytes were transferred from <i>OutDataBuffer</i>. See <i>HostAdapterStatus</i>, <i>TargetStatus</i>, <i>SenseDataLength</i>, and <i>SenseData</i> in that order for additional status information.</p>
--------------------	--

EFI_BAD_BUFFER_SIZE	The SCSI Request Packet was not executed. For read and bi-directional commands, the number of bytes that could be transferred is returned in <i>InTransferLength</i> . For write and bi-directional commands, the number of bytes that could be transferred is returned in <i>OutTransferLength</i> . See <i>HostAdapterStatus</i> and <i>TargetStatus</i> in that order for additional status information.
EFI_NOT_READY	The SCSI Request Packet could not be sent because there are too many SCSI Command Packets already queued. The caller may retry again later.
EFI_DEVICE_ERROR	A device error occurred while attempting to send the SCSI Request Packet. See <i>HostAdapterStatus</i> , <i>TargetStatus</i> , <i>SenseDataLength</i> , and <i>SenseData</i> in that order for additional status information.
EFI_INVALID_PARAMETER	The contents of <i>CommandPacket</i> are invalid. The SCSI Request Packet was not sent, so no additional status information is available.
EFI_UNSUPPORTED	The command described by the SCSI Request Packet is not supported by the SCSI initiator (i.e., SCSI Host Controller). The SCSI Request Packet was not sent, so no additional status information is available.
EFI_TIMEOUT	A timeout occurred while waiting for the SCSI Request Packet to execute. See <i>HostAdapterStatus</i> , <i>TargetStatus</i> , <i>SenseDataLength</i> , and <i>SenseData</i> in that order for additional status information.

## 15.5 SCSI Device Paths

An **EFI\_SCSI\_IO\_PROTOCOL** must be installed on a handle for its services to be available to SCSI device drivers. In addition to the **EFI\_SCSI\_IO\_PROTOCOL**, an **EFI\_DEVICE\_PATH\_PROTOCOL** must also be installed on the same handle. See [Section 10](#) for detailed description of the **EFI\_DEVICE\_PATH\_PROTOCOL**.

The SCSI Driver Model defined in this document can support the SCSI channel generated or emulated by multiple architectures, such as Parallel SCSI, ATAPI, Fibre Channel, InfiniBand, and other future channel types. In this section, there are four example device paths provided, including SCSI device path, ATAPI device path, Fibre Channel device path and InfiniBand device path.

### 15.5.1 SCSI Device Path Example

[Table 130](#) shows an example device path for a SCSI device controller on a desktop platform. This SCSI device controller is connected to a SCSI channel that is generated by a PCI SCSI host controller. The PCI SCSI host controller generates a single SCSI channel, it

is located at PCI device number 0x07 and PCI function 0x00, and is directly attached to a PCI root bridge. The SCSI device controller is assigned SCSI Id 2, and its LUN is 0.

This sample device path consists of an ACPI Device Path Node, a PCI Device Path Node, a SCSI Node, and a Device Path End Structure. The \_HID and \_UID must match the ACPI table description of the PCI Root Bridge. The shorthand notation for this device path is:

**ACPI(PNP0A03,0)/PCI(7,0)/SCSI(2,0).**

**Table 130. SCSI Device Path Examples**

Byte Offset	Byte Length	Data	Description
0x00	0x01	0x02	Generic Device Path Header – Type ACPI Device Path
0x01	0x01	0x01	Sub type – ACPI Device Path
0x02	0x02	0x0C	Length – 0x0C bytes
0x04	0x04	0x41D0, 0x0A03	_HID PNP0A03 – 0x41D0 represents the compressed string ‘PNP’ and is encoded in the low order bytes. The compression method is described in the ACPI Specification.
0x08	0x04	0x0000	_UID
0x0C	0x01	0x01	<b>Generic Device Path Header – Type Hardware Device Path</b>
0x0D	0x01	0x01	Sub type – PCI
0x0E	0x02	0x06	Length – 0x06 bytes
0x10	0x01	0x07	PCI Function
0x11	0x01	0x00	PCI Device
0x12	0x01	0x03	Generic Device Path Header – Type Message Device Path
0x13	0x01	0x02	Sub type – SCSI
0x14	0x02	0x08	Length – 0x08 bytes
0x16	0x02	0x0002	Target ID on the SCSI bus (PUN)
0x18	0x02	0x0000	Logical Unit Number (LUN)
0x1A	0x01	0xff	<b>Generic Device Path Header – Type End of Hardware Device Path</b>
0x1B	0x01	0xFF	Sub type – End of Entire Device Path
0x1C	0x02	0x04	Length – 0x04 bytes

### 15.5.2 ATAPI Device Path Example

[Table 131](#) shows an example device path for an ATAPI device on a desktop platform. This ATAPI device is connected to the IDE bus on Primary channel, and is configured as the Master device on the channel. The IDE bus is generated by the IDE controller that is a PCI device. It is located at PCI device number 0x1F and PCI function 0x01, and is directly attached to a PCI root bridge.

This sample device path consists of an ACPI Device Path Node, a PCI Device Path Node, an ATAPI Node, and a Device Path End Structure. The \_HID and \_UID must match the ACPI table description of the PCI Root Bridge. The shorthand notation for this device path is:

**ACPI(PNPOA03,0)/PCI(7,0)/ATA(Primary,Master,0).****Table 131. ATAPI Device Path Examples**

Byte Offset	Byte Length	Data	Description
0x00	0x01	0x02	Generic Device Path Header – Type ACPI Device Path
0x01	0x01	0x01	Sub type – ACPI Device Path
0x02	0x02	0x0C	Length – 0x0C bytes
0x04	0x04	0x41D0, 0x0A03	_HID PNPOA03 – 0x41D0 represents the compressed string ‘PNP’ and is encoded in the low order bytes. The compression method is described in the ACPI Specification.
0x08	0x04	0x0000	_UID
0x0C	0x01	0x01	<b>Generic Device Path Header</b> – Type Hardware Device Path
0x0D	0x01	0x01	Sub type – PCI
0x0E	0x02	0x06	Length – 0x06 bytes
0x10	0x01	0x07	PCI Function
0x11	0x01	0x00	PCI Device
0x12	0x01	0x03	Generic Device Path Header – Type Message Device Path
0x13	0x01	0x01	Sub type – ATAPI
0x14	0x02	0x08	Length – 0x08 bytes
0x16	0x01	0x00	PrimarySecondary – Set to zero for primary or one for secondary.
0x17	0x01	0x00	SlaveMaster – set to zero for master or one for slave.
0x18	0x02	0x0000	Logical Unit Number,LUN.
0x1A	0x01	0xFF	<b>Generic Device Path Header</b> – Type End of Hardware Device Path
0x1B	0x01	0xFF	Sub type – End of Entire Device Path
0x1C	0x02	0x04	Length – 0x04 bytes

### 15.5.3 Fibre Channel Device Path Example

[Table 132](#) shows an example device path for an SCSI device that is connected to a Fibre Channel Port on a desktop platform. The Fibre Channel Port is a PCI device that is located at PCI device number 0x08 and PCI function 0x00, and is directly attached to a PCI root bridge. The Fibre Channel Port is addressed by the World Wide Number, and is assigned as X (X is a 64bit value); the SCSI device’s Logical Unit Number is 0.

This sample device path consists of an ACPI Device Path Node, a PCI Device Path Node, a Fibre Channel Device Path Node, and a Device Path End Structure. The \_HID and \_UID must match the ACPI table description of the PCI Root Bridge. The shorthand notation for this device path is:

**ACPI(PNPOA03,0)/PCI(8,0)/Fibre(X,0).**

**Table 132. Fibre Channel Device Path Examples**

Byte Offset	Byte Length	Data	Description
0x00	0x01	0x02	Generic Device Path Header – Type ACPI Device Path
0x01	0x01	0x01	Sub type – ACPI Device Path
0x02	0x02	0x0C	Length – 0x0C bytes
0x04	0x04	0x41D0, 0x0A03	_HID PNPOA03 – 0x41D0 represents the compressed string ‘PNP’ and is encoded in the low order bytes. The compression method is described in the ACPI Specification.
0x08	0x04	0x0000	_UID
0x0C	0x01	0x01	<b>Generic Device Path Header</b> – Type Hardware Device Path
0x0D	0x01	0x01	Sub type – PCI
0x0E	0x02	0x06	Length – 0x06 bytes
0x10	0x01	0x08	PCI Function
0x11	0x01	0x00	PCI Device
0x12	0x01	0x03	Generic Device Path Header – Type Message Device Path
0x13	0x01	0x02	Sub type – Fibre Channel
0x14	0x02	0x24	Length – 0x24 bytes
0x16	0x04	0x00	Reserved
0x1A	0x08	X	Fibre Channel World Wide Number
0x22	0x08	0x00	Fibre Channel Logical Unit Number (LUN).
0x2A	0x01	0xFF	<b>Generic Device Path Header</b> – Type End of Hardware Device Path
0x2B	0x01	0xFF	Sub type – End of Entire Device Path
0x2C	0x02	0x04	Length – 0x04 bytes

### 15.5.4 InfiniBand Device Path Example

[Table 133](#) shows an example device path for a SCSI device in an InfiniBand Network. This SCSI device is connected to a single SCSI channel generated by a SCSI Host Adapter, and the SCSI Host Adapter is an end node in the InfiniBand Network. The SCSI Host Adapter is a PCI device that is located at PCI device number 0x07 and PCI function 0x00, and is directly attached to a PCI root bridge. The SCSI device is addressed by the (IOU X, IOC Y, DeviceId Z) in the InfiniBand Network. (X, Y, Z are EUI-64 compliant identifiers).

This sample device path consists of an ACPI Device Path Node, a PCI Device Path Node, an InfiniBand Node, and a Device Path End Structure. The \_HID and \_UID must match the ACPI table description of the PCI Root Bridge. The shorthand notation for this device path is:



**ACPI(PNP0A03,0)/PCI(7,0)/Infiniband(X,Y,Z).****Table 133. InfiniBand Device Path Examples**

Byte Offset	Byte Length	Data	Description
0x00	0x01	0x02	Generic Device Path Header – Type ACPI Device Path
0x01	0x01	0x01	Sub type – ACPI Device Path
0x02	0x02	0x0C	Length – 0x0C bytes
0x04	0x04	0x41D0, 0x0A03	_HID PNP0A03 – 0x41D0 represents the compressed string ‘PNP’ and is encoded in the low order bytes. The compression method is described in the ACPI Specification.
0x08	0x04	0x0000	_UID
0x0C	0x01	0x01	<b>Generic Device Path Header</b> – Type Hardware Device Path
0x0D	0x01	0x01	Sub type – PCI
0x0E	0x02	0x06	Length – 0x06 bytes
0x10	0x01	0x07	PCI Function
0x11	0x01	0x00	PCI Device
0x12	0x01	0x03	Generic Device Path Header – Type Message Device Path
0x13	0x01	0x09	Sub type – InfiniBand
0x14	0x02	0x20	Length – 0x20 bytes
0x16	0x04	0x00	Reserved
0x1A	0x08	X	64bit node GUID of the IOU
0x22	0x08	Y	64bit GUID of the IOC
0x2A	0x08	Z	64bit persistent ID of the device.
0x32	0x01	0xFF	<b>Generic Device Path Header</b> – Type End of Hardware Device Path
0x33	0x01	0xFF	Sub type – End of Entire Device Path
0x34	0x02	0x04	Length – 0x04 bytes

## 15.6 SCSI Pass Thru Device Paths

An [EFI\\_EXT\\_SCSI\\_PASS\\_THRU\\_PROTOCOL](#) must be installed on a handle for its services to be available to UEFI drivers and applications. In addition to the [EFI\\_EXT\\_SCSI\\_PASS\\_THRU\\_PROTOCOL](#), an [EFI\\_DEVICE\\_PATH\\_PROTOCOL](#) must also be installed on the same handle. See [Section 10](#) for a detailed description of the [EFI\\_DEVICE\\_PATH\\_PROTOCOL](#).

A device path describes the location of a hardware component in a system from the processor's point of view. This includes the list of busses that lie between the processor and the SCSI controller. The *EFI Specification* takes advantage of the *ACPI Specification* to name system components. For the following set of examples, a PCI SCSI controller is assumed. The examples will show a SCSI controller on the root PCI bus, and a SCSI controller behind a PCI-PCI bridge. In addition, an example of a multichannel SCSI controller will be shown.

[Table 134](#) shows an example device path for a single channel PCI SCSI controller that is located at PCI device number 0x07 and PCI function 0x00, and is directly attached to a PCI root bridge. This device path consists of an ACPI Device Path Node, a PCI Device Path Node, and a Device Path End Structure. The `_HID` and `_UID` must match the ACPI table description of the PCI Root Bridge. The shorthand notation for this device path is:

**ACPI(PNP0A03,0)/PCI(7,0).**

**Table 134. Single Channel PCI SCSI Controller**

Byte Offset	Byte Length	Data	Description
0x00	0x01	0x02	Generic Device Path Header – Type ACPI Device Path
0x01	0x01	0x01	Sub type – ACPI Device Path
0x02	0x02	0x0C	Length – 0x0C bytes
0x04	0x04	0x41D0, 0x0A03	<code>_HID</code> PNP0A03 – 0x41D0 represents the compressed string ‘PNP’ and is encoded in the low order bytes. The compression method is described in the ACPI Specification.
0x08	0x04	0x0000	<code>_UID</code>
0x0C	0x01	0x01	<b>Generic Device Path Header</b> – Type Hardware Device Path
0x0D	0x01	0x01	Sub type – PCI
0x0E	0x02	0x06	Length – 0x06 bytes
0x10	0x01	0x00	PCI Function
0x11	0x01	0x07	PCI Device
0x12	0x01	0xFF	<b>Generic Device Path Header</b> – Type End of Hardware Device Path
0x13	0x01	0xFF	Sub type – End of Entire Device Path
0x14	0x02	0x04	Length – 0x04 bytes

[Table 135](#) shows an example device path for a single channel PCI SCSI controller that is located behind a PCI to PCI bridge at PCI device number 0x07 and PCI function 0x00. The PCI to PCI bridge is directly attached to a PCI root bridge, and it is at PCI device number 0x05 and PCI function 0x00. This device path consists of an ACPI Device Path Node, two PCI Device Path Nodes, and a Device Path End Structure. The `_HID` and `_UID` must match the ACPI table description of the PCI Root Bridge. The shorthand notation for this device path is:

**ACPI(PNP0A03,0)/PCI(5,0)/PCI(7,0).**

**Table 135. Single Channel PCI SCSI Controller behind a PCI Bridge**

Byte Offset	Byte Length	Data	Description
0x00	0x01	0x02	Generic Device Path Header – Type ACPI Device Path
0x01	0x01	0x01	Sub type – ACPI Device Path
0x02	0x02	0x0C	Length – 0x0C bytes
0x04	0x04	0x41D0, 0x0A03	_HID PNPOA03 – 0x41D0 represents the compressed string ‘PNP’ and is encoded in the low order bytes. The compression method is described in the ACPI Specification.
0x08	0x04	0x0000	_UID
0x0C	0x01	0x01	<b>Generic Device Path Header</b> – Type Hardware Device Path
0x0D	0x01	0x01	Sub type – PCI
0x0E	0x02	0x06	Length – 0x06 bytes
0x10	0x01	0x00	PCI Function
0x11	0x01	0x05	PCI Device
0x12	0x01	0x01	<b>Generic Device Path Header</b> – Type Hardware Device Path
0x13	0x01	0x01	Sub type – PCI
0x14	0x02	0x06	Length – 0x06 bytes
0x16	0x01	0x00	PCI Function
0x17	0x01	0x07	PCI Device
0x18	0x01	0xFF	<b>Generic Device Path Header</b> – Type End of Hardware Device Path
0x19	0x01	0xFF	Sub type – End of Entire Device Path
0x1A	0x02	0x04	Length – 0x04 bytes

[Table 136](#) shows an example device path for channel #3 of a four channel PCI SCSI controller that is located behind a PCI to PCI bridge at PCI device number 0x07 and PCI function 0x00. The PCI to PCI bridge is directly attached to a PCI root bridge, and it is at PCI device number 0x05 and PCI function 0x00. This device path consists of an ACPI Device Path Node, two PCI Device Path Nodes, a Controller Node, and a Device Path End Structure. The \_HID and \_UID must match the ACPI table description of the PCI Root Bridge. The shorthand notation of the device paths for all four of the SCSI channels are listed below. [Table 136](#) shows the last device path listed.

**ACPI(PNP0A03,0)/PCI(5,0)/PCI(7,0)/Ctrl(0)**  
**ACPI(PNP0A03,0)/PCI(5,0)/PCI(7,0)/Ctrl(1)**  
**ACPI(PNP0A03,0)/PCI(5,0)/PCI(7,0)/Ctrl(2)**  
**ACPI(PNP0A03,0)/PCI(5,0)/PCI(7,0)/Ctrl(3)**

**Table 136. Channel #3 of a PCI SCSI Controller behind a PCI Bridge**

Byte Offset	Byte Length	Data	Description
0x00	0x01	0x02	Generic Device Path Header – Type ACPI Device Path
0x01	0x01	0x01	Sub type – ACPI Device Path
0x02	0x02	0x0C	Length – 0x0C bytes
0x04	0x04	0x41D0, 0x0A03	_HID PNP0A03 – 0x41D0 represents the compressed string ‘PNP’ and is encoded in the low order bytes. The compression method is described in the ACPI Specification.
0x08	0x04	0x0000	_UID
0x0C	0x01	0x01	<b>Generic Device Path Header</b> – Type Hardware Device Path
0x0D	0x01	0x01	Sub type – PCI
0x0E	0x02	0x06	Length – 0x06 bytes
0x10	0x01	0x00	PCI Function
0x11	0x01	0x05	PCI Device
0x12	0x01	0x01	<b>Generic Device Path Header</b> – Type Hardware Device Path
0x13	0x01	0x01	Sub type – PCI
0x14	0x02	0x06	Length – 0x06 bytes
0x16	0x01	0x00	PCI Function
0x17	0x01	0x07	PCI Device
0x18	0x01	0x01	<b>Generic Device Path Header</b> – Type Hardware Device Path
0x19	0x01	0x05	Sub type – Controller
0x1A	0x02	0x08	Length – 0x08 bytes
0x1C	0x04	0x0003	Controller Number
0x20	0x01	0xFF	<b>Generic Device Path Header</b> – Type End of Hardware Device Path
0x21	0x01	0xFF	Sub type – End of Entire Device Path
0x22	0x02	0x04	Length – 0x04 bytes

## 15.7 Extended SCSI Pass Thru Protocol

This section defines the Extended SCSI Pass Thru Protocol. This protocol allows information about a SCSI channel to be collected, and allows SCSI Request Packets to be sent to any SCSI devices on a SCSI channel even if those devices are not boot devices. This protocol is attached to the device handle of each SCSI channel in a system that the protocol supports, and can be used for diagnostics. It may also be used to build a Block I/O driver for SCSI hard drives and SCSI CD-ROM or DVD drives to allow those devices to become boot devices. As ATAPI cmds are derived from SCSI cmds, the above statements also are applicable for ATAPI devices attached to a ATA controller. Packet-based

commands(ATAPI cmds) would be sent to ATAPI devices only through the Extended SCSI Pass Thru Protocol.

## EFI\_EXT\_SCSI\_PASS\_THRU\_PROTOCOL

This section provides a detailed description of the **EFI\_EXT\_SCSI\_PASS\_THRU\_PROTOCOL**.

### Summary

Provides services that allow SCSI Pass Thru commands to be sent to SCSI devices attached to a SCSI channel. It also allows packet-based commands (ATAPI cmds) to be sent to ATAPI devices attached to a ATA controller.

### GUID

```
#define EFI_EXT_SCSI_PASS_THRU_PROTOCOL_GUID \
{0x143b7632, 0xb81b, 0x4cb7, \
{0xab, 0xd3, 0xb6, 0x25, 0xa5, 0xb9, 0xbf, 0xfe}}
```

### Protocol Interface Structure

```
typedef struct _EFI_EXT_SCSI_PASS_THRU_PROTOCOL {
  EFI_EXT_SCSI_PASS_THRU_MODE *Mode;
  EFI_EXT_SCSI_PASS_THRU_PASSTHRU PassThru;
  EFI_EXT_SCSI_PASS_THRU_GET_NEXT_TARGET_LUN GetNextTargetLun;
  EFI_EXT_SCSI_PASS_THRU_BUILD_DEVICE_PATH BuildDevicePath;
  EFI_EXT_SCSI_PASS_THRU_GET_TARGET_LUN GetTargetLun;
  EFI_EXT_SCSI_PASS_THRU_RESET_CHANNEL ResetChannel;
  EFI_EXT_SCSI_PASS_THRU_RESET_TARGET_LUN ResetTargetLun;
  EFI_EXT_SCSI_PASS_THRU_GET_NEXT_TARGE GetNextTarget;
} EFI_EXT_SCSI_PASS_THRU_PROTOCOL;
```

### Parameters

<i>Mode</i>	A pointer to the <b>EFI_EXT_SCSI_PASS_THRU_MODE</b> data for this SCSI channel. <b>EFI_EXT_SCSI_PASS_THRU_MODE</b> is defined in “Related Definitions” below.
<i>PassThru</i>	Sends a SCSI Request Packet to a SCSI device that is Connected to the SCSI channel. See the <a href="#">PassThru()</a> function description.
<i>GetNextTargetLun</i>	Retrieves the list of legal Target IDs and LUNs for the SCSI devices on a SCSI channel. See the <a href="#">GetNextTargetLun()</a> function description.
<i>BuildDevicePath</i>	Allocates and builds a device path node for a SCSI Device on a SCSI channel. See the <a href="#">BuildDevicePath()</a> function description.
<i>GetTargetLun</i>	Translates a device path node to a Target ID and LUN. See the <a href="#">GetTargetLun()</a> function description.

<i>ResetChannel</i>	Resets the SCSI channel. This operation resets all the SCSI devices connected to the SCSI channel. See the <a href="#">ResetChannel()</a> function description.
<i>ResetTargetLun</i>	Resets a SCSI device that is connected to the SCSI channel. See the <a href="#">ResetTargetLun()</a> function description.
<i>GetNextTartget</i>	Retrieves the list of legal Target IDs for the SCSI devices on a SCSI channel. See the <a href="#">GetNextTarget()</a> function description.

The following data values in the **EFI\_EXT\_SCSI\_PASS\_THRU\_MODE** interface are read-only.

<i>AdapterId</i>	The Target ID of the host adapter on the SCSI channel.
<i>Attributes</i>	Additional information on the attributes of the SCSI channel. See “Related Definitions” below for the list of possible attributes.
<i>IoAlign</i>	Supplies the alignment requirement for any buffer used in a data transfer. <i>IoAlign</i> values of 0 and 1 mean that the buffer can be placed anywhere in memory. Otherwise, <i>IoAlign</i> must be a power of 2, and the requirement is that the start address of a buffer must be evenly divisible by <i>IoAlign</i> with no remainder.

### Related Definitions

```
typedef struct {
    UINT32 AdapterId;
    UINT32 Attributes;
    UINT32 IoAlign;
} EFI_EXT_SCSI_PASS_THRU_MODE;
```

```
#define TARGET_MAX_BYTES 0x10
#define EFI_EXT_SCSI_PASS_THRU_ATTRIBUTES_PHYSICAL 0x0001
#define EFI_EXT_SCSI_PASS_THRU_ATTRIBUTES_LOGICAL 0x0002
#define EFI_EXT_SCSI_PASS_THRU_ATTRIBUTES_NONBLOCKIO 0x0004
```

#### EFI\_EXT\_SCSI\_PASS\_THRU\_ATTRIBUTES\_PHYSICAL

If this bit is set, then the **EFI\_EXT\_SCSI\_PASS\_THRU\_PROTOCOL** interface is for physical devices on the SCSI channel.

#### EFI\_EXT\_SCSI\_PASS\_THRU\_ATTRIBUTES\_LOGICAL

If this bit is set, then the **EFI\_EXT\_SCSI\_PASS\_THRU\_PROTOCOL** interface is for logical devices on the SCSI channel.

#### EFI\_EXT\_SCSI\_PASS\_THRU\_ATTRIBUTES\_NONBLOCKIO

If this bit is set, then the **EFI\_EXT\_SCSI\_PASS\_THRU\_PROTOCOL** interface supports non blocking I/O. Every **EFI\_EXT\_SCSI\_PASS\_THRU\_PROTOCOL** must support blocking I/O. The support of nonblocking I/O is optional.

## Description

The **EFI\_EXT\_SCSI\_PASS\_THRU\_PROTOCOL** provides information about a SCSI channel and the ability to send SCSI Request Packets to any SCSI device attached to that SCSI channel. The information includes the Target ID of the host controller on the SCSI channel and the attributes of the SCSI channel.

The printable name for the SCSI controller, and the printable name of the SCSI channel can be provided through the **EFI\_COMPONENT\_NAME2\_PROTOCOL** for multiple languages.

The *Attributes* field of the **EFI\_EXT\_SCSI\_PASS\_THRU\_PROTOCOL** interface tells if the interface is for physical SCSI devices or logical SCSI devices. Drivers for non-RAID SCSI controllers will set both the **EFI\_EXT\_SCSI\_PASS\_THRU\_ATTRIBUTES\_PHYSICAL**, and the **EFI\_EXT\_SCSI\_PASS\_THRU\_ATTRIBUTES\_LOGICAL** bits.

Drivers for RAID controllers that allow access to the physical devices and logical devices will produce two **EFI\_EXT\_SCSI\_PASS\_THRU\_PROTOCOL** interfaces: one with the just the **EFI\_EXT\_SCSI\_PASS\_THRU\_ATTRIBUTES\_PHYSICAL** bit set and another with just the **EFI\_EXT\_SCSI\_PASS\_THRU\_ATTRIBUTES\_LOGICAL** bit set. One interface can be used to access the physical devices attached to the RAID controller, and the other can be used to access the logical devices attached to the RAID controller for its current configuration.

Drivers for RAID controllers that do not allow access to the physical devices will produce one **EFI\_EXT\_SCSI\_PASS\_THROUGH\_PROTOCOL** interface with just the **EFI\_EXT\_SCSI\_PASS\_THRU\_ATTRIBUTES\_LOGICAL** bit set. The interface for logical devices can also be used by a file system driver to mount the RAID volumes. An **EFI\_EXT\_SCSI\_PASS\_THRU\_PROTOCOL** with neither **EFI\_EXT\_SCSI\_PASS\_THRU\_ATTRIBUTES\_LOGICAL** nor **EFI\_EXT\_SCSI\_PASS\_THRU\_ATTRIBUTES\_PHYSICAL** set is an illegal configuration.

The *Attributes* field also contains the **EFI\_EXT\_SCSI\_PASS\_THRU\_ATTRIBUTES\_NONBLOCKIO** bit. All **EFI\_EXT\_SCSI\_PASS\_THRU\_PROTOCOL** interfaces must support blocking I/O. If this bit is set, then the interface support both blocking I/O and nonblocking I/O.

Each **EFI\_EXT\_SCSI\_PASS\_THRU\_PROTOCOL** instance must have an associated device path. Typically this will have an *ACPI* device path node and a *PCI* device path node, although variation will exist. For a SCSI controller that supports only one channel per PCI bus/device/function, it is recommended, but not required, that an additional *Controller* device path node (for controller 0) be appended to the device path.

For a SCSI controller that supports multiple channels per PCI bus/device/function, it is required that a *Controller* device path node be appended for each channel.

Additional information about the SCSI channel can be obtained from protocols attached to the same handle as the **EFI\_EXT\_SCSI\_PASS\_THRU\_PROTOCOL**, or one of its parent handles. This would include the device I/O abstraction used to access the internal registers and functions of the SCSI controller.

## EFI\_EXT\_SCSI\_PASS\_THRU\_PROTOCOL.PassThru()

### Summary

Sends a SCSI Request Packet to a SCSI device that is attached to the SCSI channel. This function supports both blocking I/O and nonblocking I/O. The blocking I/O functionality is required, and the nonblocking I/O functionality is optional.

### Prototype

```
typedef
EFI_STATUS
(EFIAPI *EFI_EXT_SCSI_PASS_THRU_PASSTHRU) (
    IN EFI_EXT_SCSI_PASS_THRU_PROTOCOL *This,
    IN UINT8 *Target,
    IN UINT64 Lun,
    IN OUT EFI_EXT_SCSI_PASS_THRU_SCSI_REQUEST_PACKET *Packet,
    IN EFI_EVENT Event OPTIONAL
);
```

### Parameters

<i>This</i>	A pointer to the <b>EFI_EXT_SCSI_PASS_THRU_PROTOCOL</b> instance. Type <b>EFI_EXT_SCSI_PASS_THRU_PROTOCOL</b> is defined in <a href="#">Section 15.7</a> .
<i>Target</i>	The Target is an array of size <b>TARGET_MAX_BYTES</b> and it represents the id of the SCSI device to send the SCSI Request Packet. Each transport driver may chose to utilize a subset of this size to suit the needs of transport target representation. For example, a Fibre Channel driver may use only 8 bytes (WWN) to represent an FC target.
<i>Lun</i>	The LUN of the SCSI device to send the SCSI Request Packet.
<i>Packet</i>	A pointer to the SCSI Request Packet to send to the SCSI device specified by <i>Target</i> and <i>Lun</i> . See “Related Definitions” below for a description of <b>EFI_EXT_SCSI_PASS_THRU_SCSI_REQUEST_PACKET</b> .
<i>Event</i>	If nonblocking I/O is not supported then <i>Event</i> is ignored, and blocking I/O is performed. If <i>Event</i> is <b>NULL</b> , then blocking I/O is performed. If <i>Event</i> is not <b>NULL</b> and non blocking I/O is supported, then nonblocking I/O is performed, and <i>Event</i> will be signaled when the SCSI Request Packet completes.



## Related Definitions

```
typedef struct {
    UINT64 Timeout;
    VOID *InDataBuffer;
    VOID *OutDataBuffer;
    VOID *SenseData;
    VOID *Cdb;
    UINT32 InTransferLength;
    UINT32 OutTransferLength;
    UINT8 CdbLength;
    UINT8 DataDirection;
    UINT8 HostAdapterStatus;
    UINT8 TargetStatus;
    UINT8 SenseDataLength;
} EFI_EXT_SCSI_PASS_THRU_SCSI_REQUEST_PACKET;
```

<i>Timeout</i>	The timeout, in 100 ns units, to use for the execution of this SCSI Request Packet. A <i>Timeout</i> value of 0 means that this function will wait indefinitely for the SCSI Request Packet to execute. If <i>Timeout</i> is greater than zero, then this function will return <b>EFI_TIMEOUT</b> if the time required to execute the SCSI Request Packet is greater than <i>Timeout</i> .
<i>InDataBuffer</i>	A pointer to the data buffer to transfer between the SCSI controller and the SCSI device for read and bidirectional commands. For all write and non data commands where <i>InTransferLength</i> is 0 this field is optional and may be <b>NULL</b> . If this field is not <b>NULL</b> , then it must be aligned on the boundary specified by the <i>IoAlign</i> field in the <b>EFI_EXT_SCSI_PASS_THRU_MODE</b> structure.
<i>OutDataBuffer</i>	A pointer to the data buffer to transfer between the SCSI controller and the SCSI device for write or bidirectional commands. For all read and non data commands where <i>OutTransferLength</i> is 0 this field is optional and may be <b>NULL</b> . If this field is not <b>NULL</b> , then it must be aligned on the boundary specified by the <i>IoAlign</i> field in the <b>EFI_EXT_SCSI_PASS_THRU_MODE</b> structure.
<i>SenseData</i>	A pointer to the sense data that was generated by the execution of the SCSI Request Packet. If <i>SenseDataLength</i> is 0, then this field is optional and may be <b>NULL</b> . It is strongly recommended that a sense data buffer of at least 252 bytes be provided to guarantee the entire sense data buffer generated from the execution of the SCSI Request Packet can be returned. If this field is not <b>NULL</b> , then it must be aligned to the boundary specified in the <i>IoAlign</i> field in the <b>EFI_EXT_SCSI_PASS_THRU_MODE</b> structure.
<i>Cdb</i>	A pointer to buffer that contains the Command Data Block to send to the SCSI device specified by <i>Target</i> and <i>Lun</i> .

*InTransferLength* On Input, the size, in bytes, of *InDataBuffer*. On output, the number of bytes transferred between the SCSI controller and the SCSI device. If *InTransferLength* is larger than the SCSI controller can handle, no data will be transferred, *InTransferLength* will be updated to contain the number of bytes that the SCSI controller is able to transfer, and **EFI\_BAD\_BUFFER\_SIZE** will be returned.

*OutTransferLength* On Input, the size, in bytes of *OutDataBuffer*. On Output, the Number of bytes transferred between SCSI Controller and the SCSI device. If *OutTransferLength* is larger than the SCSI controller can handle, no data will be transferred, *OutTransferLength* will be updated to contain the number of bytes that the SCSI controller is able to transfer, and **EFI\_BAD\_BUFFER\_SIZE** will be returned.

*CdbLength* The length, in bytes, of the buffer *Cdb*. The standard values are 6, 10, 12, and 16, but other values are possible if a variable length *CDB* is used.

*DataDirection* The direction of the data transfer. 0 for reads, 1 for writes. A value of 2 is Reserved for Bi-Directional SCSI commands. For example XDREADWRITE. All other values are reserved, and must not be used.

*HostAdapterStatus* The status of the host adapter specified by *This* when the SCSI Request Packet was executed on the target device. See the possible values listed below. If bit 7 of this field is set, then *HostAdapterStatus* is a vendor defined error code.

*TargetStatus* The status returned by the device specified by *Target* and *Lun* when the SCSI Request Packet was executed. See the possible values listed below.

*SenseDataLength* On input, the length in bytes of the *SenseData* buffer. On output, the number of bytes written to the *SenseData* buffer.

```
//
// DataDirection
//
#define EFI_EXT_SCSI_DATA_DIRECTION_READ    0
#define EFI_EXT_SCSI_DATA_DIRECTION_WRITE  1
#define EFI_EXT_SCSI_DATA_DIRECTION_BIDIRECTIONAL 2
//
// HostAdapterStatus
//
#define EFI_EXT_SCSI_STATUS_HOST_ADAPTER_OK      0x00
#define EFI_EXT_SCSI_STATUS_HOST_ADAPTER_TIMEOUT_COMMAND 0x09
#define EFI_EXT_SCSI_STATUS_HOST_ADAPTER_TIMEOUT 0x0b
#define EFI_EXT_SCSI_STATUS_HOST_ADAPTER_MESSAGE_REJECT 0x0d
#define EFI_EXT_SCSI_STATUS_HOST_ADAPTER_BUS_RESET 0x0e
#define EFI_EXT_SCSI_STATUS_HOST_ADAPTER_PARITY_ERROR 0x0f
```

```

#define EFI_EXT_SCSI_STATUS_HOST_ADAPTER_REQUEST_SENSE_FAILED 0x10
#define EFI_EXT_SCSI_STATUS_HOST_ADAPTER_SELECTION_TIMEOUT 0x11
#define EFI_EXT_SCSI_STATUS_HOST_ADAPTER_DATA_OVERRUN_UNDERRUN 0x12
#define EFI_EXT_SCSI_STATUS_HOST_ADAPTER_BUS_FREE 0x13
#define EFI_EXT_SCSI_STATUS_HOST_ADAPTER_PHASE_ERROR 0x14
#define EFI_EXT_SCSI_STATUS_HOST_ADAPTER_OTHER 0x7f
//
// TargetStatus
//
#define EFI_EXT_SCSI_STATUS_TARGET_GOOD 0x00
#define EFI_EXT_SCSI_STATUS_TARGET_CHECK_CONDITION 0x02
#define EFI_EXT_SCSI_STATUS_TARGET_CONDITION_MET 0x04
#define EFI_EXT_SCSI_STATUS_TARGET_BUSY 0x08
#define EFI_EXT_SCSI_STATUS_TARGET_INTERMEDIATE 0x10
#define EFI_EXT_SCSI_STATUS_TARGET_INTERMEDIATE_CONDITION_MET 0x14
#define EFI_EXT_SCSI_STATUS_TARGET_RESERVATION_CONFLICT 0x18
#define EFI_EXT_SCSI_STATUS_TARGET_TASK_SET_FULL 0x28
#define EFI_EXT_SCSI_STATUS_TARGET_ACA_ACTIVE 0x30
#define EFI_EXT_SCSI_STATUS_TARGET_TASK_ABORTED 0x40

```

## Description

The [PassThru\(\)](#) function sends the SCSI Request Packet specified by *Packet* to the SCSI device specified by *Target* and *Lun*. If the driver supports nonblocking I/O and *Event* is not **NULL**, then the driver will return immediately after the command is sent to the selected device, and will later signal *Event* when the command has completed.

If the driver supports nonblocking I/O and *Event* is **NULL**, then the driver will send the command to the selected device and block until it is complete.

If the driver does not support nonblocking I/O, then the *Event* parameter is ignored, and the driver will send the command to the selected device and block until it is complete.

If *Packet* is successfully sent to the SCSI device, then **EFI\_SUCCESS** is returned.

If *Packet* cannot be sent because there are too many packets already queued up, then **EFI\_NOT\_READY** is returned. The caller may retry *Packet* at a later time.

If a device error occurs while sending the *Packet*, then **EFI\_DEVICE\_ERROR** is returned.

If a timeout occurs during the execution of *Packet*, then **EFI\_TIMEOUT** is returned.

If a device is not present but the target/LUN address in the packet are valid, then **EFI\_TIMEOUT** is returned, and *HostStatus* is set to

**EFI\_EXT\_SCSI\_STATUS\_HOST\_ADAPTER\_TIMEOUT\_COMMAND**.

If *Target* or *Lun* are not in a valid range for the SCSI channel, then **EFI\_INVALID\_PARAMETER** is returned. If *InDataBuffer*, *OutDataBuffer* or *SenseData* do not meet the alignment requirement specified by the *IoAlign* field of the **EFI\_EXT\_SCSI\_PASS\_THRU\_MODE** structure, then **EFI\_INVALID\_PARAMETER** is returned. If any of the other fields of *Packet* are invalid, then **EFI\_INVALID\_PARAMETER** is returned.

If the data buffer described by *InDataBuffer* and *InTransferLength* is too big to be transferred in a single command, then no data is transferred and **EFI\_BAD\_BUFFER\_SIZE** is returned. The number of bytes that can be transferred in a single command are returned in *InTransferLength*.

If the data buffer described by *OutDataBuffer* and *OutTransferLength* is too big to be transferred in a single command, then no data is transferred and **EFI\_BAD\_BUFFER\_SIZE** is returned. The number of bytes that can be transferred in a single command are returned in *OutTransferLength*.

If the command described in *Packet* is not supported by the host adapter, then **EFI\_UNSUPPORTED** is returned.

If **EFI\_SUCCESS**, **EFI\_BAD\_BUFFER\_SIZE**, **EFI\_DEVICE\_ERROR**, or **EFI\_TIMEOUT** is returned, then the caller must examine the status fields in *Packet* in the following precedence order: *HostAdapterStatus* followed by *TargetStatus* followed by *SenseDataLength*, followed by *SenseData*.

If nonblocking I/O is being used, then the status fields in *Packet* will not be valid until the *Event* associated with *Packet* is signaled.

If **EFI\_NOT\_READY**, **EFI\_INVALID\_PARAMETER** or **EFI\_UNSUPPORTED** is returned, then *Packet* was never sent, so the status fields in *Packet* are not valid. If nonblocking I/O is being used, the *Event* associated with *Packet* will not be signaled.

Note: Some examples of SCSI read commands are READ, INQUIRY, and MODE\_SENSE.

Note: Some examples of SCSI write commands are WRITE and MODE\_SELECT.

Note: An example of a SCSI non data command is TEST\_UNIT\_READY.

### Status Codes Returned

EFI_SUCCESS	The SCSI Request Packet was sent by the host. For bi-directional commands, <i>InTransferLength</i> bytes were transferred from <i>InDataBuffer</i> . For write and bi-directional commands, <i>OutTransferLength</i> bytes were transferred by <i>OutDataBuffer</i> . See <i>HostAdapterStatus</i> , <i>TargetStatus</i> , <i>SenseDataLength</i> , and <i>SenseData</i> in that order for additional status information.
EFI_BAD_BUFFER_SIZE	The SCSI Request Packet was not executed. The number of bytes that could be transferred is returned in <i>InTransferLength</i> . For write and bi-directional commands, <i>OutTransferLength</i> bytes were transferred by <i>OutDataBuffer</i> . See <i>HostAdapterStatus</i> , <i>TargetStatus</i> , and in that order for additional status information.
EFI_NOT_READY	The SCSI Request Packet could not be sent because there are too many SCSI Request Packets already queued. The caller may retry again later.
EFI_DEVICE_ERROR	A device error occurred while attempting to send the SCSI Request Packet. See <i>HostAdapterStatus</i> , <i>TargetStatus</i> , <i>SenseDataLength</i> , and <i>SenseData</i> in that order for additional status information.

EFI_INVALID_PARAMETER	<i>Target</i> , <i>Lun</i> , or the contents of <i>ScsiRequestPacket</i> are invalid. The SCSI Request Packet was not sent, so no additional status information is available.
EFI_UNSUPPORTED	The command described by the SCSI Request Packet is not supported by the host adapter. This includes the case of Bi-directional SCSI commands not supported by the implementation. The SCSI Request Packet was not sent, so no additional status information is available.
EFI_TIMEOUT	A timeout occurred while waiting for the SCSI Request Packet to execute. See <i>HostAdapterStatus</i> , <i>TargetStatus</i> , <i>SenseDataLength</i> , and <i>SenseData</i> in that order for additional status information.

## EFI\_EXT\_SCSI\_PASS\_THRU\_PROTOCOL.GetNextTargetLun()

### Summary

Used to retrieve the list of legal Target IDs and LUNs for SCSI devices on a SCSI channel. These can either be the list SCSI devices that are actually present on the SCSI channel, or the list of legal Target Ids and LUNs for the SCSI channel. Regardless, the caller of this function must probe the Target ID and LUN returned to see if a SCSI device is actually present at that location on the SCSI channel.

### Prototype

```
typedef
EFI_STATUS
(EFIAPI *EFI_EXT_SCSI_PASS_THRU_GET_NEXT_TARGET_LUN) (
    IN EFI_EXT_SCSI_PASS_THRU_PROTOCOL *This,
    IN OUT UINT8          **Target,
    IN OUT UINT64        *Lun
);
```

### Parameters

<i>This</i>	A pointer to the <b>EFI_EXT_SCSI_PASS_THRU_PROTOCOL</b> instance. Type <b>EFI_EXT_SCSI_PASS_THRU_PROTOCOL</b> is defined in <a href="#">Section 15.7</a> .
<i>Target</i>	On input, a pointer to a legal Target ID (an array of size <b>TARGET_MAX_BYTES</b> ) for a SCSI device present on the SCSI channel. On output, a pointer to the next legal Target ID (an array of <b>TARGET_MAX_BYTES</b> ) of a SCSI device on a SCSI channel. An input value of <b>0xFF</b> 's (all bytes in the array are <b>0xFF</b> ) in the Target array retrieves the first legal Target ID for a SCSI device present on a SCSI channel.
<i>Lun</i>	On input, a pointer to the LUN of a SCSI device present on the SCSI channel. On output, a pointer to the LUN of the next SCSI device ID on a SCSI channel.

### Description

The **EFI\_EXT\_SCSI\_PASS\_THRU\_PROTOCOL.GetNextTargetLun()** function retrieves a list of legal Target ID and LUN of a SCSI channel. If on input a *Target* is specified by all **0xFF** in the Target array, then the first legal Target ID and LUN for a SCSI device on a SCSI channel is returned in *Target* and *Lun*, and **EFI\_SUCCESS** is returned.

If *Target* and *Lun* is a Target ID and LUN value that was returned on a previous call to **GetNextTargetLun()**, then the next legal Target ID and LUN for a SCSI device on the SCSI channel is returned in *Target* and *Lun*, and **EFI\_SUCCESS** is returned.

If *Target array* is not all **0xFF**'s and *Target* and *Lun* were not returned on a previous call to **GetNextTargetLun()**, then **EFI\_INVALID\_PARAMETER** is returned.

If *Target* and *Lun* are the Target ID and LUN of the last SCSI device on the SCSI channel, then **EFI\_NOT\_FOUND** is returned.

## Status Codes Returned

EFI_SUCCESS	The Target ID and LUN of the next SCSI device on the SCSI channel was returned in <i>Target</i> and <i>Lun</i> .
EFI_NOT_FOUND	There are no more SCSI devices on this SCSI channel.
EFI_INVALID_PARAMETER	<i>Target array</i> is not all <b>0xFF</b> 's, and <i>Target</i> and <i>Lun</i> were not returned on a previous call to <b>GetNextTargetLun()</b> .

## EFI\_EXT\_SCSI\_PASS\_THRU\_PROTOCOL.BuildDevicePath()

### Summary

Used to allocate and build a device path node for a SCSI device on a SCSI channel.

### Prototype

```
typedef
EFI_STATUS
(EFIAPI *EFI_EXT_SCSI_PASS_THRU_BUILD_DEVICE_PATH) (
    IN EFI_EXT_SCSI_PASS_THRU_PROTOCOL *This,
    IN UINT8 *Target,
    IN UINT64 Lun
    IN OUT EFI_DEVICE_PATH_PROTOCOL **DevicePath
);
```

### Parameters

<i>This</i>	A pointer to the <b>EFI_EXT_SCSI_PASS_THRU_PROTOCOL</b> instance. Type <b>EFI_EXT_SCSI_PASS_THRU_PROTOCOL</b> is defined in <a href="#">Section 15.7</a> .
<i>Target</i>	The Target is an array of size <b>TARGET_MAX_BYTES</b> and it specifies the Target ID of the SCSI device for which a device path node is to be allocated and built. Transport drivers may choose to utilize a subset of this size to suit the representation of targets. For example, a Fibre Channel driver may use only 8 bytes (WWN) in the array to represent a FC target.
<i>Lun</i>	The LUN of the SCSI device for which a device path node is to be allocated and built.
<i>DevicePath</i>	A pointer to a single device path node that describes the SCSI device specified by <i>Target</i> and <i>Lun</i> . This function is responsible for allocating the buffer <i>DevicePath</i> with the boot service <b>AllocatePool()</b> . It is the caller's responsibility to free <i>DevicePath</i> when the caller is finished with <i>DevicePath</i> .

### Description

The **EFI\_EXT\_SCSI\_PASS\_THRU\_PROTOCOL.BuildDevicePath()** function allocates and builds a single device path node for the SCSI device specified by *Target* and *Lun*. If the SCSI device specified by *Target* and *Lun* are not present on the SCSI channel, then **EFI\_NOT\_FOUND** is returned. If *DevicePath* is **NULL**, then **EFI\_INVALID\_PARAMETER** is returned. If there are not enough resources to allocate the device path node, then **EFI\_OUT\_OF\_RESOURCES** is returned. Otherwise, *DevicePath* is allocated with the boot service **AllocatePool()**, the contents of *DevicePath* are initialized to describe the SCSI device specified by *Target* and *Lun*, and **EFI\_SUCCESS** is returned.



## Status Codes Returned

EFI_SUCCESS	The device path node that describes the SCSI device specified by <i>Target</i> and <i>Lun</i> was allocated and returned in <i>DevicePath</i> .
EFI_NOT_FOUND	The SCSI devices specified by <i>Target</i> and <i>Lun</i> does not exist on the SCSI channel.
EFI_INVALID_PARAMETER	<i>DevicePath</i> is <b>NULL</b> .
EFI_OUT_OF_RESOURCES	There are not enough resources to allocate DevicePath.

## EFI\_EXT\_SCSI\_PASS\_THRU\_PROTOCOL.GetTargetLun()

### Summary

Used to translate a device path node to a Target ID and LUN.

### Prototype

```
typedef
EFI_STATUS
(EFIAPI *EFI_EXT_SCSI_PASS_THRU_GET_TARGET_LUN) (
    IN EFI_EXT_SCSI_PASS_THRU_PROTOCOL *This,
    IN EFI_DEVICE_PATH_PROTOCOL *DevicePath
    OUT UINT8 **Target,
    OUT UINT64 *Lun
);
```

### Parameters

<i>This</i>	A pointer to the <b>EFI_EXT_SCSI_PASS_THRU_PROTOCOL</b> instance. Type <b>EFI_EXT_SCSI_PASS_THRU_PROTOCOL</b> is defined in <a href="#">Section 15.7</a> .
<i>DevicePath</i>	A pointer to the device path node that describes a SCSI device on the SCSI channel.
<i>Target</i>	A pointer to the Target Array which represents the ID of a SCSI device on the SCSI channel.
<i>Lun</i>	A pointer to the LUN of a SCSI device on the SCSI channel.

### Description

The **EFI\_EXT\_SCSI\_PASS\_THRU\_PROTOCOL.GetTargetLun()** function determines the Target ID and LUN associated with the SCSI device described by *DevicePath*. If *DevicePath* is a device path node type that the SCSI Pass Thru driver supports, then the SCSI Pass Thru driver will attempt to translate the contents *DevicePath* into a Target ID and LUN. If this translation is successful, then that Target ID and LUN are returned in *Target* and *Lun*, and **EFI\_SUCCESS** is returned.

If *DevicePath*, *Target*, or *Lun* are **NULL**, then **EFI\_INVALID\_PARAMETER** is returned.

If *DevicePath* is not a device path node type that the SCSI Pass Thru driver supports, then **EFI\_UNSUPPORTED** is returned.

If *DevicePath* is a device path node type that the SCSI Pass Thru driver supports, but there is not a valid translation from *DevicePath* to a Target ID and LUN, then **EFI\_NOT\_FOUND** is returned.

### Status Codes Returned

EFI_SUCCESS	<i>DevicePath</i> was successfully translated to a Target ID and LUN, and they were returned in Target and Lun.
EFI_INVALID_PARAMETER	<i>DevicePath</i> is <b>NULL</b> .

EFI_INVALID_PARAMETER	<i>Target</i> is <b>NULL</b>
EFI_INVALID_PARAMETER	<i>Lun</i> is <b>NULL</b>
EFI_UNSUPPORTED	This driver does not support the device path node type in <i>DevicePath</i> .
EFI_NOT_FOUND	A valid translation from <i>DevicePath</i> to a Target ID and LUN does not exist.

## EFI\_EXT\_SCSI\_PASS\_THRU\_PROTOCOL.ResetChannel()

### Summary

Resets a SCSI channel. This operation resets all the SCSI devices connected to the SCSI channel.

### Prototype

```
typedef
EFI_STATUS
(EFIAPI *EFI_EXT_SCSI_PASS_THRU_RESET_CHANNEL) (
    IN EFI_EXT_SCSI_PASS_THRU_PROTOCOL *This
);
```

### Parameters

*This* A pointer to the **EFI\_EXT\_SCSI\_PASS\_THRU\_PROTOCOL** instance. Type **EFI\_EXT\_SCSI\_PASS\_THRU\_PROTOCOL** is defined in [Section 15.7](#).

### Description

The **EFI\_EXT\_SCSI\_PASS\_THRU\_PROTOCOL.ResetChannel()** function resets a SCSI channel. This operation resets all the SCSI devices connected to the SCSI channel. If this SCSI channel does not support a reset operation, then **EFI\_UNSUPPORTED** is returned.

If a device error occurs while executing that channel reset operation, then **EFI\_DEVICE\_ERROR** is returned.

If a timeout occurs during the execution of the channel reset operation, then **EFI\_TIMEOUT** is returned. If the channel reset operation is completed, then **EFI\_SUCCESS** is returned.

### Status Codes Returned

EFI_SUCCESS	The SCSI channel was reset.
EFI_UNSUPPORTED	The SCSI channel does not support a channel reset operation.
EFI_DEVICE_ERROR	A device error occurred while attempting to reset the SCSI channel.
EFI_TIMEOUT	A timeout occurred while attempting to reset the SCSI channel.

## EFI\_EXT\_SCSI\_PASS\_THRU\_PROTOCOL.ResetTargetLun()

### Summary

Resets a SCSI logical unit that is connected to a SCSI channel.

### Prototype

```
typedef
EFI_STATUS
(EFIAPI *EFI_EXT_SCSI_PASS_THRU_RESET_TARGET_LUN) (
  IN EFI_EXT_SCSI_PASS_THRU_PROTOCOL *This,
  IN UINT8      *Target,
  IN UINT64     Lun
);
```

### Parameters

<i>This</i>	A pointer to the <b>EFI_EXT_SCSI_PASS_THRU_PROTOCOL</b> instance. Type <b>EFI_EXT_SCSI_PASS_THRU_PROTOCOL</b> is defined in <a href="#">Section 15.7</a> .
<i>Target</i>	The Target is an array of size <b>TARGET_MAX_BYTE</b> and it represents the target port ID of the SCSI device containing the SCSI logical unit to reset. Transport drivers may chose to utilize a subset of this array to suit the representation of their targets. For example a Fibre Channel driver may use only 8 bytes in the array (WWN) to represent a FC target.
<i>Lun</i>	The LUN of the SCSI device to reset.

### Description

The **EFI\_EXT\_SCSI\_PASS\_THRU\_PROTOCOL.ResetTargetLun()** function resets the SCSI logical unit specified by *Target* and *Lun*. If this SCSI channel does not support a target reset operation, then **EFI\_UNSUPPORTED** is returned.

If *Target* or *Lun* are not in a valid range for this SCSI channel, then **EFI\_INVALID\_PARAMETER** is returned.

If a device error occurs while executing that logical unit reset operation, then **EFI\_DEVICE\_ERROR** is returned.

If a timeout occurs during the execution of the logical unit reset operation, then **EFI\_TIMEOUT** is returned.

If the logical unit reset operation is completed, then **EFI\_SUCCESS** is returned.

### Status Codes Returned

EFI_SUCCESS	The SCSI device specified by <i>Target</i> and <i>Lun</i> was reset
EFI_UNSUPPORTED	The SCSI channel does not support a target reset operation.
EFI_INVALID_PARAMETER	<i>Target</i> or <i>Lun</i> are invalid.

EFI_DEVICE_ERROR	A device error occurred while attempting to reset the SCSI device specified by <i>Target</i> and <i>Lun</i> .
EFI_TIMEOUT	A timeout occurred while attempting to reset the SCSI device specified by <i>Target</i> and <i>Lun</i> .

## EFI\_EXT\_SCSI\_PASS\_THRU\_PROTOCOL.GetNextTarget()

### Summary

Used to retrieve the list of legal Target IDs for SCSI devices on a SCSI channel. These can either be the list SCSI devices that are actually present on the SCSI channel, or the list of legal Target IDs for the SCSI channel. Regardless, the caller of this function must probe the Target ID returned to see if a SCSI device is actually present at that location on the SCSI channel.

### Prototype

```
typedef
EFI_STATUS
(EFI_API *EFI_EXT_SCSI_PASS_THRU_GET_NEXT_TARGET) (
    IN EFI_EXT_SCSI_PASS_THRU_PROTOCOL *This,
    IN OUT UINT8 **Target,
);
```

### Parameters

*This*

A pointer to the **EFI\_EXT\_SCSI\_PASS\_THRU\_PROTOCOL** instance. Type **EFI\_EXT\_SCSI\_PASS\_THRU\_PROTOCOL** is defined in [Section 15.7](#).

*Target*

On input, a pointer to the Target ID (an array of size **TARGET\_MAX\_BYTES**) of a SCSI device present on the SCSI channel. On output, a pointer to the Target ID (an array of **TARGET\_MAX\_BYTES**) of the next SCSI device present on a SCSI channel. An input value of **0xFF**'s (all bytes in the array are **0xFF**) in the Target array retrieves the Target ID of the first SCSI device present on a SCSI channel.

### Description

The **EFI\_EXT\_SCSI\_PASS\_THRU\_PROTOCOL.GetNextTarget()** function retrieves the Target ID of a SCSI device present on a SCSI channel. If on input a *Target* is specified by all **0xF** in the Target array, then the Target ID of the first SCSI device is returned in *Target* and **EFI\_SUCCESS** is returned.

If *Target* is a Target ID value that was returned on a previous call to **GetNextTarget()**, then the Target ID of the next SCSI device on the SCSI channel is returned in *Target*, and **EFI\_SUCCESS** is returned.

If *Target* array is not all **0xFF**'s and *Target* were not returned on a previous call to **GetNextTarget()**, then **EFI\_INVALID\_PARAMETER** is returned.

If *Target* is the Target ID of the last SCSI device on the SCSI channel, then **EFI\_NOT\_FOUND** is returned.

## Status Codes Returned

EFI_SUCCESS	The Target ID of the next SCSI device on the SCSI channel was returned in <i>Target</i> .
EFI_NOT_FOUND	There are no more SCSI devices on this SCSI channel.
EFI_INVALID_PARAMETER	<i>Target array</i> is not all <b>0xFF's</b> , and <i>Target</i> were not returned on a previous call to <b>GetNextTarget()</b> .



# 16 Protocols — iSCSI Boot

---

## 16.1 Overview

The iSCSI protocol defines a transport for SCSI data over TCP/IP. It also provides an interoperable solution that takes advantage of existing internet infrastructure, management facilities, and addresses distance limitations. The iSCSI protocol specification was developed by the Internet Engineering Task Force (IETF) and is SCSI Architecture Model-2 (SAM-2) compliant. iSCSI encapsulates block-oriented SCSI commands into iSCSI Protocol Data Units (PDU) that traverse the network over TCP/IP. iSCSI defines a Session, the initiator and target nexus (I-T nexus), which could be a bundle of one or more TCP connections.

Similar to other existing mass storage protocols like Fibre Channel and parallel SCSI, boot over iSCSI is an important functionality. This document will attempt to capture the various cases for iSCSI boot and common up with generic EFI protocol changes to address them.

### 16.1.1 iSCSI UEFI Driver Layering

iSCSI UEFI Drivers may exist in two different forms:

- iSCSI UEFI Driver on a NIC:

The driver will be layered on top of the networking layers. It will use the DHCP, IP, and TCP and packet level interface protocols of the UEFI networking stack. The driver will use an iSCSI software initiator.

- iSCSI UEFI Driver on a Host Bus Adapter (HBA) that may use an offloading engine such as TOE (or any other TCP offload card):

The driver will be layered on top of the TOE TCP interfaces. It will use the DHCP, IP, TCP protocols of the TOE. The driver will present itself as a SCSI device driver using interfaces such as **EFI\_EXT\_SCSI\_PASS\_THRU\_PROTOCOL**.

To help in detecting iSCSI UEFI Drivers and their capabilities, the iSCSI UEFI driver handle must include an instance of the **EFI\_ADAPTER\_INFORMATION\_PROTOCOL** with a **EFI\_ADAPTER\_INFO\_NETWORK\_BOOT** structure.

## 16.2 EFI iSCSI Initiator Name Protocol

This protocol sets and obtains the iSCSI Initiator Name. The iSCSI Initiator Name protocol builds a default iSCSI name. The iSCSI name configures using the programming interfaces defined below. Successive configuration of the iSCSI initiator name overwrites the previously existing name. Once overwritten, the previous name will not be retrievable. Setting an iSCSI name string that is zero length is illegal. The maximum size of the iSCSI Initiator Name is 224 bytes (including the NULL terminator).

## EFI\_ISCSI\_INITIATOR\_NAME\_PROTOCOL

### Summary

iSCSI Initiator Name Protocol for setting and obtaining the iSCSI Initiator Name.

### GUID

```
#define EFI_ISCSI_INITIATOR_NAME_PROTOCOL_GUID \
{0x59324945, 0xec44, 0x4c0d, \
 {0xb1, 0xcd, 0x9d, 0xb1, 0x39, 0xdf, 0x07, 0x0c}}
```

### Protocol Interface Structure

```
typedef struct _EFI_ISCSI_INITIATOR_NAME_PROTOCOL {
  EFI_ISCSI_INITIATOR_NAME_GET Get;
  EFI_ISCSI_INITIATOR_NAME_SET Set;
} EFI_ISCSI_INITIATOR_NAME_PROTOCOL;
```

### Parameters

<i>Get</i>	Used to retrieve the iSCSI Initiator Name.
<i>Set</i>	Used to set the iSCSI Initiator Name.

### Description

The **EFI\_ISCSI\_INIT\_NAME\_PROTOCOL** provides the ability to get and set the iSCSI Initiator Name.

## EFI\_ISCSI\_INITIATOR\_NAME\_PROTOCOL. Get()

### Summary

Retrieves the current set value of iSCSI Initiator Name.

### Prototype

```
typedef EFI_STATUS
(EFIAPI *EFI_ISCSI_INITIATOR_NAME_GET) {
  IN EFI_ISCSI_INITIATOR_NAME_PROTOCOL *This
  IN OUT UINTN          *BufferSize
  OUT VOID              *Buffer
}
```

### Parameters

<i>This</i>	Pointer to the <b>EFI_ISCSI_INITIATOR_NAME_PROTOCOL</b> instance.
<i>BufferSize</i>	Size of the buffer in bytes pointed to by Buffer / Actual size of the variable data buffer.
<i>Buffer</i>	Pointer to the buffer for data to be read. The data is a null-terminated UTF-8 encoded string. The maximum length is 223 characters, including the null-terminator.

### Description

This function will retrieve the iSCSI Initiator Name from Non-volatile memory.

### Status Codes Returned

EFI_SUCCESS	Data was successfully retrieved into the provided buffer and the <i>BufferSize</i> was sufficient to handle the iSCSI initiator name
EFI_BUFFER_TOO_SMALL	<i>BufferSize</i> is too small for the result. <i>BufferSize</i> will be updated with the size required to complete the request. <i>Buffer</i> will not be affected.
EFI_INVALID_PARAMETER	<i>BufferSize</i> is <b>NULL</b> . <i>BufferSize</i> and <i>Buffer</i> will not be affected.
EFI_INVALID_PARAMETER	<i>Buffer</i> is <b>NULL</b> . <i>BufferSize</i> and <i>Buffer</i> will not be affected.
EFI_DEVICE_ERROR	The iSCSI initiator name could not be retrieved due to a hardware error.

## EFI\_ISCSI\_INITIATOR\_NAME\_PROTOCOL.Set()

### Summary

Sets the iSCSI Initiator Name.

### Prototype

```
typedef EFI_STATUS
(EFI_API *EFI_ISCSI_INITIATOR_NAME_SET) {
    IN EFI_ISCSI_INITIATOR_NAME_PROTOCOL *This
    IN OUT UINTN *BufferSize
    IN VOID *Buffer
}
```

### Parameters

<i>This</i>	Pointer to the <b>EFI_ISCSI_INITIATOR_NAME_PROTOCOL</b> instance
<i>BufferSize</i>	Size of the buffer in bytes pointed to by Buffer.
<i>Buffer</i>	Pointer to the buffer for data to be written. The data is a null-terminated UTF-8 encoded string. The maximum length is 223 characters, including the null-terminator.

### Description

This function will set the iSCSI Initiator Name into Non-volatile memory.

### Status Codes Returned

EFI_SUCCESS	Data was successfully stored by the protocol
EFI_UNSUPPORTED	Platform policies do not allow for data to be written
EFI_INVALID_PARAMETER	<i>BufferSize</i> exceeds the maximum allowed limit. <i>BufferSize</i> will be updated with the maximum size required to complete the request.
EFI_INVALID_PARAMETER	<i>BufferSize</i> is <b>NULL</b> . <i>BufferSize</i> and <i>Buffer</i> will not be affected
EFI_INVALID_PARAMETER	<i>Buffer</i> is <b>NULL</b> . <i>BufferSize</i> and <i>Buffer</i> will not be affected.
EFI_DEVICE_ERROR	The data could not be stored due to a hardware error.
EFI_OUT_OF_RESOURCES	Not enough storage is available to hold the data
EFI_PROTOCOL_ERROR	Input iSCSI initiator name does not adhere to RFC 3720 (and other related protocols)

## 17 Protocols — USB Support

---

### 17.1 USB2 Host Controller Protocol

[Section 17.1](#) and [Section 17.1.1](#) describe the USB2 Host Controller Protocol. This protocol provides an I/O abstraction for a USB2 Host Controller. The USB2 Host Controller is a hardware component that interfaces to a Universal Serial Bus (USB). It moves data between system memory and devices on the USB by processing data structures and generating transactions on the USB. This protocol is used by a USB Bus Driver to perform all data transaction over the Universal Serial Bus. It also provides services to manage the USB root hub that is integrated into the USB Host Controller. USB device drivers do not use this protocol directly. Instead, they use the I/O abstraction produced by the USB Bus Driver. This protocol should only be used by drivers that require direct access to the USB bus.

#### 17.1.1 USB Host Controller Protocol Overview

The USB Host Controller Protocol is used by code, typically USB bus drivers, running in the EFI boot services environment, to perform data transactions over a USB bus. In addition, it provides an abstraction for the root hub of the USB bus.

The interfaces provided in the [EFI\\_USB2\\_HC\\_PROTOCOL](#) are used to manage data transactions on a USB bus. It also provides control methods for the USB root hub. The [EFI\\_USB2\\_HC\\_PROTOCOL](#) is designed to support both USB 1.1 and USB 2.0 – compliant host controllers.

The [EFI\\_USB2\\_HC\\_PROTOCOL](#) abstracts basic functionality that is designed to operate with the EHCI, UHCI and OHCI standards. By using this protocol, a single USB bus driver can be implemented without knowing if the underlying USB host controller conforms to the XHCI, EHCI, OHCI or the UHCI standards.

Each instance of the [EFI\\_USB2\\_HC\\_PROTOCOL](#) corresponds to a USB host controller in a platform. The protocol is attached to the device handle of a USB host controller that is created by a device driver for the USB host controller's parent bus type. For example, a USB host controller that is implemented as a PCI device would require a PCI device driver to produce an instance of the [EFI\\_USB2\\_HC\\_PROTOCOL](#).

### EFI\_USB2\_HC\_PROTOCOL

#### Summary

Provides basic USB host controller management, basic data transactions over USB bus, and USB root hub access.

## GUID

```
#define EFI_USB2_HC_PROTOCOL_GUID \
{0x3e745226,0x9818,0x45b6,\
{0xa2,0xac,0xd7,0xcd,0x0e,0x8b,0xa2,0xbc}}
```

## Protocol Interface Structure

```
typedef struct _EFI_USB2_HC_PROTOCOL {
EFI_USB2_HC_PROTOCOL_GET_CAPABILITY           GetCapability;
EFI_USB2_HC_PROTOCOL_RESET                   Reset;
EFI_USB2_HC_PROTOCOL_GET_STATE               GetState;
EFI_USB2_HC_PROTOCOL_SET_STATE               SetState;
EFI_USB2_HC_PROTOCOL_CONTROL_TRANSFER        ControlTransfer;
EFI_USB2_HC_PROTOCOL_BULK_TRANSFER           BulkTransfer;
EFI_USB2_HC_PROTOCOL_ASYNC_INTERRUPT_TRANSFER AsyncInterruptTransfer;
EFI_USB2_HC_PROTOCOL_SYNC_INTERRUPT_TRANSFER SyncInterruptTransfer;
EFI_USB2_HC_PROTOCOL_ISOCHRONOUS_TRANSFER    IsochronousTransfer;
EFI_USB2_HC_PROTOCOL_ASYNC_ISOCHRONOUS_TRANSFER AsyncIsochronousTransfer;
EFI_USB2_HC_PROTOCOL_GET_ROOTHUB_PORT_STATUS GetRootHubPortStatus;
EFI_USB2_HC_PROTOCOL_SET_ROOTHUB_PORT_FEATURE SetRootHubPortFeature;
EFI_USB2_HC_PROTOCOL_CLEAR_ROOTHUB_PORT_FEATURE ClearRootHubPortFeature;

UINT16           MajorRevision;
UINT16           MinorRevision;
} EFI_USB2_HC_PROTOCOL;
```

## Parameters

<i>GetCapability</i>	Retrieves the capabilities of the USB host controller. See the <a href="#">GetCapability()</a> function description.
<i>Reset</i>	Software reset of USB. See the <a href="#">Reset()</a> function description.
<i>GetState</i>	Retrieves the current state of the USB host controller. See the <a href="#">GetState()</a> function description.
<i>SetState</i>	Sets the USB host controller to a specific state. See the <a href="#">SetState()</a> function description.
<i>ControlTransfer</i>	Submits a control transfer to a target USB device. See the <a href="#">ControlTransfer()</a> function description.
<i>BulkTransfer</i>	Submits a bulk transfer to a bulk endpoint of a USB device. See the <a href="#">BulkTransfer()</a> function description.

<i>AsyncInterruptTransfer</i>	Submits an asynchronous interrupt transfer to an interrupt endpoint of a USB device. See the <a href="#">AsyncInterruptTransfer()</a> function description.
<i>SyncInterruptTransfer</i>	Submits a synchronous interrupt transfer to an interrupt endpoint of a USB device. See the <a href="#">SyncInterruptTransfer()</a> function description.
<i>IsochronousTransfer</i>	Submits isochronous transfer to an isochronous endpoint of a USB device. See the <a href="#">IsochronousTransfer()</a> function description.
<i>AsyncIsochronousTransfer</i>	Submits nonblocking USB isochronous transfer. See the <a href="#">AsyncIsochronousTransfer()</a> function description.
<i>GetRootHubPortStatus</i>	Retrieves the status of the specified root hub port. See the <a href="#">GetRootHubPortStatus()</a> function description.
<i>SetRootHubPortFeature</i>	Sets the feature for the specified root hub port. See the <a href="#">SetRootHubPortFeature()</a> function description.
<i>ClearRootHubPortFeature</i>	Clears the feature for the specified root hub port. See the <a href="#">ClearRootHubPortFeature()</a> function description.
<i>MajorRevision</i>	The major revision number of the USB host controller. The revision information indicates the release of the Universal Serial Bus Specification with which the host controller is compliant.
<i>MinorRevision</i>	The minor revision number of the USB host controller. The revision information indicates the release of the Universal Serial Bus Specification with which the host controller is compliant.

## Description

The **EFI\_USB2\_HC\_PROTOCOL** provides USB host controller management, basic data transactions over a USB bus, and USB root hub access. A device driver that wishes to manage a USB bus in a system retrieves the **EFI\_USB2\_HC\_PROTOCOL** instance that is associated with the USB bus to be managed. A device handle for a USB host controller will minimally contain an [EFI\\_DEVICE\\_PATH\\_PROTOCOL](#) instance, and an **EFI\_USB2\_HC\_PROTOCOL** instance.

## EFI\_USB2\_HC\_PROTOCOL.GetCapability()

### Summary

Retrieves the Host Controller capabilities.

### Prototype

```
typedef
EFI_STATUS
(EFIAPI *EFI_USB2_HC_PROTOCOL_GET_CAPABILITY) (
    IN EFI_USB2_HC_PROTOCOL *This,
    OUT UINT8 *MaxSpeed,
    OUT UINT8 *PortNumber,
    OUT UINT8 *Is64BitCapable
);
```

### Parameters

<i>This</i>	A pointer to the <a href="#">EFI_USB2_HC_PROTOCOL</a> instance. Type <a href="#">EFI_USB2_HC_PROTOCOL</a> is defined in <a href="#">Section 17.1</a> .
<i>MaxSpeed</i>	Host controller data transfer speed; see “Related Definitions” below for a list of supported transfer speed values.
<i>PortNumber</i>	Number of the root hub ports.
<i>Is64BitCapable</i>	<b>TRUE</b> if controller supports 64-bit memory addressing, <b>FALSE</b> otherwise.

### Related Definitions

```
#define EFI_USB_SPEED_FULL 0x0000
#define EFI_USB_SPEED_LOW 0x0001
#define EFI_USB_SPEED_HIGH 0x0002
#define EFI_USB_SPEED_SUPER 0x0003
```

EFI_USB_SPEED_LOW	Low speed USB device; data bandwidth is up to 1.5 Mb/s. Supported by USB 1.1 OHCI and UHCI host controllers.
EFI_USB_SPEED_FULL	Full speed USB device; data bandwidth is up to 12 Mb/s. Supported by USB 1.1 OHCI and UHCI host controllers.
EFI_USB_SPEED_HIGH	High speed USB device; data bandwidth is up to 480 Mb/s. Supported by USB 2.0 EHCI host controllers.
EFI_USB_SPEED_SUPER	Super speed USB device; data bandwidth is up to 4.8Gbs. Supported by USB 3.0 XHCI host controllers.

### Description

This function is used to retrieve the host controller capabilities. *MaxSpeed* indicates the maximum data transfer speed the controller is capable of; this information is needed for the subsequent transfers. *PortNumber* is the number of root hub ports, it is required by the USB bus driver to perform bus enumeration. *Is64BitCapable* indicates that controller



is capable of 64-bit memory access so that the host controller software can use memory blocks above 4 GiB for the data transfers.

### Status Codes Returned

EFI_SUCCESS	The host controller capabilities were retrieved successfully.
EFI_INVALID_PARAMETER	MaxSpeed or PortNumber or Is64BitCapable is <b>NULL</b> .
EFI_DEVICE_ERROR	An error was encountered while attempting to retrieve the capabilities.

## EFI\_USB2\_HC\_PROTOCOL.Reset()

### Summary

Provides software reset for the USB host controller.

### Prototype

```
typedef
EFI_STATUS
(EFI_API *EFI_USB2_HC_PROTOCOL_RESET) (
  IN EFI_USB2_HC_PROTOCOL *This,
  IN UINT16 Attributes
);
```

### Parameters

<i>This</i>	A pointer to the <a href="#">EFI_USB2_HC_PROTOCOL</a> instance. Type <a href="#">EFI_USB2_HC_PROTOCOL</a> is defined in <a href="#">Section 17.1</a> .
<i>Attributes</i>	A bit mask of the reset operation to perform. See “Related Definitions” below for a list of the supported bit mask values.

### Related Definitions

```
#define EFI_USB_HC_RESET_GLOBAL 0x0001
#define EFI_USB_HC_RESET_HOST_CONTROLLER 0x0002
#define EFI_USB_HC_RESET_GLOBAL_WITH_DEBUG 0x0004
#define EFI_USB_HC_RESET_HOST_WITH_DEBUG 0x0008
```

#### EFI\_USB\_HC\_RESET\_GLOBAL

If this bit is set, a global reset signal will be sent to the USB bus. This resets all of the USB bus logic, including the USB host controller hardware and all the devices attached on the USB bus.

#### EFI\_USB\_HC\_RESET\_HOST\_CONTROLLER

If this bit is set, the USB host controller hardware will be reset. No reset signal will be sent to the USB bus.

#### EFI\_USB\_HC\_RESET\_GLOBAL\_WITH\_DEBUG

If this bit is set, then a global reset signal will be sent to the USB bus. This resets all of the USB bus logic, including the USB host controller and all of the devices attached on the USB bus. If this is an XHCI or EHCI controller and the debug port has been configured, then this will still reset the host controller.

#### EFI\_USB\_HC\_RESET\_HOST\_WITH\_DEBUG

If this bit is set, the USB host controller hardware will be reset. If this is an XHCI or EHCI controller and the debug port has been configured, then this will still reset the host controller.

## Description

This function provides a software mechanism to reset a USB host controller. The type of reset is specified by the *Attributes* parameter. If the type of reset specified by *Attributes* is not valid, then **EFI\_INVALID\_PARAMETER** is returned. If the reset operation is completed, then **EFI\_SUCCESS** is returned. If the type of reset specified by *Attributes* is not currently supported by the host controller hardware, **EFI\_UNSUPPORTED** is returned. If a device error occurs during the reset operation, then **EFI\_DEVICE\_ERROR** is returned.

Note: For XHCI or EHCI controllers, the **EFI\_USB\_HC\_RESET\_GLOBAL** and **EFI\_USB\_HC\_RESET\_HOST\_CONTROLLER** types of reset do not actually reset the bus if the debug port has been configured. In these cases, the function will return **EFI\_ACCESS\_DENIED**.

## Status Codes Returned

EFI_SUCCESS	The reset operation succeeded.
EFI_INVALID_PARAMETER	<i>Attributes</i> is not valid.
EFI_UNSUPPORTED	The type of reset specified by <i>Attributes</i> is not currently supported by the host controller hardware.
EFI_ACCESS_DENIED	Reset operation is rejected due to the debug port being configured and active; only <b>EFI_USB_HC_RESET_GLOBAL_WITH_DEBUG</b> or <b>EFI_USB_HC_RESET_HOST_WITH_DEBUG</b> reset <i>Attributes</i> can be used to perform reset operation for this host controller.
EFI_DEVICE_ERROR	An error was encountered while attempting to perform the reset operation.

## EFI\_USB2\_HC\_PROTOCOL.GetState()

### Summary

Retrieves current state of the USB host controller.

### Prototype

```
typedef
EFI_STATUS
(EFI_API *EFI_USB2_HC_PROTOCOL_GET_STATE) (
  IN EFI_USB2_HC_PROTOCOL *This,
  OUT EFI_USB_HC_STATE *State
);
```

### Parameters

<i>This</i>	A pointer to the <a href="#">EFI_USB2_HC_PROTOCOL</a> instance. Type <a href="#">EFI_USB2_HC_PROTOCOL</a> is defined in <a href="#">Section 17.1</a> .
<i>State</i>	A pointer to the <a href="#">EFI_USB_HC_STATE</a> data structure that indicates current state of the USB host controller. Type <a href="#">EFI_USB_HC_STATE</a> is defined in “Related Definitions.”

### Related Definitions

```
typedef enum {
  EfiUsbHcStateHalt,
  EfiUsbHcStateOperational,
  EfiUsbHcStateSuspend,
  EfiUsbHcStateMaximum
} EFI_USB_HC_STATE;
```

#### EfiUsbHcStateHalt

The host controller is in halt state. No USB transactions can occur while in this state. The host controller can enter this state for three reasons:

- After host controller hardware reset.
- Explicitly set by software.
- Triggered by a fatal error such as consistency check failure.

#### EfiUsbHcStateOperational

The host controller is in an operational state. When in this state, the host controller can execute bus traffic. This state must be explicitly set to enable the USB bus traffic.

#### EfiUsbHcStateSuspend

The host controller is in the suspend state. No USB transactions can occur while in this state. The host controller enters this state for the following reasons:

- Explicitly set by software.

- Triggered when there is no bus traffic for 3 microseconds.

## Description

This function is used to retrieve the USB host controller's current state. The USB Host Controller Protocol publishes three states for USB host controller, as defined in "Related Definitions" below. If *State* is **NULL**, then **EFI\_INVALID\_PARAMETER** is returned. If a device error occurs while attempting to retrieve the USB host controllers current state, then **EFI\_DEVICE\_ERROR** is returned. Otherwise, the USB host controller's current state is returned in *State*, and **EFI\_SUCCESS** is returned.

## Status Codes Returned

EFI_SUCCESS	The state information of the host controller was returned in <i>State</i> .
EFI_INVALID_PARAMETER	State is <b>NULL</b> .
EFI_DEVICE_ERROR	An error was encountered while attempting to retrieve the host controller's current state.

## EFI\_USB2\_HC\_PROTOCOL.SetState()

### Summary

Sets the USB host controller to a specific state.

### Prototype

```
typedef
EFI_STATUS
(EFIAPI *EFI_USB2_HC_PROTOCOL_SET_STATE) (
    IN EFI_USB2_HC_PROTOCOL *This,
    IN EFI_USB_HC_STATE State
);
```

### Parameters

*This* A pointer to the [EFI USB2 HC PROTOCOL](#) instance. Type [EFI USB2 HC PROTOCOL](#) is defined in [Section 17.1](#).

*State* Indicates the state of the host controller that will be set. See the definition and description of the type [EFI USB HC STATE](#) in the [GetState\(\)](#) function description.

### Description

This function is used to explicitly set a USB host controller's state. There are three states defined for the USB host controller. These are the halt state, the operational state and the suspend state. [Figure 58](#) illustrates the possible state transitions:

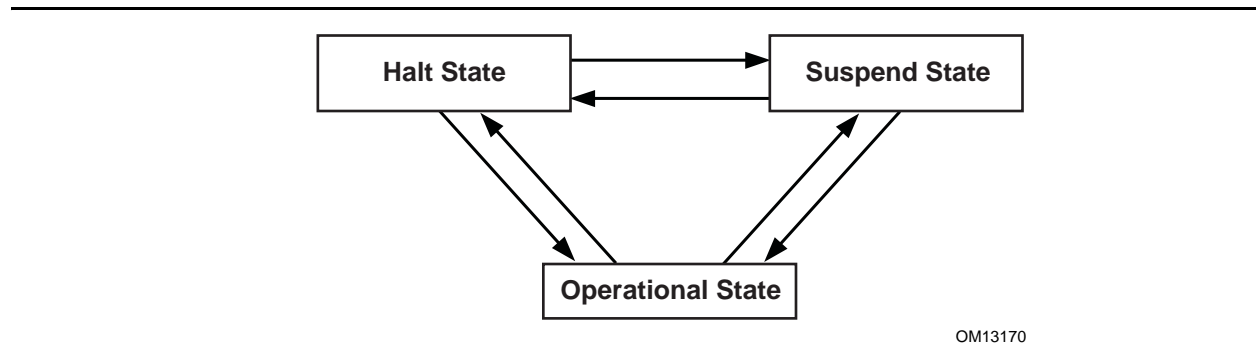

Figure 58. Software Triggered State Transitions of a USB Host Controller

If the state specified by *State* is not valid, then **EFI\_INVALID\_PARAMETER** is returned. If a device error occurs while attempting to place the USB host controller into the state specified by *State*, then **EFI\_DEVICE\_ERROR** is returned. If the USB host controller is successfully placed in the state specified by *State*, then **EFI\_SUCCESS** is returned.

## Status Codes Returned

EFI_SUCCESS	The USB host controller was successfully placed in the state specified by <i>State</i> .
EFI_INVALID_PARAMETER	<i>State</i> is invalid.
EFI_DEVICE_ERROR	Failed to set the state specified by <i>State</i> due to device error.

## EFI\_USB2\_HC\_PROTOCOL.ControlTransfer()

### Summary

Submits control transfer to a target USB device.

### Prototype

```
typedef
EFI_STATUS
(EFI_API *EFI_USB2_HC_PROTOCOL_CONTROL_TRANSFER) (
    IN EFI_USB2_HC_PROTOCOL      *This,
    IN UINT8                     DeviceAddress,
    IN UINT8                     DeviceSpeed,
    IN UINTN                     MaximumPacketLength,
    IN EFI_USB_DEVICE_REQUEST    *Request,
    IN EFI_USB_DATA_DIRECTION    TransferDirection,
    IN OUT VOID                  *Data OPTIONAL,
    IN OUT UINTN                 *DataLength OPTIONAL,
    IN UINTN                     TimeOut,
    IN EFI_USB2_HC_TRANSACTION_TRANSLATOR *Translator,
    OUT UINT32                   *TransferResult
);
```

### Related Definitions

```
typedef struct {
    UINT8 TranslatorHubAddress,
    UINT8 TranslatorPortNumber
} EFI_USB2_HC_TRANSACTION_TRANSLATOR;
```

### Parameters

<i>This</i>	A pointer to the <a href="#">EFI_USB2_HC_PROTOCOL</a> instance. Type <a href="#">EFI_USB2_HC_PROTOCOL</a> is defined in <a href="#">Section 17.1</a> .
<i>DeviceAddress</i>	Represents the address of the target device on the USB, which is assigned during USB enumeration.
<i>DeviceSpeed</i>	Indicates device speed. See “Related Definitions” in <a href="#">GetCapability()</a> for a list of the supported values.
<i>MaximumPacketLength</i>	Indicates the maximum packet size that the default control transfer endpoint is capable of sending or receiving.
<i>Request</i>	A pointer to the USB device request that will be sent to the USB device. Refer to <a href="#">UsbControlTransfer()</a> ( <a href="#">Section 17.2.4</a> ) for the definition of this function type.
<i>TransferDirection</i>	Specifies the data direction for the transfer. There are three values available, <a href="#">EfiUsbDataIn</a> , <a href="#">EfiUsbDataOut</a> and



	<b>EfiUsbNoData</b> . Refer to <b>UsbControlTransfer()</b> (Section 17.2.4) for the definition of this function type.
<i>Data</i>	A pointer to the buffer of data that will be transmitted to USB device or received from USB device.
<i>DataLength</i>	On input, indicates the size, in bytes, of the data buffer specified by <i>Data</i> . On output, indicates the amount of data actually transferred.
<i>Translator</i>	A pointer to the transaction translator data. See “Description” for the detailed information of this data structure.
<i>TimeOut</i>	Indicates the maximum time, in milliseconds, which the transfer is allowed to complete.
<i>TransferResult</i>	A pointer to the detailed result information generated by this control transfer. Refer to <b>UsbControlTransfer()</b> (Section 17.2.4) for transfer result types ( <b>EFI_USB_ERR_x</b> ).

## Description

This function is used to submit a control transfer to a target USB device specified by *DeviceAddress*. Control transfers are intended to support configuration/command/status type communication flows between host and USB device.

There are three control transfer types according to the data phase. If the *TransferDirection* parameter is **EfiUsbNoData**, *Data* is **NULL**, and *DataLength* is 0, then no data phase is present in the control transfer. If the *TransferDirection* parameter is **EfiUsbDataOut**, then *Data* specifies the data to be transmitted to the device, and *DataLength* specifies the number of bytes to transfer to the device. In this case, there is an OUT DATA stage followed by a SETUP stage. If the *TransferDirection* parameter is **EfiUsbDataIn**, then *Data* specifies the data to be received from the device, and *DataLength* specifies the number of bytes to receive from the device. In this case there is an IN DATA stage followed by a SETUP stage.

*Translator* is necessary to perform split transactions on low-speed or full-speed devices connected to a high-speed hub. Such transaction require the device connection information: device address and the port number of the hub that device is connected to. This information is passed through the fields of **EFI\_USB2\_HC\_TRANSACTION\_TRANSLATOR** structure. See “Related Definitions” for the structure field names. Translator is passed as **NULL** for the USB1.1 host controllers transfers or when the transfer is requested for high-speed device connected to USB2.0 controller.

If the control transfer has completed successfully, then **EFI\_SUCCESS** is returned. If the transfer cannot be completed within the timeout specified by *TimeOut*, then **EFI\_TIMEOUT** is returned. If an error other than timeout occurs during the USB transfer, then **EFI\_DEVICE\_ERROR** is returned and the detailed error code will be returned in the *TransferResult* parameter.

**EFI\_INVALID\_PARAMETER** is returned if one of the following conditions is satisfied:

- *TransferDirection* is invalid.

- *TransferDirection*, *Data*, and *DataLength* do not match one of the three control transfer types described above.
- *Request* pointer is **NULL**.
- *MaximumPacketLength* is not valid. If *DeviceSpeed* is **EFI\_USB\_SPEED\_LOW**, then *MaximumPacketLength* must be 8. If *DeviceSpeed* is **EFI\_USB\_SPEED\_FULL** or **EFI\_USB\_SPEED\_HIGH**, then *MaximumPacketLength* must be 8, 16, 32, or 64. If *DeviceSpeed* is **EFI\_USB\_SPEED\_SUPER**, then *MaximumPacketLength* must be 512.
- *TransferResult* pointer is **NULL**.
- *Translator* is **NULL** while the requested transfer requires split transaction. The conditions of the split transactions are described above in “Description” section.

### Status Codes Returned

EFI_SUCCESS	The control transfer was completed successfully.
EFI_OUT_OF_RESOURCES	The control transfer could not be completed due to a lack of resources.
EFI_INVALID_PARAMETER	Some parameters are invalid. The possible invalid parameters are described in “Description” above.
EFI_TIMEOUT	The control transfer failed due to timeout.
EFI_DEVICE_ERROR	The control transfer failed due to host controller or device error. Caller should check <i>TransferResult</i> for detailed error information.

## EFI\_USB2\_HC\_PROTOCOL.BulkTransfer()

### Summary

Submits bulk transfer to a bulk endpoint of a USB device.

### Prototype

```
typedef
EFI_STATUS
(EFI_API *EFI_USB2_HC_PROTOCOL_BULK_TRANSFER) (
  IN EFI_USB2_HC_PROTOCOL *This,
  IN UINT8 DeviceAddress,
  IN UINT8 EndPointAddress,
  IN UINT8 DeviceSpeed,
  IN UINTN MaximumPacketLength,
  IN UINT8 DataBuffersNumber,
  IN OUT VOID *Data[EFI_USB_MAX_BULK_BUFFER_NUM],
  IN OUT UINTN *DataLength,
  IN OUT UINT8 *DataToggle,
  IN UINTN TimeOut,
  IN EFI_USB2_HC_TRANSACTION_TRANSLATOR *Translator,
  OUT UINT32 *TransferResult
);
```

### Parameters

<i>This</i>	A pointer to the <a href="#">EFI_USB2_HC_PROTOCOL</a> instance. Type <a href="#">EFI_USB2_HC_PROTOCOL</a> is defined in <a href="#">Section 17.1</a> .
<i>DeviceAddress</i>	Represents the address of the target device on the USB, which is assigned during USB enumeration.
<i>EndPointAddress</i>	The combination of an endpoint number and an endpoint direction of the target USB device. Each endpoint address supports data transfer in one direction except the control endpoint (whose default endpoint address is 0). It is the caller's responsibility to make sure that the <i>EndPointAddress</i> represents a bulk endpoint.
<i>DeviceSpeed</i>	Indicates device speed. The supported values are <a href="#">EFI_USB_SPEED_FULL</a> , <a href="#">EFI_USB_SPEED_HIGH</a> or <a href="#">EFI_USB_SPEED_SUPER</a> .
<i>MaximumPacketLength</i>	Indicates the maximum packet size the target endpoint is capable of sending or receiving.
<i>DataBuffersNumber</i>	Number of data buffers prepared for the transfer.
<i>Data</i>	Array of pointers to the buffers of data that will be transmitted to USB device or received from USB device.

<i>DataLength</i>	When input, indicates the size, in bytes, of the data buffers specified by <i>Data</i> . When output, indicates the actually transferred data size.
<i>DataToggle</i>	A pointer to the data toggle value. On input, it indicates the initial data toggle value the bulk transfer should adopt; on output, it is updated to indicate the data toggle value of the subsequent bulk transfer.
<i>Translator</i>	A pointer to the transaction translator data. See <code>ControlTransfer()</code> “Description” for the detailed information of this data structure.
<i>TimeOut</i>	Indicates the maximum time, in milliseconds, which the transfer is allowed to complete.
<i>TransferResult</i>	A pointer to the detailed result information of the bulk transfer. Refer to <code>UsbControlTransfer()</code> ( <a href="#">Section 17.2.4</a> ) for transfer result types ( <code>EFI_USB_ERR_x</code> ).

## Description

This function is used to submit bulk transfer to a target endpoint of a USB device. The target endpoint is specified by *DeviceAddress* and *EndpointAddress*. Bulk transfers are designed to support devices that need to communicate relatively large amounts of data at highly variable times where the transfer can use any available bandwidth. Bulk transfers can be used only by full-speed and high-speed devices.

High-speed bulk transfers can be performed using multiple data buffers. The number of buffers that are actually prepared for the transfer is specified by *DataBuffersNumber*. For full-speed bulk transfers this value is ignored.

Data represents a list of pointers to the data buffers. For full-speed bulk transfers only the data pointed by *Data[0]* shall be used. For high-speed transfers depending on *DataLength* there several data buffers can be used. The total number of buffers must not exceed `EFI_USB_MAX_BULK_BUFFER_NUM`. See “Related Definitions” for the `EFI_USB_MAX_BULK_BUFFER_NUM` value.

The data transfer direction is determined by the endpoint direction that is encoded in the *EndPointAddress* parameter. Refer to *USB Specification, Revision 2.0* on the Endpoint Address encoding.

The *DataToggle* parameter is used to track target endpoint’s data sequence toggle bits. The USB provides a mechanism to guarantee data packet synchronization between data transmitter and receiver across multiple transactions. The data packet synchronization is achieved with the data sequence toggle bits and the DATA0/DATA1 PIDs. A bulk endpoint’s toggle sequence is initialized to DATA0 when the endpoint experiences a configuration event. It toggles between DATA0 and DATA1 in each successive data transfer. It is host’s responsibility to track the bulk endpoint’s data toggle sequence and set the correct value for each data packet. The input *DataToggle* value points to the data toggle value for the first data packet of this bulk transfer; the output *DataToggle* value points to the data toggle value for the last successfully transferred data packet of this bulk transfer. The caller should record the data toggle value for use in subsequent bulk transfers to the same endpoint.

If the bulk transfer is successful, then **EFI\_SUCCESS** is returned. If USB transfer cannot be completed within the timeout specified by *Timeout*, then **EFI\_TIMEOUT** is returned. If an error other than timeout occurs during the USB transfer, then **EFI\_DEVICE\_ERROR** is returned and the detailed status code is returned in *TransferResult*.

**EFI\_INVALID\_PARAMETER** is returned if one of the following conditions is satisfied:

- *Data* is **NULL**.
- *DataLength* is 0.
- *DeviceSpeed* is not valid; the legal values are **EFI\_USB\_SPEED\_FULL**, **EFI\_USB\_SPEED\_HIGH**, or **EFI\_USB\_SPEED\_SUPER**.
- *MaximumPacketLength* is not valid. The legal value of this parameter is 64 or less for full-speed, 512 or less for high-speed, and 1024 or less for super-speed transactions.
- *DataToggle* points to a value other than 0 and 1.
- *TransferResult* is **NULL**.

## Status Codes Returned

EFI_SUCCESS	The bulk transfer was completed successfully.
EFI_OUT_OF_RESOURCES	The bulk transfer could not be submitted due to lack of resource.
EFI_INVALID_PARAMETER	Some parameters are invalid. The possible invalid parameters are described in "Description" above.
EFI_TIMEOUT	The bulk transfer failed due to timeout.
EFI_DEVICE_ERROR	The bulk transfer failed due to host controller or device error. Caller should check <i>TransferResult</i> for detailed error information.

## EFI\_USB2\_HC\_PROTOCOL.AsyncInterruptTransfer()

### Summary

Submits an asynchronous interrupt transfer to an interrupt endpoint of a USB device.

### Prototype

```
typedef
EFI_STATUS
(EFI_API *EFI_USB2_HC_PROTOCOL_ASYNC_INTERRUPT_TRANSFER) (
    IN EFI_USB2_HC_PROTOCOL    *This,
    IN UINT8                   DeviceAddress,
    IN UINT8                   EndPointAddress,
    IN UINT8                   DeviceSpeed,
    IN UINTN                   MaximumPacketLength,
    IN BOOLEAN                 IsNewTransfer,
    IN OUT UINT8               *DataToggle,
    IN UINTN                   PollingInterval OPTIONAL,
    IN UINTN                   DataLength OPTIONAL,
    IN EFI_USB2_HC_TRANSACTION_TRANSLATOR *Translator OPTIONAL,
    IN EFI_ASYNC_USB_TRANSFER_CALLBACK CallbackFunction OPTIONAL,
    IN VOID                    *Context OPTIONAL
);
```

### Parameters

<i>This</i>	A pointer to the <a href="#">EFI_USB2_HC_PROTOCOL</a> instance. Type <a href="#">EFI_USB2_HC_PROTOCOL</a> is defined in <a href="#">Section 17.1</a> .
<i>DeviceAddress</i>	Represents the address of the target device on the USB, which is assigned during USB enumeration.
<i>EndPointAddress</i>	The combination of an endpoint number and an endpoint direction of the target USB device. Each endpoint address supports data transfer in one direction except the control endpoint (whose default endpoint address is zero). It is the caller's responsibility to make sure that the <i>EndPointAddress</i> represents an interrupt endpoint.
<i>DeviceSpeed</i>	Indicates device speed. See "Related Definitions" in <a href="#">EFI_USB2_HC_PROTOCOL.ControlTransfer()</a> for a list of the supported values.
<i>MaximumPacketLength</i>	Indicates the maximum packet size the target endpoint is capable of sending or receiving.
<i>IsNewTransfer</i>	If <b>TRUE</b> , an asynchronous interrupt pipe is built between the host and the target interrupt endpoint. If <b>FALSE</b> , the specified asynchronous interrupt pipe is canceled. If <b>TRUE</b> , and an interrupt transfer exists for the target endpoint, then <b>EFI_INVALID_PARAMETER</b> is returned.
<i>DataToggle</i>	A pointer to the data toggle value. On input, it is valid when <i>IsNewTransfer</i> is <b>TRUE</b> , and it indicates the initial

	data toggle value the asynchronous interrupt transfer should adopt. On output, it is valid when <i>IsNewTransfer</i> is <b>FALSE</b> , and it is updated to indicate the data toggle value of the subsequent asynchronous interrupt transfer.
<i>PollingInterval</i>	Indicates the interval, in milliseconds, that the asynchronous interrupt transfer is polled. This parameter is required when <i>IsNewTransfer</i> is <b>TRUE</b> .
<i>DataLength</i>	Indicates the length of data to be received at the rate specified by <i>PollingInterval</i> from the target asynchronous interrupt endpoint. This parameter is only required when <i>IsNewTransfer</i> is <b>TRUE</b> .
<i>Translator</i>	A pointer to the transaction translator data.
<i>CallbackFunction</i>	The Callback function. This function is called at the rate specified by <i>PollingInterval</i> . This parameter is only required when <i>IsNewTransfer</i> is <b>TRUE</b> . Refer to <b>UsbAsyncInterruptTransfer()</b> ( <a href="#">Section 17.2.4</a> ) for the definition of this function type.
<i>Context</i>	The context that is passed to the <i>CallbackFunction</i> . This is an optional parameter and may be <b>NULL</b> .

## Description

This function is used to submit asynchronous interrupt transfer to a target endpoint of a USB device. The target endpoint is specified by *DeviceAddress* and *EndpointAddress*. In the USB Specification, Revision 2.0, interrupt transfer is one of the four USB transfer types. In the [EFI USB2 HC PROTOCOL](#), interrupt transfer is divided further into synchronous interrupt transfer and asynchronous interrupt transfer.

An asynchronous interrupt transfer is typically used to query a device's status at a fixed rate. For example, keyboard, mouse, and hub devices use this type of transfer to query their interrupt endpoints at a fixed rate. The asynchronous interrupt transfer is intended to support the interrupt transfer type of "submit once, execute periodically." Unless an explicit request is made, the asynchronous transfer will never retire.

If *IsNewTransfer* is **TRUE**, then an interrupt transfer is started at a fixed rate. The rate is specified by *PollingInterval*, the size of the receive buffer is specified by *DataLength*, and the callback function is specified by *CallbackFunction*. *Context* specifies an optional context that is passed to the *CallbackFunction* each time it is called. The *CallbackFunction* is intended to provide a means for the host to periodically process interrupt transfer data.

If *IsNewTransfer* is **TRUE**, and an interrupt transfer exists for the target end point, then **EFI\_INVALID\_PARAMETER** is returned.

If *IsNewTransfer* is **FALSE**, then the interrupt transfer is canceled.

**EFI\_INVALID\_PARAMETER** is returned if one of the following conditions is satisfied:

- Data transfer direction indicated by *EndPointAddress* is other than *EfiUsbDataIn*.
- *IsNewTransfer* is **TRUE** and *DataLength* is 0.
- *IsNewTransfer* is **TRUE** and *DataToggle* points to a value other than 0 and 1.

- *IsNewTransfer* is **TRUE** and *PollingInterval* is not in the range 1..255.
- *IsNewTransfer* requested where an interrupt transfer exists for the target end point.

### Status Codes Returned

EFI_SUCCESS	The asynchronous interrupt transfer request has been successfully submitted or canceled.
EFI_INVALID_PARAMETER	Some parameters are invalid. The possible invalid parameters are described in “Description” above. When an interrupt transfer exists for the target end point and a new transfer is requested, EFI_INVALID_PARAMETER is returned.
EFI_OUT_OF_RESOURCES	The request could not be completed due to a lack of resources.



## EFI\_USB2\_HC\_PROTOCOL.SyncInterruptTransfer()

### Summary

Submits synchronous interrupt transfer to an interrupt endpoint of a USB device.

### Prototype

```
typedef
EFI_STATUS
(EFI_API *EFI_USB2_HC_PROTOCOL_SYNC_INTERRUPT_TRANSFER) (
  IN EFI_USB2_HC_PROTOCOL  *This,
  IN UINT8                 DeviceAddress,
  IN UINT8                 EndPointAddress,
  IN UINT8                 DeviceSpeed,
  IN UINTN                 MaximumPacketLength,
  IN OUT VOID              *Data,
  IN OUT UINTN             *DataLength,
  IN OUT UINT8             *DataToggle,
  IN UINTN                 TimeOut,
  IN EFI_USB2_HC_TRANSACTION_TRANSLATOR *Translator
  OUT UINT32               *TransferResult
);
```

### Parameters

<i>This</i>	A pointer to the <a href="#">EFI_USB2_HC_PROTOCOL</a> instance. Type <a href="#">EFI_USB2_HC_PROTOCOL</a> is defined in <a href="#">Section 17.1</a> .
<i>DeviceAddress</i>	Represents the address of the target device on the USB, which is assigned during USB enumeration.
<i>EndPointAddress</i>	The combination of an endpoint number and an endpoint direction of the target USB device. Each endpoint address supports data transfer in one direction except the control endpoint (whose default endpoint address is zero). It is the caller's responsibility to make sure that the <i>EndPointAddress</i> represents an interrupt endpoint.
<i>DeviceSpeed</i>	Indicates device speed. See "Related Definitions" in <a href="#">ControlTransfer()</a> for a list of the supported values.
<i>MaximumPacketLength</i>	Indicates the maximum packet size the target endpoint is capable of sending or receiving.
<i>Data</i>	A pointer to the buffer of data that will be transmitted to USB device or received from USB device.
<i>DataLength</i>	On input, the size, in bytes, of the data buffer specified by <i>Data</i> . On output, the number of bytes transferred.
<i>DataToggle</i>	A pointer to the data toggle value. On input, it indicates the initial data toggle value the synchronous interrupt transfer should adopt; on output, it is updated to indicate

- TimeOut* the data toggle value of the subsequent synchronous interrupt transfer.

Indicates the maximum time, in milliseconds, which the transfer is allowed to complete.
- Translator* A pointer to the transaction translator data.
- TransferResult* A pointer to the detailed result information from the synchronous interrupt transfer. Refer to **UsbControlTransfer()** (Section 17.2.4) for transfer result types (**EFI\_USB\_ERR\_x**).

## Description

This function is used to submit a synchronous interrupt transfer to a target endpoint of a USB device. The target endpoint is specified by *DeviceAddress* and *EndpointAddress*. In the USB Specification, Revision 2.0, interrupt transfer is one of the four USB transfer types. In the [EFI\\_USB2\\_HC\\_PROTOCOL](#), interrupt transfer is divided further into synchronous interrupt transfer and asynchronous interrupt transfer.

The synchronous interrupt transfer is designed to retrieve small amounts of data from a USB device through an interrupt endpoint. A synchronous interrupt transfer is only executed once for each request. This is the most significant difference from the asynchronous interrupt transfer.

If the synchronous interrupt transfer is successful, then **EFI\_SUCCESS** is returned. If the USB transfer cannot be completed within the timeout specified by *Timeout*, then **EFI\_TIMEOUT** is returned. If an error other than timeout occurs during the USB transfer, then **EFI\_DEVICE\_ERROR** is returned and the detailed status code is returned in *TransferResult*.

**EFI\_INVALID\_PARAMETER** is returned if one of the following conditions is satisfied:

- *Data* is **NULL**.
- *DataLength* is 0.
- *MaximumPacketLength* is not valid. The legal value of this parameter should be 3072 or less for high-speed device, 64 or less for a full-speed device; for a slow device, it is limited to 8 or less. For the full-speed device, it should be 8, 16, 32, or 64; for the slow device, it is limited to 8.
- *DataToggle* points to a value other than 0 and 1.
- *TransferResult* is **NULL**.

## Status Codes Returned

EFI_SUCCESS	The synchronous interrupt transfer was completed successfully.
EFI_OUT_OF_RESOURCES	The synchronous interrupt transfer could not be submitted due to lack of resource.
EFI_INVALID_PARAMETER	Some parameters are invalid. The possible invalid parameters are described in "Description" above.
EFI_TIMEOUT	The synchronous interrupt transfer failed due to timeout.

EFI_DEVICE_ERROR	The synchronous interrupt transfer failed due to host controller or device error. Caller should check <i>TransferResult</i> for detailed error information.
------------------	---

## EFI\_USB2\_HC\_PROTOCOL.IsochronousTransfer()

### Summary

Submits isochronous transfer to an isochronous endpoint of a USB device.

### Prototype

```
typedef
EFI_STATUS
(EFI_API *EFI_USB2_HC_PROTOCOL_ISOCHRONOUS_TRANSFER) (
    IN EFI_USB2_HC_PROTOCOL *This,
    IN UINT8 DeviceAddress,
    IN UINT8 EndPointAddress,
    IN UINT8 DeviceSpeed,
    IN UINTN MaximumPacketLength,
    IN UINT8 DataBuffersNumber,
    IN OUT VOID *Data[EFI_USB_MAX_ISO_BUFFER_NUM],
    IN UINTN DataLength,
    IN EFI_USB2_HC_TRANSACTION_TRANSLATOR *Translator,
    OUT UINT32 *TransferResult
);
```

### Related Definitions

```
#define EFI_USB_MAX_ISO_BUFFER_NUM 7
#define EFI_USB_MAX_ISO_BUFFER_NUM1 2
```

### Parameters

<i>This</i>	A pointer to the <a href="#">EFI_USB2_HC_PROTOCOL</a> instance. Type <a href="#">EFI_USB2_HC_PROTOCOL</a> is defined in <a href="#">Section 17.1</a> .
<i>DeviceAddress</i>	Represents the address of the target device on the USB, which is assigned during USB enumeration.
<i>EndPointAddress</i>	The combination of an endpoint number and an endpoint direction of the target USB device. Each endpoint address supports data transfer in one direction except the control endpoint (whose default endpoint address is 0). It is the caller's responsibility to make sure that the <i>EndPointAddress</i> represents an isochronous endpoint.
<i>DeviceSpeed</i>	Indicates device speed. The supported values are <a href="#">EFI_USB_SPEED_FULL</a> , <a href="#">EFI_USB_SPEED_HIGH</a> , or <a href="#">EFI_USB_SPEED_SUPER</a> .
<i>MaximumPacketLength</i>	Indicates the maximum packet size the target endpoint is capable of sending or receiving. For isochronous endpoints, this value is used to reserve the bus time in the schedule, required for the per-frame data payloads. The pipe may, on an ongoing basis, actually use less bandwidth than that reserved.
<i>DataBuffersNumber</i>	Number of data buffers prepared for the transfer.

<i>Data</i>	Array of pointers to the buffers of data that will be transmitted to USB device or received from USB device.
<i>DataLength</i>	Specifies the length, in bytes, of the data to be sent to or received from the USB device.
<i>Translator</i>	A pointer to the transaction translator data. See <code>ControlTransfer()</code> “Description” for the detailed information of this data structure.
<i>TransferResult</i>	A pointer to the detail result information of the isochronous transfer. Refer to <code>UsbControlTransfer()</code> ( <a href="#">Section 17.2.4</a> ) for transfer result types ( <code>EFI_USB_ERR_x</code> ).

## Description

This function is used to submit isochronous transfer to a target endpoint of a USB device. The target endpoint is specified by *DeviceAddress* and *EndpointAddress*. Isochronous transfers are used when working with isochronous data. It provides periodic, continuous communication between the host and a device. Isochronous transfers can be used only by full-speed, high-speed, and super-speed devices.

High-speed isochronous transfers can be performed using multiple data buffers. The number of buffers that are actually prepared for the transfer is specified by *DataBuffersNumber*. For full-speed isochronous transfers this value is ignored.

Data represents a list of pointers to the data buffers. For full-speed isochronous transfers only the data pointed by *Data[0]* shall be used. For high-speed isochronous transfers and for the split transactions depending on *DataLength* there several data buffers can be used. For the high-speed isochronous transfers the total number of buffers must not exceed `EFI_USB_MAX_ISO_BUFFER_NUM`. For split transactions performed on full-speed device by high-speed host controller the total number of buffers is limited to `EFI_USB_MAX_ISO_BUFFER_NUM1`. See “Related Definitions” for the `EFI_USB_MAX_ISO_BUFFER_NUM` and `EFI_USB_MAX_ISO_BUFFER_NUM1` values.

If the isochronous transfer is successful, then `EFI_SUCCESS` is returned. The isochronous transfer is designed to be completed within one USB frame time, if it cannot be completed, `EFI_TIMEOUT` is returned. If an error other than timeout occurs during the USB transfer, then `EFI_DEVICE_ERROR` is returned and the detailed status code will be returned in *TransferResult*.

`EFI_INVALID_PARAMETER` is returned if one of the following conditions is satisfied:

- *Data* is `NULL`.
- *DataLength* is 0.
- *DeviceSpeed* is not one of the supported values listed above.
- *MaximumPacketLength* is invalid. *MaximumPacketLength* must be 1023 or less for full-speed devices, and 1024 or less for high-speed and super-speed devices.
- *TransferResult* is `NULL`.

## Status Codes Returned

EFI_SUCCESS	The isochronous transfer was completed successfully.
-------------	--

EFI_OUT_OF_RESOURCES	The isochronous transfer could not be submitted due to lack of resource.
EFI_INVALID_PARAMETER	Some parameters are invalid. The possible invalid parameters are described in "Description" above.
EFI_TIMEOUT	The isochronous transfer cannot be completed within the one USB frame time.
EFI_DEVICE_ERROR	The isochronous transfer failed due to host controller or device error. Caller should check <i>TransferResult</i> for detailed error information.
EFI_UNSUPPORTED	The implementation doesn't support an Isochronous transfer function.

## EFI\_USB2\_HC\_PROTOCOL.AsyncIsochronousTransfer()

### Summary

Submits nonblocking isochronous transfer to an isochronous endpoint of a USB device.

### Prototype

```
typedef
EFI_STATUS
(EFI_API * EFI_USB2_HC_PROTOCOL_ASYNC_ISOCHRONOUS_TRANSFER) (
  IN EFI_USB2_HC_PROTOCOL *This,
  IN UINT8 DeviceAddress,
  IN UINT8 EndPointAddress,
  IN UINT8 DeviceSpeed,
  IN UINTN MaximumPacketLength,
  IN UINT8 DataBuffersNumber,
  IN OUT VOID *Data[EFI_USB_MAX_ISO_BUFFER_NUM],
  IN UINTN DataLength,
  IN EFI_USB2_HC_TRANSACTION_TRANSLATOR *Translator,
  IN EFI_ASYNC_USB_TRANSFER_CALLBACK IsochronousCallBack,
  IN VOID *Context OPTIONAL
);
```

### Parameters

<i>This</i>	A pointer to the <a href="#">EFI USB2 HC PROTOCOL</a> instance. Type <a href="#">EFI_USB2_HC_PROTOCOL</a> is defined in <a href="#">Section 17.1</a> .
<i>DeviceAddress</i>	Represents the address of the target device on the USB, which is assigned during USB enumeration.
<i>EndPointAddress</i>	The combination of an endpoint number and an endpoint direction of the target USB device. Each endpoint address supports data transfer in one direction except the control endpoint (whose default endpoint address is zero). It is the caller's responsibility to make sure that the <i>EndPointAddress</i> represents an isochronous endpoint.
<i>DeviceSpeed</i>	Indicates device speed. The supported values are <a href="#">EFI_USB_SPEED_FULL</a> , <a href="#">EFI_USB_SPEED_HIGH</a> , or <a href="#">EFI_USB_SPEED_SUPER</a> .
<i>MaximumPacketLength</i>	Indicates the maximum packet size the target endpoint is capable of sending or receiving. For isochronous endpoints, this value is used to reserve the bus time in the schedule, required for the per-frame data payloads. The pipe may, on an ongoing basis, actually use less bandwidth than that reserved.
<i>DataBuffersNumber</i>	Number of data buffers prepared for the transfer.
<i>Data</i>	Array of pointers to the buffers of data that will be transmitted to USB device or received from USB device.

<i>DataLength</i>	Specifies the length, in bytes, of the data to be sent to or received from the USB device.
<i>Translator</i>	A pointer to the transaction translator data. See <code>ControlTransfer()</code> “Description” for the detailed information of this data structure.
<i>IsochronousCallback</i>	The Callback function. This function is called if the requested isochronous transfer is completed. Refer to <b>UsbAsyncInterruptTransfer()</b> ( <a href="#">Section 17.2.4</a> ) for the definition of this function type.
<i>Context</i>	Data passed to the <i>IsochronousCallback</i> function. This is an optional parameter and may be <b>NULL</b> .

## Description

This is an asynchronous type of USB isochronous transfer. If the caller submits a USB isochronous transfer request through this function, this function will return immediately. When the isochronous transfer completes, the **IsochronousCallback** function will be triggered, the caller can know the transfer results. If the transfer is successful, the caller can get the data received or sent in this callback function.

The target endpoint is specified by *DeviceAddress* and *EndpointAddress*. Isochronous transfers are used when working with isochronous data. It provides periodic, continuous communication between the host and a device. Isochronous transfers can be used only by full-speed, high-speed, and super-speed devices.

High-speed isochronous transfers can be performed using multiple data buffers. The number of buffers that are actually prepared for the transfer is specified by *DataBuffersNumber*. For full-speed isochronous transfers this value is ignored.

Data represents a list of pointers to the data buffers. For full-speed isochronous transfers only the data pointed by *Data[0]* shall be used. For high-speed isochronous transfers and for the split transactions depending on *DataLength* there several data buffers can be used. For the high-speed isochronous transfers the total number of buffers must not exceed **EFI\_USB\_MAX\_ISO\_BUFFER\_NUM**. For split transactions performed on full-speed device by high-speed host controller the total number of buffers is limited to **EFI\_USB\_MAX\_ISO\_BUFFER\_NUM1** See “Related Definitions” in `IsochronousTransfer()` section for the **EFI\_USB\_MAX\_ISO\_BUFFER\_NUM** and **EFI\_USB\_MAX\_ISO\_BUFFER\_NUM1** values.

**EFI\_INVALID\_PARAMETER** is returned if one of the following conditions is satisfied:

- *Data* is **NULL**.
- *DataLength* is 0.
- *DeviceSpeed* is not one of the supported values listed above.
- *MaximumPacketLength* is invalid. *MaximumPacketLength* must be 1023 or less for full-speed devices and 1024 or less for high-speed and super-speed devices.



## Status Codes Returned

EFI_SUCCESS	The asynchronous isochronous transfer was completed successfully.
EFI_OUT_OF_RESOURCES	The asynchronous isochronous transfer could not be submitted due to lack of resource.
EFI_INVALID_PARAMETER	Some parameters are invalid. The possible invalid parameters are described in "Description" above.
EFI_UNSUPPORTED	The implementation doesn't support Isochronous transfer function

## EFI\_USB2\_HC\_PROTOCOL.GetRootHubPortStatus()

### Summary

Retrieves the current status of a USB root hub port.

### Prototype

```
typedef
EFI_STATUS
(EFI_API *EFI_USB2_HC_PROTOCOL_GET_ROOTHUB_PORT_STATUS) (
    IN EFI_USB2_HC_PROTOCOL *This,
    IN UINT8    PortNumber,
    OUT EFI_USB_PORT_STATUS *PortStatus
);
```

### Parameters

<i>This</i>	A pointer to the <a href="#">EFI_USB2_HC_PROTOCOL</a> instance. Type <a href="#">EFI_USB2_HC_PROTOCOL</a> is defined in <a href="#">Section 17.1</a> .
<i>PortNumber</i>	Specifies the root hub port from which the status is to be retrieved. This value is zero based. For example, if a root hub has two ports, then the first port is numbered 0, and the second port is numbered 1.
<i>PortStatus</i>	A pointer to the current port status bits and port status change bits. The type <a href="#">EFI_USB_PORT_STATUS</a> is defined in "Related Definitions" below.

### Related Definitions

```
typedef struct {
    UINT16 PortStatus;
    UINT16 PortChangeStatus;
} EFI_USB_PORT_STATUS;

//*****
// EFI_USB_PORT_STATUS.PortStatus bit definition
//*****
#define USB_PORT_STAT_CONNECTION 0x0001
#define USB_PORT_STAT_ENABLE    0x0002
#define USB_PORT_STAT_SUSPEND   0x0004
#define USB_PORT_STAT_OVERCURRENT 0x0008
#define USB_PORT_STAT_RESET     0x0010
#define USB_PORT_STAT_POWER     0x0100
#define USB_PORT_STAT_LOW_SPEED 0x0200
#define USB_PORT_STAT_HIGH_SPEED 0x0400
#define USB_PORT_STAT_SUPER_SPEED 0x0800
#define USB_PORT_STAT_OWNER     0x2000
```

```
//*****  
// EFI_USB_PORT_STATUS.PortChangeStatus bit definition  
//*****  
#define USB_PORT_STAT_C_CONNECTION 0x0001  
#define USB_PORT_STAT_C_ENABLE 0x0002  
#define USB_PORT_STAT_C_SUSPEND 0x0004  
#define USB_PORT_STAT_C_OVERCURRENT 0x0008  
#define USB_PORT_STAT_C_RESET 0x0010
```

*PortStatus* Contains current port status bitmap. The root hub port status bitmap is unified with the USB hub port status bitmap. See [Table 137](#) for a reference, which is borrowed from *Chapter 11, Hub Specification, of USB Specification, Revision 1.1*.

*PortChangeStatus* Contains current port status change bitmap. The root hub port change status bitmap is unified with the USB hub port status bitmap. See [Table 138](#) for a reference, which is borrowed from *Chapter 11, Hub Specification, of USB Specification, Revision 1.1*.

**Table 137. USB Hub Port Status Bitmap**

Bit	Description
0	<b>Current Connect Status:</b> (USB_PORT_STAT_CONNECTION) This field reflects whether or not a device is currently connected to this port. 0 = No device is present 1 = A device is present on this port
1	<b>Port Enable / Disabled:</b> (USB_PORT_STAT_ENABLE) Ports can be enabled by software only. Ports can be disabled by either a fault condition (disconnect event or other fault condition) or by software. 0 = Port is disabled 1 = Port is enabled
2	<b>Suspend:</b> (USB_PORT_STAT_SUSPEND) This field indicates whether or not the device on this port is suspended. 0 = Not suspended 1 = Suspended
3	<b>Over-current Indicator:</b> (USB_PORT_STAT_OVERCURRENT) This field is used to indicate that the current drain on the port exceeds the specified maximum. 0 = All no over-current condition exists on this port 1 = An over-current condition exists on this port
4	<b>Reset:</b> (USB_PORT_STAT_RESET) Indicates whether port is in reset state. 0 = Port is not in reset state 1 = Port is in reset state
5-7	Reserved These bits return 0 when read.
8	<b>Port Power:</b> (USB_PORT_STAT_POWER) This field reflects a port's logical, power control state. 0 = This port is in the Powered-off state 1 = This port is not in the Powered-off state
9	<b>Low Speed Device Attached:</b> (USB_PORT_STAT_LOW_SPEED) This is relevant only if a device is attached. 0 = Full-speed device attached to this port 1 = Low-speed device attached to this port
10	<b>High Speed Device Attached:</b> (USB_PORT_STAT_HIGH_SPEED) This field indicates whether the connected device is high-speed device 0 = High-speed device is not attached to this port 1 = High-speed device attached to this port NOTE: this bit has precedence over Bit 9; if set, bit 9 must be ignored.
11	<b>Super Speed Device Attached:</b> (USB_PORT_STAT_SUPER_SPEED) This field indicates whether the connected device is a super-speed device. 0 = Super-speed device is not attached to this port. 1 = Super-speed device is attached to this port. NOTE: This bit has precedence over Bit 9 and Bit 10; if set bits 9,10 must be ignored.
12	Reserved. Bit returns 0 when read.
13	The host controller owns the specified port. 0 = Controller does not own the port. 1 = Controller owns the port

Bit	Description
14-15	Reserved These bits return 0 when read.

Table 138. Hub Port Change Status Bitmap

Bit	Description
0	<b>Connect Status Change:</b> (USB_PORT_STAT_C_CONNECTION) Indicates a change has occurred in the port's Current Connect Status. 0 = No change has occurred to Current Connect status 1 = Current Connect status has changed
1	<b>Port Enable /Disable Change:</b> (USB_PORT_STAT_C_ENABLE) 0 = No change 1 = Port enabled/disabled status has changed
2	<b>Suspend Change:</b> (USB_PORT_STAT_C_SUSPEND) This field indicates a change in the host-visible suspend state of the attached device. 0 = No change 1 = Resume complete
3	<b>Over-Current Indicator Change:</b> (USB_PORT_STAT_C_OVERCURRENT) 0 = No change has occurred to Over-Current Indicator 1 = Over-Current Indicator has changed
4	<b>Reset Change:</b> (USB_PORT_STAT_C_RESET) This field is set when reset processing on this port is complete. 0 = No change 1 = Reset complete
5-15	Reserved. These bits return 0 when read.

## Description

This function is used to retrieve the status of the root hub port specified by *PortNumber*. [EFI USB PORT STATUS](#) describes the port status of a specified USB port. This data structure is designed to be common to both a USB root hub port and a USB hub port.

The number of root hub ports attached to the USB host controller can be determined with the function [GetRootHubPortStatus\(\)](#). If *PortNumber* is greater than or equal to the number of ports returned by [GetRootHubPortNumber\(\)](#), then **EFI\_INVALID\_PARAMETER** is returned. Otherwise, the status of the USB root hub port is returned in *PortStatus*, and **EFI\_SUCCESS** is returned.

## Status Codes Returned

EFI_SUCCESS	The status of the USB root hub port specified by <i>PortNumber</i> was returned in <i>PortStatus</i> .
EFI_INVALID_PARAMETER	<i>PortNumber</i> is invalid.

## EFI\_USB2\_HC\_PROTOCOL.SetRootHubPortFeature()

### Summary

Sets a feature for the specified root hub port.

### Prototype

```
typedef
EFI_STATUS
(EFI_API *EFI_USB2_HC_PROTOCOL_SET_ROOTHUB_PORT_FEATURE) (
    IN EFI_USB2_HC_PROTOCOL *This,
    IN UINT8    PortNumber,
    IN EFI_USB_PORT_FEATURE PortFeature
);
```

### Parameters

<i>This</i>	A pointer to the <a href="#">EFI_USB2_HC_PROTOCOL</a> instance. Type <a href="#">EFI_USB2_HC_PROTOCOL</a> is defined in <a href="#">Section 17.1</a> .
<i>PortNumber</i>	Specifies the root hub port whose feature is requested to be set. This value is zero based. For example, if a root hub has two ports, then the first port is number 0, and the second port is numbered 1.
<i>PortFeature</i>	Indicates the feature selector associated with the feature set request. The port feature indicator is defined in “Related Definitions” and <a href="#">Table 139</a> below.

### Related Definitions

```
typedef enum {
    EfiUsbPortEnable    = 1,
    EfiUsbPortSuspend  = 2,
    EfiUsbPortReset    = 4,
    EfiUsbPortPower    = 8,
    EfiUsbPortOwner    = 13,
    EfiUsbPortConnectChange = 16,
    EfiUsbPortEnableChange = 17,
    EfiUsbPortSuspendChange = 18,
    EfiUsbPortOverCurrentChange = 19,
    EfiUsbPortResetChange = 20
} EFI_USB_PORT_FEATURE;
```

The feature values specified in the enumeration variable have special meaning. Each value indicates its bit index in the port status and status change bitmaps, if combines these two bitmaps into a 32-bit bitmap. The meaning of each port feature is listed in [Table 139](#).

Table 139. USB Port Features

Port Feature	For SetRootHubPortFeature	For ClearRootHubPortFeature
EfiUsbPortEnable	Enable the given port of the root hub.	Disable the given port of the root hub.
EfiUsbPortSuspend	Put the given port into suspend state.	Restore the given port from the previous suspend state.
EfiUsbPortReset	Reset the given port of the root hub.	Clear the RESET signal for the given port of the root hub.
EfiUsbPortPower	Power the given port.	Shutdown the power from the given port.
EfiUsbPortOwner	N/A.	Releases the port ownership of this port to companion host controller.
EfiUsbPortConnectChange	N/A.	Clear USB_PORT_STAT_C_CONNECTION bit of the given port of the root hub.
EfiUsbPortEnableChange	N/A.	Clear USB_PORT_STAT_C_ENABLE bit of the given port of the root hub.
EfiUsbPortSuspendChange	N/A.	Clear USB_PORT_STAT_C_SUSPEND bit of the given port of the root hub.
EfiUsbPortOverCurrentChange	N/A.	Clear USB_PORT_STAT_C_OVERCURRENT bit of the given port of the root hub.
EfiUsbPortResetChange	N/A.	Clear USB_PORT_STAT_C_RESET bit of the given port of the root hub.

## Description

This function sets the feature specified by *PortFeature* for the USB root hub port specified by *PortNumber*. Setting a feature enables that feature or starts a process associated with that feature. For the meanings about the defined features, please refer to [Table 137](#) and [Table 138](#).

The number of root hub ports attached to the USB host controller can be determined with the function [GetRootHubPortStatus\(\)](#). If *PortNumber* is greater than or equal to the number of ports returned by [GetRootHubPortNumber\(\)](#), then **EFI\_INVALID\_PARAMETER** is returned. If *PortFeature* is not **EfiUsbPortEnable**, **EfiUsbPortSuspend**, **EfiUsbPortReset** nor **EfiUsbPortPower**, then **EFI\_INVALID\_PARAMETER** is returned.

## Status Codes Returned

EFI_SUCCESS	The feature specified by <i>PortFeature</i> was set for the USB root hub port specified by <i>PortNumber</i> .
EFI_INVALID_PARAMETER	<i>PortNumber</i> is invalid or <i>PortFeature</i> is invalid for this function.

## EFI\_USB2\_HC\_PROTOCOL.ClearRootHubPortFeature()

### Summary

Clears a feature for the specified root hub port.

### Prototype

```
typedef
EFI_STATUS
(EFI_API *EFI_USB2_HC_PROTOCOL_CLEAR_ROOTHUB_PORT_FEATURE) (
    IN EFI_USB2_HC_PROTOCOL *This
    IN UINT8    PortNumber,
    IN EFI_USB_PORT_FEATURE PortFeature
);
```

### Parameters

- This* A pointer to the [EFI\\_USB2\\_HC\\_PROTOCOL](#) instance. Type [EFI\\_USB2\\_HC\\_PROTOCOL](#) is defined in [Section 17.1](#).
- PortNumber* Specifies the root hub port whose feature is requested to be cleared. This value is zero-based. For example, if a root hub has two ports, then the first port is number 0, and the second port is numbered 1.
- PortFeature* Indicates the feature selector associated with the feature clear request. The port feature indicator ([EFI\\_USB\\_PORT\\_FEATURE](#)) is defined in the “Related Definitions” section of the [SetRootHubPortFeature\(\)](#) function description and in [Table 139](#).

### Description

This function clears the feature specified by *PortFeature* for the USB root hub port specified by *PortNumber*. Clearing a feature disables that feature or stops a process associated with that feature. For the meanings about the defined features, refer to [Table 137](#) and [Table 138](#).

The number of root hub ports attached to the USB host controller can be determined with the function [GetRootHubPortStatus\(\)](#). If *PortNumber* is greater than or equal to the number of ports returned by [GetRootHubPortNumber\(\)](#), then **EFI\_INVALID\_PARAMETER** is returned. If *PortFeature* is not **EfiUsbPortEnable**, **EfiUsbPortSuspend**, **EfiUsbPortPower**, **EfiUsbPortConnectChange**, **EfiUsbPortResetChange**, **EfiUsbPortEnableChange**, **EfiUsbPortSuspendChange**, or **EfiUsbPortOverCurrentChange**, then **EFI\_INVALID\_PARAMETER** is returned.

### Status Codes Returned

EFI_SUCCESS	The feature specified by <i>PortFeature</i> was cleared for the USB root hub port specified by <i>PortNumber</i> .
EFI_INVALID_PARAMETER	<i>PortNumber</i> is invalid or <i>PortFeature</i> is invalid.



## 17.2 USB Driver Model

### 17.2.1 Scope

[Section 17.2](#) describes the USB Driver Model. This includes the behavior of USB Bus Drivers, the behavior of a USB Device Drivers, and a detailed description of the EFI USB I/O Protocol. This document provides enough material to implement a USB Bus Driver, and the tools required to design and implement USB Device Drivers. It does not provide any information on specific USB devices.

The material contained in this section is designed to extend this specification and the *UEFI Driver Model* in a way that supports USB device drivers and USB bus drivers. These extensions are provided in the form of USB specific protocols. This document provides the information required to implement a USB Bus Driver in system firmware. The document also contains the information required by driver writers to design and implement USB Device Drivers that a platform may need to boot a UEFI-compliant OS.

The USB Driver Model described here is intended to be a foundation on which a USB Bus Driver and a wide variety of USB Device Drivers can be created. USB Driver Model Overview

The USB Driver Stack includes the USB Bus Driver, USB Host Controller Driver, and individual USB device drivers.

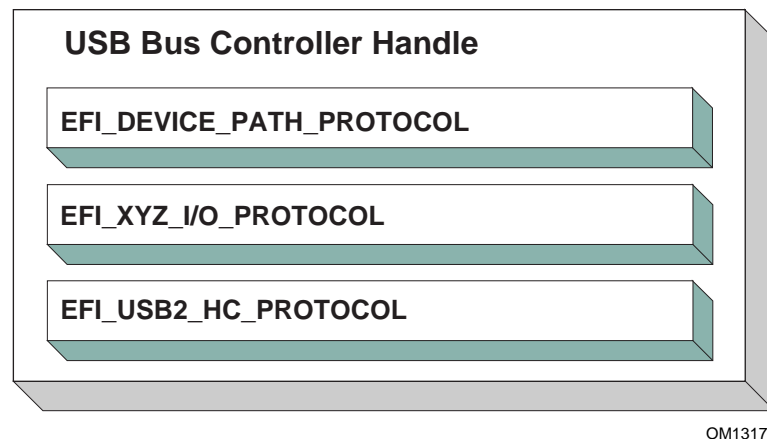

Figure 59. USB Bus Controller Handle

In the USB Bus Driver Design, the USB Bus Controller is managed by two drivers. One is USB Host Controller Driver, which consumes its parent bus **EFI\_XYZ\_IO\_PROTOCOL**, and produces **EFI\_USB2\_HC\_PROTOCOL** and attaches it to the Bus Controller Handle. The other one is USB Bus Driver, which consumes **EFI\_USB2\_HC\_PROTOCOL**, and performs bus enumeration. [Figure 59](#) shows protocols that are attached to the USB Bus Controller Handle. Detailed descriptions are presented in the following sections.

## 17.2.2 USB Bus Driver

USB Bus Driver performs periodic Enumeration on the USB Bus. In USB bus enumeration, when a new USB controller is found, the bus driver does some standard configuration for that new controller, and creates a device handle for it. The [EFI\\_USB\\_IO\\_PROTOCOL](#) and the [EFI\\_DEVICE\\_PATH\\_PROTOCOL](#) are attached to the device handle so that the USB controller can be accessed. The USB Bus Driver is also responsible for connecting USB device drivers to USB controllers. When a USB device is detached from a USB bus, the USB bus driver will stop that USB controller, and uninstall the [EFI\\_USB\\_IO\\_PROTOCOL](#) and the [EFI\\_DEVICE\\_PATH\\_PROTOCOL](#) from that handle. A detailed description is given in [Section 17.2.2.3](#).

### 17.2.2.1 USB Bus Driver Entry Point

Like all other device drivers, the entry point for a USB Bus Driver attaches the [EFI\\_DRIVER\\_BINDING\\_PROTOCOL](#) to image handle of the USB Bus Driver.

### 17.2.2.2 Driver Binding Protocol for USB Bus Drivers

The Driver Binding Protocol contains three services. These are [Supported\(\)](#), [Start\(\)](#), and [Stop\(\)](#). [Supported\(\)](#) tests to see if the USB Bus Driver can manage a device handle. A USB Bus Driver can only manage a device handle that contains [EFI\\_USB2\\_HC\\_PROTOCOL](#).

The general idea is that the USB Bus Driver is a generic driver. Since there are several types of USB Host Controllers, an [EFI\\_USB2\\_HC\\_PROTOCOL](#) is used to abstract the host controller interface. Actually, a USB Bus Driver only requires an [EFI\\_USB2\\_HC\\_PROTOCOL](#).

The [Start\(\)](#) function tells the USB Bus Driver to start managing the USB Bus. In this function, the USB Bus Driver creates a device handle for the root hub, and creates a timer to monitor root hub connection changes.

The [Stop\(\)](#) function tells the USB Bus Driver to stop managing a USB Host Bus Controller. The [Stop\(\)](#) function simply deconfigures the devices attached to the root hub. The deconfiguration is a recursive process. If the device to be deconfigured is a USB hub, then all USB devices attached to its downstream ports will be deconfigured first, then itself. If all of the child devices handles have been destroyed then the [EFI\\_USB2\\_HC\\_PROTOCOL](#) is closed. Finally, the [Stop\(\)](#) function will then place the USB Host Bus Controller in a quiescent state.

### 17.2.2.3 USB Hot-Plug Event

Hot-Plug is one of the most important features provided by USB. A USB bus driver implements this feature through two methods. There are two types of hubs defined in the USB specification. One is the USB root hub, which is implemented in the USB Host controller. A timer event is created for the root hub. The other one is a USB Hub. An event is created for each hub that is correctly configured. All these events are associated with the same trigger which is USB bus numerator.

When USB bus enumeration is triggered, the USB Bus Driver checks the source of the event. This is required because the root hub differs from standard USB hub in checking the hub status. The status of a root hub is retrieved through the

[EFI\\_USB2\\_HC\\_PROTOCOL](#), and that status of a standard USB hub is retrieved through a USB control transfer. A detailed description of the enumeration process is presented in the next section.

#### 17.2.2.4 USB Bus Enumeration

When the periodic timer or the hubs notify event is signaled, the USB Bus Driver will perform bus numeration.

1. Determine if the event is from the root hub or a standard USB hub.
2. Determine the port on which the connection change event occurred.
3. Determine if it is a connection change or a disconnection change.
4. If a connect change is detected, then a new device has been attached. Perform the following:
  - a. Reset and enable that port.
  - b. Configure the new device.
  - c. Parse the device configuration descriptors; get all of its interface descriptors (i.e., all USB controllers), and configure each interface.
  - d. Create a new handle for each interface (USB Controller) within the USB device. Attach the [EFI\\_DEVICE\\_PATH\\_PROTOCOL](#), and the [EFI\\_USB\\_IO\\_PROTOCOL](#) to each handle.
  - e. Connect the USB Controller to a USB device driver with the Boot Service [EFI\\_BOOT\\_SERVICES.ConnectController\(\)](#) if applicable.
  - f. If the USB Controller is a USB hub, create a Hub notify event which is associated with the USB Bus Enumerator, and submit an Asynchronous Interrupt Transfer Request (See [Section 17.2.4](#)).
5. If a disconnect change, then a device has been detached from the USB Bus. Perform the following:
  - a. If the device is not a USB Hub, then find and deconfigure the USB Controllers within the device. Then, stop each USB controller with [EFI\\_BOOT\\_SERVICES.DisconnectController\(\)](#), and uninstall the [EFI\\_DEVICE\\_PATH\\_PROTOCOL](#) and the [EFI\\_USB\\_IO\\_PROTOCOL](#) from the controller's handle. If the [EFI\\_BOOT\\_SERVICES.DisconnectController\(\)](#) call fails this process must be retried on a subsequent timer tick.
  - b. If the USB controller is USB hub controller, first find and deconfigure all its downstream USB devices (this is a recursive process, since there may be additional USB hub controllers on the downstream ports), then deconfigure USB hub controller itself.

#### 17.2.3 USB Device Driver

A USB Device Driver manages a USB Controller and produces a device abstraction for use by a preboot application.

### 17.2.3.1 USB Device Driver Entry Point

Like all other device drivers, the entry point for a USB Device Driver attaches [EFI\\_DRIVER\\_BINDING\\_PROTOCOL](#) to image handle of the USB Device Driver.

### 17.2.3.2 Driver Binding Protocol for USB Device Drivers

The Driver Binding Protocol contains three services. These are [Supported\(\)](#), [Start\(\)](#), and [Stop\(\)](#).

The [Supported\(\)](#) tests to see if the USB Device Driver can manage a device handle. This function checks to see if a controller can be managed by the USB Device Driver. This is done by opening the [EFI\\_USB\\_IO\\_PROTOCOL](#) bus abstraction on the USB Controller handle, and using the [EFI\\_USB\\_IO\\_PROTOCOL](#) services to determine if this USB Controller matches the profile that the USB Device Driver is capable of managing.

The [Start\(\)](#) function tells the USB Device Driver to start managing a USB Controller. It opens the [EFI\\_USB\\_IO\\_PROTOCOL](#) instance from the handle for the USB Controller. This protocol instance is used to perform USB packet transmission over the USB bus. For example, if the USB controller is USB keyboard, then the USB keyboard driver would produce and install the [EFI\\_SIMPLE\\_TEXT\\_INPUT\\_PROTOCOL](#) to the USB controller handle.

The [Stop\(\)](#) function tells the USB Device Driver to stop managing a USB Controller. It removes the I/O abstraction protocol instance previously installed in [Start\(\)](#) from the USB controller handle. It then closes the [EFI\\_USB\\_IO\\_PROTOCOL](#).

## 17.2.4 USB I/O Protocol

This section provides a detailed description of the [EFI\\_USB\\_IO\\_PROTOCOL](#). This protocol is used by code, typically drivers, running in the EFI boot services environment to access USB devices like USB keyboards, mice and mass storage devices. In particular, functions for managing devices on USB buses are defined here.

The interfaces provided in the [EFI\\_USB\\_IO\\_PROTOCOL](#) are for performing basic operations to access USB devices. Typically, USB devices are accessed through the four different transfers types:

<i>Controller Transfer</i>	Typically used to configure the USB device into an operation mode.
<i>Interrupt Transfer</i>	Typically used to get periodic small amount of data, like USB keyboard and mouse.
<i>Bulk Transfer</i>	Typically used to transfer large amounts of data like reading blocks from USB mass storage devices.
<i>Isochronous Transfer</i>	Typically used to transfer data at a fixed rate like voice data.

This protocol also provides mechanisms to manage and configure USB devices and controllers.

## EFI\_USB\_IO\_PROTOCOL

### Summary

Provides services to manage and communicate with USB devices.

### GUID

```
#define EFI_USB_IO_PROTOCOL_GUID \
  {0x2B2F68D6,0x0CD2,0x44cf,\
   {0x8E,0x8B,0xBB,0xA2,0x0B,0x1B,0x5B,0x75}}
```

### Protocol Interface Structure

```
typedef struct _EFI_USB_IO_PROTOCOL {
  EFI_USB_IO_CONTROL_TRANSFER           UsbControlTransfer;
  EFI_USB_IO_BULK_TRANSFER              UsbBulkTransfer;
  EFI_USB_IO_ASYNC_INTERRUPT_TRANSFER   UsbAsyncInterruptTransfer;
  EFI_USB_IO_SYNC_INTERRUPT_TRANSFER    UsbSyncInterruptTransfer
  EFI_USB_IO_ISOCHRONOUS_TRANSFER       UsbIsochronousTransfer;
  EFI_USB_IO_ASYNC_ISOCHRONOUS_TRANSFER UsbAsyncIsochronousTransfer;
  EFI_USB_IO_GET_DEVICE_DESCRIPTOR      UsbGetDeviceDescriptor;
  EFI_USB_IO_GET_CONFIG_DESCRIPTOR      UsbGetConfigDescriptor;
  EFI_USB_IO_GET_INTERFACE_DESCRIPTOR   UsbGetInterfaceDescriptor;
  EFI_USB_IO_GET_ENDPOINT_DESCRIPTOR    UsbGetEndpointDescriptor;
  EFI_USB_IO_GET_STRING_DESCRIPTOR      UsbGetStringDescriptor;
  EFI_USB_IO_GET_SUPPORTED_LANGUAGES    UsbGetSupportedLanguages;
  EFI_USB_IO_PORT_RESET                 UsbPortReset;
} EFI_USB_IO_PROTOCOL;
```

### Parameters

- UsbControlTransfer*      Accesses the USB Device through USB Control Transfer Pipe. See the [UsbControlTransfer\(\)](#) function description.
- UsbBulkTransfer*        Accesses the USB Device through USB Bulk Transfer Pipe. See the [UsbBulkTransfer\(\)](#) function description.
- UsbAsyncInterruptTransfer*      Non-block USB interrupt transfer. See the [UsbAsyncInterruptTransfer\(\)](#) function description.
- UsbSyncInterruptTransfer*      Accesses the USB Device through USB Synchronous Interrupt Transfer Pipe. See the [UsbSyncInterruptTransfer\(\)](#) function description.
- UsbIsochronousTransfer*      Accesses the USB Device through USB Isochronous

Transfer Pipe. See the [UsbIsochronousTransfer\(\)](#) function description.

*UsbAsyncIsochronousTransfer*

Nonblock USB isochronous transfer. See the [UsbAsyncIsochronousTransfer\(\)](#) function description.

*UsbGetDeviceDescriptor*

Retrieves the device descriptor of a USB device. See the [UsbGetDeviceDescriptor\(\)](#) function description.

*UsbGetConfigDescriptor*

Retrieves the activated configuration descriptor of a USB device. See the [UsbGetConfigDescriptor\(\)](#) function description.

*UsbGetInterfaceDescriptor*

Retrieves the interface descriptor of a USB Controller. See the [UsbGetInterfaceDescriptor\(\)](#) function description.

*UsbGetEndpointDescriptor*

Retrieves the endpoint descriptor of a USB Controller. See the [UsbGetEndpointDescriptor\(\)](#) function description.

*UsbGetStringDescriptor*

Retrieves the string descriptor inside a USB Device. See the [UsbGetStringDescriptor\(\)](#) function description.

*UsbGetSupportedLanguages*

Retrieves the array of languages that the USB device supports. See the [UsbGetSupportedLanguages\(\)](#) function description.

*UsbPortReset*

Resets and reconfigures the USB controller. See the [UsbPortReset\(\)](#) function description.

## Description

The **EFI\_USB\_IO\_PROTOCOL** provides four basic transfers types described in the *USB 1.1 Specification*. These include control transfer, interrupt transfer, bulk transfer and isochronous transfer. The **EFI\_USB\_IO\_PROTOCOL** also provides some basic USB device/controller management and configuration interfaces. A USB device driver uses the services of this protocol to manage USB devices.

## EFI\_USB\_IO\_PROTOCOL.UsbControlTransfer()

### Summary

This function is used to manage a USB device with a control transfer pipe. A control transfer is typically used to perform device initialization and configuration.

### Prototype

```
typedef
EFI_STATUS
(EFIAPI *EFI_USB_IO_CONTROL_TRANSFER) (
  IN EFI_USB_IO_PROTOCOL *This,
  IN EFI_USB_DEVICE_REQUEST *Request,
  IN EFI_USB_DATA_DIRECTION Direction,
  IN UINT32 Timeout,
  IN OUT VOID *Data OPTIONAL,
  IN UINTN DataLength OPTIONAL,
  OUT UINT32 *Status
);
```

### Parameters

<i>This</i>	A pointer to the <a href="#">EFI_USB_IO_PROTOCOL</a> instance. Type <a href="#">EFI_USB_IO_PROTOCOL</a> is defined in <a href="#">Section 17.2.4</a> .
<i>Request</i>	A pointer to the USB device request that will be sent to the USB device. See “Related Definitions” below.
<i>Direction</i>	Indicates the data direction. See “Related Definitions” below for this type.
<i>Data</i>	A pointer to the buffer of data that will be transmitted to USB device or received from USB device.
<i>Timeout</i>	Indicating the transfer should be completed within this time frame. The units are in milliseconds. If <i>Timeout</i> is 0, then the caller must wait for the function to be completed until <a href="#">EFI_SUCCESS</a> or <a href="#">EFI_DEVICE_ERROR</a> is returned.
<i>DataLength</i>	The size, in bytes, of the data buffer specified by <i>Data</i> .
<i>Status</i>	A pointer to the result of the USB transfer.

### Related Definitions

```
typedef enum {
  EfiUsbDataIn,
  EfiUsbDataOut,
  EfiUsbNoData
} EFI_USB_DATA_DIRECTION;
```

```
//
// Error code for USB Transfer Results
//
#define EFI_USB_NOERROR    0x0000
#define EFI_USB_ERR_NOTEXECUTE 0x0001
#define EFI_USB_ERR_STALL  0x0002
#define EFI_USB_ERR_BUFFER 0x0004
#define EFI_USB_ERR_BABBLE 0x0008
#define EFI_USB_ERR_NAK    0x0010
#define EFI_USB_ERR_CRC    0x0020
#define EFI_USB_ERR_TIMEOUT 0x0040
#define EFI_USB_ERR_BITSTUFF 0x0080
#define EFI_USB_ERR_SYSTEM 0x0100

typedef struct {
    UINT8      RequestType;
    UINT8      Request;
    UINT16     Value;
    UINT16     Index;
    UINT16     Length;
} EFI_USB_DEVICE_REQUEST;
```

<i>RequestType</i>	The field identifies the characteristics of the specific request.
<i>Request</i>	This field specifies the particular request.
<i>Value</i>	This field is used to pass a parameter to USB device that is specific to the request.
<i>Index</i>	This field is also used to pass a parameter to USB device that is specific to the request.
<i>Length</i>	This field specifies the length of the data transferred during the second phase of the control transfer. If it is 0, then there is no data phase in this transfer.

## Description

This function allows a USB device driver to communicate with the USB device through a Control Transfer. There are three control transfer types according to the data phase. If the *Direction* parameter is **EfiUsbNoData**, *Data* is **NULL**, and *DataLength* is 0, then no data phase exists for the control transfer. If the *Direction* parameter is **EfiUsbDataOut**, then *Data* specifies the data to be transmitted to the device, and *DataLength* specifies the number of bytes to transfer to the device. In this case there is an OUT DATA stage followed by a SETUP stage. If the *Direction* parameter is **EfiUsbDataIn**, then *Data* specifies the data that is received from the device, and *DataLength* specifies the number of bytes to receive from the device. In this case there is an IN DATA stage followed by a SETUP stage. After the USB transfer has completed successfully, **EFI\_SUCCESS** is returned. If the transfer cannot be completed due to timeout, then **EFI\_TIMEOUT** is



returned. If an error other than timeout occurs during the USB transfer, then **EFI\_DEVICE\_ERROR** is returned and the detailed status code is returned in *Status*.

### Status Code Returned

EFI_SUCCESS	The control transfer has been successfully executed.
EFI_INVALID_PARAMETER	The parameter <i>Direction</i> is not valid.
EFI_INVALID_PARAMETER	<i>Request</i> is <b>NULL</b> .
EFI_INVALID_PARAMETER	<i>Status</i> is <b>NULL</b> .
EFI_OUT_OF_RESOURCES	The request could not be completed due to a lack of resources.
EFI_TIMEOUT	The control transfer fails due to timeout.
EFI_DEVICE_ERROR	The transfer failed. The transfer status is returned in <i>Status</i> .

## EFI\_USB\_IO\_PROTOCOL.UsbBulkTransfer()

### Summary

This function is used to manage a USB device with the bulk transfer pipe. Bulk Transfers are typically used to transfer large amounts of data to/from USB devices.

### Prototype

```
typedef
EFI_STATUS
(EFI_API *EFI_USB_IO_BULK_TRANSFER) (
    IN EFI_USB_IO_PROTOCOL *This,
    IN UINT8 DeviceEndpoint,
    IN OUT VOID *Data,
    IN OUT UINTN *DataLength,
    IN UINTN Timeout,
    OUT UINT32 *Status
);
```

### Parameters

<i>This</i>	A pointer to the <a href="#">EFI_USB_IO_PROTOCOL</a> instance. Type <a href="#">EFI_USB_IO_PROTOCOL</a> is defined in <a href="#">Section 17.2.4</a> .
<i>DeviceEndpoint</i>	The destination USB device endpoint to which the device request is being sent. <i>DeviceEndpoint</i> must be between 0x01 and 0x0F or between 0x81 and 0x8F, otherwise <a href="#">EFI_INVALID_PARAMETER</a> is returned. If the endpoint is not a BULK endpoint, <a href="#">EFI_INVALID_PARAMETER</a> is returned. The MSB of this parameter indicates the endpoint direction. The number "1" stands for an IN endpoint, and "0" stands for an OUT endpoint.
<i>Data</i>	A pointer to the buffer of data that will be transmitted to USB device or received from USB device.
<i>DataLength</i>	On input, the size, in bytes, of the data buffer specified by <i>Data</i> . On output, the number of bytes that were actually transferred.
<i>Timeout</i>	Indicating the transfer should be completed within this time frame. The units are in milliseconds. If <i>Timeout</i> is 0, then the caller must wait for the function to be completed until <a href="#">EFI_SUCCESS</a> or <a href="#">EFI_DEVICE_ERROR</a> is returned.
<i>Status</i>	This parameter indicates the USB transfer status.

### Description

This function allows a USB device driver to communicate with the USB device through Bulk Transfer. The transfer direction is determined by the endpoint direction. If the USB transfer is successful, then [EFI\\_SUCCESS](#) is returned. If USB transfer cannot be completed within the *Timeout* frame, [EFI\\_TIMEOUT](#) is returned. If an error other than

timeout occurs during the USB transfer, then **EFI\_DEVICE\_ERROR** is returned and the detailed status code will be returned in the *Status* parameter.

### Status Code Returned

EFI_SUCCESS	The bulk transfer has been successfully executed.
EFI_INVALID_PARAMETER	If <i>DeviceEndpoint</i> is not valid.
EFI_INVALID_PARAMETER	<i>Data</i> is <b>NULL</b> .
EFI_INVALID_PARAMETER	<i>DataLength</i> is <b>NULL</b> .
EFI_INVALID_PARAMETER	<i>Status</i> is <b>NULL</b> .
EFI_OUT_OF_RESOURCES	The request could not be completed due to a lack of resources.
EFI_TIMEOUT	The bulk transfer cannot be completed within <i>Timeout</i> timeframe.
EFI_DEVICE_ERROR	The transfer failed other than timeout, and the transfer status is returned in <i>Status</i> .

## EFI\_USB\_IO\_PROTOCOL.UsbAsyncInterruptTransfer()

### Summary

This function is used to manage a USB device with an interrupt transfer pipe. An Asynchronous Interrupt Transfer is typically used to query a device's status at a fixed rate. For example, keyboard, mouse, and hub devices use this type of transfer to query their interrupt endpoints at a fixed rate.

### Prototype

```
typedef
EFI_STATUS
(EFI_API *EFI_USB_IO_ASYNC_INTERRUPT_TRANSFER) (
    IN EFI_USB_IO_PROTOCOL    *This,
    IN UINT8                  DeviceEndpoint,
    IN BOOLEAN                 IsNewTransfer,
    IN UINTN                   PollingInterval OPTIONAL,
    IN UINTN                   DataLength OPTIONAL,
    IN EFI_ASYNC_USB_TRANSFER_CALLBACK InterruptCallBack OPTIONAL,
    IN VOID                    *Context OPTIONAL
);
```

### Parameters

<i>This</i>	A pointer to the <a href="#">EFI_USB_IO_PROTOCOL</a> instance. Type <a href="#">EFI_USB_IO_PROTOCOL</a> is defined in <a href="#">Section 17.2.4</a> .
<i>DeviceEndpoint</i>	The destination USB device endpoint to which the device request is being sent. <i>DeviceEndpoint</i> must be between 0x01 and 0x0F or between 0x81 and 0x8F, otherwise <a href="#">EFI_INVALID_PARAMETER</a> is returned. If the endpoint is not an INTERRUPT endpoint, <a href="#">EFI_INVALID_PARAMETER</a> is returned. The MSB of this parameter indicates the endpoint direction. The number "1" stands for an IN endpoint, and "0" stands for an OUT endpoint.
<i>IsNewTransfer</i>	If <b>TRUE</b> , a new transfer will be submitted to USB controller. If <b>FALSE</b> , the interrupt transfer is deleted from the device's interrupt transfer queue. If <b>TRUE</b> , and an interrupt transfer exists for the target end point, then <a href="#">EFI_INVALID_PARAMETER</a> is returned.
<i>PollingInterval</i>	Indicates the periodic rate, in milliseconds, that the transfer is to be executed. This parameter is required when <i>IsNewTransfer</i> is <b>TRUE</b> . The value must be between 1 to 255, otherwise <a href="#">EFI_INVALID_PARAMETER</a> is returned. The units are in milliseconds.
<i>DataLength</i>	Specifies the length, in bytes, of the data to be received from the USB device. This parameter is only required when <i>IsNewTransfer</i> is <b>TRUE</b> .

<i>Context</i>	Data passed to the <i>InterruptCallback</i> function. This is an optional parameter and may be <b>NULL</b> .
<i>InterruptCallback</i>	The Callback function. This function is called if the asynchronous interrupt transfer is completed. This parameter is required when <i>IsNewTransfer</i> is <b>TRUE</b> . See "Related Definitions" for the definition of this type.

## Related Definitions

```
typedef
EFI_STATUS
(EFI_API * EFI_ASYNC_USB_TRANSFER_CALLBACK) (
    IN VOID *Data,
    IN UINTN DataLength,
    IN VOID *Context,
    IN UINT32 Status
);
```

<i>Data</i>	Data received or sent via the USB Asynchronous Transfer, if the transfer completed successfully.
<i>DataLength</i>	The length of <i>Data</i> received or sent via the Asynchronous Transfer, if transfer successfully completes.
<i>Context</i>	Data passed from <a href="#">UsbAsyncInterruptTransfer0</a> request.
<i>Status</i>	Indicates the result of the asynchronous transfer.

## Description

This function allows a USB device driver to communicate with a USB device with an Interrupt Transfer. Asynchronous Interrupt transfer is different than the other four transfer types because it is a nonblocking transfer. The interrupt endpoint is queried at a fixed rate, and the data transfer direction is always in the direction from the USB device towards the system.

If *IsNewTransfer* is **TRUE**, then an interrupt transfer is started at a fixed rate. The rate is specified by *PollingInterval*, the size of the receive buffer is specified by *DataLength*, and the callback function is specified by *InterruptCallback*. If *IsNewTransfer* is **TRUE**, and an interrupt transfer exists for the target end point, then **EFI\_INVALID\_PARAMETER** is returned.

If *IsNewTransfer* is **FALSE**, then the interrupt transfer is canceled.

## Status Code Returned

EFI_SUCCESS	The asynchronous USB transfer request has been successfully executed.
EFI_DEVICE_ERROR	The asynchronous USB transfer request failed. When an interrupt transfer exists for the target end point and a new transfer is requested, EFI_INVALID_PARAMETER is returned.

## Examples

Below is an example of how an asynchronous interrupt transfer is used. The example shows how a USB Keyboard Device Driver can periodically receive data from interrupt endpoint.

```

EFI_USB_IO_PROTOCOL *Usblo;
EFI_STATUS Status;
USB_KEYBOARD_DEV *UsbKeyboardDevice;
EFI_USB_INTERRUPT_CALLBACK KeyboardHandle;

...
Status = Usblo->UsbAsyncInterruptTransfer(
    Usblo,
    UsbKeyboardDevice->IntEndpointAddress,
    TRUE,
    UsbKeyboardDevice->IntPollingInterval,
    8,
    KeyboardHandler,
    UsbKeyboardDevice
);

...

//
// The following is the InterruptCallback function. If there is
// any results got from Asynchronous Interrupt Transfer,
// this function will be called.
//
EFI_STATUS
KeyboardHandler(
    IN VOID *Data,
    IN UINTN DataLength,
    IN VOID *Context,
    IN UINT32 Result
)
{
    USB_KEYBOARD_DEV *UsbKeyboardDevice;
    UINTN I;

    if(EFI_ERROR(Result))
    {
        //
        // Something error during this transfer,
        // just to some recovery work
        //
        ...
        ...
        return EFI_DEVICE_ERROR;
    }

    UsbKeyboardDevice = (USB_KEYBOARD_DEV *)Context;

    for(I = 0; I < DataLength; I++)

```

```
{  
  ParsedData(Data[I]);  
  ...  
}  
  
return EFI_SUCCESS;  
}
```



## EFI\_USB\_IO\_PROTOCOL.UsbSyncInterruptTransfer()

### Summary

This function is used to manage a USB device with an interrupt transfer pipe. The difference between [UsbAsyncInterruptTransfer\(\)](#) and **UsbSyncInterruptTransfer()** is that the Synchronous interrupt transfer will only be executed one time. Once it returns, regardless of its status, the interrupt request will be deleted in the system.

### Prototype

```
typedef
EFI_STATUS
(EFI_API *EFI_USB_IO_SYNC_INTERRUPT_TRANSFER) (
  IN EFI_USB_IO_PROTOCOL *This,
  IN UINT8 DeviceEndpoint,
  IN OUT VOID *Data,
  IN OUT UINTN *DataLength,
  IN UINTN Timeout,
  OUT UINT32 *Status
);
```

### Parameters

<i>This</i>	A pointer to the <a href="#">EFI_USB_IO_PROTOCOL</a> instance. Type <b>EFI_USB_IO_PROTOCOL</b> is defined in <a href="#">Section 17.2.4</a> .
<i>DeviceEndpoint</i>	The destination USB device endpoint to which the device request is being sent. <i>DeviceEndpoint</i> must be between 0x01 and 0x0F or between 0x81 and 0x8F, otherwise <b>EFI_INVALID_PARAMETER</b> is returned. If the endpoint is not an INTERRUPT endpoint, <b>EFI_INVALID_PARAMETER</b> is returned. The MSB of this parameter indicates the endpoint direction. The number "1" stands for an IN endpoint, and "0" stands for an OUT endpoint.
<i>Data</i>	A pointer to the buffer of data that will be transmitted to USB device or received from USB device.
<i>DataLength</i>	On input, then size, in bytes, of the buffer <i>Data</i> . On output, the amount of data actually transferred.
<i>Timeout</i>	The time out, in milliseconds, for this transfer. If <i>Timeout</i> is 0, then the caller must wait for the function to be completed until <b>EFI_SUCCESS</b> or <b>EFI_DEVICE_ERROR</b> is returned. If the transfer is not completed in this time frame, then <b>EFI_TIMEOUT</b> is returned.
<i>Status</i>	This parameter indicates the USB transfer status.

### Description

This function allows a USB device driver to communicate with a USB device through a synchronous interrupt transfer. The **UsbSyncInterruptTransfer()** differs from [UsbAsyncInterruptTransfer\(\)](#) described in the previous section in that it is a blocking

transfer request. The caller must wait for the function return, either successfully or unsuccessfully.

### Status Code Returned

EFI_SUCCESS	The sync interrupt transfer has been successfully executed.
EFI_INVALID_PARAMETER	The parameter <i>DeviceEndpoint</i> is not valid.
EFI_INVALID_PARAMETER	<i>Data</i> is <b>NULL</b> .
EFI_INVALID_PARAMETER	<i>DataLength</i> is <b>NULL</b> .
EFI_INVALID_PARAMETER	<i>Status</i> is <b>NULL</b> .
EFI_OUT_OF_RESOURCES	The request could not be completed due to a lack of resources.
EFI_TIMEOUT	The transfer cannot be completed within <i>Timeout</i> timeframe.
EFI_DEVICE_ERROR	The transfer failed other than timeout, and the transfer status is returned in <i>Status</i> .

## EFI\_USB\_IO\_PROTOCOL.UsbIsochronousTransfer()

### Summary

This function is used to manage a USB device with an isochronous transfer pipe. An Isochronous transfer is typically used to transfer streaming data.

### Prototype

```
typedef
EFI_STATUS
(EFI_API * EFI_USB_IO_ISOCHRONOUS_TRANSFER) (
  IN EFI_USB_IO_PROTOCOL *This,
  IN UINT8 DeviceEndpoint,
  IN OUT VOID *Data,
  IN UINTN DataLength,
  OUT UINT32 *Status
);
```

### Parameters

<i>This</i>	A pointer to the <a href="#">EFI_USB_IO_PROTOCOL</a> instance. Type <a href="#">EFI_USB_IO_PROTOCOL</a> is defined in <a href="#">Section 17.2.4</a> .
<i>DeviceEndpoint</i>	The destination USB device endpoint to which the device request is being sent. <i>DeviceEndpoint</i> must be between 0x01 and 0x0F or between 0x81 and 0x8F, otherwise <a href="#">EFI_INVALID_PARAMETER</a> is returned. If the endpoint is not an ISOCHRONOUS endpoint, <a href="#">EFI_INVALID_PARAMETER</a> is returned. The MSB of this parameter indicates the endpoint direction. The number "1" stands for an IN endpoint, and "0" stands for an OUT endpoint.
<i>Data</i>	A pointer to the buffer of data that will be transmitted to USB device or received from USB device.
<i>DataLength</i>	The size, in bytes, of the data buffer specified by <i>Data</i> .
<i>Status</i>	This parameter indicates the USB transfer status.

### Description

This function allows a USB device driver to communicate with a USB device with an Isochronous Transfer. The type of transfer is different than the other types because the USB Bus Driver will not attempt to perform error recovery if transfer fails. If the USB transfer is completed successfully, then [EFI\\_SUCCESS](#) is returned. The isochronous transfer is designed to be completed within 1 USB frame time, if it cannot be completed, [EFI\\_TIMEOUT](#) is returned. If the transfer fails due to other reasons, then [EFI\\_DEVICE\\_ERROR](#) is returned and the detailed error status is returned in *Status*. If the data length exceeds the maximum payload per USB frame time, then it is this function's responsibility to divide the data into a set of smaller packets that fit into a USB frame time. If all the packets are transferred successfully, then [EFI\\_SUCCESS](#) is returned.

## Status Code Returned

EFI_SUCCESS	The isochronous transfer has been successfully executed.
EFI_INVALID_PARAMETER	The parameter <i>DeviceEndpoint</i> is not valid.
EFI_OUT_OF_RESOURCES	The request could not be completed due to a lack of resources.
EFI_TIMEOUT	The transfer cannot be completed within the 1 USB frame time.
EFI_DEVICE_ERROR	The transfer failed due to the reason other than timeout, The error status is returned in <i>Status</i> .
EFI_UNSUPPORTED	The implementation doesn't support an Isochronous transfer function.

## EFI\_USB\_IO\_PROTOCOL.UsbAsyncIsochronousTransfer()

### Summary

This function is used to manage a USB device with an isochronous transfer pipe. An asynchronous Isochronous transfer is a nonblocking USB isochronous transfer.

### Prototype

```
typedef
EFI_STATUS
(EFIAPI *EFI_USB_IO_ASYNC_ISOCHRONOUS_TRANSFER) (
  IN EFI_USB_IO_PROTOCOL  *This,
  IN UINT8                DeviceEndpoint,
  IN OUT VOID             *Data,
  IN UINTN                DataLength,
  IN EFI_ASYNC_USB_TRANSFER_CALLBACK IsochronousCallback,
  IN VOID                 *Context OPTIONAL
);
```

### Parameters

<i>This</i>	A pointer to the <a href="#">EFI_USB_IO_PROTOCOL</a> instance. Type <a href="#">EFI_USB_IO_PROTOCOL</a> is defined in <a href="#">Section 17.2.4</a> .
<i>DeviceEndpoint</i>	The destination USB device endpoint to which the device request is being sent. <i>DeviceEndpoint</i> must be between 0x01 and 0x0F or between 0x81 and 0x8F, otherwise <a href="#">EFI_INVALID_PARAMETER</a> is returned. If the endpoint is not an ISOCHRONOUS endpoint, <a href="#">EFI_INVALID_PARAMETER</a> is returned. The MSB of this parameter indicates the endpoint direction. The number "1" stands for an IN endpoint, and "0" stands for an OUT endpoint.
<i>Data</i>	A pointer to the buffer of data that will be transmitted to USB device or received from USB device.
<i>DataLength</i>	Specifies the length, in bytes, of the data to be sent to or received from the USB device.
<i>Context</i>	Data passed to the <a href="#">IsochronousCallback()</a> function. This is an optional parameter and may be NULL.
<i>IsochronousCallback</i>	The <a href="#">IsochronousCallback()</a> function. This function is called if the requested isochronous transfer is completed. See the "Related Definitions" section of the <a href="#">UsbAsyncInterruptTransfer()</a> function description.

### Description

This is an asynchronous type of USB isochronous transfer. If the caller submits a USB isochronous transfer request through this function, this function will return immediately. When the isochronous transfer completes, the [IsochronousCallback\(\)](#) function will be

triggered, the caller can know the transfer results. If the transfer is successful, the caller can get the data received or sent in this callback function.

### Status Code Returned

EFI_SUCCESS	The asynchronous isochronous transfer has been successfully submitted to the system.
EFI_INVALID_PARAMETER	The parameter <i>DeviceEndpoint</i> is not valid.
EFI_OUT_OF_RESOURCES	The request could not be submitted due to a lack of resources.
EFI_UNSUPPORTED	The implementation doesn't support an asynchronous Isochronous transfer function.

## EFI\_USB\_IO\_PROTOCOL.UsbGetDeviceDescriptor()

### Summary

Retrieves the USB Device Descriptor.

### Prototype

```
typedef
EFI_STATUS
(EFIAPI *EFI_USB_IO_GET_DEVICE_DESCRIPTOR) (
    IN EFI_USB_IO_PROTOCOL  *This,
    OUT EFI_USB_DEVICE_DESCRIPTOR *DeviceDescriptor
);
```

### Parameters

<i>This</i>	A pointer to the <a href="#">EFI_USB_IO_PROTOCOL</a> instance. Type <a href="#">EFI_USB_IO_PROTOCOL</a> is defined in <a href="#">Section 17.2.4</a> .
<i>DeviceDescriptor</i>	A pointer to the caller allocated USB Device Descriptor. See “Related Definitions” for a detailed description.

### Related Definitions

```
//
// See USB1.1 for detail description.
//
typedef struct {
    UINT8 Length;
    UINT8 DescriptorType;
    UINT16 BcdUSB;
    UINT8 DeviceClass;
    UINT8 DeviceSubClass;
    UINT8 DeviceProtocol;
    UINT8 MaxPacketSize0;
    UINT16 IdVendor;
    UINT16 IdProduct;
    UINT16 BcdDevice;
    UINT8 StrManufacturer;
    UINT8 StrProduct;
    UINT8 StrSerialNumber;
    UINT8 NumConfigurations;
} EFI_USB_DEVICE_DESCRIPTOR;
```

### Description

This function is used to retrieve information about USB devices. This information includes the device class, subclass, and the number of configurations the USB device supports. If *DeviceDescriptor* is **NULL**, then **EFI\_INVALID\_PARAMETER** is returned. If the USB device descriptor is not found, then **EFI\_NOT\_FOUND** is returned. Otherwise, the device descriptor is returned in *DeviceDescriptor*, and **EFI\_SUCCESS** is returned.

## Status Code Returned

EFI_SUCCESS	The device descriptor was retrieved successfully.
EFI_INVALID_PARAMETER	DeviceDescriptor is NULL.
EFI_NOT_FOUND	The device descriptor was not found. The device may not be configured.



## EFI\_USB\_IO\_PROTOCOL.UsbGetConfigDescriptor()

### Summary

Retrieves the USB Device Configuration Descriptor.

### Prototype

```
typedef
EFI_STATUS
(EFIAPI *EFI_USB_IO_GET_CONFIG_DESCRIPTOR) (
  IN EFI_USB_IO_PROTOCOL *This,
  OUT EFI_USB_CONFIG_DESCRIPTOR *ConfigurationDescriptor
);
```

### Parameters

*This* A pointer to the [EFI\\_USB\\_IO\\_PROTOCOL](#) instance. Type [EFI\\_USB\\_IO\\_PROTOCOL](#) is defined in [Section 17.2.4](#).

*ConfigurationDescriptor* A pointer to the caller allocated USB Active Configuration Descriptor. See “Related Definitions” for a detailed description.

### Related Definitions

```
//
// See USB1.1 for detail description.
//
typedef struct {
  UINT8 Length;
  UINT8 DescriptorType;
  UINT16 TotalLength;
  UINT8 NumInterfaces;
  UINT8 ConfigurationValue;
  UINT8 Configuration;
  UINT8 Attributes;
  UINT8 MaxPower;
} EFI_USB_CONFIG_DESCRIPTOR;
```

### Description

This function is used to retrieve the active configuration that the USB device is currently using. If *ConfigurationDescriptor* is **NULL**, then **EFI\_INVALID\_PARAMETER** is returned. If the USB controller does not contain an active configuration, then **EFI\_NOT\_FOUND** is returned. Otherwise, the active configuration is returned in *ConfigurationDescriptor*, and **EFI\_SUCCESS** is returned.

### Status Code Returned

EFI_SUCCESS	The active configuration descriptor was retrieved successfully.
-------------	---

EFI_INVALID_PARAMETER	ConfigurationDescriptor is NULL.
EFI_NOT_FOUND	An active configuration descriptor cannot be found. The device may not be configured.

## EFI\_USB\_IO\_PROTOCOL.UsbGetInterfaceDescriptor()

### Summary

Retrieves the Interface Descriptor for a USB Device Controller. As stated earlier, an interface within a USB device is equivalently to a USB Controller within the current configuration.

### Prototype

```
typedef
EFI_STATUS
(EFIAPI *EFI_USB_IO_GET_INTERFACE_DESCRIPTOR) (
  IN EFI_USB_IO_PROTOCOL  *This,
  OUT EFI_USB_INTERFACE_DESCRIPTOR *InterfaceDescriptor
);
```

### Parameters

*This*

A pointer to the [EFI\\_USB\\_IO\\_PROTOCOL](#) instance. Type [EFI\\_USB\\_IO\\_PROTOCOL](#) is defined in [Section 17.2.4](#).

*InterfaceDescriptor*

A pointer to the caller allocated USB Interface Descriptor within the configuration setting. See “Related Definitions” for a detailed description.

### Related Definitions

```
//
// See USB1.1 for detail description.
//
typedef struct {
  UINT8 Length;
  UINT8 DescriptorType;
  UINT8 InterfaceNumber;
  UINT8 AlternateSetting;
  UINT8 NumEndpoints;
  UINT8 InterfaceClass;
  UINT8 InterfaceSubClass;
  UINT8 InterfaceProtocol;
  UINT8 Interface;
} EFI_USB_INTERFACE_DESCRIPTOR;
```

### Description

This function is used to retrieve the interface descriptor for the USB controller. If *InterfaceDescriptor* is **NULL**, then **EFI\_INVALID\_PARAMETER** is returned. If the USB controller does not contain an interface descriptor, then **EFI\_NOT\_FOUND** is returned. Otherwise, the interface descriptor is returned in *InterfaceDescriptor*, and **EFI\_SUCCESS** is returned.

## Status Code Returned

EFI_SUCCESS	The interface descriptor retrieved successfully.
EFI_INVALID_PARAMETER	InterfaceDescriptor is <b>NULL</b> .
EFI_NOT_FOUND	The interface descriptor cannot be found. The device may not be correctly configured.

## EFI\_USB\_IO\_PROTOCOL.UsbGetEndpointDescriptor()

### Summary

Retrieves an Endpoint Descriptor within a USB Controller.

### Prototype

```
typedef
EFI_STATUS
(EFIAPI *EFI_USB_IO_GET_ENDPOINT_DESCRIPTOR) (
  IN EFI_USB_IO_PROTOCOL  *This,
  IN UINT8                EndpointIndex,
  OUT EFI_USB_ENDPOINT_DESCRIPTOR *EndpointDescriptor
);
```

### Parameters

<i>This</i>	A pointer to the <a href="#">EFI_USB_IO_PROTOCOL</a> instance. Type <a href="#">EFI_USB_IO_PROTOCOL</a> is defined in <a href="#">Section 17.2.4</a> .
<i>EndpointIndex</i>	Indicates which endpoint descriptor to retrieve. The valid range is 0..15.
<i>EndpointDescriptor</i>	A pointer to the caller allocated USB Endpoint Descriptor of a USB controller. See “Related Definitions” for a detailed description.

### Related Definitions

```
//
// See USB1.1 for detail description.
//
typedef struct {
  UINT8 Length;
  UINT8 DescriptorType;
  UINT8 EndpointAddress;
  UINT8 Attributes;
  UINT16 MaxPacketSize;
  UINT8 Interval;
} EFI_USB_ENDPOINT_DESCRIPTOR;
```

### Description

This function is used to retrieve an endpoint descriptor within a USB controller. If *EndpointIndex* is not in the range 0..15, then **EFI\_INVALID\_PARAMETER** is returned. If *EndpointDescriptor* is **NULL**, then **EFI\_INVALID\_PARAMETER** is returned. If the endpoint specified by *EndpointIndex* does not exist within the USB controller, then **EFI\_NOT\_FOUND** is returned. Otherwise, the endpoint descriptor is returned in *EndpointDescriptor*, and **EFI\_SUCCESS** is returned.

### Status Code Returned

EFI_SUCCESS	The endpoint descriptor was retrieved successfully.
EFI_INVALID_PARAMETER	<i>EndpointIndex</i> is not valid.
EFI_INVALID_PARAMETER	EndpointDescriptor is <b>NULL</b> .
EFI_NOT_FOUND	The endpoint descriptor cannot be found. The device may not be correctly configured.

### Examples

The following code fragment shows how to retrieve all the endpoint descriptors from a USB controller.

```

EFI_USB_IO_PROTOCOL *Usblo;
EFI_USB_INTERFACE_DESCRIPTOR InterfaceDesc;
EFI_USB_ENDPOINT_DESCRIPTOR EndpointDesc;
UINTN Index;

Status = Usblo->GetInterfaceDescriptor (
    Usblo,
    &InterfaceDesc
);
...
for(Index = 0; Index < InterfaceDesc.NumEndpoints; Index++) {
    Status = Usblo->GetEndpointDescriptor(
        Usblo,
        Index,
        &EndpointDesc
    );
    ...
}

```

## EFI\_USB\_IO\_PROTOCOL.UsbGetStringDescriptor()

### Summary

Retrieves a string stored in a USB Device.

### Prototype

```
typedef
EFI_STATUS
(EFIAPI *EFI_USB_IO_GET_STRING_DESCRIPTOR) (
  IN EFI_USB_IO_PROTOCOL *This,
  IN UINT16   LangID,
  IN UINT8    StringID,
  OUT CHAR16  **String
);
```

### Parameters

*This*

A pointer to the [EFI\\_USB\\_IO\\_PROTOCOL](#) instance. Type [EFI\\_USB\\_IO\\_PROTOCOL](#) is defined in [Section 17.2.4](#).

*LangID*

The Language ID for the string being retrieved. See the [UsbGetSupportedLanguages\(\)](#) function description for a more detailed description.

*StringID*

The ID of the string being retrieved.

*String*

A pointer to a buffer allocated by this function with [EFI\\_BOOT\\_SERVICES.AllocatePool\(\)](#) to store the string. If this function returns [EFI\\_SUCCESS](#), it stores the string the caller wants to get. The caller should release the string buffer with [EFI\\_BOOT\\_SERVICES.FreePool\(\)](#) after the string is not used any more.

### Description

This function is used to retrieve strings stored in a USB device. The string to retrieve is identified by a language and an identifier. The language is specified by *LangID*, and the identifier is specified by *StringID*. If the string is found, it is returned in *String*, and [EFI\\_SUCCESS](#) is returned. If the string cannot be found, then [EFI\\_NOT\\_FOUND](#) is returned. The string buffer is allocated by this function with [AllocatePool\(\)](#). The caller is responsible for calling [FreePool\(\)](#) for *String* when it is no longer required.

### Status Code Returned

EFI_SUCCESS	The string was retrieved successfully.
EFI_NOT_FOUND	The string specified by <i>LangID</i> and <i>StringID</i> was not found.
EFI_OUT_OF_RESOURCES	There are not enough resources to allocate the return buffer <i>String</i> .

## EFI\_USB\_IO\_PROTOCOL.UsbGetSupportedLanguages()

### Summary

Retrieves all the language ID codes that the USB device supports.

### Prototype

```
typedef
EFI_STATUS
(EFI_API *EFI_USB_IO_GET_SUPPORTED_LANGUAGES) (
    IN EFI_USB_IO_PROTOCOL *This,
    OUT UINT16    **LangIDTable,
    OUT UINT16    *TableSize
);
```

### Parameters

<i>This</i>	A pointer to the <a href="#">EFI_USB_IO_PROTOCOL</a> instance. Type <a href="#">EFI_USB_IO_PROTOCOL</a> is defined in <a href="#">Section 17.2.4</a> .
<i>LangIDTable</i>	Language ID for the string the caller wants to get. This is a 16-bit ID defined by Microsoft. This buffer pointer is allocated and maintained by the USB Bus Driver, the caller should not modify its contents.
<i>TableSize</i>	The size, in bytes, of the table <i>LangIDTable</i> .

### Description

Retrieves all the language ID codes that the USB device supports.

### Status Code Returned

EFI_SUCCESS	The support languages were retrieved successfully.
-------------	--



## EFI\_USB\_IO\_PROTOCOL.UsbPortReset()

### Summary

Resets and reconfigures the USB controller. This function will work for all USB devices except USB Hub Controllers.

### Prototype

```
typedef
EFI_STATUS
(EFIAPI *EFI_USB_IO_PORT_RESET) (
    IN EFI_USB_IO_PROTOCOL *This
);
```

### Parameters

*This*

A pointer to the [EFI\\_USB\\_IO\\_PROTOCOL](#) instance. Type [EFI\\_USB\\_IO\\_PROTOCOL](#) is defined in [Section 17.2.4](#).

### Description

This function provides a reset mechanism by sending a RESET signal from the parent hub port. A reconfiguration process will happen (that includes setting the address and setting the configuration). This reset function does not change the bus topology. A USB hub controller cannot be reset using this function, because it would impact the downstream USB devices. So if the controller is a USB hub controller, then **EFI\_INVALID\_PARAMETER** is returned.

### Status Code Returned

EFI_SUCCESS	The USB controller was reset.
EFI_INVALID_PARAMETER	If the controller specified by <i>This</i> is a USB hub.
EFI_DEVICE_ERROR	An error occurred during the reconfiguration process.

## 17.3 USB Function Protocol

This section describes the USB Function Protocol, enabling a USB Function device with a UEFI driver that implements the protocol to communicate with a USB Host device.

The USB Function Protocol provides an I/O abstraction for a USB Controller operating in Function mode (also commonly referred to as Device, Peripheral, or Target mode) and the mechanisms by which the USB Function can communicate with the USB Host. It is used by other UEFI drivers or applications to perform data transactions and basic USB controller management over a USB Function port.

This simple protocol only supports USB 2.0 bulk transfers on systems with a single configuration and a single interface. It does not support isochronous or interrupt transfers, alternate interfaces, or USB 3.0 functionality. Future revisions of this protocol may support these or additional features.

## EFI\_USBFN\_IO\_PROTOCOL

### Summary

Provides basic data transactions and basic USB controller management for a USB Function port.

**GUID**

```
// {32D2963A-FE5D-4f30-B633-6E5DC55803CC}
#define EFI_USBFN_IO_PROTOCOL_GUID \
  {0x32d2963a, 0xfe5d, 0x4f30, \
   {0xb6, 0x33, 0x6e, 0x5d, 0xc5, 0x58, 0x3, 0xcc}};
```

**Revision Number**

```
#define EFI_USBFN_IO_PROTOCOL_REVISION 0x00010001
```

**Protocol Interface Structure**

```
typedef struct _EFI_USBFN_IO_PROTOCOL {
  UINT32          Revision;
  EFI_USBFN_IO_DETECT_PORT    DetectPort;
  EFI_USBFN_IO_CONFIGURE_ENABLE_ENDPOINTS \
    ConfigureEnableEndpoints;
  EFI_USBFN_IO_GET_ENDPOINT_MAXPACKET_SIZE \
    GetEndpointMaxPacketSize;
  EFI_USBFN_IO_GET_DEVICE_INFO    GetDeviceInfo;
  EFI_USBFN_IO_GET_VENDOR_ID_PRODUCT_ID \
    GetVendorIdProductId;
  EFI_USBFN_IO_ABORT_TRANSFER    AbortTransfer;
  EFI_USBFN_IO_GET_ENDPOINT_STALL_STATE \
    GetEndpointStallState;
  EFI_USBFN_IO_SET_ENDPOINT_STALL_STATE \
    SetEndpointStallState;
  EFI_USBFN_IO_EVENTHANDLER    EventHandler;
  EFI_USBFN_IO_TRANSFER    Transfer;
  EFI_USBFN_IO_GET_MAXTRANSFER_SIZE \
    GetMaxTransferSize;
  EFI_USBFN_IO_ALLOCATE_TRANSFER_BUFFER    AllocateTransferBuffer;
  EFI_USBFN_IO_FREE_TRANSFER_BUFFER    FreeTransferBuffer;

  EFI_USBFN_IO_START_CONTROLLER    StartController;
  EFI_USBFN_IO_STOP_CONTROLLER    StopController;

  EFI_USBFN_IO_SET_ENDPOINT_POLICY    SetEndpointPolicy;
  EFI_USBFN_IO_GET_ENDPOINT_POLICY    GetEndpointPolicy;
} EFI_USBFN_IO_PROTOCOL;
```

**Parameters**

*Revision*

The revision to which the **EFI\_USBFN\_IO\_PROTOCOL** adheres. All future revisions must be backwards compatible. If a future version is not backwards compatible, a different GUID must be used.

<i>DetectPort</i>	Returns information about the USB port type. See <a href="#">EFI_USBEN_IO_PROTOCOL.DetectPort()</a> , "Related Definitions" for more details.
<i>ConfigureEnableEndpoints</i>	Initializes all endpoints based on supplied device and configuration descriptors. Enables the device by setting the run/stop bit.
<i>GetEndpointMaxPacketSize</i>	Returns the maximum packet size of the specified endpoint.
<i>GetDeviceInfo</i>	Returns device specific information based on the supplied identifier as a Unicode string.
<i>GetVendorIdProductId</i>	Returns the vendor-id and product-id of the device.
<i>AbortTransfer</i>	Aborts the transfer on the specified endpoint.
<i>GetEndpointStallState</i>	Returns the stall state on the specified endpoint.
<i>SetEndpointStallState</i>	Sets or clears the stall state on the specified endpoint.
<i>EventHandler</i>	This function is called repeatedly to get information on USB bus states, receive-completion and transmit-completion events on the endpoints, and notification on setup packet on endpoint 0.
<i>Transfer</i>	This function handles transferring data to or from the host on the specified endpoint, depending on the direction specified.
<i>GetMaxTransferSize</i>	The maximum supported transfer size in bytes.
<i>AllocateTransferBuffer</i>	Allocates a transfer buffer of the specified size that satisfies the controller requirements.
<i>FreeTransferBuffer</i>	Deallocates the memory allocated for the transfer buffer by <a href="#">EFI_USBEN_IO_PROTOCOL.AllocateTransferBuffer()</a> function.
<i>StartController</i>	This function initializes the hardware and the internal data structures. The port must not be activated by this function.
<i>StopController</i>	This function disables the device by deactivating the port.
<i>SetEndpointPolicy</i>	This function sets the configuration policy for the specified non-control endpoint. There are a few calling restrictions for this function. See the <a href="#">EFI_USBEN_IO_PROTOCOL.SetEndpointPolicy()</a> function definition for more details.

*GetEndpointPolicy* This function retrieves the configuration policy for the specified non-control endpoint.

## Description

This protocol provides basic data transactions and USB controller management for a USB Function port. It provides a lightweight communication mechanism between a USB Host and a USB Function in the UEFI environment.

Like other UEFI device drivers, the entry point for a USB function driver attaches **EFI\_DRIVER\_BINDING\_PROTOCOL** to image handle of **EFI\_USBFN\_IO\_PROTOCOL** driver.

The driver binding protocol contains three services, *Supported*, *Start* and *Stop*.

The *Supported* function must test to see if this driver supports a given controller.

The *Start* function must supply power to the USB controller if needed, initialize hardware and internal data structures, and then return. The port must not be activated by this function.

The *Stop* function must disable the USB controller and power it off if needed.

## EFI\_USBFN\_IO\_PROTOCOL.DetectPort()

### Summary

Returns information about what USB port type was attached.

### Prototype

```
typedef
EFI_STATUS
(EFIAPI * EFI_USBFN_IO_DETECT_PORT) (
    IN EFI_USBFN_IO_PROTOCOL *This,
    OUT EFI_USBFN_PORT_TYPE *PortType
);
```

### Parameters

<i>This</i>	A pointer to the <b>EFI_USBFN_IO_PROTOCOL</b> instance.
<i>PortType</i>	Returns the USB port type. Refer to the Related Definitions.

for this function below for details.

### Description

Returns information about the USB port type attached. Refer to the "Related Definitions" below for further details.

### Status Codes

EFI_SUCCESS	The function returned successfully.
EFI_INVALID_PARAMETER	A parameter is invalid.
EFI_DEVICE_ERROR	The physical device reported an error.
EFI_NOT_READY	The physical device is busy or not ready to process this request or there is no USB port attached to the device.

### Related Definitions

```
typedef enum _EFI_USBFN_PORT_TYPE {
    EfiUsbUnknownPort = 0,
    EfiUsbStandardDownstreamPort,
    EfiUsbChargingDownstreamPort,
    EfiUsbDedicatedChargingPort,
    EfiUsbInvalidDedicatedChargingPort
} EFI_USBFN_PORT_TYPE;
```

<i>Unknown Port</i>	Driver internal default port type, this is never returned by the driver with a success status code.
---------------------	---

*Standard Downstream Port*

Standard USB host; refer to *USB Battery Charging Specification, Revision 1.2* in [Section O.1](#) for details and the link.

*Charging Downstream Port*

Standard USB host with special charging properties; refer to *USB Battery Charging Specification, Revision 1.2* in [Section O.1](#) for the details and link.

*Dedicated Charging Port*

A wall-charger, not USB host; refer to *USB Battery Charging Specification, Revision 1.2*, [Section O.1](#) for details and the link.

*Invalid Dedicated Charging Port –*

Neither a USB host nor a dedicated charging port as defined by the *USB Battery Charging Specification, Revision 1.2*. (See [Section O.1](#) for details and the link.) An example is a USB charger that raises the voltages on D+/D-, causing the charger to look like an SDP even though it will never issue a setup packet to the upstream facing port.

## EFI\_USBFN\_IO\_PROTOCOL.ConfigureEnableEndpoints()

### Summary

Configures endpoints based on supplied device and configuration descriptors.

### Prototype

```
typedef
EFI_STATUS
(EFIAPI * EFI_USBFN_IO_CONFIGURE_ENABLE_ENDPOINTS) (
    IN EFI_USBFN_IO_PROTOCOL *This,
    IN EFI_USB_DEVICE_INFO *DeviceInfo
);
```

### Parameters

<i>This</i>	A pointer to the <b>EFI_USBFN_IO_PROTOCOL</b> instance.
<i>DeviceInfo</i>	A pointer to <b>EFI_USB_DEVICE_INFO</b> instance. Refer to the "Related Definitions" for this function below for details.

### Description

Assuming that the hardware has already been initialized, this function configures the endpoints using the device information supplied by *DeviceInfo*, activates the port, and starts receiving USB events.

This function must ignore the **bMaxPacketSize0** field of the *Standard Device Descriptor* and the **wMaxPacketSize** field of the *Standard Endpoint Descriptor* that are made available through *DeviceInfo*.

### Status Codes

EFI_SUCCESS	The function returned successfully.
EFI_INVALID_PARAMETER	A parameter is invalid.
EFI_DEVICE_ERROR	The physical device reported an error.
EFI_NOT_READY	The physical device is busy or not ready to process this request.
EFI_OUT_OF_RESOURCES	The request could not be completed due to lack of resources.

### Related Definitions

```
typedef struct {
    EFI_USB_INTERFACE_DESCRIPTOR *InterfaceDescriptor,
    EFI_USB_ENDPOINT_DESCRIPTOR **EndpointDescriptorTable,
} EFI_USB_INTERFACE_INFO;
```



```
typedef struct {
    EFI_USB_CONFIG_DESCRIPTOR  *ConfigDescriptor;
    EFI_USB_INTERFACE_INFO     **InterfaceInfoTable;
} EFI_USB_CONFIG_INFO;
```

```
typedef struct {
    EFI_USB_DEVICE_DESCRIPTOR  *DeviceDescriptor;
    EFI_USB_CONFIG_INFO        **ConfigInfoTable;
} EFI_USB_DEVICE_INFO;
```

USB\_DEVICE\_DESCRIPTOR, USB\_CONFIG\_DESCRIPTOR, USB\_INTERFACE\_DESCRIPTOR, and USB\_ENDPOINT\_DESCRIPTOR are defined in [Section 17.2.4](#).

## EFI\_USBFN\_IO\_PROTOCOL.GetEndpointMaxPacketSize()

### Summary

Returns the maximum packet size of the specified endpoint type for the supplied bus speed.

### Prototype

```
typedef
EFI_STATUS
(EFI_API * EFI_USBFN_IO_GET_ENDPOINT_MAXPACKET_SIZE) (
    IN EFI_USBFN_IO_PROTOCOL *This,
    IN EFI_USB_ENDPOINT_TYPE EndpointType,
    IN EFI_USB_BUS_SPEED BusSpeed,
    OUT UINT16 *MaxPacketSize
);
```

### Parameters

<i>This</i>	A pointer to the <b>EFI_USBFN_IO_PROTOCOL</b> instance.
<i>EndpointType</i>	Endpoint type as defined as <b>EFI_USB_ENDPOINT_TYPE</b> in the "Related Definitions" for this function below for details.
<i>BusSpeed</i>	Bus speed as defined as <b>EFI_USB_BUS_SPEED</b> in the "Related Definitions" for the <i>EventHandle</i> function for details.
<i>MaxPacketSize</i>	The maximum packet size, in bytes, of the specified endpoint type.

### Description

Returns the maximum packet size of the specified endpoint type for the supplied bus speed. If the *BusSpeed* is *UsbBusSpeedUnknown*, the maximum speed the underlying controller supports is assumed.

This protocol currently does not support isochronous or interrupt transfers. Future revisions of this protocol may eventually support it.

### Status Codes

EFI_SUCCESS	The function returned successfully.
EFI_INVALID_PARAMETER	A parameter is invalid.
EFI_DEVICE_ERROR	The physical device reported an error.
EFI_NOT_READY	The physical device is busy or not ready to process this request.

### Related Definitions

```
typedef enum _EFI_USB_ENDPOINT_TYPE
{
    UsbEndpointControl = 0x00,
```

```
// UsbEndpointIsochronous = 0x01,  
UsbEndpointBulk = 0x02,  
// UsbEndpointInterrupt = 0x03  
} EFI_USB_ENDPOINT_TYPE;
```

## EFI\_USBFN\_IO\_PROTOCOL.GetDeviceInfo()

### Summary

Returns device specific information based on the supplied identifier as a Unicode string.

### Prototype

```
typedef
EFI_STATUS
(EFI_API * EFI_USBFN_IO_GET_DEVICE_INFO) (
  IN EFI_USBFN_IO_PROTOCOL *This,
  IN EFI_USBFN_DEVICE_INFO_ID Id,
  IN OUT UINTN *BufferSize,
  OUT VOID *Buffer OPTIONAL
);
```

### Parameters

<i>This</i>	A pointer to the <b>EFI_USBFN_IO_PROTOCOL</b> instance.
<i>Id</i>	The requested information id. Refer to the "Related Definitions" for this function below for details.
<i>BufferSize</i>	On input, the size of the <i>Buffer</i> in bytes. On output, the amount of data returned in <i>Buffer</i> in bytes.
<i>Buffer</i>	A pointer to a buffer to return the requested information as a Unicode string.

### Description

Returns device specific information based on the supplied identifier as a Unicode string. If the supplied *Buffer* isn't large enough, or is NULL, the method fails with **EFI\_BUFFER\_TOO\_SMALL** and the required size is returned through *BufferSize*. All returned strings are in Unicode format.

An *Id* of *EfiUsbDeviceInfoUnknown* is treated as an invalid parameter.

## Status Codes

EFI_SUCCESS	The function returned successfully.
EFI_INVALID_PARAMETER	One or more of the following conditions is TRUE: <ul style="list-style-type: none"><li>• BufferSize is NULL.</li><li>• *BufferSize is not 0 and Buffer is NULL.</li><li>• Id is invalid.</li></ul>
EFI_DEVICE_ERROR	The physical device reported an error.
EFI_NOT_READY	The physical device is busy or not ready to process this request.
EFI_BUFFER_TOO_SMALL	The buffer is too small to hold the buffer. *BufferSize has been updated with the size needed to hold the request string.

## Related Definitions

```
typedef enum _EFI_USBFN_DEVICE_INFO_ID
{
    EfiUsbDeviceInfoUnknown = 0,
    EfiUsbDeviceInfoSerialNumber,
    EfiUsbDeviceInfoManufacturerName,
    EfiUsbDeviceInfoProductName
} EFI_USBFN_DEVICE_INFO_ID;
```

## EFI\_USBFN\_IO\_PROTOCOL.GetVendorIdProductId()

### Summary

Returns the vendor-id and product-id of the device.

### Prototype

```
typedef
EFI_STATUS
(EFIAPI * EFI_USBFN_IO_GET_VENDOR_ID_PRODUCT_ID) (
    IN EFI_USBFN_IO_PROTOCOL *This,
    OUT UINT16 *Vid,
    OUT UINT16 *Pid
);
```

### Parameters

<i>This</i>	A pointer to the <b>EFI_USBFN_IO_PROTOCOL</b> instance.
<i>Vid</i>	Returned vendor-id of the device.
<i>Pid</i>	Returned product-id of the device.

### Description

Returns vendor-id and product-id of the device.

### Status Codes

EFI_SUCCESS	The function returned successfully.
EFI_INVALID_PARAMETER	A parameter is invalid.
EFI_NOT_FOUND	Unable to return the vendor-id or the product-id

### Related Definitions

Vendor IDs (VIDs) are 16-bit numbers that represent the device's vendor company and are assigned and maintained by the USB-IF. Product IDs (PIDs) are 16-bit numbers assigned by each vendor to the device.

## EFI\_USBFN\_IO\_PROTOCOL.AbortTransfer()

### Summary

Aborts the transfer on the specified endpoint.

### Prototype

```
typedef
EFI_STATUS
(EFIAPI * EFI_USBFN_IO_ABORT_TRANSFER) (
  IN EFI_USBFN_IO_PROTOCOL *This,
  IN UINT8      EndpointIndex,
  IN EFI_USBFN_ENDPOINT_DIRECTION Direction
);
```

### Parameters

<i>This</i>	A pointer to the <b>EFI_USBFN_IO_PROTOCOL</b> instance.
<i>EndpointIndex</i>	Indicates the endpoint on which the ongoing transfer needs to be canceled.
<i>Direction</i>	Direction of the endpoint. Refer to the "Related Definitions" for this function (below) for details.

### Description

Aborts the transfer on the specified endpoint. This function should fail with **EFI\_INVALID\_PARAMETER** if the specified direction is incorrect for the endpoint.

### Status Codes

EFI_SUCCESS	The function returned successfully.
EFI_INVALID_PARAMETER	A parameter is invalid.
EFI_DEVICE_ERROR	The physical device reported an error.
EFI_NOT_READY	The physical device is busy or not ready to process this request.

### Related Definitions

```
typedef enum _EFI_USBFN_ENDPOINT_DIRECTION
{
  EfiUsbEndpointDirectionHostOut = 0,
  EfiUsbEndpointDirectionHostIn,
  EfiUsbEndpointDirectionDeviceTx = EfiUsbEndpointDirectionHostIn,
  EfiUsbEndpointDirectionDeviceRx = EfiUsbEndpointDirectionHostOut
} EFI_USBFN_ENDPOINT_DIRECTION;
```

## EFI\_USBFN\_IO\_PROTOCOL.GetEndpointStallState()

### Summary

Returns the stall state on the specified endpoint.

### Prototype

```
typedef
EFI_STATUS
(EFI_API * EFI_USBFN_IO_GET_ENDPOINT_STALL_STATE) (
  IN EFI_USBFN_IO_PROTOCOL *This,
  IN UINT8      EndpointIndex,
  IN EFI_USBFN_ENDPOINT_DIRECTION Direction,
  IN OUT BOOLEAN *State
);
```

### Parameters

<i>This</i>	A pointer to the <b>EFI_USBFN_IO_PROTOCOL</b> instance.
<i>EndpointIndex</i>	Indicates the endpoint.
<i>Direction</i>	Direction of the endpoint. Refer to the "Related Definitions" for <a href="#">EFI_USBFN_IO_PROTOCOL.AbortTransfer()</a> for details.
<i>State</i>	Boolean, true value indicates that the endpoint is in a stalled state, false otherwise.

### Description

Returns the stall state on the specified endpoint. This function would fail with **EFI\_INVALID\_PARAMETER** if the specified direction is incorrect for the endpoint.

### Status Codes

EFI_SUCCESS	The function returned successfully.
EFI_INVALID_PARAMETER	A parameter is invalid.
EFI_DEVICE_ERROR	The physical device reported an error.
EFI_NOT_READY	The physical device is busy or not ready to process this request.



## EFI\_USBFN\_IO\_PROTOCOL.SetEndpointStallState()

### Summary

Sets or clears the stall state on the specified endpoint.

### Prototype

```
typedef
EFI_STATUS
(EFI_API * EFI_USBFN_IO_SET_ENDPOINT_STALL_STATE) (
  IN EFI_USBFN_IO_PROTOCOL *This,
  IN UINT8      EndpointIndex,
  IN EFI_USBFN_ENDPOINT_DIRECTION Direction,
  IN BOOLEAN    State
);
```

### Parameters

<i>This</i>	A pointer to the <b>EFI_USBFN_IO_PROTOCOL</b> instance.
<i>EndpointIndex</i>	Indicates the endpoint.
<i>Direction</i>	Direction of the endpoint. Refer to the "Related Definitions" for the <a href="#">EFI_USBFN_IO_PROTOCOL.AbortTransfer()</a> function for details.
<i>State</i>	Requested stall state on the specified endpoint. True value causes the endpoint to stall; false value clears an existing stall.

### Description

Sets or clears the stall state on the specified endpoint. This function would fail with **EFI\_INVALID\_PARAMETER** if the specified direction is incorrect for the endpoint.

### Status Codes

EFI_SUCCESS	The function returned successfully.
EFI_INVALID_PARAMETER	A parameter is invalid.
EFI_DEVICE_ERROR	The physical device reported an error.
EFI_NOT_READY	The physical device is busy or not ready to process this request.

## EFI\_USBFN\_IO\_PROTOCOL.EventHandler()

### Summary

This function is called repeatedly to get information on USB bus states, receive-completion and transmit-completion events on the endpoints, and notification on setup packet on endpoint 0.

### Prototype

```
typedef
EFI_STATUS
(EFIAPI * EFI_USBFN_IO_EVENTHANDLER) (
    IN EFI_USBFN_IO_PROTOCOL *This,
    OUT EFI_USBFN_MESSAGE *Message,
    IN OUT UINTN *PayloadSize,
    OUT EFI_USBFN_MESSAGE_PAYLOAD *Payload
);
```

### Parameters

- This* A pointer to the **EFI\_USBFN\_IO\_PROTOCOL** instance.
- Message* Indicates the event that initiated this notification. Refer to the "Related Definitions" for this function (below) for all possible types.
- PayloadSize* On input, the size of the memory pointed by *Payload*. On output, the amount of data returned in *Payload*.
- Payload* A pointer to **EFI\_USBFN\_MESSAGE\_PAYLOAD** instance to return additional payload for current message. Refer to the "Related Definitions" for this function (below) for details on the type.

### Description

This function is called repeatedly to get information on USB bus states, receive-completion and transmit-completion events on the endpoints, and notification on setup packet on endpoint 0. A class driver must call **EFI\_USBFN\_IO\_PROTOCOL.EventHandler()** repeatedly to receive updates on the transfer status and number of bytes transferred on various endpoints. Refer to [Figure 60](#) for details.

A few messages have an associated payload that is returned in the supplied buffer. The following table describes various messages and their payload:

Message	Payload	Description
EfiUsbMsgSetupPacket	EFI_USB_DEVICE_REQUEST	SETUP packet was received.

EfiUsbMsgEndpointStatusChangedRx	EFI_USBFN_TRANSFER_RESULT	Some of the requested data has been transmitted to the host. It is the responsibility of the class driver to determine if any remaining data needs to be re-sent. The <i>Buffer</i> supplied to <a href="#">EFI_USBEN_IO_PROTOCOL.Transfer()</a> must be same as the <i>Buffer</i> field of the payload.
EfiUsbMsgEndpointStatusChangedTx	EFI_USBFN_TRANSFER_RESULT	Some of the requested data has been received from the host. It is the responsibility of the class driver to determine if it needs to wait for any remaining data. The <i>Buffer</i> supplied to <a href="#">EFI_USBEN_IO_PROTOCOL.Transfer()</a> must be same as the <i>Buffer</i> field of the payload.
EfiUsbMsgBusEventReset	None	A RESET bus event was signaled.
EfiUsbMsgBusEventDetach	None	A DETACH bus event was signaled.
EfiUsbMsgBusEventAttach	None	An ATTACH bus event was signaled.
EfiUsbMsgBusEventSuspend	None	A SUSPEND bus event was signaled.
EfiUsbMsgBusEventResume	None	A RESUME bus event was signaled.
EfiUsbMsgBusEventSpeed	EFI_USB_BUS_SPEED	A Bus speed update was signaled.

Table 140. Payload-associated Messages and Descriptions

## Status Codes

EFI_SUCCESS	The function returned successfully.
EFI_INVALID_PARAMETER	A parameter is invalid.
EFI_DEVICE_ERROR	The physical device reported an error.
EFI_NOT_READY	The physical device is busy or not ready to process this request.
EFI_BUFFER_TOO_SMALL	The Supplied buffer is not large enough to hold the message payload.

## Related Definitions

```
typedef enum _EFI_USBFN_MESSAGE {
    //
    // Nothing
    //
    EfiUsbMsgNone = 0,
    //
    // SETUP packet is received, returned Buffer contains
    // EFI_USB_DEVICE_REQUEST struct
    //
    EfiUsbMsgSetupPacket,
    //
    // Indicates that some of the requested data has been
    // received from the host. It is the responsibility of the
    // class driver to determine if it needs to wait for any
    // remaining data. Returned Buffer contains
    // EFI_USBFN_TRANSFER_RESULT struct containing endpoint
    // number, transfer status and count of bytes received.
    //
    EfiUsbMsgEndpointStatusChangedRx,

    //
    // Indicates that some of the requested data has been
    // transmitted to the host. It is the responsibility of the
    // class driver to determine if any remaining data needs to be
    // resent. Returned Buffer contains
    // EFI_USBFN_TRANSFER_RESULT struct containing endpoint
    // number, transfer status and count of bytes sent.
    //
    EfiUsbMsgEndpointStatusChangedTx,

    //
    // DETACH bus event signaled
    //
    EfiUsbMsgBusEventDetach,
    //
    // ATTACH bus event signaled
    //
    EfiUsbMsgBusEventAttach,
    //
    // RESET bus event signaled
    //
    EfiUsbMsgBusEventReset,
    //
    // SUSPEND bus event signaled
```

```

//
EfiUsbMsgBusEventSuspend,
//
// RESUME bus event signaled
//
EfiUsbMsgBusEventResume,
//
// Bus speed updated, returned buffer indicated bus speed
// using following enumeration named EFI_USB_BUS_SPEED
//
EfiUsbMsgBusEventSpeed
} EFI_USBFN_MESSAGE;

typedef enum _EFI_USBFN_TRANSFER_STATUS {
  UsbTransferStatusUnknown = 0,
  UsbTransferStatusComplete,
  UsbTransferStatusAborted,
  UsbTransferStatusActive,
  UsbTransferStatusNone
} EFI_USBFN_TRANSFER_STATUS;

typedef struct _EFI_USBFN_TRANSFER_RESULT {
  UINTN      BytesTransferred,
  EFI_USBFN_TRANSFER_STATUS TransferStatus,
  UINT8      EndpointIndex,
  EFI_USBFN_ENDPOINT_DIRECTION Direction,
  VOID      *Buffer,
} EFI_USBFN_TRANSFER_RESULT;

typedef enum _EFI_USB_BUS_SPEED {
  UsbBusSpeedUnknown = 0,
  UsbBusSpeedLow,
  UsbBusSpeedFull,
  UsbBusSpeedHigh,
  UsbBusSpeedSuper,
  UsbBusSpeedMaximum = UsbBusSpeedSuper
} EFI_USB_BUS_SPEED;

typedef union _EFI_USBFN_MESSAGE_PAYLOAD {
  EFI_USB_DEVICE_REQUEST udr,
  EFI_USBFN_TRANSFER_RESULT utr,
  EFI_USB_BUS_SPEED ubs,
} EFI_USBFN_MESSAGE_PAYLOAD;

```

## EFI\_USBFN\_IO\_PROTOCOL.Transfer()

### Summary

This function handles transferring data to or from the host on the specified endpoint, depending on the direction specified.

### Prototype

```
typedef
EFI_STATUS
(EFIAPI *EFI_USBFN_IO_TRANSFER) (
  IN EFI_USBFN_IO_PROTOCOL *This,
  IN UINT8 EndpointIndex,
  IN EFI_USBFN_ENDPOINT_DIRECTION Direction,
  IN OUT UINTN *BufferSize,
  IN OUT VOID *Buffer
);
```

### Parameters

This	A pointer to the <b>EFI_USBFN_IO_PROTOCOL</b> instance.
EndpointIndex	Indicates the endpoint on which TX or RX transfer needs to take place.
Direction	Direction of the endpoint. Refer to the "Related Definitions" of the <a href="#">EFI_USBFN_IO_PROTOCOL.AbortTransfer()</a> function for details.
BufferSize	If <i>Direction</i> is EfiUsbEndpointDirectionDeviceRx: On input, the size of the <i>Buffer</i> in bytes. On output, the amount of data returned in <i>Buffer</i> in bytes. If <i>Direction</i> is EfiUsbEndpointDirectionDeviceTx: On input, the size of the <i>Buffer</i> in bytes. On output, the amount of data transmitted in bytes.
Buffer	If <i>Direction</i> is EfiUsbEndpointDirectionDeviceRx: The <i>Buffer</i> to return the received data. If <i>Direction</i> is EfiUsbEndpointDirectionDeviceTx: The Buffer that contains the data to be transmitted.

**Note:** This buffer is allocated and freed using the [EFI\\_USBFN\\_IO\\_PROTOCOL.AbortTransfer\(\)](#) and [EFI\\_USBFN\\_IO\\_PROTOCOL.FreeTransferBuffer\(\)](#) functions. The caller of this function must not free or reuse the buffer until EfiUsbMsgEndpointStatusChangedRx or EfiUsbMsgEndpointStatusChangedTx message was received along with the address of the transfer buffer as part of the message payload. Refer to the function definition for [EFI\\_USBFN\\_IO\\_PROTOCOL.EventHandler\(\)](#) for more information on various messages and their payloads.

### Description

This function handles transferring data to or from the host on the specified endpoint, depending on the direction specified.

Direction	Description
EfiUsbEndpointDirectionDeviceTx	Start a transmit transfer on the specified endpoint and return immediately.
EfiUsbEndpointDirectionDeviceRx	Start a receive transfer on the specified endpoint and return immediately with available data.

A class driver must call [EFI\\_USBFN\\_IO\\_PROTOCOL.EventHandler\(\)](#) repeatedly to receive updates on the transfer status and the number of bytes transferred on various endpoints. Upon an update of the transfer status, the *Buffer* field of the **EFI\_USBFN\_TRANSFER\_RESULT** structure (as described in the function description for [EFI\\_USBFN\\_IO\\_PROTOCOL.EventHandler\(\)](#)) must be initialized with the *Buffer* pointer that was supplied to this method.

The overview of the call sequence is illustrated in the [Figure 60](#).

This function should fail with **EFI\_INVALID\_PARAMETER** if the specified direction is incorrect for the endpoint.

## Status codes

EFI_SUCCESS	The function returned successfully.
EFI_INVALID_PARAMETER	A parameter is invalid.
EFI_DEVICE_ERROR	The physical device reported an error.
EFI_NOT_READY	The physical device is busy or not ready to process this request.

## EFI\_USBFN\_IO\_PROTOCOL.GetMaxTransferSize()

### Summary

Returns the maximum supported transfer size.

### Prototype

```
typedef
EFI_STATUS
(EFIAPI * EFI_USBFN_IO_GET_MAXTRANSFER_SIZE) (
    IN EFI_USBFN_IO_PROTOCOL *This,
    OUT UINTN *MaxTransferSize
);
```

### Parameters

<i>This</i>	A pointer to the <b>EFI_USBFN_IO_PROTOCOL</b> instance.
<i>MaxTransferSize</i>	The maximum supported transfer size, in bytes.

### Description

Returns the maximum number of bytes that the underlying controller can accommodate in a single transfer.

### Status Codes

EFI_SUCCESS	The function returned successfully.
EFI_INVALID_PARAMETER	A parameter is invalid.
EFI_DEVICE_ERROR	The physical device reported an error.
EFI_NOT_READY	The physical device is busy or not ready to process this request.



## EFI\_USBFN\_IO\_PROTOCOL.AllocateTransferBuffer()

### Summary

Allocates a transfer buffer of the specified size that satisfies the controller requirements.

### Prototype

```
typedef
EFI_STATUS
(EFI_API * EFI_USBFN_IO_ALLOCATE_TRANSFER_BUFFER) (
  IN EFI_USBFN_IO_PROTOCOL *This,
  IN UINTN      Size,
  OUT VOID      **Buffer
);
```

### Parameters

<i>This</i>	A pointer to the <b>EFI_USBFN_IO_PROTOCOL</b> instance.
<i>Size</i>	The number of bytes to allocate for the transfer buffer.
<i>Buffer</i>	A pointer to a pointer to the allocated buffer if the call succeeds; undefined otherwise.

### Description

The **AllocateTransferBuffer()** function allocates a memory region of *Size* bytes and returns the address of the allocated memory that satisfies the underlying controller requirements in the location referenced by *Buffer*.

The allocated transfer buffer must be freed using a matching call to [EFI\\_USBFN\\_IO\\_PROTOCOL.FreeTransferBuffer\(\)](#) function.

### Status Codes

EFI_SUCCESS	The function returned successfully.
EFI_INVALID_PARAMETER	A parameter is invalid.
EFI_OUT_OF_RESOURCES	The requested transfer buffer could not be allocated.

## EFI\_USBFN\_IO\_PROTOCOL.FreeTransferBuffer()

### Summary

Deallocates the memory allocated for the transfer buffer by the [EFI\\_USBFN\\_IO\\_PROTOCOL.AllocateTransferBuffer\(\)](#) function.

### Prototype

```
typedef
EFI_STATUS
(EFI_API * EFI_USBFN_IO_FREE_TRANSFER_BUFFER) (
  IN EFI_USBFN_IO_PROTOCOL *This,
  IN VOID *Buffer
);
```

### Parameters

<i>This</i>	A pointer to the <b>EFI_USBFN_IO_PROTOCOL</b> instance.
<i>Buffer</i>	A pointer to the transfer buffer to deallocate.

### Description

The [EFI\\_USBFN\\_IO\\_PROTOCOL.FreeTransferBuffer\(\)](#) function deallocates the memory specified by *Buffer*. The Buffer that is freed must have been allocated by [EFI\\_USBFN\\_IO\\_PROTOCOL.AllocateTransferBuffer\(\)](#).

### Status Codes

EFI_SUCCESS	The function returned successfully.
EFI_INVALID_PARAMETER	A parameter is invalid.

## EFI\_USBFN\_IO\_PROTOCOL.StartController()

### Summary

This function supplies power to the USB controller if needed and initializes the hardware and the internal data structures. The port must not be activated by this function

### Prototype

```
typedef
EFI_STATUS
(EFIAPI * EFI_USBFN_IO_START_CONTROLLER) (
    IN EFI_USBFN_IO_PROTOCOL *This
);
```

### Parameters

*This* A pointer to the **EFI\_USBFN\_IO\_PROTOCOL** instance.

### Description

This function starts the hardware by supplying power to the USB controller if needed, and initializing the hardware and internal data structures. The port must not be activated by this function.

### Status codes

EFI_SUCCESS	The function returned successfully.
EFI_INVALID_PARAMETER	A parameter is invalid.
EFI_DEVICE_ERROR	The physical device reported an error.

## EFI\_USBFN\_IO\_PROTOCOL.StopController()

### Summary

This function stops the USB hardware device.

### Prototype

```
typedef
EFI_STATUS
(EFIAPI * EFI_USBFN_IO_STOP_CONTROLLER) (
    IN EFI_USBFN_IO_PROTOCOL *This
);
```

### Parameters

*This* A pointer to the **EFI\_USBFN\_IO\_PROTOCOL** instance.

### Description

This function stops the USB hardware device

### Status codes

EFI_SUCCESS	The function returned successfully.
EFI_INVALID_PARAMETER	A parameter is invalid.
EFI_DEVICE_ERROR	The physical device reported an error.

## EFI\_USBFN\_IO\_PROTOCOL.SetEndpointPolicy()

### Summary

This function sets the configuration policy for the specified non-control endpoint. Refer to the description for calling restrictions.

### Prototype

```
typedef
EFI_STATUS
(EFI_API * EFI_USBFN_SET_ENDPOINT_POLICY) (
  IN EFI_USBFN_IO_PROTOCOL *This,
  IN UINT8      EndpointIndex
  IN EFI_USBFN_ENDPOINT_DIRECTION Direction,
  IN EFI_USBFN_POLICY_TYPE PolicyType,
  IN UINTN      BufferSize,
  IN VOID      *Buffer
);
```

### Parameters

<i>This</i>	A pointer to the <b>EFI_USBFN_IO_PROTOCOL</b> instance.
<i>EndpointIndex</i>	Indicates the non-control endpoint for which the policy needs to be set.
<i>Direction</i>	Direction of the endpoint. Refer to the "Related Definitions" for the <a href="#">EFI_USBFN_IO_PROTOCOL.AbortTransfer()</a> function for details.
<i>PolicyType</i>	Policy type the user is trying to set for the specified non-control endpoint. Refer to "Related Definitions" for this function below for details.
<i>BufferSize</i>	The size of the <i>Buffer</i> in bytes.
<i>Buffer</i>	The new value for the policy parameter that <i>PolicyType</i> specifies. Refer to "Related Definitions" for this function below for details.

### Description

This function sets the configuration policy for the specified non-control endpoint. This function can only be called before [EFI\\_USBFN\\_IO\\_PROTOCOL.StartController\(\)](#) or after [EFI\\_USBFN\\_IO\\_PROTOCOL.StopController\(\)](#) has been called.

## Status codes

EFI_SUCCESS	The function returned successfully.
EFI_INVALID_PARAMETER	A parameter is invalid.
EFI_DEVICE_ERROR	The physical device reported an error.
EFI_UNSUPPORTED	Changing this policy value is not supported.

## Related Definitions

```
typedef enum _EFI_USBFN_POLICY_TYPE
{
    EfiUsbPolicyUndefined = 0,
    EfiUsbPolicyMaxTransactionSize,
    EfiUsbPolicyZeroLengthTerminationSupport,
    EfiUsbPolicyZeroLengthTermination
} EFI_USBFN_POLICY_TYPE;
```

### EfiUsbPolicyUndefined

Invalid policy value that must never be used across driver boundary. If used, the function must not return a success status code.

### EfiUsbPolicyMaxTransactionSize

EfiUsbPolicyMaxTransactionSize is only used with [EFI\\_USBFN\\_IO\\_PROTOCOL.GetEndpointPolicy\(\)](#). It provides the size of the largest single transaction (delivery of service to an endpoint) supported by a controller. It must be greater than or equal to the maximum transfer size that can be retrieved by calling [EFI\\_USBFN\\_IO\\_PROTOCOL.GetMaxTransferSize\(\)](#).

	GetEndpointPolicy	SetEndpointPolicy
BufferSize	4 bytes, sizeof(UINT32)	Not applicable
Return Status	EFI_STATUS	EFI_UNSUPPORTED

### EfiUsbPolicyZeroLengthTerminationSupport

EfiUsbPolicyZeroLengthTerminationSupport is only used with [EFI\\_USBFN\\_IO\\_PROTOCOL.GetEndpointPolicy\(\)](#). It is TRUE if the USB controller is capable of automatically handling zero length packets when the transfer size is a multiple of USB maximum packet size and FALSE if it is not supported by the controller.

	GetEndpointPolicy	SetEndpointPolicy
BufferSize	1 byte, sizeof(BOOLEAN)	Not applicable
Return Status	EFI_STATUS	EFI_UNSUPPORTED

### EfiUsbPolicyZeroLengthTermination

When used with [EFI\\_USBEN\\_IO\\_PROTOCOL.GetEndpointPolicy\(\)](#), a TRUE value is returned if the USB controller hardware is configured to automatically handle zero length packets when the transfer size is a multiple of USB maximum packet size; a FALSE value is returned if the controller hardware is not configured to do this.

Using [EFI\\_USBEN\\_IO\\_PROTOCOL.SetEndpointPolicy\(\)](#) to set the EfiUsbPolicyZeroLengthTermination policy is only applicable to USB controller hardware capable of supporting automatic zero length packet termination. When this value is set to TRUE, the controller must be configured to handle zero length termination for the specified endpoint. When this value is set to FALSE, the controller must be configured to not handle zero length termination for the specified endpoint.

The USB controller's default policy must not enable automatic zero length packet termination, even if the hardware is capable of supporting it.

	GetEndpointPolicy	SetEndpointPolicy
BufferSize	1 byte, sizeof (BOOLEAN)	1 byte, sizeof (BOOLEAN)
Return Status	EFI_STATUS	EFI_STATUS

## EFI\_USBFN\_IO\_PROTOCOL.GetEndpointPolicy()

### Summary

This function retrieves the configuration policy for the specified non-control endpoint. There are no associated calling restrictions for this function.

### Prototype

```
typedef
EFI_STATUS
(EFIAPI * EFI_USBFN_GET_ENDPOINT_POLICY) (
    IN EFI_USBFN_IO_PROTOCOL *This,
    IN UINT8 EndpointIndex
    IN EFI_USBFN_ENDPOINT_DIRECTION Direction,
    IN EFI_USBFN_POLICY_TYPE PolicyType,
    IN OUT UINTN *BufferSize,
    IN OUT VOID *Buffer
);
```

### Parameters

<i>This</i>	A pointer to the <b>EFI_USBFN_IO_PROTOCOL</b> instance.
<i>EndpointIndex</i>	Indicates the non-control endpoint for which the policy needs to be set.
<i>Direction</i>	Direction of the endpoint. Refer to the "Related Definitions" for the <a href="#">EFI_USBFN_IO_PROTOCOL.AbortTransfer()</a> function for details.
<i>PolicyType</i>	Policy type the user is trying to retrieve for the specified non-control endpoint. Refer to the "Related Definitions" for the <a href="#">EFI_USBFN_IO_PROTOCOL.SetEndpointPolicy()</a> function for details.
<i>BufferSize</i>	On input, the size of <i>Buffer</i> in bytes. On output, the amount of data returned in <i>Buffer</i> in bytes.
<i>Buffer</i>	A pointer to a buffer to return requested endpoint policy value. Refer to the "Related Definitions" for the <a href="#">EFI_USBFN_IO_PROTOCOL.SetEndpointPolicy()</a> function for size requirements of various policy types.

### Description

This function retrieves the configuration policy for the specified non-control endpoint. This function has no calling restrictions.

### Status codes

EFI_SUCCESS	The function returned successfully.
EFI_INVALID_PARAMETER	A parameter is invalid.



EFI_DEVICE_ERROR	The physical device reported an error.
EFI_UNSUPPORTED	The specified policy value is not supported.
EFI_BUFFER_TOO_SMALL	Supplied buffer is not large enough to hold requested policy value.

### USB Function Sequence Diagram

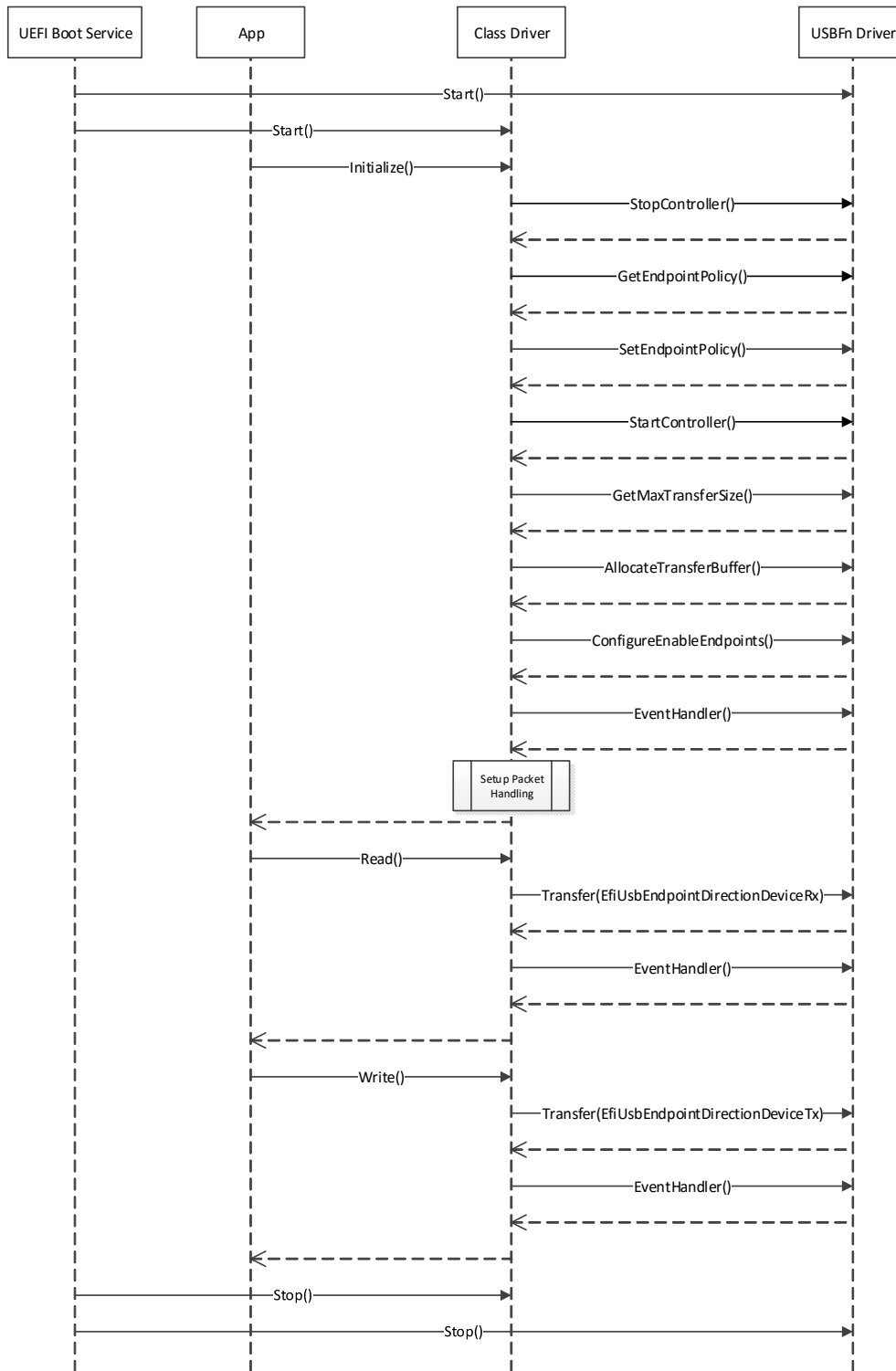

Figure 60. Sequence of Operations with Endpoint Policy Changes

## 18 Protocols — Debugger Support

---

This chapter describes a minimal set of protocols and associated data structures necessary to enable the creation of source level debuggers for EFI. It does not fully define a debugger design. Using the services described in this document, it should also be possible to implement a variety of debugger solutions.

### 18.1 Overview

Efficient UEFI driver and application development requires the availability of source level debugging facilities. Although completely on-target debuggers are clearly possible, UEFI debuggers are generally expected to be remotely hosted. That is to say, the debugger itself will be split between two machines, which are the host and target. A majority of debugger code runs on the host that is typically responsible for disassembly, symbol management, source display, and user interface. Similarly, a smaller piece of code runs on the target that establishes the communication to the host and proxies requests from the host. The on-target code is known as the “debug agent.”

The debug agent design is subdivided further into two parts, which are the processor/platform abstraction and the debugger host specific communication grammar. This specification describes architectural interfaces for the former only. Specific implementations for various debugger host communication grammars can be created that make use of the facilities described in this specification.

The processor/platform abstraction is presented as a pair of protocol interfaces, which are the Debug Support protocol and the Debug Port protocol.

The Debug Support protocol abstracts the processor’s debugging facilities, namely a mechanism to manage the processor’s context via caller-installable exception handlers.

The Debug Port protocol abstracts the device that is used for communication between the host and target. Typically this will be a 16550 serial port, 1394 device, or other device that is nominally a serial stream.

Furthermore, a table driven, quiescent, memory-only mechanism for determining the base address of PE32+ images is provided to enable the debugger host to determine where images are located in memory.

Aside from timing differences that occur because of running code associated with the debug agent and user initiated changes to the machine context, the operation of the on-target debugger component must be transparent to the rest of the system. In addition, no portion of the debug agent that runs in interrupt context may make any calls to EFI services or other protocol interfaces.

The services described in this document do not comprise a complete debugger, rather they provide a minimal abstraction required to implement a wide variety of debugger solutions.

## 18.2 EFI Debug Support Protocol

This section defines the EFI Debug Support protocol which is used by the debug agent.

### 18.2.1 EFI Debug Support Protocol Overview

The debug-agent needs to be able to gain control of the machine when certain types of events occur; i.e., breakpoints, processor exceptions, etc. Additionally, the debug agent must also be able to periodically gain control during operation of the machine to check for asynchronous commands from the host. The EFI Debug Support protocol services enable these capabilities.

The EFI Debug Support protocol interfaces produce callback registration mechanisms which are used by the debug agent to register functions that are invoked either periodically or when specific processor exceptions. When they are invoked by the Debug Support driver, these callback functions are passed the current machine context record. The debug agent may modify this context record to change the machine context which is restored to the machine after the callback function returns. The debug agent does not run in the same context as the rest of UEFI and all modifications to the machine context are deferred until after the callback function returns.

It is expected that there will typically be two instances of the EFI Debug Support protocol in the system. One associated with the native processor instruction set (IA-32, x64, ARM, RISC-V, or Itanium processor family), and one for the EFI virtual machine that implements EFI byte code (EBC).

While multiple instances of the EFI Debug Support protocol are expected, there must never be more than one for any given instruction set.

## EFI\_DEBUG\_SUPPORT\_PROTOCOL

### Summary

This protocol provides the services to allow the debug agent to register callback functions that are called either periodically or when specific processor exceptions occur.

### GUID

```
#define EFI_DEBUG_SUPPORT_PROTOCOL_GUID \
  {0x2755590C,0x6F3C,0x42FA,\
   {0x9E,0xA4,0xA3,0xBA,0x54,0x3C,0xDA,0x25}}
```

### Protocol Interface Structure

```
typedef struct {
  EFI_INSTRUCTION_SET_ARCHITECTURE Isa;
  EFI_GET_MAXIMUM_PROCESSOR_INDEX GetMaximumProcessorIndex;
  EFI_REGISTER_PERIODIC_CALLBACK RegisterPeriodicCallback;
  EFI_REGISTER_EXCEPTION_CALLBACK RegisterExceptionCallback;
  EFI_INVALIDATE_INSTRUCTION_CACHE InvalidateInstructionCache;
} EFI_DEBUG_SUPPORT_PROTOCOL;
```

## Parameters

- Isa* Declares the processor architecture for this instance of the EFI Debug Support protocol.
- GetMaximumProcessorIndex* Returns the maximum processor index value that may be used with [EFI\\_DEBUG\\_SUPPORT\\_PROTOCOL.RegisterPeriodicCallback\(\)](#) and [EFI\\_DEBUG\\_SUPPORT\\_PROTOCOL.RegisterExceptionCallback\(\)](#). See the [EFI\\_DEBUG\\_SUPPORT\\_PROTOCOL.GetMaximumProcessorIndex\(\)](#) function description.
- RegisterPeriodicCallback* Registers a callback function that will be invoked periodically and asynchronously to the execution of EFI. See the [RegisterPeriodicCallback\(\)](#) function description.
- RegisterExceptionCallback* Registers a callback function that will be called each time the specified processor exception occurs. See the [RegisterExceptionCallback\(\)](#) function description.
- InvalidateInstructionCache* Invalidate the instruction cache of the processor. This is required by processor architectures where instruction and data caches are not coherent when instructions in the code under debug has been modified by the debug agent. See the [EFI\\_DEBUG\\_SUPPORT\\_PROTOCOL.InvalidateInstructionCache\(\)](#) function description.

## Related Definitions

Refer to the Microsoft PE/COFF Specification revision 6.2 or later for **IMAGE\_FILE\_MACHINE** definitions.

**Note:** *At the time of publication of this specification, the latest revision of the PE/COFF specification was 6.2. The definition of **IMAGE\_FILE\_MACHINE\_EBC** is not included in revision 6.2 of the PE/COFF specification. It will be added in a future revision of the PE/COFF specification.*

```
//
// Machine type definition
//
typedef enum {
  IsaI386 = IMAGE_FILE_MACHINE_I386,    // 0x014C
  IsaX64 = IMAGE_FILE_MACHINE_X64,     // 0x8664
  IsaIpf = IMAGE_FILE_MACHINE_IA64,    // 0x0200
  IsaEbc = IMAGE_FILE_MACHINE_EBC,     // 0x0EBC
  IsaArm = IMAGE_FILE_MACHINE_ARMTHUMB_MIXED // 0x1C2
  IsaAArch64 = IMAGE_FILE_MACHINE_AARCH64 // 0xAA64
  IsaRISCV32 = IMAGE_FILE_MACHINE_RISCV32 // 0x5032
  IsaRISCV64 = IMAGE_FILE_MACHINE_RISCV64 // 0x5064
  IsaRISCV128 = IMAGE_FILE_MACHINE_RISCV128 // 0x5128
} EFI_INSTRUCTION_SET_ARCHITECTURE;
```

## Description

The EFI Debug Support protocol provides the interfaces required to register debug agent callback functions and to manage the processor's instruction stream as required. Registered callback functions are invoked in interrupt context when the specified event occurs.

The driver that produces the EFI Debug Support protocol is also responsible for saving the machine context prior to invoking a registered callback function and restoring it after the callback function returns prior to returning to the code under debug. If the debug agent has modified the context record, the modified context must be used in the restore operation.

Furthermore, if the debug agent modifies any of the code under debug (to set a software breakpoint for example), it must call the **InvalidateInstructionCache()** function for the region of memory that has been modified.

## EFI\_DEBUG\_SUPPORT\_PROTOCOL.GetMaximumProcessorIndex()

### Summary

Returns the maximum value that may be used for the *ProcessorIndex* parameter in [EFI\\_DEBUG\\_SUPPORT\\_PROTOCOL.RegisterPeriodicCallback\(\)](#) and [EFI\\_DEBUG\\_SUPPORT\\_PROTOCOL.RegisterExceptionCallback\(\)](#).

### Prototype

```
typedef
EFI_STATUS
(EFIAPI *EFI_GET_MAXIMUM_PROCESSOR_INDEX) (
  IN EFI_DEBUG_SUPPORT_PROTOCOL *This,
  OUT UINTN *MaxProcessorIndex
);
```

### Parameters

<i>This</i>	A pointer to the <a href="#">EFI_DEBUG_SUPPORT_PROTOCOL</a> instance. Type <a href="#">EFI_DEBUG_SUPPORT_PROTOCOL</a> is defined in this section.
<i>MaxProcessorIndex</i>	Pointer to a caller-allocated UINTN in which the maximum supported processor index is returned.

### Description

The **GetMaximumProcessorIndex()** function returns the maximum processor index in the output parameter *MaxProcessorIndex*. This value is the largest value that may be used in the *ProcessorIndex* parameter for both **RegisterPeriodicCallback()** and **RegisterExceptionCallback()**. All values between 0 and *MaxProcessorIndex* must be supported by **RegisterPeriodicCallback()** and **RegisterExceptionCallback()**.

It is the responsibility of the caller to insure all parameters are correct. There is no provision for parameter checking by **GetMaximumProcessorIndex()**. The implementation behavior when an invalid parameter is passed is not defined by this specification.

### Status Codes Returned

EFI_SUCCESS	The function completed successfully.
-------------	--------------------------------------

## EFI\_DEBUG\_SUPPORT\_PROTOCOL.RegisterPeriodicCallback()

### Summary

Registers a function to be called back periodically in interrupt context.

### Prototype

```
typedef
EFI_STATUS
(EFIAPI *EFI_REGISTER_PERIODIC_CALLBACK) (
  IN EFI_DEBUG_SUPPORT_PROTOCOL *This,
  IN UINTN      ProcessorIndex,
  IN EFI_PERIODIC_CALLBACK  PeriodicCallback
);
```

### Parameters

<i>This</i>	A pointer to the <a href="#">EFI_DEBUG_SUPPORT_PROTOCOL</a> instance. Type <a href="#">EFI_DEBUG_SUPPORT_PROTOCOL</a> is defined in <a href="#">Section 18.2</a> .
<i>ProcessorIndex</i>	Specifies which processor the callback function applies to.
<i>PeriodicCallback</i>	A pointer to a function of type <a href="#">PERIODIC_CALLBACK</a> that is the main periodic entry point of the debug agent. It receives as a parameter a pointer to the full context of the interrupted execution thread.

### Related Definitions

```
typedef
VOID (*EFI_PERIODIC_CALLBACK) (
  IN OUT EFI_SYSTEM_CONTEXT      SystemContext
);
```

**// Universal EFI\_SYSTEM\_CONTEXT definition**

```
typedef union {
  EFI_SYSTEM_CONTEXT_EBC      *SystemContextEbc;
  EFI_SYSTEM_CONTEXT_IA32     *SystemContextIa32;
  EFI_SYSTEM_CONTEXT_X64      *SystemContextX64;
  EFI_SYSTEM_CONTEXT_IPF      *SystemContextIpf;
  EFI_SYSTEM_CONTEXT_ARM      *SystemContextArm;
  EFI_SYSTEM_CONTEXT_AARCH64  *SystemContextAArch64;
  EFI_SYSTEM_CONTEXT_RISCV32  *SystemContextRiscV32;
  EFI_SYSTEM_CONTEXT_RISCV64  *SystemContextRiscV64;
  EFI_SYSTEM_CONTEXT_RISCV128 *SystemContextRiscv128;
} EFI_SYSTEM_CONTEXT;
```



```

// System context for virtual EBC processors
typedef struct {
    UINT64      R0, R1, R2, R3, R4, R5, R6, R7;
    UINT64      Flags;
    UINT64      ControlFlags;
    UINT64      Ip;
} EFI_SYSTEM_CONTEXT_EBC;

// System context for RISC-V 32
typedef struct {

    // Integer registers
    UINT32      X0, X1, X2, X3, X4, X5, X6, X7;
    UINT32      X8, X9, X10, X11, X12, X13, X14, X15;
    UINT32      X16, X17, X18, X19, X20, X21, X22, X23;
    UINT32      X24, X25, X25, X27, X28, X29, X30, X31;

    // Floating registers
    UINT64      F0, F1, F2, F3, F4, F5, F6, F7;
    UINT64      F8, F9, F10, F11, F12, F13, F14, F15;
    UINT64      F16, F17, F18, F19, F20, F21, F22, F23;
    UINT64      F24, F25, F25, F27, F28, F29, F30, F31;
} EFI_SYSTEM_CONTEXT_RISCV32;

// System context for RISC-V 64
typedef struct {

    // Integer registers
    UINT64      X0, X1, X2, X3, X4, X5, X6, X7;
    UINT64      X8, X9, X10, X11, X12, X13, X14, X15;
    UINT64      X16, X17, X18, X19, X20, X21, X22, X23;
    UINT64      X24, X25, X25, X27, X28, X29, X30, X31;

    // Floating registers
    UINT128     F0, F1, F2, F3, F4, F5, F6, F7;
    UINT128     F8, F9, F10, F11, F12, F13, F14, F15;
    UINT128     F16, F17, F18, F19, F20, F21, F22, F23;
    UINT128     F24, F25, F25, F27, F28, F29, F30, F31;
} EFI_SYSTEM_CONTEXT_RISCV64;

// System context for RISC-V 128
typedef struct {

    // Integer registers
    UINT128     X0, X1, X2, X3, X4, X5, X6, X7;
    UINT128     X8, X9, X10, X11, X12, X13, X14, X15;
    UINT128     X16, X17, X18, X19, X20, X21, X22, X23;

```

```

UINT128    X24, X25, X25, X27, X28, X29, X30, X31;

// Floating registers
UINT128    F0, F1, F2, F3, F4, F5, F6, F7;
UINT128    F8, F9, F10, F11, F12, F13, F14, F15;
UINT128    F16, F17, F18, F19, F20, F21, F22, F23;
UINT128    F24, F25, F25, F27, F28, F29, F30, F31;

} EFI_SYSTEM_CONTEXT_RISCV128;
    
```

**Note:** When the context record field is larger than the register being stored in it, the upper bits of the context record field are unused and ignored

```

// System context for IA-32 processors
typedef struct {
    UINT32 ExceptionData; // ExceptionData is
        // additional data pushed
        // on the stack by some
        // types of IA-32
        // exceptions
    EFI_FX_SAVE_STATE_IA32 FxSaveState;
    UINT32    Dr0, Dr1, Dr2, Dr3, Dr6, Dr7;
    UINT32    Cr0, Cr1 /* Reserved */, Cr2, Cr3, Cr4;
    UINT32    Eflags;
    UINT32    Ldtr, Tr;
    UINT32    Gdtr[2], Idtr[2];
    UINT32    Eip;
    UINT32    Gs, Fs, Es, Ds, Cs, Ss;
    UINT32    Edi, Esi, Ebp, Esp, Ebx, Edx, Ecx, Eax;
} EFI_SYSTEM_CONTEXT_IA32;
    
```

```

// FXSAVE_STATE - FP / MMX / XMM registers
typedef struct {
    UINT16    Fcw;
    UINT16    Fsw;
    UINT16    Ftw;
    UINT16    Opcode;
    UINT32    Eip;
    UINT16    Cs;
    UINT16    Reserved1;
    UINT32    DataOffset;
    UINT16    Ds;
    UINT8     Reserved2[10];
    UINT8     St0Mm0[10], Reserved3[6];
    
```

```

UINT8      St1Mm1[10], Reserved4[6];
UINT8      St2Mm2[10], Reserved5[6];
UINT8      St3Mm3[10], Reserved6[6];
UINT8      St4Mm4[10], Reserved7[6];
UINT8      St5Mm5[10], Reserved8[6];
UINT8      St6Mm6[10], Reserved9[6];
UINT8      St7Mm7[10], Reserved10[6];
UINT8      Xmm0[16];
UINT8      Xmm1[16];
UINT8      Xmm2[16];
UINT8      Xmm3[16];
UINT8      Xmm4[16];
UINT8      Xmm5[16];
UINT8      Xmm6[16];
UINT8      Xmm7[16];
UINT8      Reserved11[14 * 16];
} EFI_FX_SAVE_STATE_IA32

// System context for x64 processors
typedef struct {
  UINT64      ExceptionData; // ExceptionData is
                          // additional data pushed
                          // on the stack by some
                          // types of x64 64-bit
                          // mode exceptions
  EFI_FX_SAVE_STATE_X64 FxSaveState;
  UINT64      Dr0, Dr1, Dr2, Dr3, Dr6, Dr7;
  UINT64      Cr0, Cr1 /* Reserved */, Cr2, Cr3, Cr4, Cr8;
  UINT64      Rflags;
  UINT64      Ldtr, Tr;
  UINT64      Gdtr[2], Idtr[2];
  UINT64      Rip;
  UINT64      Gs, Fs, Es, Ds, Cs, Ss;
  UINT64      Rdi, Rsi, Rbp, Rsp, Rbx, Rdx, Rcx, Rax;
  UINT64      R8, R9, R10, R11, R12, R13, R14, R15;
} EFI_SYSTEM_CONTEXT_X64;

// FXSAVE_STATE – FP / MMX / XMM registers
typedef struct {
  UINT16      Fcw;
  UINT16      Fsw;
  UINT16      Ftw;
  UINT16      Opcode;

```

```

UINT64    Rip;
UINT64    DataOffset;
UINT8     Reserved1[8];
UINT8     St0Mm0[10], Reserved2[6];
UINT8     St1Mm1[10], Reserved3[6];
UINT8     St2Mm2[10], Reserved4[6];
UINT8     St3Mm3[10], Reserved5[6];
UINT8     St4Mm4[10], Reserved6[6];
UINT8     St5Mm5[10], Reserved7[6];
UINT8     St6Mm6[10], Reserved8[6];
UINT8     St7Mm7[10], Reserved9[6];
UINT8     Xmm0[16];
UINT8     Xmm1[16];
UINT8     Xmm2[16];
UINT8     Xmm3[16];
UINT8     Xmm4[16];
UINT8     Xmm5[16];
UINT8     Xmm6[16];
UINT8     Xmm7[16];
UINT8     Reserved11[14 * 16];
} EFI_FX_SAVE_STATE_X64;
    
```

```

// System context for Itanium processor family
typedef struct {
UINT64 Reserved;

UINT64 R1, R2, R3, R4, R5, R6, R7, R8, R9, R10,
        R11, R12, R13, R14, R15, R16, R17, R18, R19, R20,
        R21, R22, R23, R24, R25, R26, R27, R28, R29, R30,
        R31;

UINT64 F2[2], F3[2], F4[2], F5[2], F6[2],
        F7[2], F8[2], F9[2], F10[2], F11[2],
        F12[2], F13[2], F14[2], F15[2], F16[2],
        F17[2], F18[2], F19[2], F20[2], F21[2],
        F22[2], F23[2], F24[2], F25[2], F26[2],
        F27[2], F28[2], F29[2], F30[2], F31[2];

UINT64 Pr;

UINT64 B0, B1, B2, B3, B4, B5, B6, B7;
    
```

```

// application registers
UINT64 ArRsc, ArBsp, ArBspstore, ArRnat;
UINT64 ArFcr;
UINT64 ArEflag, ArCsd, ArSsd, ArCflg;
UINT64 ArFsr, ArFir, ArFdr;
UINT64 ArCcv;
UINT64 ArUnat;
UINT64 ArFpsr;
UINT64 ArPfs, ArLc, ArEc;

// control registers
UINT64 CrDcr, CrItm, CrIva, CrPta, CrIpsr, CrIsr;
UINT64 CrIip, CrIfa, CrItir, CrIpa, CrIfs, CrIim;
UINT64 CrIha;

// debug registers
UINT64 Dbr0, Dbr1, Dbr2, Dbr3, Dbr4, Dbr5, Dbr6, Dbr7;
UINT64 Ibr0, Ibr1, Ibr2, Ibr3, Ibr4, Ibr5, Ibr6, Ibr7;

// virtual registers
UINT64 IntNat; // nat bits for R1-R31

} EFI_SYSTEM_CONTEXT_IPF;

//
// ARM processor context definition
//
typedef struct {
UINT32 R0;
UINT32 R1;
UINT32 R2;
UINT32 R3;
UINT32 R4;
UINT32 R5;
UINT32 R6;
UINT32 R7;
UINT32 R8;
UINT32 R9;
UINT32 R10;
UINT32 R11;
UINT32 R12;
UINT32 SP;
UINT32 LR;

```

```
    UINT32 PC;
    UINT32 CPSR;
    UINT32 DFSR;
    UINT32 DFAR;
    UINT32 IFSR;
} EFI_SYSTEM_CONTEXT_ARM;
//
///
/// AARCH64 processor context definition.
///
typedef struct {
// General Purpose Registers
    UINT64 X0;
    UINT64 X1;
    UINT64 X2;
    UINT64 X3;
    UINT64 X4;
    UINT64 X5;
    UINT64 X6;
    UINT64 X7;
    UINT64 X8;
    UINT64 X9;
    UINT64 X10;
    UINT64 X11;
    UINT64 X12;
    UINT64 X13;
    UINT64 X14;
    UINT64 X15;
    UINT64 X16;
    UINT64 X17;
    UINT64 X18;
    UINT64 X19;
    UINT64 X20;
    UINT64 X21;
    UINT64 X22;
    UINT64 X23;
    UINT64 X24;
    UINT64 X25;
    UINT64 X26;
    UINT64 X27;
    UINT64 X28;
    UINT64 FP; // x29 - Frame Pointer
    UINT64 LR; // x30 - Link Register
    UINT64 SP; // x31 - Stack Pointer
// FP/SIMD Registers
    UINT64 V0[2];
    UINT64 V1[2];
```

```

UINT64 V2[2];
UINT64 V3[2];
UINT64 V4[2];
UINT64 V5[2];
UINT64 V6[2];
UINT64 V7[2];
UINT64 V8[2];
UINT64 V9[2];
UINT64 V10[2];
UINT64 V11[2];
UINT64 V12[2];
UINT64 V13[2];
UINT64 V14[2];
UINT64 V15[2];
UINT64 V16[2];
UINT64 V17[2];
UINT64 V18[2];
UINT64 V19[2];
UINT64 V20[2];
UINT64 V21[2];
UINT64 V22[2];
UINT64 V23[2];
UINT64 V24[2];
UINT64 V25[2];
UINT64 V26[2];
UINT64 V27[2];
UINT64 V28[2];
UINT64 V29[2];
UINT64 V30[2];
UINT64 V31[2];
UINT64 ELR; // Exception Link Register
UINT64 SPSR; // Saved Processor Status Register
UINT64 FPSR; // Floating Point Status Register
UINT64 ESR; // Exception syndrome register
UINT64 FAR; // Fault Address Register
} EFI_SYSTEM_CONTEXT_AARCH64;

```

## Description

The **RegisterPeriodicCallback()** function registers and enables the on-target debug agent's periodic entry point. To unregister and disable calling the debug agent's periodic entry point, call **RegisterPeriodicCallback()** passing a **NULL** *PeriodicCallback* parameter.

The implementation must handle saving and restoring the processor context to/from the system context record around calls to the registered callback function.

If the interrupt is also used by the firmware for the EFI time base or some other use, two rules must be observed. First, the registered callback function must be called before any EFI processing takes place. Second, the Debug Support implementation must perform

the necessary steps to pass control to the firmware's corresponding interrupt handler in a transparent manner.

There is no quality of service requirement or specification regarding the frequency of calls to the registered *PeriodicCallback* function. This allows the implementation to mitigate a potential adverse impact to EFI timer based services due to the latency induced by the context save/restore and the associated callback function.

It is the responsibility of the caller to insure all parameters are correct. There is no provision for parameter checking by **RegisterPeriodicCallback()**. The implementation behavior when an invalid parameter is passed is not defined by this specification.

## Status Codes Returned

EFI_SUCCESS	The function completed successfully.
EFI_ALREADY_STARTED	Non-NULL <i>PeriodicCallback</i> parameter when a callback function was previously registered.
EFI_OUT_OF_RESOURCES	System has insufficient memory resources to register new callback function.



## EFI\_DEBUG\_SUPPORT\_PROTOCOL.RegisterExceptionCallback()

### Summary

Registers a function to be called when a given processor exception occurs.

### Prototype

```
typedef
EFI_STATUS
(EFI_API *REGISTER_EXCEPTION_CALLBACK) (
  IN EFI_DEBUG_SUPPORT_PROTOCOL *This,
  IN UINTN ProcessorIndex,
  IN EFI_EXCEPTION_CALLBACK ExceptionCallback,
  IN EFI_EXCEPTION_TYPE ExceptionType
);
```

### Parameters

<i>This</i>	A pointer to the <a href="#">EFI_DEBUG_SUPPORT_PROTOCOL</a> instance. Type <a href="#">EFI_DEBUG_SUPPORT_PROTOCOL</a> is defined in <a href="#">Section 18.2</a> .
<i>ProcessorIndex</i>	Specifies which processor the callback function applies to.
<i>ExceptionCallback</i>	A pointer to a function of type <a href="#">EXCEPTION_CALLBACK</a> that is called when the processor exception specified by <i>ExceptionType</i> occurs. Passing <b>NULL</b> unregisters any previously registered function associated with <i>ExceptionType</i> .
<i>ExceptionType</i>	Specifies which processor exception to hook.

## Related Definitions

```

typedef
VOID (*EFI_EXCEPTION_CALLBACK) (
    IN EFI_EXCEPTION_TYPE ExceptionType,
    IN OUT EFI_SYSTEM_CONTEXT SystemContext
);

typedef INTN EFI_EXCEPTION_TYPE;

// EBC Exception types
#define EXCEPT_EBC_UNDEFINED          0
#define EXCEPT_EBC_DIVIDE_ERROR      1
#define EXCEPT_EBC_DEBUG             2
#define EXCEPT_EBC_BREAKPOINT        3
#define EXCEPT_EBC_OVERFLOW          4
#define EXCEPT_EBC_INVALID_OPCODE    5
#define EXCEPT_EBC_STACK_FAULT       6
#define EXCEPT_EBC_ALIGNMENT_CHECK   7
#define EXCEPT_EBC_INSTRUCTION_ENCODING 8
#define EXCEPT_EBC_BAD_BREAK         9
#define EXCEPT_EBC_SINGLE_STEP      10

// IA-32 Exception types
#define EXCEPT_IA32_DIVIDE_ERROR      0
#define EXCEPT_IA32_DEBUG             1
#define EXCEPT_IA32_NMI              2
#define EXCEPT_IA32_BREAKPOINT        3
#define EXCEPT_IA32_OVERFLOW          4
#define EXCEPT_IA32_BOUNDED           5
#define EXCEPT_IA32_INVALID_OPCODE    6
#define EXCEPT_IA32_DOUBLE_FAULT     8
#define EXCEPT_IA32_INVALID_TSS      10
#define EXCEPT_IA32_SEG_NOT_PRESENT   11
#define EXCEPT_IA32_STACK_FAULT      12
#define EXCEPT_IA32_GP_FAULT         13
#define EXCEPT_IA32_PAGE_FAULT       14
#define EXCEPT_IA32_FP_ERROR         16
#define EXCEPT_IA32_ALIGNMENT_CHECK   17
#define EXCEPT_IA32_MACHINE_CHECK    18
#define EXCEPT_IA32_SIMD             19

//
// X64 Exception types
//
#define EXCEPT_X64_DIVIDE_ERROR      0
#define EXCEPT_X64_DEBUG             1
#define EXCEPT_X64_NMI              2

```

```

#define EXCEPT_X64_BREAKPOINT      3
#define EXCEPT_X64_OVERFLOW        4
#define EXCEPT_X64_BOUND           5
#define EXCEPT_X64_INVALID_OPCODE  6
#define EXCEPT_X64_DOUBLE_FAULT    8
#define EXCEPT_X64_INVALID_TSS     10
#define EXCEPT_X64_SEG_NOT_PRESENT  11
#define EXCEPT_X64_STACK_FAULT     12
#define EXCEPT_X64_GP_FAULT        13
#define EXCEPT_X64_PAGE_FAULT      14
#define EXCEPT_X64_FP_ERROR        16
#define EXCEPT_X64_ALIGNMENT_CHECK  17
#define EXCEPT_X64_MACHINE_CHECK   18
#define EXCEPT_X64_SIMD            19

// Itanium Processor Family Exception types
#define EXCEPT_IPF_VHTP_TRANSLATION  0
#define EXCEPT_IPF_INSTRUCTION_TLB  1
#define EXCEPT_IPF_DATA_TLB         2
#define EXCEPT_IPF_ALT_INSTRUCTION_TLB 3
#define EXCEPT_IPF_ALT_DATA_TLB     4
#define EXCEPT_IPF_DATA_NESTED_TLB  5
#define EXCEPT_IPF_INSTRUCTION_KEY_MISSED 6
#define EXCEPT_IPF_DATA_KEY_MISSED  7
#define EXCEPT_IPF_DIRTY_BIT        8
#define EXCEPT_IPF_INSTRUCTION_ACCESS_BIT 9
#define EXCEPT_IPF_DATA_ACCESS_BIT  10
#define EXCEPT_IPF_BREAKPOINT       11
#define EXCEPT_IPF_EXTERNAL_INTERRUPT 12
// 13 - 19 reserved
#define EXCEPT_IPF_PAGE_NOT_PRESENT  20
#define EXCEPT_IPF_KEY_PERMISSION    21
#define EXCEPT_IPF_INSTRUCTION_ACCESS_RIGHTS 22
#define EXCEPT_IPF_DATA_ACCESS_RIGHTS 23
#define EXCEPT_IPF_GENERAL_EXCEPTION 24
#define EXCEPT_IPF_DISABLED_FP_REGISTER 25
#define EXCEPT_IPF_NAT_CONSUMPTION   26
#define EXCEPT_IPF_SPECULATION       27
// 28 reserved
#define EXCEPT_IPF_DEBUG              29
#define EXCEPT_IPF_UNALIGNED_REFERENCE 30
#define EXCEPT_IPF_UNSUPPORTED_DATA_REFERENCE 31
#define EXCEPT_IPF_FP_FAULT          32
#define EXCEPT_IPF_FP_TRAP           33
#define EXCEPT_IPF_LOWER_PRIVILEGE_TRANSFER_TRAP 34
#define EXCEPT_IPF_TAKEN_BRANCH      35

```

```
#define EXCEPT_IPF_SINGLE_STEP    36
// 37 - 44 reserved
#define EXCEPT_IPF_IA32_EXCEPTION  45
#define EXCEPT_IPF_IA32_INTERCEPT 46
#define EXCEPT_IPF_IA32_INTERRUPT  47
//
// ARM processor exception types
//
#define EXCEPT_ARM_RESET          0
#define EXCEPT_ARM_UNDEFINED_INSTRUCTION 1
#define EXCEPT_ARM_SOFTWARE_INTERRUPT 2
#define EXCEPT_ARM_PREFETCH_ABORT  3
#define EXCEPT_ARM_DATA_ABORT      4
#define EXCEPT_ARM_RESERVED        5
#define EXCEPT_ARM_IRQ              6
#define EXCEPT_ARM_FIQ              7

//
// For coding convenience, define the maximum valid ARM
// exception.
//
#define MAX_ARM_EXCEPTION EXCEPT_ARM_FIQ
///
/// AARCH64 processor exception types.
///
#define EXCEPT_AARCH64_SYNCHRONOUS_EXCEPTIONS 0
#define EXCEPT_AARCH64_IRQ 1
#define EXCEPT_AARCH64_FIQ 2
#define EXCEPT_AARCH64_SERROR 3
///
/// For coding convenience, define the maximum valid
/// AARCH64 exception.
///
#define MAX_AARCH64_EXCEPTION EXCEPT_AARCH64_SERROR
```

```

///
/// RISC-V processor exception types.
///
#define EXCEPT_RISCV_INST_MISALIGNED    0
#define EXCEPT_RISCV_INST_ACCESS_FAULT  1
#define EXCEPT_RISCV_ILLEGAL_INST      2
#define EXCEPT_RISCV_BREAKPOINT        3
#define EXCEPT_RISCV_LOAD_ADDRESS_MISALIGNED 4
#define EXCEPT_RISCV_LOAD_ACCESS_FAULT  5
#define EXCEPT_RISCV_STORE_AMO_ADDRESS_MISALIGNED 6
#define EXCEPT_RISCV_STORE_AMO_ACCESS_FAULT 7
#define EXCEPT_RISCV_ENV_CALL_FROM_UMODE 8
#define EXCEPT_RISCV_ENV_CALL_FROM_SMODE 9
#define EXCEPT_RISCV_ENV_CALL_FROM_HMODE 10
#define EXCEPT_RISCV_ENV_CALL_FROM_MMODE 11

///
/// RISC-V processor interrupt types.
///

#define EXCEPT_RISCV_USER_SOFTWARE_INT0
#define EXCEPT_RISCV_SUPERVISOR_SOFTWARE_INT1
#define EXCEPT_RISCV_HYPERSVISOR_SOFTWARE_INT2
#define EXCEPT_RISCV_MACHINE_SOFTWARE_INT3
#define EXCEPT_RISCV_USER_TIMER_INT4
#define EXCEPT_RISCV_SUPERVISOR_TIMER_INT5
#define EXCEPT_RISCV_HYPERSVISOR_TIMER_INT6
#define EXCEPT_RISCV_MACHINE_TIMER_INT7
#define EXCEPT_RISCV_USER_EXTERNAL_INT8
#define EXCEPT_RISCV_SUPERVISOR_EXTERNAL_INT9
#define EXCEPT_RISCV_HYPERSVISOR_EXTERNAL_INT10
#define EXCEPT_RISCV_MACHINE_EXTERNAL_INT11

```

## Description

The **RegisterExceptionCallback()** function registers and enables an exception callback function for the specified exception. The specified exception must be valid for the instruction set architecture. To unregister the callback function and stop servicing the exception, call **RegisterExceptionCallback()** passing a **NULL** *ExceptionCallback* parameter.

The implementation must handle saving and restoring the processor context to/from the system context record around calls to the registered callback function. No chaining of exception handlers is allowed.

It is the responsibility of the caller to insure all parameters are correct. There is no provision for parameter checking by **RegisterExceptionCallback()**. The implementation behavior when an invalid parameter is passed is not defined by this specification.

## Status Codes Returned

EFI_SUCCESS	The function completed successfully.
EFI_ALREADY_STARTED	Non- <b>NULL</b> <i>ExceptionCallback</i> parameter when a callback function was previously registered.
EFI_OUT_OF_RESOURCES	System has insufficient memory resources to register new callback function.

## EFI\_DEBUG\_SUPPORT\_PROTOCOL.InvalidateInstructionCache()

### Summary

Invalidates processor instruction cache for a memory range. Subsequent execution in this range causes a fresh memory fetch to retrieve code to be executed.

### Prototype

```
typedef
EFI_STATUS
(EFIAPI *EFI_INVALIDATE_INSTRUCTION_CACHE) (
  IN EFI_DEBUG_SUPPORT_PROTOCOL *This,
  IN UINTN      ProcessorIndex,
  IN VOID      *Start,
  IN UINT64    Length
);
```

### Parameters

<i>This</i>	A pointer to the <a href="#">EFI_DEBUG_SUPPORT_PROTOCOL</a> instance. Type <a href="#">EFI_DEBUG_SUPPORT_PROTOCOL</a> is defined in <a href="#">Section 18.2</a> .
<i>ProcessorIndex</i>	Specifies which processor's instruction cache is to be invalidated.
<i>Start</i>	Specifies the physical base of the memory range to be invalidated.
<i>Length</i>	Specifies the minimum number of bytes in the processor's instruction cache to invalidate.

### Description

Typical operation of a debugger may require modifying the code image that is under debug. This can occur for many reasons, but is typically done to insert/remove software break instructions. Some processor architectures do not have coherent instruction and data caches so modifications to the code image require that the instruction cache be explicitly invalidated in that memory region.

The **InvalidateInstructionCache()** function abstracts this operation from the debug agent and provides a general purpose capability to invalidate the processor's instruction cache.

It is the responsibility of the caller to insure all parameters are correct. There is no provision for parameter checking by [EFI\\_DEBUG\\_SUPPORT\\_PROTOCOL.RegisterExceptionCallback\(\)](#). The implementation behavior when an invalid parameter is passed is not defined by this specification.

## Status Codes Returned

EFI_SUCCESS	The function completed successfully.
-------------	--------------------------------------

## 18.3 EFI Debugport Protocol

This section defines the EFI Debugport protocol. This protocol is used by debug agent to communicate with the remote debug host.

### 18.3.1 EFI Debugport Overview

Historically, remote debugging has typically been done using a standard UART serial port to connect the host and target. This is obviously not possible in a legacy reduced system that does not have a UART. The Debugport protocol solves this problem by providing an abstraction that can support many different types of debugport hardware. The debug agent should use this abstraction to communicate with the host.

The interface is minimal with only reset, read, write, and poll abstractions. Since these functions are called in interrupt context, none of them may call any EFI services or other protocol interfaces.

Debugport selection and configuration is handled by setting defaults via an environment variable which contains a full device path to the debug port. This environment variable is used during the debugport driver's initialization to configure the debugport correctly. The variable contains a full device path to the debugport, with the last node (prior to the terminal node) being a debugport messaging node. See [Section 18.3.2](#) for details.

The driver must also produce an instance of the EFI Device Path protocol to indicate what hardware is being used for the debugport. This may be used by the OS to maintain the debugport across a call to [EFI\\_BOOT\\_SERVICES.ExitBootServices\(\)](#).

## EFI\_DEBUGPORT\_PROTOCOL

### Summary

This protocol provides the communication link between the debug agent and the remote host.

### GUID

```
#define EFI_DEBUGPORT_PROTOCOL_GUID \
  {0xEBA4E8D2,0x3858,0x41EC,\
   {0xA2,0x81,0x26,0x47,0xBA,0x96,0x60,0xD0}}
```



## Protocol Interface Structure

```
typedef struct {  
    EFI_DEBUGPORT_RESET    Reset;  
    EFI_DEBUGPORT_WRITE    Write;  
    EFI_DEBUGPORT_READ     Read;  
    EFI_DEBUGPORT_POLL     Poll;  
} EFI_DEBUGPORT_PROTOCOL;
```

## Parameters

<i>Reset</i>	Resets the debugport hardware.
<i>Write</i>	Send a buffer of characters to the debugport device.
<i>Read</i>	Receive a buffer of characters from the debugport device.
<i>Poll</i>	Determine if there is any data available to be read from the debugport device.

## Description

The Debugport protocol is used for byte stream communication with a debugport device. The debugport can be a standard UART Serial port, a USB-based character device, or potentially any character-based I/O device.

The attributes for all UART-style debugport device interfaces are defined in the DEBUGPORT variable (see [Section 18.3.2](#)).

## EFI\_DEBUGPORT\_PROTOCOL.Reset()

### Summary

Resets the debugport.

### Prototype

```
typedef
EFI_STATUS
(EFIAPI *EFI_DEBUGPORT_RESET) (
    IN EFI_DEBUGPORT_PROTOCOL  *This
);
```

### Parameters

*This*

A pointer to the [EFI\\_DEBUGPORT\\_PROTOCOL](#) instance. Type [EFI\\_DEBUGPORT\\_PROTOCOL](#) is defined in [Section 18.3](#).

### Description

The **Reset()** function resets the debugport device.

It is the responsibility of the caller to insure all parameters are valid. There is no provision for parameter checking by **Reset()**. The implementation behavior when an invalid parameter is passed is not defined by this specification.

### Status Codes Returned

EFI_SUCCESS	The debugport device was reset and is in usable state.
EFI_DEVICE_ERROR	The debugport device could not be reset and is unusable.

## EFI\_DEBUGPORT\_PROTOCOL.Write()

### Summary

Writes data to the debugport.

### Prototype

```
typedef
EFI_STATUS
(EFIAPI *EFI_DEBUGPORT_WRITE) (
    IN EFI_DEBUGPORT_PROTOCOL *This,
    IN UINT32 Timeout,
    IN OUT UINTN *BufferSize,
    IN VOID *Buffer
);
```

### Parameters

<i>This</i>	A pointer to the <a href="#">EFI_DEBUGPORT_PROTOCOL</a> instance. Type <a href="#">EFI_DEBUGPORT_PROTOCOL</a> is defined in <a href="#">Section 18.3</a> .
<i>Timeout</i>	The number of microseconds to wait before timing out a write operation.
<i>BufferSize</i>	On input, the requested number of bytes of data to write. On output, the number of bytes of data actually written.
<i>Buffer</i>	A pointer to a buffer containing the data to write.

### Description

The **Write()** function writes the specified number of bytes to a debugport device. If a timeout error occurs while data is being sent to the debugport, transmission of this buffer will terminate, and **EFI\_TIMEOUT** will be returned. In all cases the number of bytes actually written to the debugport device is returned in *BufferSize*.

It is the responsibility of the caller to insure all parameters are valid. There is no provision for parameter checking by **Write()**. The implementation behavior when an invalid parameter is passed is not defined by this specification.

### Status Codes Returned

EFI_SUCCESS	The data was written.
EFI_DEVICE_ERROR	The device reported an error.
EFI_TIMEOUT	The data write was stopped due to a timeout.

## EFI\_DEBUGPORT\_PROTOCOL.Read()

### Summary

Reads data from the debugport.

### Prototype

```
typedef
EFI_STATUS
(EFIAPI *EFI_DEBUGPORT_READ) (
    IN EFI_DEBUGPORT_PROTOCOL *This,
    IN UINT32 Timeout,
    IN OUT UINTN *BufferSize,
    OUT VOID *Buffer
);
```

### Parameters

<i>This</i>	A pointer to the <a href="#">EFI_DEBUGPORT_PROTOCOL</a> instance. Type <b>EFI_DEBUGPORT_PROTOCOL</b> is defined in <a href="#">Section 18.3</a> .
<i>Timeout</i>	The number of microseconds to wait before timing out a read operation.
<i>BufferSize</i>	A pointer to an integer which, on input contains the requested number of bytes of data to read, and on output contains the actual number of bytes of data read and returned in <i>Buffer</i> .
<i>Buffer</i>	A pointer to a buffer into which the data read will be saved.

### Description

The **Read()** function reads a specified number of bytes from a debugport. If a timeout error or an overrun error is detected while data is being read from the debugport, then no more characters will be read, and **EFI\_TIMEOUT** will be returned. In all cases the number of bytes actually read is returned in *\*BufferSize*.

It is the responsibility of the caller to insure all parameters are valid. There is no provision for parameter checking by **Read()**. The implementation behavior when an invalid parameter is passed is not defined by this specification.

### Status Codes Returned

EFI_SUCCESS	The data was read.
EFI_DEVICE_ERROR	The debugport device reported an error.
EFI_TIMEOUT	The operation was stopped due to a timeout or overrun.

## EFI\_DEBUGPORT\_PROTOCOL.Poll()

### Summary

Checks to see if any data is available to be read from the debugport device.

### Prototype

```
typedef
EFI_STATUS
(EFIAPI *EFI_DEBUGPORT_POLL) (
    IN EFI_DEBUGPORT_PROTOCOL  *This
);
```

### Parameters

*This*

A pointer to the [EFI\\_DEBUGPORT\\_PROTOCOL](#) instance. Type [EFI\\_DEBUGPORT\\_PROTOCOL](#) is defined in [Section 18.3](#).

### Description

The **Poll()** function checks if there is any data available to be read from the debugport device and returns the result. No data is actually removed from the input stream. This function enables simpler debugger design since buffering of reads is not necessary by the caller.

### Status Codes Returned

EFI_SUCCESS	At least one byte of data is available to be read.
EFI_NOT_READY	No data is available to be read.
EFI_DEVICE_ERROR	The debugport device is not functioning correctly.

## 18.3.2 Debugport Device Path

The debugport driver must establish and maintain an instance of the EFI Device Path protocol for the debugport. A graceful handoff of debugport ownership between the EFI Debugport driver and an OS debugport driver requires that the OS debugport driver can determine the type, location, and configuration of the debugport device.

The Debugport Device Path is a vendor-defined messaging device path with no data, only a GUID. It is used at the end of a conventional device path to tag the device for use as the debugport. For example, a typical UART debugport would have the following fully qualified device path:

**PciRoot(0)/Pci(0x1f,0)/ACPI(PNP0501,0)/UART(115200,N,8,1)/DebugPort()**

The Vendor\_GUID that defines the debugport device path is the same as the debugport protocol GUID, as defined below.

```
#define DEVICE_PATH_MESSAGING_DEBUGPORT \
    EFI_DEBUGPORT_PROTOCOL_GUID
```

[Table 141](#) shows all fields of the debugport device path.

**Table 141. Debugport Messaging Device Path**

Mnemonic	Byte Offset	Byte Length	Description
Type	0	1	Type 3 – Messaging Device Path.
Sub Type	1	1	Sub Type 10 – Vendor.
Length	2	2	Length of this structure in bytes. Length is 20 bytes.
Vendor_GUID	4	16	<b>DEVICE_PATH_MESSAGING_DEBUGPORT.</b>

### 18.3.3 EFI Debugport Variable

Even though there may be more than one hardware device that could function as a debugport in a system, only one debugport may be active at a time. The DEBUGPORT variable is used to declare which hardware device will act as the debugport, and what communication parameters it should assume.

Like all EFI variables, the DEBUGPORT variable has both a name and a GUID. The name is "DEBUGPORT." The GUID is the same as the **EFI\_DEBUGPORT\_PROTOCOL\_GUID**:

```
#define EFI_DEBUGPORT_VARIABLE_NAME L"DEBUGPORT"
#define EFI_DEBUGPORT_VARIABLE_GUID EFI_DEBUGPORT_PROTOCOL_GUID
```

The data contained by the DEBUGPORT variable is a fully qualified debugport device path (see [Section 18.3.2](#)).

The desired communication parameters for the debugport are declared in the DEBUGPORT variable. The debugport driver must read this variable during initialization to determine how to configure the debug port.

To reduce the required complexity of the debugport driver, the debugport driver is not required to support all possible combinations of communication parameters. What combinations of parameters are possible is implementation specific.

Additionally debugport drivers implemented for PNP0501 devices, that is debugport devices with a PNP0501 ACPI node in the device path, must support the following defaults. These defaults must be used in the absence of a DEBUGPORT variable, or when the communication parameters specified in the DEBUGPORT variable are not supported by the driver.

- Baud : 115200
- 8 data bits
- No parity
- 1 stop bit
- No flow control (See Appendix A for flow control details)

In the absence of the DEBUGPORT variable, the selection of which port to use as the debug port is implementation specific.

Future revisions of this specification may define new defaults for other debugport types.

The debugport device path must be constructed to reflect the actual settings for the debugport. Any code needing to know the state of the debug port must reference the

device path rather than the `DEBUGPORT` variable, since the debugport may have assumed a default setting in spite of the existence of the `DEBUGPORT` variable.

If it is not possible to configure the debug port using either the settings declared in the `DEBUGPORT` variable or the default settings for the particular debugport type, the driver initialization must not install any protocol interfaces and must exit with an error.

## 18.4 EFI Debug Support Table

This chapter defines the EFI Debug Support Table which is used by the debug agent or an external debugger to determine loaded image information in a quiescent manner.

### 18.4.1 Overview

Every executable image loaded in EFI is represented by an EFI handle populated with an instance of the [EFI\\_LOADED\\_IMAGE\\_PROTOCOL](#) protocol. This handle is known as an “image handle.” The associated Loaded Image protocol provides image information that is of interest to a source level debugger. Normal EFI executables can access this information by using EFI services to locate all instances of the Loaded Image protocol.

A debugger has two problems with this scenario. First, if it is an external hardware debugger, the location of the EFI system table is not known. Second, even if the location of the EFI system table is known, the services contained therein are generally unavailable to a debugger either because it is an on-target debugger that is running in interrupt context, or in the case of an external hardware debugger there is no debugger code running on the target at all.

Since a source level debugger must be capable of determining image information for all loaded images, an alternate mechanism that does not use EFI services must be provided. Two features are added to the EFI system software to enable this capability.

First, an alternate mechanism of locating the EFI system table is required. A check-summed structure containing the physical address of the EFI system table is created and located on a 4M aligned memory address. A hardware debugger can search memory for this structure to determine the location of the EFI system table.

Second, an **EFI\_CONFIGURATION\_TABLE** is published that leads to a database of pointers to all instances of the Loaded Image protocol. Several layers of indirection are used to allow dynamically managing the data as images are loaded and unloaded. Once the address of the EFI system table is known, it is possible to discover a complete and accurate list of EFI images. (Note that the EFI core itself must be represented by an instance of the Loaded Image protocol.)

[Figure 61](#) illustrates the table indirection and pointer usage.

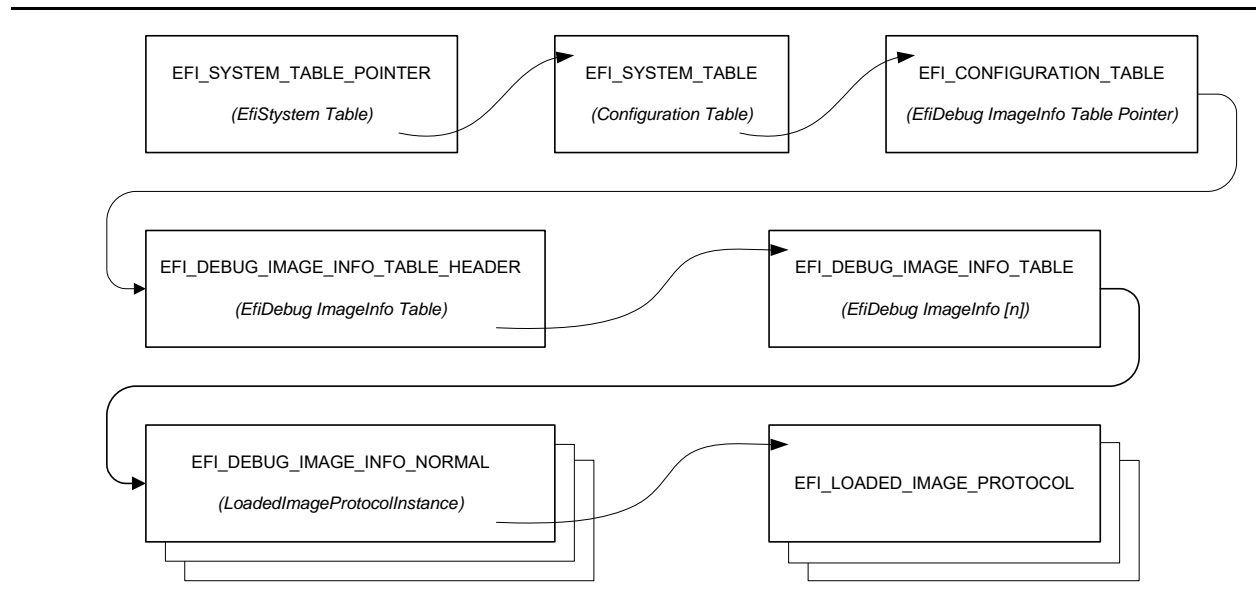

Figure 61. Debug Support Table Indirection and Pointer Usage

### 18.4.2 EFI System Table Location

The EFI system table can be located by an off-target hardware debugger by searching for the **EFI\_SYSTEM\_TABLE\_POINTER** structure. The **EFI\_SYSTEM\_TABLE\_POINTER** structure is located on a 4M boundary as close to the top of physical memory as feasible. It may be found searching for **the EFI\_SYSTEM\_TABLE\_SIGNATURE** on each 4M boundary starting at the top of memory and scanning down. When the signature is found, the entire structure must be verified using the *Crc32* field. The 32-bit CRC of the entire structure is calculated assuming the *Crc32* field is zero. This value is then written to the *Crc32* field.

```
typedef struct _EFI_SYSTEM_TABLE_POINTER {
    UINT64    Signature;
    EFI_PHYSICAL_ADDRESS EfiSystemTableBase;
    UINT32    Crc32;
} EFI_SYSTEM_TABLE_POINTER;
```

- Signature*                      A constant **UINT64** that has the value **EFI\_SYSTEM\_TABLE\_SIGNATURE** (see the EFI 1.0 specification).
- EfiSystemTableBase*            The physical address of the EFI system table.
- Crc32*                            A 32-bit CRC value that is used to verify the **EFI\_SYSTEM\_TABLE\_POINTER** structure is valid.

### 18.4.3 EFI Image Info

The **EFI\_DEBUG\_IMAGE\_INFO\_TABLE** is an array of pointers to **EFI\_DEBUG\_IMAGE\_INFO** unions. Each member of an **EFI\_DEBUG\_IMAGE\_INFO** union is



a pointer to a data structure representing a particular image type. For each image that has been loaded, there is an appropriate image data structure with a pointer to it stored in the **EFI\_DEBUG\_IMAGE\_INFO\_TABLE**. Data structures for normal images and SMM images are defined. All other image types are reserved for future use.

The process of locating the **EFI\_DEBUG\_IMAGE\_INFO\_TABLE** begins with an EFI configuration table.

```
//
// EFI_DEBUG_IMAGE_INFO_TABLE configuration table
// GUID declaration - {49152E77-1ADA-4764-B7A2-7AFEFED95E8B}
//
#define EFI_DEBUG_IMAGE_INFO_TABLE_GUID \
{0x49152E77,0x1ADA,0x4764,\
{0xB7,0xA2,0x7A,0xFE,0xFE,0xD9,0x5E,0x8B}}
```

The configuration table leads to an **EFI\_DEBUG\_IMAGE\_INFO\_TABLE\_HEADER** structure that contains a pointer to the **EFI\_DEBUG\_IMAGE\_INFO\_TABLE** and some status bits that are used to control access to the **EFI\_DEBUG\_IMAGE\_INFO\_TABLE** when it is being updated.

```
//
// UpdateStatus bits
//
#define EFI_DEBUG_IMAGE_INFO_UPDATE_IN_PROGRESS 0x01
#define EFI_DEBUG_IMAGE_INFO_TABLE_MODIFIED 0x02
```

```
typedef struct {
volatile UINT32  UpdateStatus;
UINT32         TableSize;
EFI_DEBUG_IMAGE_INFO *EfiDebugImageInfoTable;
} EFI_DEBUG_IMAGE_INFO_TABLE_HEADER;
```

#### *UpdateStatus*

*UpdateStatus* is used by the system to indicate the state of the debug image info table.

The **EFI\_DEBUG\_IMAGE\_INFO\_UPDATE\_IN\_PROGRESS** bit must be set when the table is being modified. Software consuming the table must qualify the access to the table with this bit.

The **EFI\_DEBUG\_IMAGE\_INFO\_TABLE\_MODIFIED** bit is always set by software that modifies the table. It may be cleared by software that consumes the table once the entire table has been read. It is essentially a sticky version of the

**EFI\_DEBUG\_IMAGE\_INFO\_UPDATE\_IN\_PROGRESS** bit and is intended to provide an efficient mechanism to minimize the number of times the table must be scanned by the consumer.

#### *TableSize*

The number of **EFI\_DEBUG\_IMAGE\_INFO** elements in the array pointed to by *EfiDebugImageInfoTable*.

*EfiDebugImageInfoTable*

A pointer to the first element of an array of **EFI\_DEBUG\_IMAGE\_INFO** structures.

```
#define EFI_DEBUG_IMAGE_INFO_TYPE_NORMAL 0x01
```

```
typedef union {
    UINT32      *ImageInfoType;
    EFI_DEBUG_IMAGE_INFO_NORMAL *NormalImage;
} EFI_DEBUG_IMAGE_INFO;
```

```
typedef struct {
    UINT32      ImageInfoType;
    EFI_LOADED_IMAGE_PROTOCOL *LoadedImageProtocolInstance;
    EFI_HANDLE  ImageHandle;
} EFI_DEBUG_IMAGE_INFO_NORMAL;
```

*ImageInfoType* Indicates the type of image info structure. For PE32 EFI images, this is set to **EFI\_DEBUG\_IMAGE\_INFO\_TYPE\_NORMAL**.

*LoadedImageProtocolInstance* A pointer to an instance of the loaded image protocol for the associated image.

*ImageHandle* Indicates the image handle of the associated image.

# 19 Protocols — Compression Algorithm Specification

---

In EFI firmware storage, binary codes/data are often compressed to save storage space. These compressed codes/data are extracted into memory for execution at boot time. This demands an efficient lossless compression/decompression algorithm. The compressor must produce small compressed images, and the decompressor must operate fast enough to avoid delays at boot time.

This chapter describes in detail the UEFI compression/decompression algorithm, as well as the EFI Decompress Protocol. The EFI Decompress Protocol provides a standard decompression interface for use at boot time.

## 19.1 Algorithm Overview

In this chapter the term “**character**” denotes a single byte and the term “**string**” denotes a series of concatenated characters.

The compression/decompression algorithm used in EFI firmware storage is a combination of the LZ77 algorithm and Huffman Coding. The LZ77 algorithm replaces a repeated string with a pointer to the previous occurrence of the string. Huffman Coding encodes symbols in a way that the more frequently a symbol appears in a text, the shorter the code that is assigned to it.

The compression process contains two steps:

- The first step is to find repeated strings (using LZ77 algorithm) and produce intermediate data.

Beginning with the first character, the compressor scans the source data and determines if the characters starting at the current position can form a string previously appearing in the text. If a long enough matching string is found, the compressor will output a pointer to the string. If the pointer occupies more space than the string itself, the compressor will output the original character at the current position in the source data. Then the compressor advances to the next position and repeats the process. To speed up the compression process, the compressor dynamically maintains a **String Info Log** to record the positions and lengths of strings encountered, so that string comparisons are performed quickly by looking up the String Info Log.

Because a compressor cannot have unlimited resources, as the compression continues the compressor removes “old” string information. This prevents the String Info Log from becoming too large. As a result, the algorithm can only look up repeated strings within the range of a fixed-sized “sliding window” behind the current position.

In this way, a stream of intermediate data is produced which contains two types of symbols: the **Original Characters** (to be preserved in the decompressed data), and the **Pointers** (representing a previous string). A Pointer consists of two elements: the **String Position** and the **String Length**, representing the location and the length of the target string, respectively.

- To improve the compression ratio further, Huffman Coding is utilized as the second step.

The intermediate data (consisting of original characters and pointers) is divided into **Blocks** so that the compressor can perform Huffman Coding on a Block immediately after it is generated; eliminating the need for a second pass from the beginning after the intermediate data has been generated. Also, since symbol frequency distribution may differ in different parts of the intermediate data, Huffman Coding can be optimized for each specific Block. The compressor determines Block Size for each Block according to the specifications defined in [Section 19.2](#).

In each Block, two symbol sets are defined for Huffman Coding. The **Char&Len Set** consists of the Original Characters plus the String Lengths and the **Position Set** consists of String Positions (Note that the two elements of a Pointer belong to separate symbol sets). The Huffman Coding schemes applied on these two symbol sets are independent.

The algorithm uses “canonical” Huffman Coding so a Huffman tree can be represented as an array of code lengths in the order of the symbols in the symbol set. This code length array represents the Huffman Coding scheme for the symbol set. Both the Char&Len Set code length array and the Position Set code length array appear in the Block Header.

Huffman coding is used on the code length array of the Char&Len Set to define a third symbol set. The **Extra Set** is defined based on the code length values in the Char&Len Set code length array. The code length array for the Huffman Coding of Extra Set also appears in the Block Header together with the other two code length arrays. For exact format of the Block Header, see [Section 19.2.3.1](#).

The decompression process is straightforward given that the compression process is known. The decompressor scans the compressed data and decodes the symbols one by one, according to the Huffman code mapping tables generated from code length arrays. Along the process, if it encounters an original character, it outputs it; if it encounters a pointer, it looks it up in the already decompressed data and outputs the associated string.

## 19.2 Data Format

This section describes in detail the format of the compressed data produced by the compressor. The compressed data serves as input to the decompressor and can be fully extracted to the original source data.

### 19.2.1 Bit Order

In computer data representation, a byte is the minimum unit and there is no differentiation in the order of bits within a byte. However, the compressed data is a sequence of bits rather than a sequence of bytes and as a result the order of bits in a byte needs to be defined. In a compressed data stream, the higher bits are defined to precede the lower bits in a byte. [Figure 62](#) illustrates a compressed data sequence written as bytes from left to right. For each byte, the bits are written in an order with bit 7 (the highest bit)

at the left and bit 0 (the lowest bit) at the right. Concatenating the bytes from left to right forms a bit sequence.

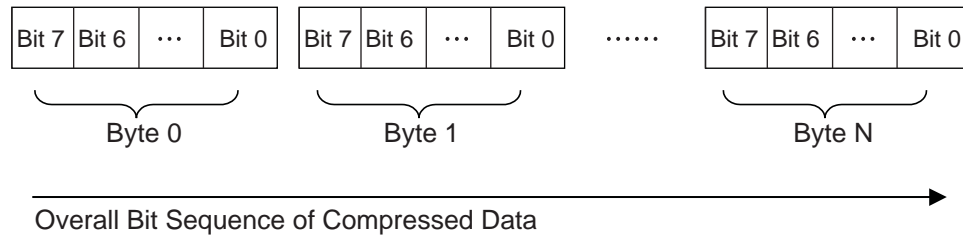

OM13173

Figure 62. Bit Sequence of Compressed Data

The bits of the compressed data are actually formed by a sequence of data units. These data units have variable bit lengths. The bits of each data unit are arranged so that the higher bit of the data unit precedes the lower bit of the data unit.

### 19.2.2 Overall Structure

The compressed data begins with two 32-bit numerical fields: the compressed size and the original size. The compressed data following these two fields is composed of one or more Blocks. Each Block is a unit for Huffman Coding with a coding scheme independent of the other Blocks. Each Block is composed of a Block Header containing the Huffman code trees for this Block and a Block Body with the data encoded using the coding scheme defined by the Huffman trees. The compressed data is terminated by an additional byte of zero.

The overall structure of the compressed data is shown in [Figure 63](#).

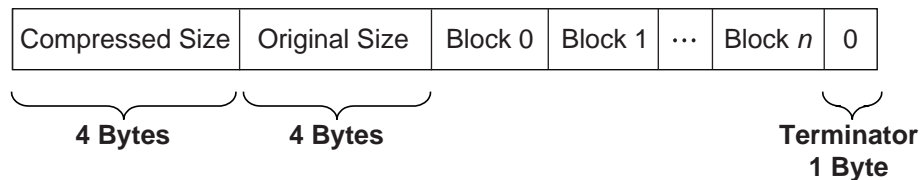

OM13174

Figure 63. Compressed Data Structure

Note the following:

- Blocks are of variable lengths.
- Block lengths are counted by bits and not necessarily divisible by 8. Blocks are tightly packed (there are no padding bits between blocks). Neither the starting position nor ending position of a Block is necessarily at a byte boundary. However, if the last Block is not terminated at a byte boundary, there should be some bits of 0 to fill up the remaining bits of the last byte of the block, before the terminator byte of 0.

- Compressed Size = Size in bytes of (Block 0 + Block 1 + ... + Block N + Filling Bits (if any) + Terminator).
- Original Size is the size in bytes of original data.
- Both Compressed Size and Original Size are “little endian” (starting from the least significant byte).

### 19.2.3 Block Structure

A Block is composed of a Block Header and a Block Body, as shown in [Figure 64](#). These two parts are packed tightly (there are no padding bits between them). The lengths in bits of Block Header and Block Body are not necessarily divisible by eight.

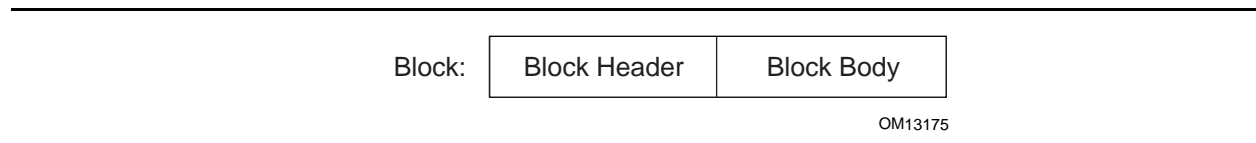

Figure 64. Block Structure

#### 19.2.3.1 Block Header

The Block Header contains the Huffman encoding information for this block. Since “canonical” Huffman Coding is being used, a Huffman tree is represented as an array of code lengths in increasing order of the symbols in the symbol set. Code lengths are limited to be less than or equal to 16 bits. This requires some extra handling of Huffman codes in the compressor, which is described in [Section 19.3](#).

There are three code length arrays for three different symbol sets in the Block Header: one for the Extra Set, one for the Char&Len Set, and one for the Position Set.

The Block Header is composed of the tightly packed (no padding bits) fields described in [Table 142](#).

Table 142. Block Header Fields

Field Name	Length (bits)	Description
Block Size	16	The size of this Block. Block Size is defined as the number of original characters plus the number of pointers that appear in the Block Body: Block Size = Number of Original Characters in the Block Body + Number of Pointers in the Block Body.
Extra Set Code Length Array Size	5	The number of code lengths in the Extra Set Code Length Array. The Extra Set Code Length Array contains code lengths of the Extra Set in increasing order of the symbols, and if all symbols greater than a certain symbol have zero code length, the Extra Set Code Length Array terminates at the last nonzero code length symbol. Since there are 19 symbols in the Extra Set (see the description of the Char&Len Set Code Length Array), the maximum Extra Set Code Length Array Size is 19.
Extra Set Code Length Array	Variable	If Extra Set Code Length Array Size is 0, then this field is a 5-bit value that represents the only Huffman code used. If Extra Set Code Length Array Size is not 0, then this field is an encoded form of a concatenation of code lengths in increasing order of the symbols. The concatenation of Code lengths are encoded as follows: If a code length is less than 7, then it is encoded as a 3-bit value; If a code length is equal to or greater than 7, then it is encoded as a series of "1"s followed by a terminating "0." The number of "1"s = Code length - 4. For example, code length "ten" is encoded as "1111110"; code length "seven" is encoded as "11110." After the third length of the code length concatenation, a 2-bit value is used to indicate the number of consecutive zero lengths immediately after the third length. (Note this 2-bit value only appears once after the third length, and does NOT appear multiple times after every 3 <sup>rd</sup> length.) This 2-bit value ranges from 0 to 3. For example, if the 2-bit value is "00," then it means there are no zero lengths at the point, and following encoding starts from the fourth code length; if the 2-bit value is "10" then it means the fourth and fifth length are zero and following encoding starts from the sixth code length.
Position Set Code Length Array Size	4	The number of code lengths in the Position Set Code Length Array. The Position Set Code Length Array contains code lengths of Position Set in increasing order of the symbols in the Position Set, and if all symbols greater than a certain symbol have zero code length, the Position Set Code Length Array terminates at the last nonzero code length symbol. Since there are 14 symbols in the Position Set (see 3.3.2), the maximum Position Set Code Length Array Size is 14.

Field Name	Length (bits)	Description
Char&Len Set Code Length Array	Variable	<p>If Char&amp;Len Set Code Length Array Size is 0, then this field is a 9-bit value that represents the only Huffman code used.</p> <p>If Char&amp;Len Set Code Length Array Size is not 0, then this field is an encoded form of a concatenation of code lengths in increasing order of the symbols.</p> <p>The concatenation of Code lengths are two-step encoded:</p> <p>Step 1:                      If a code length is not zero, then it is encoded as "code length + 2";                      If a code length is zero, then the number of consecutive zero lengths starting from this code length is counted -- If the count is equal to or less than 2, then the code "0" is used for each zero length; if the count is greater than 2 and less than 19, then the code "1" followed by a 4-bit value of "count - 3" is used for these consecutive zero lengths; if the count is equal to 19, then it is treated as "1 + 18," and a code "0" and a code "1" followed by a 4-bit value of "15" are used for these consecutive zero lengths; if the count is greater than 19, then the code "2" followed by a 9-bit value of "count - 20" is used for these consecutive zero lengths.</p> <p>Step 2:                      The second step encoding is a Huffman encoding of the codes produced by first step. (While encoding codes "1" and "2," their appended values are not encoded and preserved in the resulting text).                      The code lengths of generated Huffman tree are just the contents of the Extra Set Code Length Array.</p>
Position Set Code Length Array Size	4	<p>The number of code lengths in the Position Set Code Length Array. The Position Set Code Length Array contains code lengths of Position Set in increasing order of the symbols in the Position Set, and if all symbols greater than a certain symbol have zero code length, the Position Set Code Length Array terminates at the last nonzero code length symbol. Since there are 14 symbols in the Position Set (see 3.3.2), the maximum Position Set Code Length Array Size is 14.</p>
Position Set Code Length Array	Variable	<p>If Position Set Code Length Array Size is 0, then this field is a 5-bit value that represents the only Huffman code used.</p> <p>If Position Set Code Length Array Size is not 0, then this field is an encoded form of a concatenation of code lengths in increasing order of the symbols.</p> <p>The concatenation of Code lengths are encoded as follows:                      If a code length is less than 7, then it is encoded as a normal 3-bit value;                      If a code length is equal to or greater than 7, then it is encoded as a series of "1"s followed by a terminating "0." The number of "1"s = Code length - 4. For example, code length "10" is encoded as "1111110"; code length "7" is encoded as "1110."</p>

### 19.2.3.2 Block Body

The Block Body is simply a mixture of Original Characters and Pointers, while each Pointer has two elements: String Length preceding String Position. All these data units are tightly packed together.



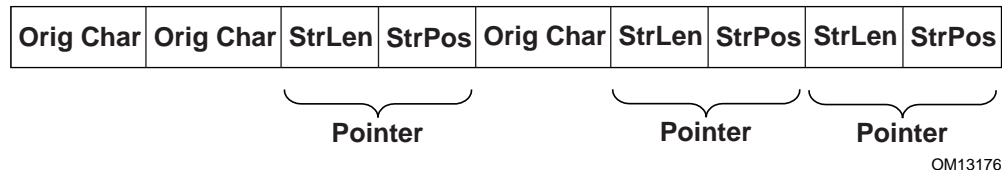

**Figure 65. Block Body**

The Original Characters, String Lengths and String Positions are all Huffman coded using the Huffman trees presented in the Block Header, with some additional variations. The exact format is described below:

An Original Character is a byte in the source data. A String Length is a value that is greater than 3 and less than 257 (this range should be ensured by the compressor). By calculating “(String Length – 3) | 0x100,” a value set is obtained that ranges from 256 to 509. By combining this value set with the value set of Original Characters (0 ~ 255), the Char&Len Set (ranging from 0 to 509) is generated for Huffman Coding.

A String Position is a value that indicates the distance between the current position and the target string. The String Position value is defined as “Current Position – Starting Position of the target string - 1.” The String Position value ranges from 0 to 8190 (so 8192 is the “sliding window” size, and this range should be ensured by the compressor). The lengths of the String Position values (in binary form) form a value set ranging from 0 to 13 (it is assumed that value 0 has length of 0). This value set is the Position Set for Huffman Coding. The full representation of a String Position value is composed of two consecutive parts: one is the Huffman code for the value length; the other is the actual String Position value of “length - 1” bits (excluding the highest bit since the highest bit is always “1”). For example, String Position value 18 is represented as: Huffman code for “5” followed by “0010.” If the value length is 0 or 1, then no value is appended to the Huffman code. This kind of representation favors small String Position values, which is a hint for compressor design.

## 19.3 Compressor Design

The compressor takes the source data as input and produces a compressed image. This section describes the design used in one possible implementation of a compressor that follows the UEFI Compression Algorithm. The source code that illustrates an implementation of this specific design is listed in Appendix H.

### 19.3.1 Overall Process

The compressor scans the source data from the beginning, character by character. As the scanning proceeds, the compressor generates Original Characters or Pointers and outputs the compressed data packed in a series of Blocks representing individual Huffman coding units.

The compressor maintains a String Info Log containing data that facilitates string comparison. Old data items are deleted and new data items are inserted regularly.

The compressor does not output a Pointer immediately after it sees a matching string for the current position. Instead, it delays its decision until it gets the matching string for the next position. The compressor has two criteria at hand: one is that the former match length should be no shorter than three characters; the other is that the former match length should be no shorter than the latter match length. Only when these two criteria are met does the compressor output a Pointer to the former matching string.

The overall process of compression can be described by following pseudo code:

```

Set the Current Position at the beginning of the source data;
Delete the outdated string info from the String Info Log;
Search the String Info Log for matching string;
Add the string info of the current position into the String Info Log;
WHILE not end of source data DO
  Remember the last match;
  Advance the Current Position by 1;
  Delete the outdated String Info from the String Info Log;
  Search the String Info Log for matching string;
  Add the string info of the Current Position into the String Info Log;
  IF the last match is shorter than 3 characters or this match is longer than
  the last match THEN
    Call Output()* to output the character at the previous position as an
    Original Character;
  ELSE
    Call Output()* to output a Pointer to the last matching string;
  WHILE (--last match length) > 0 DO
    Advance the Current Position by 1;
    Delete the outdated piece of string info from the String Info Log;
    Add the string info of the current position into the String Info Log;
  ENDWHILE
ENDIF
ENDWHILE

```

The *Output()* is the function that is responsible for generating Huffman codes and Blocks. It accepts an Original Character or a Pointer as input and maintains a Block Buffer to temporarily store data units that are to be Huffman coded. The following pseudo code describes the function:

```

FUNCTION NAME: Output
INPUT: an Original Character or a Pointer

Put the Original Character or the Pointer into the Block Buffer;
Advance the Block Buffer position pointer by 1;
IF the Block Buffer is full THEN
  Encode the Char&Len Set in the Block buffer;
  Encode the Position Set in the Block buffer;
  Encode the Extra Set;
  Output the Block Header containing the code length arrays;
  Output the Block Body containing the Huffman encoded Original Characters and
  Pointers;
  Reset the Block Buffer position pointer to point to the beginning of the
  Block buffer;
ENDIF

```

### 19.3.2 String Info Log

The provision of the String Info Log is to speed up the process of finding matching strings. The design of this has significant impact on the overall performance of the

compressor. This section describes in detail how String Info Log is implemented and the typical operations on it.

### 19.3.2.1 Data Structures

The String Info Log is implemented as a set of search trees. These search trees are dynamically updated as the compression proceeds through the source data. The structure of a typical search tree is depicted in [Figure 66](#).

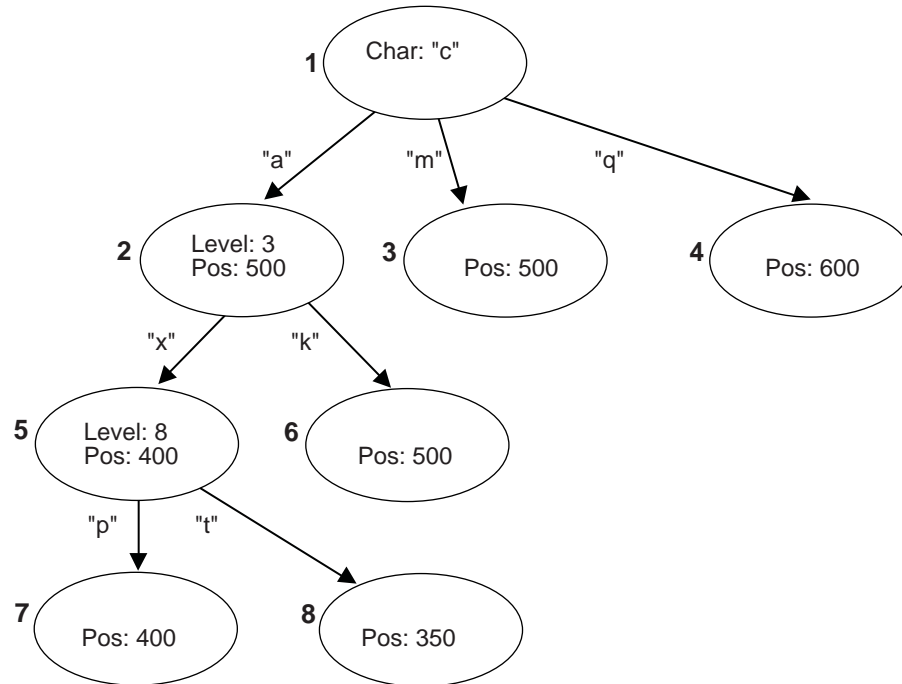

OM13177

**Figure 66. String Info Log Search Tree**

There are three types of nodes in a search tree: the root node, internal nodes, and leaves. The root node has a “character” attribute, which represents the starting character of a string. Each edge also has a “character” attribute, which represents the next character in the string. Each internal node has a “level” attribute, which indicates the character on any edge that leads to its child nodes is the “level + 1”th character in the string. Each internal node or leaf has a “position” attribute that indicates the string’s starting position in the source data.

To speed up the tree searching, a hash function is used. Given the parent node and the edge-character, the hash function will quickly find the expected child node.

### 19.3.2.2 Searching the Tree

Traversing the search tree is performed as follows:

The following example uses the search tree shown in [Figure 66](#) above. Assume that the current position in the source data contains the string “camxrsxpj...”

1. The starting character “c” is used to find the root of the tree. The next character “a” is used to follow the edge from node 1 to node 2. The “position” of node 2 is 500, so a string starting with “ca” can be found at position 500. The string at the current position is compared with the string starting at position 500.
2. Node 2 is at Level 3; so at most three characters are compared. Assume that the three-character comparison passes.
3. The fourth character “x” is used to follow the edge from Node 2 to Node 5. The position value of node 5 is 400, which means there is a string located in position 400 that starts with “cam” and the character at position 403 is an “x.”
4. Node 5 is at Level 8, so the fifth to eighth characters of the source data are compared with the string starting at position 404. Assume the strings match.
5. At this point, the ninth character “p” has been reached. It is used to follow the edge from Node 5 to Node 7.
6. This process continues until a mismatch occurs, or the length of the matching strings exceeds the predefined MAX\_MATCH\_LENGTH. The most recent matching string (which is also the longest) is the desired matching string.

### 19.3.2.3 Adding String Info

String info needs to be added to the String Info Log for each position in the source data. Each time a search for a matching string is performed, the new string info is inserted for the current position. There are several cases that can be discussed:

1. No root is found for the first character. A new tree is created with the root node labeled with the starting character and a child leaf node with its edge to the root node labeled with the second character in the string. The “position” value of the child node is set to the current position.
2. One root node matches the first character, but the second character does not match any edge extending from the root node. A new child leaf node is created with its edge labeled with the second character. The “position” value of the new leaf child node is set to the current position.
3. A string comparison succeeds with an internal node, but a matching edge for the next character does not exist. This is similar to (2) above. A new child leaf node is created with its edge labeled with the character that does not exist. The “position” value of the new leaf child node is set to the current position.
4. A string comparison exceeds MAX\_MATCH\_LENGTH. Note: This only happens with leaf nodes. For this case, the “position” value in the leaf node is updated with the current position.
5. If a string comparison with an internal node or leaf node fails (mismatch occurs before the “Level + 1”th character is reached or MAX\_MATCH\_LENGTH is exceeded), then a “split” operation is performed as follows:

Suppose a comparison is being performed with a level 9 Node, at position 350, and the current position is 1005. If the sixth character at position 350 is an “x” and the sixth character at position 1005 is a “y,” then a mismatch will occur. In this case, a new internal node and a new child node are inserted into the tree, as depicted in [Figure 67](#).

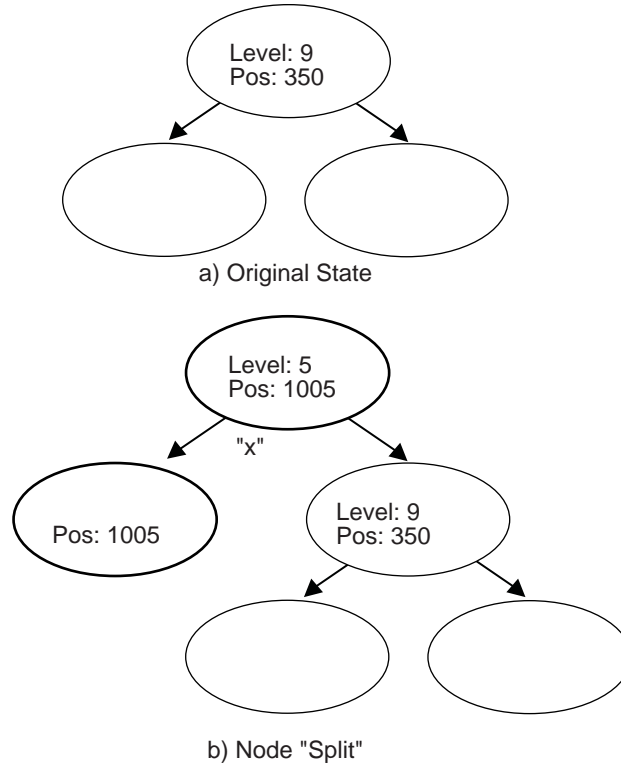

OM13178

Figure 67. Node Split

The b) portion of [Figure 67](#) has two new inserted nodes, which reflects the new string information that was found at the current position. The process splits the old node into two child nodes, and that is why this operation is called a "split."

#### 19.3.2.4 Deleting String Info

The String Info Log will grow as more and more string information is logged. The size of the String Info Log must be limited, so outdated information must be removed on a regular basis. A sliding window is maintained behind the current position, and the searches are always limited within the range of the sliding window. Each time the current position is advanced, outdated string information that falls outside the sliding window should be removed from the tree. The search for outdated string information is simplified by always updating the nodes' "position" attribute when searching for matching strings.

### 19.3.3 Huffman Code Generation

Another major component of the compressor design is generation of the Huffman Code. Huffman Coding is applied to the Char&Len Set, the Position Set, and the Extra Set. The Huffman Coding used here has the following features:

- The Huffman tree is represented as an array of code lengths ("canonical" Huffman Coding);

- The maximum code length is limited to 16 bits.

The Huffman code generation process can be divided into three steps. These are the generation of Huffman tree, the adjustment of code lengths, and the code generation.

### 19.3.3.1 Huffman Tree Generation

This process generates a typical Huffman tree. First, the frequency of each symbol is counted, and a list of nodes is generated with each node containing a symbol and the symbol's frequency. The two nodes with the lowest frequency values are merged into a single node. This new node becomes the parent node of the two nodes that are merged. The frequency value of this new parent node is the sum of the two child nodes' frequency values. The node list is updated to include the new parent node but exclude the two child nodes that are merged. This process is repeated until there is a single node remaining that is the root of the generated tree.

### 19.3.3.2 Code Length Adjustment

The leaf nodes of the tree generated by the previous step represent all the symbols that were generated. Traditionally the code for each symbol is found by traversing the tree from the root node to the leaf node. Going down a left edge generates a "0," and going down a right edge generates a "1." However, a different approach is used here. The number of codes of each code length is counted. This generates a 16-element *LengthCount* array, with *LengthCount[i]* = Number Of Codes whose Code Length is *i*. Since a code length may be longer than 16 bits, the sixteenth entry of the *LengthCount* array is set to the Number Of Codes whose Code Length is greater than or equal to 16.

The *LengthCount* array goes through further adjustment described by following code:

```

INT32 i, k;
UINT32 cum;

cum = 0;
for (i = 16; i > 0; i--) {
    cum += LengthCount[i] << (16 - i);
}
while (cum != (1U << 16)) {
    LengthCount[16]--;
    for (i = 15; i > 0; i--) {
        if (LengthCount[i] != 0) {
            LengthCount[i]--;
            LengthCount[i+1] += 2;
            break;
        }
    }
}

```

```

    cum--;
}

```

### 19.3.3.3 Code Generation

In the previous step, the count of each length was obtained. Now, each symbol is going to be assigned a code. First, the length of the code for each symbol is determined. Naturally, the code lengths are assigned in such a way that shorter codes are assigned to more frequently appearing symbols. A *CodeLength* array is generated with *CodeLength[i]* = the code length of symbol *i*. Given this array, a code is assigned to each symbol using the algorithm described by the pseudo code below (the resulting codes are stored in array *Code* such that *Code[i]* = the code assigned to symbol *i*):

```

INT32 i;
UINT16 Start[18];

Start[1] = 0;

for (i = 1; i <= 16; i++) {
    Start[i + 1] = (UINT16)((Start[i] + LengthCount[i]) << 1);
}

for (i = 0; i < NumberOfSymbols; i++) {
    Code[i] = Start[CodeLength[i]]++;
}

```

The code length adjustment process ensures that no code longer than the designated length will be generated. As long as the decompressor has the *CodeLength* array at hand, it can regenerate the codes.

## 19.4 Decompressor Design

The decompressor takes the compressed data as input and produces the original source data. The main tasks for the decompressor are decoding Huffman codes and restoring Pointers to the strings to which they point.

The following pseudo code describes the algorithm used in the design of a decompressor. The source code that illustrates an implementation of this design is listed in Appendix I.

```

WHILE not end of data DO
IF at block boundary THEN
    Read in the Extra Set Code Length Array;
    Generate the Huffman code mapping table for the Extra Set;
    Read in and decode the Char&Len Set Code Length Array;
    Generate the Huffman code mapping table for the Char&Len Set;
    Read in the Position Set Code Length Array;
    Generate the Huffman code mapping table for the Position Set;
ENDIF
    Get next code;
    Look the code up in the Char&Len Set code mapping table.

```

```

Store the result as C;
IF C < 256 (it represents an Original Character) THEN
  Output this character;
ELSE (it represents a String Length)
  Transform C to be the actual String Length value;
  Get next code and look it up in the Position Set code mapping table, and
  with some additional transformation, store the result as P;
  Output C characters starting from the position "Current Position - P";
ENDIF
ENDWHILE

```

## 19.5 Decompress Protocol

This section provides a detailed description of the **EFI\_DECOMPRESS\_PROTOCOL**.

### EFI\_DECOMPRESS\_PROTOCOL

#### Summary

Provides a decompression service.

#### GUID

```

#define EFI_DECOMPRESS_PROTOCOL_GUID \
  {0xd8117cfe,0x94a6,0x11d4,\
  {0x9a,0x3a,0x00,0x90,0x27,0x3f,0xc1,0x4d}}

```

#### Protocol Interface Structure

```

typedef struct _EFI_DECOMPRESS_PROTOCOL {
  EFI_DECOMPRESS_GET_INFO GetInfo;
  EFI_DECOMPRESS_DECOMPRESS Decompress;
} EFI_DECOMPRESS_PROTOCOL;

```

#### Parameters

*GetInfo*

Given the compressed source buffer, this function retrieves the size of the uncompressed destination buffer and the size of the scratch buffer required to perform the decompression. It is the caller's responsibility to allocate the destination buffer and the scratch buffer prior to calling [EFI\\_DECOMPRESS\\_PROTOCOL.Decompress\(\)](#). See the [EFI\\_DECOMPRESS\\_PROTOCOL.GetInfo\(\)](#) function description.

*Decompress*

Decompresses a compressed source buffer into an uncompressed destination buffer. It is the caller's responsibility to allocate the destination buffer and a scratch buffer prior to making this call. See the [Decompress\(\)](#) function description.



## Description

The **EFI\_DECOMPRESS\_PROTOCOL** provides a decompression service that allows a compressed source buffer in memory to be decompressed into a destination buffer in memory. It also requires a temporary scratch buffer to perform the decompression. The **GetInfo()** function retrieves the size of the destination buffer and the size of the scratch buffer that the caller is required to allocate. The **Decompress()** function performs the decompression. The scratch buffer can be freed after the decompression is complete.

## EFI\_DECOMPRESS\_PROTOCOL.GetInfo()

### Summary

Given a compressed source buffer, this function retrieves the size of the uncompressed buffer and the size of the scratch buffer required to decompress the compressed source buffer.

### Prototype

```
typedef
EFI_STATUS
(EFI_API *EFI_DECOMPRESS_GET_INFO) (
    IN EFI_DECOMPRESS_PROTOCOL *This,
    IN VOID          *Source,
    IN UINT32       SourceSize,
    OUT UINT32      *DestinationSize,
    OUT UINT32      *ScratchSize
);
```

### Parameters

<i>This</i>	A pointer to the <a href="#">EFI_DECOMPRESS_PROTOCOL</a> instance. Type <a href="#">EFI_DECOMPRESS_PROTOCOL</a> is defined in <a href="#">Section 19.5</a> .
<i>Source</i>	The source buffer containing the compressed data.
<i>SourceSize</i>	The size, in bytes, of the source buffer.
<i>DestinationSize</i>	A pointer to the size, in bytes, of the uncompressed buffer that will be generated when the compressed buffer specified by <i>Source</i> and <i>SourceSize</i> is decompressed.
<i>ScratchSize</i>	A pointer to the size, in bytes, of the scratch buffer that is required to decompress the compressed buffer specified by <i>Source</i> and <i>SourceSize</i> .

### Description

The **GetInfo()** function retrieves the size of the uncompressed buffer and the temporary scratch buffer required to decompress the buffer specified by *Source* and *SourceSize*. If the size of the uncompressed buffer or the size of the scratch buffer cannot be determined from the compressed data specified by *Source* and *SourceData*, then **EFI\_INVALID\_PARAMETER** is returned. Otherwise, the size of the uncompressed buffer is returned in *DestinationSize*, the size of the scratch buffer is returned in *ScratchSize*, and **EFI\_SUCCESS** is returned.

The **GetInfo()** function does not have scratch buffer available to perform a thorough checking of the validity of the source data. It just retrieves the "Original Size" field from the beginning bytes of the source data and output it as *DestinationSize*. And *ScratchSize* is specific to the decompression implementation.

## Status Codes Returned

EFI_SUCCESS	The size of the uncompressed data was returned in <i>DestinationSize</i> and the size of the scratch buffer was returned in <i>ScratchSize</i> .
EFI_INVALID_PARAMETER	The size of the uncompressed data or the size of the scratch buffer cannot be determined from the compressed data specified by <i>Source</i> and <i>SourceSize</i> .

## EFI\_DECOMPRESS\_PROTOCOL.Decompress()

### Summary

Decompresses a compressed source buffer.

### Prototype

```
typedef
EFI_STATUS
(EFI_API *EFI_DECOMPRESS_DECOMPRESS) (
  IN EFI_DECOMPRESS_PROTOCOL *This,
  IN VOID *Source,
  IN UINT32 SourceSize,
  IN OUT VOID *Destination,
  IN UINT32 DestinationSize,
  IN OUT VOID *Scratch,
  IN UINT32 ScratchSize
);
```

### Parameters

<i>This</i>	A pointer to the <a href="#">EFI_DECOMPRESS_PROTOCOL</a> instance. Type <a href="#">EFI_DECOMPRESS_PROTOCOL</a> is defined in <a href="#">Section 19.5</a> .
<i>Source</i>	The source buffer containing the compressed data.
<i>SourceSize</i>	The size of source data.
<i>Destination</i>	On output, the destination buffer that contains the uncompressed data.
<i>DestinationSize</i>	The size of the destination buffer. The size of the destination buffer needed is obtained from <a href="#">EFI_DECOMPRESS_PROTOCOL.GetInfo()</a> .
<i>Scratch</i>	A temporary scratch buffer that is used to perform the decompression.
<i>ScratchSize</i>	The size of scratch buffer. The size of the scratch buffer needed is obtained from <a href="#">GetInfo()</a> .

### Description

The [Decompress\(\)](#) function extracts decompressed data to its original form.

This protocol is designed so that the decompression algorithm can be implemented without using any memory services. As a result, the [Decompress\(\)](#) function is not allowed to call [EFI\\_BOOT\\_SERVICES.AllocatePool\(\)](#) or [EFI\\_BOOT\\_SERVICES.AllocatePages\(\)](#) in its implementation. It is the caller's responsibility to allocate and free the *Destination* and *Scratch* buffers.

If the compressed source data specified by *Source* and *SourceSize* is successfully decompressed into *Destination*, then [EFI\\_SUCCESS](#) is returned. If the compressed source

data specified by *Source* and *SourceSize* is not in a valid compressed data format, then **EFI\_INVALID\_PARAMETER** is returned.

### Status Codes Returned

EFI_SUCCESS	Decompression completed successfully, and the uncompressed buffer is returned in <i>Destination</i> .
EFI_INVALID_PARAMETER	The source buffer specified by <i>Source</i> and <i>SourceSize</i> is corrupted (not in a valid compressed format).



## 20 Protocols — ACPI Protocols

---

### EFI\_ACPI\_TABLE\_PROTOCOL

#### Summary

This protocol may be used to install or remove an ACPI table from a platform.

#### GUID

```
#define EFI_ACPI_TABLE_PROTOCOL_GUID \
{0xffe06bdd, 0x6107, 0x46a6, \
{0x7b, 0xb2, 0x5a, 0x9c, 0x7e, 0xc5, 0x27, 0x5c}}
```

#### Protocol Interface Structure

```
typedef struct _EFI_ACPI_TABLE_PROTOCOL {
    EFI_ACPI_TABLE_INSTALL_ACPI_TABLE    InstallAcpiTable;
    EFI_ACPI_TABLE_UNINSTALL_ACPI_TABLE  UninstallAcpiTable;
} EFI_ACPI_TABLE_PROTOCOL;
```

#### Parameters

<i>InstallAcpiTable</i>	Installs an ACPI table into the system.
<i>UninstallAcpiTable</i>	Removes a previously installed ACPI table from the system.

#### Description

The **EFI\_ACPI\_TABLE\_PROTOCOL** provides the ability for a component to install and uninstall ACPI tables from a platform.

## EFI\_ACPI\_TABLE\_PROTOCOL.InstallAcpiTable()

### Summary

Installs an ACPI table into the RSDT/XSDT.

### Prototype

```
typedef
EFI_STATUS
(EFI_API *EFI_ACPI_TABLE_INSTALL_ACPI_TABLE) (
    IN EFI_ACPI_TABLE_PROTOCOL *This,
    IN VOID *AcpiTableBuffer,
    IN UINTN AcpiTableBufferSize,
    OUT UINTN *TableKey,
);
```

### Parameters

<i>This</i>	A pointer to a <a href="#">EFI_ACPI_TABLE_PROTOCOL</a> .
<i>AcpiTableBuffer</i>	A pointer to a buffer containing the ACPI table to be installed.
<i>AcpiTableBufferSize</i>	Specifies the size, in bytes, of the <i>AcpiTableBuffer</i> buffer.
<i>TableKey</i>	Returns a key to refer to the ACPI table.

### Description

The **InstallAcpiTable()** function allows a caller to install an ACPI table. The ACPI table may either be a System Description Table or the FACS. For all tables except for the DSDT and FACS, a copy of the table will be linked by the RSDT/XSDT. For the FACS and DSDT, the pointer to a copy of the table will be updated in the FADT, if present.

To prevent namespace collision, ACPI tables may be created using UEFI ACPI table format. See [Appendix O](#). If this protocol is used to install a table with a signature already present in the system, the new table will not replace the existing table. It is a platform implementation decision to add a new table with a signature matching an existing table or disallow duplicate table signatures and return **EFI\_ACCESS\_DENIED**.

On successful output, *TableKey* is initialized with a unique key. Its value may be used in a subsequent call to **UninstallAcpiTable** to remove an ACPI table.

On successful output, the **EFI\_ACPI\_TABLE\_PROTOCOL** will ensure that the checksum field is correct for both the RSDT/XSDT table and the copy of the table being installed that is linked by the RSDT/XSDT.

If an EFI application is running at the time of this call, the relevant **EFI\_CONFIGURATION\_TABLE** pointer to the RSDT is no longer considered valid.

### Status Codes Returned

EFI_SUCCESS	The table was successfully inserted
-------------	-------------------------------------



EFI_INVALID_PARAMETER	The <i>AcpiTableBuffer</i> is <b>NULL</b> , the <i>TableKey</i> is <b>NULL</b> ; the <i>AcpiTableBufferSize</i> , and the size field embedded in the ACPI table pointed to by <i>AcpiTableBuffer</i> are not in sync.
EFI_OUT_OF_RESOURCES	Insufficient resources exist to complete the request.
EFI_ACCESS_DENIED	The table signature matches a table already present in the system and platform policy does not allow duplicate tables of this type.

## EFI\_ACPI\_TABLE\_PROTOCOL.UninstallAcpiTable()

### Summary

Removes an ACPI table from the RSDT/XSDT.

### Prototype

```
typedef
EFI_STATUS
(EFIAPI *EFI_ACPI_TABLE_UNINSTALL_ACPI_TABLE) (
    IN EFI_ACPI_TABLE_PROTOCOL *This,
    IN UINTN      TableKey,
);
```

### Parameters

<i>This</i>	A pointer to a <a href="#">EFI ACPI TABLE PROTOCOL</a> .
<i>TableKey</i>	Specifies the table to uninstall. The key was returned from <a href="#">InstallAcpiTable()</a> .

### Description

The [UninstallAcpiTable\(\)](#) function allows a caller to remove an ACPI table. The routine will remove its reference from the RSDT/XSDT. A table is referenced by the TableKey parameter returned from a prior call to [InstallAcpiTable\(\)](#). If an EFI application is running at the time of this call, the relevant [EFI\\_CONFIGURATION\\_TABLE](#) pointer to the RSDT is no longer considered valid.

### Status Codes Returned

EFI_SUCCESS	The table was successfully inserted
EFI_NOT_FOUND	TableKey does not refer to a valid key for a table entry.
EFI_OUT_OF_RESOURCES	Insufficient resources exist to complete the request.

## 21 Protocols — String Services

### 21.1 Unicode Collation Protocol

This section defines the Unicode Collation protocol. This protocol is used to allow code running in the boot services environment to perform lexical comparison functions on Unicode strings for given languages.

#### EFI\_UNICODE\_COLLATION\_PROTOCOL

##### Summary

Is used to perform case-insensitive comparisons of strings.

##### GUID

```
#define EFI_UNICODE_COLLATION_PROTOCOL2_GUID \
{0xa4c751fc, 0x23ae, 0x4c3e, \
 {0x92, 0xe9, 0x49, 0x64, 0xcf, 0x63, 0xf3, 0x49}}
```

##### Protocol Interface Structure

```
typedef struct {
  EFI_UNICODE_COLLATION_STRICOLL  StriColl;
  EFI_UNICODE_COLLATION_METAIMATCH MetaiMatch;
  EFI_UNICODE_COLLATION_STRLWR    StrLwr;
  EFI_UNICODE_COLLATION_STRUPR    StrUpr;
  EFI_UNICODE_COLLATION_FATTOSTR  FatToStr;
  EFI_UNICODE_COLLATION_STRTOFAT  StrToFat;
  CHAR8                           *SupportedLanguages;
} EFI_UNICODE_COLLATION_PROTOCOL;
```

##### Parameters

<i>StriColl</i>	Performs a case-insensitive comparison of two Null-terminated strings. See the <a href="#">StriColl()</a> function description.
<i>MetaiMatch</i>	Performs a case-insensitive comparison between a Null-terminated pattern string and a Null-terminated string. The pattern string can use the '?' wildcard to match any character, and the '*' wildcard to match any substring. See the <a href="#">MetaiMatch()</a> function description.
<i>StrLwr</i>	Converts all the characters in a Null-terminated string to lowercase characters. See the <a href="#">StrLwr()</a> function description.
<i>StrUpr</i>	Converts all the characters in a Null-terminated string to uppercase characters. See the <a href="#">StrUpr()</a> function description.

<i>FatToStr</i>	Converts an 8.3 FAT file name using an OEM character set to a Null-terminated string. See the <a href="#">FatToStr()</a> function description.
<i>StrToFat</i>	Converts a Null-terminated string to legal characters in a FAT filename using an OEM character set. See the <a href="#">StrToFat()</a> function description.
<i>SupportedLanguages</i>	A Null-terminated ASCII string array that contains one or more language codes. This array is specified in RFC 4646 format. See <a href="#">Appendix M</a> for the format of language codes and language code arrays.

## Description

The **EFI\_UNICODE\_COLLATION\_PROTOCOL** is used to perform case-insensitive comparisons of strings.

One or more of the **EFI\_UNICODE\_COLLATION\_PROTOCOL** instances may be present at one time. Each protocol instance can support one or more language codes. The language codes supported in the **EFI\_UNICODE\_COLLATION\_PROTOCOL** are declared in *SupportedLanguages*.

The *SupportedLanguages* is a Null-terminated ASCII string array that contains one or more supported language codes. This is the list of language codes that this protocol supports. See [Appendix M](#) for the format of language codes and language code arrays.

The main motivation for this protocol is to help support file names in a file system driver. When a file is opened, a file name needs to be compared to the file names on the disk. In some cases, this comparison needs to be performed in a case-insensitive manner. In addition, this protocol can be used to sort files from a directory or to perform a case-insensitive file search.

## EFI\_UNICODE\_COLLATION\_PROTOCOL.StriColl()

### Summary

Performs a case-insensitive comparison of two Null-terminated strings.

### Prototype

```
typedef
INTN
(EFI_API *EFI_UNICODE_COLLATION_STRI_COLL) (
  IN EFI_UNICODE_COLLATION_PROTOCOL *This,
  IN CHAR16 *s1,
  IN CHAR16 *s2
);
```

### Parameters

<i>This</i>	A pointer to the <a href="#">EFI_UNICODE_COLLATION_PROTOCOL</a> instance. Type <code>EFI_UNICODE_COLLATION_PROTOCOL</code> is defined above.
<i>s1</i>	A pointer to a Null-terminated string.
<i>s2</i>	A pointer to a Null-terminated string.

### Description

The **StriColl()** function performs a case-insensitive comparison of two Null-terminated strings.

This function performs a case-insensitive comparison between the string *s1* and the string *s2* using the rules for the language codes that this protocol instance supports. If *s1* is equivalent to *s2*, then 0 is returned. If *s1* is lexically less than *s2*, then a negative number will be returned. If *s1* is lexically greater than *s2*, then a positive number will be returned. This function allows strings to be compared and sorted.

### Status Codes Returned

0	s1 is equivalent to s2.
> 0	s1 is lexically greater than s2.
< 0	s1 is lexically less than s2.

## EFI\_UNICODE\_COLLATION\_PROTOCOL.MetaiMatch()

### Summary

Performs a case-insensitive comparison of a Null-terminated pattern string and a Null-terminated string.

### Prototype

```
typedef
BOOLEAN
(EFI_API *EFI_UNICODE_COLLATION_METAIMATCH) (
    IN EFI_UNICODE_COLLATION_PROTOCOL *This,
    IN CHAR16      *String,
    IN CHAR16      *Pattern
);
```

### Parameters

<i>This</i>	A pointer to the <a href="#">EFI_UNICODE_COLLATION_PROTOCOL</a> instance. Type <a href="#">EFI_UNICODE_COLLATION_PROTOCOL</a> is defined above.
<i>String</i>	A pointer to a Null-terminated string.
<i>Pattern</i>	A pointer to a Null-terminated string.

### Description

The **MetaiMatch()** function performs a case-insensitive comparison of a Null-terminated pattern string and a Null-terminated string.

This function checks to see if the pattern of characters described by *Pattern* are found in *String*. The pattern check is a case-insensitive comparison using the rules for the language codes that this protocol instance supports. If the pattern match succeeds, then **TRUE** is returned. Otherwise **FALSE** is returned. The following syntax can be used to build the string *Pattern*:

*	Match 0 or more characters.
?	Match any one character.
[<char1><char2>...<charN>]	Match any character in the set.
[<char1>-<char2>]	Match any character between <char1> and <char2>.
<char>	Match the character <char>.

Following is an example pattern for English:

*.FW	Matches all strings that end in ".FW" or ".fw" or ".Fw" or ".fW."
[a-z]	Match any letter in the alphabet.
[!@#%\$%^&*()]	Match any one of these symbols.
z	Match the character "z" or "Z."

**D?.\***

Match the character "D" or "d" followed by any character followed by a "." followed by any string.

**Status Codes Returned**

TRUE	Pattern was found in <i>String</i> .
FALSE	Pattern was not found in <i>String</i> .

## EFI\_UNICODE\_COLLATION\_PROTOCOL.StrLwr()

### Summary

Converts all the characters in a Null-terminated string to lowercase characters.

### Prototype

```
typedef
VOID
(EFI_API *EFI_UNICODE_COLLATION_STRLWR) (
  IN EFI_UNICODE_COLLATION_PROTOCOL *This,
  IN OUT CHAR16 *String
);
```

### Parameters

*This*

A pointer to the [EFI\\_UNICODE\\_COLLATION\\_PROTOCOL](#) instance. Type `EFI_UNICODE_COLLATION_PROTOCOL` is defined above.

*String*

A pointer to a Null-terminated string.

### Description

This function walks through all the characters in *String*, and converts each one to its lowercase equivalent if it has one. The converted string is returned in *String*.



## EFI\_UNICODE\_COLLATION\_PROTOCOL.StrUpr()

### Summary

Converts all the characters in a Null-terminated string to uppercase characters.

### Prototype

```
typedef
VOID
(EFI_API *EFI_UNICODE_COLLATION_STRUPR) (
    IN EFI_UNICODE_COLLATION_PROTOCOL *This,
    IN OUT CHAR16 *String
);
```

### Parameters

*This*

A pointer to the [EFI\\_UNICODE\\_COLLATION\\_PROTOCOL](#) instance. Type [EFI\\_UNICODE\\_COLLATION\\_PROTOCOL](#) is defined above.

*String*

A pointer to a Null-terminated string.

### Description

This function walks through all the characters in *String*, and converts each one to its uppercase equivalent if it has one. The converted string is returned in *String*.

## EFI\_UNICODE\_COLLATION\_PROTOCOL.FatToStr()

### Summary

Converts an 8.3 FAT file name in an OEM character set to a Null-terminated string.

### Prototype

```
typedef
VOID
(EFI_API *EFI_UNICODE_COLLATION_FATTOSTR) (
  IN EFI_UNICODE_COLLATION_PROTOCOL *This,
  IN UINTN FatSize,
  IN CHAR8 *Fat,
  OUT CHAR16 *String
);
```

### Parameters

<i>This</i>	A pointer to the <a href="#">EFI_UNICODE_COLLATION_PROTOCOL</a> instance. Type <a href="#">EFI_UNICODE_COLLATION_PROTOCOL</a> is defined above.
<i>FatSize</i>	The size of the string <i>Fat</i> in bytes.
<i>Fat</i>	A pointer to a Null-terminated string that contains an 8.3 file name encoded using an 8-bit OEM character set.
<i>String</i>	A pointer to a Null-terminated string. The string must be allocated in advance to hold <i>FatSize</i> characters.

### Description

This function converts the string specified by *Fat* with length *FatSize* to the Null-terminated string specified by *String*. The characters in *Fat* are from an OEM character set.

## EFI\_UNICODE\_COLLATION\_PROTOCOL.StrToFat()

### Summary

Converts a Null-terminated string to legal characters in a FAT filename using an OEM character set.

### Prototype

```
typedef
BOOLEAN
(EFI_API *EFI_UNICODE_COLLATION_STRTOFAT) (
  IN EFI_UNICODE_COLLATION_PROTOCOL *This,
  IN CHAR16      *String,
  IN UINTN      FatSize,
  OUT CHAR8      *Fat
);
```

### Parameters

*This*

A pointer to the [EFI\\_UNICODE\\_COLLATION\\_PROTOCOL](#) instance. Type [EFI\\_UNICODE\\_COLLATION\\_PROTOCOL](#) is defined above.

*String*

A pointer to a Null-terminated string.

*FatSize*

The size of the string *Fat* in bytes.

*Fat*

A pointer to a string that contains the converted version of *String* using legal FAT characters from an OEM character set.

### Description

This function converts the characters from *String* into legal FAT characters in an OEM character set and stores them in the string *Fat*. This conversion continues until either *FatSize* bytes are stored in *Fat*, or the end of *String* is reached. The characters '.' (period) and ' ' (space) are ignored for this conversion. Characters that map to an illegal FAT character are substituted with an '\_'. If no valid mapping from a character to an OEM character is available, then it is also substituted with an '\_'. If any of the character conversions are substituted with a '\_', then **TRUE** is returned. Otherwise **FALSE** is returned.

### Status Codes Returned

TRUE	One or more conversions failed and were substituted with '_'.
FALSE	None of the conversions failed.

## 21.2 Regular Expression Protocol

This section defines the Regular Expression Protocol. This protocol is used to match Unicode strings against Regular Expression patterns.

## EFI\_REGULAR\_EXPRESSION\_PROTOCOL

### Summary

### GUID

```
#define EFI_REGULAR_EXPRESSION_PROTOCOL_GUID \
{ 0xB3F79D9A, 0x436C, 0xDC11, \
  { 0xB0, 0x52, 0xCD, 0x85, 0xDF, 0x52, 0x4C, 0xE6 } }
```

### Protocol Interface Structure

```
typedef struct {
  EFI_REGULAR_EXPRESSION_MATCH MatchString;
  EFI_REGULAR_EXPRESSION_GET_INFO GetInfo;
} EFI_REGULAR_EXPRESSION_PROTOCOL;
```

### Parameters

*MatchString*

Search the input string for anything that matches the regular expression.

*GetInfo*

Returns information about the regular expression syntax types supported by the implementation.

## EFI\_REGULAR\_EXPRESSION\_PROTOCOL.MatchString()

### Summary

Checks if the input string matches to the regular expression pattern.

### Prototype

```
typedef
EFI_STATUS
EFI_API *EFI_REGULAR_EXPRESSION_MATCH) (
  IN EFI_REGULAR_EXPRESSION_PROTOCOL *This,
  IN CHAR16      *String,
  IN CHAR16      *Pattern,
  IN EFI_REGEX_SYNTAX_TYPE  *SyntaxType, OPTIONAL
  OUT BOOLEAN      *Result,
  OUT EFI_REGEX_CAPTURE  **Captures, OPTIONAL
  OUT UINTN        *CapturesCount
);
```

### Parameters

<i>This</i>	A pointer to the <b>EFI_REGULAR_EXPRESSION_PROTOCOL</b> instance. Type <b>EFI_REGULAR_EXPRESSION_PROTOCOL</b> is defined in above.
<i>String</i>	A pointer to a NULL terminated string to match against the regular expression string specified by <i>Pattern</i> .
<i>Pattern</i>	A pointer to a NULL terminated string that represents the regular expression.
<i>SyntaxType</i>	A pointer to the <b>EFI_REGEX_SYNTAX_TYPE</b> that identifies the regular expression syntax type to use. May be NULL in which case the function will use its default regular expression syntax type.
<i>Result</i>	On return, points to <b>TRUE</b> if <i>String</i> fully matches against the regular expression <i>Pattern</i> using the regular expression <i>SyntaxType</i> . Otherwise, points to <b>FALSE</b> .
<i>Captures</i>	A Pointer to an array of <b>EFI_REGEX_CAPTURE</b> objects to receive the captured groups in the event of a match. The full sub-string match is put in <i>Captures</i> [0], and the results of N capturing groups are put in <i>Captures</i> [1:N]. If <i>Captures</i> is NULL, then this function doesn't allocate the memory for the array and does not build up the elements. It only returns the number of matching patterns in <i>CapturesCount</i> . If <i>Captures</i> is not NULL, this function returns a pointer to an array and builds up the elements in the array. <i>CapturesCount</i> is also updated to the number of matching patterns found. It is the caller's responsibility to free the memory pool in <i>Captures</i> and in each <i>CapturePtr</i> in the array elements.

*CapturesCount* On output, *CapturesCount* is the number of matching patterns found in *String*. Zero means no matching patterns were found in the string.

### Description

The **MatchString()** function performs a matching of a Null-terminated input string with the NULL terminated pattern string. The pattern string syntax type is optionally identified in *SyntaxType*.

This function checks to see if *String* fully matches against the regular expression described by *Pattern*. The pattern check is performed using regular expression rules that are supported by this implementation, as indicated in the return value of *GetInfo* function. If the pattern match succeeds, then **TRUE** is returned in *Result*. Otherwise **FALSE** is returned.

### Related Definitions

```
typedef struct {
    CONST CHAR16 *CapturePtr;
    UINTN Length;
} EFI_REGEX_CAPTURE;
```

*\*CapturePtr* Pointer to the start of the captured sub-expression within matched *String*.

*Length* Length of captured sub-expression.

### Status Codes Returned

EFI_SUCCESS	The regular expression string matching completed successfully.
EFI_UNSUPPORTED	The regular expression syntax specified by <i>SyntaxType</i> is not supported by this driver.
EFI_DEVICE_ERROR	The regular expression string matching failed due to a hardware or firmware error.
EFI_INVALID_PARAMETER	<i>String</i> , <i>Pattern</i> , <i>Result</i> , or <i>CapturesCount</i> is NULL.

## EFI\_REGULAR\_EXPRESSION\_PROTOCOL.GetInfo()

### Summary

Returns information about the regular expression syntax types supported by the implementation.

### Prototype

```
typedef
EFI_STATUS
EFIAPI *EFI_REGULAR_EXPRESSION_GET_INFO) (
  IN EFI_REGULAR_EXPRESSION_PROTOCOL *This,
  IN OUT UINTN *RegExSyntaxTypeListSize,
  OUT EFI_REGEX_SYNTAX_TYPE *RegExSyntaxTypeList
);
```

### Parameters

*This*

A pointer to the **EFI\_REGULAR\_EXPRESSION\_PROTOCOL** instance.

*RegExSyntaxTypeListSize*

On input, the size in bytes of *RegExSyntaxTypeList*. On output with a return code of **EFI\_SUCCESS**, the size in bytes of the data returned in *RegExSyntaxTypeList*. On output with a return code of **EFI\_BUFFER\_TOO\_SMALL**, the size of *RegExSyntaxTypeList* required to obtain the list.

*RegExSyntaxTypeList* A caller-allocated memory buffer filled by the driver with one **EFI\_REGEX\_SYNTAX\_TYPE** element for each supported regular expression syntax type. The list must not change across multiple calls to the same driver. The first syntax type in the list is the default type for the driver.

### Description

This function returns information about supported regular expression syntax types. A driver implementing the **EFI\_REGULAR\_EXPRESSION\_PROTOCOL** protocol need not support more than one regular expression syntax type, but shall support a minimum of one regular expression syntax type.

## Related Definitions

```
typedef EFI_GUID EFI_REGEX_SYNTAX_TYPE;
```

## Status Codes Returned

EFI_SUCCESS	The regular expression syntax types list was returned successfully.
EFI_UNSUPPORTED	The service is not supported by this driver.
EFI_DEVICE_ERROR	The list of syntax types could not be retrieved due to a hardware or firmware error.
EFI_BUFFER_TOO_SMALL	The buffer <i>RegExSyntaxTypeList</i> is too small to hold the result.
EFI_INVALID_PARAMETER	<i>RegExSyntaxTypeListSize</i> is NULL.

## 21.2.1 EFI Regular Expression Syntax Type Definitions

### Summary

This sub-section provides **EFI\_GUID** values for a selection of **EFI\_REGULAR\_EXPRESSION\_PROTOCOL** syntax types. The types listed are optional, not meant to be exhaustive and may be augmented by vendors or other industry standards.

### Prototype

For regular expression rules specified in the POSIX Extended Regular Expression (ERE) Syntax:

```
#define EFI_REGEX_SYNTAX_TYPE_POSIX_EXTENDED_GUID \  
    {0x5F05B20F, 0x4A56, 0xC231, \  
    { 0xFA, 0x0B, 0xA7, 0xB1, 0xF1, 0x10, 0x04, 0x1D } }
```

For regular expression rules specified in the Perl standard:

```
#define EFI_REGEX_SYNTAX_TYPE_PERL_GUID \  
    {0x63E60A51, 0x497D, 0xD427, \  
    { 0xC4, 0xA5, 0xB8, 0xAB, 0xDC, 0x3A, 0xAE, 0xB6 } }
```

For regular expression rules specified in the ECMA 262 Specification:

```
#define EFI_REGEX_SYNTAX_TYPE_ECMA_262_GUID \  
    { 0x9A473A4A, 0x4CEB, 0xB95A, 0x41, \  
    { 0x5E, 0x5B, 0xA0, 0xBC, 0x63, 0x9B, 0x2E } }
```



For regular expression rules specified in the POSIX Extended Regular Expression (ERE) Syntax, where the Pattern and String input strings need to be converted to ASCII:

```
#define EFI_REGEX_SYNTAX_TYPE_POSIX_EXTENDED_ASCII_GUID \
    {0x3FD32128, 0x4BB1, 0xF632, \
     { 0xBE, 0x4F, 0xBA, 0xBF, 0x85, 0xC9, 0x36, 0x76 }}
```

For regular expression rules specified in the Perl standard, where the Pattern and String input strings need to be converted to ASCII:

```
#define EFI_REGEX_SYNTAX_TYPE_PERL_ASCII_GUID \
    {0x87DFB76D, 0x4B58, 0xEF3A, \
     { 0xF7, 0xC6, 0x16, 0xA4, 0x2A, 0x68, 0x28, 0x10 }}
```

For regular expression rules specified in the ECMA 262 Specification, where the Pattern and String input strings need to be converted to ASCII:

```
#define EFI_REGEX_SYNTAX_TYPE_ECMA_262_ASCII_GUID \
    { 0xB2284A2F, 0x4491, 0x6D9D, \
     { 0xEA, 0xB7, 0x11, 0xB0, 0x67, 0xD4, 0x9B, 0x9A }}
(See Appendix Q for more information.)
```

(See Appendix Q for more information.)



## 22 EFI Byte Code Virtual Machine

---

This section defines an EFI Byte Code (EBC) Virtual Machine that can provide platform- and processor-independent mechanisms for loading and executing EFI device drivers.

### 22.1 Overview

The current design for option ROMs that are used in personal computer systems has been in place since 1981. Attempts to change the basic design requirements have failed for a variety of reasons. The EBC Virtual Machine described in this chapter is attempting to help achieve the following goals:

- Abstract and extensible design
- Processor independence
- OS independence
- Build upon existing specifications when possible
- Facilitate the removal of legacy infrastructure
- Exclusive use of EFI Services

One way to satisfy many of these goals is to define a pseudo or virtual machine that can interpret a predefined instruction set. This will allow the virtual machine to be ported across processor and system architectures without changing or recompiling the option ROM. This specification defines a set of machine level instructions that can be generated by a C compiler.

The following sections are a detailed description of the requirements placed on future option ROMs.

#### 22.1.1 Processor Architecture Independence

Option ROM images shall be independent of supported 32-bit and supported 64-bit architectures. In order to abstract the architectural differences between processors option ROM images shall be EBC. This model is presented below:

- 64-bit C source code
- The EFI EBC image is the flashed image
- The system BIOS implements the EBC interpreter
- The interpreter handles 32 vs. 64 bit issues

Current Option ROM technology is processor dependent and heavily reliant upon the existence of the PC-AT infrastructure. These dependencies inhibit the evolution of both hardware and software under the veil of "backward compatibility." A solution that isolates the hardware and support infrastructure through abstraction will facilitate the uninhibited progression of technology.

### 22.1.2 OS Independent

Option ROMs shall not require or assume the existence of a particular OS.

### 22.1.3 EFI Compliant

Option ROM compliance with EFI requires (but is not limited to) the following:

- Little endian layout
- Single-threaded model with interrupt polling if needed
- Where EFI provides required services, EFI is used exclusively. These include:
  - Console I/O
  - Memory Management
  - Timer services
  - Global variable access
- When an Option ROM provides EFI services, the EFI specification is strictly followed:
  - Service/protocol installation
  - Calling conventions
  - Data structure layouts
  - Guaranteed return on services

### 22.1.4 Coexistence of Legacy Option ROMs

The infrastructure shall support coexistent Legacy Option ROM and EBC Option ROM images. This case would occur, for example, when a Plug and Play Card has both Legacy and EBC Option ROM images flashed. The details of the mechanism used to select which image to load is beyond the scope of this document. Basically, a legacy System BIOS would not recognize an EBC Option ROM and therefore would never load it. Conversely, an EFI Firmware Boot Manager would only load images that it supports.

The EBC Option ROM format must utilize a legacy format to the extent that a Legacy System BIOS can:

- Determine the type of the image, in order to ignore the image. The type must be incompatible with currently defined types.
- Determine the size of the image, in order to skip to the next image.

### 22.1.5 Relocatable Image

An EBC option ROM image shall be eligible for placement in any system memory area large enough to accommodate it.

Current option ROM technology requires images to be shadowed in system memory address range 0xC0000 to 0xEFFFF on a 2048 byte boundary. This dependency not only limits the number of Option ROMs, it results in unused memory fragments up to 2 KiB.

### 22.1.6 Size Restrictions Based on Memory Available

EBC option ROM images shall not be limited to a predetermined fixed maximum size.

Current option ROM technology limits the size of a preinitialization option ROM image to 128 KiB (126 KiB actual). Additionally, in the DDIM an image is not allowed to grow during initialization. It is inevitable that 64-bit solutions will increase in complexity and size. To avoid revisiting this issue, EBC option ROM size is only limited by available system memory. EFI memory allocation services allow device drivers to claim as much memory as they need, within limits of available system memory.

The PCI specification limits the size of an image stored in an option ROM to 16 MB. If the driver is stored on the hard drive then the 16MB option ROM limit does not apply. In addition, the PE/COFF object format limits the size of images to 2 GB.

## 22.2 Memory Ordering

The term memory ordering refers to the order in which a processor issues reads (loads) and writes (stores) out onto the bus to system memory. The EBC Virtual Machine enforces strong memory ordering, where reads and writes are issued on the system bus in the order they occur in the instruction stream under all circumstances.

## 22.3 Virtual Machine Registers

The EBC virtual machine utilizes a simple register set. There are two categories of VM registers: general purpose registers and dedicated registers. All registers are 64-bits wide. There are eight (8) general-purpose registers (**R0-R7**), which are used by most EBC instructions to manipulate or fetch data. [Table 143](#) lists the general-purpose registers in the VM and the conventions for their usage during execution.

**Table 143. General Purpose VM Registers**

Index	Register	Description
0	R0	Points to the top of the stack
1-3	R1-R3	Preserved across calls
4-7	R4-R7	Scratch, not preserved across calls

Register **R0** is used as a stack pointer and is used by the [CALL](#), [RET](#), [PUSH](#), and [POP](#) instructions. The VM initializes this register to point to the incoming arguments when an EBC image is started or entered. This register may be modified like any other general purpose VM register using EBC instructions. Register **R7** is used for function return values. Unlike the general-purpose registers, the VM dedicated registers have specific purposes. There are two dedicated registers: the instruction pointer (**IP**), and the flags (**Flags**) register. Specialized instructions provide access to the dedicated registers. These instructions reference the particular dedicated register by its assigned index value. [Table 144](#) lists the dedicated registers and their corresponding index values.

Table 144. Dedicated VM Registers

Index	Register	Description	
0	FLAGS		
		Bit	Description
		0	C = Condition code
		1	SS = Single step
		2..63	Reserved
1	IP	Points to current instruction	
2..7	Reserved	Not defined	

The VM **Flags** register contains VM status and context flags. [Table 145](#) lists the descriptions of the bits in the **Flags** register.

Table 145. VM Flags Register

Bit	Flag	Description
0	C	Condition code. Set to 1 if the result of the last compare was true, or set to 0 if the last compare was false. Used by conditional JMP instructions.
1	S	Single-step. If set, causes the VM to generate a single-step exception after executing each instruction. The bit is not cleared by the VM following the exception.
2..63	-	Reserved

The VM **IP** register is used as an instruction pointer and holds the address of the currently executing EBC instruction. The virtual machine will update the **IP** to the address of the next instruction on completion of the current instruction, and will continue execution from the address indicated in **IP**. The **IP** register can be moved into any general-purpose register (**R0-R7**). Data manipulation and data movement instructions can then be used to manipulate the value. The only instructions that may modify the **IP** are the [JMP](#), [CALL](#), and [RET](#) instructions. Since the instruction set is designed to use words as the minimum instruction entity, the low order bit (bit 0) of **IP** is always cleared to 0. If a JMP, CALL, or RET instruction causes bit 0 of **IP** to be set to 1, then an alignment exception occurs.

## 22.4 Natural Indexing

The natural indexing mechanism is the critical functionality that enables EBC to be executed unchanged on 32- or 64-bit systems. Natural indexing is used to specify the offset of data relative to a base address. However, rather than specifying the offset as a fixed number of bytes, the offset is encoded in a form that specifies the actual offset in two parts: a constant offset, and an offset specified as a number of natural units (where one natural unit = sizeof (VOID \*)). These two values are used to compute the actual offset to data at runtime. When the VM decodes an index during execution, the resultant offset

is computed based on the natural processor size. The encoded indexes themselves may be 16, 32, or 64 bits in size. [Table 146](#) describes the fields in a natural index encoding.

**Table 146. Index Encoding**

Bit #	Description
N	Sign bit (sign), most significant bit
N-3..N-1	Bits assigned to natural units (w)
A..N-4	Constant units (c)
0..A-1	Natural units (n)

As shown in [Table 146](#), for a given encoded index, the most significant bit (bit N) specifies the sign of the resultant offset after it has been calculated. The sign bit is followed by three bits (N-3..N-1) that are used to compute the width of the natural units field (n). The value (w) from this field is multiplied by the index size in bytes to determine the actual width (A) of the natural units field (n). Once the width of the natural units field has been determined, then the natural units (n) and constant units (c) can be extracted. The offset is then calculated at runtime according to the following equation:

$$\text{Offset} = (c + n * (\text{sizeof}(\text{VOID} *))) * \text{sign}$$

The following sections describe each of these fields in more detail.

### 22.4.1 Sign Bit

The sign bit determines the sign of the index once the offset calculation has been performed. All index computations using “n” and “c” are done with positive numbers, and the sign bit is only used to set the sign of the final offset computed.

### 22.4.2 Bits Assigned to Natural Units

This 3-bit field that is used to determine the width of the natural units field. The units vary based on the size of the index according to [Table 147](#). For example, for a 16-bit index, the value contained in this field would be multiplied by 2 to get the actual width of the natural-units field.

**Table 147. Index Size in Index Encoding**

Index Size	Units
16 bits	2 bits
32 bits	4 bits
64 bits	8 bits

### 22.4.3 Constant

The constant is the number of bytes in the index that do not scale with processor size. When the index is a 16-bit value, the maximum constant is 4095. This index is achieved when the bits assigned to natural units is 0.

## 22.4.4 Natural Units

Natural units are used when a structure has fields that can vary with the architecture of the processor. Fields that precipitate the use of natural units include pointers and EFI INTN and UINTN data types. The size of one pointer or INTN/UINTN equals one natural unit. The natural units field in an index encoding is a count of the number of natural fields whose sizes (in bytes) must be added to determine a field offset.

As an example, assume that a given EBC instruction specifies a 16-bit index of 0xA048. This breaks down into:

- Sign bit (bit 15) = 1 (negative offset)
- Bits assigned to natural units (w, bits 14-12) = 2. Multiply by index size in bytes =  $2 \times 2 = 4$  (A)
- c = bits 11-4 = 4
- n = bits 3-0 = 8

On a 32-bit machine, the offset is then calculated to be:

- Offset =  $(4 + 8 * 4) * -1 = -36$
- On a 64-bit machine, the offset is calculated to be:
- Offset =  $(4 + 8 * 8) * -1 = -68$

## 22.5 EBC Instruction Operands

The VM supports an EBC instruction set that performs data movement, data manipulation, branching, and other miscellaneous operations typical of a simple processor. Most instructions operate on two operands, and have the general form:

**INSTRUCTION Operand1, Operand2**

Typically, instruction operands will be one of the following:

- Direct
- Indirect
- Indirect with index
- Immediate

The following subsections explain these operands.

### 22.5.1 Direct Operands

When a direct operand is specified for an instruction, the data to operate upon is contained in one of the VM general-purpose registers **R0-R7**. Syntactically, an example of direct operand mode could be the [ADD](#) instruction:

**ADD64 R1, R2**

This form of the instruction utilizes two direct operands. For this particular instruction, the VM would take the contents of register **R2**, add it to the contents of register **R1**, and store the result in register **R1**.



## 22.5.2 Indirect Operands

When an indirect operand is specified, a VM register contains the address of the operand data. This is sometimes referred to as register indirect, and is indicated by prefixing the register operand with "@" Syntactically, an example of an indirect operand mode could be this form of the ADD instruction:

**ADD32 R1, @R2**

For this instruction, the VM would take the 32-bit value at the address specified in **R2**, add it to the contents of register **R1**, and store the result in register **R1**.

## 22.5.3 Indirect with Index Operands

When an indirect with index operand is specified, the address of the operand is computed by adding the contents of a register to a decoded natural index that is included in the instruction. Typically with indexed addressing, the base address will be loaded in the register and an index value will be used to indicate the offset relative to this base address. Indexed addressing takes the form

**@R<sub>1</sub> (+n,+c)**

where:

- **R<sub>1</sub>** is one of the general-purpose registers (**R0-R7**) which contains the base address
- **+n** is a count of the number of "natural" units offset. This portion of the total offset is computed at runtime as  $(n * \text{sizeof}(\text{VOID}^*))$
- **+c** is a byte offset to add to the natural offset to resolve the total offset

The values of **n** and **c** can be either positive or negative, though they must both have the same sign. These values get encoded in the indexes associated with EBC instructions as shown in [Table 146](#). Indexes can be 16-, 32-, or 64-bits wide depending on the instruction. An example of indirect with index syntax would be:

**ADD32 R1, @R2 (+1, +8)**

This instruction would take the address in register **R2**, add  $(8 + 1 * \text{sizeof}(\text{VOID}^*))$ , read the 32-bit value at the address, add the contents of **R1** to the value, and store the result back to **R1**.

## 22.5.4 Immediate Operands

Some instructions support an immediate operand, which is simply a value included in the instruction encoding. The immediate value may or may not be sign extended, depending on the particular instruction. One instruction that supports an immediate operand is [MOVI](#). An example usage of this instruction is:

**MOVI<sub>ww</sub> R1, 0x1234**

This instruction moves the immediate value 0x1234 directly into VM register **R1**. The immediate value is contained directly in the encoding for the MOVI instruction.

## 22.6 EBC Instruction Syntax

Most EBC instructions have one or more variations that modify the size of the instruction and/or the behavior of the instruction itself. These variations will typically modify an instruction in one or more of the following ways:

- The size of the data being operated upon
- The addressing mode for the operands
- The size of index or immediate data
- To represent these variations syntactically in this specification the following conventions are used:
  - Natural indexes are indicated with the “Index” keyword, and may take the form of “Index16,” “Index32,” or “Index64” to indicate the size of the index value supported. Sometimes the form Index16|32|64 is used here, which is simply a shorthand notation for Index16|Index32|Index64. A natural index is encoded per [Table 146](#) and is resolved at runtime.
  - Immediate values are indicated with the “Immed” keyword, and may take the form of “Immed16,” “Immed32,” or “Immed64” to indicate the size of the immediate value supported. The shorthand notation Immed16|32|64 is sometimes used when different size immediate values are supported.
  - Terms in brackets [ ] are required.
  - Terms in braces { } are optional.
  - Alternate terms are separated by a vertical bar |.
  - The form R<sub>1</sub> and R<sub>2</sub> represent Operand 1 register and Operand 2 register respectfully, and can typically be any VM general-purpose register **R0-R7**.
  - Within descriptions of the instructions, brackets [ ] enclosing a register and/or index indicate that the contents of the memory pointed to by the enclosed contents are used.

## 22.7 Instruction Encoding

Most EBC instructions take the form:

**INSTRUCTION R<sub>1</sub>, R<sub>2</sub> Index|Immed**

For those instructions that adhere to this form, the binary encoding for the instruction will typically consist of an opcode byte, followed by an operands byte, followed by two or more bytes of immediate or index data. Thus the instruction stream will be:

**(1 Byte Opcode) + (1 Byte Operands) + (Immediate data|Index data)**

### 22.7.1 Instruction Opcode Byte Encoding

The first byte of an instruction is the opcode byte, and an instruction’s actual opcode value consumes 6 bits of this byte. The remaining two bits will typically be used to indicate operand sizes and/or presence or absence of index or immediate data. [Table 148](#) defines the bits in the opcode byte for most instructions, and their usage.

**Table 148. Opcode Byte Encoding**

Bit	Sym	Description
6..7	Modifiers	One or more of: Index or immediate data present/absent Operand size Index or immediate data size
0..5	Op	Instruction opcode

For those instructions that use bit 7 to indicate the presence of an index or immediate data and bit 6 to indicate the size of the index or immediate data, if bit 7 is 0 (no immediate data), then bit 6 is ignored by the VM. Otherwise, unless otherwise specified for a given instruction, setting unused bits in the opcode byte results in an instruction encoding exception when the instruction is executed. Setting the modifiers field in the opcode byte to reserved values will also result in an instruction encoding exception.

## 22.7.2 Instruction Operands Byte Encoding

The second byte of most encoded instructions is an operand byte, which encodes the registers for the instruction operands and whether the operands are direct or indirect. [Table 149](#) defines the encoding for the operand byte for these instructions. Unless otherwise specified for a given instruction, setting unused bits in the operand byte results in an instruction encoding exception when the instruction is executed. Setting fields in the operand byte to reserved values will also result in an instruction encoding exception.

**Table 149. Operand Byte Encoding**

Bit	Description
7	0 = Operand 2 is direct 1 = Operand 2 is indirect
4..6	Operand 2 register
3	0 = Operand 1 is direct 1 = Operand 1 is indirect
0..2	Operand 1 register

## 22.7.3 Index/Immediate Data Encoding

Following the operand bytes for most instructions is the instruction's immediate data. The immediate data is, depending on the instruction and instruction encoding, either an unsigned or signed literal value, or an index encoded using natural encoding. In either case, the size of the immediate data is specified in the instruction encoding.

For most instructions, the index/immediate value in the instruction stream is interpreted as a signed immediate value if the register operand is direct. This immediate value is then added to the contents of the register to compute the instruction operand. If the register is indirect, then the data is usually interpreted as a natural index (see [Section 22.4](#)) and the computed index value is added to the contents of the register to get the address of the operand.

## 22.8 EBC Instruction Set

The following sections describe each of the EBC instructions in detail. Information includes an assembly-language syntax, a description of the instruction functionality, binary encoding, and any limitations or unique behaviors of the instruction.

## ADD

### Syntax

**ADD[32|64] {@}R<sub>1</sub>, {@}R<sub>2</sub> {Index16|Immed16}**

### Description

Adds two signed operands and stores the result to Operand 1. The operation can be performed on either 32-bit (ADD32) or 64-bit (ADD64) operands.

### Operation

**Operand 1 <= Operand 1 + Operand 2**

Table 150. ADD Instruction Encoding

BYTE	Description	
0	Bit	Description
	7	0 = Immediate/index absent 1 = Immediate/index present
	6	0 = 32-bit operation 1 = 64-bit operation
	0.5	Opcode = 0x0C
1	Bit	Description
	7	0 = Operand 2 direct 1 = Operand 2 indirect
	4..6	Operand 2
	3	0 = Operand 1 direct 1 = Operand 1 indirect
	0..2	Operand 1
2..3	Optional 16-bit immediate data/index	

### Behaviors and Restrictions

- If Operand 2 is indirect, then the immediate data is interpreted as an index and the Operand 2 value is fetched from memory as a signed value at address [R<sub>2</sub> + Index16].
- If Operand 2 is direct, then the immediate data is considered a signed immediate value and is added to the R<sub>2</sub> register contents such that Operand 2 = R<sub>2</sub> + Immed16.
- If the instruction is ADD32 and Operand 1 is direct, then the result is stored back to the Operand 1 register with the upper 32 bits cleared.

## AND

### Syntax

**AND[32|64] {@}R<sub>1</sub>, {@}R<sub>2</sub> {Index16|Immed16}**

### Description

Performs a logical AND operation on two operands and stores the result to Operand 1. The operation can be performed on either 32-bit (AND32) or 64-bit (AND64) operands.

### Operation

**Operand 1 <= Operand 1 AND Operand 2**

Table 151. AND Instruction Encoding

BYTE	Description	
0	Bit	Description
	7	0 = Immediate/index absent 1 = Immediate/index present
	6	0 = 32-bit operation 1 = 64-bit operation
	0.5	Opcode = 0x14
1	Bit	Description
	7	0 = Operand 2 direct 1 = Operand 2 indirect
	4..6	Operand 2
	3	0 = Operand 1 direct 1 = Operand 1 indirect
	0..2	Operand 1
2..3	Optional 16-bit immediate data/index	

### Behaviors and Restrictions

- If Operand 2 is indirect, then the immediate data is interpreted as an index, and the Operand 2 value is fetched from memory as an unsigned value at address [R<sub>2</sub> + Index16].
- If Operand 2 is direct, then the immediate data is considered a signed immediate value and is added to the register contents such that Operand 2 = R<sub>2</sub> + Immed16.
- If the instruction is AND32 and Operand 1 is direct, then the result is stored to the Operand 1 register with the upper 32 bits cleared.

## ASHR

### Syntax

**ASHR[32|64] {@}R<sub>1</sub>, {@}R<sub>2</sub> {Index16|Immed16}**

### Description

Performs an arithmetic right-shift of a signed 32-bit (ASHR32) or 64-bit (ASHR64) operand and stores the result back to Operand 1

### Operation

**Operand 1 <= Operand 1 SHIFT-RIGHT Operand 2**

Table 152. ASHR Instruction Encoding

BYTE	Description	
0	Bit	Description
	7	0 = Immediate/index absent 1 = Immediate/index present
	6	0 = 32-bit operation 1 = 64-bit operation
	0.5	Opcode = 0x19
1	Bit	Description
	7	0 = Operand 2 direct 1 = Operand 2 indirect
	4..6	Operand 2
	3	0 = Operand 1 direct 1 = Operand 1 indirect
	0..2	Operand 1
2..3	Optional 16-bit immediate data/index	

### Behaviors and Restrictions

- If Operand 2 is indirect, then the immediate data is interpreted as an index, and the Operand 2 value is fetched from memory as a signed value at address [R<sub>2</sub>+ Index16].
- If Operand 2 is direct, then the immediate data is considered a signed immediate value and is added to the register contents such that Operand 2 = R<sub>2</sub> + Immed16.
- If the instruction is ASHR32, and Operand 1 is direct, then the result is stored back to the Operand 1 register with the upper 32 bits cleared.

## BREAK

### Syntax

**BREAK** [break code]

### Description

The BREAK instruction is used to perform special processing by the VM. The break code specifies the functionality to perform.

**BREAK 0** – Runaway program break. This indicates that the VM is likely executing code from cleared memory. This results in a bad break exception.

**BREAK 1** – Get virtual machine version. This instruction returns the 64-bit virtual machine revision number in VM register **R7**. The encoding is shown in [Table 153](#) and [Table 154](#). A VM that conforms to this version of the specification should return a version number of 0x00010000.

**Table 153. VM Version Format**

Bits	Description
63-32	Reserved = 0
31..16	VM major version
15..0	VM minor version

**BREAK 3** – Debug breakpoint. Executing this instruction results in a debug break exception. If a debugger is attached or available, then it may halt execution of the image.

**BREAK 4** – System call. There are no system calls supported for use with this break code, so the VM will ignore the instruction and continue execution at the following instruction.

**BREAK 5** – Create thunk. This causes the interpreter to create a thunk for the EBC entry point whose 32-bit IP-relative offset is stored at the 64-bit address in VM register **R7**. The interpreter then replaces the contents of the memory location pointed to by **R7** to point to the newly created thunk. Since all EBC IP-relative offsets are relative to the next instruction or data object, the original offset is off by 4, so must be incremented by 4 to get the actual address of the entry point.

**BREAK 6** – Set compiler version. An EBC C compiler can insert this break instruction into an executable to set the compiler version used to build an EBC image. When the VM executes this instruction it takes the compiler version from register **R7** and may perform version compatibility checking. The compiler version number follows the same format as the VM version number returned by the BREAK 1 instruction.



**Table 154. BREAK Instruction Encoding**

Byte	Description
0	Opcode = 0x00
1	0 = Runaway program break 1 = Get virtual machine version 3 = Debug breakpoint 4 = System call 5 = Create thunk 6 = Set compiler version

### Behaviors and Restrictions

- Executing an undefined BREAK code results in a bad break exception.
- Executing BREAK 0 results in a bad break exception.

## CALL

### Syntax

**CALL32{EX}{a} {@}R<sub>1</sub> {Immed32|Index32}**

**CALL64{EX}{a} Immed64**

### Description

The CALL instruction pushes the address of the following instruction on the stack and jumps to a subroutine. The subroutine may be either EBC or native code, and may be to an absolute or **IP**-relative address. CALL32 is used to jump directly to EBC code within a given application, whereas CALLEX is used to jump to external code (either native or EBC), which requires thunking. Functionally, the CALL does the following:

```

R0 = R0 - 8;
PUSH64 ReturnAddress
if (Opcode.ImmedData64Bit) {
  if (Operands.EbcCall) {
    IP = Immed64;
  } else {
    NativeCall (Immed64);
  }
} else {
  if (Operand1 != R0) {
    Addr = Operand1;
  } else {
    Addr = Immed32;
  }
  if (Operands.EbcCall) {
    if (Operands.RelativeAddress) {
      IP += Addr + SizeOfThisInstruction;
    } else {
      IP = Addr
    }
  } else {
    if (Operands.RelativeAddress) {
      NativeCall (IP + Addr)
    } else {
      NativeCall (Addr)
    }
  }
}

```

## Operation

$R0 \leq R0 - 16$

$[R0] \leq IP + \text{SizeOfThisInstruction}$

$IP \leq IP + \text{SizeOfThisInstruction} + \text{Operand 1 (relative CALL)}$

$IP \leq \text{Operand 1 (absolute CALL)}$

Table 155. CALL Instruction Encoding

BYTE	Description	
0	Bit	Description
	7	0 = Immediate/index data absent 1 = Immediate/index data present
	6	0 = CALL32 with 32-bit immediate data/index if present 1 = CALL64 with 64-bit immediate data
	0..5	Opcode = 0x03

1	Bit	Description
	6..7	Reserved = 0
	5	0 = Call to EBC 1 = Call to native code
	4	0 = Absolute address 1 = Relative address
	3	0 = Operand 1 direct 1 = Operand 1 indirect
	0..2	Operand 1
2..5	Optional 32-bit index/immediate for CALL32	
2..9	Required 64-bit immediate data for CALL64	

## BEHAVIOR AND RESTRICTIONS

- For the CALL32 forms, if Operand 1 is indirect, then the immediate data is interpreted as an index, and the Operand 1 value is fetched from memory address  $[R_1 + \text{Index}32]$ .
- For the CALL32 forms, if Operand 1 is direct, then the immediate data is considered a signed immediate value and is added to the Operand 1 register contents such that  $\text{Operand 1} = R_1 + \text{Immed}32$ .
- For the CALLEX forms, the VM must fix up the stack pointer and execute a call to native code in a manner compatible with the native code such that the callee is able to access arguments passed on the VM stack..
- For the CALLEX forms, the value returned by the callee should be returned in **R7**.
- For the CALL64 forms, the Operand 1 fields are ignored.
- If  $\text{Byte}7:\text{Bit}6 = 1$  (CALL64), then  $\text{Byte}1:\text{Bit}4$  is assumed to be 0 (absolute address)
- For CALL32 forms, if Operand 1 register = **R0**, then the register operand is ignored and only the immediate data is used in the calculation of the call address.
- Prior to the call, the VM will decrement the stack pointer **R0** by 16 bytes, and store the 64-bit return address on the stack.
- Offsets for relative calls are relative to the address of the instruction following the CALL instruction.

## CMP

### Syntax

**CMP[32|64][eq|lte|gte|ulte|ugte] R<sub>1</sub>, {@}R<sub>2</sub> {Index16|Immed16}**

### Description

The CMP instruction is used to compare Operand 1 to Operand 2. Supported comparison modes are =, <=, >=, unsigned <=, and unsigned >=. The comparison size can be 32 bits (CMP32) or 64 bits (CMP64). The effect of this instruction is to set or clear the condition code bit in the **Flags** register per the comparison results. The operands are compared as signed values except for the CMPulte and CMPugte forms.

## Operation

**CMPEq: Flags.C <= (Operand 1 == Operand 2)**

**CMPLte: Flags.C <= (Operand 1 <= Operand 2)**

**CMPPgte: Flags.C <= (Operand 1 >= Operand 2)**

**CMPLulte: Flags.C <= (Operand 1 <= Operand 2) (unsigned)**

**CMPPulte: Flags.C <= (Operand 1 >= Operand 2) (unsigned)**

**Table 156. CMP Instruction Encoding**

BYTE	Description	
0	Bit	Description
	7	0 = Immediate/index data absent 1 = Immediate/index data present
	6	0 = 32-bit comparison 1 = 64-bit comparison
	0..5	Opcode 0x05 = CMPEq compare equal 0x06 = CMPLte compare signed less than/equal 0x07 = CMPPgte compare signed greater than/equal 0x08 = CMPLulte compare unsigned less than/equal 0x09 = CMPPulte compare unsigned greater than/equal
1	Bit	Description
	7	0 = Operand 2 direct 1 = Operand 2 indirect
	4..6	Operand 2
	3	Reserved = 0
	0..2	Operand 1
2..3	Optional 16-bit immediate data/index	

## Behaviors and Restrictions

- If Operand 2 is indirect, then the immediate data is interpreted as an index, and the Operand 2 value is fetched from memory address  $[R_2 + \text{Index}16]$ .
- If Operand 2 is direct, then the immediate data is considered a signed immediate value and is added to the register contents such that  $\text{Operand 2} = R_2 + \text{Immed}16$ .
- Only register direct is supported for Operand 1.

## CMPI

### Syntax

**CMPI[32|64]{w|d}[eq|lte|gte|ulte|ugte] {@}R<sub>1</sub> {Index16}, Immed16|Immed32**

### Description

Compares two operands, one of which is an immediate value, for =, <=, >=, unsigned <=, or unsigned >=, and sets or clears the condition flag bit in the **Flags** register accordingly. Comparisons can be performed on a 32-bit (CMPI32) or 64-bit (CMPI64) basis. The size of the immediate data can be either 16 bits (CMPIw) or 32 bits (CMPId).

## Operation

**CMPIeq:  $\text{Flags.C} \leftarrow (\text{Operand 1} == \text{Operand 2})$**

**CMPIlts:  $\text{Flags.C} \leftarrow (\text{Operand 1} <= \text{Operand 2})$**

**CMPIgts:  $\text{Flags.C} \leftarrow (\text{Operand 1} >= \text{Operand 2})$**

**CMPIults:  $\text{Flags.C} \leftarrow (\text{Operand 1} <= \text{Operand 2})$**

**CMPIugts:  $\text{Flags.C} \leftarrow (\text{Operand 1} >= \text{Operand 2})$**

**Table 157. CMPI Instruction Encoding**

BYTE	Description	
0	Bit	Description
	7	0 = 16-bit immediate data 1 = 32-bit immediate data
	6	0 = 32-bit comparison 1 = 64-bit comparison
	0..5	Opcode 0x2D = CMPIeq compare equal 0x2E = CMPIlts compare signed less than/equal 0x2F = CMPIgts compare signed greater than/equal 0x30 = CMPIults compare unsigned less than/equal 0x31 = CMPIugts compare unsigned greater than/equal
	1	Bit
1	5..7	Reserved = 0
	4	0 = Operand 1 index absent 1 = Operand 1 index present
	3	0 = Operand 1 direct 1 = Operand 1 indirect
	0..2	Operand 1
2..3	Optional 16-bit Operand 1 index	
2..3/4..5	16-bit immediate data	
2..5/4..7	32-bit immediate data	

## Behaviors and Restrictions

- The immediate data is fetched as a signed value.
- If the immediate data is smaller than the comparison size, then the immediate data is sign-extended appropriately.
- If Operand 1 is direct, and an Operand 1 index is specified, then an instruction encoding exception is generated.



## DIV

### Syntax

**DIV[32|64] {@}R<sub>1</sub>, {@}R<sub>2</sub> {Index16|Immed16}**

### Description

Performs a divide operation on two signed operands and stores the result to Operand 1. The operation can be performed on either 32-bit (DIV32) or 64-bit (DIV64) operands.

### Operation

**Operand 1 <= Operand 1 / Operand 2**

Table 158. DIV Instruction Encoding

BYTE	Description	
0	Bit	Description
	7	0 = Immediate/index absent 1 = Immediate/index present
	6	0 = 32-bit operation 1 = 64-bit operation
	0.5	Opcode = 0x10
1	Bit	Description
	7	0 = Operand 2 direct 1 = Operand 2 indirect
	4..6	Operand 2
	3	0 = Operand 1 direct 1 = Operand 1 indirect
	0..2	Operand 1
2..3	Optional 16-bit immediate data/index	

### Behaviors and Restrictions

- If Operand 2 is indirect, then the immediate data is interpreted as an index, and the Operand 2 value is fetched from memory as a signed value at address [R<sub>2</sub>+ Index16].
- If Operand 2 is direct, then the immediate data is considered a signed value and is added to the register contents such that Operand 2 = R<sub>2</sub> + Immed16
- If the instruction is DIV32 form, and Operand 1 is direct, then the upper 32 bits of the result are set to 0 before storing to the Operand 1 register.
- A divide-by-0 exception occurs if Operand 2 = 0.

## DIVU

### Syntax

**DIVU[32|64] {@}R<sub>1</sub>, {@}R<sub>2</sub> {Index16|Immed16}**

### Description

Performs a divide operation on two unsigned operands and stores the result to Operand 1. The operation can be performed on either 32-bit (DIVU32) or 64-bit (DIVU64) operands.

### Operation

**Operand 1 <= Operand 1 / Operand 2**

Table 159. DIVU Instruction Encoding

BYTE	Description	
0	Bit	Description
	7	0 = Immediate/index absent 1 = Immediate/index present
	6	0 = 32-bit operation 1 = 64-bit operation
	0..5	Opcode = 0x11
1	Bit	Description
	7	0 = Operand 2 direct 1 = Operand 2 indirect
	4..6	Operand 2
	3	0 = Operand 1 direct 1 = Operand 1 indirect
	0..2	Operand 1
2..3	Optional 16-bit immediate data/index	

### Behaviors and Restrictions

- If Operand 2 is indirect, then the immediate data is interpreted as an index, and the value is fetched from memory as an unsigned value at address  $[R_2 + \text{Index16}]$ .
- If Operand 2 is direct, then the immediate data is considered an unsigned value and is added to the Operand 2 register contents such that  $\text{Operand 2} = R_2 + \text{Immed16}$
- For the DIVU32 form, if Operand 1 is direct then the upper 32 bits of the result are set to 0 before storing back to the Operand 1 register.
- A divide-by-0 exception occurs if  $\text{Operand 2} = 0$ .

## EXTNDB

### Syntax

**EXTNDB[32|64] {@}R<sub>1</sub>, {@}R<sub>2</sub> {Index16|Immed16}**

### Description

Sign-extend a byte value and store the result to Operand 1. The byte can be signed extended to 32 bits (EXTNDB32) or 64 bits (EXTNDB64).

### Operation

**Operand 1 <= (sign extended) Operand 2**

**Table 160. EXTNDB Instruction Encoding**

BYTE	Description	
0	Bit	Description
	7	0 = Immediate/index absent 1 = Immediate/index present
	6	0 = 32-bit operation 1 = 64-bit operation
	0.5	Opcode = 0x1A
1	Bit	Description
	7	0 = Operand 2 direct 1 = Operand 2 indirect
	4..6	Operand 2
	3	0 = Operand 1 direct 1 = Operand 1 indirect
	0..2	Operand 1
2..3	Optional 16-bit immediate data/index	

### Behaviors and Restrictions

- If Operand 2 is indirect, then the immediate data is interpreted as an index, and the byte Operand 2 value is fetched from memory as a signed value at address [R<sub>2</sub> + Index16].
- If Operand 2 is direct, then the immediate data is considered a signed immediate value, is added to the signed-extended byte from the Operand 2 register, and the byte result is sign extended to 32 or 64 bits.
- If the instruction is EXTNDB32 and Operand 1 is direct, then the 32-bit result is stored in the Operand 1 register with the upper 32 bits cleared.

## EXTNDD

### Syntax

**EXTNDD[32|64] {@}R<sub>1</sub>, {@}R<sub>2</sub> {Index16|Immed16}**

### Description

Sign-extend a 32-bit Operand 2 value and store the result to Operand 1. The Operand 2 value can be extended to 32 bits (EXTNDD32) or 64 bits (EXTNDD64).

### Operation

**Operand 1 <= (sign extended) Operand 2**

**Table 161. EXTNDD Instruction Encoding**

BYTE	Description	
0	Bit	Description
	7	0 = Immediate/index absent 1 = Immediate/index present
	6	0 = 32-bit operation 1 = 64-bit operation
	0.5	Opcode = 0x1C
1	Bit	Description
	7	0 = Operand 2 direct 1 = Operand 2 indirect
	4..6	Operand 2
	3	0 = Operand 1 direct 1 = Operand 1 indirect
	0..2	Operand 1
2..3	Optional 16-bit immediate data/index	

### Behaviors and Restrictions

- If Operand 2 is indirect, then the immediate data is interpreted as an index, and the 32-bit value is fetched from memory as a signed value at address  $[R_2 + \text{Index16}]$ .
- If Operand 2 is direct, then the immediate data is considered a signed immediate value such that  $\text{Operand 2} = R_2 + \text{Immed16}$ , and the value is sign extended to 32 or 64 bits accordingly.
- If the instruction is EXTNDD32 and Operand 1 is direct, then the result is stored in the Operand 1 register with the upper 32 bits cleared.

## EXTNDW

### Syntax

**EXTNDW[32|64] {@}R<sub>1</sub>, {@}R<sub>2</sub> {Index16|Immed16}**

### Description

Sign-extend a 16-bit Operand 2 value and store the result back to Operand 1. The value can be signed extended to 32 bits (EXTNDW32) or 64 bits (EXTNDW64).

### Operation

**Operand 1 <= (sign extended) Operand 2**

Table 162. EXTNDW Instruction Encoding

BYTE	Description	
0	Bit	Description
	7	0 = Immediate/index absent 1 = Immediate/index present
	6	0 = 32-bit operation 1 = 64-bit operation
	0.5	Opcode = 0x1B
1	Bit	Description
	7	0 = Operand 2 direct 1 = Operand 2 indirect
	4..6	Operand 2
	3	0 = Operand 1 direct 1 = Operand 1 indirect
	0..2	Operand 1
2..3	Optional 16-bit immediate data/index	

### Behaviors and Restrictions

- If Operand 2 is indirect, then the immediate data is interpreted as an index, and the word value is fetched from memory as a signed value at address [R<sub>2</sub> + Index16].
- If Operand 2 is direct, then the immediate data is considered a signed immediate value such that Operand 2 = R<sub>2</sub> + Immed16, and the value is sign extended to 32 or 64 bits accordingly.
- If the instruction is EXTNDW32 and Operand 1 is direct, then the 32-bit result is stored in the Operand 1 register with the upper 32 bits cleared.

## JMP

### Syntax

**JMP32{cs|cc} {@}R<sub>1</sub> {Immed32|Index32}**

**JMP64{cs|cc} Immed64**

### Description

The JMP instruction is used to conditionally or unconditionally jump to a relative or absolute address and continue executing EBC instructions. The condition test is done using the condition bit in the VM **Flags** register. The JMP64 form only supports an immediate value that can be used for either a relative or absolute jump. The JMP32 form adds support for indirect addressing of the JMP offset or address. The JMP is implemented as:

```

if (ConditionMet) {
  if (Operand.RelativeJump) {
    IP += Operand1 + SizeOfThisInstruction;
  } else {
    IP = Operand1;
  }
}

```

## Operation

IP <= Operand 1 (absolute address)

IP <= IP + SizeOfThisInstruction + Operand 1 (relative address)

Table 163. JMP Instruction Encoding

Byte	Description	
0	Bit	Description
	7	0 = Immediate/index data absent 1 = Immediate/index data present
	6	0 = JMP32 1 = JMP64
	0..5	Opcode = 0x01
1	Bit	Description
	7	0 = Unconditional jump 1 = Conditional jump
	6	0 = Jump if <b>Flags.C</b> is clear (cc) 1 = Jump if <b>Flags.C</b> is set (cs)
	5	Reserved = 0
	4	0 = Absolute address 1 = Relative address
	3	0 = Operand 1 direct 1 = Operand 1 indirect
	0..2	Operand 1
2..5	Optional 32-bit immediate data/index for JMP32	
2..9	64-bit immediate data for JMP64	

## Behaviors and Restrictions

- Operand 1 fields are ignored for the JMP64 forms
- If the instruction is JMP32, and Operand 1 register = **R0**, then the register contents are assumed to be 0.
- If the instruction is JMP32, and Operand 1 is indirect, then the immediate data is interpreted as an index, and the jump offset or address is fetched as a 32-bit signed value from address [R<sub>1</sub> + Index32]

- If the instruction is JMP32, and Operand 1 is direct, then the immediate data is considered a signed immediate value such that  $\text{Operand 1} = R_1 + \text{Immed32}$
- If the jump is unconditional, then Byte1:Bit6 (condition) is ignored
- If the instruction is JMP64, and Byte0:Bit7 is clear (no immediate data), then an instruction encoding exception is generated.
- If the instruction is JMP32, and Operand 2 is indirect, then the Operand 2 value is read as a natural value from memory address  $[R_1 + \text{Index32}]$
- An alignment check exception is generated if the jump is taken and the target address is odd.



## JMP8

### Syntax

**JMP8{cs|cc} Immed8**

### Description

Conditionally or unconditionally jump to a relative offset and continue execution. The offset is a signed one-byte offset specified in the number of words. The offset is relative to the start of the following instruction.

### Operation

**$IP = IP + \text{SizeOfThisInstruction} + (\text{Immed8} * 2)$**

Table 164. JMP8 Instruction Encoding

BYTE	Description	
0	Bit	Description
	7	0 = Unconditional jump 1 = Conditional jump
	6	0 = Jump if <b>Flags.C</b> is clear (cc) 1 = Jump if <b>Flags.C</b> is set (cs)
	0..5	Opcode = 0x02
1	Immediate data (signed word offset)	

### Behaviors and Restrictions

- If the jump is unconditional, then Byte0:Bit6 (condition) is ignored

## LOADSP

### Syntax

**LOADSP [Flags], R<sub>2</sub>**

### Description

This instruction loads a VM dedicated register with the contents of a VM general-purpose register **R0-R7**. The dedicated register is specified by its index as shown in [Table 144](#).

### Operation

**Operand 1 <= R<sub>2</sub>**

Table 165. LOADSP Instruction Encoding

BYTE	Description	
0	Bit	Description
	6..7	Reserved = 0
	0..5	Opcode = 0x29
1	7	Reserved
	4..6	Operand 2 general purpose register
	3	Reserved
	0..2	Operand 1 dedicated register index

### Behaviors and Restrictions

- Attempting to load any register (Operand 1) other than the **Flags** register results in an instruction encoding exception.
- Specifying a reserved dedicated register index results in an instruction encoding exception.
- If Operand 1 is the **Flags** register, then reserved bits in the **Flags** register are not modified by this instruction.

## MOD

### Syntax

**MOD[32|64] {@}R<sub>1</sub>, {@}R<sub>2</sub> {Index16|Immed16}**

### Description

Perform a modulus on two signed 32-bit (MOD32) or 64-bit (MOD64) operands and store the result to Operand 1.

### Operation

**Operand 1 <= Operand 1 MOD Operand 2**

**Table 166. MOD Instruction Encoding**

BYTE	Description	
0	Bit	Description
	7	0 = Immediate/index absent 1 = Immediate/index present
	6	0 = 32-bit operation 1 = 64-bit operation
	0.5	Opcode = 0x12
1	Bit	Description
	7	0 = Operand 2 direct 1 = Operand 2 indirect
	4..6	Operand 2
	3	0 = Operand 1 direct 1 = Operand 1 indirect
	0..2	Operand 1
2..3	Optional 16-bit immediate data/index	

### Behaviors and Restrictions

- If Operand 2 is indirect, then the immediate data is interpreted as an index, and the Operand 2 value is fetched from memory as a signed value at address [R<sub>2</sub> + Index16].
- If Operand 2 is direct, then the immediate data is considered a signed immediate value such that Operand 2 = R<sub>2</sub> + Immed16, and the value is sign extended to 32 or 64 bits accordingly.
- If Operand 2 = 0, then a divide-by-zero exception is generated.

## MODU

### Syntax

**MODU[32|64] {@}R<sub>1</sub>, {@}R<sub>2</sub> {Index16|Immed16}**

### Description

Perform a modulus on two unsigned 32-bit (MODU32) or 64-bit (MODU64) operands and store the result to Operand 1.

### Operation

**Operand 1 <= Operand 1 MOD Operand 2**

Table 167. MODU Instruction Encoding

BYTE	Description	
0	Bit	Description
	7	0 = Immediate/index absent 1 = Immediate/index present
	6	0 = 32-bit operation 1 = 64-bit operation
	0.5	Opcode = 0x13
1	Bit	Description
	7	0 = Operand 2 direct 1 = Operand 2 indirect
	4..6	Operand 2
	3	0 = Operand 1 direct 1 = Operand 1 indirect
	0..2	Operand 1
2..3	Optional 16-bit immediate data/index	

### Behaviors and Restrictions

- If Operand 2 is indirect, then the immediate data is interpreted as an index, and the Operand 2 value is fetched from memory as an unsigned value at address [R<sub>2</sub> + Index16].
- If Operand 2 is direct, then the immediate data is considered an unsigned immediate value such that Operand 2 = R<sub>2</sub> + Immed16.
- If Operand 2 = 0, then a divide-by-zero exception is generated.

## MOV

### Syntax

**MOV[b|w|d|q]{w|d} {@}R<sub>1</sub> {Index16|32}, {@}R<sub>2</sub> {Index16|32}**

**MOVqq {@}R<sub>1</sub> {Index64}, {@}R<sub>2</sub> {Index64}**

### Description

This instruction moves data from Operand 2 to Operand 1. Both operands can be indexed, though both indexes are the same size. In the instruction syntax for the first form, the first variable character indicates the size of the data move, which can be 8 bits (b), 16 bits (w), 32 bits (d), or 64 bits (q). The optional character indicates the presence and size of the index value(s), which may be 16 bits (w) or 32 bits (d). The MOVqq instruction adds support for 64-bit indexes.

## Operation

**Operand 1 <= Operand 2**

**Table 168. MOV Instruction Encoding**

Byte	Description	
0	Bit	Description
	7	0 = Operand 1 index absent 1 = Operand 1 index present
	6	0 = Operand 2 index absent 1 = Operand 2 index present
	0..5	0x1D = MOVbw opcode 0x1E = MOVww opcode 0x1F = MOVdw opcode 0x20 = MOVqw opcode 0x21 = MOVbd opcode 0x22 = MOVwd opcode 0x23 = MOVdd opcode 0x24 = MOVqd opcode 0x28 = MOVqq opcode
1	Bit	Description
	7	0 = Operand 2 direct 1 = Operand 2 indirect
	4..6	Operand 2
	3	0 = Operand 1 direct 1 = Operand 1 indirect
	0..2	Operand 1
2..3	Optional Operand 1 16-bit index	
2..3/4..5	Optional Operand 2 16-bit index	
2..5	Optional Operand 1 32-bit index	
2..5/6..9	Optional Operand 2 32-bit index	
2..9	Optional Operand 1 64-bit index (MOVqq)	
2..9/10..17	Optional Operand 2 64-bit index (MOVqq)	

## Behaviors and Restrictions

- If an index is specified for Operand 1, and Operand 1 is direct, then an instruction encoding exception is generated.

## MOVI

### Syntax

**MOVI**[b|w|d|q][w|d|q] {@}R<sub>1</sub> {Index16}, Immed16|32|64

### Description

This instruction moves a signed immediate value to Operand 1. In the instruction syntax, the first variable character specifies the width of the move, which may be 8 bits (b), 16 bits (w), 32-bits (d), or 64 bits (q). The second variable character specifies the width of the immediate data, which may be 16 bits (w), 32 bits (d), or 64 bits (q).

### Operation

**Operand 1 <= Operand 2**

Table 169. MOVI Instruction Encoding

BYTE	Description	
0	Bit	Description
	6..7	0 = Reserved 1 = Immediate data is 16 bits (w) 2 = Immediate data is 32 bits (d) 3 = Immediate data is 64 bits (q)
	0..5	Opcode = 0x37
1	Bit	Description
	7	Reserved = 0
	6	0 = Operand 1 index absent 1 = Operand 1 index present
	4..5	0 = 8 bit (b) move 1 = 16 bit (w) move 2 = 32 bit (d) move 3 = 64 bit (q) move
	3	0 = Operand 1 direct 1 = Operand 1 indirect
	0..2	Operand 1
2..3	Optional 16-bit index	
2..3/4..5	16-bit immediate data	
2..5/4..7	32-bit immediate data	
2..9/4..11	64-bit immediate data	

### Behaviors and Restrictions

- Specifying an index value with Operand 1 direct results in an instruction encoding exception.
- If the immediate data is smaller than the move size, then the value is sign-extended to the width of the move.

- If Operand 1 is a register, then the value is stored to the register with bits beyond the move size cleared.



## MOVIn

### Syntax

**MOVIn[w|d|q] {@}R<sub>1</sub> {Index16}, Index16|32|64**

### Description

This instruction moves an indexed value of form (+n,+c) to Operand 1. The index value is converted from (+n, +c) format to a signed offset per the encoding described in [Table 146](#). The size of the Operand 2 index data can be 16 (w), 32 (d), or 64 (q) bits.

### Operation

**Operand 1 <= Operand 2 (index value)**

Table 170. MOVIn Instruction Encoding

BYTE	Description	
0	Bit	Description
	6..7	0 = Reserved 1 = Operand 2 index value is 16 bits (w) 2 = Operand 2 index value is 32 bits (d) 3 = Operand 2 index value is 64 bits (q)
	0..5	Opcode = 0x38
1	Bit	Description
	7	Reserved
	6	0 = Operand 1 index absent 1 = Operand 1 index present
	4..5	Reserved = 0
	3	0 = Operand 1 direct 1 = Operand 1 indirect
	0..2	Operand 1
2..3	Optional 16-bit Operand 1 index	
2..3/4..5	16-bit Operand 2 index	
2..5/4..7	32-bit Operand 2 index	
2..9/4..11	64-bit Operand 2 index	

### Behaviors and Restrictions

- Specifying an Operand 1 index when Operand 1 is direct results in an instruction encoding exception.
- The Operand 2 index is sign extended to the size of the move if necessary.
- If the Operand 2 index size is smaller than the move size, then the value is truncated.
- If Operand 1 is direct, then the Operand 2 value is sign extended to 64 bits and stored to the Operand 1 register.

## MOVn

### Syntax

**MOVn{w|d} {@}R<sub>1</sub> {Index16|32}, {@}R<sub>2</sub> {Index16|32}**

### Description

This instruction loads an unsigned natural value from Operand 2 and stores the value to Operand 1. Both operands can be indexed, though both operand indexes are the same size. The operand index(s) can be 16 bits (w) or 32 bits (d).

### Operation

**Operand1 <= (UINTN)Operand2**

Table 171. MOVn Instruction Encoding

BYTE	Description	
0	Bit	Description
	7	0 = Operand 1 index absent 1 = Operand 1 index present
	6	0 = Operand 2 index absent 1 = Operand 2 index present
	0..5	0x32 = MOVnw opcode 0x33 = MOVnd opcode
1	Bit	Description
	7	0 = Operand 2 direct 1 = Operand 2 indirect
	4..6	Operand 2
	3	0 = Operand 1 direct 1 = Operand 1 indirect
	0..2	Operand 1
2..3	Optional Operand 1 16-bit index	
2..3/4..5	Optional Operand 2 16-bit index	
2..5	Optional Operand 1 32-bit index	
2..5/6..9	Optional Operand 2 32-bit index	

### Behaviors and Restrictions

- If an index is specified for Operand 2, and Operand 2 register is direct, then the Operand 2 index value is added to the register contents such that Operand 2 = (UINTN)(R<sub>2</sub> + Index).
- If an index is specified for Operand 1, and Operand 1 is direct, then an instruction encoding exception is generated.
- If Operand 1 is direct, then the Operand 2 value will be 0-extended to 64 bits on a 32-bit machine before storing to the Operand 1 register.

## MOVREL

### Syntax

**MOVREL[w|d|q] {@}R<sub>1</sub> {Index16}, Immed16|32|64**

### Description

This instruction fetches data at an **IP**-relative immediate offset (Operand 2) and stores the result to Operand 1. The offset is a signed offset relative to the following instruction. The fetched data is unsigned and may be 16 (w), 32 (d), or 64 (q) bits in size.

### Operation

**Operand 1 <= [IP + SizeOfThisInstruction + Immed]**

Table 172. MOVREL Instruction Encoding

BYTE	Description	
0	Bit	Description
	6..7	0 = Reserved 1 = Immediate data is 16 bits (w) 2 = Immediate data is 32 bits (d) 3 = Immediate data is 64 bits (q)
	0..5	Opcode = 0x39
1	Bit	Description
	7	Reserved = 0
	6	0 = Operand 1 index absent 1 = Operand 1 index present
	4..5	Reserved = 0
	3	0 = Operand 1 direct 1 = Operand 1 indirect
	0..2	Operand 1
2..3	Optional 16-bit Operand 1 index	
2..3/4..5	16-bit immediate offset	
2..5/4..7	32-bit immediate offset	
2..9/4..11	64-bit immediate offset	

### Behaviors and Restrictions

- If an Operand 1 index is specified and Operand 1 is direct, then an instruction encoding exception is generated.

## MOVsn

### Syntax

**MOVsn{w} {@}R<sub>1</sub>, {Index16}, {@}R<sub>2</sub> {Index16|Immed16}**

**MOVsn{d} {@}R<sub>1</sub> {Index32}, {@}R<sub>2</sub> {Index32|Immed32}**

### Description

Moves a signed natural value from Operand 2 to Operand 1. Both operands can be indexed, though the indexes are the same size. Indexes can be either 16 bits (MOVsnw) or 32 bits (MOVsnd) in size.

### Operation

**Operand 1 <= Operand 2**

Table 173. MOVsn Instruction Encoding

BYTE	Description	
0	Bit	Description
	7	0 = Operand 1 index absent 1 = Operand 1 index present
	6	0 = Operand 2 index/immediate data absent 1 = Operand 2 index/immediate data present
	0..5	0x25 = MOVsnw opcode 0x26 = MOVsnd opcode
1	Bit	Description
	7	0 = Operand 2 direct 1 = Operand 2 indirect
	4..6	Operand 2
	3	0 = Operand 1 direct 1 = Operand 1 indirect
	0..2	Operand 1
2..3	Optional 16-bit Operand 1 index (MOVsnw)	
2..3/4..5	Optional 16-bit Operand 2 index (MOVsnw)	
2..5	Optional 32-bit Operand 1 index/immediate data (MOVsnd)	
2..5/6..9	Optional 32-bit Operand 2 index/immediate data (MOVsnd)	

### Behaviors and Restrictions

- If Operand 2 is direct, and Operand 2 index/immediate data is specified, then the immediate value is read as a signed immediate value and is added to the contents of Operand 2 register such that  $\text{Operand 2} = R_2 + \text{Immed}$ .
- If Operand 2 is indirect, and Operand 2 index/immediate data is specified, then the immediate data is interpreted as an index and the Operand 2 value is fetched from memory as a signed value at address  $[R_2 + \text{Index16}]$ .

- If an index is specified for Operand 1, and Operand 1 is direct, then an instruction encoding exception is generated.
- If Operand 1 is direct, then the Operand 2 value is sign-extended to 64-bits on 32-bit native machines.

## MUL

### Syntax

**MUL[32|64] {@}R<sub>1</sub>, {@}R<sub>2</sub> {Index16|Immed16}**

### Description

Perform a signed multiply of two operands and store the result back to Operand 1. The operands can be either 32 bits (MUL32) or 64 bits (MUL64).

### Operation

**Operand 1 <= Operand \* Operand 2**

Table 174. MUL Instruction Encoding

BYTE	Description	
0	Bit	Description
	7	0 = Operand 2 immediate/index absent 1 = Operand 2 immediate/index present
	6	0 = 32-bit operation 1 = 64-bit operation
	0..5	Opcode = 0x0E
1	Bit	Description
	7	0 = Operand 2 direct 1 = Operand 2 indirect
	4..6	Operand 2
	3	0 = Operand 1 direct 1 = Operand 1 indirect
	0..2	Operand 1
2..3	Optional 16-bit Operand 2 immediate data/index	

### Behaviors and Restrictions

- If Operand 2 is indirect, then the immediate data is interpreted as an index, and the Operand 2 value is fetched from memory as a signed value at address  $[R_2 + \text{Index16}]$ .
- If Operand 2 is direct, then the immediate data is considered a signed immediate value and is added to the Operand 2 register contents such that  $\text{Operand 2} = R_2 + \text{Immed16}$ .
- If the instruction is MUL32, and Operand 1 is direct, then the result is stored to Operand 1 register with the upper 32 bits cleared.

## MULU

### Syntax

**MULU[32|64] {@}R<sub>1</sub>, {@}R<sub>2</sub> {Index16|Immed16}**

### Description

Performs an unsigned multiply of two 32-bit (MULU32) or 64-bit (MULU64) operands, and stores the result back to Operand 1.

### Operation

**Operand 1 <= Operand \* Operand 2**

Table 175. MULU Instruction Encoding

BYTE	Description	
0	Bit	Description
	7	0 = Operand 2 immediate/index absent 1 = Operand 2 immediate/index present
	6	0 = 32-bit operation 1 = 64-bit operation
	0.5	Opcode = 0x0F
1	Bit	Description
	7	0 = Operand 2 direct 1 = Operand 2 indirect
	4..6	Operand 2
	3	0 = Operand 1 direct 1 = Operand 1 indirect
	0..2	Operand 1
2..3	Optional 16-bit immediate data/index	

### Behaviors and Restrictions

- If Operand 2 is indirect, then the immediate data is interpreted as an index, and the Operand 2 value is fetched from memory as an unsigned value at address [R<sub>2</sub> + Index16].
- If Operand 2 is direct, then the immediate data is considered a signed immediate value and is added to the Operand 2 register contents such that Operand 2 = R<sub>2</sub> + Immed16.
- If the instruction is MULU32 and Operand 1 is direct, then the result is written to the Operand 1 register with the upper 32 bits cleared.

## NEG

### Syntax

**NEG[32|64] {@}R<sub>1</sub>, {@}R<sub>2</sub> {Index16|Immed16}**

### Description

Multiply Operand 2 by negative 1, and store the result back to Operand 1. Operand 2 is a signed value and fetched as either a 32-bit (NEG32) or 64-bit (NEG64) value.

### Operation

**Operand 1 <= -1 \* Operand 2**

**Table 176. NEG Instruction Encoding**

BYTE	Description	
0	Bit	Description
	7	0 = Operand 2 immediate/index absent 1 = Operand 2 immediate/index present
	6	0 = 32-bit operation 1 = 64-bit operation
	0.5	Opcode = 0x0B
1	Bit	Description
	7	0 = Operand 2 direct 1 = Operand 2 indirect
	4..6	Operand 2
	3	0 = Operand 1 direct 1 = Operand 1 indirect
	0..2	Operand 1
2..3	Optional 16-bit immediate data/index	

### Behaviors and Restrictions

- If Operand 2 is indirect, then the immediate data is interpreted as an index, and the Operand 2 value is fetched from memory as a signed value at address [R<sub>2</sub> + Index16].
- If Operand 2 is direct, then the immediate data is considered a signed immediate value and is added to the Operand 2 register contents such that Operand 2 = R<sub>2</sub> + Immed16.
- If the instruction is NEG32 and Operand 1 is direct, then the result is stored in Operand 1 register with the upper 32-bits cleared.



## NOT

### Syntax

**NOT**[32|64] {@}R<sub>1</sub>, {@}R<sub>2</sub> {Index16|Immed16}

### Description

Performs a logical NOT operation on Operand 2, an unsigned 32-bit (NOT32) or 64-bit (NOT64) value, and stores the result back to Operand 1.

### Operation

**Operand 1 <= NOT Operand 2**

Table 177. NOT Instruction Encoding

BYTE	Description	
0	Bit	Description
	7	0 = Operand 2 immediate/index absent 1 = Operand 2 immediate/index present
	6	0 = 32-bit operation 1 = 64-bit operation
	0.5	Opcode = 0x0A
1	Bit	Description
	7	0 = Operand 2 direct 1 = Operand 2 indirect
	4..6	Operand 2
	3	0 = Operand 1 direct 1 = Operand 1 indirect
	0..2	Operand 1
2..3	Optional 16-bit immediate data/index	

### Behaviors and Restrictions

- If Operand 2 is indirect, then the immediate data is interpreted as an index, and the Operand 2 value is fetched from memory as an unsigned value at address [R<sub>2</sub> + Index16].
- If Operand 2 is direct, then the immediate data is considered a signed immediate value and is added to the Operand 2 register contents such that Operand 2 = R<sub>2</sub> + Immed16.
- If the instruction is NOT32 and Operand 1 is a register, then the result is stored in the Operand 1 register with the upper 32 bits cleared.

## OR

### Syntax

**OR[32|64] {@}R<sub>1</sub>, {@}R<sub>2</sub> {Index16|Immed16}**

### Description

Performs a bit-wise OR of two 32-bit (OR32) or 64-bit (OR64) operands, and stores the result back to Operand 1.

### Operation

**Operand 1 <= Operand 1 OR Operand 2**

**Table 178. OR Instruction Encoding**

BYTE	Description	
0	Bit	Description
	7	0 = Operand 2 immediate/index absent 1 = Operand 2 immediate/index present
	6	0 = 32-bit operation 1 = 64-bit operation
	0.5	Opcode = 0x15
1	Bit	Description
	7	0 = Operand 2 direct 1 = Operand 2 indirect
	4..6	Operand 2
	3	0 = Operand 1 direct 1 = Operand 1 indirect
	0..2	Operand 1
2..3	Optional 16-bit immediate data/index	

### Behaviors and Restrictions

- If Operand 2 is indirect, then the immediate data is interpreted as an index, and the Operand 2 value is fetched from memory as an unsigned value at address [R<sub>2</sub> + Index16].
- If Operand 2 is direct, then the immediate data is considered a signed immediate value and is added to the Operand 2 register contents such that Operand 2 = R<sub>2</sub> + Immed16.
- If the instruction is OR32 and Operand 1 is direct, then the result is stored to Operand 1 register with the upper 32 bits cleared.

## POP

### Syntax

**POP[32|64] {@}R<sub>1</sub> {Index16|Immed16}**

### Description

This instruction pops a 32-bit (POP32) or 64-bit (POP64) value from the stack, stores the result to Operand 1, and adjusts the stack pointer **R0** accordingly.

### Operation

**Operand 1 <= [R0]**

**R0 <= R0 + 4 (POP32)**

**R0 <= R0 + 8 (POP64)**

Table 179. POP Instruction Encoding

BYTE	Description	
0	Bit	Description
	7	0 = Immediate/index absent 1 = Immediate/index present
	6	0 = 32-bit operation 1 = 64-bit operation
	0..5	Opcode = 0x2C
1	Bit	Description
	7..4	Reserved = 0
	3	0 = Operand 1 direct 1 = Operand 1 indirect
	0..2	Operand 1
2..3	Optional 16-bit immediate data/index	

### Behaviors and Restrictions

- If Operand 1 is direct, and an index/immediate data is specified, then the immediate data is read as a signed value and is added to the value popped from the stack, and the result stored to the Operand 1 register.
- If Operand 1 is indirect, then the immediate data is interpreted as an index, and the value popped from the stack is stored to address [R<sub>1</sub> + Index16].
- If the instruction is POP32, and Operand 1 is direct, then the popped value is sign-extended to 64 bits before storing to the Operand 1 register.

## POPn

### Syntax

**POPn {@}R<sub>1</sub> {Index16|Immed16}**

### Description

Read an unsigned natural value from memory pointed to by stack pointer **R0**, adjust the stack pointer accordingly, and store the value back to Operand 1.

### Operation

**Operand 1 <= (UINTN)[R0]**

**R0 <= R0 + sizeof (VOID \*)**

Table 180. POPn Instruction Encoding

BYTE	Description	
0	Bit	Description
	7	0 = Immediate/index absent 1 = Immediate/index present
	6	Reserved = 0
	0..5	Opcode = 0x36
1	Bit	Description
	7..4	Reserved = 0
	3	0 = Operand 1 direct 1 = Operand 1 indirect
	0..2	Operand 1
2..3	Optional 16-bit immediate data/index	

### Behaviors and Restrictions

- If Operand 1 is direct, and an index/immediate data is specified, then the immediate data is fetched as a signed value and is added to the value popped from the stack and the result is stored back to the Operand 1 register.
- If Operand 1 is indirect, and an index/immediate data is specified, then the immediate data is interpreted as a natural index and the value popped from the stack is stored at [R<sub>1</sub> + Index16].
- If Operand 1 is direct, and the instruction is executed on a 32-bit machine, then the result is stored to the Operand 1 register with the upper 32 bits cleared.

## PUSH

### Syntax

**PUSH[32|64] {@}R<sub>1</sub> {Index16|Immed16}**

### Description

Adjust the stack pointer **R0** and store a 32-bit (PUSH32) or 64-bit (PUSH64) Operand 1 value on the stack.

### Operation

**R0 <= R0 - 4 (PUSH32)**

**R0 <= R0 - 8 (PUSH64)**

**[R0] <= Operand 1**

Table 181. PUSH Instruction Encoding

BYTE	Description	
0	Bit	Description
	7	0 = Immediate/index absent 1 = Immediate/index present
	6	0 = 32-bit operation 1 = 64-bit operation
	0..5	Opcode = 0x2B
1	Bit	Description
	7..4	Reserved = 0
	3	0 = Operand 1 direct 1 = Operand 1 indirect
	0..2	Operand 1
2..3	Optional 16-bit immediate data/index	

### Behaviors and Restrictions

- If Operand 1 is direct, and an index/immediate data is specified, then the immediate data is read as a signed value and is added to the Operand 1 register contents such that  $\text{Operand 1} = R_1 + \text{Immed16}$ .
- If Operand 1 is indirect, and an index/immediate data is specified, then the immediate data is interpreted as a natural index and the pushed value is read from  $[R_1 + \text{Index16}]$ .

## PUSHn

### Syntax

**PUSHn** {@}R<sub>1</sub> {Index16|Immed16}

### Description

Adjust the stack pointer **R0**, and store a natural value on the stack.

### Operation

**R0** <= **R0** - sizeof (VOID \*)  
**[R0]** <= Operand 1

Table 182. PUSHn Instruction Encoding

BYTE	Description	
0	Bit	Description
	7	0 = Immediate/index absent 1 = Immediate/index present
	6	Reserved = 0
	0..5	Opcode = 0x35
1	Bit	Description
	7..4	Reserved = 0
	3	0 = Operand 1 direct 1 = Operand 1 indirect
	0..2	Operand 1
2..3	Optional 16-bit immediate data/index	

### Behaviors and Restrictions

- If Operand 1 is direct, and an index/immediate data is specified, then the immediate data is fetched as a signed value and is added to the Operand 1 register contents such that Operand 1 = R<sub>1</sub> + Immed16.
- If Operand 1 is indirect, and an index/immediate data is specified, then the immediate data is interpreted as a natural index and the Operand 1 value pushed is fetched from [R<sub>1</sub> + Index16].

## RET

### Syntax

**RET**

### Description

This instruction fetches the return address from the stack, sets the **IP** to the value, adjusts the stack pointer register **RO**, and continues execution at the return address. If the RET is a final return from the EBC driver, then execution control returns to the caller, which may be EBC or native code.

### Operation

**IP** <= [**R0**]

**RO** <= **RO** + 16

Table 183. RET Instruction Encoding

BYTE	Description	
0	Bit	Description
	6..7	Reserved = 0
	0..5	Opcode = 0x04
1	Reserved = 0	

### Behaviors and Restrictions

- An alignment exception will be generated if the return address is not aligned on a 16-bit boundary.

## SHL

### Syntax

**SHL[32|64] {@}R<sub>1</sub>, {@}R<sub>2</sub> {Index16|Immed16}**

### Description

Left-shifts Operand 1 by Operand 2 bit positions and stores the result back to Operand 1. The operand sizes may be either 32-bits (SHL32) or 64 bits (SHL64).

### Operation

**Operand 1 <= Operand 1 << Operand 2**

Table 184. SHL Instruction Encoding

BYTE	Description	
0	Bit	Description
	7	0 = Operand 2 immediate/index absent 1 = Operand 2 immediate/index present
	6	0 = 32-bit operation 1 = 64-bit operation
	0.5	Opcode = 0x17
1	Bit	Description
	7	0 = Operand 2 direct 1 = Operand 2 indirect
	4..6	Operand 2
	3	0 = Operand 1 direct 1 = Operand 1 indirect
	0..2	Operand 1
2..3	Optional 16-bit immediate data/index	

### Behaviors and Restrictions

- If Operand 2 is indirect, then the immediate data is interpreted as an index, and the Operand 2 value is fetched from memory as an unsigned value at address [R<sub>2</sub> + Index16].
- If Operand 2 is direct, then the immediate data is considered a signed immediate value and is added to the Operand 2 register contents such that Operand 2 = R<sub>2</sub> + Immed16.
- If the instruction is SHL32, and Operand 1 is direct, then the result is stored to the Operand 1 register with the upper 32 bits cleared.



## SHR

### Syntax

**SHR[32|64] {@}R<sub>1</sub>, {@}R<sub>2</sub> {Index16|Immed16}**

### Description

Right-shifts unsigned Operand 1 by Operand 2 bit positions and stores the result back to Operand 1. The operand sizes may be either 32-bits (SHR32) or 64 bits (SHR64).

### Operation

**Operand 1 <= Operand 1 >> Operand 2**

Table 185. SHR Instruction Encoding

BYTE	Description	
0	Bit	Description
	7	0 = Operand 2 immediate/index absent 1 = Operand 2 immediate/index present
	6	0 = 32-bit operation 1 = 64-bit operation
	0.5	Opcode = 0x18
1	Bit	Description
	7	0 = Operand 2 direct 1 = Operand 2 indirect
	4..6	Operand 2
	3	0 = Operand 1 direct 1 = Operand 1 indirect
	0..2	Operand 1
2..3	Optional 16-bit immediate data/index	

### Behaviors and Restrictions

- If Operand 2 is indirect, then the immediate data is interpreted as an index, and the Operand 2 value is fetched from memory as an unsigned value at address [R<sub>2</sub> + Index16].
- If Operand 2 is direct, then the immediate data is considered a signed immediate value and is added to the Operand 2 register contents such that Operand 2 = R<sub>2</sub> + Immed16.
- If the instruction is SHR32, and Operand 1 is direct, then the result is stored to the Operand 1 register with the upper 32 bits cleared.

## STORESP

### Syntax

**STORESP**  $R_1$ , [IP|Flags]

### Description

This instruction transfers the contents of a dedicated register to a general-purpose register. See [Table 144](#) for the VM dedicated registers and their corresponding index values.

### Operation

**Operand 1** <= **Operand 2**

Table 186. STORESP Instruction Encoding

BYTE	Description	
0	Bit	Description
	6..7	Reserved = 0
	0..5	Opcode = 0x2A
1	7	Reserved = 0
	4..6	Operand 2 dedicated register index
	3	Reserved = 0
	0..2	Operand 1 general purpose register

### Behaviors and Restrictions

- Specifying an invalid dedicated register index results in an instruction encoding exception.

## SUB

### Syntax

**SUB[32|64] {@}R<sub>1</sub>, {@}R<sub>2</sub> {Index16|Immed16}**

### Description

Subtracts a 32-bit (SUB32) or 64-bit (SUB64) signed Operand 2 value from a signed Operand 1 value of the same size, and stores the result to Operand 1.

### Operation

**Operand 1 <= Operand 1 - Operand 2**

Table 187. SUB Instruction Encoding

BYTE	Description	
0	Bit	Description
	7	0 = Operand 2 immediate/index absent 1 = Operand 2 immediate/index present
	6	0 = 32-bit operation 1 = 64-bit operation
	0.5	Opcode = 0x0D
1	Bit	Description
	7	0 = Operand 2 direct 1 = Operand 2 indirect
	4..6	Operand 2
	3	0 = Operand 1 direct 1 = Operand 1 indirect
	0..2	Operand 1
2..3	Optional 16-bit immediate data/index	

### Behaviors and Restrictions

- If Operand 2 is indirect, then the immediate data is interpreted as an index, and the Operand 2 value is fetched from memory as a signed value at address [R<sub>2</sub> + Index16].
- If Operand 2 is direct, then the immediate data is considered a signed immediate value and is added to the Operand 2 register contents such that Operand 2 = R<sub>2</sub> + Immed16.
- If the instruction is SUB32 and Operand 1 is direct, then the result is stored to the Operand 1 register with the upper 32 bits cleared.

## XOR

### Syntax

**XOR[32|64] {@}R<sub>1</sub>, {@}R<sub>2</sub> {Index16|Immed16}**

### Description

Performs a bit-wise exclusive OR of two 32-bit (XOR32) or 64-bit (XOR64) operands, and stores the result back to Operand 1.

### Operation

**Operand 1 <= Operand 1 XOR Operand 2**

Table 188. XOR Instruction Encoding

BYTE	Description	
0	Bit	Description
	7	0 = Operand 2 immediate/index absent 1 = Operand 2 immediate/index present
	6	0 = 32-bit operation 1 = 64-bit operation
	0.5	Opcode = 0x16
1	Bit	Description
	7	0 = Operand 2 direct 1 = Operand 2 indirect
	4..6	Operand 2
	3	0 = Operand 1 direct 1 = Operand 1 indirect
	0..2	Operand 1
2..3	Optional 16-bit immediate data/index	

### Behaviors and Restrictions

- If Operand 2 is indirect, then the immediate data is interpreted as an index, and the Operand 2 value is fetched from memory as an unsigned value at address [R<sub>2</sub> + Index16].
- If Operand 2 is direct, then the immediate data is considered a signed immediate value and is added to the Operand 2 register contents such that Operand 2 = R<sub>2</sub> + Immed16.
- If the instruction is XOR32 and Operand1 is direct, then the result is stored to the Operand 1 register with the upper 32-bits cleared.

## 22.9 Runtime and Software Conventions

### 22.9.1 Calling Outside VM

Calls can be made to routines in other modules that are native or in another VM. It is the responsibility of the calling VM to prepare the outgoing arguments correctly to make the call outside the VM. It is also the responsibility of the VM to prepare the incoming arguments correctly for the call from outside the VM. Calls outside the VM must use the [CALLEX](#) instruction.

### 22.9.2 Calling Inside VM

Calls inside VM can be made either directly using the [CALL](#) or [CALLEX](#) instructions. Using direct CALL instructions is an optimization.

### 22.9.3 Parameter Passing

Parameters are pushed on the VM stack per the CDECL calling convention. Per this convention, the last argument in the parameter list is pushed on the stack first, and the first argument in the parameter list is pushed on the stack last.

All parameters are stored or accessed as natural size (using naturally sized instruction) except 64-bit integers, which are pushed as 64-bit values. 32-bit integers are pushed as natural size (since they should be passed as 64-bit parameter values on 64-bit machines).

### 22.9.4 Return Values

Return values of 8 bytes or less in size are returned in general-purpose register **R7**. Return values larger than 8 bytes are not supported.

### 22.9.5 Binary Format

PE32+ format will be used for generating binaries for the VM. A VarBss section will be included in the binary image. All global and static variables will be placed in this section. The size of the section will be based on worst-case 64-bit pointers. Initialized data and pointers will also be placed in the VarBss section, with the compiler generating code to initialize the values at runtime.

## 22.10 Architectural Requirements

This section provides a high level overview of the architectural requirements that are necessary to support execution of EBC on a platform.

### 22.10.1 EBC Image Requirements

All EBC images will be PE32+ format. Some minor additions to the format will be required to support EBC images. See the *Microsoft Portable Executable and Common Object File Format Specification* pointed to in [Appendix O](#) for details of this image file format.

A given EBC image must be executable on different platforms, independent of whether it is a 32- or 64-bit processor. All EBC images should be driver implementations.

### 22.10.2 EBC Execution Interfacing Requirements

EBC drivers will typically be designed to execute in an (usually preboot) EFI environment. As such, EBC drivers must be able to invoke protocols and expose protocols for use by other drivers or applications. The following execution transitions must be supported:

- EBC calling EBC
- EBC calling native code
- Native code calling EBC
- Native code calling native code
- Returning from all the above transitions

Obviously native code calling native code is available by default, so is not discussed in this document.

To maintain backward compatibility with existing native code, and minimize the overhead for non-EBC drivers calling EBC protocols, all four transitions must be seamless from the application perspective. Therefore, drivers, whether EBC or native, shall not be required to have any knowledge of whether or not the calling code, or the code being called, is native or EBC compiled code. The onus is put on the tools and interpreter to support this requirement.

### 22.10.3 Interfacing Function Parameters Requirements

To allow code execution across protocol boundaries, the interpreter must ensure that parameters passed across execution transitions are handled in the same manner as the standard parameter passing convention for the native processor.

### 22.10.4 Function Return Requirements

The interpreter must support standard function returns to resume execution to the caller of external protocols. The details of this requirement are specific to the native processor. The called function must not be required to have any knowledge of whether or not the caller is EBC or native code.

### 22.10.5 Function Return Values Requirements

The interpreter must support standard function return values from called protocols. The exact implementation of this functionality is dependent on the native processor. This requirement applies to return values of 64 bits or less. The called function must not be required to have any knowledge of whether or not the caller is EBC or native code. Note that returning of structures is not supported.

## 22.11 EBC Interpreter Protocol

The EFI EBC protocol provides services to execute EBC images, which will typically be loaded into option ROMs.

### EFI\_EBC\_PROTOCOL

#### Summary

This protocol provides the services that allow execution of EBC images.

#### GUID

```
#define EFI_EBC_PROTOCOL_GUID \
{0x13ac6dd1,0x73d0,0x11d4,\
{0xb0,0x6b,0x00,0xaa,0x00,0xbd,0x6d,0xe7}}
```

#### Protocol Interface Structure

```
typedef struct _EFI_EBC_PROTOCOL {
  EFI_EBC_CREATE_THUNK      CreateThunk;
  EFI_EBC_UNLOAD_IMAGE      UnloadImage;
  EFI_EBC_REGISTER_ICACHE_FLUSH  RegisterICacheFlush;
  EFI_EBC_GET_VERSION        GetVersion;
} EFI_EBC_PROTOCOL;
```

#### Parameters

<i>CreateThunk</i>	Creates a thunk for an EBC image entry point or protocol service, and returns a pointer to the thunk. See the <a href="#">CreateThunk()</a> function description.
<i>UnloadImage</i>	Called when an EBC image is unloaded to allow the interpreter to perform any cleanup associated with the image's execution. See the <a href="#">UnloadImage()</a> function description.
<i>RegisterICacheFlush</i>	Called to register a callback function that the EBC interpreter can call to flush the processor instruction cache after creating thunks. See the <a href="#">RegisterICacheFlush()</a> function description.
<i>GetVersion</i>	Called to get the version of the associated EBC interpreter. See the <a href="#">GetVersion()</a> function description.

#### Description

The EFI EBC protocol provides services to load and execute EBC images, which will typically be loaded into option ROMs. The image loader will load the EBC image, perform standard relocations, and invoke the [CreateThunk\(\)](#) service to create a thunk for the EBC image's entry point. The image can then be run using the standard EFI start image services.

## EFI\_EBC\_PROTOCOL.CreateThunk()

### Summary

Creates a thunk for an EBC entry point, returning the address of the thunk.

### Prototype

```
typedef
EFI_STATUS
(EFI_API *EFI_EBC_CREATE_THUNK) (
  IN EFI_EBC_PROTOCOL *This,
  IN EFI_HANDLE ImageHandle,
  IN VOID *EbcEntryPoint,
  OUT VOID **Thunk
);
```

### Parameters

<i>This</i>	A pointer to the <a href="#">EFI_EBC_PROTOCOL</a> instance. This protocol is defined in <a href="#">Section 22.11</a> .
<i>ImageHandle</i>	Handle of image for which the thunk is being created.
<i>EbcEntryPoint</i>	Address of the actual EBC entry point or protocol service the thunk should call.
<i>Thunk</i>	Returned pointer to a thunk created.

### Description

A PE32+ EBC image, like any other PE32+ image, contains an optional header that specifies the entry point for image execution. However for EBC images this is the entry point of EBC instructions, so is not directly executable by the native processor. Therefore when an EBC image is loaded, the loader must call this service to get a pointer to native code (thunk) that can be executed which will invoke the interpreter to begin execution at the original EBC entry point.

### Status Codes Returned

EFI_SUCCESS	The function completed successfully.
EFI_INVALID_PARAMETER	Image entry point is not 2-byte aligned.
EFI_OUT_OF_RESOURCES	Memory could not be allocated for the thunk.



## EFI\_EBC\_PROTOCOL.UnloadImage()

### Summary

Called prior to unloading an EBC image from memory.

### Prototype

```
typedef
EFI_STATUS
(EFI_API *EFI_EBC_UNLOAD_IMAGE) (
  IN EFI_EBC_PROTOCOL  *This,
  IN EFI_HANDLE        ImageHandle
);
```

### Parameters

*This*

A pointer to the [EFI EBC PROTOCOL](#) instance. This protocol is defined in [Section 22.11](#).

*ImageHandle*

Image handle of the EBC image that is being unloaded from memory.

### Description

This function is called after an EBC image has exited, but before the image is actually unloaded. It is intended to provide the interpreter with the opportunity to perform any cleanup that may be necessary as a result of loading and executing the image.

### Status Codes Returned

EFI_SUCCESS	The function completed successfully.
EFI_INVALID_PARAMETER	Image handle is not recognized as belonging to an EBC image that has been executed.

## EFI\_EBC\_PROTOCOL.RegisterICacheFlush()

### Summary

Registers a callback function that the EBC interpreter calls to flush the processor instruction cache following creation of thunks.

### Prototype

```
typedef
EFI_STATUS
(* EFI_EBC_REGISTER_ICACHE_FLUSH) (
    IN EFI_EBC_PROTOCOL    *This,
    IN EBC_ICACHE_FLUSH    Flush
);
```

### Parameters

<i>This</i>	A pointer to the <a href="#">EFI_EBC_PROTOCOL</a> instance. This protocol is defined in <a href="#">Section 22.11</a> .
<i>Flush</i>	Pointer to a function of type <a href="#">EBC_ICACH_FLUSH</a> . See “Related Definitions” below for a detailed description of this type.

### Related Definitions

```
typedef
EFI_STATUS
(* EBC_ICACHE_FLUSH) (
    IN EFI_PHYSICAL_ADDRESS Start,
    IN UINT64                Length
);
```

*Start* The beginning physical address to flush from the processor’s instruction cache.

*Length* The number of bytes to flush from the processor’s instruction cache.

This is the prototype for the *Flush* callback routine. A pointer to a routine of this type is passed to the EBC [EFI\\_EBC\\_REGISTER\\_ICACHE\\_FLUSH](#) protocol service.

### Description

An EBC image’s original PE32+ entry point is not directly executable by the native processor. Therefore to execute an EBC image, a thunk (which invokes the EBC interpreter for the image’s original entry point) must be created for the entry point, and the thunk is executed when the EBC image is started. Since the thunks may be created on-the-fly in memory, the processor’s instruction cache may require to be flushed after thunks are created. The caller to this EBC service can provide a pointer to a function to flush the instruction cache for any thunks created after the [CreateThunk\(\)](#) service has been called. If an instruction-cache flush callback is not provided to the interpreter, then the

interpreter assumes the system has no instruction cache, or that flushing the cache is not required following creation of thunks.

### Status Codes Returned

EFI_SUCCESS	The function completed successfully.
-------------	--------------------------------------

## EFI\_EBC\_PROTOCOL.GetVersion()

### Summary

Called to get the version of the interpreter.

### Prototype

```
typedef
EFI_STATUS
(* EFI_EBC_GET_VERSION) (
  IN EFI_EBC_PROTOCOL *This,
  OUT UINT64 *Version
);
```

### Parameters

*This*

A pointer to the [EFI EBC PROTOCOL](#) instance. This protocol is defined in [Section 22.11](#).

*Version*

Pointer to where to store the returned version of the interpreter.

### Description

This function is called to get the version of the loaded EBC interpreter. The value and format of the returned version is identical to that returned by the EBC [BREAK 1](#) instruction.

### Status Codes Returned

EFI_SUCCESS	The function completed successfully.
EFI_INVALID_PARAMETER	Version pointer is <b>NULL</b> .

## 22.12 EBC Tools

### 22.12.1 EBC C Compiler

This section describes the responsibilities of the EBC C compiler. To fully specify these responsibilities requires that the thinking mechanisms between EBC and native code be described.

### 22.12.2 C Coding Convention

The EBC C compiler supports only the C programming language. There is no support for C++, inline assembly, floating point types/operations, or C calling conventions other than CDECL.

Pointer type in C is supported only as 64-bit pointer. The code should be 64-bit pointer ready (not assign pointers to integers and vice versa).

The compiler does not support user-defined sections through pragmas.

Global variables containing pointers that are initialized will be put in the uninitialized VarBss section and the compiler will generate code to initialize these variables during load time. The code will be placed in an init text section. This compiler-generated code will be executed before the actual image entry point is executed.

### 22.12.3 EBC Interface Assembly Instructions

The EBC instruction set includes two forms of a [CALL](#) instruction that can be used to invoke external protocols. Their assembly language formats are:

**CALLEX Immed64**  
**CALLEX32 {@}R<sub>1</sub> {Immed32}**

Both forms can be used to invoke external protocols at an absolute address specified by the immediate data and/or register operand. The second form also supports jumping to code at a relative address. When one of these instructions is executed, the interpreter is responsible for thunking arguments and then jumping to the destination address. When the called function returns, code begins execution at the EBC instruction following the CALL instruction. The process by which this happens is called thunking. Later sections describe this operation in detail.

### 22.12.4 Stack Maintenance and Argument Passing

There are several EBC assembly instructions that directly manipulate the stack contents and stack pointer. These instructions operate on the EBC stack, not the interpreter stack. The instructions include the EBC [PUSH](#), [POP](#), [PUSHn](#), and [POPn](#), and all forms of the [MOV](#) instructions.

These instructions must adjust the EBC stack pointer in the same manner as equivalent instructions of the native instruction set. With this implementation, parameters pushed on the stack by an EBC driver can be accessed normally for stack-based native code. If native code expects parameters in registers, then the interpreter thunking process must transfer the arguments from EBC stack to the appropriate processor registers. The process would need to be reversed when native code calls EBC.

### 22.12.5 Native to EBC Arguments Calling Convention

The calling convention for arguments passed to EBC functions follows the standard CDECL calling convention. The arguments must be pushed as their native size. After the function arguments have been pushed on the stack, execution is passed to the called EBC function. The overhead of thunking the function parameters depends on the standard parameter passing convention for the host processor. The implementation of this functionality is left to the interpreter.

### 22.12.6 EBC to Native Arguments Calling Convention

When EBC makes function calls via function pointers, the EBC C compiler cannot determine whether the calls are to native code or EBC. It therefore assumes that the calls are to native code, and emits the appropriate EBC [CALLEX](#) instructions. To be compatible with calls to native code, the calling convention of EBC calling native code must follow the

parameter passing convention of the native processor. The EBC C compiler generates EBC instructions that push all arguments on the stack. The interpreter is then responsible for performing the necessary thinking. The exact implementation of this functionality is left to the interpreter.

### 22.12.7 EBC to EBC Arguments Calling Convention

If the EBC C compiler is able to determine that a function call is to a local function, it can emit a standard EBC [CALL](#) instruction. In this case, the function arguments are passed as described in the other sections of this specification.

### 22.12.8 Function Returns

When EBC calls an external function, the thinking process includes setting up the host processor stack or registers such that when the called function returns, execution is passed back to the EBC at the instruction following the call. The implementation is left to the interpreter, but it must follow the standard function return process of the host processor. Typically this will require the interpreter to push the return address on the stack or move it to a processor register prior to calling the external function.

### 22.12.9 Function Return Values

EBC function return values of 8 bytes or less are returned in VM general-purpose register **R7**. Returning values larger than 8 bytes on the stack is not supported. Instead, the caller or callee must allocate memory for the return value, and the caller can pass a pointer to the callee, or the callee can return a pointer to the value in the standard return register **R7**.

If an EBC function returns to native code, then the interpreter thinking process is responsible for transferring the contents of **R7** to an appropriate location such that the caller has access to the value using standard native code. Typically the value will be transferred to a processor register. Conversely, if a native function returns to an EBC function, the interpreter is responsible for transferring the return value from the native return memory or register location into VM register **R7**.

### 22.12.10 Thinking

Thinking is the process by which transitions between execution of native and EBC are handled. The major issues that must be addressed for thinking are the handling of function arguments, how the external function is invoked, and how return values and function returns are handled. The following sections describe the thinking process for the possible transitions.

#### 22.12.10.1 Thinking EBC to Native Code

By definition, all external calls from within EBC are calls to native code. The EBC [CALLEX](#) instructions are used to make these calls. A typical application for EBC calling native code would be a simple "Hello World" driver. For a UEFI driver, the code could be written as shown below.

```

EFI_STATUS EfiMain (
    IN EFI_HANDLE  ImageHandle,
    IN EFI_SYSTEM_TABLE *ST
)
{
    ST->ConOut->OutputString(ST->ConOut, L"Hello World!");
    return EFI_SUCCESS;
}

```

This C code, when compiled to EBC assembly, could result in two [PUSHn](#) instructions to push the parameters on the stack, some code to get the absolute address of the [OutputString0](#) function, then a CALLEX instruction to jump to native code. Typical pseudo assembly code for the function call could be something like the following:

```

PUSHn    _HelloString
PUSHn    _ConOut
MOVnw    R1, _OutputString
CALLEX64R1

```

The interpreter is responsible for executing the PUSHn instructions to push the arguments on the EBC stack when interpreting the PUSHn instructions. When the CALLEX instruction is encountered, it must thunk to external native code. The exact thunking mechanism is native processor dependent. For example, a supported 32-bit thunking implementation could simply move the system stack pointer to point to the EBC stack, then perform a [CALL](#) to the absolute address specified in VM register **R1**. However, the function calling convention for the Itanium processor family calls for the first 8 function arguments being passed in registers. Therefore, the Itanium processor family thunking mechanism requires the arguments to be copied from the EBC stack into processor registers. Then a CALL can be performed to jump to the absolute address in VM register **R1**. Note that since the interpreter is not aware of the number of arguments to the function being called, the maximum amount of data may be copied from the EBC stack into processor registers.

### 22.12.10.2 Thunking Native Code to EBC

An EBC driver may install protocols for use by other EBC drivers, or UEFI drivers or applications. These protocols provide the mechanism by which external native code can call EBC. Typical C code to install a generic protocol is shown below.

```

EFI_STATUS Foo(UINT32 Arg1, UINT32 Arg2);

MyProtInterface->Service1= Foo;

Status = LibInstallProtocolInterfaces (&Handle, &MyProtGUID, MyProtInterface,
NULL);

```

To support thunking native code to EBC, the EBC compiler resolves all EBC function pointers using one level of indirection. In this way, the address of an EBC function actually becomes the address of a piece of native (thunk) code that invokes the interpreter to

execute the actual EBC function. As a result of this implementation, any time the address of an EBC function is taken, the EBC C compiler must generate the following:

- A 64-bit function pointer data object that contains the actual address of the EBC function
- EBC initialization code that is executed before the image entry point that will execute EBC **BREAK** 5 instructions to create thunks for each function pointer data object
- Associated relocations for the above

So for the above code sample, the compiler must generate EBC initialization code similar to the following. This code is executed prior to execution of the actual EBC driver's entry point.

```
MOVqq R7, Foo_pointer; get address of Foo pointer  
BREAK 5 ; create a thunk for the function
```

The **BREAK** instruction causes the interpreter to create native thunk code elsewhere in memory, and then modify the memory location pointed to by R7 to point to the newly created thunk code for EBC function Foo. From within EBC, when the address of Foo is taken, the address of the thunk is actually returned. So for the assignment of the protocol Service1 above, the EBC C compiler will generate something like the following:

```
MOVqq R7, Foo_pointer; get address of Foo function pointer  
MOVqq R7, @R7 ; one level of indirection  
MOVn R6, _MyProtInterface->Service1 ; get address of variable  
MOVqq @R6, R7 ; address of thunk to ->Service1
```

### 22.12.10.3 Thinking EBC to EBC

EBC can call EBC via function pointers or protocols. These two mechanisms are treated identically by the EBC C compiler, and are performed using EBC **CALLEX** instructions. For EBC to call EBC, the EBC being called must have provided the address of the function. As described above, the address is actually the address of native thunk code for the actual EBC function. Therefore, when EBC calls EBC, the interpreter assumes native code is being called so prepares function arguments accordingly, and then makes the call. The native thunk code assumes native code is calling EBC, so will basically “undo” the preparation of function arguments, and then invoke the interpreter to execute the actual EBC function of interest.

### 22.12.11 EBC Linker

New constants must be defined for use by the linker in processing EBC images. For EBC images, the linker must set the machine type in the PE file header accordingly to indicate that the image contains EBC.

```
#define IMAGE_FILE_MACHINE_EBC 0x0EBC
```

In addition, the linker must support EBC images with of the following subsystem types as set in a PE32+ optional header:



```
#define IMAGE_SUBSYSTEM_EFI_APPLICATION 10
#define IMAGE_SUBSYSTEM_EFI_BOOT_SERVICE_DRIVER 11
#define IMAGE_SUBSYSTEM_EFI_RUNTIME_DRIVER 12
```

For EFI EBC images and object files, the following relocation types must be supported:

```
// No relocations required
#define IMAGE_REL_EBC_ABSOLUTE 0x0000
// 32-bit address w/o image base
#define IMAGE_REL_EBC_ADDR32NB 0x0001
// 32-bit relative address from byte following relocs
#define IMAGE_REL_EBC_REL32 0x0002
// Section table index
#define IMAGE_REL_EBC_SECTION 0x0003
// Offset within section
#define IMAGE_REL_EBC_SECREL 0x0004
```

The ADDR32NB relocation is used internally to the linker when RVAs are emitted. It also is used for version resources which probably will not be used. The REL32 relocation is for PC relative addressing on code. The SECTION and SECREL relocations are used for debug information.

### 22.12.12 Image Loader

The EFI image loader is responsible for loading an executable image into memory and applying relocation information so that an image can execute at the address in memory where it has been loaded prior to execution of the image. For EBC images, the image loader must also invoke the interpreter protocol to create a thunk for the image entry point and return the address of this thunk. After loading the image in this manner, the image can be executed in the standard manner. To implement this functionality, only minor changes will be made to EFI service [EFI\\_BOOT\\_SERVICES.LoadImage\(\)](#), and no changes should be made to [EFI\\_BOOT\\_SERVICES.StartImage\(\)](#).

After the image is unloaded, the EFI image load service must call the EBC [EFI\\_BOOT\\_SERVICES.UnloadImage\(\)](#) service to perform any cleanup to complete unloading of the image. Typically this will include freeing up any memory allocated for thunks for the image during load and execution.

### 22.12.13 Debug Support

The interpreter must support debugging in an EFI environment per the EFI debug support protocol.

## 22.13 VM Exception Handling

This section lists the different types of exceptions that the VM may assert during execution of an EBC image. If a debugger is attached to the EBC driver via the EFI debug support protocol, then the debugger should be able to capture and identify the exception

type. If a debugger is not attached, then depending on the severity of the exception, the interpreter may do one of the following:

- Invoke the `EFI ASSERT()` macro, which will typically display an error message and halt the system
- Sit in a `while(1)` loop to hang the system
- Ignore the exception and continue execution of the image (minor exceptions only)

It is a platform policy decision as to the action taken in response to EBC exceptions. The following sections describe the exceptions that may be generated by the VM.

### 22.13.1 Divide By 0 Exception

A divide-by-0 exception can occur for the EBC instructions [DIV](#), [DIVU](#), [MOD](#), and [MODU](#).

### 22.13.2 Debug Break Exception

A debug break exception occurs if the VM encounters a [BREAK](#) instruction with a break code of 3.

### 22.13.3 Invalid Opcode Exception

An invalid opcode exception will occur if the interpreter encounters a reserved opcode during execution.

### 22.13.4 Stack Fault Exception

A stack fault exception can occur if the interpreter detects that function nesting within the interpreter or system interrupts was sufficient to potentially corrupt the EBC image's stack contents. This exception could also occur if the EBC driver attempts to adjust the stack pointer outside the range allocated to the driver.

### 22.13.5 Alignment Exception

An alignment exception can occur if the particular implementation of the interpreter does not support unaligned accesses to data or code. It may also occur if the stack pointer or instruction pointer becomes misaligned.

### 22.13.6 Instruction Encoding Exception

An instruction encoding exception can occur for the following:

- For some instructions, if an Operand 1 index is specified and Operand 1 is direct
- If an instruction encoding has reserved bits set to values other than 0
- If an instruction encoding has a field set to a reserved value.

### 22.13.7 Bad Break Exception

A bad break exception occurs if the VM encounters a [BREAK](#) instruction with a break code of 0, or any other unrecognized or unsupported break code.

### 22.13.8 Undefined Exception

An undefined exception can occur for other conditions detected by the VM. The cause of such an exception is dependent on the VM implementation, but will most likely include internal VM faults.

## 22.14 Option ROM Formats

The new option ROM capability is designed to be a departure from the legacy method of formatting an option ROM. PCI local bus add-in cards are the primary targets for this design although support for future bus types will be added as necessary. EFI EBC drivers can be stored in option ROMs or on hard drives in an EFI system partition.

The new format defined for the UEFI specification is intended to coexist with legacy format PCI Expansion ROM images. This provides the ability for IHVs to make a single option ROM binary that contains both legacy and new format images at the same time. This is important for the ability to have single add-in card SKUs that can work in a variety of systems both with and without native support for UEFI. Support for multiple image types in this way provides a smooth migration path during the period before widespread adoption of UEFI drivers as the primary means of support for software needed to accomplish add-in card operation in the pre-OS boot timeframe.

### 22.14.1 EFI Drivers for PCI Add-in Cards

The location mechanism for UEFI drivers in PCI option ROM containers is described fully in [Section 11.3](#). Readers should refer to this section for complete details of the scheme and associated data structures.

### 22.14.2 Non-PCI Bus Support

EFI expansion ROMs are not supported on any other bus besides PCI local bus in the current revision of the UEFI specification.

This means that support for UEFI drivers in legacy ISA add-in card ROMs is explicitly excluded.

Support for UEFI drivers to be located on add-in card type devices for future bus designs other than PCI local bus will be added to future revisions of the UEFI specification. This support will depend upon the specifications that govern such new bus designs with respect to the mechanisms defined for support of driver code on devices.



## 23 Firmware Update and Reporting

---

The UEFI Firmware Management Protocol provides an abstraction for device to provide firmware management support. The base requirements for managing device firmware images include identifying firmware image revision level and programming the image into the device.

The protocol for managing firmware provides the following services.

- Get the attributes of the current firmware image. Attributes include revision level.
- Get a copy of the current firmware image. As an example, this service could be used by a management application to facilitate a firmware roll-back.
- Program the device with a firmware image supplied by the user.
- Label all the firmware images within a device with a single version.

When UEFI Firmware Management Protocol (FMP) instance is intended to perform the update of an option ROM loaded from a PCI or PCI Express device, it is recommended that the FMP instance be attached to the handle with **EFI\_LOADED\_IMAGE\_PROTOCOL** for said Option ROM.

When the FMP instance is intended to update internal device firmware, or a combination of device firmware and Option ROM, the FMP instance may instead be attached to the Controller handle of the device. However in the case where multiple devices represented by multiple controller handles are served by the same firmware store, only a single Controller handle should expose FMP. In all cases a specific updatable hardware firmware store must be represented by exactly one FMP instance.

Care should be taken to ensure that the FMP instance reports current version data that accurately represents the actual contents of the firmware store of the device exposing FMP, because in some cases the device driver currently operating the device may have been loaded from another device or media.

### 23.1 Firmware Management Protocol

#### EFI\_FIRMWARE\_MANAGEMENT\_PROTOCOL

##### Summary

Firmware Management application invokes this protocol to manage device firmware.

## GUID

```
// {86C77A67-0B97-4633-A187-49104D0685C7}
#define EFI_FIRMWARE_MANAGEMENT_PROTOCOL_GUID \
  { 0x86c77a67, 0xb97, 0x4633, \
    {0xa1, 0x87, 0x49, 0x10, 0x4d, 0x06, 0x85, 0xc7 } }
```

## Protocol

```
typedef struct _EFI_FIRMWARE_MANAGEMENT_PROTOCOL {
  EFI_FIRMWARE_MANAGEMENT_PROTOCOL_GET_IMAGE_INFO GetImageInfo;
  EFI_FIRMWARE_MANAGEMENT_PROTOCOL_GET_IMAGE GetImage;
  EFI_FIRMWARE_MANAGEMENT_PROTOCOL_SET_IMAGE SetImage;
  EFI_FIRMWARE_MANAGEMENT_PROTOCOL_CHECK_IMAGE CheckImage;
  EFI_FIRMWARE_MANAGEMENT_PROTOCOL_GET_PACKAGE_INFO
  GetPackageInfo;
  EFI_FIRMWARE_MANAGEMENT_PROTOCOL_SET_PACKAGE_INFO
  SetPackageInfo;
} EFI_FIRMWARE_MANAGEMENT_PROTOCOL;
```

## Members

### *GetImageInfo*

Returns information about the current firmware image(s) of the device.

### *GetImage*

Retrieves a copy of the current firmware image of the device.

### *SetImage*

Updates the device firmware image of the device.

### *CheckImage*

Checks if the firmware image is valid for the device.

### *GetPackageInfo*

Returns information about the current firmware package.

### *SetPackageInfo*

Updates information about the firmware package.

## EFI\_FIRMWARE\_MANAGEMENT\_PROTOCOL.GetImageInfo()

### Summary

Returns information about the current firmware image(s) of the device.

### Protocol

```
typedef
EFI_STATUS
(EFIAPI *EFI_FIRMWARE_MANAGEMENT_PROTOCOL_GET_IMAGE_INFO) (
  IN EFI_FIRMWARE_MANAGEMENT_PROTOCOL  *This,
  IN OUT UINTN                          *ImageInfoSize,
  IN OUT EFI_FIRMWARE_IMAGE_DESCRIPTOR *ImageInfo,
  OUT  UINT32                           *DescriptorVersion
  OUT  UINT8                             *DescriptorCount,
  OUT  UINTN                             *DescriptorSize,
  OUT  UINT32                           *PackageVersion,
  OUT  CHAR16                           **PackageVersionName
);
```

### Parameters

#### *This*

A pointer to the **EFI\_FIRMWARE\_MANAGEMENT\_PROTOCOL** instance.

#### *ImageInfoSize*

A pointer to the size, in bytes, of the *ImageInfo* buffer. On input, this is the size of the buffer allocated by the caller. On output, it is the size of the buffer returned by the firmware if the buffer was large enough, or the size of the buffer needed to contain the image(s) information if the buffer was too small.

#### *ImageInfo*

A pointer to the buffer in which firmware places the current image(s) information. The information is an array of **EFI\_FIRMWARE\_IMAGE\_DESCRIPTOR**s. See “Related Definitions”.

#### *DescriptorVersion*

A pointer to the location in which firmware returns the version number associated with the **EFI\_FIRMWARE\_IMAGE\_DESCRIPTOR**. See “Related Definitions”.

#### *DescriptorCount*

A pointer to the location in which firmware returns the number of descriptors or firmware images within this device.

#### *DescriptorSize*

A pointer to the location in which firmware returns the size, in bytes, of an individual **EFI\_FIRMWARE\_IMAGE\_DESCRIPTOR**.

*PackageVersion*

A version number that represents all the firmware images in the device. The format is vendor specific and new version must have a greater value than the old version. If *PackageVersion* is not supported, the value is 0xFFFFFFFF. A value of 0xFFFFFFFFE indicates that package version comparison is to be performed using *PackageVersionName*. A value of 0xFFFFFFFFD indicates that package version update is in progress.

*PackageVersionName*

A pointer to a pointer to a null-terminated string representing the package version name. The buffer is allocated by this function with **AllocatePool()**, and it is the caller's responsibility to free it with a call to **FreePool()**.

**Related Definitions**

```

//*****
// EFI_FIRMWARE_IMAGE_DESCRIPTOR
//*****
typedef struct {
    UINT8  ImageIndex;
    EFI_GUID ImageTypeId;
    UINT64 ImageId;
    CHAR16 *ImageIdName;
    UINT32 Version;
    CHAR16 *VersionName;
    UINTN  Size;
    UINT64 AttributesSupported;
    UINT64 AttributesSetting;
    UINT64 Compatibilities;
    UINT32 LowestSupportedImageVersion; \
//Introduced with DescriptorVersion 2+
    UINT32 LastAttemptVersion; //Introduced with V3+
    UINT32 LastAttemptStatus; //Introduced with V3+
    UINT64 HardwareInstance; //Introduced with V3+
} EFI_FIRMWARE_IMAGE_DESCRIPTOR;

```

*ImageIndex*

A unique number identifying the firmware image within the device. The number is between 1 and *DescriptorCount*.

*ImageTypeId*

A unique GUID identifying the firmware image type.

*ImageId*

A unique number identifying the firmware image.

*ImageIdName*

A pointer to a null-terminated string representing the firmware image name.



### *Version*

Identifies the version of the device firmware. The format is vendor specific and new version must have a greater value than an old version.

### *VersionName*

A pointer to a null-terminated string representing the firmware image version name.

### *Size*

Size of the image in bytes. If size=0, then only *ImageIndex* and *ImageTypeId* are valid.

### *AttributesSupported*

Image attributes that are supported by this device. See "Image Attribute Definitions" for possible returned values of this parameter. A value of 1 indicates the attribute is supported and the current setting value is indicated in *AttributesSetting*. A value of 0 indicates the attribute is not supported and the current setting value in *AttributesSetting* is meaningless.

### *AttributesSetting*

Image attributes. See "Image Attribute Definitions" for possible returned values of this parameter.

### *Compatibilities*

Image compatibilities. See "Image Compatibility Definitions" for possible returned values of this parameter.

### *LowestSupportedImageVersion*

Describes the lowest *ImageDescriptor* version that the device will accept. Only present in version 2 or higher.

### *LastAttemptVersion*

Describes the version that was last attempted to update. If no update attempted the value will be 0. If the update attempted was improperly formatted and no version number was available then the value will be zero. Only present in version 3 or higher.

### *LastAttemptStatus*

Describes the status that was last attempted to update. If no update has been attempted the value will be **LAST\_ATTEMPT\_STATUS\_SUCCESS**. See "Related Definitions" in [Section 23.3](#) for Last Attempt Status values. Only present in version 3 or higher.

### *HardwareInstance*

An optional number to identify the unique hardware instance within the system for devices that may have multiple instances (Example: a plug in pci network card). This number must be unique within the namespace of the *ImageTypeId* GUID and *ImageIndex*. For FMP instances that have multiple descriptors for a single hardware instance, all descriptors must have the same *HardwareInstance* value. This number must be consistent between

boots and should be based on some sort of hardware identified unique id (serial number, etc) whenever possible. If a hardware based number is not available the FMP provider may use some other characteristic such as device path, bus/dev/function, slot num, etc for generating the *HardwareInstance*. For implementations that will never have more than one instance a zero can be used. A zero means the FMP provider is not able to determine a unique hardware instance number or a hardware instance number is not needed. Only present in version 3 or higher.

```

//*****
// Image Attribute Definitions
//*****
#define IMAGE_ATTRIBUTE_IMAGE_UPDATABLE 0x0000000000000001
#define IMAGE_ATTRIBUTE_RESET_REQUIRED 0x0000000000000002
#define IMAGE_ATTRIBUTE_AUTHENTICATION_REQUIRED
0x0000000000000004
#define IMAGE_ATTRIBUTE_IN_USE 0x0000000000000008
#define IMAGE_ATTRIBUTE_UEFI_IMAGE 0x0000000000000010

```

The attribute **IMAGE\_ATTRIBUTE\_IMAGE\_UPDATABLE** indicates this device supports firmware image update.

The attribute **IMAGE\_ATTRIBUTE\_RESET\_REQUIRED** indicates a reset of the device is required for the new firmware image to take effect after a firmware update. The device is the device hosting the firmware image.

The attribute **IMAGE\_ATTRIBUTE\_AUTHENTICATION\_REQUIRED** indicates authentication is required to perform the following image operations: **GetImage()**, **SetImage()**, and **CheckImage()**. See "Image Attribute – Authentication".

The attribute **IMAGE\_ATTRIBUTE\_IN\_USE** indicates the current state of the firmware image. This distinguishes firmware images in a device that supports redundant images.

The attribute **IMAGE\_ATTRIBUTE\_UEFI\_IMAGE** indicates that this image is an EFI compatible image.

```

//*****
// Image Compatibility Definitions
//*****
#define IMAGE_COMPATIBILITY_CHECK_SUPPORTED 0x0000000000000001

```

Values from 0x0000000000000002 thru 0x000000000000FFFF are reserved for future assignments.

Values from 0x0000000000010000 thru 0xFFFFFFFFFFFFFFFF are used by firmware vendor for compatibility check.

```

//*****
// Descriptor Version exposed by GetImageInfo() function
//*****
#define EFI_FIRMWARE_IMAGE_DESCRIPTOR_VERSION 3

//*****
// Image Attribute – Authentication Required
//*****
typedef struct {
    UINT64      MonotonicCount;
    WIN_CERTIFICATE_UEFI_GUID  AuthInfo;
} EFI_FIRMWARE_IMAGE_AUTHENTICATION;

```

### *MonotonicCount*

It is included in the signature of *AuthInfo*. It is used to ensure freshness/no replay. It is incremented during each firmware image operation.

### *AuthInfo*

Provides the authorization for the firmware image operations. It is a signature across the image data and the Monotonic Count value. Caller uses the private key that is associated with a public key that has been provisioned via the key exchange. Because this is defined as a signature, **WIN\_CERTIFICATE\_UEFI\_GUID.CertType** must be **EFI\_CERT\_TYPE\_PKCS7\_GUID**.

## Description

**GetImageInfo()** is the only required function. **GetImage()**, **SetImage()**, **CheckImage()**, **GetPackageInfo()**, and **SetPackageInfo()** shall return **EFI\_UNSUPPORTED** if not supported by the driver.

A package can have one to many firmware images. The firmware images can have the same version naming or different version naming. *PackageVersion* may be used as the representative version for all the firmware images. *PackageVersion* can be obtained from **GetPackageInfo()**. *PackageVersion* is also available in **GetImageInfo()** as **GetPackageInfo()** is optional. It also ensures the package version is in sync with the versions of the images within the package by returning the package version and image version(s) in a single function call.

The value of *ImageTypeID* is implementation specific. This feature facilitates vendor to target a single firmware release to cover multiple products within a product family. As an example, a vendor has an initial product A and then later developed a product B that is of the same product family. Product A and product B will have the same *ImageTypeID* to indicate firmware compatibility between the two products.

To determine image attributes, software must use both *AttributesSupported* and *AttributesSetting*. An attribute setting in *AttributesSetting* is meaningless if the corresponding attribute is not supported in *AttributesSupported*.

*Compatibilities* are used to ensure the targeted firmware image supports the current hardware configuration. *Compatibilities* are set based on the current hardware configuration and firmware update policy should match the current settings to those supported by the new firmware image, and only permits update to proceed if the new firmware image settings are equal or greater than the current hardware configuration settings. For example, if this function returns *Compatibilities*=0x0000000000070001 and the new firmware image supports settings=0x0000000000030001, then the update policy should block the firmware update and notify the user that updating the hardware with the new firmware image may render the hardware inoperable. This situation usually occurs when updating the hardware with an older version of firmware.

The authentication support leverages the authentication scheme employed in variable authentication. Please reference **EFI\_VARIABLE\_AUTHENTICATION** in the “Variable Services” section of “Services – Runtime Services” chapter.

If **IMAGE\_ATTRIBUTE\_AUTHENTICATION\_REQUIRED** is supported and clear, then authentication is not required to perform the firmware image operations. In firmware image operations, the image pointer points to the start of the firmware image and the image size is the firmware image.

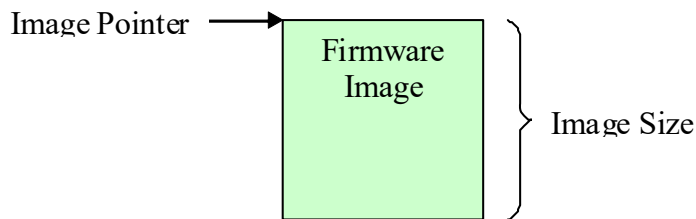

Figure 68. Firmware Image with no Authentication Support

If **IMAGE\_ATTRIBUTE\_AUTHENTICATION\_REQUIRED** is supported and set, then authentication is required to perform the firmware image operations. In firmware image operations, the image pointer points to the start of the **authentication data** and the image size is the size of the **authentication data** and the size of the firmware image.

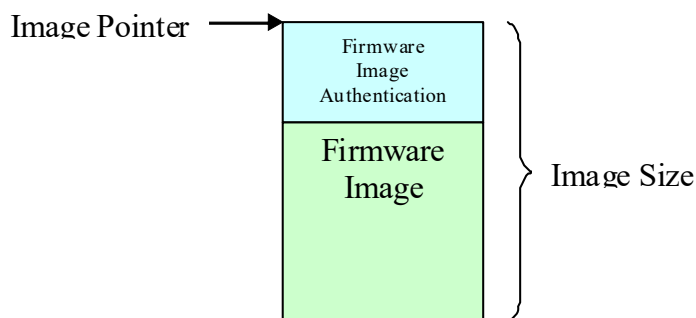

Figure 69. Firmware Image with Authentication Support

## Status Codes Returned

EFI_SUCCESS	The image information was successfully returned.
EFI_BUFFER_TOO_SMALL	The <i>ImageInfo</i> buffer was too small. The current buffer size needed to hold the image(s) information is returned in <i>ImageInfoSize</i> .
EFI_INVALID_PARAMETER	<i>ImageInfoSize</i> is NULL.
EFI_DEVICE_ERROR	Valid information could not be returned. Possible corrupted image.

## EFI\_FIRMWARE\_MANAGEMENT\_PROTOCOL.GetImage()

### Summary

Retrieves a copy of the current firmware image of the device.

### Protocol

```
typedef
EFI_STATUS
(EFI_API *EFI_FIRMWARE_MANAGEMENT_PROTOCOL_GET_IMAGE) (
    IN EFI_FIRMWARE_MANAGEMENT_PROTOCOL *This,
    IN UINT8      ImageIndex,
    IN OUT VOID   *Image,
    IN OUT UINTN  *ImageSize
);
```

### Parameters

*This*

A pointer to the **EFI\_FIRMWARE\_MANAGEMENT\_PROTOCOL** instance.

*ImageIndex*

A unique number identifying the firmware image(s) within the device. The number is between 1 and *DescriptorCount*.

*Image*

Points to the buffer where the current image is copied to.

*ImageSize*

On entry, points to the size of the buffer pointed to by *Image*, in bytes. On return, points to the length of the image, in bytes.

### Related Definitions

None

### Description

This function allows a copy of the current firmware image to be created and saved. The saved copy could later be used, for example, in firmware image recovery or rollback.

## Status Codes Returned

EFI_SUCCESS	The current image was successfully copied to the buffer.
EFI_BUFFER_TOO_SMALL	The buffer specified by <i>ImageSize</i> is too small to hold the image. The current buffer size needed to hold the image is returned in <i>ImageSize</i> .
EFI_INVALID_PARAMETER	The <i>Image</i> was NULL.
EFI_NOT_FOUND	The current image is not copied to the buffer.
EFI_UNSUPPORTED	The operation is not supported.
EFI_SECURITY_VIOLATION	The operation could not be performed due to an authentication failure.

## EFI\_FIRMWARE\_MANAGEMENT\_PROTOCOL.SetImage()

### Summary

Updates the firmware image of the device.

### Protocol

```
typedef
EFI_STATUS
(EFI_API *EFI_FIRMWARE_MANAGEMENT_PROTOCOL_SET_IMAGE) (
  IN EFI_FIRMWARE_MANAGEMENT_PROTOCOL  *This,
  IN UINT8          ImageIndex,
  IN CONST VOID     *Image,
  IN UINTN          ImageSize,
  IN CONST VOID     *VendorCode,
  IN EFI_FIRMWARE_MANAGEMENT_UPDATE_IMAGE_PROGRESS Progress,
  OUT CHAR16        **AbortReason
);
```

### Parameters

#### *This*

A pointer to the **EFI\_FIRMWARE\_MANAGEMENT\_PROTOCOL** instance.

#### *ImageIndex*

A unique number identifying the firmware image(s) within the device. The number is between 1 and *DescriptorCount*.

#### *Image*

Points to the new image.

#### *ImageSize*

Size of the new image in bytes.

#### *VendorCode*

This enables vendor to implement vendor-specific firmware image update policy. Null indicates the caller did not specify the policy or use the default policy.

#### *Progress*

A function used by the driver to report the progress of the firmware update.

#### *AbortReason*

A pointer to a pointer to a null-terminated string providing more details for the aborted operation. The buffer is allocated by this function with **AllocatePool()**, and it is the caller's responsibility to free it with a call to **FreePool()**.



## Related Definitions

```
typedef
EFI_STATUS
(EFI_API *EFI_FIRMWARE_MANAGEMENT_UPDATE_IMAGE_PROGRESS) (
    IN UINTN          Completion
);
Completion
```

A value between 1 and 100 indicating the current completion progress of the firmware update. Completion progress is reported as from 1 to 100 percent. A value of 0 is used by the driver to indicate that progress reporting is not supported.

On **EFI\_SUCCESS, SetImage()** continues to do the callback if supported. On **NOT EFI\_SUCCESS, SetImage()** discontinues the callback and completes the update and returns.

## Description

This function updates the hardware with the new firmware image.

This function returns **EFI\_UNSUPPORTED** if the firmware image is not updatable.

If the firmware image is updatable, the function should perform the following minimal validations before proceeding to do the firmware image update.

- Validate the image authentication if image has attribute **IMAGE\_ATTRIBUTE\_AUTHENTICATION\_REQUIRED**. The function returns **EFI\_SECURITY\_VIOLATION** if the validation fails.
- Validate the image is a supported image for this device. The function returns **EFI\_ABORTED** if the image is unsupported. The function can optionally provide more detailed information on why the image is not a supported image.
- Validate the data from *VendorCode* if not null. Image validation must be performed before *VendorCode* data validation. *VendorCode* data is ignored or considered invalid if image validation failed. The function returns **EFI\_ABORTED** if the data is invalid.

*VendorCode* enables vendor to implement vendor-specific firmware image update policy. Null if the caller did not specify the policy or use the default policy. As an example, vendor can implement a policy to allow an option to force a firmware image update when the abort reason is due to the new firmware image version is older than the current firmware image version or bad image checksum. Sensitive operations such as those wiping the entire firmware image and render the device to be non-functional should be encoded in the image itself rather than passed with the *VendorCode*.

*AbortReason* enables vendor to have the option to provide a more detailed description of the abort reason to the caller.

## Status Codes Returned

EFI_SUCCESS	The device was successfully updated with the new image.
EFI_ABORTED	The operation is aborted.

EFI_INVALID_PARAMETER	The <i>Image</i> was NULL.
EFI_UNSUPPORTED	The operation is not supported.
EFI_SECURITY_VIOLATION	The operation could not be performed due to an authentication failure.

## EFI\_FIRMWARE\_MANAGEMENT\_PROTOCOL.CheckImage()

### Summary

Checks if the firmware image is valid for the device.

### Protocol

```
typedef
EFI_STATUS
(EFIAPI *EFI_FIRMWARE_MANAGEMENT_PROTOCOL_CHECK_IMAGE) (
  IN EFI_FIRMWARE_MANAGEMENT_PROTOCOL *This,
  IN UINT8      ImageIndex,
  IN CONST VOID *Image,
  IN UINTN      ImageSize,
  OUT UINT32     *ImageUpdatable
);
```

### Parameters

*This*

A pointer to the **EFI\_FIRMWARE\_MANAGEMENT\_PROTOCOL** instance.

*ImageIndex*

A unique number identifying the firmware image(s) within the device. The number is between 1 and *DescriptorCount*.

*Image*

Points to the new image.

*ImageSize*

Size of the new image in bytes.

*ImageUpdatable*

Indicates if the new image is valid for update. It also provides, if available, additional information if the image is invalid. See "Related Definitions".

### Related Definitions

```
/**
//*****
// ImageUpdatable Definitions
//*****
#define IMAGE_UPDATABLE_VALID  0x0000000000000001
#define IMAGE_UPDATABLE_INVALID 0x0000000000000002
#define IMAGE_UPDATABLE_INVALID_TYPE 0x0000000000000004
#define IMAGE_UPDATABLE_INVALID_OLD 0x0000000000000008
#define IMAGE_UPDATABLE_VALID_WITH_VENDOR_CODE \
0x0000000000000010
```

**IMAGE\_UPDATABLE\_VALID** indicates **SetImage()** will accept the new image and update the device with the new image. The version of the new image could be higher or lower than the current image. **SetImage** *VendorCode* is optional but can be used for vendor specific action.

**IMAGE\_UPDATABLE\_INVALID** indicates **SetImage()** will reject the new image. No additional information is provided for the rejection.

**IMAGE\_UPDATABLE\_INVALID\_TYPE** indicates **SetImage()** will reject the new image. The rejection is due to the new image is not a firmware image recognized for this device.

**IMAGE\_UPDATABLE\_INVALID\_OLD** indicates **SetImage()** will reject the new image. The rejection is due to the new image version is older than the current firmware image version in the device. The device firmware update policy does not support firmware version downgrade.

**IMAGE\_UPDATABLE\_VALID\_WITH\_VENDOR\_CODE** indicates **SetImage()** will accept and update the new image only if a correct *VendorCode* is provided or else image would be rejected and **SetImage** will return appropriate error.

## Description

This function allows firmware update application to validate the firmware image without invoking the **SetImage()** first. Please see **SetImage()** for the type of image validations performed.

## Status Codes Returned

EFI_SUCCESS	The image was successfully checked.
EFI_INVALID_PARAMETER	The <i>Image</i> was NULL.
EFI_UNSUPPORTED	The operation is not supported.
EFI_SECURITY_VIOLATION	The operation could not be performed due to an authentication failure.

## EFI\_FIRMWARE\_MANAGEMENT\_PROTOCOL.GetPackageInfo()

### Summary

Returns information about the firmware package.

### Protocol

```
typedef
EFI_STATUS
(EFI_API *EFI_FIRMWARE_MANAGEMENT_PROTOCOL_GET_PACKAGE_INFO) (
  IN EFI_FIRMWARE_MANAGEMENT_PROTOCOL *This,
  OUT UINT32          *PackageVersion,
  OUT CHAR16         **PackageVersionName,
  OUT UINT32         *PackageVersionNameMaxLen,
  OUT UINT64         *AttributesSupported,
  OUT UINT64         *AttributesSetting
);
```

### Parameters

#### *This*

A pointer to the **EFI\_FIRMWARE\_MANAGEMENT\_PROTOCOL** instance.

#### *PackageVersion*

A version number that represents all the firmware images in the device. The format is vendor specific and new version must have a greater value than the old version. If *PackageVersion* is not supported, the value is 0xFFFFFFFF. A value of 0xFFFFFFF0 indicates that package version comparison is to be performed using *PackageVersionName*. A value of 0xFFFFFFF1 indicates that package version update is in progress.

#### *PackageVersionName*

A pointer to a pointer to a null-terminated string representing the package version name. The buffer is allocated by this function with **AllocatePool()**, and it is the caller's responsibility to free it with a call to **FreePool()**.

#### *PackageVersionNameMaxLen*

The maximum length of package version name if device supports update of package version name. A value of 0 indicates the device does not support update of package version name. Length is the number of Unicode characters, including the terminating null character.

#### *AttributesSupported*

Package attributes that are supported by this device. See "Package Attribute Definitions" for possible returned values of this parameter. A value of 1 indicates the attribute is supported and the current setting value is indicated in *AttributesSetting*. A value of 0 indicates the attribute is not supported and the current setting value in *AttributesSetting* is meaningless.

*AttributesSetting*

Package attributes. See “Package Attribute Definitions” for possible returned values of this parameter.

**Related Definitions**

```

//*****
// Package Attribute Definitions
//*****
#define PACKAGE_ATTRIBUTE_VERSION_UPDATABLE 0x0000000000000001
#define PACKAGE_ATTRIBUTE_RESET_REQUIRED 0x0000000000000002
#define PACKAGE_ATTRIBUTE_AUTHENTICATION_REQUIRED
0x0000000000000004
    
```

The attribute **PACKAGE\_ATTRIBUTE\_VERSION\_UPDATABLE** indicates this device supports the update of the firmware package version.

The attribute **PACKAGE\_ATTRIBUTE\_RESET\_REQUIRED** indicates a reset of the device is required for the new package info to take effect after an update.

The attribute **PACKAGE\_ATTRIBUTE\_AUTHENTICATION\_REQUIRED** indicates authentication is required to update the package info.

**Description**

This function returns package information.

**Status Codes Returned**

EFI_SUCCESS	The package information was successfully returned.
EFI_UNSUPPORTED	The operation is not supported.

## EFI\_FIRMWARE\_MANAGEMENT\_PROTOCOL.SetPackageInfo()

### Summary

Updates information about the firmware package.

### Protocol

```
typedef
EFI_STATUS
(EFIAPI *EFI_FIRMWARE_MANAGEMENT_PROTOCOL_SET_PACKAGE_INFO) (
  IN EFI_FIRMWARE_MANAGEMENT_PROTOCOL *This,
  IN CONST VOID *Image,
  IN UINTN ImageSize,
  IN CONST VOID *VendorCode,
  IN UINT32 PackageVersion,
  IN CONST CHAR16 *PackageVersionName
);
```

### Parameters

*This*

A pointer to the **EFI\_FIRMWARE\_MANAGEMENT\_PROTOCOL** instance.

*Image*

Points to the authentication image. Null if authentication is not required.

*ImageSize*

Size of the authentication image in bytes. 0 if authentication is not required.

*VendorCode*

This enables vendor to implement vendor-specific firmware image update policy. Null indicates the caller did not specify this policy or use the default policy.

*PackageVersion*

The new package version.

*PackageVersionName*

A pointer to the new null-terminated Unicode string representing the package version name. The string length is equal to or less than the value returned in *PackageVersionNameMaxLen*.

### Description

This function updates package information.

This function returns **EFI\_UNSUPPORTED** if the package information is not updatable.

*VendorCode* enables vendor to implement vendor-specific package information update policy. Null if the caller did not specify this policy or use the default policy.

## Status Codes Returned

EFI_SUCCESS	The device was successfully updated with the new package information
EFI_INVALID_PARAMETER	The <i>PackageVersionName</i> length is longer than the value returned in <i>PackageVersionNameMaxLen</i> .
EFI_UNSUPPORTED	The operation is not supported.
EFI_SECURITY_VIOLATION	The operation could not be performed due to an authentication failure.

## 23.2 Delivering Capsules Containing Updates to Firmware Management Protocol

### Summary

This section defines a method for delivery of a Firmware Management Protocol defined update using the UpdateCapsule runtime API.

### 23.2.1 EFI\_FIRMWARE\_MANAGEMENT\_CAPSULE\_ID\_GUID

#### GUID

```
// {6DCBD5ED-E82D-4C44-BDA1-7194199AD92A}
#define EFI_FIRMWARE_MANAGEMENT_CAPSULE_ID_GUID \
  {0x6dcbd5ed, 0xe82d, 0x4c44, \
   {0xbd, 0xa1, 0x71, 0x94, 0x19, 0x9a, 0xd9, 0x2a } }
```

#### Description

This GUID is used in the *CapsuleGuid* field of **EFI\_CAPSULE\_HEADER** struct within a capsule constructed according to the definitions of section [Section 8.5.3.1](#). Use of this GUID indicates a capsule with body conforming to the additional structure defined in [Section 23.2.2](#).

When delivered to platform firmware **QueryCapsuleCapabilities()** the capsule will be examined according to the structure defined in [Section 23.2.2](#) and if it is possible for the platform to process **EFI\_SUCCESS** will be returned.

When delivered to platform firmware **UpdateCapsule()** the capsule will be examined according to the structure defined in [Section 23.2.2](#) and if it is possible for the platform to process the update will be processed.

By definition Firmware Management protocol services are not available in EFI runtime and depending upon platform capabilities, EFI runtime delivery of this capsule may not be supported and may return an error when delivered in EFI runtime with **CAPSULE\_FLAGS\_PERSIST\_ACROSS\_RESET** bit defined. However any platform supporting this capability is required to accept this form of capsule in Boot Services, including optional use of **CAPSULE\_FLAGS\_PERSIST\_ACROSS\_RESET** bit.



## 23.2.2 DEFINED FIRMWARE MANAGEMENT PROTOCOL DATA CAPSULE STRUCTURE

### Structure of the Capsule Body

Generic EFI Capsule Body is defined in [Section 8.5.3.1](#). When an EFI Capsule is identified by **EFI\_FIRMWARE\_MANAGEMENT\_CAPSULE\_ID\_GUID**, the internal structure of the capsule **\_\_FIRMWARE\_MANAGEMENT\_CAPSULE\_HEADER** followed by optional EFI drivers to be loaded by the platform and optional binary payload items to be processed and passed to Firmware Management Protocol image update function. Each binary payload item is preceded by **EFI\_FIRMWARE\_MANAGEMENT\_CAPSULE\_IMAGE\_HEADER**. Internal capsule structure diagram follows.

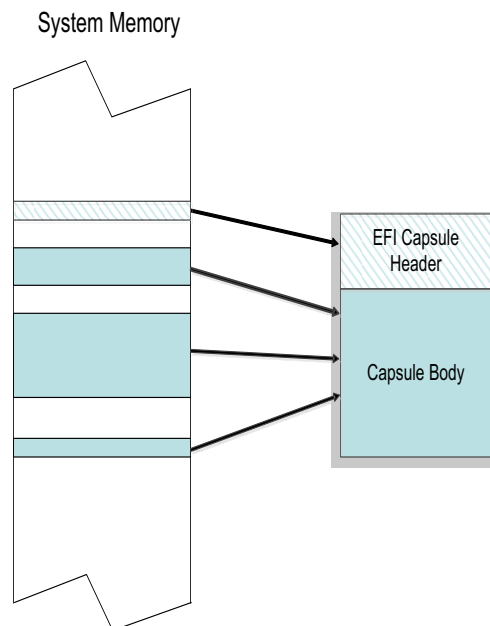

Figure 70. Optional Scatter-Gather Construction of Capsule Submitted to UpdateCapsule()

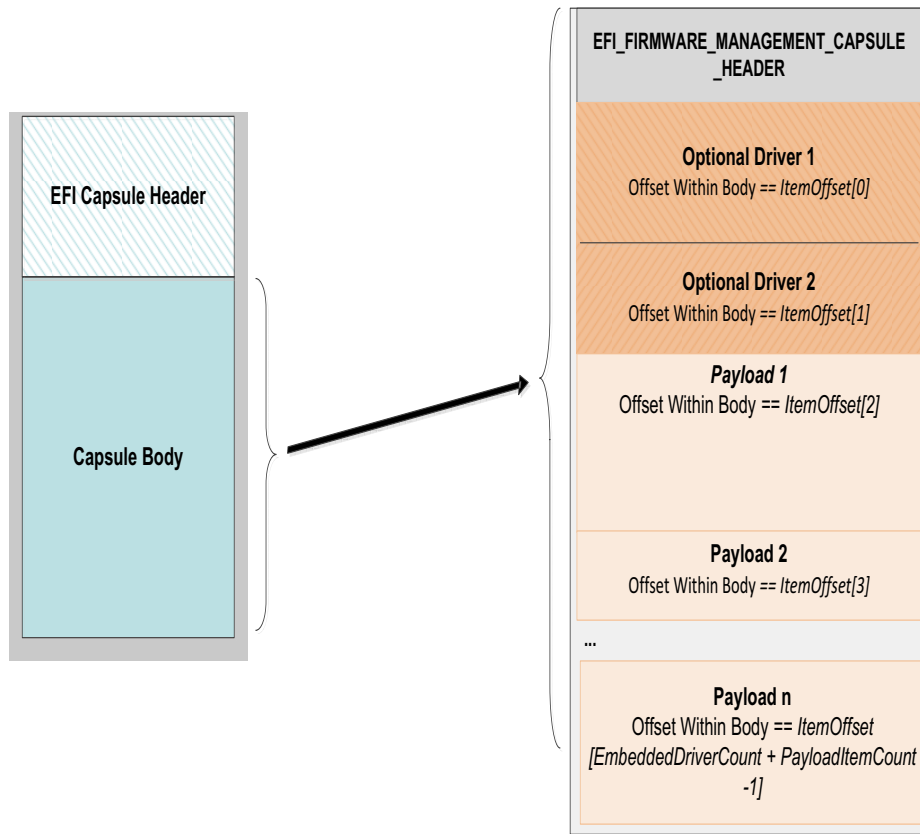

Figure 71. Capsule Header and Firmware Management Capsule Header

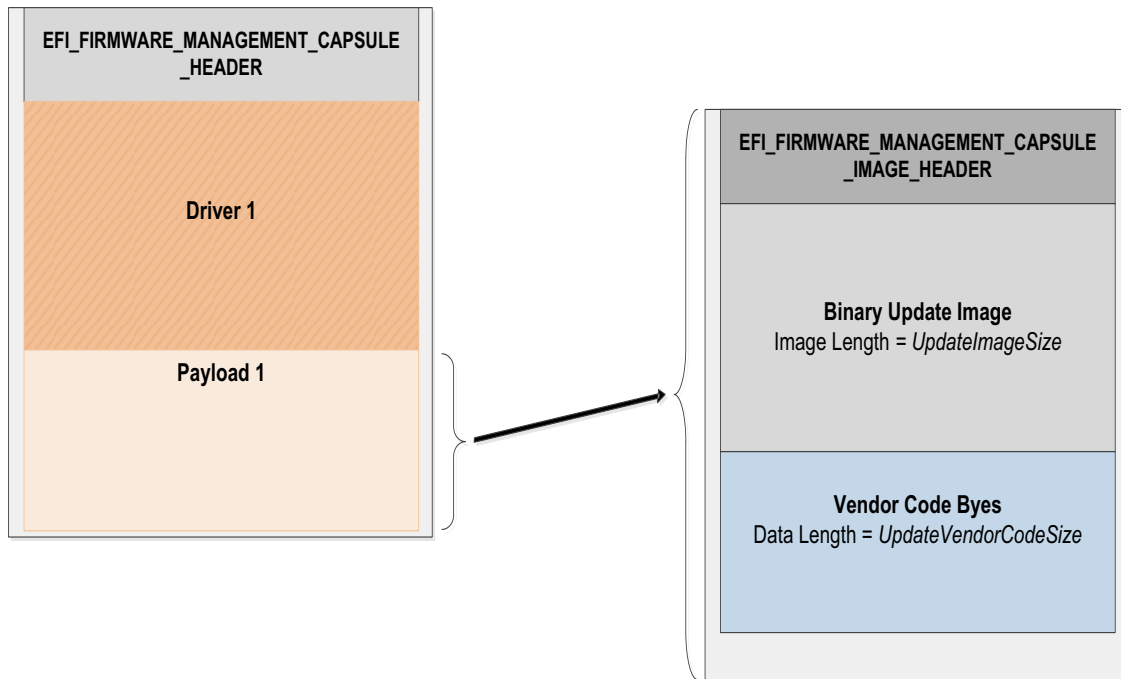

Figure 72. Firmware Management and Firmware Image Management headers

## Related Definitions

```
#pragma pack(1)
typedef struct {
    UINT32  Version;
    UINT16  EmbeddedDriverCount;
    UINT16  PayloadItemCount;
    // UINT64 ItemOffsetList[];
} EFI_FIRMWARE_MANAGEMENT_CAPSULE_HEADER;
```

### *Version*

Version of the structure, initially 0x00000001.

### *EmbeddedDriverCount*

The number of drivers included in the capsule and the number of corresponding offsets stored in *ItemOffsetList* array. This field may be zero in the case where no driver is required.

### *PayloadItemCount*

The number of payload items included in the capsule and the number of corresponding offsets stored in the *ItemOffsetList* array. This field may be zero in the case where no binary payload object is required to accomplish the update.

*ItemOffsetList*

Variable length array of dimension [*EmbeddedDriverCount* + *PayloadItemCount*] containing offsets of each of the drivers and payload items contained within the capsule. The offsets of the items are calculated relative to the base address of the **EFI\_FIRMWARE\_MANAGEMENT\_CAPSULE\_HEADER** struct. Offset may indicate structure begins on any byte boundary. Offsets in the array must be sorted in ascending order with all drivers preceding all binary payload elements.

```
#pragma pack(1)
typedef struct {
    UINT32  Version;
    EFI_GUID  UpdateImageTypeId;
    UINT8  UpdateImageIndex;
    UINT8  reserved_bytes[3];
    UINT32  UpdateImageSize;
    UINT32  UpdateVendorCodeSize;
    UINT64  UpdateHardwareInstance; //Introduced in v2
} EFI_FIRMWARE_MANAGEMENT_CAPSULE_IMAGE_HEADER;
```

*Version*

Version of the structure, initially **0x00000002**.

*UpdateImageTypeId*

Used to identify device firmware targeted by this update. This guid is matched by system firmware against *ImageTypeId* field within a **EFI\_FIRMWARE\_IMAGE\_DESCRIPTOR** returned by an instance of **EFI\_FIRMWARE\_MANAGEMENT\_PROTOCOL.GetImageInfo()** in the system.

*UpdateImageIndex*

Passed as *ImageIndex* in call to **EFI\_FIRMWARE\_MANAGEMENT\_PROTOCOL.SetImage()**

*UpdateImageSize*

Size of the binary update image which immediately follows this structure. Passed as *ImageSize* to **EFI\_FIRMWARE\_MANAGEMENT\_PROTOCOL.SetImage()**. This size may or may not include Firmware Image Authentication information.

*UpdateVendorCodeSize*

Size of the *VendorCode* bytes which optionally immediately follow binary update image in the capsule. Pointer to these bytes passed in *VendorCode* to **EFI\_FIRMWARE\_MANAGEMENT\_PROTOCOL.SetImage()**. If *UpdateVendorCodeSize* is zero, then *VendorCode* is null in **SetImage()** call.

*UpdateHardwareInstance*

The *HardwareInstance* to target with this update. If value is zero it means match all *HardwareInstances*. This field allows update software to target only a single device in cases where there are more than one device with the same *ImageTypeId* GUID. This header is outside the signed data of the Authentication Info structure and therefore can be modified without changing the Auth data.

**Description**

The **EFI\_FIRMWARE\_MANAGEMENT\_CAPSULE\_HEADER** structure is located at the lowest offset within the body of the capsule identified by **EFI\_FIRMWARE\_MANAGEMENT\_CAPSULE\_ID\_GUID**. The structure is variable length with the number of element offsets within of the *ItemOffsetList* array determined by the count of drivers within the capsule plus the count of binary payload elements. It is expected that drivers whose presence is indicated by non-zero *EmbeddedDriverCount* will be used to supply an implementation of **EFI\_FIRMWARE\_MANAGEMENT\_PROTOCOL** for devices that lack said protocol within the image to be updated.

Each payload item contained within the capsule body is preceded by a **EFI\_FIRMWARE\_MANAGEMENT\_CAPSULE\_IMAGE\_HEADER** struct used to provide information required to prepare the payload item as an image for delivery to a instance of **EFI\_FIRMWARE\_MANAGEMENT\_PROTOCOL.SetImage()**function.

**Note:** *[Caution] The capsule identified by **EFI\_FIRMWARE\_MANAGEMENT\_CAPSULE\_ID\_GUID** uses packed structures and structure fields may not be naturally aligned within the capsule buffer as delivered. Drivers and binary payload elements may start on byte boundary with no padding. Processing firmware may need to copy content elements during capsule unpacking in order to achieve any required natural alignment.*

### 23.2.3 Firmware Processing of the Capsule Identified by **EFI\_FIRMWARE\_MANAGEMENT\_CAPSULE\_ID\_GUID**

1. Capsule is presented to system firmware via call to **UpdateCapsule()** or using mass storage delivery procedure of [Section 8.5.5](#). The capsule must be constructed to consist of a single **EFI\_FIRMWARE\_MANAGEMENT\_CAPSULE\_HEADER** structure with the 0 or more drivers and 0 or more binary payload items. However a capsule in which driver count and payload count are both zero is not processed.
2. Capsule is recognized by **EFI\_CAPSULE\_HEADER** member *CapsuleGuid* equal to **EFI\_FIRMWARE\_MANAGEMENT\_CAPSULE\_ID\_GUID**. **CAPSULE\_FLAGS\_POPULATE\_SYSTEM\_TABLE** flag must be 0.
3. If system is not in boot services and platform does not support persistence of capsule across reset when initiated within EFI Runtime, **EFI\_OUT\_OF\_RESOURCES** error is returned.
4. If device requires hardware reset to unlock flash write protection, **CAPSULE\_FLAGS\_PERSIST\_ACROSS\_RESET** and optionally **CAPSULE\_FLAGS\_INITIATE\_RESET** should be set to 1 in the **EFI\_CAPSULE\_HEADER**.

5. When reset is requested using **CAPSULE\_FLAGS\_PERSIST\_ACROSS\_RESET**, the capsule is processed in Boot Services, before the **EFI\_EVENT\_GROUP\_READY\_TO\_BOOT** event.
6. All scatter-gather fragmentation is removed by the platform firmware and the capsule is processed as a contiguous buffer.
7. Examining **EFI\_FIRMWARE\_MANAGEMENT\_CAPSULE\_HEADER**, if *EmbeddedDriverCount* is non-zero, for each of the included drivers up to indicated count, the portion of the capsule body starting at the offset indicated by *ItemOffsetList[n]* and continuing for a size encompassing all bytes up to the next element's offset stored in *ItemOffsetList[n+1]* or the end of the capsule, will be copied to a buffer. The driver contained within the capsule body may not be naturally aligned and the exact driver size in bytes should be respected to ensure successful security validation. In the case where a driver is last element in the *ItemOffsetList* array, the driver size may be calculated by reference to body size as calculated from *CapsuleImageSize* in **EFI\_CAPSULE\_HEADER**.
8. Each extracted driver is placed into a buffer and passed to **LoadImage()**. The driver image passed to **LoadImage()** must successfully pass all image format, platform type, and security checks including those related to UEFI secure boot, if enabled on the platform. After **LoadImage()** returns the processing of the capsule is continued with next driver if present until all drivers have been passed to **LoadImage()**. The driver being installed must check for matching hardware and instantiate any required protocols during call to **EFI\_IMAGE\_ENTRY\_POINT**. In case where matching hardware is not found the driver should exit with error. In case where capsule creator has preference as to which of several included drivers to be made resident, later drivers in the capsule should confirm earlier driver successfully loaded and then exit with load error.
9. After driver processing is complete the platform firmware examines *PayloadItemCount*, and if zero the capsule processing is complete. Otherwise platform firmware sequentially locates each **EFI\_FIRMWARE\_MANAGEMENT\_CAPSULE\_IMAGE\_HEADER** found within the capsule and processes according to steps 10-14.
10. For all instances of **EFI\_FIRMWARE\_MANAGEMENT\_PROTOCOL** in the system, **GetImageInfo()** is called to return arrays of **EFI\_FIRMWARE\_IMAGE\_DESCRIPTOR** structures.
11. Find the matching FMP instance(s):
  - a. If the **EFI\_FIRMWARE\_MANAGEMENT\_CAPSULE\_IMAGE\_HEADER** is version 1 or it is version 2 with *UpdateHardwareInstance* set to 0, then system firmware will use only the *ImageTypeId* to determine a match. For each instance of **EFI\_FIRMWARE\_MANAGEMENT\_PROTOCOL** that returns a **EFI\_FIRMWARE\_IMAGE\_DESCRIPTOR** containing an *ImageTypeId* GUID that matches the *UpdateImageTypeId* GUID within **EFI\_FIRMWARE\_MANAGEMENT\_CAPSULE\_IMAGE\_HEADER**, the system firmware will call **SetImage()** function within that instance. In some cases there may be more than one instance of matching **EFI\_FIRMWARE\_MANAGEMENT\_PROTOCOL** when multiple matching devices are installed in the system and all instances will be checked for GUID match and **SetImage()** call if match is successful.

- b If the **EFI\_FIRMWARE\_MANAGEMENT\_CAPSULE\_IMAGE\_HEADER** is version 2 and contains a non-zero value in the *UpdateHardwareInstance* field, then system firmware will use both *ImageTypeId* and *HardwareInstance* to determine a match. For the instance of **EFI\_FIRMWARE\_MANAGEMENT\_PROTOCOL** that returns a **EFI\_FIRMWARE\_IMAGE\_DESCRIPTOR** containing an *ImageTypeId* GUID that matches the *UpdateImageTypeId* GUID and a *HardwareInstance* matching the *UpdateHardwareInstance* within **EFI\_FIRMWARE\_MANAGEMENT\_CAPSULE\_IMAGE\_HEADER**, the system firmware will call the **SetImage()** function within that instance. There will never be more than one instance since the *ImageId* must be unique.
12. In the situation where platform configuration or policy prohibits the processing of a capsule or individual FMP payload, the error **EFI\_NOT\_READY** will be returned in capsule result variable *CapsuleStatus* field. Otherwise **SetImage()** parameters are constructed using the *UpdateImageIndex*, *UpdateImageSize* and *UpdateVendorCodeSize* fields within **EFI\_FIRMWARE\_MANAGEMENT\_CAPSULE\_IMAGE\_HEADER**. In the case of capsule containing multiple payloads, or a payload matching multiple FMP instances, a separate Capsule Result Variable will be created with the results of each call to **SetImage()**. If any call to **SetImage()** selected per above matching algorithm returns an error, the processing of additional FMP instances or payload items in that capsule will be skipped and **EFI\_ABORTED** returned in Capsule Result Variable for each potential call to **SetImage()** that was skipped.
  13. **SetImage()** performs any required image authentication as described in that functions definition within this chapter.
  14. Note: if multiple separate component updates including multiple *ImageIndex* values are required then additional **EFI\_FIRMWARE\_MANAGEMENT\_CAPSULE\_IMAGE\_HEADER** structures and image binaries are included within the capsule.
  15. After all items in the capsule are processed the system is restarted by the platform firmware.

## 23.3 EFI System Resource Table

### EFI\_SYSTEM\_RESOURCE\_TABLE

#### Summary

The EFI System Resource Table (ESRT) provides an optional mechanism for identifying device and system firmware resources for the purposes of targeting firmware updates to those resources. Each entry in the ESRT describes a device or system firmware resource that can be targeted by a firmware capsule update. Each entry in the ESRT will also be used to report status of the last attempted update. See [Section 4.6](#) for description of how to publish ESRT using **EFI\_CONFIGURATION\_TABLE**. The ESRT shall be stored in memory of type **EfiBootServicesData**. See [Section 8.5.3](#) and [Section 8.5.5](#) for details on delivery of updates to devices listed in ESRT.

## GUID

```
#define EFI_SYSTEM_RESOURCE_TABLE_GUID
    { 0xb122a263, 0x3661, 0x4f68, \
      0x99, 0x29, 0x78, 0xf8, 0xb0, 0xd6, 0x21, 0x80 }
```

## Table Structure

```
typedef struct {
    UINT32      FwResourceCount;
    UINT32      FwResourceCountMax;
    UINT64      FwResourceVersion;
    //EFI_SYSTEM_RESOURCE_ENTRY Entries[];
} EFI_SYSTEM_RESOURCE_TABLE;
```

## Members

<i>FwResourceCount</i>	The number of firmware resources in the table, must not be zero.
<i>FwResourceCountMax</i>	The maximum number of resource array entries that can be within the table without reallocating the table, must not be zero.
<i>FwResourceVersion</i>	The version of the <b>EFI_SYSTEM_RESOURCE_ENTRY</b> entities used in this table. This field should be set to 1. See <b>EFI_SYSTEM_RESOURCE_TABLE_FIRMWARE_RESOURCE_VERSION</b> .
<i>Entries</i>	Array of <b>EFI_SYSTEM_RESOURCE_ENTRY</b>

## Related Definitions

```
// Current Entry Version
#define EFI_SYSTEM_RESOURCE_TABLE_FIRMWARE_RESOURCE_VERSION 1

typedef struct {
    EFI_GUID  FwClass;
    UINT32    FwType;
    UINT32    FwVersion;
    UINT32    LowestSupportedFwVersion;
    UINT32    CapsuleFlags;
    UINT32    LastAttemptVersion;
    UINT32    LastAttemptStatus;
} EFI_SYSTEM_RESOURCE_ENTRY;
```

<i>FwClass</i>	The firmware class field contains a GUID that identifies a firmware component that can be updated via <b>UpdateCapsule()</b> . This GUID must be unique within all entries of the ESRT.
<i>FwType</i>	Identifies the type of firmware resource. See “Firmware Type Definitions” below for possible values.



<i>FwVersion</i>	The firmware version field represents the current version of the firmware resource, value must always increase as a larger number represents a newer version.
<i>LowestSupportedFwVersion</i>	The lowest firmware resource version to which a firmware resource can be rolled back for the given system/device. Generally this is used to protect against known and fixed security issues.
<i>CapsuleFlags</i>	The capsule flags field contains the <i>CapsuleGuid</i> flags (bits 0- 15) as defined in the <b>EFI_CAPSULE_HEADER</b> that will be set in the capsule header.
<i>LastAttemptVersion</i>	<p>The last attempt version field describes the last firmware version for which an update was attempted (uses the same format as Firmware Version).</p> <p>Last Attempt Version is updated each time an <b>UpdateCapsule()</b> is attempted for an ESRT entry and is preserved across reboots (non-volatile). However, in cases where the attempt version is not recorded due to limitations in the update process, the field shall set to zero after a failed update. Similarly, in the case of a removable device, this value is set to 0 in cases where the device has not been updated since being added to the system.</p>
<i>LastAttemptStatus</i>	<p>The last attempt status field describes the result of the last firmware update attempt for the firmware resource entry.</p> <p><i>LastAttemptStatus</i> is updated each time an <b>UpdateCapsule()</b> is attempted for an ESRT entry and is preserved across reboots (non-volatile).</p> <p>If a firmware update has never been attempted or is unknown, for example after fresh insertion of a removable device, <i>LastAttemptStatus</i> must be set to Success.</p>

```
//  
// Firmware Type Definitions  
//  
#define ESRT_FW_TYPE_UNKNOWN 0x00000000  
#define ESRT_FW_TYPE_SYSTEMFIRMWARE 0x00000001  
#define ESRT_FW_TYPE_DEVICEFIRMWARE 0x00000002  
#define ESRT_FW_TYPE UEFIDRIVER 0x00000003  
  
//  
// Last Attempt Status Values  
//  
#define LAST_ATTEMPT_STATUS_SUCCESS 0x00000000  
#define LAST_ATTEMPT_STATUS_ERROR_UNSUCCESSFUL 0x00000001  
#define LAST_ATTEMPT_STATUS_ERROR_INSUFFICIENT_RESOURCES  
0x00000002  
#define LAST_ATTEMPT_STATUS_ERROR_INCORRECT_VERSION 0x00000003  
#define LAST_ATTEMPT_STATUS_ERROR_INVALID_FORMAT 0x00000004  
#define LAST_ATTEMPT_STATUS_ERROR_AUTH_ERROR 0x00000005  
#define LAST_ATTEMPT_STATUS_ERROR_PWR_EVT_AC 0x00000006  
#define LAST_ATTEMPT_STATUS_ERROR_PWR_EVT_BATT 0x00000007
```

### 23.3.1 Adding and Removing Devices from the ESRT

ESRT entries must be updated by System Firmware before handoff to the Operating System under the following conditions. Devices and systems that support hot swapping (once the OS has been loaded) will not get their ESRT entries updated until the next reboot and execution of ESRT updating logic in the UEFI space.

**Required:** System firmware is responsible for updating the *FirmwareVersion*, *LowestSupportedFirmwareVersion*, *LastAttemptVersion* and *LastAttemptStatus* values in the ESRT any time **UpdateCapsule** is called and a firmware update attempt is made for the corresponding ESRT entry.

**Required:** the ESRT must be updated each time a configuration change is detected by system firmware, such as when a device is added or removed from the system.

**Optional:** all devices in the ESRT should be polled for any configuration changes any time **UpdateCapsule** is called.

### 23.3.2 ESRT and Firmware Management Protocol

Although the ESRT does not require firmware to use Firmware Management Protocol for updates it is designed to work with and extend the capabilities of FMP. The ESRT can be used to represent system and device firmware serviced by capsules that have an implementation specific format as well as devices that support Firmware Management Protocol and that are serviced by capsules formatted as described in [Section 23.2](#), *Delivering Capsules Containing Updates to Firmware Management Protocol*. For system

expansion devices, the task of building ESRT table entries is to be performed by the system firmware based upon FMP data published by the device.

### 23.3.3 Mapping Firmware Management Protocol Descriptors to ESRT Entries

Firmware management Protocol descriptors define most of the information needed for an ESRT entry. The table below helps identify which members map to which fields. Some members are dependent on certain versions of FMP and it is left to system firmware to resolve any mappings when information is not present in the FMP instance. FMP descriptors should only be mapped to ESRT entries if the following are true:

- An entry with the same *ImageTypeId* is not already in the ESRT.
- *AttributesSupported* and *AttributesSetting* have the **IMAGE\_ATTRIBUTE\_IN\_USE** bit set.
- In the case where *DescriptorCount* returned by **GetImageInfo()** is greater than one, firmware shall populate the ESRT according to system policy, noting however that multiple ESRT entries with identical FwClass values are not permitted.

ESRT Field	FMP Field	Comment
<i>FwClass</i>	<i>ImageTypeId</i>	The ImageTypeId GUID from the Firmware Management Protocol instance for a device is used as the Firmware Class GUID in the ESRT. Where there are multiple identical devices in the system, system firmware must create a mapping to ensure that the ESRT FwClass GUIDs are unique and consistent.
<i>FwVersion</i>	<i>Version</i>	Represents the current version of device firmware for an FMP instance.
<i>LowestSupportedFwVersion</i>	<i>LowestSupportedImageVersion</i>	
<i>LastAttemptVersion</i>	<i>LastAttemptVersion</i>	To be set after the completion of a firmware update attempt. In descriptor v3+ only. Default value is 0.
<i>LastAttemptStatus</i>	<i>LastAttemptStatus</i>	To be set after the completion of a firmware update attempt. In descriptor v3+ only. Default value is SUCCESS.

Table 189. ESRT and FMP Fields



## 24 Network Protocols — SNP, PXE, BIS and HTTP Boot

### 24.1 Simple Network Protocol

This section defines the Simple Network Protocol. This protocol provides a packet level interface to a network adapter.

#### EFI\_SIMPLE\_NETWORK\_PROTOCOL

##### Summary

The **EFI\_SIMPLE\_NETWORK\_PROTOCOL** provides services to initialize a network interface, transmit packets, receive packets, and close a network interface.

##### GUID

```
#define EFI_SIMPLE_NETWORK_PROTOCOL_GUID \
{0xA19832B9,0xAC25,0x11D3,\
 {0x9A,0x2D,0x00,0x90,0x27,0x3f,0xc1,0x4d}}
```

##### Revision Number

```
#define EFI_SIMPLE_NETWORK_PROTOCOL_REVISION 0x00010000
```

##### Protocol Interface Structure

```
typedef struct _EFI_SIMPLE_NETWORK_PROTOCOL_ {
    UINT64                               Revision;
    EFI_SIMPLE_NETWORK_START             Start;
    EFI_SIMPLE_NETWORK_STOP              Stop;
    EFI_SIMPLE_NETWORK_INITIALIZE        Initialize;
    EFI_SIMPLE_NETWORK_RESET            Reset;
    EFI_SIMPLE_NETWORK_SHUTDOWN         Shutdown;
    EFI_SIMPLE_NETWORK_RECEIVE_FILTERS  ReceiveFilters;
    EFI_SIMPLE_NETWORK_STATION_ADDRESS  StationAddress;
    EFI_SIMPLE_NETWORK_STATISTICS       Statistics;
    EFI_SIMPLE_NETWORK_MCAST_IP_TO_MAC MCastIpToMac;
    EFI_SIMPLE_NETWORK_NVDATA           NvData;
    EFI_SIMPLE_NETWORK_GET_STATUS       GetStatus;
    EFI_SIMPLE_NETWORK_TRANSMIT         Transmit;
    EFI_SIMPLE_NETWORK_RECEIVE          Receive;
    EFI_EVENT                            WaitForPacket;
    EFI_SIMPLE_NETWORK_MODE             *Mode;
} EFI_SIMPLE_NETWORK_PROTOCOL;
```

##### Parameters

*Revision*

Revision of the **EFI\_SIMPLE\_NETWORK\_PROTOCOL**. All future revisions must be backwards compatible. If a future

version is not backwards compatible it is not the same GUID.

<i>Start</i>	Prepares the network interface for further command operations. No other <b>EFI_SIMPLE_NETWORK_PROTOCOL</b> interface functions will operate until this call is made. See the <a href="#">Start()</a> function description.
<i>Stop</i>	Stops further network interface command processing. No other <b>EFI_SIMPLE_NETWORK_PROTOCOL</b> interface functions will operate after this call is made until another <b>Start()</b> call is made. See the <a href="#">Stop()</a> function description.
<i>Initialize</i>	Resets the network adapter and allocates the transmit and receive buffers. See the <a href="#">Initialize()</a> function description.
<i>Reset</i>	Resets the network adapter and reinitializes it with the parameters provided in the previous call to <b>Initialize()</b> . See the <a href="#">Reset()</a> function description.
<i>Shutdown</i>	Resets the network adapter and leaves it in a state safe for another driver to initialize. The memory buffers assigned in the <b>Initialize()</b> call are released. After this call, only the <b>Initialize()</b> or <b>Stop()</b> calls may be used. See the <a href="#">Shutdown()</a> function description.
<i>ReceiveFilters</i>	Enables and disables the receive filters for the network interface and, if supported, manages the filtered multicast HW MAC (Hardware Media Access Control) address list. See the <a href="#">ReceiveFilters()</a> function description.
<i>StationAddress</i>	Modifies or resets the current station address, if supported. See the <a href="#">StationAddress()</a> function description.
<i>Statistics</i>	Collects statistics from the network interface and allows the statistics to be reset. See the <a href="#">Statistics()</a> function description.
<i>MCastIpToMac</i>	Maps a multicast IP address to a multicast HW MAC address. See the <a href="#">MCastIPtoMAC()</a> function description.
<i>NvData</i>	Reads and writes the contents of the NVRAM devices attached to the network interface. See the <a href="#">NvData()</a> function description.
<i>GetStatus</i>	Reads the current interrupt status and the list of recycled transmit buffers from the network interface. See the <a href="#">GetStatus()</a> function description.
<i>Transmit</i>	Places a packet in the transmit queue. See the <a href="#">Transmit()</a> function description.
<i>Receive</i>	Retrieves a packet from the receive queue, along with the status flags that describe the packet type. See the <a href="#">Receive()</a> function description.
<i>WaitForPacket</i>	Event used with <a href="#">EFI_BOOT_SERVICES.WaitForEvent()</a> to wait for a packet to be received.

*Mode* Pointer to the [EFI\\_SIMPLE\\_NETWORK\\_MODE](#) data for the device. See “Related Definitions” below.

## Related Definitions

```

//*****
// EFI_SIMPLE_NETWORK_MODE
//
// Note that the fields in this data structure are read-only
// and are updated by the code that produces the
// EFI_SIMPLE_NETWORK_PROTOCOL
// functions. All these fields must be discovered
// in a protocol instance of
// EFI_DRIVER_BINDING_PROTOCOL.Start().
//*****
typedef struct {
  UINT32   State;
  UINT32   HwAddressSize;
  UINT32   MediaHeaderSize;
  UINT32   MaxPacketSize;
  UINT32   NvRamSize;
  UINT32   NvRamAccessSize;
  UINT32   ReceiveFilterMask;
  UINT32   ReceiveFilterSetting;
  UINT32   MaxMCastFilterCount;
  UINT32   MCastFilterCount;
  EFI_MAC_ADDRESS MCastFilter[MAX_MCAST_FILTER_CNT];
  EFI_MAC_ADDRESS CurrentAddress;
  EFI_MAC_ADDRESS BroadcastAddress;
  EFI_MAC_ADDRESS PermanentAddress;
  UINT8    IfType;
  BOOLEAN  MacAddressChangeable;
  BOOLEAN  MultipleTxSupported;
  BOOLEAN  MediaPresentSupported;
  BOOLEAN  MediaPresent;
} EFI_SIMPLE_NETWORK_MODE;

```

*State* Reports the current state of the network interface (see [EFI\\_SIMPLE\\_NETWORK\\_STATE](#) below). When an [EFI\\_SIMPLE\\_NETWORK\\_PROTOCOL](#) driver initializes a network interface, the network interface is left in the **EfiSimpleNetworkStopped** state.

*HwAddressSize* The size, in bytes, of the network interface’s HW address.

*MediaHeaderSize* The size, in bytes, of the network interface’s media header.

*MaxPacketSize* The maximum size, in bytes, of the packets supported by the network interface.

<i>NvRamSize</i>	The size, in bytes, of the NVRAM device attached to the network interface. If an NVRAM device is not attached to the network interface, then this field will be zero. This value must be a multiple of <i>NvramAccessSize</i> .
<i>NvRamAccessSize</i>	The size that must be used for all NVRAM reads and writes. The start address for NVRAM read and write operations and the total length of those operations, must be a multiple of this value. The legal values for this field are 0, 1, 2, 4, and 8. If the value is zero, then no NVRAM devices are attached to the network interface.
<i>ReceiveFilterMask</i>	The multicast receive filter settings supported by the network interface.
<i>ReceiveFilterSetting</i>	The current multicast receive filter settings. See “Bit Mask Values for <i>ReceiveFilterSetting</i> ” below.
<i>MaxMCastFilterCount</i>	The maximum number of multicast address receive filters supported by the driver. If this value is zero, then <code>ReceiveFilters()</code> cannot modify the multicast address receive filters. This field may be less than <b>MAX_MCAST_FILTER_CNT</b> (see below).
<i>MCastFilterCount</i>	The current number of multicast address receive filters.
<i>MCastFilter</i>	Array containing the addresses of the current multicast address receive filters.
<i>CurrentAddress</i>	The current HW MAC address for the network interface.
<i>BroadcastAddress</i>	The current HW MAC address for broadcast packets.
<i>PermanentAddress</i>	The permanent HW MAC address for the network interface.
<i>IfType</i>	The interface type of the network interface. See RFC 3232, section “Number Hardware Type.”
<i>MacAddressChangeable</i>	<b>TRUE</b> if the HW MAC address can be changed.
<i>MultipleTxSupported</i>	<b>TRUE</b> if the network interface can transmit more than one packet at a time.
<i>MediaPresentSupported</i>	<b>TRUE</b> if the presence of media can be determined; otherwise <b>FALSE</b> . If <b>FALSE</b> , <b>MediaPresent</b> cannot be used.
<i>MediaPresent</i>	<b>TRUE</b> if media are connected to the network interface; otherwise <b>FALSE</b> . This field shows the media present status as of the most recent <code>GetStatus()</code> call.



```

//*****
// EFI_SIMPLE_NETWORK_STATE
//*****
typedef enum {
  EfiSimpleNetworkStopped,
  EfiSimpleNetworkStarted,
  EfiSimpleNetworkInitialized,
  EfiSimpleNetworkMaxState
} EFI_SIMPLE_NETWORK_STATE;

//*****
// MAX_MCAST_FILTER_CNT
//*****
#define MAX_MCAST_FILTER_CNT      16

//*****
// Bit Mask Values for ReceiveFilterSetting.
//
// Note that all other bit values are reserved.
//*****
#define EFI_SIMPLE_NETWORK_RECEIVE_UNICAST    0x01
#define EFI_SIMPLE_NETWORK_RECEIVE_MULTICAST 0x02
#define EFI_SIMPLE_NETWORK_RECEIVE_BROADCAST 0x04
#define EFI_SIMPLE_NETWORK_RECEIVE_PROMISCUOUS 0x08
#define EFI_SIMPLE_NETWORK_RECEIVE_PROMISCUOUS_MULTICAST 0x10

```

## Description

The **EFI\_SIMPLE\_NETWORK\_PROTOCOL** protocol is used to initialize access to a network adapter. Once the network adapter initializes, the **EFI\_SIMPLE\_NETWORK\_PROTOCOL** protocol provides services that allow packets to be transmitted and received. This provides a packet level interface that can then be used by higher level drivers to produce boot services like DHCP, TFTP, and MTFTP. In addition, this protocol can be used as a building block in a full UDP and TCP/IP implementation that can produce a wide variety of application level network interfaces. See the *Preboot Execution Environment (PXE) Specification* for more information.

**Note:** *The underlying network hardware may only be able to access 4 GiB (32-bits) of system memory. Any requests to transfer data to/from memory above 4 GiB with 32-bit network hardware will be double-buffered (using intermediate buffers below 4 GiB) and will reduce performance.*

**Note:** *The same handle can have an instance of the **EFI\_ADAPTER\_INFORMATION\_PROTOCOL** with a **EFI\_ADAPTER\_INFO\_MEDIA\_STATE** type structure.*

## EFI\_SIMPLE\_NETWORK.Start()

### Summary

Changes the state of a network interface from “stopped” to “started.”

### Prototype

```
typedef
EFI_STATUS
(EFIAPI *EFI_SIMPLE_NETWORK_START) (
    IN EFI_SIMPLE_NETWORK_PROTOCOL *This
);
```

### Parameters

*This*

A pointer to the [EFI\\_SIMPLE\\_NETWORK\\_PROTOCOL](#) instance.

### Description

This function starts a network interface. If the network interface successfully starts, then **EFI\_SUCCESS** will be returned.

### Status Codes Returned

EFI_SUCCESS	The network interface was started.
EFI_ALREADY_STARTED	The network interface is already in the started state.
EFI_INVALID_PARAMETER	<i>This</i> parameter was <b>NULL</b> or did not point to a valid <code>EFI_SIMPLE_NETWORK_PROTOCOL</code> structure.
EFI_DEVICE_ERROR	The command could not be sent to the network interface.
EFI_UNSUPPORTED	This function is not supported by the network interface.

## EFI\_SIMPLE\_NETWORK.Stop()

### Summary

Changes the state of a network interface from “started” to “stopped.”

### Prototype

```
typedef
EFI_STATUS
(EFI_API *EFI_SIMPLE_NETWORK_STOP) (
    IN EFI_SIMPLE_NETWORK_PROTOCOL *This
);
```

### Parameters

*This* A pointer to the [EFI\\_SIMPLE\\_NETWORK\\_PROTOCOL](#) instance.

### Description

This function stops a network interface. This call is only valid if the network interface is in the started state. If the network interface was successfully stopped, then **EFI\_SUCCESS** will be returned.

### Status Codes Returned

EFI_SUCCESS	The network interface was stopped.
EFI_NOT_STARTED	The network interface has not been started.
EFI_INVALID_PARAMETER	<i>This</i> parameter was <b>NULL</b> or did not point to a valid <code>EFI_SIMPLE_NETWORK_PROTOCOL</code> structure.
EFI_DEVICE_ERROR	The command could not be sent to the network interface.
EFI_UNSUPPORTED	This function is not supported by the network interface.

## EFI\_SIMPLE\_NETWORK.Initialize()

### Summary

Resets a network adapter and allocates the transmit and receive buffers required by the network interface; optionally, also requests allocation of additional transmit and receive buffers.

### Prototype

```
typedef
EFI_STATUS
(EFI_API *EFI_SIMPLE_NETWORK_INITIALIZE) (
    IN EFI_SIMPLE_NETWORK_PROTOCOL *This,
    IN UINTN          ExtraRxBufferSize OPTIONAL,
    IN UINTN          ExtraTxBufferSize OPTIONAL
);
```

### Parameters

<i>This</i>	A pointer to the <a href="#">EFI_SIMPLE_NETWORK_PROTOCOL</a> instance.
<i>ExtraRxBufferSize</i>	The size, in bytes, of the extra receive buffer space that the driver should allocate for the network interface. Some network interfaces will not be able to use the extra buffer, and the caller will not know if it is actually being used.
<i>ExtraTxBufferSize</i>	The size, in bytes, of the extra transmit buffer space that the driver should allocate for the network interface. Some network interfaces will not be able to use the extra buffer, and the caller will not know if it is actually being used.

### Description

This function allocates the transmit and receive buffers required by the network interface. If this allocation fails, then **EFI\_OUT\_OF\_RESOURCES** is returned. If the allocation succeeds and the network interface is successfully initialized, then **EFI\_SUCCESS** will be returned.

### Status Codes Returned

EFI_SUCCESS	The network interface was initialized.
EFI_NOT_STARTED	The network interface has not been started.
EFI_OUT_OF_RESOURCES	There was not enough memory for the transmit and receive buffers.
EFI_INVALID_PARAMETER	<i>This</i> parameter was <b>NULL</b> or did not point to a valid <code>EFI_SIMPLE_NETWORK_PROTOCOL</code> structure.
EFI_DEVICE_ERROR	The command could not be sent to the network interface.
EFI_UNSUPPORTED	The increased buffer size feature is not supported.

## EFI\_SIMPLE\_NETWORK.Reset()

### Summary

Resets a network adapter and reinitializes it with the parameters that were provided in the previous call to [Initialize\(\)](#).

### Prototype

```
typedef
EFI_STATUS
(EFI_API *EFI_SIMPLE_NETWORK_RESET) (
    IN EFI_SIMPLE_NETWORK_PROTOCOL *This,
    IN BOOLEAN ExtendedVerification
);
```

### Parameters

*This*

A pointer to the [EFI\\_SIMPLE\\_NETWORK\\_PROTOCOL](#) instance.

*ExtendedVerification*

Indicates that the driver may perform a more exhaustive verification operation of the device during reset.

### Description

This function resets a network adapter and reinitializes it with the parameters that were provided in the previous call to [Initialize\(\)](#). The transmit and receive queues are emptied and all pending interrupts are cleared. Receive filters, the station address, the statistics, and the multicast-IP-to-HW MAC addresses are not reset by this call. If the network interface was successfully reset, then **EFI\_SUCCESS** will be returned. If the driver has not been initialized, **EFI\_DEVICE\_ERROR** will be returned.

### Status Codes Returned

EFI_SUCCESS	The network interface was reset.
EFI_NOT_STARTED	The network interface has not been started.
EFI_INVALID_PARAMETER	One or more of the parameters has an unsupported value.
EFI_DEVICE_ERROR	The command could not be sent to the network interface.
EFI_UNSUPPORTED	This function is not supported by the network interface.

## EFI\_SIMPLE\_NETWORK.Shutdown()

### Summary

Resets a network adapter and leaves it in a state that is safe for another driver to initialize.

### Prototype

```
typedef
EFI_STATUS
(EFI_API *EFI_SIMPLE_NETWORK_SHUTDOWN) (
  IN EFI_SIMPLE_NETWORK_PROTOCOL *This
);
```

### Parameters

*This* A pointer to the [EFI SIMPLE NETWORK PROTOCOL](#) instance.

### Description

This function releases the memory buffers assigned in the [Initialize\(\)](#) call. Pending transmits and receives are lost, and interrupts are cleared and disabled. After this call, only the [Initialize\(\)](#) and [Stop\(\)](#) calls may be used. If the network interface was successfully shutdown, then **EFI\_SUCCESS** will be returned. If the driver has not been initialized, **EFI\_DEVICE\_ERROR** will be returned.

### Status Codes Returned

EFI_SUCCESS	The network interface was shutdown.
EFI_NOT_STARTED	The network interface has not been started.
EFI_INVALID_PARAMETER	<i>This</i> parameter was <b>NULL</b> or did not point to a valid <code>EFI_SIMPLE_NETWORK_PROTOCOL</code> structure.
EFI_DEVICE_ERROR	The command could not be sent to the network interface.

## EFI\_SIMPLE\_NETWORK.ReceiveFilters()

### Summary

Manages the multicast receive filters of a network interface.

### Prototype

```
typedef
EFI_STATUS
(EFI_API *EFI_SIMPLE_NETWORK_RECEIVE_FILTERS) (
  IN EFI_SIMPLE_NETWORK_PROTOCOL *This,
  IN UINT32      Enable,
  IN UINT32      Disable,
  IN BOOLEAN     ResetMCastFilter,
  IN UINTN       MCastFilterCnt OPTIONAL,
  IN EFI_MAC_ADDRESS *MCastFilter OPTIONAL,
);
```

### Parameters

<i>This</i>	A pointer to the <a href="#">EFI_SIMPLE_NETWORK_PROTOCOL</a> instance.
<i>Enable</i>	A bit mask of receive filters to enable on the network interface.
<i>Disable</i>	A bit mask of receive filters to disable on the network interface. For backward compatibility with EFI 1.1 platforms, the <a href="#">EFI_SIMPLE_NETWORK_RECEIVE_MULTICAST</a> bit must be set when the <i>ResetMCastFilter</i> parameter is <b>TRUE</b> .
<i>ResetMCastFilter</i>	Set to <b>TRUE</b> to reset the contents of the multicast receive filters on the network interface to their default values.
<i>MCastFilterCnt</i>	Number of multicast HW MAC addresses in the new <i>MCastFilter</i> list. This value must be less than or equal to the <i>MCastFilterCnt</i> field of <a href="#">EFI_SIMPLE_NETWORK_MODE</a> . This field is optional if <i>ResetMCastFilter</i> is <b>TRUE</b> .
<i>MCastFilter</i>	A pointer to a list of new multicast receive filter HW MAC addresses. This list will replace any existing multicast HW MAC address list. This field is optional if <i>ResetMCastFilter</i> is <b>TRUE</b> .

### Description

This function is used enable and disable the hardware and software receive filters for the underlying network device.

The receive filter change is broken down into three steps:

- The filter mask bits that are set (ON) in the Enable parameter are added to the current receive filter settings.

- The filter mask bits that are set (ON) in the Disable parameter are subtracted from the updated receive filter settings.
- If the resulting receive filter setting is not supported by the hardware a more liberal setting is selected.

If the same bits are set in the Enable and Disable parameters, then the bits in the Disable parameter takes precedence.

If the `ResetMCastFilter` parameter is TRUE, then the multicast address list filter is disabled (irregardless of what other multicast bits are set in the Enable and Disable parameters). The `SNP->Mode->MCastFilterCount` field is set to zero. The `Snp->Mode->MCastFilter` contents are undefined.

After enabling or disabling receive filter settings, software should verify the new settings by checking the `Snp->Mode->ReceiveFilterSettings`, `Snp->Mode->MCastFilterCount` and `Snp->Mode->MCastFilter` fields.

**Note:** Some network drivers and/or devices will automatically promote receive filter settings if the requested setting can not be honored. For example, if a request for four multicast addresses is made and the underlying hardware only supports two multicast addresses the driver might set the promiscuous or promiscuous multicast receive filters instead. The receiving software is responsible for discarding any extra packets that get through the hardware receive filters.

**Note:** *Note: To disable all receive filter hardware, the network driver must be Shutdown() and Stopped(). Calling ReceiveFilters() with Disable set to Snp->Mode->ReceiveFilterSettings will make it so no more packets are returned by the Receive() function, but the receive hardware may still be moving packets into system memory before inspecting and discarding them. Unexpected system errors, reboots and hangs can occur if an OS is loaded and the network devices are not Shutdown() and Stopped().*

If `ResetMCastFilter` is **TRUE**, then the multicast receive filter list on the network interface will be reset to the default multicast receive filter list. If `ResetMCastFilter` is **FALSE**, and this network interface allows the multicast receive filter list to be modified, then the `MCastFilterCnt` and `MCastFilter` are used to update the current multicast receive filter list. The modified receive filter list settings can be found in the `MCastFilter` field of [EFI\\_SIMPLE\\_NETWORK\\_MODE](#). If the network interface does not allow the multicast receive filter list to be modified, then `EFI_INVALID_PARAMETER` will be returned. If the driver has not been initialized, `EFI_DEVICE_ERROR` will be returned.

If the receive filter mask and multicast receive filter list have been successfully updated on the network interface, `EFI_SUCCESS` will be returned.

## Status Codes Returned

EFI_SUCCESS	The multicast receive filter list was updated.
EFI_NOT_STARTED	The network interface has not been started.



EFI_INVALID_PARAMETER	<ul style="list-style-type: none"> <li>• One or more of the following conditions is <b>TRUE</b>:</li> <li>• <i>This</i> is <b>NULL</b></li> <li>• There are bits set in Enable that are not set in Snp-&gt;Mode-&gt;ReceiveFilterMask</li> <li>• There are bits set in Disable that are not set in Snp-&gt;Mode-&gt;ReceiveFilterMask</li> <li>• Multicast is being enabled (the EFI_SIMPLE_NETWORK_RECEIVE_MULTICAST bit is set in Enable, it is not set in Disable, and ResetMCastFilter is <b>FALSE</b>) and MCastFilterCount is zero</li> <li>• Multicast is being enabled and MCastFilterCount is greater than Snp-&gt;Mode-&gt;MaxMCastFilterCount</li> <li>• Multicast is being enabled and MCastFilter is <b>NULL</b></li> <li>• Multicast is being enabled and one or more of the addresses in the MCastFilter list are not valid multicast MAC addresses</li> </ul>
EFI_DEVICE_ERROR	<ul style="list-style-type: none"> <li>• One or more of the following conditions is <b>TRUE</b>:</li> <li>• The network interface has been started but has not been initialized</li> <li>• An unexpected error was returned by the underlying network driver or device</li> </ul>
EFI_UNSUPPORTED	This function is not supported by the network interface.

## EFI\_SIMPLE\_NETWORK.StationAddress()

### Summary

Modifies or resets the current station address, if supported.

### Prototype

```
typedef
EFI_STATUS
(EFI_API *EFI_SIMPLE_NETWORK_STATION_ADDRESS) (
  IN EFI_SIMPLE_NETWORK_PROTOCOL *This,
  IN BOOLEAN      Reset,
  IN EFI_MAC_ADDRESS *New OPTIONAL
);
```

### Parameters

<i>This</i>	A pointer to the <a href="#">EFI_SIMPLE_NETWORK_PROTOCOL</a> instance.
<i>Reset</i>	Flag used to reset the station address to the network interface's permanent address.
<i>New</i>	New station address to be used for the network interface.

### Description

This function modifies or resets the current station address of a network interface, if supported. If **Reset** is **TRUE**, then the current station address is set to the network interface's permanent address. If **Reset** is **FALSE**, and the network interface allows its station address to be modified, then the current station address is changed to the address specified by **New**. If the network interface does not allow its station address to be modified, then **EFI\_INVALID\_PARAMETER** will be returned. If the station address is successfully updated on the network interface, **EFI\_SUCCESS** will be returned. If the driver has not been initialized, **EFI\_DEVICE\_ERROR** will be returned.

### Status Codes Returned

EFI_SUCCESS	The network interface's station address was updated.
EFI_NOT_STARTED	The Simple Network Protocol interface has not been started by calling <b>Start()</b> .
EFI_INVALID_PARAMETER	The <i>New</i> station address was not accepted by the NIC.
EFI_INVALID_PARAMETER	<i>Reset</i> is <b>FALSE</b> and <i>New</i> is <b>NULL</b> .
EFI_DEVICE_ERROR	The Simple Network Protocol interface has not been initialized by calling <b>Initialize()</b> .
EFI_DEVICE_ERROR	An error occurred attempting to set the new station address.
EFI_UNSUPPORTED	The NIC does not support changing the network interface's station address.

## EFI\_SIMPLE\_NETWORK.Statistics()

### Summary

Resets or collects the statistics on a network interface.

### Prototype

```
typedef
EFI_STATUS
(EFI_API *EFI_SIMPLE_NETWORK_STATISTICS) (
  IN EFI_SIMPLE_NETWORK_PROTOCOL *This,
  IN BOOLEAN      Reset,
  IN OUT UINTN    *StatisticsSize OPTIONAL,
  OUT EFI_NETWORK_STATISTICS *StatisticsTable OPTIONAL
);
```

### Parameters

<i>This</i>	A pointer to the <a href="#">EFI_SIMPLE_NETWORK_PROTOCOL</a> instance.
<i>Reset</i>	Set to <b>TRUE</b> to reset the statistics for the network interface.
<i>StatisticsSize</i>	On input the size, in bytes, of <i>StatisticsTable</i> . On output the size, in bytes, of the resulting table of statistics.
<i>StatisticsTable</i>	A pointer to the <a href="#">EFI_NETWORK_STATISTICS</a> structure that contains the statistics. Type <b>EFI_NETWORK_STATISTICS</b> is defined in “Related Definitions” below.

## Related Definitions

```

//*****
// EFI_NETWORK_STATISTICS
//
// Any statistic value that is -1 is not available
// on the device and is to be ignored.
//*****
typedef struct {
  UINT64  RxTotalFrames;
  UINT64  RxGoodFrames;
  UINT64  RxUndersizeFrames;
  UINT64  RxOversizeFrames;
  UINT64  RxDroppedFrames;
  UINT64  RxUnicastFrames;
  UINT64  RxBroadcastFrames;
  UINT64  RxMulticastFrames;
  UINT64  RxCrcErrorFrames;
  UINT64  RxTotalBytes;
  UINT64  TxTotalFrames;
  UINT64  TxGoodFrames;
  UINT64  TxUndersizeFrames;
  UINT64  TxOversizeFrames;
  UINT64  TxDroppedFrames;
  UINT64  TxUnicastFrames;
  UINT64  TxBroadcastFrames;
  UINT64  TxMulticastFrames;
  UINT64  TxCrcErrorFrames;
  UINT64  TxTotalBytes;
  UINT64  Collisions;
  UINT64  UnsupportedProtocol;
  UINT64  RxDuplicatedFrames;
  UINT64  RxDecryptErrorFrames;
  UINT64  TxErrorFrames;
  UINT64  TxRetryFrames;
} EFI_NETWORK_STATISTICS;

```

<i>RxTotalFrames</i>	Total number of frames received. Includes frames with errors and dropped frames.
<i>RxGoodFrames</i>	Number of valid frames received and copied into receive buffers.
<i>RxUndersizeFrames</i>	Number of frames below the minimum length for the communications device.
<i>RxOversizeFrames</i>	Number of frames longer than the maximum length for the communications device.

<i>RxDroppedFrames</i>	Valid frames that were dropped because receive buffers were full.
<i>RxUnicastFrames</i>	Number of valid unicast frames received and not dropped.
<i>RxBroadcastFrames</i>	Number of valid broadcast frames received and not dropped.
<i>RxMulticastFrames</i>	Number of valid multicast frames received and not dropped.
<i>RxCrcErrorFrames</i>	Number of frames with CRC or alignment errors.
<i>RxTotalBytes</i>	Total number of bytes received. Includes frames with errors and dropped frames.
<i>TxTotalFrames</i>	Total number of frames transmitted. Includes frames with errors and dropped frames.
<i>TxGoodFrames</i>	Number of valid frames transmitted and copied into receive buffers.
<i>TxUndersizeFrames</i>	Number of frames below the minimum length for the media. This would be less than 64 for Ethernet.
<i>TxOversizeFrames</i>	Number of frames longer than the maximum length for the media. This would be greater than 1500 for Ethernet.
<i>TxDroppedFrames</i>	Valid frames that were dropped because receive buffers were full.
<i>TxUnicastFrames</i>	Number of valid unicast frames transmitted and not dropped.
<i>TxBroadcastFrames</i>	Number of valid broadcast frames transmitted and not dropped.
<i>TxMulticastFrames</i>	Number of valid multicast frames transmitted and not dropped.
<i>TxCrcErrorFrames</i>	Number of frames with CRC or alignment errors.
<i>TxTotalBytes</i>	Total number of bytes transmitted. Includes frames with errors and dropped frames.
<i>Collisions</i>	Number of collisions detected on this subnet.
<i>UnsupportedProtocol</i>	Number of frames destined for unsupported protocol.
<i>RxDuplicatedFrames</i>	Number of valid frames received that were duplicated.
<i>RxDecryptErrorFrames</i>	Number of encrypted frames received that failed to decrypt.
<i>TxErrorFrames</i>	Number of frames that failed to transmit after exceeding the retry limit.
<i>TxRetryFrames</i>	Number of frames transmitted successfully after more than one attempt.

## Description

This function resets or collects the statistics on a network interface. If the size of the statistics table specified by **StatisticsSize** is not big enough for all the statistics that are collected by the network interface, then a partial buffer of statistics is returned in

**StatisticsTable**, **StatisticsSize** is set to the size required to collect all the available statistics, and **EFI\_BUFFER\_TOO\_SMALL** is returned.

If **StatisticsSize** is big enough for all the statistics, then **StatisticsTable** will be filled, **StatisticsSize** will be set to the size of the returned **StatisticsTable** structure, and **EFI\_SUCCESS** is returned. If the driver has not been initialized, **EFI\_DEVICE\_ERROR** will be returned.

If **Reset** is **FALSE**, and both **StatisticsSize** and **StatisticsTable** are **NULL**, then no operations will be performed, and **EFI\_SUCCESS** will be returned.

If **Reset** is **TRUE**, then all of the supported statistics counters on this network interface will be reset to zero.

## Status Codes Returned

EFI_SUCCESS	The requested operation succeeded.
EFI_NOT_STARTED	The Simple Network Protocol interface has not been started by calling <b>Start()</b> .
EFI_BUFFER_TOO_SMALL	<i>StatisticsSize</i> is not <b>NULL</b> and <i>StatisticsTable</i> is <b>NULL</b> . The current buffer size that is needed to hold all the statistics is returned in <i>StatisticsSize</i> .
EFI_BUFFER_TOO_SMALL	<i>StatisticsSize</i> is not <b>NULL</b> and <i>StatisticsTable</i> is not <b>NULL</b> . The current buffer size that is needed to hold all the statistics is returned in <i>StatisticsSize</i> . A partial set of statistics is returned in <i>StatisticsTable</i> .
EFI_INVALID_PARAMETER	<i>StatisticsSize</i> is <b>NULL</b> and <i>StatisticsTable</i> is not <b>NULL</b> .
EFI_DEVICE_ERROR	The Simple Network Protocol interface has not been initialized by calling <b>Initialize()</b> .
EFI_DEVICE_ERROR	An error was encountered collecting statistics from the NIC.
EFI_UNSUPPORTED	The NIC does not support collecting statistics from the network interface.

## EFI\_SIMPLE\_NETWORK.MCastIPtoMAC()

### Summary

Converts a multicast IP address to a multicast HW MAC address.

### Prototype

```
typedef
EFI_STATUS
(EFIAPI *EFI_SIMPLE_NETWORK_MCAST_IP_TO_MAC) (
  IN EFI_SIMPLE_NETWORK_PROTOCOL *This,
  IN BOOLEAN IPv6,
  IN EFI_IP_ADDRESS *IP,
  OUT EFI_MAC_ADDRESS *MAC
);
```

### Parameters

<i>This</i>	A pointer to the <a href="#">EFI_SIMPLE_NETWORK_PROTOCOL</a> instance.
<i>IPv6</i>	Set to <b>TRUE</b> if the multicast IP address is IPv6 [RFC 2460]. Set to <b>FALSE</b> if the multicast IP address is IPv4 [RFC 791].
<i>IP</i>	The multicast IP address that is to be converted to a multicast HW MAC address.
<i>MAC</i>	The multicast HW MAC address that is to be generated from <i>IP</i> .

### Description

This function converts a multicast IP address to a multicast HW MAC address for all packet transactions. If the mapping is accepted, then **EFI\_SUCCESS** will be returned.

### Status Codes Returned

EFI_SUCCESS	The multicast IP address was mapped to the multicast HW MAC address.
EFI_NOT_STARTED	The Simple Network Protocol interface has not been started by calling <b>Start()</b> .
EFI_INVALID_PARAMETER	<i>IP</i> is <b>NULL</b> .
EFI_INVALID_PARAMETER	<i>MAC</i> is <b>NULL</b> .
EFI_INVALID_PARAMETER	<i>IP</i> does not point to a valid IPv4 or IPv6 multicast address.
EFI_DEVICE_ERROR	The Simple Network Protocol interface has not been initialized by calling <b>Initialize()</b> .
EFI_UNSUPPORTED	<i>IPv6</i> is <b>TRUE</b> and the implementation does not support IPv6 multicast to MAC address conversion.

## EFI\_SIMPLE\_NETWORK.NvData()

### Summary

Performs read and write operations on the NVRAM device attached to a network interface.

### Prototype

```
typedef
EFI_STATUS
(EFIAPI *EFI_SIMPLE_NETWORK_NVDATA) (
  IN EFI_SIMPLE_NETWORK_PROTOCOL *This
  IN BOOLEAN      ReadWrite,
  IN UINTN       Offset,
  IN UINTN       BufferSize,
  IN OUT VOID    *Buffer
);
```

### Parameters

<i>This</i>	A pointer to the <a href="#">EFI_SIMPLE_NETWORK_PROTOCOL</a> instance.
<i>ReadWrite</i>	<b>TRUE</b> for read operations, <b>FALSE</b> for write operations.
<i>Offset</i>	Byte offset in the NVRAM device at which to start the read or write operation. This must be a multiple of <i>NvRamAccessSize</i> and less than <i>NvRamSize</i> . (See <a href="#">EFI_SIMPLE_NETWORK_MODE</a> )
<i>BufferSize</i>	The number of bytes to read or write from the NVRAM device. This must also be a multiple of <i>NvramAccessSize</i> .
<i>Buffer</i>	A pointer to the data buffer.

### Description

This function performs read and write operations on the NVRAM device attached to a network interface. If **ReadWrite** is **TRUE**, a read operation is performed. If **ReadWrite** is **FALSE**, a write operation is performed.

**Offset** specifies the byte offset at which to start either operation. **Offset** must be a multiple of **NvRamAccessSize**, and it must have a value between zero and **NvRamSize**.

**BufferSize** specifies the length of the read or write operation. **BufferSize** must also be a multiple of **NvRamAccessSize**, and **Offset + BufferSize** must not exceed **NvRamSize**.

If any of the above conditions is not met, then **EFI\_INVALID\_PARAMETER** will be returned.

If all the conditions are met and the operation is “read,” the NVRAM device attached to the network interface will be read into **Buffer** and **EFI\_SUCCESS** will be returned. If this is a write operation, the contents of **Buffer** will be used to update the contents of the NVRAM device attached to the network interface and **EFI\_SUCCESS** will be returned.



## Status Codes Returned

EFI_SUCCESS	The NVRAM access was performed.
EFI_NOT_STARTED	The network interface has not been started.
EFI_INVALID_PARAMETER	<p>One or more of the following conditions is <b>TRUE</b>:</p> <ul style="list-style-type: none"> <li>• The <i>This</i> parameter is <b>NULL</b></li> <li>• The <i>This</i> parameter does not point to a valid <b>EFI_SIMPLE_NETWORK_PROTOCOL</b> structure</li> <li>• The <i>Offset</i> parameter is not a multiple of <b>EFI_SIMPLE_NETWORK_MODE.NvRamAccessSize</b></li> <li>• The <i>Offset</i> parameter is not less than <b>EFI_SIMPLE_NETWORK_MODE.NvRamSize</b></li> <li>• The <i>BufferSize</i> parameter is not a multiple of <b>EFI_SIMPLE_NETWORK_MODE.NvRamAccessSize</b></li> </ul> <p>The <i>Buffer</i> parameter is <b>NULL</b></p>
EFI_DEVICE_ERROR	The command could not be sent to the network interface.
EFI_UNSUPPORTED	This function is not supported by the network interface.

## EFI\_SIMPLE\_NETWORK.GetStatus()

### Summary

Reads the current interrupt status and recycled transmit buffer status from a network interface.

### Prototype

```
typedef
EFI_STATUS
(EFI_API *EFI_SIMPLE_NETWORK_GET_STATUS) (
  IN EFI_SIMPLE_NETWORK_PROTOCOL *This,
  OUT UINT32 *InterruptStatus OPTIONAL,
  OUT VOID **TxBuf OPTIONAL
);
```

### Parameters

<i>This</i>	A pointer to the <a href="#">EFI_SIMPLE_NETWORK_PROTOCOL</a> instance.
<i>InterruptStatus</i>	A pointer to the bit mask of the currently active interrupts (see “Related Definitions”). If this is <b>NULL</b> , the interrupt status will not be read from the device. If this is not <b>NULL</b> , the interrupt status will be read from the device. When the interrupt status is read, it will also be cleared. Clearing the transmit interrupt does not empty the recycled transmit buffer array.
<i>TxBuf</i>	Recycled transmit buffer address. The network interface will not transmit if its internal recycled transmit buffer array is full. Reading the transmit buffer does not clear the transmit interrupt. If this is <b>NULL</b> , then the transmit buffer status will not be read. If there are no transmit buffers to recycle and <i>TxBuf</i> is not <b>NULL</b> , * <i>TxBuf</i> will be set to <b>NULL</b> .

### Related Definitions

```
/**
// *****
// Interrupt Bit Mask Settings for InterruptStatus.
// Note that all other bit values are reserved.
// *****
#define EFI_SIMPLE_NETWORK_RECEIVE_INTERRUPT 0x01
#define EFI_SIMPLE_NETWORK_TRANSMIT_INTERRUPT 0x02
#define EFI_SIMPLE_NETWORK_COMMAND_INTERRUPT 0x04
#define EFI_SIMPLE_NETWORK_SOFTWARE_INTERRUPT 0x08
```

### Description

This function gets the current interrupt and recycled transmit buffer status from the network interface. The interrupt status is returned as a bit mask in **InterruptStatus**. If **InterruptStatus** is **NULL**, the interrupt status will not be read. Upon successful return of

the media status, the *MediaPresent* field of **EFI\_SIMPLE\_NETWORK\_MODE** will be updated to reflect any change of media status. Upon successful return of the media status, the *MediaPresent* field of **EFI\_SIMPLE\_NETWORK\_MODE** will be updated to reflect any change of media status. If **TxBuf** is not **NULL**, a recycled transmit buffer address will be retrieved. If a recycled transmit buffer address is returned in **TxBuf**, then the buffer has been successfully transmitted, and the status for that buffer is cleared. If the status of the network interface is successfully collected, **EFI\_SUCCESS** will be returned. If the driver has not been initialized, **EFI\_DEVICE\_ERROR** will be returned.

### Status Codes Returned

EFI_SUCCESS	The status of the network interface was retrieved.
EFI_NOT_STARTED	The network interface has not been started.
EFI_INVALID_PARAMETER	<i>This</i> parameter was <b>NULL</b> or did not point to a valid <b>EFI_SIMPLE_NETWORK_PROTOCOL</b> structure.
EFI_DEVICE_ERROR	The command could not be sent to the network interface.

## EFI\_SIMPLE\_NETWORK.Transmit()

### Summary

Places a packet in the transmit queue of a network interface.

### Prototype

```
typedef
EFI_STATUS
(EFI_API *EFI_SIMPLE_NETWORK_TRANSMIT) (
  IN EFI_SIMPLE_NETWORK_PROTOCOL *This
  IN UINTN      HeaderSize,
  IN UINTN      BufferSize,
  IN VOID       *Buffer,
  IN EFI_MAC_ADDRESS *SrcAddr OPTIONAL,
  IN EFI_MAC_ADDRESS *DestAddr OPTIONAL,
  IN UINT16      *Protocol OPTIONAL,
);
```

### Parameters

<i>This</i>	A pointer to the <a href="#">EFI_SIMPLE_NETWORK_PROTOCOL</a> instance.
<i>HeaderSize</i>	The size, in bytes, of the media header to be filled in by the <b>Transmit()</b> function. If <i>HeaderSize</i> is nonzero, then it must be equal to <i>This-&gt;Mode-&gt;MediaHeaderSize</i> and the <i>DestAddr</i> and <i>Protocol</i> parameters must not be <b>NULL</b> .
<i>BufferSize</i>	The size, in bytes, of the entire packet (media header and data) to be transmitted through the network interface.
<i>Buffer</i>	A pointer to the packet (media header followed by data) to be transmitted. This parameter cannot be <b>NULL</b> . If <i>HeaderSize</i> is zero, then the media header in <i>Buffer</i> must already be filled in by the caller. If <i>HeaderSize</i> is nonzero, then the media header will be filled in by the <b>Transmit()</b> function.
<i>SrcAddr</i>	The source HW MAC address. If <i>HeaderSize</i> is zero, then this parameter is ignored. If <i>HeaderSize</i> is nonzero and <i>SrcAddr</i> is <b>NULL</b> , then <i>This-&gt;Mode-&gt;CurrentAddress</i> is used for the source HW MAC address.
<i>DestAddr</i>	The destination HW MAC address. If <i>HeaderSize</i> is zero, then this parameter is ignored.
<i>Protocol</i>	The type of header to build. If <i>HeaderSize</i> is zero, then this parameter is ignored. See RFC 3232, section "Ether Types," for examples.

### Description

This function places the packet specified by **Header** and **Buffer** on the transmit queue. If **HeaderSize** is nonzero and **HeaderSize** is not equal to

**This->Mode->MediaHeaderSize**, then **EFI\_INVALID\_PARAMETER** will be returned. If **BufferSize** is less than **This->Mode->MediaHeaderSize**, then **EFI\_BUFFER\_TOO\_SMALL** will be returned. If **Buffer** is **NULL**, then **EFI\_INVALID\_PARAMETER** will be returned. If **HeaderSize** is nonzero and **DestAddr** or **Protocol** is **NULL**, then **EFI\_INVALID\_PARAMETER** will be returned. If the transmit engine of the network interface is busy, then **EFI\_NOT\_READY** will be returned. If this packet can be accepted by the transmit engine of the network interface, the packet contents specified by **Buffer** will be placed on the transmit queue of the network interface, and **EFI\_SUCCESS** will be returned. **GetStatus()** can be used to determine when the packet has actually been transmitted. The contents of the *Buffer* must not be modified until the packet has actually been transmitted.

The **Transmit()** function performs nonblocking I/O. A caller who wants to perform blocking I/O, should call **Transmit()**, and then **GetStatus()** until the transmitted buffer shows up in the recycled transmit buffer.

If the driver has not been initialized, **EFI\_DEVICE\_ERROR** will be returned.

## Status Codes Returned

EFI_SUCCESS	The packet was placed on the transmit queue.
EFI_NOT_STARTED	The network interface has not been started.
EFI_NOT_READY	The network interface is too busy to accept this transmit request.
EFI_BUFFER_TOO_SMALL	The <i>BufferSize</i> parameter is too small.
EFI_INVALID_PARAMETER	One or more of the parameters has an unsupported value.
EFI_DEVICE_ERROR	The command could not be sent to the network interface.
EFI_UNSUPPORTED	This function is not supported by the network interface.

## EFI\_SIMPLE\_NETWORK.Receive()

### Summary

Receives a packet from a network interface.

### Prototype

```
typedef
EFI_STATUS
(EFI_API *EFI_SIMPLE_NETWORK_RECEIVE) (
  IN EFI_SIMPLE_NETWORK_PROTOCOL *This
  OUT UINTN          *HeaderSize OPTIONAL,
  IN OUT UINTN      *BufferSize,
  OUT VOID          *Buffer,
  OUT EFI_MAC_ADDRESS *SrcAddr OPTIONAL,
  OUT EFI_MAC_ADDRESS *DestAddr OPTIONAL,
  OUT UINT16        *Protocol OPTIONAL
);
```

### Parameters

<i>This</i>	A pointer to the <a href="#">EFI_SIMPLE_NETWORK_PROTOCOL</a> instance.
<i>HeaderSize</i>	The size, in bytes, of the media header received on the network interface. If this parameter is <b>NULL</b> , then the media header size will not be returned.
<i>BufferSize</i>	On entry, the size, in bytes, of <i>Buffer</i> . On exit, the size, in bytes, of the packet that was received on the network interface.
<i>Buffer</i>	A pointer to the data buffer to receive both the media header and the data.
<i>SrcAddr</i>	The source HW MAC address. If this parameter is <b>NULL</b> , the HW MAC source address will not be extracted from the media header.
<i>DestAddr</i>	The destination HW MAC address. If this parameter is <b>NULL</b> , the HW MAC destination address will not be extracted from the media header.
<i>Protocol</i>	The media header type. If this parameter is <b>NULL</b> , then the protocol will not be extracted from the media header. See RFC 1700 section "Ether Types" for examples.

### Description

This function retrieves one packet from the receive queue of a network interface. If there are no packets on the receive queue, then **EFI\_NOT\_READY** will be returned. If there is a packet on the receive queue, and the size of the packet is smaller than **BufferSize**, then the contents of the packet will be placed in **Buffer**, and **BufferSize** will be updated with the actual size of the packet. In addition, if **SrcAddr**, **DestAddr**, and **Protocol** are not

**NULL**, then these values will be extracted from the media header and returned. **EFI\_SUCCESS** will be returned if a packet was successfully received. If **BufferSize** is smaller than the received packet, then the size of the receive packet will be placed in **BufferSize** and **EFI\_BUFFER\_TOO\_SMALL** will be returned. If the driver has not been initialized, **EFI\_DEVICE\_ERROR** will be returned.

## Status Codes Returned

EFI_SUCCESS	The received data was stored in <i>Buffer</i> , and <i>BufferSize</i> has been updated to the number of bytes received.
EFI_NOT_STARTED	The network interface has not been started.
EFI_NOT_READY	No packets have been received on the network interface.
EFI_BUFFER_TOO_SMALL	<i>BufferSize</i> is too small for the received packets. <i>BufferSize</i> has been updated to the required size.
EFI_INVALID_PARAMETER	One or more of the following conditions is <b>TRUE</b> : <ul style="list-style-type: none"> <li>The <i>This</i> parameter is <b>NULL</b></li> <li>The <i>This</i> parameter does not point to a valid <b>EFI_SIMPLE_NETWORK_PROTOCOL</b> structure.</li> <li>The <i>BufferSize</i> parameter is <b>NULL</b></li> <li>The <i>Buffer</i> parameter is <b>NULL</b></li> </ul>
EFI_DEVICE_ERROR	The command could not be sent to the network interface.

## 24.2 Network Interface Identifier Protocol

This is an optional protocol that is used to describe details about the software layer that is used to produce the Simple Network Protocol. This protocol is only required if the underlying network interface is 16-bit UNDI, 32/64-bit S/W UNDI, or H/W UNDI. It is used to obtain type and revision information about the underlying network interface.

An instance of the Network Interface Identifier protocol must be created for each physical external network interface that is controlled by the IPXE structure. The IPXE structure is defined in the 32/64-bit UNDI Specification in Appendix E.

### EFI\_NETWORK\_INTERFACE\_IDENTIFIER\_PROTOCOL

#### Summary

An optional protocol that is used to describe details about the software layer that is used to produce the Simple Network Protocol.

## GUID

```
#define EFI_NETWORK_INTERFACE_IDENTIFIER_PROTOCOL_GUID_31 \
{0x1ACED566, 0x76ED, 0x4218, \
{0xBC, 0x81, 0x76, 0x7F, 0x1F, 0x97, 0x7A, 0x89}}
```

## Revision Number

```
#define EFI_NETWORK_INTERFACE_IDENTIFIER_PROTOCOL_REVISION \
0x00020000
```

## Protocol Interface Structure

```
typedef struct {
    UINT64  Revision;
    UINT64  Id;
    UINT64  ImageAddr;
    UINT32  ImageSize;
    CHAR8   StringId[4];
    UINT8   Type;
    UINT8   MajorVer;
    UINT8   MinorVer;
    BOOLEAN Ipv6Supported;
    UINT16  IfNum;
} EFI_NETWORK_INTERFACE_IDENTIFIER_PROTOCOL;
```

## Parameters

*Revision*

The revision of the **EFI\_NETWORK\_INTERFACE\_IDENTIFIER** protocol.

*Id*

Address of the first byte of the identifying structure for this network interface. This is only valid when the network interface is started (see [Start\(\)](#)). When the network interface is not started, this field is set to zero.

### 16-bit UNDI and 32/64-bit S/W UNDI:

**Id** contains the address of the first byte of the copy of the **!PXE** structure in the relocated UNDI code segment. See the *Preboot Execution Environment (PXE) Specification* and Appendix E.

### H/W UNDI:

**Id** contains the address of the **!PXE** structure.

*ImageAddr*

Address of the unrelocated network interface image.

### 16-bit UNDI:

**ImageAddr** is the address of the PXE option ROM image in upper memory.

### 32/64-bit S/W UNDI:

**ImageAddr** is the address of the unrelocated S/W UNDI image.



	<b>H/W UNDI:</b> <i>ImageAddr</i> contains zero.
<i>ImageSize</i>	Size of unrelocated network interface image. <b>16-bit UNDI:</b> <b>ImageSize</b> is the size of the PXE option ROM image in upper memory. <b>32/64-bit S/W UNDI:</b> <b>ImageSize</b> is the size of the unrelocated S/W UNDI image.
	<b>H/W UNDI:</b> <b>ImageSize</b> contains zero.
<i>StringId</i>	A four-character ASCII string that is sent in the class identifier field of option 60 in DHCP. For a <i>Type</i> of <b>EfiNetworkInterfaceUdi</b> , this field is "UNDI."
<i>Type</i>	Network interface type. This will be set to one of the values in <b>EFI_NETWORK_INTERFACE_TYPE</b> (see "Related Definitions" below).
<i>MajorVer</i>	Major version number. <b>16-bit UNDI:</b> <b>MajorVer</b> comes from the third byte of the <b>UNDIRev</b> field in the <b>UNDI ROM ID</b> structure. Refer to the <i>Preboot Execution Environment (PXE) Specification</i> . <b>32/64-bit S/W UNDI and H/W UNDI:</b> <b>MajorVer</b> comes from the <b>Major</b> field in the <b>!PXE</b> structure. See Appendix E.
<i>MinorVer</i>	Minor version number. <b>16-bit UNDI:</b> <b>MinorVer</b> comes from the second byte of the <b>UNDIRev</b> field in the <b>UNDI ROM ID</b> structure. Refer to the <i>Preboot Execution Environment (PXE) Specification</i> . <b>32/64-bit S/W UNDI and H/W UNDI:</b> <b>MinorVer</b> comes from the <b>Minor</b> field in the <b>!PXE</b> structure. See Appendix E.
<i>Ipv6Supported</i>	<b>TRUE</b> if the network interface supports IPv6; otherwise <b>FALSE</b> .
<i>IfNum</i>	The network interface number that is being identified by this Network Interface Identifier Protocol. This field must be less than or equal to the (IFcnt   IFcntExt <<8) field in the <b>!PXE</b> structure.

## Related Definitions

```

//*****
// EFI_NETWORK_INTERFACE_TYPE
//*****
typedef enum {
  EfiNetworkInterfaceUndi = 1
} EFI_NETWORK_INTERFACE_TYPE;

```

## Description

The **EFI\_NETWORK\_INTERFACE\_IDENTIFIER\_PROTOCOL** is used by **EFI\_PXE\_BASE\_CODE\_PROTOCOL** and OS loaders to identify the type of the underlying network interface and to locate its initial entry point.

## 24.3 PXE Base Code Protocol

This section defines the Preboot Execution Environment (PXE) Base Code protocol, which is used to access PXE-compatible devices for network access and network booting. For more information about PXE, see “Links to UEFI-Related Documents” (<http://uefi.org/uefi>) under the heading “Preboot Execution Environment (PXE) Specification”.

### EFI\_PXE\_BASE\_CODE\_PROTOCOL

#### Summary

The **EFI\_PXE\_BASE\_CODE\_PROTOCOL** is used to control PXE-compatible devices. The features of these devices are defined in the *Preboot Execution Environment (PXE) Specification*. An **EFI\_PXE\_BASE\_CODE\_PROTOCOL** will be layered on top of an **EFI\_MANAGED\_NETWORK\_PROTOCOL** protocol in order to perform packet level transactions. The **EFI\_PXE\_BASE\_CODE\_PROTOCOL** handle also supports the **EFI\_LOAD\_FILE\_PROTOCOL** protocol. This provides a clean way to obtain control from the boot manager if the boot path is from the remote device.

## GUID

```
#define EFI_PXE_BASE_CODE_PROTOCOL_GUID \
{0x03C4E603,0xAC28,0x11d3,\
{0x9A,0x2D,0x00,0x90,0x27,0x3F,0xC1,0x4D}}
```

## Revision Number

```
#define EFI_PXE_BASE_CODE_PROTOCOL_REVISION 0x00010000
```

## Protocol Interface Structure

```
typedef struct {
    UINT64      Revision;
    EFI_PXE_BASE_CODE_START   Start;
    EFI_PXE_BASE_CODE_STOP    Stop;
    EFI_PXE_BASE_CODE_DHCP    Dhcp;
    EFI_PXE_BASE_CODE_DISCOVER Discover;
    EFI_PXE_BASE_CODE_MTFTP   Mtftp;
    EFI_PXE_BASE_CODE_UDP_WRITE UdpWrite;
    EFI_PXE_BASE_CODE_UDP_READ  UdpRead;
    EFI_PXE_BASE_CODE_SET_IP_FILTER SetIpFilter;
    EFI_PXE_BASE_CODE_ARP      Arp;
    EFI_PXE_BASE_CODE_SET_PARAMETERS SetParameters;
    EFI_PXE_BASE_CODE_SET_STATION_IP SetStationIp;
    EFI_PXE_BASE_CODE_SET_PACKETS SetPackets;
    EFI_PXE_BASE_CODE_MODE      *Mode;
} EFI_PXE_BASE_CODE_PROTOCOL;
```

## Parameters

<i>Revision</i>	The revision of the <b>EFI_PXE_BASE_CODE_PROTOCOL</b> . All future revisions must be backwards compatible. If a future version is not backwards compatible it is not the same GUID.
<i>Start</i>	Starts the PXE Base Code Protocol. Mode structure information is not valid and no other Base Code Protocol functions will operate until the Base Code is started. See the <a href="#">Start()</a> function description.
<i>Stop</i>	Stops the PXE Base Code Protocol. Mode structure information is unchanged by this function. No Base Code Protocol functions will operate until the Base Code is restarted. See the <a href="#">Stop()</a> function description.
<i>Dhcp</i>	Attempts to complete a DHCPv4 D.O.R.A. (discover / offer / request / acknowledge) or DHCPv6 S.A.R.R (solicit / advertise / request / reply) sequence. See the <a href="#">Dhcp()</a> function description.
<i>Discover</i>	Attempts to complete the PXE Boot Server and/or boot image discovery sequence. See the <a href="#">Discover()</a> function description.

<i>Mtftp</i>	Performs TFTP and MTFTP services. See the <a href="#">Mtftp()</a> function description.
<i>UdpWrite</i>	Writes a UDP packet to the network interface. See the <a href="#">UdpWrite()</a> function description.
<i>UdpRead</i>	Reads a UDP packet from the network interface. See the <a href="#">UdpRead()</a> function description.
<i>SetIpFilter</i>	Updates the IP receive filters of the network device. See the <a href="#">SetIpFilter()</a> function description.
<i>Arp</i>	Uses the ARP protocol to resolve a MAC address. See the <a href="#">Arp()</a> function description.
<i>SetParameters</i>	Updates the parameters that affect the operation of the PXE Base Code Protocol. See the <a href="#">SetParameters()</a> function description.
<i>SetStationIp</i>	Updates the station IP address and subnet mask values. See the <a href="#">SetStationIp()</a> function description.
<i>SetPackets</i>	Updates the contents of the cached DHCP and Discover packets. See the <a href="#">SetPackets()</a> function description.
<i>Mode</i>	Pointer to the <a href="#">EFI_PXE_BASE_CODE_MODE</a> data for this device. The <a href="#">EFI_PXE_BASE_CODE_MODE</a> structure is defined in “Related Definitions” below.

## Related Definitions

```

//*****
// Maximum ARP and Route Entries
//*****
#define EFI_PXE_BASE_CODE_MAX_ARP_ENTRIES 8
#define EFI_PXE_BASE_CODE_MAX_ROUTE_ENTRIES 8

//*****
// EFI_PXE_BASE_CODE_MODE
//
// The data values in this structure are read-only and
// are updated by the code that produces the
// EFI_PXE_BASE_CODE_PROTOCOL functions. //
//*****
typedef struct {
    BOOLEAN    Started;
    BOOLEAN    Ipv6Available;
    BOOLEAN    Ipv6Supported;
    BOOLEAN    UsingIpv6;
    BOOLEAN    BisSupported;
    BOOLEAN    BisDetected;
    BOOLEAN    AutoArp;
    BOOLEAN    SendGUID;
    BOOLEAN    DhcpDiscoverValid;

```

```

BOOLEAN    DhcpAckReceived;
BOOLEAN    ProxyOfferReceived;
BOOLEAN    PxeDiscoverValid;
BOOLEAN    PxeReplyReceived;
BOOLEAN    PxeBisReplyReceived;
BOOLEAN    IcmpErrorReceived;
BOOLEAN    TftpErrorReceived;
BOOLEAN    MakeCallbacks;
UINT8      TTL;
UINT8      ToS;
EFI_IP_ADDRESS  StationIp;
EFI_IP_ADDRESS  SubnetMask;
EFI_PXE_BASE_CODE_PACKET DhcpDiscover;
EFI_PXE_BASE_CODE_PACKET DhcpAck;
EFI_PXE_BASE_CODE_PACKET ProxyOffer;
EFI_PXE_BASE_CODE_PACKET PxeDiscover;
EFI_PXE_BASE_CODE_PACKET PxeReply;
EFI_PXE_BASE_CODE_PACKET PxeBisReply;
EFI_PXE_BASE_CODE_IP_FILTER IpFilter;
UINT32      ArpCacheEntries;
EFI_PXE_BASE_CODE_ARP_ENTRY
    ArpCache[EFI_PXE_BASE_CODE_MAX_ARP_ENTRIES];
UINT32      RouteTableEntries;
EFI_PXE_BASE_CODE_ROUTE_ENTRY
    RouteTable[EFI_PXE_BASE_CODE_MAX_ROUTE_ENTRIES];
EFI_PXE_BASE_CODE_ICMP_ERROR IcmpError;
EFI_PXE_BASE_CODE_TFTP_ERROR TftpError;
} EFI_PXE_BASE_CODE_MODE;

```

<i>Started</i>	<b>TRUE</b> if this device has been started by calling <a href="#">Start()</a> . This field is set to <b>TRUE</b> by the <a href="#">Start()</a> function and to <b>FALSE</b> by the <a href="#">Stop()</a> function.
<i>Ipv6Available</i>	<b>TRUE</b> if the UNDI protocol supports IPv6.
<i>Ipv6Supported</i>	<b>TRUE</b> if this PXE Base Code Protocol implementation supports IPv6.
<i>UsingIpv6</i>	<b>TRUE</b> if this device is currently using IPv6. This field is set by the <a href="#">Start()</a> function.
<i>BisSupported</i>	<b>TRUE</b> if this PXE Base Code implementation supports Boot Integrity Services (BIS). This field is set by the <a href="#">Start()</a> function.
<i>BisDetected</i>	<b>TRUE</b> if this device and the platform support Boot Integrity Services (BIS). This field is set by the <a href="#">Start()</a> function.
<i>AutoArp</i>	<b>TRUE</b> for automatic ARP packet generation; <b>FALSE</b> otherwise. This field is initialized to <b>TRUE</b> by <a href="#">Start()</a> and can be modified with the <a href="#">SetParameters()</a> function.

<i>SendGUID</i>	This field is used to change the Client Hardware Address (chaddr) field in the DHCP and Discovery packets. Set to <b>TRUE</b> to send the SystemGuid (if one is available). Set to <b>FALSE</b> to send the client NIC MAC address. This field is initialized to <b>FALSE</b> by <b>Start()</b> and can be modified with the <b>SetParameters()</b> function.
<i>DhcpDiscoverValid</i>	This field is initialized to <b>FALSE</b> by the <b>Start()</b> function and set to <b>TRUE</b> when the <b>Dhcp()</b> function completes successfully. When <b>TRUE</b> , the <b>DhcpDiscover</b> field is valid. This field can also be changed by the <b>SetPackets()</b> function.
<i>DhcpAckReceived</i>	This field is initialized to <b>FALSE</b> by the <b>Start()</b> function and set to <b>TRUE</b> when the <b>Dhcp()</b> function completes successfully. When <b>TRUE</b> , the <b>DhcpAck</b> field is valid. This field can also be changed by the <b>SetPackets()</b> function.
<i>ProxyOfferReceived</i>	This field is initialized to <b>FALSE</b> by the <b>Start()</b> function and set to <b>TRUE</b> when the <b>Dhcp()</b> function completes successfully and a proxy DHCP offer packet was received. When <b>TRUE</b> , the <b>ProxyOffer</b> packet field is valid. This field can also be changed by the <b>SetPackets()</b> function.
<i>PxeDiscoverValid</i>	When <b>TRUE</b> , the <b>PxeDiscover</b> packet field is valid. This field is set to <b>FALSE</b> by the <b>Start()</b> and <b>Dhcp()</b> functions, and can be set to <b>TRUE</b> or <b>FALSE</b> by the <b>Discover()</b> and <b>SetPackets()</b> functions.
<i>PxeReplyReceived</i>	When <b>TRUE</b> , the <b>PxeReply</b> packet field is valid. This field is set to <b>FALSE</b> by the <b>Start()</b> and <b>Dhcp()</b> functions, and can be set to <b>TRUE</b> or <b>FALSE</b> by the <b>Discover()</b> and <b>SetPackets()</b> functions.
<i>PxeBisReplyReceived</i>	When <b>TRUE</b> , the <b>PxeBisReply</b> packet field is valid. This field is set to <b>FALSE</b> by the <b>Start()</b> and <b>Dhcp()</b> functions, and can be set to <b>TRUE</b> or <b>FALSE</b> by the <b>Discover()</b> and <b>SetPackets()</b> functions.
<i>IcmpErrorReceived</i>	Indicates whether the <b>IcmpError</b> field has been updated. This field is reset to <b>FALSE</b> by the <b>Start()</b> , <b>Dhcp()</b> , <b>Discover()</b> , <b>Mtftp()</b> , <b>UdpRead()</b> , <b>UdpWrite()</b> and <b>Arp()</b> functions. If an ICMP error is received, this field will be set to <b>TRUE</b> after the <b>IcmpError</b> field is updated.
<i>TftpErrorReceived</i>	Indicates whether the <b>TftpError</b> field has been updated. This field is reset to <b>FALSE</b> by the <b>Start()</b> and <b>Mtftp()</b> functions. If a TFTP error is received, this field will be set to <b>TRUE</b> after the <b>TftpError</b> field is updated.
<i>MakeCallbacks</i>	When <b>FALSE</b> , callbacks will not be made. When <b>TRUE</b> , make callbacks to the PXE Base Code Callback Protocol. This field is reset to <b>FALSE</b> by the <b>Start()</b> function if the PXE Base Code Callback Protocol is not available. It is reset to <b>TRUE</b> by the <b>Start()</b> function if the PXE Base Code Callback Protocol is available.

<i>TTL</i>	The “time to live” field of the IP header. This field is initialized to DEFAULT_TTL (See “Related Definitions”) by the <b>Start()</b> function and can be modified by the <a href="#">SetParameters()</a> function.
<i>ToS</i>	The type of service field of the IP header. This field is initialized to DEFAULT_ToS (See “Related Definitions”) by <b>Start()</b> , and can be modified with the <a href="#">SetParameters()</a> function.
<i>StationIp</i>	The device’s current IP address. This field is initialized to a zero address by <b>Start()</b> . This field is set when the <a href="#">Dhcp()</a> function completes successfully. This field can also be set by the <a href="#">SetStationIp()</a> function. This field must be set to a valid IP address by either <a href="#">Dhcp()</a> or <a href="#">SetStationIp()</a> before the <a href="#">Discover()</a> , <a href="#">Mftp()</a> , <a href="#">UdpRead()</a> , <a href="#">UdpWrite()</a> and <a href="#">Arp()</a> functions are called.
<i>SubnetMask</i>	The device’s current subnet mask. This field is initialized to a zero address by the <b>Start()</b> function. This field is set when the <a href="#">Dhcp()</a> function completes successfully. This field can also be set by the <a href="#">SetStationIp()</a> function. This field must be set to a valid subnet mask by either <a href="#">Dhcp()</a> or <a href="#">SetStationIp()</a> before the <a href="#">Discover()</a> , <a href="#">Mftp()</a> , <a href="#">UdpRead()</a> , <a href="#">UdpWrite()</a> , or <a href="#">Arp()</a> functions are called.
<i>DhcpDiscover</i>	Cached DHCP Discover packet. This field is zero-filled by the <b>Start()</b> function, and is set when the <a href="#">Dhcp()</a> function completes successfully. The contents of this field can be replaced by the <a href="#">SetPackets()</a> function.
<i>DhcpAck</i>	Cached DHCP Ack packet. This field is zero-filled by the <b>Start()</b> function, and is set when the <a href="#">Dhcp()</a> function completes successfully. The contents of this field can be replaced by the <a href="#">SetPackets()</a> function.
<i>ProxyOffer</i>	Cached Proxy Offer packet. This field is zero-filled by the <b>Start()</b> function, and is set when the <a href="#">Dhcp()</a> function completes successfully. The contents of this field can be replaced by the <a href="#">SetPackets()</a> function.
<i>PxeDiscover</i>	Cached PXE Discover packet. This field is zero-filled by the <b>Start()</b> function, and is set when the <a href="#">Discover()</a> function completes successfully. The contents of this field can be replaced by the <a href="#">SetPackets()</a> function.
<i>PxeReply</i>	Cached PXE Reply packet. This field is zero-filled by the <b>Start()</b> function, and is set when the <a href="#">Discover()</a> function completes successfully. The contents of this field can be replaced by the <a href="#">SetPackets()</a> function.
<i>PxeBisReply</i>	Cached PXE BIS Reply packet. This field is zero-filled by the <b>Start()</b> function, and is set when the <a href="#">Discover()</a> function completes successfully. This field can be replaced by the <a href="#">SetPackets()</a> function.

<i>IpFilter</i>	The current IP receive filter settings. The receive filter is disabled and the number of IP receive filters is set to zero by the <a href="#">Start()</a> function, and is set by the <a href="#">SetIpFilter()</a> function.
<i>ArpCacheEntries</i>	The number of valid entries in the ARP cache. This field is reset to zero by the <b>Start()</b> function.
<i>ArpCache</i>	Array of cached ARP entries.
<i>RouteTableEntries</i>	The number of valid entries in the current route table. This field is reset to zero by the <b>Start()</b> function.
<i>RouteTable</i>	Array of route table entries.
<i>IcmpError</i>	ICMP error packet. This field is updated when an ICMP error is received and is undefined until the first ICMP error is received. This field is zero-filled by the <b>Start()</b> function.
<i>TftpError</i>	TFTP error packet. This field is updated when a TFTP error is received and is undefined until the first TFTP error is received. This field is zero-filled by the <b>Start()</b> function.



```

//*****
// EFI_PXE_BASE_CODE_UDP_PORT
//*****
typedef UINT16 EFI_PXE_BASE_CODE_UDP_PORT;

//*****
// EFI_IPv4_ADDRESS and EFI_IPv6_ADDRESS
//*****
typedef struct {
    UINT8  Addr[4];
} EFI_IPv4_ADDRESS;

typedef struct {
    UINT8  Addr[16];
} EFI_IPv6_ADDRESS;

//*****
// EFI_IP_ADDRESS
//*****
typedef union {
    UINT32  Addr[4];
    EFI_IPv4_ADDRESS  v4;
    EFI_IPv6_ADDRESS  v6;
} EFI_IP_ADDRESS;

//*****
// EFI_MAC_ADDRESS
//*****
typedef struct {
    UINT8  Addr[32];
} EFI_MAC_ADDRESS;

```

## DHCP Packet Data Types

This section defines the data types for DHCP packets, ICMP error packets, and TFTP error packets. All of these are byte-packed data structures.

**Note:** All the multibyte fields in these structures are stored in network order.

```

//*****
// EFI_PXE_BASE_CODE_DHCPV4_PACKET
//*****
typedef struct {
    UINT8  BootpOpcode;
    UINT8  BootpHwType;
    UINT8  BootpHwAddrLen;
    UINT8  BootpGateHops;
    UINT32 BootpIdent;
    UINT16 BootpSeconds;
    UINT16 BootpFlags;
    UINT8  BootpCiAddr[4];
    UINT8  BootpYiAddr[4];
    UINT8  BootpSiAddr[4];
    UINT8  BootpGiAddr[4];
    UINT8  BootpHwAddr[16];
    UINT8  BootpSrvName[64];
    UINT8  BootpBootFile[128];
    UINT32 DhcpMagik;
    UINT8  DhcpOptions[56];
} EFI_PXE_BASE_CODE_DHCPV4_PACKET;

//*****
// DHCPV6 Packet structure
//*****
typedef struct {
    UINT32 MessageType:8;
    UINT32 TransactionId:24;
    UINT8  DhcpOptions[1024];
} EFI_PXE_BASE_CODE_DHCPV6_PACKET;

//*****
// EFI_PXE_BASE_CODE_PACKET
//*****
typedef union {
    UINT8      Raw[1472];
    EFI_PXE_BASE_CODE_DHCPV4_PACKET  Dhcpv4;
    EFI_PXE_BASE_CODE_DHCPV6_PACKET  Dhcpv6;
} EFI_PXE_BASE_CODE_PACKET;

//*****
// EFI_PXE_BASE_CODE_ICMP_ERROR
//*****
typedef struct {
    UINT8  Type;
    UINT8  Code;

```

```

    UINT16 Checksum;
    union {
        UINT32 reserved;
        UINT32 Mtu;
        UINT32 Pointer;
        struct {
            UINT16 Identifier;
            UINT16 Sequence;
        } Echo;
    } u;
    UINT8 Data[494];
} EFI_PXE_BASE_CODE_ICMP_ERROR;

//*****
// EFI_PXE_BASE_CODE_TFTP_ERROR
//*****
typedef struct {
    UINT8 ErrorCode;
    CHAR8 ErrorString[127];
} EFI_PXE_BASE_CODE_TFTP_ERROR;

```

## IP Receive Filter Settings

This section defines the data types for IP receive filter settings.

```

#define EFI_PXE_BASE_CODE_MAX_IPCNT8

//*****
// EFI_PXE_BASE_CODE_IP_FILTER
//*****
typedef struct {
    UINT8 Filters;
    UINT8 IpCnt;
    UINT16 reserved;
    EFI_IP_ADDRESS IpList[EFI_PXE_BASE_CODE_MAX_IPCNT];
} EFI_PXE_BASE_CODE_IP_FILTER;

#define EFI_PXE_BASE_CODE_IP_FILTER_STATION_IP 0x0001
#define EFI_PXE_BASE_CODE_IP_FILTER_BROADCAST 0x0002
#define EFI_PXE_BASE_CODE_IP_FILTER_PROMISCUOUS 0x0004
#define EFI_PXE_BASE_CODE_IP_FILTER_PROMISCUOUS_MULTICAST 0x0008

```

## ARP Cache Entries

This section defines the data types for ARP cache entries, and route table entries.

```

//*****
// EFI_PXE_BASE_CODE_ARP_ENTRY
//*****
typedef struct {
    EFI_IP_ADDRESS IpAddr;
    EFI_MAC_ADDRESS MacAddr;
} EFI_PXE_BASE_CODE_ARP_ENTRY;

//*****
// EFI_PXE_BASE_CODE_ROUTE_ENTRY
//*****
typedef struct {
    EFI_IP_ADDRESS IpAddr;
    EFI_IP_ADDRESS SubnetMask;
    EFI_IP_ADDRESS GwAddr;
} EFI_PXE_BASE_CODE_ROUTE_ENTRY;

```

## Filter Operations for UDP Read/Write Functions

This section defines the types of filter operations that can be used with the [UdpRead\(\)](#) and [UdpWrite\(\)](#) functions.

```

#define EFI_PXE_BASE_CODE_UDP_OPFLAGS_ANY_SRC_IP 0x0001
#define EFI_PXE_BASE_CODE_UDP_OPFLAGS_ANY_SRC_PORT 0x0002
#define EFI_PXE_BASE_CODE_UDP_OPFLAGS_ANY_DEST_IP 0x0004
#define EFI_PXE_BASE_CODE_UDP_OPFLAGS_ANY_DEST_PORT 0x0008
#define EFI_PXE_BASE_CODE_UDP_OPFLAGS_USE_FILTER 0x0010
#define EFI_PXE_BASE_CODE_UDP_OPFLAGS_MAY_FRAGMENT 0x0020
#define DEFAULT_TTL 16
#define DEFAULT_ToS 0

```

The following table defines values for the PXE DHCP and Bootserver Discover packet tags that are specific to the UEFI environment. Complete definitions of all PXE tags are defined in [Table 190](#) "PXE DHCP Options (Full List)," in the *PXE Specification*.

Table 190. PXE Tag Definitions for EFI

Tag Name	Tag #	Length	Data Field
Client Network Interface Identifier	94 [0x5E]	3 [0x03]	Type (1), MajorVer (1), MinorVer (1) Type is a one byte field that identifies the network interface that will be used by the downloaded program. Type is followed by two one byte version number fields, MajorVer and MinorVer. Type UNDI (1) = 0x01 Versions WfM-1.1a 16-bit UNDI: MajorVer = 0x02, MinorVer = 0x00 PXE-2.0 16-bit UNDI: MajorVer = 0x02, MinorVer = 0x01 32/64-bit UNDI & H/W UNDI: MajorVer = 0x03, MinorVer = 0x00
Client System Architecture	93 [0x5D]	2 [0x02]	Type (2) Type is a two byte, network order, field that identifies the processor and programming environment of the client system. For the various architecture type encodings, see the table "Processor Architecture Types" at "Links to UEFI-Related Documents" ( <a href="http://uefi.org/uefi">http://uefi.org/uefi</a> ) under the heading "Processor Architecture Types"
Class Identifier	60 [0x3C]	32 [0x20]	<b>"PXEClient:Arch:xxxxx:UNDI:yyyzzz"</b> "PXEClient:..." is used to identify communication between PXE clients and servers. Information from tags 93 & 94 is embedded in the Class Identifier string. (The strings defined in this tag are case sensitive and must not be NULL-terminated.) xxxxx = ASCII representation of Client System Architecture. yyyzzz = ASCII representation of Client Network Interface Identifier version numbers MajorVer(yyy) and MinorVer(zzz). <b>Example</b> "PXEClient:Arch:00002:UNDI:00300" identifies an IA64 PC w/ 32/64-bit UNDI

## Description

The basic mechanisms and flow for remote booting in UEFI are identical to the remote boot functionality described in detail in the *PXE Specification*. However, the actual execution environment, linkage, and calling conventions are replaced and enhanced for the UEFI environment.

The DHCP Option for the Client System Architecture is used to inform the DHCP server if the client is a UEFI environment in supported systems. The server may use this information to provide default images if it does not have a specific boot profile for the client.

The DHCP Option for Client Network Interface Identifier is used to inform the DHCP server of the client underlying network interface information. If the NII protocol is present, such information will be acquired by this protocol. Otherwise, Type = 0x01, MajorVer=0x03, MinorVer=0x00 will be the default value.

A handle that supports [EFI\\_PXE\\_BASE\\_CODE\\_PROTOCOL](#) is required to support [EFI\\_LOAD\\_FILE\\_PROTOCOL](#). The [EFI\\_LOAD\\_FILE\\_PROTOCOL](#) function [LoadFile\(\)](#) is used by the firmware to load files from devices that do not support file system type accesses. Specifically, the firmware's boot manager invokes [LoadFile\(\)](#) with [BootPolicy](#) being **TRUE** when attempting to boot from the device. The firmware then loads and transfers control to the downloaded PXE boot image. Once the remote image is successfully loaded, it may utilize the [EFI\\_PXE\\_BASE\\_CODE\\_PROTOCOL](#) interfaces, or even the [EFI\\_SIMPLE\\_NETWORK\\_PROTOCOL](#) interfaces, to continue the remote process.

## EFI\_PXE\_BASE\_CODE\_PROTOCOL.Start()

### Summary

Enables the use of the PXE Base Code Protocol functions.

### Prototype

```
typedef
EFI_STATUS
(EFI_API *EFI_PXE_BASE_CODE_START) (
    IN EFI_PXE_BASE_CODE_PROTOCOL      *This,
    IN BOOLEAN                          UseIpv6
);
```

### Parameters

<i>This</i>	Pointer to the <a href="#">EFI_PXE_BASE_CODE_PROTOCOL</a> instance.
<i>UseIpv6</i>	Specifies the type of IP addresses that are to be used during the session that is being started. Set to <b>TRUE</b> for IPv6 addresses, and <b>FALSE</b> for IPv4 addresses.

### Description

This function enables the use of the PXE Base Code Protocol functions. If the **Started** field of the [EFI\\_PXE\\_BASE\\_CODE\\_MODE](#) structure is already **TRUE**, then **EFI\_ALREADY\_STARTED** will be returned. If **UseIpv6** is **TRUE**, then IPv6 formatted addresses will be used in this session. If **UseIpv6** is **FALSE**, then IPv4 formatted addresses will be used in this session. If **UseIpv6** is **TRUE**, and the **Ipv6Supported** field of the [EFI\\_PXE\\_BASE\\_CODE\\_MODE](#) structure is **FALSE**, then **EFI\_UNSUPPORTED** will be returned. If there is not enough memory or other resources to start the PXE Base Code Protocol, then **EFI\_OUT\_OF\_RESOURCES** will be returned. Otherwise, the PXE Base Code Protocol will be started, and all of the fields of the [EFI\\_PXE\\_BASE\\_CODE\\_MODE](#) structure will be initialized as follows:

<b>Started</b>	Set to <b>TRUE</b> .
<b>Ipv6Supported</b>	Unchanged.
<b>Ipv6Available</b>	Unchanged.
<b>UsingIpv6</b>	Set to <b>UseIpv6</b> .
<b>BisSupported</b>	Unchanged.
<b>BisDetected</b>	Unchanged.
<b>AutoArp</b>	Set to <b>TRUE</b> .
<b>SendGUID</b>	Set to <b>FALSE</b> .
<b>TTL</b>	Set to <b>DEFAULT_TTL</b> .
<b>ToS</b>	Set to <b>DEFAULT_ToS</b> .
<b>DhcpCompleted</b>	Set to <b>FALSE</b> .
<b>ProxyOfferReceived</b>	Set to <b>FALSE</b> .

<b>StationIp</b>	Set to an address of all zeros.
<b>SubnetMask</b>	Set to a subnet mask of all zeros.
<b>DhcpDiscover</b>	Zero-filled.
<b>DhcpAck</b>	Zero-filled.
<b>ProxyOffer</b>	Zero-filled.
<b>PxeDiscoverValid</b>	Set to <b>FALSE</b> .
<b>PxeDiscover</b>	Zero-filled.
<b>PxeReplyValid</b>	Set to <b>FALSE</b> .
<b>PxeReply</b>	Zero-filled.
<b>PxeBisReplyValid</b>	Set to <b>FALSE</b> .
<b>PxeBisReply</b>	Zero-filled.
<b>IpFilter</b>	Set the <b>Filters</b> field to 0 and the <b>IpCnt</b> field to 0.
<b>ArpCacheEntries</b>	Set to 0.
<b>ArpCache</b>	Zero-filled.
<b>RouteTableEntries</b>	Set to 0.
<b>RouteTable</b>	Zero-filled.
<b>IcmpErrorReceived</b>	Set to <b>FALSE</b> .
<b>IcmpError</b>	Zero-filled.
<b>TftpErrorReceived</b>	Set to <b>FALSE</b> .
<b>TftpError</b>	Zero-filled.
<i>MakeCallbacks</i>	Set to <b>TRUE</b> if the PXE Base Code Callback Protocol is available. Set to <b>FALSE</b> if the PXE Base Code Callback Protocol is not available.

## Status Codes Returned

EFI_SUCCESS	The PXE Base Code Protocol was started.
EFI_INVALID_PARAMETER	The <i>This</i> parameter is <b>NULL</b> or does not point to a valid <b>EFI_PXE_BASE_CODE_PROTOCOL</b> structure.
EFI_UNSUPPORTED	<i>UseIpv6</i> is <b>TRUE</b> , but the <i>Ipv6Supported</i> field of the <b>EFI_PXE_BASE_CODE_MODE</b> structure is <b>FALSE</b> .
EFI_ALREADY_STARTED	The PXE Base Code Protocol is already in the started state.
EFI_DEVICE_ERROR	The network device encountered an error during this operation.
EFI_OUT_OF_RESOURCES	Could not allocate enough memory or other resources to start the PXE Base Code Protocol.



## EFI\_PXE\_BASE\_CODE\_PROTOCOL.Stop()

### Summary

Disables the use of the PXE Base Code Protocol functions.

### Prototype

```
typedef
EFI_STATUS
(EFI_API *EFI_PXE_BASE_CODE_STOP) (
    IN EFI_PXE_BASE_CODE_PROTOCOL *This
);
```

### Parameters

*This* Pointer to the [EFI\\_PXE\\_BASE\\_CODE\\_PROTOCOL](#) instance.

### Description

This function stops all activity on the network device. All the resources allocated in [Start\(\)](#) are released, the **Started** field of the [EFI\\_PXE\\_BASE\\_CODE\\_MODE](#) structure is set to **FALSE** and **EFI\_SUCCESS** is returned. If the **Started** field of the [EFI\\_PXE\\_BASE\\_CODE\\_MODE](#) structure is already **FALSE**, then **EFI\_NOT\_STARTED** will be returned.

### Status Codes Returned

EFI_SUCCESS	The PXE Base Code Protocol was stopped.
EFI_NOT_STARTED	The PXE Base Code Protocol is already in the stopped state.
EFI_INVALID_PARAMETER	The <i>This</i> parameter is <b>NULL</b> or does not point to a valid <a href="#">EFI_PXE_BASE_CODE_PROTOCOL</a> structure.
EFI_DEVICE_ERROR	The network device encountered an error during this operation.

## EFI\_PXE\_BASE\_CODE\_PROTOCOL.Dhcp()

### Summary

Attempts to complete a DHCPv4 D.O.R.A. (discover / offer / request / acknowledge) or DHCPv6 S.A.R.R (solicit / advertise / request / reply) sequence.

### Prototype

```
typedef
EFI_STATUS
(EFIAPI *EFI_PXE_BASE_CODE_DHCP) (
    IN EFI_PXE_BASE_CODE_PROTOCOL *This,
    IN BOOLEAN          SortOffers
);
```

### Parameters

<i>This</i>	Pointer to the <a href="#">EFI_PXE_BASE_CODE_PROTOCOL</a> instance.
<i>SortOffers</i>	<b>TRUE</b> if the offers received should be sorted. Set to <b>FALSE</b> to try the offers in the order that they are received.

### Description

This function attempts to complete the DHCP sequence. If this sequence is completed, then **EFI\_SUCCESS** is returned, and the **DhcpCompleted**, **ProxyOfferReceived**, **StationIp**, **SubnetMask**, **DhcpDiscover**, **DhcpAck**, and **ProxyOffer** fields of the [EFI\\_PXE\\_BASE\\_CODE\\_MODE](#) structure are filled in.

If **SortOffers** is **TRUE**, then the cached DHCP offer packets will be sorted before they are tried. If **SortOffers** is **FALSE**, then the cached DHCP offer packets will be tried in the order in which they are received. Please see the *Preboot Execution Environment (PXE) Specification* for additional details on the implementation of DHCP.

This function can take at least 31 seconds to timeout and return control to the caller. If the DHCP sequence does not complete, then **EFI\_TIMEOUT** will be returned.

If the Callback Protocol does not return **EFI\_PXE\_BASE\_CODE\_CALLBACK\_STATUS\_CONTINUE**, then the DHCP sequence will be stopped and **EFI\_ABORTED** will be returned.

### Status Codes Returned

EFI_SUCCESS	Valid DHCP has completed.
EFI_NOT_STARTED	The PXE Base Code Protocol is in the stopped state.
EFI_INVALID_PARAMETER	The <i>This</i> parameter is <b>NULL</b> or does not point to a valid <b>EFI_PXE_BASE_CODE_PROTOCOL</b> structure.
EFI_DEVICE_ERROR	The network device encountered an error during this operation.
EFI_OUT_OF_RESOURCES	Could not allocate enough memory to complete the DHCP Protocol.

EFI_ABORTED	The callback function aborted the DHCP Protocol.
EFI_TIMEOUT	The DHCP Protocol timed out.
EFI_ICMP_ERROR	An ICMP error packet was received during the DHCP session. The ICMP error packet has been cached in the <b>EFI_PXE_BASE_CODE_MODE.IcmpError</b> packet structure. Information about ICMP packet contents can be found in RFC 792.
EFI_NO_RESPONSE	Valid PXE offer was not received.

## EFI\_PXE\_BASE\_CODE\_PROTOCOL.Discover()

### Summary

Attempts to complete the PXE Boot Server and/or boot image discovery sequence.

### Prototype

```
typedef
EFI_STATUS
(EFI_API *EFI_PXE_BASE_CODE_DISCOVER) (
    IN EFI_PXE_BASE_CODE_PROTOCOL          *This,
    IN UINT16                             Type,
    IN UINT16                             *Layer,
    IN BOOLEAN                             UseBis,
    IN EFI_PXE_BASE_CODE_DISCOVER_INFO    *Info OPTIONAL
);
```

### Parameters

<i>This</i>	Pointer to the <a href="#">EFI PXE BASE CODE PROTOCOL</a> instance.
<i>Type</i>	The type of bootstrap to perform. See “Related Definitions” below.
<i>Layer</i>	Pointer to the boot server layer number to discover, which must be <b>PXE_BOOT_LAYER_INITIAL</b> when a new server type is being discovered. This is the only layer type that will perform multicast and broadcast discovery. All other layer types will only perform unicast discovery. If the boot server changes <b>Layer</b> , then the new <b>Layer</b> will be returned.
<i>UseBis</i>	<b>TRUE</b> if Boot Integrity Services are to be used. <b>FALSE</b> otherwise.
<i>Info</i>	Pointer to a data structure that contains additional information on the type of discovery operation that is to be performed. If this field is <b>NULL</b> , then the contents of the cached <b>DhcpAck</b> and <b>ProxyOffer</b> packets will be used.

## Related Definitions

```

//*****
// Bootstrap Types
//*****

#define EFI_PXE_BASE_CODE_BOOT_TYPE_BOOTSTRAP 0
#define EFI_PXE_BASE_CODE_BOOT_TYPE_MS_WINNT_RIS 1
#define EFI_PXE_BASE_CODE_BOOT_TYPE_INTEL_LCM 2
#define EFI_PXE_BASE_CODE_BOOT_TYPE_DOSUNDI 3
#define EFI_PXE_BASE_CODE_BOOT_TYPE_NEC_ESMPRO 4
#define EFI_PXE_BASE_CODE_BOOT_TYPE_IBM_WSoD 5
#define EFI_PXE_BASE_CODE_BOOT_TYPE_IBM_LCCM 6
#define EFI_PXE_BASE_CODE_BOOT_TYPE_CA_UNICENTER_TNG 7
#define EFI_PXE_BASE_CODE_BOOT_TYPE_HP_OPENVIEW 8
#define EFI_PXE_BASE_CODE_BOOT_TYPE_ALTIRIS_9 9
#define EFI_PXE_BASE_CODE_BOOT_TYPE_ALTIRIS_10 10
#define EFI_PXE_BASE_CODE_BOOT_TYPE_ALTIRIS_11 11
#define EFI_PXE_BASE_CODE_BOOT_TYPE_NOT_USED_12 12
#define EFI_PXE_BASE_CODE_BOOT_TYPE_REDHAT_INSTALL 13
#define EFI_PXE_BASE_CODE_BOOT_TYPE_REDHAT_BOOT 14
#define EFI_PXE_BASE_CODE_BOOT_TYPE_REMBO 15
#define EFI_PXE_BASE_CODE_BOOT_TYPE_BEOBOOT 16
//
// Values 17 through 32767 are reserved.
// Values 32768 through 65279 are for vendor use.
// Values 65280 through 65534 are reserved.
//
#define EFI_PXE_BASE_CODE_BOOT_TYPE_PXETEST 65535

#define EFI_PXE_BASE_CODE_BOOT_LAYER_MASK 0x7FFF
#define EFI_PXE_BASE_CODE_BOOT_LAYER_INITIAL 0x0000

//*****
// EFI_PXE_BASE_CODE_DISCOVER_INFO
//*****
typedef struct {
    BOOLEAN UseMCast;
    BOOLEAN UseBCast;
    BOOLEAN UseUCast;
    BOOLEAN MustUseList;
    EFI_IP_ADDRESS ServerMCastIp;
    UINT16 IpCnt;
    EFI_PXE_BASE_CODE_SRVLIST SrvList[IpCnt];
} EFI_PXE_BASE_CODE_DISCOVER_INFO;

//*****
// EFI_PXE_BASE_CODE_SRVLIST

```

```

//*****
typedef struct {
    UINT16    Type;
    BOOLEAN   AcceptAnyResponse;
    UINT8     reserved;
    EFI_IP_ADDRESS IpAddr;
} EFI_PXE_BASE_CODE_SRVLIST;

```

## Description

This function attempts to complete the PXE Boot Server and/or boot image discovery sequence. If this sequence is completed, then **EFI\_SUCCESS** is returned, and the **PxeDiscoverValid**, **PxeDiscover**, **PxeReplyReceived**, and **PxeReply** fields of the **EFI\_PXE\_BASE\_CODE\_MODE** structure are filled in. If **UseBis** is **TRUE**, then the **PxeBisReplyReceived** and **PxeBisReply** fields of the **EFI\_PXE\_BASE\_CODE\_MODE** structure will also be filled in. If **UseBis** is **FALSE**, then **PxeBisReplyValid** will be set to **FALSE**.

In the structure referenced by parameter **Info**, the PXE Boot Server list, **SrvList[]**, has two uses: It is the Boot Server IP address list used for unicast discovery (if the **UseUCast** field is **TRUE**), and it is the list used for Boot Server verification (if the **MustUseList** field is **TRUE**). Also, if the **MustUseList** field in that structure is **TRUE** and the **AcceptAnyResponse** field in the **SrvList[]** array is **TRUE**, any Boot Server reply of that type will be accepted. If the **AcceptAnyResponse** field is **FALSE**, only responses from Boot Servers with matching IP addresses will be accepted.

This function can take at least 10 seconds to timeout and return control to the caller. If the Discovery sequence does not complete, then **EFI\_TIMEOUT** will be returned. Please see the *Preboot Execution Environment (PXE) Specification* for additional details on the implementation of the Discovery sequence.

If the Callback Protocol does not return **EFI\_PXE\_BASE\_CODE\_CALLBACK\_STATUS\_CONTINUE**, then the Discovery sequence is stopped and **EFI\_ABORTED** will be returned.

## Status Codes Returned

EFI_SUCCESS	The Discovery sequence has been completed.
EFI_NOT_STARTED	The PXE Base Code Protocol is in the stopped state.

EFI_INVALID_PARAMETER	<p>One or more of the following conditions was <b>TRUE</b>:</p> <ul style="list-style-type: none"> <li>• The <i>This</i> parameter was <b>NULL</b></li> <li>• The <i>This</i> parameter did not point to a valid <b>EFI_PXE_BASE_CODE_PROTOCOL</b> structure</li> <li>• The <i>Layer</i> parameter was <b>NULL</b></li> <li>• The <i>Info-&gt;ServerMCastIp</i> parameter does not contain a valid multicast IP address</li> <li>• The <i>Info-&gt;UseUCast</i> parameter is not <b>FALSE</b> and the <i>Info-&gt;IpCnt</i> parameter is zero</li> </ul> <p>One or more of the IP addresses in the <i>Info-&gt;SrvList[]</i> array is not a valid unicast IP address.</p>
EFI_DEVICE_ERROR	The network device encountered an error during this operation.
EFI_OUT_OF_RESOURCES	Could not allocate enough memory to complete Discovery.
EFI_ABORTED	The callback function aborted the Discovery sequence.
EFI_TIMEOUT	The Discovery sequence timed out.
EFI_ICMP_ERROR	<p>An ICMP error packet was received during the PXE discovery session. The ICMP error packet has been cached in the <b>EFI_PXE_BASE_CODE_MODE.IcmpError</b> packet structure. Information about ICMP packet contents can be found in RFC 792.</p>

## EFI\_PXE\_BASE\_CODE\_PROTOCOL.Mtftp()

### Summary

Used to perform TFTP and MTFTP services.

### Prototype

```
typedef
EFI_STATUS
(EFI_API *EFI_PXE_BASE_CODE_MTFTP) (
  IN EFI_PXE_BASE_CODE_PROTOCOL *This,
  IN EFI_PXE_BASE_CODE_TFTP_OPCODE Operation,
  IN OUT VOID *BufferPtr, OPTIONAL
  IN BOOLEAN Overwrite,
  IN OUT UINT64 *BufferSize,
  IN UINTN *BlockSize, OPTIONAL
  IN EFI_IP_ADDRESS *ServerIp,
  IN CHAR8 *Filename, OPTIONAL
  IN EFI_PXE_BASE_CODE_MTFTP_INFO *Info, OPTIONAL
  IN BOOLEAN DontUseBuffer
);
```

### Parameters

<i>This</i>	Pointer to the <a href="#">EFI_PXE_BASE_CODE_PROTOCOL</a> instance.
<i>Operation</i>	The type of operation to perform. See “Related Definitions” below for the list of operation types.
<i>BufferPtr</i>	A pointer to the data buffer. Ignored for read file if <b>DontUseBuffer</b> is <b>TRUE</b> .
<i>Overwrite</i>	Only used on write file operations. <b>TRUE</b> if a file on a remote server can be overwritten.
<i>BufferSize</i>	For get-file-size operations, <i>BufferSize</i> returns the size of the requested file. For read-file and write-file operations, this parameter is set to the size of the buffer specified by the <i>BufferPtr</i> parameter. For read-file operations, if <b>EFI_BUFFER_TOO_SMALL</b> is returned, <i>BufferSize</i> returns the size of the requested file.
<i>BlockSize</i>	The requested block size to be used during a TFTP transfer. This must be at least 512. If this field is <b>NULL</b> , then the largest block size supported by the implementation will be used.
<i>ServerIp</i>	The TFTP / MTFTP server IP address.
<i>Filename</i>	A Null-terminated ASCII string that specifies a directory name or a file name. This is ignored by MTFTP read directory.



*Info* Pointer to the MTFTP information. This information is required to start or join a multicast TFTP session. It is also required to perform the “get file size” and “read directory” operations of MTFTP. See “Related Definitions” below for the description of this data structure.

*DontUseBuffer* Set to **FALSE** for normal TFTP and MTFTP read file operation. Setting this to **TRUE** will cause TFTP and MTFTP read file operations to function without a receive buffer, and all of the received packets are passed to the Callback Protocol which is responsible for storing them. This field is only used by TFTP and MTFTP read file.

## Related Definitions

```

//*****
// EFI_PXE_BASE_CODE_TFTP_OPCODE
//*****
typedef enum {
  EFI_PXE_BASE_CODE_TFTP_FIRST,
  EFI_PXE_BASE_CODE_TFTP_GET_FILE_SIZE,
  EFI_PXE_BASE_CODE_TFTP_READ_FILE,
  EFI_PXE_BASE_CODE_TFTP_WRITE_FILE,
  EFI_PXE_BASE_CODE_TFTP_READ_DIRECTORY,
  EFI_PXE_BASE_CODE_MTFTP_GET_FILE_SIZE,
  EFI_PXE_BASE_CODE_MTFTP_READ_FILE,
  EFI_PXE_BASE_CODE_MTFTP_READ_DIRECTORY,
  EFI_PXE_BASE_CODE_MTFTP_LAST
} EFI_PXE_BASE_CODE_TFTP_OPCODE;

//*****
// EFI_PXE_BASE_CODE_MTFTP_INFO
//*****
typedef struct {
  EFI_IP_ADDRESS      MCastIp;
  EFI_PXE_BASE_CODE_UDP_PORT CPort;
  EFI_PXE_BASE_CODE_UDP_PORT SPort;
  UINT16              ListenTimeout;
  UINT16              TransmitTimeout;
} EFI_PXE_BASE_CODE_MTFTP_INFO;

```

*MCastIp* File multicast IP address. This is the IP address to which the server will send the requested file.

*CPort* Client multicast listening port. This is the UDP port to which the server will send the requested file.

*SPort* Server multicast listening port. This is the UDP port on which the server listens for multicast open requests and data acks.

<i>ListenTimeout</i>	The number of seconds a client should listen for an active multicast session before requesting a new multicast session.
<i>TransmitTimeout</i>	The number of seconds a client should wait for a packet from the server before retransmitting the previous open request or data ack packet.

## Description

This function is used to perform TFTP and MTFTP services. This includes the TFTP operations to get the size of a file, read a directory, read a file, and write a file. It also includes the MTFTP operations to get the size of a file, read a directory, and read a file. The type of operation is specified by **Operation**. If the callback function that is invoked during the TFTP/MTFTP operation does not return

**EFI\_PXE\_BASE\_CODE\_CALLBACK\_STATUS\_CONTINUE**, then **EFI\_ABORTED** will be returned.

For read operations, the return data will be placed in the buffer specified by **BufferPtr**. If **BufferSize** is too small to contain the entire downloaded file, then **EFI\_BUFFER\_TOO\_SMALL** will be returned and **BufferSize** will be set to zero or the size of the requested file (the size of the requested file is only returned if the TFTP server supports TFTP options). If **BufferSize** is large enough for the read operation, then **BufferSize** will be set to the size of the downloaded file, and **EFI\_SUCCESS** will be returned. Applications using the **PxeBc.Mtftp()** services should use the get-file-size operations to determine the size of the downloaded file prior to using the read-file operations—especially when downloading large (greater than 64 MiB) files—instead of making two calls to the read-file operation. Following this recommendation will save time if the file is larger than expected and the TFTP server does not support TFTP option extensions. Without TFTP option extension support, the client has to download the entire file, counting and discarding the received packets, to determine the file size.

For write operations, the data to be sent is in the buffer specified by **BufferPtr**. **BufferSize** specifies the number of bytes to send. If the write operation completes successfully, then **EFI\_SUCCESS** will be returned.

For TFTP “get file size” operations, the size of the requested file or directory is returned in **BufferSize**, and **EFI\_SUCCESS** will be returned. If the TFTP server does not support options, the file will be downloaded into a bit bucket and the length of the downloaded file will be returned. For MTFTP “get file size” operations, if the MTFTP server does not support the “get file size” option, **EFI\_UNSUPPORTED** will be returned.

This function can take up to 10 seconds to timeout and return control to the caller. If the TFTP sequence does not complete, **EFI\_TIMEOUT** will be returned.

If the Callback Protocol does not return

**EFI\_PXE\_BASE\_CODE\_CALLBACK\_STATUS\_CONTINUE**, then the TFTP sequence is stopped and **EFI\_ABORTED** will be returned.

The format of the data returned from a TFTP read directory operation is a null-terminated filename followed by a null-terminated information string, of the form “size year-month-day hour:minute:second” (i.e., %d %d-%d-%d %d:%d:%f - note that the seconds field can be a decimal number), where the date and time are UTC. For an MTFTP read directory

command, there is additionally a null-terminated multicast IP address preceding the filename of the form %d.%d.%d.%d for IP v4. The final entry is itself null-terminated, so that the final information string is terminated with two null octets.

## Status Codes Returned

EFI_SUCCESS	The TFTP/MTFTP operation was completed.
EFI_NOT_STARTED	The PXE Base Code Protocol is in the stopped state.
EFI_INVALID_PARAMETER	<p>One or more of the following conditions was <b>TRUE</b>:</p> <ul style="list-style-type: none"> <li>The <i>This</i> parameter was <b>NULL</b></li> <li>The <i>This</i> parameter did not point to a valid EFI_PXE_BASE_CODE_PROTOCOL structure</li> <li>The Operation parameter was not one of the listed EFI_PXE_BASE_CODE_TFTP_OPCODE constants</li> <li>The <i>BufferPtr</i> parameter was <b>NULL</b> and the DontUseBuffer parameter was <b>FALSE</b></li> <li>The <i>BufferSize</i> parameter was <b>NULL</b></li> <li>The BlockSize parameter was not <b>NULL</b> and *BlockSize was less than 512</li> <li>The ServerIp parameter was <b>NULL</b> or did not contain a valid unicast IP address</li> <li>The Filename parameter was <b>NULL</b> for a file transfer or information request</li> <li>The Info parameter was <b>NULL</b> for a multicast request</li> </ul> <p>The Info-&gt;MCastIp parameter is not a valid multicast IP address</p>
EFI_DEVICE_ERROR	The network device encountered an error during this operation.
EFI_BUFFER_TOO_SMALL	The buffer is not large enough to complete the read operation.
EFI_ABORTED	The callback function aborted the TFTP/MTFTP operation.
EFI_TIMEOUT	The TFTP/MTFTP operation timed out.
EFI_TFTP_ERROR	A TFTP error packet was received during the MTFTP session. The TFTP error packet has been cached in the <b>EFI_PXE_BASE_CODE_MODE.TftpError</b> packet structure. Information about TFTP error packet contents can be found in RFC 1350.
EFI_ICMP_ERROR	An ICMP error packet was received during the MTFTP session. The ICMP error packet has been cached in the <b>EFI_PXE_BASE_CODE_MODE.IcmpError</b> packet structure. Information about ICMP packet contents can be found in RFC 792.

## EFI\_PXE\_BASE\_CODE\_PROTOCOL.UdpWrite()

### Summary

Writes a UDP packet to the network interface.

### Prototype

```
typedef
EFI_STATUS
(EFI_API *EFI_PXE_BASE_CODE_UDP_WRITE) (
  IN EFI_PXE_BASE_CODE_PROTOCOL *This,
  IN UINT16      OpFlags,
  IN EFI_IP_ADDRESS *DestIp,
  IN EFI_PXE_BASE_CODE_UDP_PORT *DestPort,
  IN EFI_IP_ADDRESS *GatewayIp, OPTIONAL
  IN EFI_IP_ADDRESS *SrcIp,  OPTIONAL
  IN OUT EFI_PXE_BASE_CODE_UDP_PORT *SrcPort, OPTIONAL
  IN UINTN      *HeaderSize, OPTIONAL
  IN VOID      *HeaderPtr,  OPTIONAL
  IN UINTN      *BufferSize,
  IN VOID      *BufferPtr
);
```

### Parameters

<i>This</i>	Pointer to the <a href="#">EFI PXE BASE CODE PROTOCOL</a> instance.
<i>OpFlags</i>	The UDP operation flags. If <b>MAY_FRAGMENT</b> is set, then if required, this UDP write operation may be broken up across multiple packets.
<i>DestIp</i>	The destination IP address.
<i>DestPort</i>	The destination UDP port number.
<i>GatewayIp</i>	The gateway IP address. If <i>DestIp</i> is not in the same subnet as <b>StationIp</b> , then this gateway IP address will be used. If this field is <b>NULL</b> , and the <b>DestIp</b> is not in the same subnet as <i>StationIp</i> , then the <b>RouteTable</b> will be used.
<i>SrcIp</i>	The source IP address. If this field is <b>NULL</b> , then <i>StationIp</i> will be used as the source IP address.
<i>SrcPort</i>	The source UDP port number. If <b>OpFlags</b> has <b>ANY_SRC_PORT</b> set or <i>SrcPort</i> is <b>NULL</b> , then a source UDP port will be automatically selected. If a source UDP port was automatically selected, and <b>SrcPort</b> is not <b>NULL</b> , then it will be returned in <i>SrcPort</i> .
<i>HeaderSize</i>	An optional field which may be set to the length of a header at <i>HeaderPtr</i> to be prefixed to the data at <i>BufferPtr</i> .
<i>HeaderPtr</i>	If <i>HeaderSize</i> is not <b>NULL</b> , a pointer to a header to be prefixed to the data at <i>BufferPtr</i> .

*BufferSize*

A pointer to the size of the data at **BufferPtr**.

*BufferPtr*

A pointer to the data to be written.

## Description

This function writes a UDP packet specified by the (optional **HeaderPtr** and) **BufferPtr** parameters to the network interface. The UDP header is automatically built by this routine. It uses the parameters **OpFlags**, **DestIp**, **DestPort**, **GatewayIp**, **SrcIp**, and **SrcPort** to build this header. If the packet is successfully built and transmitted through the network interface, then **EFI\_SUCCESS** will be returned. If a timeout occurs during the transmission of the packet, then **EFI\_TIMEOUT** will be returned. If an ICMP error occurs during the transmission of the packet, then the **IcmpErrorReceived** field is set to **TRUE**, the **IcmpError** field is filled in and **EFI\_ICMP\_ERROR** will be returned. If the Callback Protocol does not return **EFI\_PXE\_BASE\_CODE\_CALLBACK\_STATUS\_CONTINUE**, then **EFI\_ABORTED** will be returned.

## Status Codes Returned

EFI_SUCCESS	The UDP Write operation was completed.
EFI_NOT_STARTED	The PXE Base Code Protocol is in the stopped state.
EFI_INVALID_PARAMETER	One or more of the following conditions was <b>TRUE</b> : <ul style="list-style-type: none"> <li>The <i>This</i> parameter was <b>NULL</b></li> <li>The <i>This</i> parameter did not point to a valid <b>EFI_PXE_BASE_CODE_PROTOCOL</b> structure</li> <li>Reserved bits in the OpFlags parameter were not set to zero</li> <li>The DestIp parameter was <b>NULL</b></li> <li>The DestPort parameter was <b>NULL</b></li> <li>The GatewayIp parameter was not <b>NULL</b> and did not contain a valid unicast IP address.</li> <li>The HeaderSize parameter was not <b>NULL</b> and *HeaderSize is zero</li> <li>The *HeaderSize parameter was not zero and the HeaderPtr parameter was <b>NULL</b></li> <li>The BufferSize parameter was <b>NULL</b></li> <li>The *BufferSize parameter was not zero and the BufferPtr parameter was <b>NULL</b></li> </ul>
EFI_DEVICE_ERROR	The network device encountered an error during this operation.
EFI_BAD_BUFFER_SIZE	The buffer is too long to be transmitted.
EFI_ABORTED	The callback function aborted the UDP Write operation.
EFI_TIMEOUT	The UDP Write operation timed out.
EFI_ICMP_ERROR	An ICMP error packet was received during the UDP write session. The ICMP error packet has been cached in the <b>EFI_PXE_BASE_CODE_MODE.IcmpError</b> packet structure. Information about ICMP packet contents can be found in RFC 792.

## EFI\_PXE\_BASE\_CODE\_PROTOCOL.UdpRead()

### Summary

Reads a UDP packet from the network interface.

### Prototype

```
typedef
EFI_STATUS
(EFI_API *EFI_PXE_BASE_CODE_UDP_READ) (
  IN EFI_PXE_BASE_CODE_PROTOCOL *This
  IN UINT16      OpFlags,
  IN OUT EFI_IP_ADDRESS *DestIp, OPTIONAL
  IN OUT EFI_PXE_BASE_CODE_UDP_PORT *DestPort, OPTIONAL
  IN OUT EFI_IP_ADDRESS *SrcIp, OPTIONAL
  IN OUT EFI_PXE_BASE_CODE_UDP_PORT *SrcPort, OPTIONAL
  IN UINTN      *HeaderSize, OPTIONAL
  IN VOID      *HeaderPtr, OPTIONAL
  IN OUT UINTN  *BufferSize,
  IN VOID      *BufferPtr
);
```

### Parameters

<i>This</i>	Pointer to the <a href="#">EFI_PXE_BASE_CODE_PROTOCOL</a> instance.
<i>OpFlags</i>	The UDP operation flags.
<i>DestIp</i>	The destination IP address.
<i>DestPort</i>	The destination UDP port number.
<i>SrcIp</i>	The source IP address.
<i>SrcPort</i>	The source UDP port number.
<i>HeaderSize</i>	An optional field which may be set to the length of a header to be put in <b>HeaderPtr</b> .
<i>HeaderPtr</i>	If <b>HeaderSize</b> is not <b>NULL</b> , a pointer to a buffer to hold the <b>HeaderSize</b> bytes which follow the UDP header.
<i>BufferSize</i>	On input, a pointer to the size of the buffer at <i>BufferPtr</i> . On output, the size of the data written to <i>BufferPtr</i> .
<i>BufferPtr</i>	A pointer to the data to be read.

### Description

This function reads a UDP packet from a network interface. The data contents are returned in (the optional **HeaderPtr** and) **BufferPtr**, and the size of the buffer received is returned in **BufferSize**. If the input **BufferSize** is smaller than the UDP packet received (less optional **HeaderSize**), it will be set to the required size, and **EFI\_BUFFER\_TOO\_SMALL** will be returned. In this case, the contents of **BufferPtr** are undefined, and the packet is lost. If a UDP packet is successfully received, then

**EFI\_SUCCESS** will be returned, and the information from the UDP header will be returned in **DestIp**, **DestPort**, **SrcIp**, and **SrcPort** if they are not **NULL**. Depending on the values of **OpFlags** and the **DestIp**, **DestPort**, **SrcIp**, and **SrcPort** input values, different types of UDP packet receive filtering will be performed. The following tables summarize these receive filter operations.

Table 191. Destination IP Filter Operation

OpFlags USE_FILTER	OpFlags ANY_DEST_IP	DestIp	Action
0	0	NULL	Receive a packet sent to <i>StationIp</i> .
0	1	NULL	Receive a packet sent to any IP address.
1	x	NULL	Receive a packet whose destination IP address passes the IP filter.
0	0	not NULL	Receive a packet whose destination IP address matches <i>DestIp</i> .
0	1	not NULL	Receive a packet sent to any IP address and, return the destination IP address in <i>DestIp</i> .
1	x	not NULL	Receive a packet whose destination IP address passes the IP filter, and return the destination IP address in <i>DestIp</i> .

Table 192. Destination UDP Port Filter Operation

OpFlags ANY_DEST_PORT	DestPort	Action
0	NULL	Return <b>EFI_INVALID_PARAMETER</b> .
1	NULL	Receive a packet sent to any UDP port.
0	not NULL	Receive a packet whose destination Port matches <i>DestPort</i> .
1	not NULL	Receive a packet sent to any UDP port, and return the destination port in <i>DestPort</i> .

Table 193. Source IP Filter Operation

OpFlags ANY_SRC_IP	SrcIp	Action
0	NULL	Return <b>EFI_INVALID_PARAMETER</b> .
1	NULL	Receive a packet sent from any IP address.
0	not NULL	Receive a packet whose source IP address matches <i>SrcIp</i> .
1	not NULL	Receive a packet sent from any IP address, and return the source IP address in <i>SrcIp</i> .

Table 194. Source UDP Port Filter Operation

OpFlags ANY_SRC_PORT	SrcPort	Action
0	NULL	Return <b>EFI_INVALID_PARAMETER</b> .
1	NULL	Receive a packet sent from any UDP port.
0	not NULL	Receive a packet whose source UDP port matches <i>SrcPort</i> .



OpFlags	SrcPort	Action
ANY_SRC_PORT		
1	not NULL	Receive a packet sent from any UDP port, and return the source UDP port in <i>SrcPort</i> .

## Status Codes Returned

EFI_SUCCESS	The UDP Read operation was completed.
EFI_NOT_STARTED	The PXE Base Code Protocol is in the stopped state.
EFI_INVALID_PARAMETER	One or more of the following conditions was <b>TRUE</b> : <ul style="list-style-type: none"> <li>The <i>This</i> parameter was <b>NULL</b></li> <li>The <i>This</i> parameter did not point to a valid EFI_PXE_BASE_CODE_PROTOCOL structure</li> <li>Reserved bits in the OpFlags parameter were not set to zero</li> <li>The HeaderSize parameter is not <b>NULL</b> and *HeaderSize is zero</li> <li>The HeaderSize parameter is not <b>NULL</b> and the HeaderPtr parameter is <b>NULL</b></li> <li>The BufferSize parameter is <b>NULL</b></li> <li>The BufferPtr parameter is <b>NULL</b></li> </ul>
EFI_DEVICE_ERROR	The network device encountered an error during this operation.
EFI_BUFFER_TOO_SMALL	The packet is larger than <i>Buffer</i> can hold.
EFI_ABORTED	The callback function aborted the UDP Read operation.
EFI_TIMEOUT	The UDP Read operation timed out.

## EFI\_PXE\_BASE\_CODE\_PROTOCOL.SetIpFilter()

### Summary

Updates the IP receive filters of a network device and enables software filtering.

### Prototype

```
typedef
EFI_STATUS
(EFIAPI *EFI_PXE_BASE_CODE_SET_IP_FILTER) (
    IN EFI_PXE_BASE_CODE_PROTOCOL          *This,
    IN EFI_PXE_BASE_CODE_IP_FILTER        *NewFilter
);
```

### Parameters

<i>This</i>	Pointer to the <a href="#">EFI_PXE_BASE_CODE_PROTOCOL</a> instance.
<i>NewFilter</i>	Pointer to the new set of IP receive filters.

### Description

The **NewFilter** field is used to modify the network device's current IP receive filter settings and to enable a software filter. This function updates the **IpFilter** field of the [EFI\\_PXE\\_BASE\\_CODE\\_MODE](#) structure with the contents of **NewIpFilter**. The software filter is used when the **USE\_FILTER** in **OpFlags** is set to [UdpRead\(\)](#). The current hardware filter remains in effect no matter what the settings of **OpFlags** are, so that the meaning of **ANY\_DEST\_IP** set in **OpFlags** to [UdpRead\(\)](#) is from those packets whose reception is enabled in hardware – physical NIC address (unicast), broadcast address, logical address or addresses (multicast), or all (promiscuous). [UdpRead\(\)](#) does not modify the IP filter settings.

[Dhcp\(\)](#), [Discover\(\)](#), and [Mftftp\(\)](#) set the IP filter, and return with the IP receive filter list emptied and the filter set to `EFI_PXE_BASE_CODE_IP_FILTER_STATION_IP`. If an application or driver wishes to preserve the IP receive filter settings, it will have to preserve the IP receive filter settings before these calls, and use [SetIpFilter\(\)](#) to restore them after the calls. If incompatible filtering is requested (for example, PROMISCUOUS with anything else) or if the device does not support a requested filter setting and it cannot be accommodated in software (for example, PROMISCUOUS not supported), `EFI_INVALID_PARAMETER` will be returned. The *IPlist* field is used to enable IPs other than the *StationIP*. They may be multicast or unicast. If *IPcnt* is set as well as `EFI_PXE_BASE_CODE_IP_FILTER_STATION_IP`, then both the *StationIP* and the IPs from the *IPlist* will be used.

### Status Codes Returned

EFI_SUCCESS	The IP receive filter settings were updated.
-------------	--

EFI_INVALID_PARAMETER	<ul style="list-style-type: none"><li>• One or more of the following conditions was <b>TRUE</b>:</li><li>• The <i>This</i> parameter was <b>NULL</b></li><li>• The <i>This</i> parameter did not point to a valid <a href="#">EFI PXE BASE CODE PROTOCOL</a> structure</li><li>• The <i>NewFilter</i> parameter was <b>NULL</b></li><li>• The <i>NewFilter</i> -&gt; <i>IPList</i> [] array contains one or more broadcast IP addresses</li></ul>
EFI_NOT_STARTED	The PXE Base Code Protocol is not in the started state.

## EFI\_PXE\_BASE\_CODE\_PROTOCOL.Arp()

### Summary

Uses the ARP protocol to resolve a MAC address.

### Prototype

```
typedef
EFI_STATUS
(EFI_API *EFI_PXE_BASE_CODE_ARP) (
  IN EFI_PXE_BASE_CODE_PROTOCOL *This,
  IN EFI_IP_ADDRESS *IpAddr,
  IN EFI_MAC_ADDRESS *MacAddr OPTIONAL
);
```

### Parameters

<i>This</i>	Pointer to the <a href="#">EFI_PXE_BASE_CODE_PROTOCOL</a> instance.
<i>IpAddr</i>	Pointer to the IP address that is used to resolve a MAC address. When the MAC address is resolved, the <b>ArpCacheEntries</b> and <b>ArpCache</b> fields of the <a href="#">EFI_PXE_BASE_CODE_MODE</a> structure are updated.
<i>MacAddr</i>	If not <b>NULL</b> , a pointer to the MAC address that was resolved with the ARP protocol.

### Description

This function uses the ARP protocol to resolve a MAC address. The **UsingIpv6** field of the [EFI\\_PXE\\_BASE\\_CODE\\_MODE](#) structure is used to determine if IPv4 or IPv6 addresses are being used. The IP address specified by **IpAddr** is used to resolve a MAC address in the case of IPv4; the concept of Arp is not supported in IPv6, though.

If the ARP protocol succeeds in resolving the specified address, then the **ArpCacheEntries** and **ArpCache** fields of the [EFI\\_PXE\\_BASE\\_CODE\\_MODE](#) structure are updated, and **EFI\_SUCCESS** is returned. If **MacAddr** is not **NULL**, the resolved MAC address is placed there as well.

If the PXE Base Code protocol is in the stopped state, then **EFI\_NOT\_STARTED** is returned. If the ARP protocol encounters a timeout condition while attempting to resolve an address, then **EFI\_TIMEOUT** is returned. If the Callback Protocol does not return **EFI\_PXE\_BASE\_CODE\_CALLBACK\_STATUS\_CONTINUE**, then **EFI\_ABORTED** is returned.

### Status Codes Returned

EFI_SUCCESS	The IP or MAC address was resolved.
-------------	-------------------------------------

EFI_INVALID_PARAMETER	One or more of the following conditions was : <ul style="list-style-type: none"><li>• The <i>This</i> parameter was <b>NULL</b></li><li>• The <i>This</i> parameter did not point to a valid <b>EFI_PXE_BASE_CODE_PROTOCOL</b> structure</li><li>• The IpAddr parameter was <b>NULL</b></li></ul>
EFI_DEVICE_ERROR	The network device encountered an error during this operation.
EFI_NOT_STARTED	The PXE Base Code Protocol is in the stopped state.
EFI_TIMEOUT	The ARP Protocol encountered a timeout condition.
EFI_ABORTED	The callback function aborted the ARP Protocol.
EFI_UNSUPPORTED	When Mode->UsingIpv6 is <b>TRUE</b> because the Arp is a concept special for IPv4.

## EFI\_PXE\_BASE\_CODE\_PROTOCOL.SetParameters()

### Summary

Updates the parameters that affect the operation of the PXE Base Code Protocol.

### Prototype

```
typedef
EFI_STATUS
(EFI_API *EFI_PXE_BASE_CODE_SET_PARAMETERS) (
  IN EFI_PXE_BASE_CODE_PROTOCOL *This,
  IN BOOLEAN      *NewAutoArp,  OPTIONAL
  IN BOOLEAN      *NewSendGUID, OPTIONAL
  IN UINT8        *NewTTL,      OPTIONAL
  IN UINT8        *NewToS,      OPTIONAL
  IN BOOLEAN      *NewMakeCallback OPTIONAL
);
```

### Parameters

<i>This</i>	Pointer to the <a href="#">EFI PXE BASE CODE PROTOCOL</a> instance.
<i>NewAutoArp</i>	If not <b>NULL</b> , a pointer to a value that specifies whether to replace the current value of <b>AutoARP</b> . <b>TRUE</b> for automatic ARP packet generation, <b>FALSE</b> otherwise. If <b>NULL</b> , this parameter is ignored.
<i>NewSendGUID</i>	If not <b>NULL</b> , a pointer to a value that specifies whether to replace the current value of <b>SendGUID</b> . <b>TRUE</b> to send the SystemGUID (if there is one) as the client hardware address in DHCP; <b>FALSE</b> to send client NIC MAC address. If <b>NULL</b> , this parameter is ignored. If <i>NewSendGUID</i> is <b>TRUE</b> and there is no SystemGUID, then <b>EFI_INVALID_PARAMETER</b> is returned.
<i>NewTTL</i>	If not <b>NULL</b> , a pointer to be used in place of the current value of <b>TTL</b> , the “time to live” field of the IP header. If <b>NULL</b> , this parameter is ignored.
<i>NewToS</i>	If not <b>NULL</b> , a pointer to be used in place of the current value of <b>ToS</b> , the “type of service” field of the IP header. If <b>NULL</b> , this parameter is ignored.
<i>NewMakeCallback</i>	If not <b>NULL</b> , a pointer to a value that specifies whether to replace the current value of the <b>MakeCallback</b> field of the Mode structure. If <b>NULL</b> , this parameter is ignored. If the Callback Protocol is not available <b>EFI_INVALID_PARAMETER</b> is returned.

### Description

This function sets parameters that affect the operation of the PXE Base Code Protocol. The parameter specified by *NewAutoArp* is used to control the generation of ARP

protocol packets. If *NewAutoArp* is **TRUE**, then ARP Protocol packets will be generated as required by the PXE Base Code Protocol. If *NewAutoArp* is **FALSE**, then no ARP Protocol packets will be generated. In this case, the only mappings that are available are those stored in the **ArpCache** of the **EFI\_PXE\_BASE\_CODE\_MODE** structure. If there are not enough mappings in the **ArpCache** to perform a PXE Base Code Protocol service, then the service will fail. This function updates the **AutoArp** field of the **EFI\_PXE\_BASE\_CODE\_MODE** structure to **NewAutoArp**.

The [SetParameters\(\)](#) call must be invoked after a Callback Protocol is installed to enable the use of callbacks.

## Status Codes Returned

EFI_SUCCESS	The new parameters values were updated.
EFI_INVALID_PARAMETER	<ul style="list-style-type: none"> <li>• One or more of the following conditions was <b>TRUE</b> :</li> <li>• The <i>This</i> parameter was <b>NULL</b></li> <li>• The <i>This</i> parameter did not point to a valid <b>EFI_PXE_BASE_CODE_PROTOCOL</b> structure</li> <li>• The <i>NewSendGUID</i> parameter is not <b>NULL</b> and * <i>NewSendGUID</i> is <b>TRUE</b> and a system GUID could not be located</li> <li>• The <i>NewMakeCallback</i> parameter is not <b>NULL</b> and * <i>NewMakeCallback</i> is <b>TRUE</b> and an <b>EFI_PXE_BASE_CODE_CALLBACK_PROTOCOL</b> could not be located on the network device handle.</li> </ul>
EFI_NOT_STARTED	The PXE Base Code Protocol is not in the started state.

## EFI\_PXE\_BASE\_CODE\_PROTOCOL.SetStationIp()

### Summary

Updates the station IP address and/or subnet mask values of a network device.

### Prototype

```
typedef
EFI_STATUS
(EFI_API *EFI_PXE_BASE_CODE_SET_STATION_IP) (
  IN EFI_PXE_BASE_CODE_PROTOCOL *This,
  IN EFI_IP_ADDRESS             *NewStationIp, OPTIONAL
  IN EFI_IP_ADDRESS             *NewSubnetMask OPTIONAL
);
```

### Parameters

<i>This</i>	Pointer to the <a href="#">EFI_PXE_BASE_CODE_PROTOCOL</a> instance.
<i>NewStationIp</i>	Pointer to the new IP address to be used by the network device. If this field is <b>NULL</b> , then the <b>StationIp</b> address will not be modified.
<i>NewSubnetMask</i>	Pointer to the new subnet mask to be used by the network device. If this field is <b>NULL</b> , then the <b>SubnetMask</b> will not be modified.

### Description

This function updates the station IP address and/or subnet mask values of a network device.

The *NewStationIp* field is used to modify the network device's current IP address. If *NewStationIp* is **NULL**, then the current IP address will not be modified. Otherwise, this function updates the *StationIp* field of the [EFI\\_PXE\\_BASE\\_CODE\\_MODE](#) structure with *NewStationIp*.

The *NewSubnetMask* field is used to modify the network device's current subnet mask. If *NewSubnetMask* is **NULL**, then the current subnet mask will not be modified. Otherwise, this function updates the **SubnetMask** field of the [EFI\\_PXE\\_BASE\\_CODE\\_MODE](#) structure with *NewSubnetMask*.

### Status Codes Returned

EFI_SUCCESS	The new station IP address and/or subnet mask were updated.
-------------	---



EFI_INVALID_PARAMETER	One or more of the following conditions was <b>TRUE</b> : <ul style="list-style-type: none"><li>• The <i>This</i>s parameter was <b>NULL</b></li><li>• The <i>This</i> parameter did not point to a valid <a href="#">EFI_PXE_BASE_CODE_PROTOCOL</a> structure</li><li>• The <i>NewStationIp</i> parameter is not <b>NULL</b> and * <i>NewStationIp</i> is not a valid unicast IP address</li><li>• The <i>NewSubnetMask</i> parameter is not <b>NULL</b> and * <i>NewSubnetMask</i> does not contain a valid IP subnet mask</li></ul>
EFI_NOT_STARTED	The PXE Base Code Protocol is not in the started state.

## EFI\_PXE\_BASE\_CODE\_PROTOCOL.SetPackets()

### Summary

Updates the contents of the cached DHCP and Discover packets.

### Prototype

```
typedef
EFI_STATUS
(EFI_API *EFI_PXE_BASE_CODE_SET_PACKETS) (
    IN EFI_PXE_BASE_CODE_PROTOCOL      *This,
    IN BOOLEAN                        *NewDhcpDiscoverValid, OPTIONAL
    IN BOOLEAN                        *NewDhcpAckReceived,  OPTIONAL
    IN BOOLEAN                        *NewProxyOfferReceived, OPTIONAL
    IN BOOLEAN                        *NewPxeDiscoverValid,  OPTIONAL
    IN BOOLEAN                        *NewPxeReplyReceived,  OPTIONAL
    IN BOOLEAN                        *NewPxeBisReplyReceived, OPTIONAL
    IN EFI_PXE_BASE_CODE_PACKET      *NewDhcpDiscover,  OPTIONAL
    IN EFI_PXE_BASE_CODE_PACKET      *NewDhcpAck,     OPTIONAL
    IN EFI_PXE_BASE_CODE_PACKET      *NewProxyOffer,   OPTIONAL
    IN EFI_PXE_BASE_CODE_PACKET      *NewPxeDiscover,  OPTIONAL
    IN EFI_PXE_BASE_CODE_PACKET      *NewPxeReply,    OPTIONAL
    IN EFI_PXE_BASE_CODE_PACKET      *NewPxeBisReply,  OPTIONAL
);
```

### Parameters

<i>This</i>	Pointer to the <a href="#">EFI PXE BASE CODE PROTOCOL</a> instance.
<i>NewDhcpDiscoverValid</i>	Pointer to a value that will replace the current <i>DhcpDiscoverValid</i> field. If <b>NULL</b> , this parameter is ignored.
<i>NewDhcpAckReceived</i>	Pointer to a value that will replace the current <b>DhcpAckReceived</b> field. If <b>NULL</b> , this parameter is ignored.
<i>NewProxyOfferReceived</i>	Pointer to a value that will replace the current <i>ProxyOfferReceived</i> field. If <b>NULL</b> , this parameter is ignored.
<i>NewPxeDiscoverValid</i>	Pointer to a value that will replace the current <i>ProxyOfferReceived</i> field. If <b>NULL</b> , this parameter is ignored.
<i>NewPxeReplyReceived</i>	Pointer to a value that will replace the current <i>PxeReplyReceived</i> field. If <b>NULL</b> , this parameter is ignored.
<i>NewPxeBisReplyReceived</i>	Pointer to a value that will replace the current <i>PxeBisReplyReceived</i> field. If <b>NULL</b> , this parameter is ignored.

<i>NewDhcpDiscover</i>	Pointer to the new cached DHCP Discover packet contents. If <b>NULL</b> , this parameter is ignored.
<i>NewDhcpAck</i>	Pointer to the new cached DHCP Ack packet contents. If <b>NULL</b> , this parameter is ignored.
<i>NewProxyOffer</i>	Pointer to the new cached Proxy Offer packet contents. If <b>NULL</b> , this parameter is ignored.
<i>NewPxeDiscover</i>	Pointer to the new cached PXE Discover packet contents. If <b>NULL</b> , this parameter is ignored.
<i>NewPxeReply</i>	Pointer to the new cached PXE Reply packet contents. If <b>NULL</b> , this parameter is ignored.
<i>NewPxeBisReply</i>	Pointer to the new cached PXE BIS Reply packet contents. If <b>NULL</b> , this parameter is ignored.

## Description

The pointers to the new packets are used to update the contents of the cached packets in the [EFI\\_PXE\\_BASE\\_CODE\\_MODE](#) structure.

## Status Codes Returned

EFI_SUCCESS	The cached packet contents were updated.
EFI_INVALID_PARAMETER	<ul style="list-style-type: none"> <li>One or more of the following conditions was <b>TRUE</b>:</li> <li>The <i>This</i> parameter was <b>NULL</b></li> </ul> The <i>This</i> parameter did not point to a valid <a href="#">EFI_PXE_BASE_CODE_PROTOCOL</a> structure.
EFI_NOT_STARTED	The PXE Base Code Protocol is not in the started state.

### 24.3.1 Netboot6

For IPv4, PXE drivers typically install a LoadFile protocol on the NIC handle. In the case of supporting both IPv4 and IPv6 where two PXE Base Code and LoadFile protocol instances need be produced, the PXE driver will have to create two child handles and install [EFI\\_LOAD\\_FILE\\_PROTOCOL](#), [EFI\\_SIMPLE\\_NETWORK\\_PROTOCOL](#) and [PXE\\_BASE\\_CODE\\_PROTOCOL](#) on each child handle. To distinguish these two child handles, an IP device path node can be appended to the parent device path, for example:

**PciRoot(0x0)/Pci(0x19,0x0)/MAC(001320F4B4FF,0x0)/IPv4(...)**  
**PciRoot(0x0)/Pci(0x19,0x0)/MAC(001320F4B4FF,0x0)/IPv6(...)**

These two instances allow for the boot manager to decide a preference of IPv6 versus IPv4 since the IETF and other bodies do not speak to this policy choice.

#### 24.3.1.1 DHCP6 options for PXE

In IPv4-based PXE, as defined by the rfc2131, rfc2132 and rfc4578, and described by the PXE2.1 specification and the UEFI specification, there are the following PXE related options/fields in DHCPv4 packet:

- siaddr field/ServerAddress option (54) – next server address.

- BootFileName option (67)
- ) – NBP file name.
- BootFileSize option (13)
- – NBP file size.
- ClassIdentifier (60)
- – PXE client tag.
- ClientSystemArchitectureType option (93)
- – client architecture type.
- ClientNetworkInterface Identifier option (94)
- – client network interface identifier.

In IPv6-based PXE, or 'netboot6', there are the following PXE related options in the DHCPv6 packet:

- BootFileURL option - OPT\_BOOTFILE\_URL (59) – next server address and NBP (Network Bootable Program) file name.
- BootFileParameters option
- - OPT\_BOOTFILE\_PARAM (60) – NBP file size.
- VendorClass option (16)
- – PXE client tag.
- ClientSystemArchitectureType option - OPTION\_CLIENT\_ARCH\_TYPE (61) – client architecture type.
- ClientNetworkInterfaceIdentifier option (
- 62) – client network interface identifier.

The BootFileURL option is used to deliver the next server address or the next server address with NBP file name.

As an example where the next server address delivered only:

"tftp:// [FEDC:BA98:7654:3210:FEDC:BA98:7654:3210];mode=octet".

As an example where the next server address and BOOTFILE\_NAME delivered both:

"tftp:// [FEDC:BA98:7654:3210:FEDC:BA98:7654:3210]/ BOOTFILE\_NAME ;mode=octet".

The BootFileParameters option is used to deliver the NBP file size with the unit of 512-octet blocks. The maximum of the NBP file size is 65535 \* 512 bytes.

As an example where the NBP file size is 1600 \* 512 bytes:

**para-len 1 = 4**  
**parameter 1 = "1600"**

The VendorClass option is used to deliver the PXE client tag.

As an example where the client architecture is EFI-X64 and the client network interface identifier is UNDI:

**Enterprise-number = (343)**  
**Vendor-class-data = "PXEClient:Arch:00006:UNDI:003016"**

**#define DUID-UUID 4**

The Netboot6 client will use the DUID-UUID to report the platform identifier as part of the netboot6 DHCP options.

### 24.3.1.2 IPv6-based PXE boot

As PXE 2.1 specification describes step-by-step synopsis of the IPv4-based PXE process, Figure 1 describes the corresponding synopsis for netboot6.

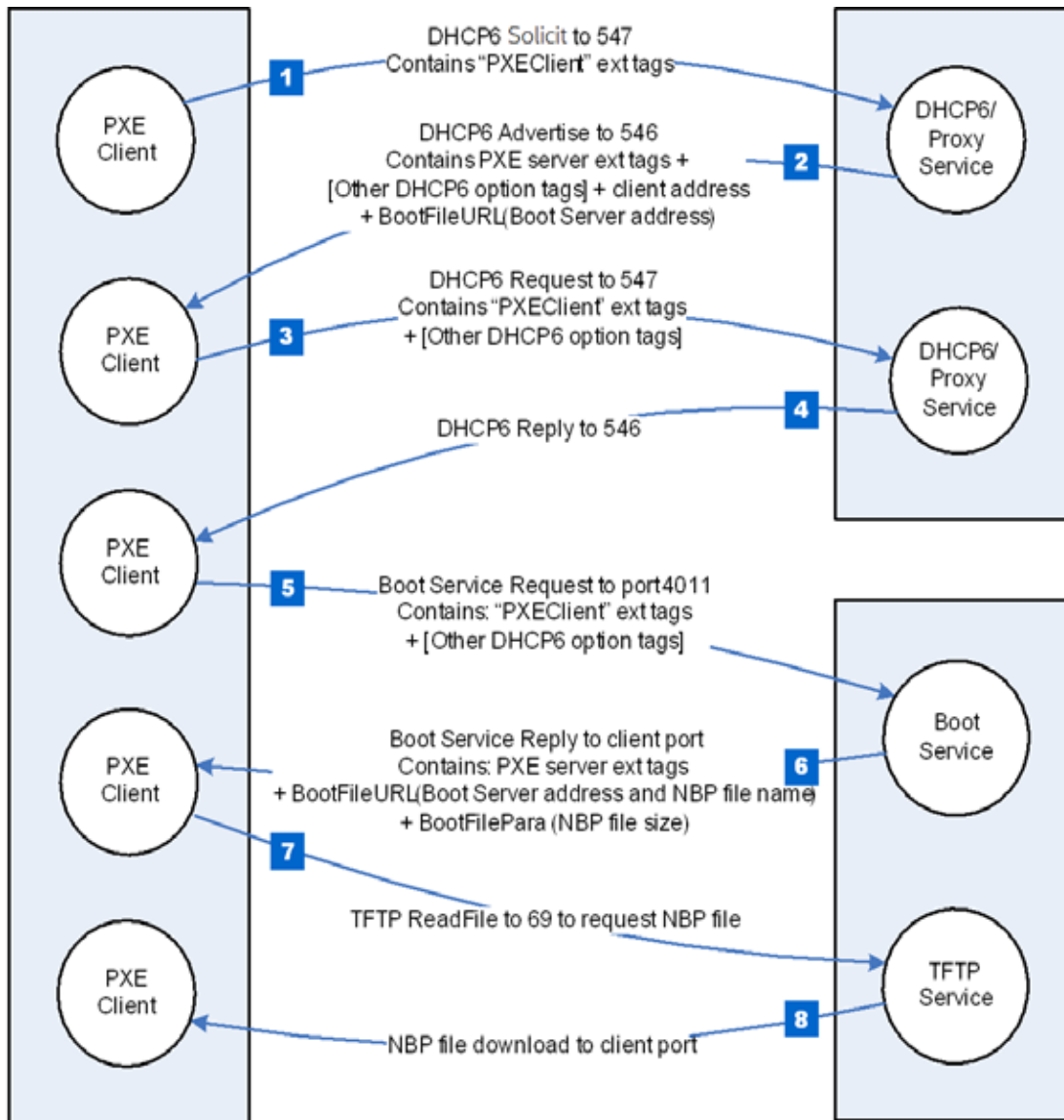

Figure 73. IPv6-based PXE boot

**24.3.1.2.1 Step 1.**

The client multicasts a SOLICIT message to the standard DHCP6 port (547). It contains the following:

- A tag for client UNDI version.
- A tag for the client system architecture.
- A tag for PXE client, Vendor Class data set to
- "PXEClient:Arch:xxxxx:UNDI:yyyzzz".

**24.3.1.2.2 Step 2.**

The DHCP6 or Proxy DHCP6 service responds by sending a ADVERTISE message to the client on the standard DHCP6 reply port (546). If this is a Proxy DHCP6 service, the next server (Boot Server) address is delivered by Boot File URL option. If this is a DHCP6 service, the new assigned client address is delivered by IA option. The extension tags information will be conveyed via the VENDOR OPTS field.

**24.3.1.2.3 Steps 3 and 4.**

If the client selects an address from a DHCP6 service, then it must complete the standard DHCP6 process by sending a REQUEST for the address back to the service and then waiting for an REPLY from the service.

**24.3.1.2.4 Step 5.**

The client multicasts a REQUEST message to the Boot Server port 4011, it contains the following:

- A tag for client UNDI version.
- A tag for the client system architecture.
- A tag for PXE client, Vendor Class option, set to
- "PXEClient:Arch:xxxxx:UNDI:yyyzzz".

**24.3.1.2.5 Step 6.**

The Boot Server unicasts a REPLY message back to the client on the client port. It contains the following:

- A tag for NBP file name.
- A tag for NBP file size if needed.

**24.3.1.2.6 Step 7.**

The client requests the NBP file using TFTP (port 69).

**24.3.1.2.7 Step 8.**

The NBP file, dependent on the client's CPU architecture, is downloaded into client's memory.

### 24.3.1.3 Proxy DHCP6

The netboot6 DHCP6 options may be supplied by the DHCP6 service or a Proxy DHCP6 service. This Proxy DHCP6 service may reside on the same server as the DHCP6 service, or it may be located on a separate server. A Proxy DHCP6 service on the same server as the DHCP6 service is illustrated in Figure 2. In this case, the Proxy DHCP6 service is listening to UDP port (4011), and communication with the Proxy DHCP6 service occurs after completing the standard DHCP6 process. Proxy DHCP6 uses port (4011) because it cannot share port (547) with the DHCP6 service. The netboot6 client knows how to interrogate the Proxy DHCP6 service because the ADVERTISE from the DHCP6 service contains a VendorClass option "PXECient" tag without a BootFileURL option (including NBP file name). The client will not request option 16 (**OPTION\_VENDOR\_CLASS**) in ORO, but server must still reply with "PXECient" in order to inform the client to start the Proxy DHCPv6 mode. The client will accept just the string "PXECient" as sufficient, the server need not echo back the entire

**OPTION\_VENDOR\_CLASS.**

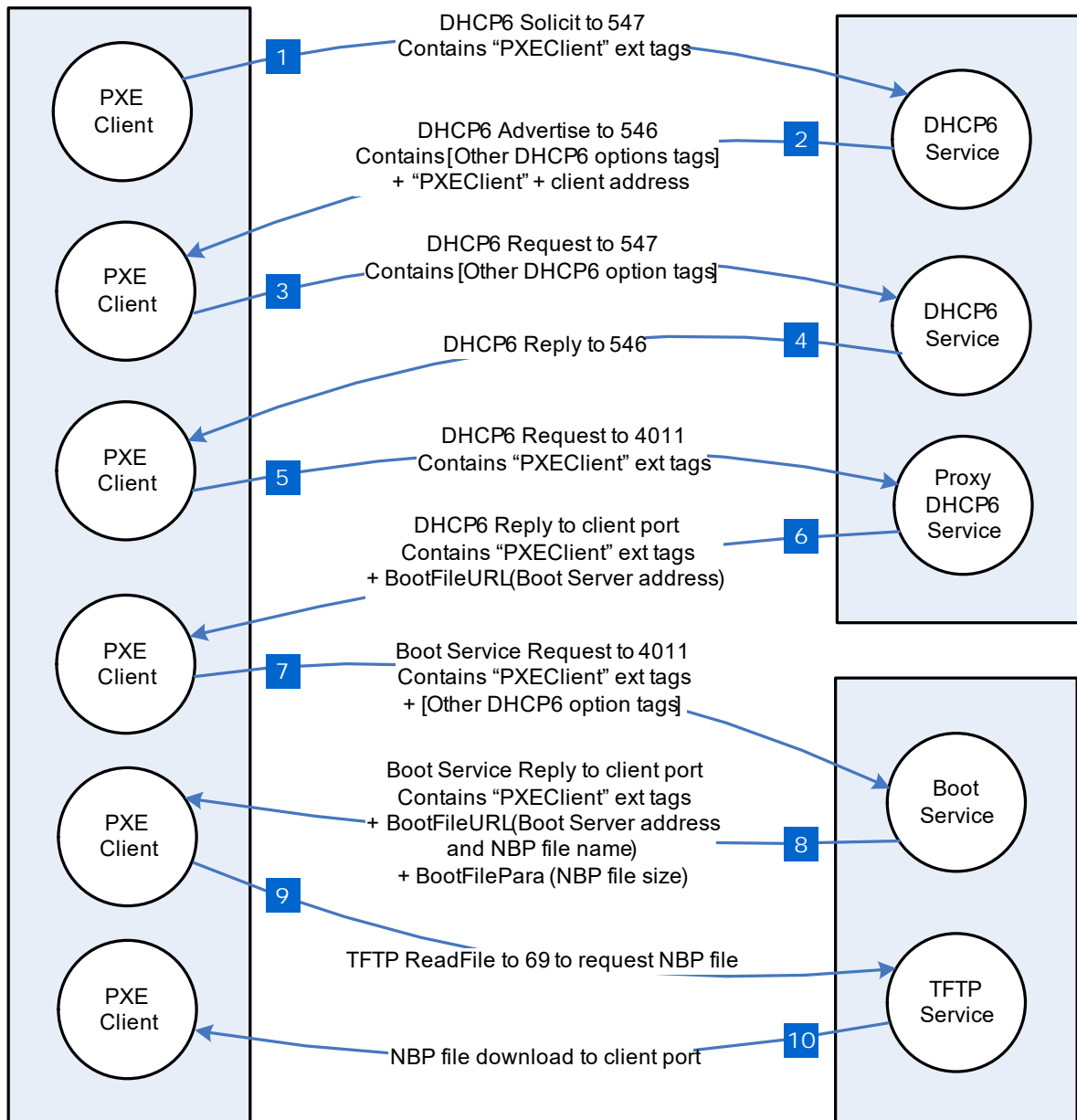

Figure 74. netboot6 (DHCP6 and ProxyDHCP6 reside on the same server)

[Figure 75](#) illustrates the case of a Proxy DHCP6 service and the DHCP6 service on different servers. In this case, the Proxy DHCP6 service listens to UDP port (547) and responds in parallel with DHCP6 service.



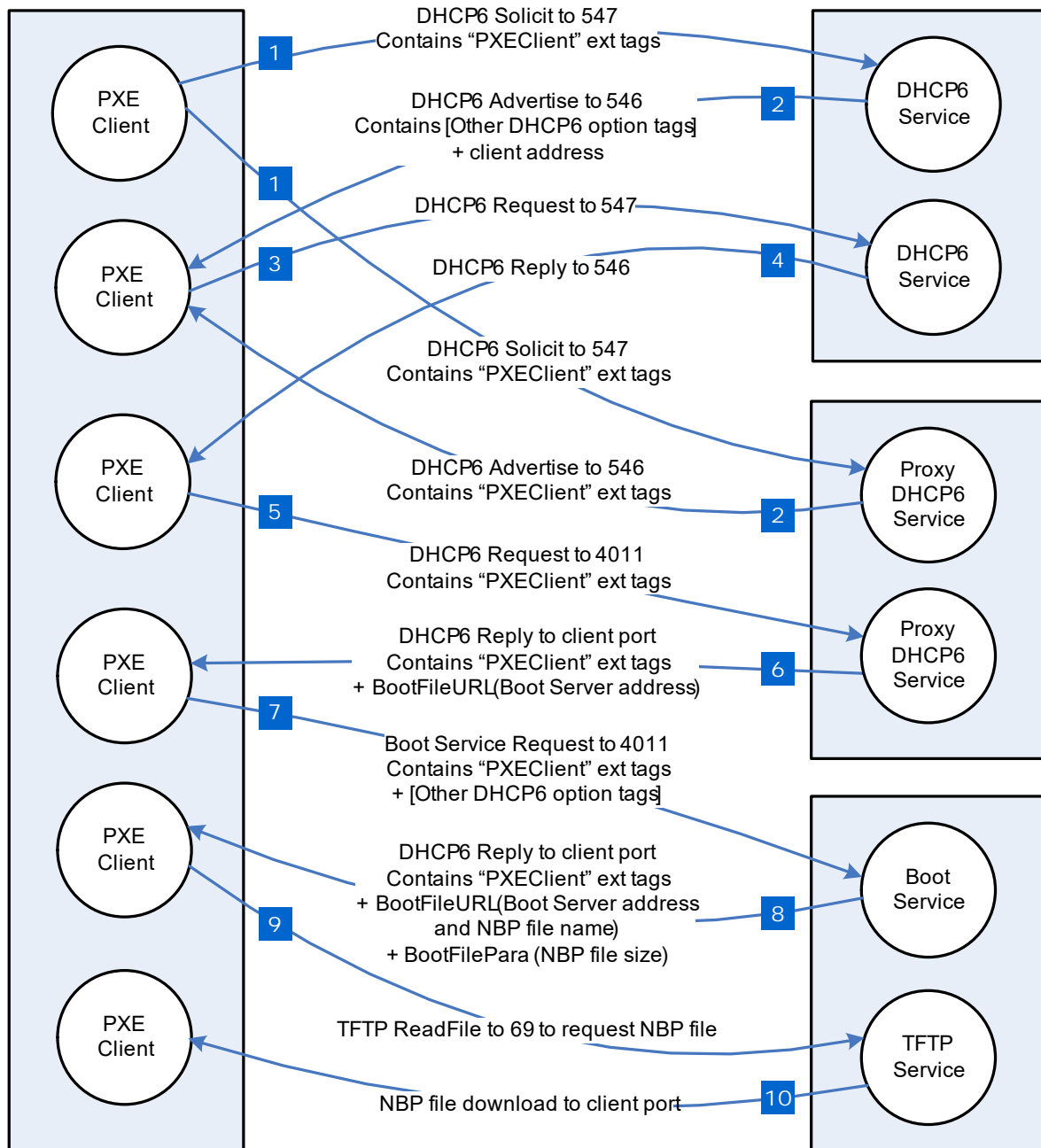

Figure 75. IPv6-based PXE boot (DHCP6 and ProxyDHCP6 reside on the different server)

## 24.4 PXE Base Code Callback Protocol

This protocol is a specific instance of the PXE Base Code Callback Protocol that is invoked when the PXE Base Code Protocol is about to transmit, has received, or is waiting to receive a packet. The PXE Base Code Callback Protocol must be on the same handle as the PXE Base Code Protocol.

## EFI\_PXE\_BASE\_CODE\_CALLBACK\_PROTOCOL

### Summary

Protocol that is invoked when the PXE Base Code Protocol is about to transmit, has received, or is waiting to receive a packet.

### GUID

```
#define EFI_PXE_BASE_CODE_CALLBACK_PROTOCOL_GUID \
  {0x245DCA21,0xFB7B,0x11d3,\
   {0x8F,0x01,0x00,0xA0, 0xC9,0x69,0x72,0x3B}}
```

### Revision Number

```
#define EFI_PXE_BASE_CODE_CALLBACK_PROTOCOL_REVISION \
  0x00010000
```

### Protocol Interface Structure

```
typedef struct {
  UINT64      Revision;
  EFI_PXE_CALLBACK Callback;
} EFI_PXE_BASE_CODE_CALLBACK_PROTOCOL;
```

### Parameters

*Revision*

The revision of the **EFI\_PXE\_BASE\_CODE\_CALLBACK\_PROTOCOL**. All future revisions must be backwards compatible. If a future revision is not backwards compatible, it is not the same GUID.

*Callback*

Callback routine used by the PXE Base Code [Dhcp\(\)](#), [Discover\(\)](#), [Mftp\(\)](#), [UdpWrite\(\)](#), and [Arp\(\)](#) functions.

## EFI\_PXE\_BASE\_CODE\_CALLBACK.Callback()

### Summary

Callback function that is invoked when the PXE Base Code Protocol is about to transmit, has received, or is waiting to receive a packet.

### Prototype

```
typedef
EFI_PXE_BASE_CODE_CALLBACK_STATUS
(*EFI_PXE_CALLBACK) (
  IN EFI_PXE_BASE_CODE_CALLBACK_PROTOCOL *This,
  IN EFI_PXE_BASE_CODE_FUNCTION    Function,
  IN BOOLEAN                        Received,
  IN UINT32                         PacketLen,
  IN EFI_PXE_BASE_CODE_PACKET      *Packet OPTIONAL
);
```

### Parameters

<i>This</i>	Pointer to the <a href="#">EFI PXE BASE CODE PROTOCOL</a> instance.
<i>Function</i>	The PXE Base Code Protocol function that is waiting for an event.
<i>Received</i>	<b>TRUE</b> if the callback is being invoked due to a receive event. <b>FALSE</b> if the callback is being invoked due to a transmit event.
<i>PacketLen</i>	The length, in bytes, of <b>Packet</b> . This field will have a value of zero if this is a wait for receive event.
<i>Packet</i>	If <i>Received</i> is <b>TRUE</b> , a pointer to the packet that was just received; otherwise a pointer to the packet that is about to be transmitted. This field will be <b>NULL</b> if this is not a packet event.

### Related Definitions

```
/*******
// EFI_PXE_BASE_CODE_CALLBACK_STATUS
/*******
typedef enum {
    EFI_PXE_BASE_CODE_CALLBACK_STATUS_FIRST,
    EFI_PXE_BASE_CODE_CALLBACK_STATUS_CONTINUE,
    EFI_PXE_BASE_CODE_CALLBACK_STATUS_ABORT,
    EFI_PXE_BASE_CODE_CALLBACK_STATUS_LAST
} EFI_PXE_BASE_CODE_CALLBACK_STATUS;
```

```

//*****
// EFI_PXE_BASE_CODE_FUNCTION
//*****
typedef enum {
    EFI_PXE_BASE_CODE_FUNCTION_FIRST,
    EFI_PXE_BASE_CODE_FUNCTION_DHCP,
    EFI_PXE_BASE_CODE_FUNCTION_DISCOVER,
    EFI_PXE_BASE_CODE_FUNCTION_MTFTP,
    EFI_PXE_BASE_CODE_FUNCTION_UDP_WRITE,
    EFI_PXE_BASE_CODE_FUNCTION_UDP_READ,
    EFI_PXE_BASE_CODE_FUNCTION_ARP,
    EFI_PXE_BASE_CODE_FUNCTION_IGMP,
    EFI_PXE_BASE_CODE_PXE_FUNCTION_LAST
} EFI_PXE_BASE_CODE_FUNCTION;

```

## Description

This function is invoked when the PXE Base Code Protocol is about to transmit, has received, or is waiting to receive a packet. Parameters **Function** and **Received** specify the type of event. Parameters **PacketLen** and **Packet** specify the packet that generated the event. If these fields are zero and **NULL** respectively, then this is a status update callback. If the operation specified by **Function** is to continue, then **CALLBACK\_STATUS\_CONTINUE** should be returned. If the operation specified by **Function** should be aborted, then **CALLBACK\_STATUS\_ABORT** should be returned. Due to the polling nature of UEFI device drivers, a callback function should not execute for more than 5 ms.

The [SetParameters\(\)](#) function must be called after a Callback Protocol is installed to enable the use of callbacks.

## 24.5 Boot Integrity Services Protocol

This section defines the Boot Integrity Services (BIS) protocol, which is used to check a digital signature of a data block against a digital certificate for the purpose of an integrity and authorization check. BIS is primarily used by the Preboot Execution Environment (PXE) Base Code protocol [EFI PXE BASE CODE PROTOCOL](#) to check downloaded network boot images before executing them. BIS is a UEFI Boot Service Driver, so its services are also available to applications written to this specification until the time of [EFI\\_BOOT\\_SERVICES.ExitBootServices\(\)](#). More information about BIS can be found in the *Boot Integrity Services Application Programming Interface Version 1.0*.

This section defines the Boot Integrity Services Protocol. This protocol is used to check a digital signature of a data block against a digital certificate for the purpose of an integrity and authorization check.

## EFI\_BIS\_PROTOCOL

### Summary

The **EFI\_BIS\_PROTOCOL** is used to check a digital signature of a data block against a digital certificate for the purpose of an integrity and authorization check.

### GUID

```
#define EFI_BIS_PROTOCOL_GUID \
    {0x0b64aab0,0x5429,0x11d4,\
     {0x98,0x16,0x00,0xa0,0xc9,0x1f,0xad,0xcf}}
```

### Protocol Interface Structure

```
typedef struct _EFI_BIS_PROTOCOL {
    EFI_BIS_INITIALIZE Initialize;
    EFI_BIS_SHUTDOWN Shutdown;
    EFI_BIS_FREE Free;
    EFI_BIS_GET_BOOT_OBJECT_AUTHORIZATION_CERTIFICATE
        GetBootObjectAuthorizationCertificate;
    EFI_BIS_GET_BOOT_OBJECT_AUTHORIZATION_CHECKFLAG
        GetBootObjectAuthorizationCheckFlag;
    EFI_BIS_GET_BOOT_OBJECT_AUTHORIZATION_UPDATE_TOKEN
        GetBootObjectAuthorizationUpdateToken;
    EFI_BIS_GET_SIGNATURE_INFO
        GetSignatureInfo;
    EFI_BIS_UPDATE_BOOT_OBJECT_AUTHORIZATION
        UpdateBootObjectAuthorization;
    EFI_BIS_VERIFY_BOOT_OBJECT
        VerifyBootObject;
    EFI_BIS_VERIFY_OBJECT_WITH_CREDENTIAL
        VerifyObjectWithCredential;
} EFI_BIS_PROTOCOL;
```

### Parameters

#### *Initialize*

Initializes an application instance of the **EFI\_BIS** protocol, returning a handle for the application instance. Other functions in the **EFI\_BIS** protocol require a valid application instance handle obtained from this function. See the [Initialize\(\)](#) function description.

#### *Shutdown*

Ends the lifetime of an application instance of the **EFI\_BIS** protocol, invalidating its application instance handle. The application instance handle may no longer be used in other functions in the **EFI\_BIS** protocol. See the [Shutdown\(\)](#) function description.

- Free* Frees memory structures allocated and returned by other functions in the **EFI\_BIS** protocol. See the [Free\(\)](#) function description.
- GetBootObjectAuthorizationCertificate* Retrieves the current digital certificate (if any) used by the **EFI\_BIS** protocol as the source of authorization for verifying boot objects and altering configuration parameters. See the [GetBootObjectAuthorizationCertificate\(\)](#) function description.
- GetBootObjectAuthorizationCheckFlag* Retrieves the current setting of the authorization check flag that indicates whether or not authorization checks are required for boot objects. See the [GetBootObjectAuthorizationCheckFlag\(\)](#) function description.
- GetBootObjectAuthorizationUpdateToken* Retrieves an uninterpreted token whose value gets included and signed in a subsequent request to alter the configuration parameters, to protect against attempts to “replay” such a request. See the [GetBootObjectAuthorizationUpdateToken\(\)](#) function description.
- GetSignatureInfo* Retrieves information about the digital signature algorithms supported and the identity of the installed authorization certificate, if any. See the [GetSignatureInfo\(\)](#) function description.
- UpdateBootObjectAuthorization* Requests that the configuration parameters be altered by installing or removing an authorization certificate or changing the setting of the check flag. See the [UpdateBootObjectAuthorization\(\)](#) function description.
- VerifyBootObject* Verifies a boot object according to the supplied digital signature and the current authorization certificate and check flag setting. See the [VerifyBootObject\(\)](#) function description.
- VerifyObjectWithCredential* Verifies a data object according to a supplied digital signature and a supplied digital certificate. See the [VerifyObjectWithCredential\(\)](#) function description.

## Description

The **EFI\_BIS\_PROTOCOL** provides a set of functions as defined in this section. There is no physical device associated with these functions, however, in the context of UEFI every

protocol operates on a device. Accordingly, BIS installs and operates on a single abstract device that has only a software representation.

## EFI\_BIS\_PROTOCOL.Initialize()

### Summary

Initializes the BIS service, checking that it is compatible with the version requested by the caller. After this call, other BIS functions may be invoked.

### Prototype

```
typedef
EFI_STATUS
(EFIAPI *EFI_BIS_INITIALIZE)(
  IN EFI_BIS_PROTOCOL *This,
  OUT BIS_APPLICATION_HANDLE *AppHandle,
  IN OUT EFI_BIS_VERSION *InterfaceVersion,
  IN EFI_BIS_DATA *TargetAddress
);
```

### Parameters

*This*

A pointer to the [EFI\\_BIS\\_PROTOCOL](#) object. The protocol implementation may rely on the actual pointer value and object location, so the caller must not copy the object to a new location.

*AppHandle*

The function writes the new [BIS\\_APPLICATION\\_HANDLE](#) if successful, otherwise it writes **NULL**. The caller must eventually destroy this handle by calling [Shutdown\(\)](#). Type **BIS\_APPLICATION\_HANDLE** is defined in “Related Definitions” below.

*InterfaceVersion*

On input, the caller supplies the major version number of the interface version desired. The minor version number supplied on input is ignored since interface compatibility is determined solely by the major version number. On output, both the major and minor version numbers are updated with the major and minor version numbers of the interface (and underlying implementation). This update is done whether or not the initialization was successful. Type **EFI\_BIS\_VERSION** is defined in “Related Definitions” below.

*TargetAddress*

Indicates a network or device address of the BIS platform to connect to. Local-platform BIS implementations require that the caller sets *TargetAddress.Data* to **NULL**, but otherwise ignores this parameter. BIS implementations that redirect calls to an agent at a remote address must define their own format and interpretation of this parameter outside the scope of this document. For all implementations, if the *TargetAddress* is an unsupported value, the function fails with the error



**EFI\_UNSUPPORTED**. Type **EFI\_BIS\_DATA** is defined in “Related Definitions” below.

## Related Definitions

```

//*****
// BIS_APPLICATION_HANDLE
//*****
typedef VOID    *BIS_APPLICATION_HANDLE;

```

This type is an opaque handle representing an initialized instance of the BIS interface. A **BIS\_APPLICATION\_HANDLE** value is returned by the *Initialize()* function as an “out” parameter. Other BIS functions take a **BIS\_APPLICATION\_HANDLE** as an “in” parameter to identify the BIS instance.

```

//*****
// EFI_BIS_VERSION
//*****
typedef struct _EFI_BIS_VERSION {
    UINT32    Major;
    UINT32    Minor;
} EFI_BIS_VERSION;

```

*Major*

This describes the major BIS version number. The major version number defines version compatibility. That is, when a new version of the BIS interface is created with new capabilities that are not available in the previous interface version, the major version number is increased.

*Minor*

This describes a minor BIS version number. This version number is increased whenever a new BIS implementation is built that is fully interface compatible with the previous BIS implementation. This number may be reset when the major version number is increased.

This type represents a version number of the BIS interface. This is used as an “in out” parameter of the *Initialize()* function for a simple form of negotiation of the BIS interface version between the caller and the BIS implementation.

```

//*****
// EFI_BIS_VERSION predefined values
// Use these values to initialize EFI_BIS_VERSION.Major
// and to interpret results of Initialize.
//*****
#define BIS_CURRENT_VERSION_MAJOR  BIS_VERSION_1
#define BIS_VERSION_1              1

```

These C preprocessor macros supply values for the major version number of an **EFI\_BIS\_VERSION**. At the time of initialization, a caller supplies a value to request a BIS interface version. On return, the (IN OUT) parameter is over-written with the actual version of the interface.

```

//*****
// EFI_BIS_DATA
//
// EFI_BIS_DATA instances obtained from BIS must be freed by
// calling Free\(\).
//*****
typedef struct _EFI_BIS_DATA {
    UINT32 Length;
    UINT8 *Data;
} EFI_BIS_DATA;

    Length                The length of the data buffer in bytes.
    Data                  A pointer to the raw data buffer.

```

This type defines a structure that describes a buffer. BIS uses this type to pass back and forth most large objects such as digital certificates, strings, etc. Several of the BIS functions allocate a **EFI\_BIS\_DATA\*** and return it as an “out” parameter. The caller must eventually free any allocated **EFI\_BIS\_DATA\*** using the [Free\(\)](#) function.

## Description

This function must be the first BIS function invoked by an application. It passes back a [BIS APPLICATION HANDLE](#) value that must be used in subsequent BIS functions. The handle must be eventually destroyed by a call to the [Shutdown\(\)](#) function, thus ending that handle’s lifetime. After the handle is destroyed, BIS functions may no longer be called with that handle value. Thus all other BIS functions may only be called between a pair of [Initialize\(\)](#) and [Shutdown\(\)](#) functions.

There is no penalty for calling [Initialize\(\)](#) multiple times. Each call passes back a distinct handle value. Each distinct handle must be destroyed by a distinct call to [Shutdown\(\)](#). The lifetimes of handles created and destroyed with these functions may be overlapped in any way.

## Status Codes Returned

EFI_SUCCESS	The function completed successfully.
EFI_INCOMPATIBLE_VERSION	The <i>InterfaceVersion.Major</i> requested by the caller was not compatible with the interface version of the implementation. The <i>InterfaceVersion.Major</i> has been updated with the current interface version.
EFI_UNSUPPORTED	This is a local-platform implementation and <i>TargetAddress.Data</i> was not <b>NULL</b> , or <i>TargetAddress.Data</i> was any other value that was not supported by the implementation.
EFI_OUT_OF_RESOURCES	The function failed due to lack of memory or other resources.

EFI_DEVICE_ERROR	The function encountered an unexpected internal failure while initializing a cryptographic software module, or No cryptographic software module with compatible version was found, or A resource limitation was encountered while using a cryptographic software module.
EFI_INVALID_PARAMETER	The <i>This</i> parameter supplied by the caller is <b>NULL</b> or does not reference a valid <b>EEL_BIS_PROTOCOL</b> object, or The <i>AppHandle</i> parameter supplied by the caller is <b>NULL</b> or an invalid memory reference, or The <i>InterfaceVersion</i> parameter supplied by the caller is <b>NULL</b> or an invalid memory reference, or The <i>TargetAddress</i> parameter supplied by the caller is <b>NULL</b> or an invalid memory reference.

## EFI\_BIS\_PROTOCOL.Shutdown()

### Summary

Shuts down an application's instance of the BIS service, invalidating the application handle. After this call, other BIS functions may no longer be invoked using the application handle value.

### Prototype

```
typedef
EFI_STATUS
(EFIAPI *EFI_BIS_SHUTDOWN)(
    IN BIS_APPLICATION_HANDLE AppHandle
);
```

### Parameters

*AppHandle* An opaque handle that identifies the caller's instance of initialization of the BIS service. Type [BIS\\_APPLICATION\\_HANDLE](#) is defined in the [Initialize\(\)](#) function description.

### Description

This function shuts down an application's instance of the BIS service, invalidating the application handle. After this call, other BIS functions may no longer be invoked using the application handle value.

This function must be paired with a preceding successful call to the **Initialize()** function. The lifetime of an application handle extends from the time the handle was returned from **Initialize()** until the time the handle is passed to **Shutdown()**. If there are other remaining handles whose lifetime is still active, they may still be used in calling BIS functions.

The caller must free all memory resources associated with this *AppHandle* that were allocated and returned from other BIS functions before calling **Shutdown()**. Memory resources are freed using the [Free\(\)](#) function. Failure to free such memory resources is a caller error, however, this function does not return an error code under this circumstance. Further attempts to access the outstanding memory resources cause unspecified results.

### Status Codes Returned

EFI_SUCCESS	The function completed successfully.
EFI_NO_MAPPING	The <i>AppHandle</i> parameter is not or is no longer a valid application instance handle associated with the EFI_BIS protocol.
EFI_DEVICE_ERROR	The function encountered an unexpected internal error while returning resources associated with a cryptographic software module, or The function encountered an internal error while trying to shut down a cryptographic software module.
EFI_OUT_OF_RESOURCES	The function failed due to lack of memory or other resources.

## EFI\_BIS\_PROTOCOL.Free()

### Summary

Frees memory structures allocated and returned by other functions in the **EFI\_BIS** protocol.

### Prototype

```
typedef
EFI_STATUS
(EFIAPI *EFI_BIS_FREE)(
  IN BIS_APPLICATION_HANDLE AppHandle,
  IN EFI_BIS_DATA *ToFree
);
```

### Parameters

<i>AppHandle</i>	An opaque handle that identifies the caller's instance of initialization of the BIS service. Type <a href="#">BIS_APPLICATION_HANDLE</a> is defined in the <a href="#">Initialize()</a> function description.
<i>ToFree</i>	An <b>EFI_BIS_DATA*</b> and associated memory block to be freed. This <b>EFI_BIS_DATA*</b> must have been allocated by one of the other BIS functions. Type <a href="#">EFI_BIS_DATA</a> is defined in the <a href="#">Initialize()</a> function description.

### Description

This function deallocates an **EFI\_BIS\_DATA\*** and associated memory allocated by one of the other BIS functions.

Callers of other BIS functions that allocate memory in the form of an **EFI\_BIS\_DATA\*** must eventually call this function to deallocate the memory before calling the [Shutdown\(\)](#) function for the application handle under which the memory was allocated. Failure to do so causes unspecified results, and the continued correct operation of the BIS service cannot be guaranteed.

### Status Codes Returned

EFI_SUCCESS	The function completed successfully.
EFI_NO_MAPPING	The <i>AppHandle</i> parameter is not or is no longer a valid application instance handle associated with the EFI_BIS protocol.
EFI_INVALID_PARAMETER	The <i>ToFree</i> parameter is not or is no longer a memory resource associated with this <i>AppHandle</i> .
EFI_OUT_OF_RESOURCES	The function failed due to lack of memory or other resources.

## EFI\_BIS\_PROTOCOL.GetBootObjectAuthorizationCertificate()

### Summary

Retrieves the certificate that has been configured as the identity of the organization designated as the source of authorization for signatures of boot objects.

### Prototype

```
typedef
EFI_STATUS
(EFIAPI *EFI_BIS_GET_BOOT_OBJECT_AUTHORIZATION_CERTIFICATE)(
  IN BIS_APPLICATION_HANDLE AppHandle,
  OUT EFI_BIS_DATA    **Certificate
);
```

### Parameters

<i>AppHandle</i>	An opaque handle that identifies the caller's instance of initialization of the BIS service. Type <a href="#">BIS_APPLICATION_HANDLE</a> is defined in the <a href="#">Initialize()</a> function description.
<i>Certificate</i>	The function writes an allocated <b>EFI_BIS_DATA*</b> containing the Boot Object Authorization Certificate object. The caller must eventually free the memory allocated by this function using the function <a href="#">Free()</a> . Type <a href="#">EFI_BIS_DATA</a> is defined in the <a href="#">Initialize()</a> function description.

### Description

This function retrieves the certificate that has been configured as the identity of the organization designated as the source of authorization for signatures of boot objects.

### Status Codes Returned

EFI_SUCCESS	The function completed successfully.
EFI_NO_MAPPING	The <i>AppHandle</i> parameter is not or is no longer a valid application instance handle associated with the EFI_BIS protocol.
EFI_NOT_FOUND	There is no Boot Object Authorization Certificate currently installed.
EFI_OUT_OF_RESOURCES	The function failed due to lack of memory or other resources.
EFI_INVALID_PARAMETER	The <i>Certificate</i> parameter supplied by the caller is <b>NULL</b> or an invalid memory reference.

## EFI\_BIS\_PROTOCOL.GetBootObjectAuthorizationCheckFlag()

### Summary

Retrieves the current status of the Boot Authorization Check Flag.

### Prototype

```
typedef
EFI_STATUS
(EFIAPI *EFI_BIS_GET_BOOT_OBJECT_AUTHORIZATION_CHECKFLAG)(
  IN BIS_APPLICATION_HANDLE AppHandle,
  OUT BOOLEAN      *ChecksRequired
);
```

### Parameters

*AppHandle*

An opaque handle that identifies the caller's instance of initialization of the BIS service. Type [BIS\\_APPLICATION\\_HANDLE](#) is defined in the [Initialize\(\)](#) function description.

*ChecksRequired*

The function writes the value **TRUE** if a Boot Authorization Check is currently required on this platform, otherwise the function writes **FALSE**.

### Description

This function retrieves the current status of the Boot Authorization Check Flag (in other words, whether or not a Boot Authorization Check is currently required on this platform).

### Status Codes Returned

EFI_SUCCESS	The function completed successfully.
EFI_NO_MAPPING	The <i>AppHandle</i> parameter is not or is no longer a valid application instance handle associated with the EFI_BIS protocol.
EFI_OUT_OF_RESOURCES	The function failed due to lack of memory or other resources.
EFI_INVALID_PARAMETER	The <i>ChecksRequired</i> parameter supplied by the caller is <b>NULL</b> or an invalid memory reference.

## EFI\_BIS\_PROTOCOL.GetBootObjectAuthorizationUpdateToken()

### Summary

Retrieves a unique token value to be included in the request credential for the next update of any parameter in the Boot Object Authorization set (Boot Object Authorization Certificate and Boot Authorization Check Flag).

### Prototype

```
typedef
EFI_STATUS
(EFIAPI *EFI_BIS_GET_BOOT_OBJECT_AUTHORIZATION_UPDATE_TOKEN)(
  IN BIS_APPLICATION_HANDLE AppHandle,
  OUT EFI_BIS_DATA    **UpdateToken
);
```

### Parameters

*AppHandle*

An opaque handle that identifies the caller's instance of initialization of the BIS service. Type [BIS\\_APPLICATION\\_HANDLE](#) is defined in the [Initialize\(\)](#) function description.

*UpdateToken*

The function writes an allocated **EFI\_BIS\_DATA\*** containing the new unique update token value. The caller must eventually free the memory allocated by this function using the function [Free\(\)](#). Type [EFI\\_BIS\\_DATA](#) is defined in the [Initialize\(\)](#) function description.

### Description

This function retrieves a unique token value to be included in the request credential for the next update of any parameter in the Boot Object Authorization set (Boot Object Authorization Certificate and Boot Authorization Check Flag). The token value is unique to this platform, parameter set, and instance of parameter values. In particular, the token changes to a new unique value whenever any parameter in this set is changed.

### Status Codes Returned

EFI_SUCCESS	The function completed successfully.
EFI_NO_MAPPING	The <i>AppHandle</i> parameter is not or is no longer a valid application instance handle associated with the EFI_BIS protocol.
EFI_OUT_OF_RESOURCES	The function failed due to lack of memory or other resources.
EFI_DEVICE_ERROR	The function encountered an unexpected internal error in a cryptographic software module.
EFI_INVALID_PARAMETER	The <i>UpdateToken</i> parameter supplied by the caller is <b>NULL</b> or an invalid memory reference.



## EFI\_BIS\_PROTOCOL.GetSignatureInfo()

### Summary

Retrieves a list of digital certificate identifier, digital signature algorithm, hash algorithm, and key-length combinations that the platform supports.

### Prototype

```
typedef
EFI_STATUS
(EFI_API *EFI_BIS_GET_SIGNATURE_INFO)(
  IN BIS_APPLICATION_HANDLE AppHandle,
  OUT EFI_BIS_DATA **SignatureInfo
);
```

### Parameters

*AppHandle*

An opaque handle that identifies the caller's instance of initialization of the BIS service. Type [BIS\\_APPLICATION\\_HANDLE](#) is defined in the [Initialize\(\)](#) function description.

*SignatureInfo*

The function writes an allocated **EFI\_BIS\_DATA\*** containing the array of **EFI\_BIS\_SIGNATURE\_INFO** structures representing the supported digital certificate identifier, algorithm, and key length combinations. The caller must eventually free the memory allocated by this function using the function [Free\(\)](#). Type [EFI\\_BIS\\_DATA](#) is defined in the [Initialize\(\)](#) function description. Type **EFI\_BIS\_SIGNATURE\_INFO** is defined in "Related Definitions" below.

### Related Definitions

```
/*******
// EFI_BIS_SIGNATURE_INFO
//*****
typedef struct _EFI_BIS_SIGNATURE_INFO {
  BIS_CERT_ID CertificateID;
  BIS_ALG_ID AlgorithmID;
  UINT16 KeyLength;
} EFI_BIS_SIGNATURE_INFO;
```

*CertificateID*

A shortened value identifying the platform's currently configured Boot Object Authorization Certificate, if one is currently configured. The shortened value is derived from the certificate as defined in the Related Definition for **BIS\_CERT\_ID** below. If there is no certificate currently configured, the value is one of the reserved **BIS\_CERT\_ID\_XXX** values defined below. Type

**BIS\_CERT\_ID** and its predefined reserved values are defined in “Related Definitions” below.

*AlgorithmID*

A predefined constant representing a particular digital signature algorithm. Often this represents a combination of hash algorithm and encryption algorithm, however, it may also represent a standalone digital signature algorithm. Type **BIS\_ALG\_ID** and its permitted values are defined in “Related Definitions” below.

*KeyLength*

The length of the public key, in bits, supported by this digital signature algorithm.

This type defines a digital certificate, digital signature algorithm, and key-length combination that may be supported by the BIS implementation. This type is returned by **GetSignatureInfo()** to describe the combination(s) supported by the implementation.

```

//*****
// BIS_GET_SIGINFO_COUNT macro
// Tells how many EFI_BIS_SIGNATURE_INFO elements are contained
// in a EFI_BIS_DATA struct pointed to by the provided
// EFI_BIS_DATA*.
//*****
#define BIS_GET_SIGINFO_COUNT(BisDataPtr) \
  ((BisDataPtr)->Length/sizeof(EFI_BIS_SIGNATURE_INFO))

```

*BisDataPtr*

Supplies the pointer to the target **EFI\_BIS\_DATA** structure.

*(return value)*

The number of **EFI\_BIS\_SIGNATURE\_INFO** elements contained in the array.

This macro computes how many **EFI\_BIS\_SIGNATURE\_INFO** elements are contained in an **EFI\_BIS\_DATA** structure returned from **GetSignatureInfo()**. The number returned is the count of items in the list of supported digital certificate, digital signature algorithm, and key-length combinations.

```

//*****
// BIS_GET_SIGINFO_ARRAY macro
// Produces a EFI_BIS_SIGNATURE_INFO* from a given
// EFI_BIS_DATA*.
//*****
#define BIS_GET_SIGINFO_ARRAY(BisDataPtr) \
  ((EFI_BIS_SIGNATURE_INFO*)(BisDataPtr)->Data)

```

*BisDataPtr*

Supplies the pointer to the target **EFI\_BIS\_DATA** structure.

*(return value)*

The pointer to the **EFI\_BIS\_SIGNATURE\_INFO** array, cast as an **EFI\_BIS\_SIGNATURE\_INFO\***.

This macro returns a pointer to the **EFI\_BIS\_SIGNATURE\_INFO** array contained in an **EFI\_BIS\_DATA** structure returned from **GetSignatureInfo()** representing the list of supported digital certificate, digital signature algorithm, and key-length combinations.

```

//*****
// BIS_CERT_ID
//*****
typedef UINT32    BIS_CERT_ID;

```

This type represents a shortened value that identifies the platform's currently configured Boot Object Authorization Certificate. The value is the first four bytes, in "little-endian" order, of the SHA-1 hash of the certificate, except that the most-significant bits of the second and third bytes are reserved, and must be set to zero regardless of the outcome of the hash function. This type is included in the array of values returned from the *GetSignatureInfo()* function to indicate the required source of a signature for a boot object or a configuration update request. There are a few predefined reserved values with special meanings as described below.

```

//*****
// BIS_CERT_ID predefined values
// Currently defined values for EFI_BIS_SIGNATURE_INFO.
// CertificateId.
//*****
#define BIS_CERT_ID_DSA    BIS_ALG_DSA    //CSSM_ALGID_DSA
#define BIS_CERT_ID_RSA_MD5    BIS_ALG_RSA_MD5 //
CSSM_ALGID_MD5_WITH_RSA

```

These C preprocessor symbols provide values for the **BIS\_CERT\_ID** type. These values are used when the platform has no configured Boot Object Authorization Certificate. They indicate the signature algorithm that is supported by the platform. Users must be careful to avoid constructing Boot Object Authorization Certificates that transform to **BIS\_CERT\_ID** values that collide with these predefined values or with the **BIS\_CERT\_ID** values of other Boot Object Authorization Certificates they use.

```

//*****
// BIS_CERT_ID_MASK
// The following is a mask value that gets applied to the
// truncated hash of a platform Boot Object Authorization
// Certificate to create the CertificateId. A CertificateId
// must not have any bits set to the value 1 other than bits in
// this mask.
//*****
#define BIS_CERT_ID_MASK    (0xFF7F7FFF)

```

This C preprocessor symbol may be used as a bit-wise "AND" value to transform the first four bytes (in little-endian order) of a SHA-1 hash of a certificate into a certificate ID with the "reserved" bits properly set to zero.

```

//*****
// BIS_ALG_ID
//*****
typedef UINT16    BIS_ALG_ID;

```

This type represents a digital signature algorithm. A digital signature algorithm is often composed of a particular combination of secure hash algorithm and encryption algorithm. This type also allows for digital signature algorithms that cannot be decomposed. Predefined values for this type are as defined below.

```

//*****
// BIS_ALG_ID predefined values
// Currently defined values for EFI_BIS_SIGNATURE_INFO.
// AlgorithmID. The exact numeric values come from "Common
// Data Security Architecture (CDSA) Specification."
//*****
#define BIS_ALG_DSA (41) //CSSM_ALGID_DSA
#define BIS_ALG_RSA_MD5 (42) //CSSM_ALGID_MD5_WITH_RSA

```

These values represent the two digital signature algorithms predefined for BIS. Each implementation of BIS must support at least one of these digital signature algorithms. Values for the digital signature algorithms are chosen by an industry group known as The Open Group. Developers planning to support additional digital signature algorithms or define new digital signature algorithms should refer to The Open Group for interoperable values to use.

## Description

This function retrieves a list of digital certificate identifier, digital signature algorithm, hash algorithm, and key-length combinations that the platform supports. The list is an array of (certificate id, algorithm id, key length) triples, where the certificate id is derived from the platform's Boot Object Authorization Certificate as described in the Related Definition for **BIS\_CERT\_ID** above, the algorithm id represents the combination of signature algorithm and hash algorithm, and the key length is expressed in bits. The number of array elements can be computed using the *Length* field of the retrieved **EFI\_BIS\_DATA\***.

The retrieved list is in order of preference. A digital signature algorithm for which the platform has a currently configured Boot Object Authorization Certificate is preferred over any digital signature algorithm for which there is not a currently configured Boot Object Authorization Certificate. Thus the first element in the list has a *CertificateID* representing a Boot Object Authorization Certificate if the platform has one configured. Otherwise the *CertificateID* of the first element in the list is one of the reserved values representing a digital signature algorithm.

## Status Codes Returned

EFI_SUCCESS	The function completed successfully.
-------------	--------------------------------------

EFI_NO_MAPPING	The <i>AppHandle</i> parameter is not or is no longer a valid application instance handle associated with the EFI_BIS protocol.
EFI_OUT_OF_RESOURCES	The function failed due to lack of memory or other resources.
EFI_DEVICE_ERROR	The function encountered an unexpected internal error in a cryptographic software module, or The function encountered an unexpected internal consistency check failure (possible corruption of stored Boot Object Authorization Certificate).
EFI_INVALID_PARAMETER	The <i>SignatureInfo</i> parameter supplied by the caller is <b>NULL</b> or an invalid memory reference.

## EFI\_BIS\_PROTOCOL.UpdateBootObjectAuthorization()

### Summary

Updates one of the configurable parameters of the Boot Object Authorization set (Boot Object Authorization Certificate or Boot Authorization Check Flag).

### Prototype

```
typedef
EFI_STATUS
(EFIAPI *EFI_BIS_UPDATE_BOOT_OBJECT_AUTHORIZATION)(
    IN BIS_APPLICATION_HANDLE AppHandle,
    IN EFI_BIS_DATA *RequestCredential,
    OUT EFI_BIS_DATA **NewUpdateToken
);
```

### Parameters

*AppHandle*

An opaque handle that identifies the caller's instance of initialization of the BIS service. Type [BIS\\_APPLICATION\\_HANDLE](#) is defined in the [Initialize\(\)](#) function description.

*RequestCredential*

This is a Signed Manifest with embedded attributes that carry the details of the requested update. The required syntax of the Signed Manifest is described in the Related Definition for Manifest Syntax below. The key used to sign the request credential must be the private key corresponding to the public key in the platform's configured Boot Object Authorization Certificate. Authority to update parameters in the Boot Object Authorization set cannot be delegated.

If there is no Boot Object Authorization Certificate, the request credential may be signed with any private key. In this case, this function interacts with the user in a platform-specific way to determine whether the operation should succeed. Type [EFI\\_BIS\\_DATA](#) is defined in the [Initialize\(\)](#) function description.

*NewUpdateToken*

The function writes an allocated [EFI\\_BIS\\_DATA\\*](#) containing the new unique update token value. The caller must eventually free the memory allocated by this function using the function [Free\(\)](#). Type [EFI\\_BIS\\_DATA](#) is defined in the [Initialize\(\)](#) function description.

## Related Definitions

```
//*****
// Manifest Syntax
```

```
//*****
```

The Signed Manifest consists of three parts grouped together into an Electronic Shrink Wrap archive as described in [SM spec]: a manifest file, a signer's information file, and a signature block file. These three parts, along with examples are described in the following sections. In these examples, text in parentheses is a description of the text that would appear in the signed manifest. Text outside of parentheses must appear exactly as shown. Also note that manifest files and signer's information files must conform to a 72-byte line-length limit. Continuation lines (lines beginning with a single "space" character) are used for lines longer than 72 bytes. The examples given here follow this rule for continuation lines.

Note that the manifest file and signer's information file parts of a Signed Manifest are ASCII text files. In cases where these files contain a base-64 encoded string, the string is an ASCII string before base-64 encoding.

```
//*****
// Manifest File Example
//*****
```

The manifest file must include a section referring to a memory-type data object with the reserved name as shown in the example below. This data object is a zero-length object whose sole purpose in the manifest is to serve as a named collection point for the attributes that carry the details of the requested update. The attributes are also contained in the manifest file. An example manifest file is shown below.

```
Manifest-Version: 2.0
ManifestPersistentId: (base-64 representation of a unique GUID)

Name: memory:UpdateRequestParameters
Digest-Algorithms: SHA-1
SHA-1-Digest: (base-64 representation of a SHA-1 digest of zero-length
buffer)
X-Intel-BIS-ParameterSet: (base-64 representation of
BootObjectAuthorizationSetGUID)
X-Intel-BIS-ParameterSetToken: (base-64 representation of the current
update token)
X-Intel-BIS-ParameterId: (base-64 representation of
"BootObjectAuthorizationCertificate" or
"BootAuthorizationCheckFlag")
X-Intel-BIS-ParameterValue: (base-64 representation of
certificate or
single-byte boolean flag)
```

A line-by-line description of this manifest file is as follows.

```
Manifest-Version: 2.0
```

This is a standard header line that all signed manifests have. It must appear exactly as shown.

**ManifestPersistentId:** (base-64 representation of a unique GUID)

The left-hand string must appear exactly as shown. The right-hand string must be a unique GUID for every manifest file created. The Win32 function `UuidCreate()` can be used for this on Win32 systems. The GUID is a binary value that must be base-64 encoded. Base-64 is a simple encoding scheme for representing binary values that uses only printing characters. Base-64 encoding is described in [BASE-64].

**Name:** `memory:UpdateRequestParameters`

This identifies the manifest section that carries a dummy zero-length data object serving as the collection point for the attribute values appearing later in this manifest section (lines prefixed with "**X-Intel-BIS-**"). The string "**memory:UpdateRequestParameters**" must appear exactly as shown.

**Digest-Algorithms:** `SHA-1`

This enumerates the digest algorithms for which integrity data is included for the data object. These are required even though the data object is zero-length. For systems with DSA signing, SHA-1 hash, and 1024-bit key length, the digest algorithm must be "**SHA-1**." For systems with RSA signing, MD5 hash, and 512-bit key length, the digest algorithm must be "**MD5**." Multiple algorithms can be specified as a whitespace-separated list. For every digest algorithm **XXX** listed, there must also be a corresponding **XXX-Digest** line.

**SHA-1-Digest:** (base-64 representation of a SHA-1 digest of zero-length buffer)

Gives the corresponding digest value for the dummy zero-length data object. The value is base-64 encoded. Note that for both MD5 and SHA-1, the digest value for a zero-length data object is not zero.

**X-Intel-BIS-ParameterSet:** (base-64 representation of `BootObjectAuthorizationSetGUID`)

A named attribute value that distinguishes updates of BIS parameters from updates of other parameters. The left-hand attribute-name keyword must appear exactly as shown. The GUID value for the right-hand side is always the same, and can be found under the preprocessor symbol **BOOT\_OBJECT\_AUTHORIZATION\_PARMSET\_GUIDVALUE**. The representation inserted into the manifest is base-64 encoded.

Note the "**X-Intel-BIS-**" prefix on this and the following attributes. The "**X-**" part of the prefix was chosen to avoid collisions with future reserved keywords defined by future versions of the signed manifest specification. The "**Intel-BIS-**" part of the prefix was chosen to avoid collisions with other user-defined attribute names within the user-defined attribute name space.

**X-Intel-BIS-ParameterSetToken:** (base-64 representation of the current update token)

A named attribute value that makes this update of BIS parameters different from any other on the same target platform. The left-hand attribute-name keyword must appear exactly as shown. The value for the right-hand side is generally different for each update-request manifest generated. The value to be base-64 encoded is retrieved through the functions [GetBootObjectAuthorizationUpdateToken\(\)](#) or [UpdateBootObjectAuthorization\(\)](#).



X-Intel-BIS-ParameterId: (base-64 representation of  
 "BootObjectAuthorizationCertificate" or  
 "BootAuthorizationCheckFlag")

A named attribute value that indicates which BIS parameter is to be updated. The left-hand attribute-name keyword must appear exactly as shown. The value for the right-hand side is the base-64 encoded representation of one of the two strings shown.

X-Intel-BIS-ParameterValue: (base-64 representation of  
 certificate or  
 single-byte boolean flag)

A named attribute value that indicates the new value to be set for the indicated parameter. The left-hand attribute-name keyword must appear exactly as shown. The value for the right-hand side is the appropriate base-64 encoded new value to be set. In the case of the Boot Object Authorization Certificate, the value is the new digital certificate raw data. A zero-length value removes the certificate altogether. In the case of the Boot Authorization Check Flag, the value is a single-byte Boolean value, where a nonzero value "turns on" the check and a zero value "turns off" the check.

```
//*****
// Signer's Information File Example
//*****
```

The signer's information file must include a section whose name matches the reserved data object section name of the section in the Manifest file. This section in the signer's information file carries the integrity data for the attributes in the corresponding section in the manifest file. An example signer's information file is shown below.

```
Signature-Version: 2.0
SignerInformationPersistentId: (base-64 representation of a unique
GUID)
SignerInformationName: BIS_UpdateManifestSignerInfoName

Name: memory:UpdateRequestParameters
Digest-Algorithms: SHA-1
SHA-1-Digest: (base-64 representation of a SHA-1 digest of the
corresponding manifest section)
```

A line-by-line description of this signer's information file is as follows.

```
Signature-Version: 2.0
```

This is a standard header line that all signed manifests have. It must appear exactly as shown.

```
SignerInformationPersistentId: (base-64 representation of a unique
GUID)
```

The left-hand string must appear exactly as shown. The right-hand string must be a unique GUID for every signer's information file created. The Win32 function UuidCreate() can be used for this on Win32 systems. The GUID is a binary value that must be base-64 encoded. Base-64 is a simple encoding scheme for representing binary values that uses only printing characters. Base-64 encoding is described in [BASE-64].

```
SignerInformationName: BIS_UpdateManifestSignerInfoName
```

The left-hand string must appear exactly as shown. The right-hand string must appear exactly as shown.

```
Name: memory:UpdateRequestParameters
```

This identifies the section in the signer's information file corresponding to the section with the same name in the manifest file described earlier. The string "**memory:UpdateRequestParameters**" must appear exactly as shown.

Digest-Algorithms: SHA-1

This enumerates the digest algorithms for which integrity data is included for the corresponding manifest section. Strings identifying digest algorithms are the same as in the manifest file. The digest algorithms specified here must match those specified in the manifest file. For every digest algorithm **XXX** listed, there must also be a corresponding **XXX-Digest** line.

SHA-1-Digest: (base-64 representation of a SHA-1 digest of the corresponding manifest section)

Gives the corresponding digest value for the corresponding manifest section. The value is base-64 encoded. Note that for the purpose of computing the hash of the manifest section, the manifest section starts at the beginning of the opening "**Name:**" keyword and continues up to, but not including, the next section's "**Name:**" keyword or the end-of-file. Thus the hash includes the blank line(s) at the end of a section and any newline(s) preceding the next "**Name:**" keyword or end-of-file.

```
//*****
// Signature Block File Example
//*****
```

A signature block file is a raw binary file (not base-64 encoded) that is a PKCS#7 defined format signature block. The signature block covers exactly the contents of the signer's information file. There must be a correspondence between the name of the signer's information file and the signature block file. The base name matches, and the three-character extension is modified to reflect the signature algorithm used according to the following rules:

- DSA signature algorithm (which uses SHA-1 hash): extension is DSA.
- RSA signature algorithm with MD5 hash: extension is RSA.

So for example with a signer's information file name of "myinfo.SF," the corresponding DSA signature block file name would be "myinfo.DSA."

The format of a signature block file is defined in [PKCS].

```
//*****
// "X-Intel-BIS-ParameterSet" Attribute value
// Binary Value of "X-Intel-BIS-ParameterSet" Attribute.
// (Value is Base-64 encoded in actual signed manifest).
//*****

#define BOOT_OBJECT_AUTHORIZATION_PARMSET_GUID \
{0xedd35e31,0x7b9,0x11d2,{0x83,0xa3,0x0,0xa0,0xc9,0x1f,0xad,0xcf}}
```

This preprocessor symbol gives the value for an attribute inserted in signed manifests to distinguish updates of BIS parameters from updates of other parameters. The representation inserted into the manifest is base-64 encoded.

## Description

This function updates one of the configurable parameters of the Boot Object Authorization set (Boot Object Authorization Certificate or Boot Authorization Check Flag). It passes back a new unique update token that must be included in the request credential for the next update of any parameter in the Boot Object Authorization set. The token value is unique to this platform, parameter set, and instance of parameter values. In particular, the token changes to a new unique value whenever any parameter in this set is changed.

## Status Codes Returned

EFI_SUCCESS	The function completed successfully.
EFI_NO_MAPPING	The <i>AppHandle</i> parameter is not or is no longer a valid application instance handle associated with the EFI_BIS protocol.
EFI_OUT_OF_RESOURCES	The function failed due to lack of memory or other resources.
EFI_DEVICE_ERROR	The function encountered an unexpected internal error in a cryptographic software module.
EFI_SECURITY_VIOLATION	<p>The signed manifest supplied as the <i>RequestCredential</i> parameter was invalid (could not be parsed),</p> <p>or</p> <p>The signed manifest supplied as the <i>RequestCredential</i> parameter failed to verify using the installed Boot Object Authorization Certificate or the signer's Certificate in <i>RequestCredential</i>,</p> <p>or</p> <p>Platform-specific authorization failed,</p> <p>or</p> <p>The signed manifest supplied as the <i>RequestCredential</i> parameter did not include the <b>X-Intel-BIS-ParameterSet</b> attribute value,</p> <p>or</p> <p>The <b>X-Intel-BIS-ParameterSet</b> attribute value supplied did not match the required GUID value,</p> <p>or</p> <p>The signed manifest supplied as the <i>RequestCredential</i> parameter did not include the <b>X-Intel-BIS-ParameterSetToken</b> attribute value,</p> <p>or</p> <p>The <b>X-Intel-BIS-ParameterSetToken</b> attribute value supplied did not match the platform's current update-token value,</p> <p>or</p>

EFI_SECURITY_VIOLATION	<p>The signed manifest supplied as the <i>RequestCredential</i> parameter did not include the <b>X-Intel-BIS-ParameterId</b> attribute value,  or  The <b>X-Intel-BIS-ParameterId</b> attribute value supplied did not match one of the permitted values,  or</p> <p>The signed manifest supplied as the <i>RequestCredential</i> parameter did not include the <b>X-Intel-BIS-ParameterValue</b> attribute value,  or  Any other required attribute value was missing,  or  The new certificate supplied was too big to store,  or  The new certificate supplied was invalid (could not be parsed),  or  The new certificate supplied had an unsupported combination of key algorithm and key length,  or  The new check flag value supplied is the wrong length (1 byte),  or</p> <p>The signed manifest supplied as the <i>RequestCredential</i> parameter did not include a signer certificate,  or  The signed manifest supplied as the <i>RequestCredential</i> parameter did not include the manifest section named <b>"memory:UpdateRequestParameters,"</b>  or</p>
------------------------	---

EFI_SECURITY_VIOLATION	<p>The signed manifest supplied as the <i>RequestCredential</i> parameter had a signing certificate with an unsupported public-key algorithm,</p> <p>or</p> <p>The manifest section named "<b>memory:UpdateRequestParameters</b>" did not include a digest with a digest algorithm corresponding to the signing certificate's public key algorithm,</p> <p>or</p> <p>The zero-length data object referenced by the manifest section named "<b>memory:UpdateRequestParameters</b>" did not verify with the digest supplied in that manifest section,</p> <p>or</p> <p>The signed manifest supplied as the <i>RequestCredential</i> parameter did not include a signer's information file with the <b>SignerInformationName</b> identifying attribute value "<b>BIS_UpdateManifestSignerInfoName</b>,"</p> <p>or</p> <p>There were no signers associated with the identified signer's information file,</p> <p>or</p> <p>There was more than one signer associated with the identified signer's information file,</p> <p>or</p> <p>Any other unspecified security violation occurred.</p>
EFI_DEVICE_ERROR	<p>An unexpected internal error occurred while analyzing the new certificate's key algorithm,</p> <p>or</p> <p>An unexpected internal error occurred while attempting to retrieve the public key algorithm of the manifest's signer's certificate,</p> <p>or</p> <p>An unexpected internal error occurred in a cryptographic software module.</p>
EFI_INVALID_PARAMETER	<p>The <i>RequestCredential</i> parameter supplied by the caller is <b>NULL</b> or an invalid memory reference,</p> <p>or</p> <p>The <i>RequestCredential.Data</i> parameter supplied by the caller is <b>NULL</b> or an invalid memory reference,</p> <p>or</p> <p>The <i>NewUpdateToken</i> parameter supplied by the caller is <b>NULL</b> or an invalid memory reference.</p>

## EFI\_BIS\_PROTOCOL.VerifyBootObject()

### Summary

Verifies the integrity and authorization of the indicated data object according to the indicated credentials.

### Prototype

```
typedef
EFI_STATUS
(EFIAPI *EFI_BIS_VERIFY_BOOT_OBJECT)(
  IN BIS_APPLICATION_HANDLE AppHandle,
  IN EFI_BIS_DATA *Credentials,
  IN EFI_BIS_DATA *DataObject,
  OUT BOOLEAN *IsVerified
);
```

### Parameters

<i>AppHandle</i>	An opaque handle that identifies the caller's instance of initialization of the BIS service. Type <a href="#">BIS_APPLICATION_HANDLE</a> is defined in the <a href="#">Initialize()</a> function description.
<i>Credentials</i>	A Signed Manifest containing verification information for the indicated data object. The Manifest signature itself must meet the requirements described below. This parameter is optional if a Boot Authorization Check is currently not required on this platform ( <i>Credentials.Data</i> may be <b>NULL</b> ), otherwise this parameter is required. The required syntax of the Signed Manifest is described in the Related Definition for Manifest Syntax below. Type <a href="#">EFI_BIS_DATA</a> is defined in the <a href="#">Initialize()</a> function description.
<i>DataObject</i>	An in-memory copy of the raw data object to be verified. Type <a href="#">EFI_BIS_DATA</a> is defined in the <a href="#">Initialize()</a> function description.
<i>IsVerified</i>	The function writes <b>TRUE</b> if the verification succeeded, otherwise <b>FALSE</b> .

### Related Definitions

```
//*****
// Manifest Syntax
//*****
```

The Signed Manifest consists of three parts grouped together into an Electronic Shrink Wrap archive as described in [SM spec]: a manifest file, a signer's information file, and a signature block file. These three parts along with examples are described in the following sections. In these examples, text in parentheses is a description of the text that would appear in the signed manifest. Text outside of parentheses must appear exactly as shown.

Also note that manifest files and signer's information files must conform to a 72-byte line-length limit. Continuation lines (lines beginning with a single "space" character) are used for lines longer than 72 bytes. The examples given here follow this rule for continuation lines.

Note that the manifest file and signer's information file parts of a Signed Manifest are ASCII text files. In cases where these files contain a base-64 encoded string, the string is an ASCII string before base-64 encoding.

```
//*****
// Manifest File Example
//*****
```

The manifest file must include a section referring to a memory-type data object with the reserved name as shown in the example below. This data object is the Boot Object to be verified. An example manifest file is shown below.

```
Manifest-Version: 2.0
ManifestPersistentId: (base-64 representation of a unique GUID)

Name: memory:BootObject
Digest-Algorithms: SHA-1
SHA-1-Digest: (base-64 representation of a SHA-1 digest of the
boot object)
```

A line-by-line description of this manifest file is as follows.

```
Manifest-Version: 2.0
```

This is a standard header line that all signed manifests have. It must appear exactly as shown.

```
ManifestPersistentId: (base-64 representation of a unique GUID)
```

The left-hand string must appear exactly as shown. The right-hand string must be a unique GUID for every manifest file created. The Win32 function `UuidCreate()` can be used for this on Win32 systems. The GUID is a binary value that must be base-64 encoded. Base-64 is a simple encoding scheme for representing binary values that uses only printing characters. Base-64 encoding is described in [BASE-64].

```
Name: memory:BootObject
```

This identifies the section that carries the integrity data for the Boot Object. The string "**memory:BootObject**" must appear exactly as shown. Note that the Boot Object cannot be found directly from this manifest. A caller verifying the Boot Object integrity must load the Boot Object into memory and specify its memory location explicitly to this verification function through the *DataObject* parameter.

```
Digest-Algorithms: SHA-1
```

This enumerates the digest algorithms for which integrity data is included for the data object. For systems with DSA signing, SHA-1 hash, and 1024-bit key length, the digest algorithm must be "**SHA-1**." For systems with RSA signing, MD5 hash, and 512-bit key length, the digest algorithm must be "**MD5**." Multiple algorithms can be specified as a whitespace-separated list. For every digest algorithm **XXX** listed, there must also be a corresponding **XXX-Digest** line.

```
SHA-1-Digest: (base-64 representation of a SHA-1 digest of the boot object)
```

Gives the corresponding digest value for the data object. The value is base-64 encoded.

```

//*****
// Signer's Information File Example
//*****

```

The signer's information file must include a section whose name matches the reserved data object section name of the section in the Manifest file. This section in the signer's information file carries the integrity data for the corresponding section in the manifest file. An example signer's information file is shown below.

```

Signature-Version: 2.0
SignerInformationPersistentId: (base-64 representation of a
unique GUID)
SignerInformationName: BIS_VerifiableObjectSignerInfoName

Name: memory:BootObject
Digest-Algorithms: SHA-1
SHA-1-Digest: (base-64 representation of a SHA-1 digest of the
corresponding manifest section)

```

A line-by-line description of this signer's information file is as follows.

```
Signature-Version: 2.0
```

This is a standard header line that all signed manifests have. It must appear exactly as shown.

```
SignerInformationPersistentId: (base-64 representation of a unique GUID)
```

The left-hand string must appear exactly as shown. The right-hand string must be a unique GUID for every signer's information file created. The Win32 function `UuidCreate()` can be used for this on Win32 systems. The GUID is a binary value that must be base-64 encoded. Base-64 is a simple encoding scheme for representing binary values that uses only printing characters. Base-64 encoding is described in [BASE-64].

```
SignerInformationName: BIS_VerifiableObjectSignerInfoName
```

The left-hand string must appear exactly as shown. The right-hand string must appear exactly as shown.

```
Name: memory:BootObject
```

This identifies the section in the signer's information file corresponding to the section with the same name in the manifest file described earlier. The string "**memory:BootObject**" must appear exactly as shown.

```
Digest-Algorithms: SHA-1
```

This enumerates the digest algorithms for which integrity data is included for the corresponding manifest section. Strings identifying digest algorithms are the same as in the manifest file. The digest algorithms specified here must match those specified in the manifest file. For every digest algorithm **XXX** listed, there must also be a corresponding **XXX-Digest** line.

```
SHA-1-Digest: (base-64 representation of a SHA-1 digest of the
corresponding manifest section)
```

Gives the corresponding digest value for the corresponding manifest section. The value is base-64 encoded. Note that for the purpose of computing the hash of the manifest section, the manifest section starts at the beginning of the opening "**Name:**" keyword and continues up to, but not including, the next section's "**Name:**" keyword or the end-of-file.



Thus the hash includes the blank line(s) at the end of a section and any newline(s) preceding the next “Name:” keyword or end-of-file.

```
//*****
// Signature Block File Example
//*****
```

A signature block file is a raw binary file (not base-64 encoded) that is a PKCS#7 defined format signature block. The signature block covers exactly the contents of the signer’s information file. There must be a correspondence between the name of the signer’s information file and the signature block file. The base name matches, and the three-character extension is modified to reflect the signature algorithm used according to the following rules:

- DSA signature algorithm (which uses SHA-1 hash): extension is DSA.
- RSA signature algorithm with MD5 hash: extension is RSA.

So for example with a signer’s information file name of “myinfo.SF,” the corresponding DSA signature block file name would be “myinfo.DSA.”

The format of a signature block file is defined in [PKCS].

## Description

This function verifies the integrity and authorization of the indicated data object according to the indicated credentials. The rules for successful verification depend on whether or not a Boot Authorization Check is currently required on this platform.

If a Boot Authorization Check is *not* currently required on this platform, no authorization check is performed. However, the following rules are applied for an integrity check:

- In this case, the credentials are optional. If they are *not* supplied (*Credentials.Data* is **NULL**), no integrity check is performed, and the function returns immediately with a “success” indication and *IsVerified* is **TRUE**.
- If the credentials *are* supplied (*Credentials.Data* is other than **NULL**), integrity checks are performed as follows:
  - Verify the credentials – The credentials parameter is a valid signed Manifest, with a single signer. The signer’s identity is included in the credential as a certificate.
  - Verify the data object – The Manifest must contain a section named “**memory:BootObject**,” with associated verification information (in other words, hash value). The hash value from this Manifest section must match the hash value computed over the specified *DataObject* data.
  - If these checks succeed, the function returns with a “success” indication and *IsVerified* is **TRUE**. Otherwise, *IsVerified* is **FALSE** and the function returns with a “security violation” indication.

If a Boot Authorization Check *is* currently required on this platform, authorization and integrity checks are performed. The integrity check is the same as in the case above, except that it is required. The following rules are applied:

- Verify the credentials – The credentials parameter is required in this case (*Credentials.Data* must be other than **NULL**). The credentials parameter is a valid Signed Manifest, with a single signer. The signer’s identity is included in the credential as a certificate.

- Verify the data object – The Manifest must contain a section named “**memory:BootObject**,” with associated verification information (in other words, hash value). The hash value from this Manifest section must match the hash value computed over the specified *DataObject* data.
- Do Authorization check – This happens one of two ways depending on whether or not the platform currently has a Boot Object Authorization Certificate configured.
  - If a Boot Object Authorization Certificate is not currently configured, this function interacts with the user in a platform-specific way to determine whether the operation should succeed.
  - If a Boot Object Authorization Certificate *is* currently configured, this function uses the Boot Object Authorization Certificate to determine whether the operation should succeed. The public key certified by the signer’s certificate must match the public key in the Boot Object Authorization Certificate configured for this platform. The match must be direct, that is, the signature authority cannot be delegated along a certificate chain.
  - If these checks succeed, the function returns with a “success” indication and *IsVerified* is **TRUE**. Otherwise, *IsVerified* is **FALSE** and the function returns with a “security violation” indication.

Note that if a Boot Authorization Check is currently required on this platform this function *always* performs an authorization check, either through platform-specific user interaction or through a signature generated with the private key corresponding to the public key in the platform’s Boot Object Authorization Certificate.

## Status Codes Returned

EFI_SUCCESS	The function completed successfully.
EFI_NO_MAPPING	The <i>AppHandle</i> parameter is not or is no longer a valid application instance handle associated with the EFI_BIS protocol.
EFI_INVALID_PARAMETER	<p>The <i>Credentials</i> parameter supplied by the caller is <b>NULL</b> or an invalid memory reference,</p> <p>or</p> <p>The Boot Authorization Check is currently required on this platform and the <i>Credentials.Data</i> parameter supplied by the caller is <b>NULL</b> or an invalid memory reference,</p> <p>or</p> <p>The <i>DataObject</i> parameter supplied by the caller is <b>NULL</b> or an invalid memory reference,</p> <p>or</p> <p>The <i>DataObject.Data</i> parameter supplied by the caller is <b>NULL</b> or an invalid memory reference,</p> <p>or</p> <p>The <i>IsVerified</i> parameter supplied by the caller is <b>NULL</b> or an invalid memory reference.</p>
EFI_OUT_OF_RESOURCES	The function failed due to lack of memory or other resources.

EFI_SECURITY_VIOLATION	The signed manifest supplied as the <i>Credentials</i> parameter was invalid (could not be parsed), or The signed manifest supplied as the <i>Credentials</i> parameter failed to verify using the installed Boot Object Authorization Certificate or the signer's Certificate in <i>Credentials</i> , or Platform-specific authorization failed, or Any other required attribute value was missing, or The signed manifest supplied as the <i>Credentials</i> parameter did not include a signer certificate, or
------------------------	--

EFI_SECURITY_VIOLATION	<p>The signed manifest supplied as the <i>Credentials</i> parameter did not include the manifest section named <b>"memory:BootObject,"</b></p> <p>or</p> <p>The signed manifest supplied as the <i>Credentials</i> parameter had a signing certificate with an unsupported public-key algorithm,</p> <p>or</p> <p>The manifest section named <b>"memory:BootObject"</b> did not include a digest with a digest algorithm corresponding to the signing certificate's public key algorithm,</p> <p>or</p> <p>The data object supplied as the <i>DataObject</i> parameter and referenced by the manifest section named <b>"memory:BootObject"</b> did not verify with the digest supplied in that manifest section,</p> <p>or</p> <p>The signed manifest supplied as the <i>Credentials</i> parameter did not include a signer's information file with the <b>SignerInformationName</b> identifying attribute value <b>"BIS_VerifiableObjectSignerInfoName,"</b></p> <p>or</p> <p>There were no signers associated with the identified signer's information file,</p> <p>or</p> <p>There was more than one signer associated with the identified signer's information file,</p> <p>or</p> <p>The platform's check flag is "on" (requiring authorization checks) but the <i>Credentials.Data</i> supplied by the caller is <b>NULL</b>,</p> <p>or</p> <p>Any other unspecified security violation occurred.</p>
------------------------	---

EFI_DEVICE_ERROR	An unexpected internal error occurred while attempting to retrieve the public key algorithm of the manifest's signer's certificate, or An unexpected internal error occurred in a cryptographic software module.
------------------	--

## EFI\_BIS\_PROTOCOL.VerifyObjectWithCredential()

### Summary

Verifies the integrity and authorization of the indicated data object according to the indicated credentials and authority certificate.

### Prototype

```
typedef
EFI_STATUS
(EFIAPI *EFI_BIS_VERIFY_OBJECT_WITH_CREDENTIAL)(
  IN BIS_APPLICATION_HANDLE AppHandle,
  IN EFI_BIS_DATA *Credentials,
  IN EFI_BIS_DATA *DataObject,
  IN EFI_BIS_DATA *SectionName,
  IN EFI_BIS_DATA *AuthorityCertificate,
  OUT BOOLEAN *IsVerified
);
```

### Parameters

<i>AppHandle</i>	An opaque handle that identifies the caller's instance of initialization of the BIS service. Type <a href="#">BIS_APPLICATION_HANDLE</a> is defined in the <a href="#">Initialize()</a> function description.
<i>Credentials</i>	A Signed Manifest containing verification information for the indicated data object. The Manifest signature itself must meet the requirements described below. The required syntax of the Signed Manifest is described in the Related Definition of Manifest Syntax below. Type <a href="#">EFI_BIS_DATA</a> is defined in the <a href="#">Initialize()</a> function description.
<i>DataObject</i>	An in-memory copy of the raw data object to be verified. Type <a href="#">EFI_BIS_DATA</a> is defined in the <a href="#">Initialize()</a> function description.
<i>SectionName</i>	An ASCII string giving the section name in the manifest holding the verification information (in other words, hash value) that corresponds to <i>DataObject</i> . Type <a href="#">EFI_BIS_DATA</a> is defined in the <a href="#">Initialize()</a> function description.
<i>AuthorityCertificate</i>	A digital certificate whose public key must match the signer's public key which is found in the credentials. This parameter is optional ( <i>AuthorityCertificate.Data</i> may be <a href="#">NULL</a> ). Type <a href="#">EFI_BIS_DATA</a> is defined in the <a href="#">Initialize()</a> function description.

*IsVerified*

The function writes **TRUE** if the verification was successful. Otherwise, the function writes **FALSE**.

## Related Definitions

```
//*****
// Manifest Syntax
//*****
```

The Signed Manifest consists of three parts grouped together into an Electronic Shrink Wrap archive as described in [SM spec]: a manifest file, a signer's information file, and a signature block file. These three parts along with examples are described in the following sections. In these examples, text in parentheses is a description of the text that would appear in the signed manifest. Text outside of parentheses must appear exactly as shown. Also note that manifest files and signer's information files must conform to a 72-byte line-length limit. Continuation lines (lines beginning with a single "space" character) are used for lines longer than 72 bytes. The examples given here follow this rule for continuation lines.

Note that the manifest file and signer's information file parts of a Signed Manifest are ASCII text files. In cases where these files contain a base-64 encoded string, the string is an ASCII string before base-64 encoding.

```
//*****
// Manifest File Example
//*****
```

The manifest file must include a section referring to a memory-type data object with the caller-chosen name as shown in the example below. This data object is the Data Object to be verified. An example manifest file is shown below.

```
Manifest-Version: 2.0
ManifestPersistentId: (base-64 representation of a unique GUID)

Name: (a memory-type data object name)
Digest-Algorithms: SHA-1
SHA-1-Digest: (base-64 representation of a SHA-1 digest of the
data object)
```

A line-by-line description of this manifest file is as follows.

```
Manifest-Version: 2.0
```

This is a standard header line that all signed manifests have. It must appear exactly as shown.

```
ManifestPersistentId: (base-64 representation of a unique GUID)
```

The left-hand string must appear exactly as shown. The right-hand string must be a unique GUID for every manifest file created. The Win32 function UuidCreate() can be used for this on Win32 systems. The GUID is a binary value that must be base-64 encoded. Base-64 is a simple encoding scheme for representing binary values that uses only printing characters. Base-64 encoding is described in [BASE-64].

```
Name: (a memory-type data object name)
```

This identifies the section that carries the integrity data for the target Data Object. The right-hand string must obey the syntax for memory-type references, that is, it is of the form “**memory:SomeUniqueName.**” The “**memory:**” part of this string must appear exactly. The “**SomeUniqueName**” part is chosen by the caller. It must be unique within the section names in this manifest file. The entire “**memory:SomeUniqueName**” string must match exactly the corresponding string in the signer’s information file described below. Furthermore, this entire string must match the value given for the *SectionName* parameter to this function. Note that the target Data Object cannot be found directly from this manifest. A caller verifying the Data Object integrity must load the Data Object into memory and specify its memory location explicitly to this verification function through the *DataObject* parameter.

Digest-Algorithms: SHA-1

This enumerates the digest algorithms for which integrity data is included for the data object. For systems with DSA signing, SHA-1 hash, and 1024-bit key length, the digest algorithm must be “**SHA-1.**” For systems with RSA signing, MD5 hash, and 512-bit key length, the digest algorithm must be “**MD5.**” Multiple algorithms can be specified as a whitespace-separated list. For every digest algorithm **XXX** listed, there must also be a corresponding **XXX-Digest** line.

SHA-1-Digest: (base-64 representation of a SHA-1 digest of the data object)

Gives the corresponding digest value for the data object. The value is base-64 encoded.

```
//*****
// Signer's Information File Example
//*****
```

The signer’s information file must include a section whose name matches the reserved data object section name of the section in the Manifest file. This section in the signer’s information file carries the integrity data for the corresponding section in the manifest file. An example signer’s information file is shown below.

```
Signature-Version: 2.0
SignerInformationPersistentId: (base-64 representation of a
unique GUID)
SignerInformationName: BIS_VerifiableObjectSignerInfoName

Name: (a memory-type data object name)
Digest-Algorithms: SHA-1
SHA-1-Digest: (base-64 representation of a SHA-1 digest of the
corresponding manifest section)
```

A line-by-line description of this signer’s information file is as follows.

Signature-Version: 2.0

This is a standard header line that all signed manifests have. It must appear exactly as shown.

SignerInformationPersistentId: (base-64 representation of a unique GUID)

The left-hand string must appear exactly as shown. The right-hand string must be a unique GUID for every signer’s information file created. The Win32 function UuidCreate() can be used for this on Win32 systems. The GUID is a binary value that must be base-64 encoded. Base-64 is a simple encoding scheme for representing binary values that uses only printing characters. Base-64 encoding is described in [BASE-64].



SignerInformationName: BIS\_VerifiableObjectSignerInfoName

The left-hand string must appear exactly as shown. The right-hand string must appear exactly as shown.

Name: (a memory-type data object name)

This identifies the section in the signer's information file corresponding to the section with the same name in the manifest file described earlier. The right-hand string must match exactly the corresponding string in the manifest file described above.

Digest-Algorithms: SHA-1

This enumerates the digest algorithms for which integrity data is included for the corresponding manifest section. Strings identifying digest algorithms are the same as in the manifest file. The digest algorithms specified here must match those specified in the manifest file. For every digest algorithm **XXX** listed, there must also be a corresponding **XXX-Digest** line.

SHA-1-Digest: (base-64 representation of a SHA-1 digest of the corresponding manifest section)

Gives the corresponding digest value for the corresponding manifest section. The value is base-64 encoded. Note that for the purpose of computing the hash of the manifest section, the manifest section starts at the beginning of the opening "**Name:**" keyword and continues up to, but not including, the next section's "**Name:**" keyword or the end-of-file. Thus the hash includes the blank line(s) at the end of a section and any newline(s) preceding the next "**Name:**" keyword or end-of-file.

```
//*****
// Signature Block File Example
//*****
```

A signature block file is a raw binary file (not base-64 encoded) that is a PKCS#7 defined format signature block. The signature block covers exactly the contents of the signer's information file. There must be a correspondence between the name of the signer's information file and the signature block file. The base name matches, and the three-character extension is modified to reflect the signature algorithm used according to the following rules:

- DSA signature algorithm (which uses SHA-1 hash): extension is DSA.
- RSA signature algorithm with MD5 hash: extension is RSA.

So for example with a signer's information file name of "myinfo.SF," the corresponding DSA signature block file name would be "myinfo.DSA."

The format of a signature block file is defined in [PKCS].

## Description

This function verifies the integrity and authorization of the indicated data object according to the indicated credentials and authority certificate.

Both an integrity check and an authorization check are performed. The rules for a successful integrity check are:

- Verify the credentials – The credentials parameter is a valid Signed Manifest, with a single signer. The signer's identity is included in the credential as a certificate.

- Verify the data object – The Manifest must contain a section with the name as specified by the *SectionName* parameter, with associated verification information (in other words, hash value). The hash value from this Manifest section must match the hash value computed over the data specified by the *DataObject* parameter of this function.

The authorization check is optional. It is performed only if the *AuthorityCertificate.Data* parameter is other than **NULL**. If it is other than **NULL**, the rules for a successful authorization check are:

- The *AuthorityCertificate* parameter is a valid digital certificate. There is no requirement regarding the signer (issuer) of this certificate.
- The public key certified by the signer's certificate must match the public key in the *AuthorityCertificate*. The match must be direct, that is, the signature authority cannot be delegated along a certificate chain.

If all of the integrity and authorization check rules are met, the function returns with a "success" indication and *IsVerified* is **TRUE**. Otherwise, it returns with a nonzero specific error code and *IsVerified* is **FALSE**.

## Status Codes Returned

EFI_SUCCESS	The function completed successfully.
EFI_NO_MAPPING	The <i>AppHandle</i> parameter is not or is no longer a valid application instance handle associated with the EFI_BIS protocol.
EFI_INVALID_PARAMETER	<p>The <i>Credentials</i> parameter supplied by the caller is <b>NULL</b> or an invalid memory reference,</p> <p>or</p> <p>The <i>Credentials.Data</i> parameter supplied by the caller is <b>NULL</b> or an invalid memory reference,</p> <p>or</p> <p>The <i>Credentials.Length</i> supplied by the caller is zero,</p> <p>or</p> <p>The <i>DataObject</i> parameter supplied by the caller is <b>NULL</b> or an invalid memory reference,</p> <p>or</p> <p>The <i>DataObject.Data</i> parameter supplied by the caller is <b>NULL</b> or an invalid memory reference,</p> <p>or</p>

EFI_INVALID_PARAMETER	<p>The <i>SectionName</i> parameter supplied by the caller is <b>NULL</b> or an invalid memory reference,</p> <p>or</p> <p>The <i>SectionName.Data</i> parameter supplied by the caller is <b>NULL</b> or an invalid memory reference,</p> <p>or</p> <p>The <i>SectionName.Length</i> supplied by the caller is zero,</p> <p>or</p> <p>The <i>AuthorityCertificate</i> parameter supplied by the caller is <b>NULL</b> or an invalid memory reference,</p> <p>or</p> <p>The <i>IsVerified</i> parameter supplied by the caller is <b>NULL</b> or an invalid memory reference.</p>
EFI_OUT_OF_RESOURCES	The function failed due to lack of memory or other resources.

EFI_SECURITY_VIOLATION	<p>The <i>Credentials.Data</i> supplied by the caller is <b>NULL</b>,</p> <p>or</p> <p>The <i>AuthorityCertificate</i> supplied by the caller was invalid (could not be parsed),</p> <p>or</p> <p>The signed manifest supplied as <i>Credentials</i> failed to verify using the <i>AuthorityCertificate</i> supplied by the caller or the manifest's signer's certificate,</p> <p>or</p> <p>Any other required attribute value was missing,</p> <p>or</p> <p>The signed manifest supplied as the <i>Credentials</i> parameter did not include a signer certificate,</p> <p>or</p> <p>The signed manifest supplied as the <i>Credentials</i> parameter did not include the manifest section named according to <i>SectionName</i>,</p> <p>or</p> <p>The signed manifest supplied as the <i>Credentials</i> parameter had a signing certificate with an unsupported public-key algorithm,</p> <p>or</p> <p>The manifest section named according to <i>SectionName</i> did not include a digest with a digest algorithm corresponding to the signing certificate's public key algorithm,</p> <p>or</p> <p>The data object supplied as the <i>DataObject</i> parameter and referenced by the manifest section named according to <i>SectionName</i> did not verify with the digest supplied in that manifest section,</p> <p>or</p>
EFI_SECURITY_VIOLATION	<p>The signed manifest supplied as the <i>Credentials</i> parameter did not include a signer's information file with the <b>SignerInformationName</b> identifying attribute value "<b>BIS_VerifiableObjectSignerInfoName</b>,"</p> <p>or</p> <p>There were no signers associated with the identified signer's information file,</p> <p>or</p> <p>There was more than one signer associated with the identified signer's information file,</p> <p>or</p> <p>Any other unspecified security violation occurred.</p>

EFI_DEVICE_ERROR	An unexpected internal error occurred while attempting to retrieve the public key algorithm of the manifest's signer's certificate, or An unexpected internal error occurred in a cryptographic software module.
------------------	--

## 24.6 DHCP options for iSCSI on IPV6

Option 59 is the iSCSI Root path

The format of the root path is

"iscsi:"<servername>":"<protocol>":"<port>":"<LUN>":"<targetname>

This is per the description in "Links to UEFI-Related Documents" (<http://uefi.org/uefi>) under the heading "Format of the iSCSI root path; RFC 4173".

Option 60 is the DHCP Server address.

This is formatted the same as parameter 1 in OPT\_BOOTFILE\_PARAM (60) is the IPv6 address of the DHCP server as described in "Links to UEFI-Related Documents" (<http://uefi.org/uefi>) under the heading "DHCPv6 Options for Network Boot".

## 24.7 HTTP Boot

### 24.7.1 Boot from URL

Elsewhere in this specification there is defined a discoverable network boot using DHCP as a control channel allowing a firmware client machine export its architecture type, and then have the boot server response with a binary image. For the UEFI architecture types defined in "Links to UEFI-Related Documents" (<http://uefi.org/uefi>) under the heading "IANA DHCPv6 parameters", the binary image on the boot service is a UEFI-formatted executable with a machine subsystem type that corresponds to the UEFI firmware on the client machine, or it could be mounted as a RAM disk which contains a UEFI-compliant file system (see [Section 13.3](#)). This binary image is often referred to as a "Network Boot Program" (NBP). The UEFI client machine that downloads the NBP uses the IPV4 or IPV6 TFTP protocol to address the indicated server, depending upon if DHCP4 or DHCP6 was used initially, in order to download images such as 64-bit UEFI (type 0x07).

This section defines a related method indicated by other codes in the DHCP options, in which the name and path of the NBP are specified as a URI string in one of several formats specifying protocol and unique name identifying the NBP for the specified protocol. In this method the NBP will be downloaded via IPV4 or IPV6 HTTP protocol if the tag indicates x64 UEFI HTTP Boot (type code 0x0f for x86 and 0x10 for x64).

In the future other protocols such as FTP or NFS could be encoded with both new tag types and corresponding URIs (e.g., 'ftp://nbp.efi' or 'nfs://nbp.efi', respectively). However, assignment of these type codes has not yet occurred.

The rest of this section will describe 'HTTP Boot' as one example of 'boot from URI'. It is expected that the procedure can be extended as additional protocol type codes are defined.

Please reference the definitions of **EFI\_DNS4\_PROTOCOL** and **EFI\_DNS6\_PROTOCOL** elsewhere in this document. In systems that also support one of both of these protocols, the target URI can be specified using Internet domain name format understood by DNS servers supporting the appropriate RFC specifications.

Also, elsewhere in this document, the PXE2.1 and UEFI2.4 netboot6 sections talk about the 'boot from TFTP' method of 'boot from URI.'

The following RFC documents should be consulted for network message details related to the processes described in this chapter:

1. RFC1034 - "Domain Names - Concepts and Facilities",
2. RFC 1035 - "Domain Names - Implementation and Specification",
3. RFC 3513 - "Internet Protocol Version 6 (IPv6) Addressing Architecture", , April 2003.
4. RFC 3596 - DNS Extensions to Support IP Version 6
5. RFC 2131 – Dynamic Host Configuration Protocol
6. RFC 2132 – DHCP options and BOOTP Vendor Extensions
7. RFC 5970 – DHCPv6 Options for Network Boot
8. RFC 4578 – Dynamic Host Configuration Protocol (DHCP) Options for the Intel Preboot eXecution Environment (PXE)
9. RFC 3986 – Uniform Resource Identifiers (URI): Generic Syntax, IETF, 2005
10. RFC 3004 – The User Class option
11. RFC3315 – Dynamic Host Configuration Protocol for IPv6 (DHCPv6)
12. RFC3646 – DNS Configuration options for Dynamic Host Configuration Protocol for IPv6 (DHCPv6)
13. RFC2246 – TLS protocol Version 1.0

## 24.7.2 Concept configuration for a typical HTTP Boot scenario

HTTP Boot is client-server communication based application. It combines the DHCP, DNS, and HTTP protocols to provide the capability for system deployment and configuration over the network. This new capability can be utilized as a higher-performance replacement for tftp-based PXE boot methods of network deployment.

### 24.7.2.1 Use in Corporate environment

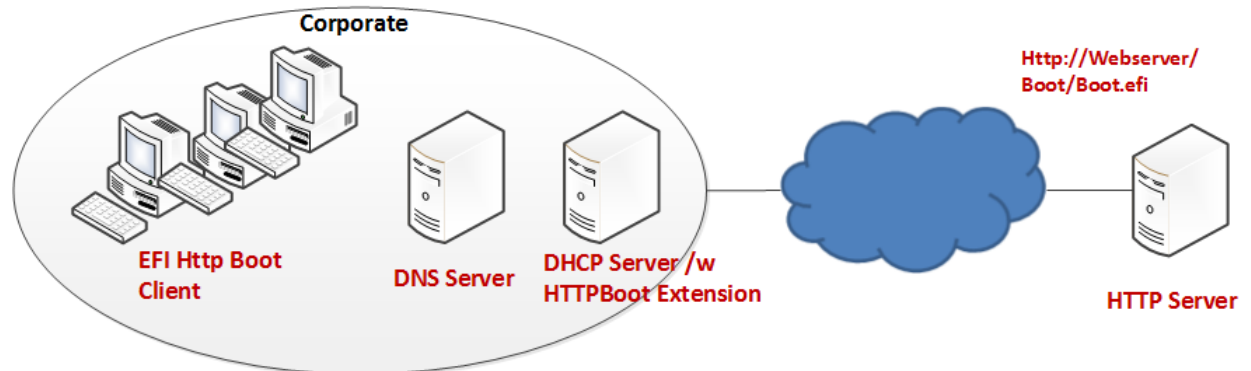

Figure 76. HTTP Boot Network Topology Concept – Corporate Environment

A typical network configuration which supports UEFI HTTP Boot may involve one or more UEFI client systems, and several server systems. [Figure 76](#) show a typical HTTP Boot network topology for a corporate environment.

- **UEFI HTTP Boot Client** initiates the communication between the client and different server system.
- **DHCP server with HTTPBoot extension** for boot service discovery. Besides the standard host configuration information (such as address/subnet/gateway/name-server, etc...), the DHCP server with the extensions can also provide the discovery of URI locations for boot images on the HTTP server.
- **HTTP server** could be located either inside the corporate environment or across networks, such as on the Internet. The boot resource itself is deployed on the HTTP server. In this example, "http://webserver/boot/boot.efi" is used as the boot resource. Such an application is also called a Network Boot Program (NBP). NBPs are used to setup the client system, which may include installation of an operating system, or running a service OS for maintenance and recovery tasks.
- **DNS server** is optional; and provides standard domain name resolution service.

### 24.7.2.2 Use case in Home environment

Unlike the corporate environment, in which a standard DHCP server can be enhanced to support the HTTPBoot extension, generally, in home network, only a standard DHCP server is available for host configuration information assignment. [Figure 77](#) shows the concept network topology for a typical home PC environment.

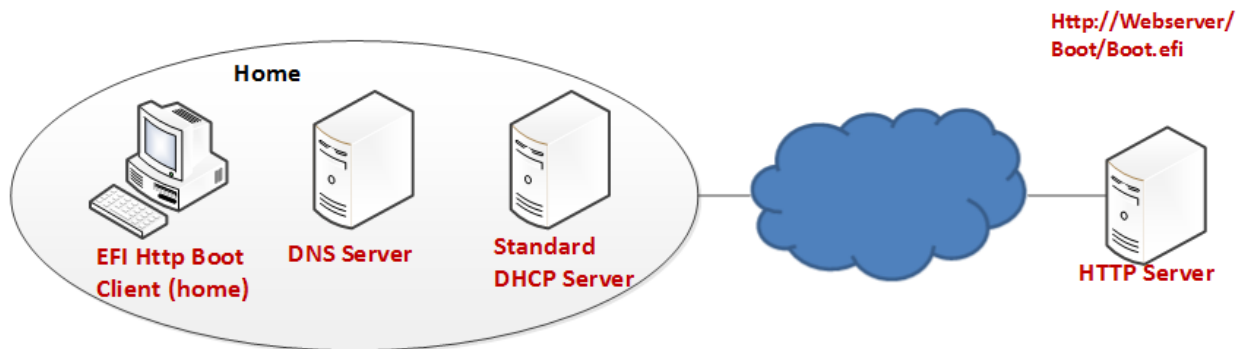

Figure 77. HTTP Boot Network Topology Concept2 – Home environments

**UEFI HTTP Boot Client** initiates the communication between the client and different servers. In this configuration however, the Client will expect the boot resource information to be available from a source other than the standard DHCP server, which does not typically have HTTPBoot extensions. Instead of DHCP, the boot URI could be created by a UEFI application or extracted from text entered by a user.

**DHCP server** provides the standard service to assign host configuration information (such as address/subnet/gateway/name-server etc...) to the UEFI Client

**DNS Server**, is optional; and provides standard domain name resolution service.

### 24.7.3 Protocol Layout for UEFI HTTP Boot Client concept configuration for a typical HTTP Boot scenario



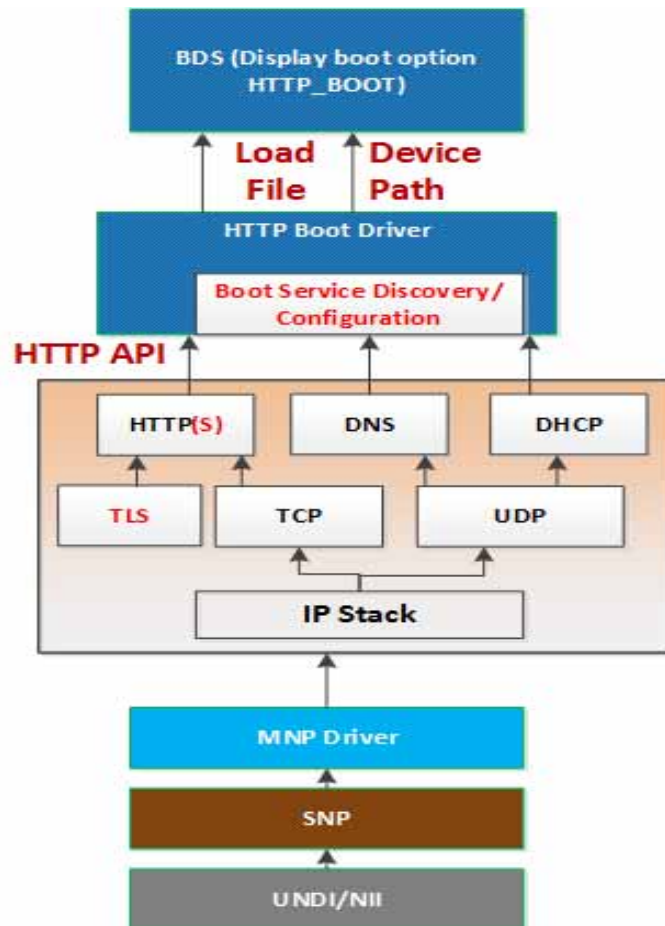

Figure 78. UEFI HTTP Boot Protocol Layout

This figure illustrates the UEFI network layers related to how the HTTP Boot works.

The HTTP Boot driver is layered on top of a UEFI Network stack implementation. It consumes DHCP service to do the Boot service discovery, and DNS service to do domain name resolution if needed. It also consumes HTTP serviced to retrieve images from the HTTP server. The functionality needed in the HTTP Boot scenario is limited to client initiated requests to download the boot image.

TLS is consumed if HTTPS functionality is needed. The TLS design is covered in [Section 28.10.2](#).

The HTTP Boot driver produces **LoadFile** protocol and device path protocol. BDS will provide the boot options for the HTTP Boot. Once a boot option for HTTP boot is executed, a particular network interface is selected. HTTP Boot driver will perform all steps on that interface and it is not required to use other interfaces.

### 24.7.3.1 Device Path

If both IPv4 and IPv6 are supported, the HTTP Boot driver should create two child handles, with LoadFile and DevicePath installed on each child handle. For the device path, an IP device path node and a BootURI device path are appended to the parent device path, for example:

```
PciRoot(0x0)/Pci(0x19, 0x0)/MAC(001230F4B4FF, 0x0)/IPv4(0.0.0.0, 0, DHCP, 0.0.0.0, 0.0.0.0, 0.0.0.0)/Uri()
```

```
PciRoot(0x0)/Pci(0x19, 0x0)/MAC(001230F4B4FF, 0x0)/IPv6(::<128, 0, Static, ::128, ::128, 0)/Uri()
```

Also, after retrieving the boot resource information and IP address, the BootURI device path node will be updated to include the BootURI information. For example, if the NBP is a UEFI-formatted executable, the device patch will be updated to

```
PciRoot(0x0)/Pci(0x19, 0x0)/MAC(001230F4B4FF, 0x0)/IPv4(192.168.1.100, TCP, DHCP, 192.168.1.5, 192.168.1.1, 255.255.255.0)/Uri(http://192.168.1.100/shell.efi)
```

```
PciRoot(0x0)/Pci(0x19, 0x0)/MAC(001230F4B4FF, 0x0)/IPv6(2015::100, TCP, StatefulAutoConfigure, 2015::5, 2015::10, 64)/Uri(http://2015::100/shell.efi)
```

These two instances allow for the boot manager to decide a preference of IPv6 versus IPv4.

If the NBP is a binary image which could be mounted as a RAM disk, the device path will be updated to

```
PciRoot(0x0)/Pci(0x19, 0x0)/MAC(001230F4B4FF, 0x0)/IPv4(192.168.1.100, TCP, DHCP, 192.168.1.5, 192.168.1.1, 255.255.255.0)/Uri(http://192.168.1.100/boot.iso [^])
```

```
PciRoot(0x0)/Pci(0x19, 0x0)/MAC(001230F4B4FF, 0x0)/IPv6(2015::100, TCP, StatefulAutoConfigure, 2015::5, 2015::10, 64)/Uri (http://2015::100/boot.iso)
```

In this case, the HTTP Boot driver will register RAM disk with the downloaded NBP, by appending a RamDisk device node to the device path above, like

```
PciRoot(0x0)/Pci(0x19, 0x0)/MAC(001230F4B4FF, 0x0)/IPv4(192.168.1.100, TCP, DHCP, 192.168.1.5, 192.168.1.1, 255.255.255.0)/Uri(http://192.168.1.100/boot.iso )/RamDisk(0x049EA000, 0x5DEA000, 0, 3D5ABD30-4175-87CE-6D64-D2ADE523C4BB)
```

```
PciRoot(0x0)/Pci(0x19, 0x0)/MAC(001230F4B4FF, 0x0)/IPv6(2015::100, TCP, StatefulAutoConfigure, 2015::5, 2015::10, 64)/Uri (http://2015::100/boot.iso)/RamDisk(0x049EA000, 0x5DEA000, 0, 3D5ABD30-4175-87CE-6D64-D2ADE523C4BB)
```

In some cases, Uri includes a host name and DNS become mandatory for translating the name to the IP address of the host. The HTTP Boot driver may append DNS device path node immediately before Uri device path node, for example:

```
PciRoot(0x0)/Pci(0x19, 0x0)/MAC(001230F4B4FF, 0x0)/IPv4(192.168.1.100, TCP, DHCP,
192.168.1.5, 192.168.1.1, 255.255.255.0)/Dns(192.168.22.100, 192.168.22.101)/
Uri(http://www.bootserver.com/boot.iso) / RamDisk(0x049EA000, 0x5DEA000, 0,
3D5ABD30-4175-87CE-6D64-D2ADE523C4BB)
```

```
PciRoot(0x0)/Pci(0x19, 0x0)/MAC(001230F4B4FF, 0x0)/IPv6(2015::100, TCP,
StatefulAutoConfigure, 2015::5, 2015::10, 64)/Dns(2016::100, 2016::101)/Uri (http://
www.bootserver.com/ boot.iso)/ RamDisk(0x049EA000, 0x5DEA000, 0, 3D5ABD30-
4175-87CE-6D64-D2ADE523C4BB)
```

If HTTP Boot driver cannot obtain the DNS server addresses, it should not append an empty DNS device path node.

The boot manager could use the example device paths to match the device which produces a device path protocol including a URI device path node in the system, without matching the Specific Device Path data in IP device path node and URI device path node, because the IP device path node and URI device path node might be updated by HTTP Boot driver in different scenarios.

The BootURI information could be retrieved from a DHCP server with HTTPBoot extension, or from a boot option which includes a short-form URI device path, or from a boot option which includes a URI device path node, or created by a UEFI application or extracted from text entered by a user.

Once the HTTP Boot driver retrieves the BootURI information from the short-form URI device path, it will perform all other steps for HTTP boot except retrieving the BootURI from DHCP server. Also, when the short-form URI device path is inputted to HTTP Boot driver via *LoadFile* protocol, the HTTP Boot driver should expand the short-form URI device path to above example device path after retrieving IP address configuration from DHCP server.

Once the HTTP Boot driver retrieves the BootURI information from a boot option which includes a URI device path node, it should retrieve the IP address configuration from the IP device path node of the same boot option. If the IP address configuration or BootURI information is empty, the HTTP Boot driver could retrieve the required information from DHCP server. If the IP address configuration or BootURI information is not empty but invalid, the HTTP boot process will fail.

The HTTP Boot block diagram ([Figure 78](#)) describes a suggested implementation for HTTP Boot. Other implementation can create their own HTTP Netboot Driver which meets the requirements for their netboot methodology

#### 24.7.4 Concept of Message Exchange in a typical HTTP Boot scenario (IPv4 in Corporate Environment)

In summary, the newly installed networked client machine (UEFI HTTP Boot Client) should be able to enter a heterogeneous network, acquire a network address from a DHCP server, and then download an NBP to set itself up.

The concept of HTTP Boot message exchange sequence is as follows. The client initiates the DHCPv4 D.O.R.A process by broadcasting a DHCPDISCOVER containing the extension that identifies the request as coming from a client that implements the HTTP Boot functionality. Assuming that a DHCP server or a Proxy DHCP server implementing this extension is available, after several intermediate steps, besides the standard configuration such as address/subnet/router/dns-server, boot resource location will be provided to the client system in the format of a URI. The URI points to the NBP which is appropriate for this client hardware configuration. A boot option is created, and if selected by the system logic the client then uses HTTP to download the NBP from the HTTP server into memory. Finally, the client executes the downloaded NBP image from memory. This image can then consume other UEFI interfaces for further system setup.

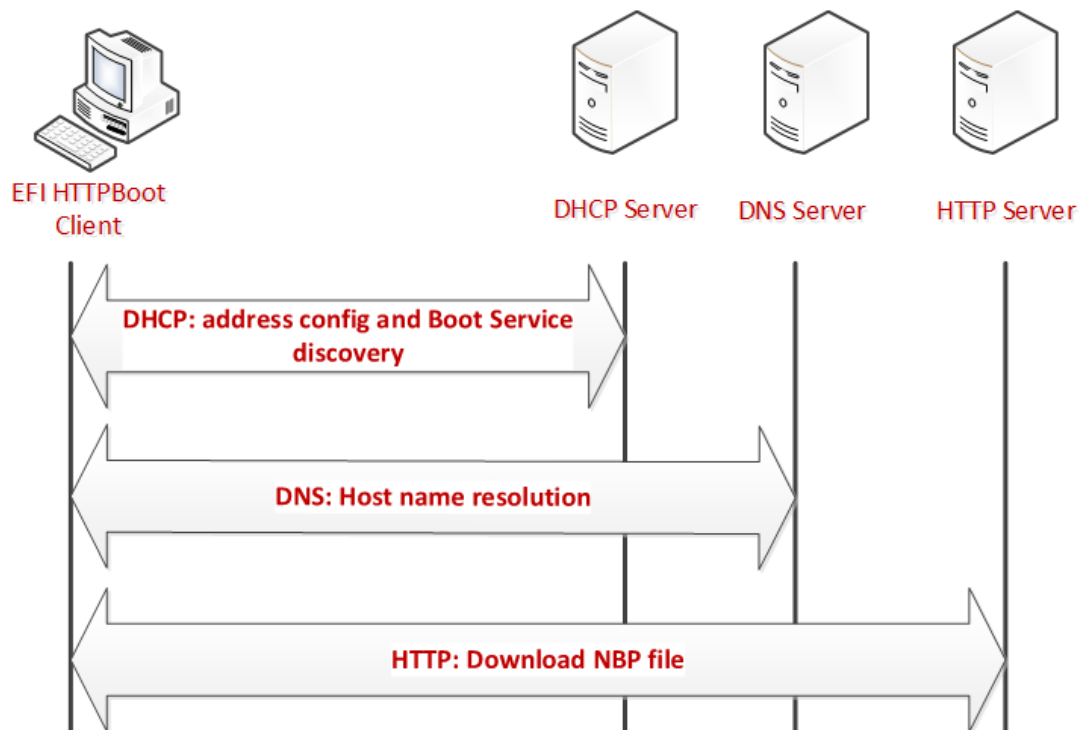

Figure 79. HTTP Boot overall flow

#### 24.7.4.1 Message exchange between EFI Client and DHCP server using DHCP Client Extensions

##### 24.7.4.1.1 Client broadcast

The client broadcasts a DHCP Discover message to the standard DHCP port (67).

An option field in this packet contains the following:

- Fill DHCP option 55 – Parameter Requested List option
  - Address configuration, Server information, Name server, Vendor class identifier
- A DHCP option 97: UUID/GUID-based Client Identifier

- A DHCP option 94: Client Network Identifier Option
  - If support UNDI, fill this option (Refer RFC5970)
- A DHCP option 93: the client system architecture (Refer [Arch-Type])
  - 0x0F - x86 UEFI HTTP Boot
  - 0x10 - x64 UEFI HTTP Boot
- A DHCP option 60, Vendor Class ID, set to "HTTPClient:Arch:XXXX:UNDI:YYYYZZZ"

#### 24.7.4.1.2 DHCP server response

The DHCP server responds by sending DHCPOFFER message on standard DHCP reply port (68).

The HTTP Boot Client may possibly receive multiple DHCPOFFER packets from different sources of DHCP Services, possibly from DHCP Services which recognize the HTTP extensions or from Standard DHCP Services.

A service recognizing HTTP extensions must respond with an offer that has Option 60 (Vendor class identifier) parameter set to "HTTPClient", in response to the Vendor class identifier requested in option 55 in the DHCP Discover message.

Each message contains standard DHCP parameters: an IP address for the client and any other parameters that the administrator might have configured on the DHCP or Proxy DHCP Service. The DHCP service or Proxy DHCP which recognizes the HTTPBoot extension will provide DHCPOFFER with HTTPClient extensions. If this is a Proxy DHCP service, then the client IP address field is (0.0.0.0). If this is from a DHCP service, then the returned client IP address field is valid.

From the received DHCPOFFER(s), the client records the information as follows:

- Client IP address (and other parameters) offered by a standard DHCP/BOOTP services.
- If Boot URI information is provided thru 'file' field in DHCP Header or option 67, then the client will record the information as well.
- Optional Name-server information if URI is displayed using domain-name

**Timeout:** After Client sent out the DHCP Discover packet, the Client will wait for a timeout to collect enough DHCP Offers. If failed to retrieve all the required information, the DHCP Discover will be retried, at most four times. The four timeout mechanisms is 4, 8, 16 and 32 seconds respectively,

**Priority:** Among all the received DHCPOFFERs, the Priority is considered as follows:

#### Priority1

Choose the DHCPOFFER that provides all required information:

*<IP address configuration, Boot URI configuration, Name-server configuration (if domain-name used in Boot URI)>*

If Boot URI and IP address configuration provided in different DHCPOFFER, Using 5 DHCPOFFER as example for priority description

- Packet1 – DHCPOFFER, provide <IP address configuration, Name server>
- Packet2 – DHCPOFFER, provide <IP address configuration>
- Packet3 – DHCPOFFER, provide <domain-name expressed URI>
- Packet4 – DHCPOFFER, provide <IP address expressed URI>
- Packet5 – DHCPOFFER, provide <IP address, domain-name expressed URI>

Then,

### Priority2

Choose the DHCPOFFER from different packet, firstly find out URI info represented in IP address mode, then choose DHCPOFFER which provide IP address configuration

In this example, the chosen DHCPOFFER packet is packet4 + packet1 / packet 2 (packet 1/2 take same priority, implementation can make its own implementation choice)

### Priority3

Choose the DHCPOFFER from different packet, firstly find out URI info represented in domain-name mode, then choose DHCPOFFER which provide <IP address configuration, domain-name expressed URI>

In this example, the chosen DHCPOFFER packet is packet3 / packet5 + packet1

**Note:** *If packet5, then client IP address assigned by Packet5 will be override by IP address in packet1.*

### Priority4

If failed to retrieve <Boot URI / IP address / (on-demand) Name-server> information through all received DHCPOFFERs, this is deemed as FAILED-CONFIGURATION

Assuming the boot image is in the boot subdirectory of the web server root, the supported URI could be one of below formats. [RFC3986] where '/boot/' is replaced by administrator-created directory, and 'image' is the file name of the NBP.

<http://reg-name:port/boot/image>

<http://ipv4address:port/boot/image>

<http://ipv6address:port/boot/image>

In the URL example, Port is optional if web service is provided through port 80 for the HTTP data transfer. Commonly, the reg-name use DNS as name registry mechanism.

After retrieving the boot URI through [Section 24.7.3.1](#), if IP address (either IPv4 or IPv6 address) is provided, the HTTP Boot Client can directly use that address for next step HTTP transfer. If a reg-name is provided in the URI, the HTTP Boot Client driver need initiate DNS process ([Section 24.7.4.3](#)) to resolve its IP address.

#### 24.7.4.1.3 DHCP Request

The HTTP Boot Client selects an IP address offered by a DHCP Service, and then it completes the standard DHCP protocol by sending a DHCP Request packet for the address to the DHCP Server and waiting for acknowledgement from the DHCP server.

#### 24.7.4.1.4 DHCP ACK

The server acknowledges the IP address by sending DHCP ACK packet to the client.

#### 24.7.4.2 Message exchange between UEFI Client and DHCP server not using DHCP Client Extensions

In a home environment, because the Boot URI Information will not be provided by the DHCP Offers, we need other channels to provide this information. The implementation suggestion is provisioning this information by OEM or input by end user through Setup Options, henceforth, the UEFI Boot Client already know the Boot URI before contacting the DHCP server.

The message exchange between the EFI Client and DHCP server will be standard DHCP D.O.R.A to obtain <IP address, Name-server>.

#### 24.7.4.3 Message in DNS Query/Reply

The DNS Query/Reply is a standard process defined in DNS Protocol [RFC 1034, RFC 1035]. Multiple IP address might be retrieved from the DNS process. It's the HTTP Boot Client driver's responsibility to select proper IP address automatically or expose user interface for customer to decide proper IP address.

#### 24.7.4.4 Message in HTTP Download

In the HTTP Boot scenario, HTTP GET message is used to get image from the Web server.

### 24.7.5 Concept of Message Exchange in HTTP Boot scenario (IPv6)

#### 24.7.5.1 Message exchange between EFI Client and DHCPv6 server with DHCP Client extensions

##### 24.7.5.1.1 Client multicast a DHCPv6 Solicit message to the standard DHCPv6 port (547).

Besides the options required for address auto-configuration, option field in this packet also contains the following:

- Fill DHCPv6 Option 6 – Option Request Option
  - Request server to supply option 59 (OPT\_BOOTFILE\_URL), option 60 (OPT\_BOOTFILE\_PARAM), option 23 (OPT\_DNS\_SERVERS), option 16 (OPTION\_VENDOR\_CLASS).
- A DHCPv6 option 1, Client identifier
- A DHCPv6 option 16, Vendor Class ID, set to "HTTPClient:Arch:XXXX:UNDI:YYYYZZZ"
- A DHCPv6 option 61: the client system architecture (Refer [Arch-Type])
  - 0x0F - x86 UEFI HTTP Boot
  - 0x10 - x64 UEFI HTTP Boot
- A DHCPv6 option 62: Client Network Identifier Option
  - If support UNDI, fill this option (Refer RFC5970)

#### 24.7.5.1.2 Server unicast DHCPv6 Advertisement to the Client to the DHCPv6 port (546).

The HTTP Boot Client will receive multiple advertisements from different sources of DHCPv6 Services, possibly from DHCPv6 Services which recognize the HTTP extensions or from Standard DHCPv6 Services.

A DHCPv6 service recognizing HTTP extensions must respond with an Advertisement that has Option 16 (OPTION\_VENDOR\_CLASS) parameter set to "HTTPClient", in response to the OPTION\_VENDOR\_CLASS requested in Option 6 in the DHCPv6 Solicit message.

Each message contains standard DHCP parameters: Identify Association (IA) option which conveys information including <IP address, lifetime, etc...>. Name server option conveys the DNS server address. The DHCP service or Proxy DHCP which recognizes the HTTPBoot extension will provide DHCPv6 Advertisement with HTTPClient extensions, including Boot URI and Optional Boot Parameters.

From the received DHCP OFFER(s), the client records the information as follows:

- Client IP address (and other parameters) provided through IA option
- Boot URI provided through option 59
- Optional BootFile Parameter provided through option 60 (if no other parameter needed for this boot URI, this option can be eliminated)
- Optional Name-server information provided through option 23, if URI is displayed using domain-name.

#### 24.7.5.1.3 Client multicast DHCPv6 Request to the selected DHCP Advertisement to confirm the IP address assigned by that server

This packet is the same with the DHCPv6 Solicit packet except for the message type is Request.

#### 24.7.5.1.4 Server unicast the DHCPv6 Reply to acknowledge the Client IP address for the UEFI HTTP Client.

#### 24.7.5.2 Message exchange between UEFI Client and DHCPv6 server not using DHCP Client Extensions

In a home environment, the Boot URI Information will not be provided by the DHCPv6 Offers, we need other channels to provide this information. Like what is described in [Section 24.7.4.2](#), the implementation suggestion is provisioning this information by OEM or input by end user through Setup Options, henceforth, the UEFI Boot Client already know the Boot URI before contacting the DHCP server.

The message exchange between the EFI Client and DHCP server will be standard DHCP D.O.R.A to obtain <IP address, Name-server>.

#### 24.7.5.3 Message exchange between UEFI Client and DNS6 server

The DNS Query/Reply for domain name resolution is the same process as described in [Section 24.7.4.3](#).



#### 24.7.5.4 Message in HTTP Download

HTTP Download process is the same process as described in [Section 24.7.4.4](#).

## 24.7.6 EFI HTTP Boot Callback Protocol

This section defines the EFI HTTP Boot Callback Protocol that is invoked when the HTTP Boot driver is about to transmit or has received a packet. The EFI HTTP Boot Callback Protocol must be installed on the same handle as the Load File Protocol for the HTTP Boot.

### EFI\_HTTP\_BOOT\_CALLBACK\_PROTOCOL

#### Summary

Protocol that is invoked when the HTTP Boot driver is about to transmit or has received a packet.

#### GUID

```
#define EFI_HTTP_BOOT_CALLBACK_PROTOCOL_GUID \
    {0xba23b311, 0x343d, 0x11e6, {0x91, 0x85, 0x58, 0x20, 0xb1, 0xd6, 0x52, 0x99}}
```

#### Protocol Interface Structure

```
typedef struct _EFI_HTTP_BOOT_CALLBACK_PROTOCOL {
    EFI_HTTP_BOOT_CALLBACK Callback;
} EFI_HTTP_BOOT_CALLBACK_PROTOCOL;
```

#### Parameters

*Callback*                      Callback routine used by the HTTP Boot driver.

## EFI\_HTTP\_BOOT\_CALLBACK\_PROTOCOL.Callback()

### Summary

Callback function that is invoked when the HTTP Boot driver is about to transmit or has received a packet.

### Prototype

```
typedef
EFI_STATUS
(EFIAPI *EFI_HTTP_BOOT_CALLBACK) (
  IN EFI_HTTP_BOOT_CALLBACK_PROTOCOL *This,
  IN EFI_HTTP_BOOT_CALLBACK_DATA_TYPE DataType,
  IN BOOLEAN Received,
  IN UINT32 DataLength,
  IN VOID *Data OPTIONAL
);
```

### Parameters

<i>This</i>	Pointer to the <b>EFI_HTTP_BOOT_CALLBACK_PROTOCOL</b> instance.
<i>DataType</i>	The event that occurs in the current state. Type <b>EFI_HTTP_BOOT_CALLBACK_DATA_TYPE</b> is defined below.
<i>Received</i>	<b>TRUE</b> if the callback is being invoked due to a receive event. <b>FALSE</b> if the callback is being invoked due to a transmit event.
<i>DataLength</i>	The length in bytes of the buffer pointed to by <i>Data</i> .
<i>Data</i>	A pointer to the buffer of data, the data type is specified by <i>DataType</i> .

## Related Definitions

```

//*****
// EFI_HTTP_BOOT_CALLBACK_DATA_TYPE
//*****
typedef enum {
  HttpBootDhcp4,
  HttpBootDhcp6,
  HttpBootHttpRequest,
  HttpBootHttpResponse,
  HttpBootHttpEntityBody,
  HttpBootTypeMax
} EFI_HTTP_BOOT_CALLBACK_DATA_TYPE;

```

*HttpBootDhcp4*      *Data* points to a DHCP4 packet which is about to transmit or has received.

*HttpBootDhcp6*      *Data* points to a DHCP6 packet which is about to be transmit or has received.

*HttpBootHttpRequest*      *Data* points to an **EFI\_HTTP\_MESSAGE** structure, which contains a HTTP request message to be transmitted.

*HttpBootHttpResponse*      *Data* points to an **EFI\_HTTP\_MESSAGE** structure, which contains a received HTTP response message.

*HttpBootHttpEntityBody*      Part of the entity body has been received from the HTTP server.  
*Data* points to the buffer of the entity body data.

## Description

This function is invoked when the HTTP Boot driver is about to transmit or has received packet. Parameters *Data* and *Received* specify the type of event and the format of the buffer pointed to by *Data*. Due to the polling nature of UEFI device drivers, this callback function should not execute for more than 5 ms.

The returned status code determines the behavior of the HTTP Boot driver.

## Status Codes Returned

EFI_SUCCESS	Tells the HTTP Boot driver to continue the HTTP Boot process.
EFI_ABORTED	Tells the HTTP Boot driver to abort the current HTTP Boot process.

## 25 Network Protocols — Managed Network

---

### 25.1 EFI Managed Network Protocol

This chapter defines the EFI Managed Network Protocol. It is split into the following two main sections:

- Managed Network Service Binding Protocol (MNSBP)
- Managed Network Protocol (MNP)

The MNP provides raw (unformatted) asynchronous network packet I/O services. These services make it possible for multiple-event-driven drivers and applications to access and use the system network interfaces at the same time.

#### EFI\_MANAGED\_NETWORK\_SERVICE\_BINDING\_PROTOCOL

##### Summary

The MNSBP is used to locate communication devices that are supported by an MNP driver and to create and destroy instances of the MNP child protocol driver that can use the underlying communications device.

The EFI Service Binding Protocol in [Section 2.5.8](#) defines the generic Service Binding Protocol functions. This section discusses the details that are specific to the MNP.

##### GUID

```
#define EFI_MANAGED_NETWORK_SERVICE_BINDING_PROTOCOL_GUID \
  {0xf36ff770,0xa7e1,0x42cf,\
   {0x9ed2,0x56,0xf0,0xf2,0x71,0xf4,0x4c}}
```

##### Description

A network application (or driver) that requires shared network access can use one of the protocol handler services, such as **BS->LocateHandleBuffer()**, to search for devices that publish an MNSBP GUID. Each device with a published MNSBP GUID supports MNP and may be available for use.

After a successful call to the **EFI\_MANAGED\_NETWORK\_SERVICE\_BINDING\_PROTOCOL.CreateChild()** function, the child MNP driver instance is in an unconfigured state; it is not ready to send and receive data packets.

Before a network application terminates execution, every successful call to the **EFI\_MANAGED\_NETWORK\_SERVICE\_BINDING\_PROTOCOL.CreateChild()** function must be matched with a call to the **EFI\_MANAGED\_NETWORK\_SERVICE\_BINDING\_PROTOCOL.DestroyChild()** function.

## EFI\_MANAGED\_NETWORK\_PROTOCOL

### Summary

The MNP is used by network applications (and drivers) to perform raw (unformatted) asynchronous network packet I/O.

### GUID

```
#define EFI_MANAGED_NETWORK_PROTOCOL_GUID\
{0x7ab33a91, 0xace5, 0x4326,\
 0xb5, 0x72, 0xe7, 0xee, 0x33, 0xd3, 0x9f, 0x16}}
```

### Protocol Interface Structure

```
typedef struct _EFI_MANAGED_NETWORK_PROTOCOL {
  EFI_MANAGED_NETWORK_GET_MODE_DATA  GetModeData;
  EFI_MANAGED_NETWORK_CONFIGURE      Configure;
  EFI_MANAGED_NETWORK_MCAST_IP_TO_MAC McastIpToMac;
  EFI_MANAGED_NETWORK_GROUPS         Groups;
  EFI_MANAGED_NETWORK_TRANSMIT       Transmit;
  EFI_MANAGED_NETWORK_RECEIVE        Receive;
  EFI_MANAGED_NETWORK_CANCEL         Cancel;
  EFI_MANAGED_NETWORK_POLL           Poll;
} EFI_MANAGED_NETWORK_PROTOCOL;
```

### Parameters

<i>GetModeData</i>	Returns the current MNP child driver operational parameters. May also support returning underlying Simple Network Protocol (SNP) driver mode data. See the <b>GetModeData()</b> function description.
<i>Configure</i>	Sets and clears operational parameters for an MNP child driver. See the <b>Configure()</b> function description.
<i>McastIpToMac</i>	Translates a software (IP) multicast address to a hardware (MAC) multicast address. This function may be unsupported in some MNP implementations. See the <b>McastIpToMac()</b> function description.
<i>Groups</i>	Enables and disables receive filters for multicast addresses. This function may be unsupported in some MNP implementations. See the <b>Groups()</b> function description.
<i>Transmit</i>	Places asynchronous outgoing data packets into the transmit queue. See the <b>Transmit()</b> function description.
<i>Receive</i>	Places an asynchronous receiving request into the receiving queue. See the <b>Receive()</b> function description.
<i>Cancel</i>	Aborts a pending transmit or receive request. See the <b>Cancel()</b> function description.

*Poll*

Polls for incoming data packets and processes outgoing data packets. See the **Poll()** function description.

**Description**

The services that are provided by MNP child drivers make it possible for multiple drivers and applications to send and receive network traffic using the same network device.

Before any network traffic can be sent or received, the **EFI\_MANAGED\_NETWORK\_PROTOCOL.Configure()** function must initialize the operational parameters for the MNP child driver instance. Once configured, data packets can be received and sent using the following functions:

- **EFI\_MANAGED\_NETWORK\_PROTOCOL.Transmit()**
- **EFI\_MANAGED\_NETWORK\_PROTOCOL.Receive()**
- **EFI\_MANAGED\_NETWORK\_PROTOCOL.Poll()**

## EFI\_MANAGED\_NETWORK\_PROTOCOL.GetModeData()

### Summary

Returns the operational parameters for the current MNP child driver. May also support returning the underlying SNP driver mode data.

### Prototype

```
typedef
EFI_STATUS
(EFIAPI *EFI_MANAGED_NETWORK_GET_MODE_DATA) (
  IN EFI_MANAGED_NETWORK_PROTOCOL *This,
  OUT EFI_MANAGED_NETWORK_CONFIG_DATA *MnpConfigData OPTIONAL,
  OUT EFI_SIMPLE_NETWORK_MODE *SnpModeData OPTIONAL
);
```

### Parameters

<i>This</i>	Pointer to the <b>EFI_MANAGED_NETWORK_PROTOCOL</b> instance.
<i>MnpConfigData</i>	Pointer to storage for MNP operational parameters. Type <b>EFI_MANAGED_NETWORK_CONFIG_DATA</b> is defined in “Related Definitions” below.
<i>SnpModeData</i>	Pointer to storage for SNP operational parameters. This feature may be unsupported. Type <b>EFI_SIMPLE_NETWORK_MODE</b> is defined in the <b>EFI_SIMPLE_NETWORK_PROTOCOL</b> .

### Description

The **GetModeData()** function is used to read the current mode data (operational parameters) from the MNP or the underlying SNP.



## Related Definitions

```

//*****
// EFI_MANAGED_NETWORK_CONFIG_DATA
//*****
typedef struct {
    UINT32  ReceivedQueueTimeoutValue;
    UINT32  TransmitQueueTimeoutValue;
    UINT16  ProtocolTypeFilter;
    BOOLEAN EnableUnicastReceive;
    BOOLEAN EnableMulticastReceive;
    BOOLEAN EnableBroadcastReceive;
    BOOLEAN EnablePromiscuousReceive;
    BOOLEAN FlushQueuesOnReset;
    BOOLEAN EnableReceiveTimestamps;
    BOOLEAN DisableBackgroundPolling;
} EFI_MANAGED_NETWORK_CONFIG_DATA;

```

### *ReceivedQueueTimeoutValue*

Timeout value for a UEFI one-shot timer event. A packet that has not been removed from the MNP receive queue by a call to **EFI\_MANAGED\_NETWORK\_PROTOCOL.PoII()** will be dropped if its receive timeout expires. If this value is zero, then there is no receive queue timeout. If the receive queue fills up, then the device receive filters are disabled until there is room in the receive queue for more packets. The startup default value is 10,000,000 (10 seconds).

### *TransmitQueueTimeoutValue*

Timeout value for a UEFI one-shot timer event. A packet that has not been removed from the MNP transmit queue by a call to **EFI\_MANAGED\_NETWORK\_PROTOCOL.PoII()** will be dropped if its transmit timeout expires. If this value is zero, then there is no transmit queue timeout. If the transmit queue fills up, then the **EFI\_MANAGED\_NETWORK\_PROTOCOL.Transmit()** function will return **EFI\_NOT\_READY** until there is room in the transmit queue for more packets. The startup default value is 10,000,000 (10 seconds).

### *ProtocolTypeFilter*

Ethernet type II 16-bit protocol type in host byte order. Valid values are zero and 1,500 to 65,535. Set to zero to receive packets with any protocol type. The startup default value is zero.

### *EnableUnicastReceive*

Set to **TRUE** to receive packets that are sent to the

network device MAC address. The startup default value is **FALSE**.

*EnableMulticastReceive*

Set to **TRUE** to receive packets that are sent to any of the active multicast groups. The startup default value is **FALSE**.

*EnableBroadcastReceive*

Set to **TRUE** to receive packets that are sent to the network device broadcast address. The startup default value is **FALSE**.

*EnablePromiscuousReceive*

Set to **TRUE** to receive packets that are sent to any MAC address. Note that setting this field to **TRUE** may cause packet loss and degrade system performance on busy networks. The startup default value is **FALSE**.

*FlushQueuesOnReset*

Set to **TRUE** to drop queued packets when the configuration is changed. The startup default value is **FALSE**.

*EnableReceiveTimestamps*

Set to **TRUE** to timestamp all packets when they are received by the MNP. Note that timestamps may be unsupported in some MNP implementations. The startup default value is **FALSE**.

*DisableBackgroundPolling*

Set to **TRUE** to disable background polling in this MNP instance. Note that background polling may not be supported in all MNP implementations. The startup default value is **FALSE**, unless background polling is not supported.

## Status Codes Returned

EFI_SUCCESS	The operation completed successfully.
EFI_INVALID_PARAMETER	<i>This</i> is <b>NULL</b> .
EFI_UNSUPPORTED	The requested feature is unsupported in this MNP implementation.
EFI_NOT_STARTED	This MNP child driver instance has not been configured. The default values are returned in <i>MnpConfigData</i> if it is not <b>NULL</b> .
Other	The mode data could not be read.

## EFI\_MANAGED\_NETWORK\_PROTOCOL.Configure()

### Summary

Sets or clears the operational parameters for the MNP child driver.

### Prototype

```
typedef
EFI_STATUS
(EFIAPI *EFI_MANAGED_NETWORK_CONFIGURE) (
  IN EFI_MANAGED_NETWORK_PROTOCOL *This,
  IN EFI_MANAGED_NETWORK_CONFIG_DATA *MnpConfigData OPTIONAL
);
```

### Parameters

<i>This</i>	Pointer to the <b>EFI_MANAGED_NETWORK_PROTOCOL</b> instance.
<i>MnpConfigData</i>	Pointer to configuration data that will be assigned to the MNP child driver instance. If <b>NULL</b> , the MNP child driver instance is reset to startup defaults and all pending transmit and receive requests are flushed. Type <b>EFI_MANAGED_NETWORK_CONFIG_DATA</b> is defined in <b>EFI_MANAGED_NETWORK_PROTOCOL.GetModeData()</b> .

### Description

The **Configure()** function is used to set, change, or reset the operational parameters for the MNP child driver instance. Until the operational parameters have been set, no network traffic can be sent or received by this MNP child driver instance. Once the operational parameters have been reset, no more traffic can be sent or received until the operational parameters have been set again.

Each MNP child driver instance can be started and stopped independently of each other by setting or resetting their receive filter settings with the **Configure()** function.

After any successful call to **Configure()**, the MNP child driver instance is started. The internal periodic timer (if supported) is enabled. Data can be transmitted and may be received if the receive filters have also been enabled.

**Note:** *If multiple MNP child driver instances will receive the same packet because of overlapping receive filter settings, then the first MNP child driver instance will receive the original packet and additional instances will receive copies of the original packet.*

**Note:** *Warning: Receive filter settings that overlap will consume extra processor and/or DMA resources and degrade system and network performance.*

### Status Codes Returned

EFI_SUCCESS	The operation completed successfully.
-------------	---------------------------------------

EFI_INVALID_PARAMETER	<p>One or more of the following conditions is <b>TRUE</b>:</p> <ul style="list-style-type: none"> <li>• <i>This</i> is <b>NULL</b>.</li> <li>• <i>MnpConfigData.ProtocolTypeFilter</i> is not valid.</li> </ul> <p>The operational data for the MNP child driver instance is unchanged.</p>
EFI_OUT_OF_RESOURCES	<p>Required system resources (usually memory) could not be allocated.</p> <p>The MNP child driver instance has been reset to startup defaults.</p>
EFI_UNSUPPORTED	<p>The requested feature is unsupported in this [MNP] implementation.</p> <p>The operational data for the MNP child driver instance is unchanged.</p>
EFI_DEVICE_ERROR	<p>An unexpected network or system error occurred.</p> <p>The MNP child driver instance has been reset to startup defaults.</p>
Other	<p>The MNP child driver instance has been reset to startup defaults.</p>

## EFI\_MANAGED\_NETWORK\_PROTOCOL.McastIpToMac()

### Summary

Translates an IP multicast address to a hardware (MAC) multicast address. This function may be unsupported in some MNP implementations.

### Prototype

```
typedef
EFI_STATUS
(EFI_API *EFI_MANAGED_NETWORK_MCAST_IP_TO_MAC) (
  IN EFI_MANAGED_NETWORK_PROTOCOL *This,
  IN BOOLEAN      Ipv6Flag,
  IN EFI_IP_ADDRESS *IpAddress,
  OUT EFI_MAC_ADDRESS *MacAddress
);
```

### Parameters

<i>This</i>	Pointer to the <b>EFI_MANAGED_NETWORK_PROTOCOL</b> instance.
<i>Ipv6Flag</i>	Set to <b>TRUE</b> to if <i>IpAddress</i> is an IPv6 multicast address. Set to <b>FALSE</b> if <i>IpAddress</i> is an IPv4 multicast address.
<i>IpAddress</i>	Pointer to the multicast IP address (in network byte order) to convert.
<i>MacAddress</i>	Pointer to the resulting multicast MAC address.

### Description

The **McastIpToMac()** function translates an IP multicast address to a hardware (MAC) multicast address.

This function may be implemented by calling the underlying **EFI\_SIMPLE\_NETWORK.MCastIpToMac()** function, which may also be unsupported in some MNP implementations.

### Status Codes Returned

EFI_SUCCESS	The operation completed successfully.
EFI_INVALID_PARAMETER	One of the following conditions is <b>TRUE</b> : <ul style="list-style-type: none"> <li><i>This</i> is <b>NULL</b>.</li> <li><i>IpAddress</i> is <b>NULL</b>.</li> <li><i>*IpAddress</i> is not a valid multicast IP address.</li> <li><i>MacAddress</i> is <b>NULL</b>.</li> </ul>
EFI_NOT_STARTED	This MNP child driver instance has not been configured.
EFI_UNSUPPORTED	The requested feature is unsupported in this MNP implementation.
EFI_DEVICE_ERROR	An unexpected network or system error occurred.

Other	The address could not be converted.
-------	-------------------------------------

## EFI\_MANAGED\_NETWORK\_PROTOCOL.Groups()

### Summary

Enables and disables receive filters for multicast address. This function may be unsupported in some MNP implementations.

### Prototype

```
typedef
EFI_STATUS
(EFI_API *EFI_MANAGED_NETWORK_GROUPS) (
  IN EFI_MANAGED_NETWORK_PROTOCOL *This,
  IN BOOLEAN JoinFlag,
  IN EFI_MAC_ADDRESS *MacAddress OPTIONAL
);
```

### Parameters

<i>This</i>	Pointer to the <b>EFI_MANAGED_NETWORK_PROTOCOL</b> instance.
<i>JoinFlag</i>	Set to <b>TRUE</b> to join this multicast group. Set to <b>FALSE</b> to leave this multicast group.
<i>MacAddress</i>	Pointer to the multicast MAC group (address) to join or leave.

### Description

The **Groups()** function only adds and removes multicast MAC addresses from the filter list. The MNP driver does not transmit or process Internet Group Management Protocol (IGMP) packets.

If *JoinFlag* is **FALSE** and *MacAddress* is **NULL**, then all joined groups are left.

### Status Codes Returned

EFI_SUCCESS	The requested operation completed successfully.
EFI_INVALID_PARAMETER	One or more of the following conditions is <b>TRUE</b> : <ul style="list-style-type: none"> <li><i>This</i> is <b>NULL</b>.</li> <li><i>JoinFlag</i> is <b>TRUE</b> and <i>MacAddress</i> is <b>NULL</b>.</li> <li><i>*MacAddress</i> is not a valid multicast MAC address.</li> </ul> The MNP multicast group settings are unchanged.
EFI_NOT_STARTED	This MNP child driver instance has not been configured.
EFI_ALREADY_STARTED	The supplied multicast group is already joined.
EFI_NOT_FOUND	The supplied multicast group is not joined.
EFI_DEVICE_ERROR	An unexpected network or system error occurred. The MNP child driver instance has been reset to startup defaults.
EFI_UNSUPPORTED	The requested feature is unsupported in this MNP implementation.

Other	The requested operation could not be completed. The MNP multicast group settings are unchanged.
-------	--



## EFI\_MANAGED\_NETWORK\_PROTOCOL.Transmit()

### Summary

Places asynchronous outgoing data packets into the transmit queue.

### Prototype

```
typedef
EFI_STATUS
(EFIAPI *EFI_MANAGED_NETWORK_TRANSMIT) (
    IN EFI_MANAGED_NETWORK_PROTOCOL *This,
    IN EFI_MANAGED_NETWORK_COMPLETION_TOKEN *Token
);
```

### Parameters

<i>This</i>	Pointer to the <b>EFI_MANAGED_NETWORK_PROTOCOL</b> instance.
<i>Token</i>	Pointer to a token associated with the transmit data descriptor. Type <b>EFI_MANAGED_NETWORK_COMPLETION_TOKEN</b> is defined in “Related Definitions” below.

### Description

The **Transmit()** function places a completion token into the transmit packet queue. This function is always asynchronous.

The caller must fill in the *Token.Event* and *Token.TxData* fields in the completion token, and these fields cannot be **NULL**. When the transmit operation completes, the MNP updates the *Token.Status* field and the *Token.Event* is signaled.

**Note:** *There may be a performance penalty if the packet needs to be defragmented before it can be transmitted by the network device. Systems in which performance is critical should review the requirements and features of the underlying communications device and drivers.*

### Related Definitions

```
/**
//*****
// EFI_MANAGED_NETWORK_COMPLETION_TOKEN
//*****
typedef struct {
    EFI_EVENT      Event;
    EFI_STATUS     Status;
    union {
        EFI_MANAGED_NETWORK_RECEIVE_DATA *RxData;
        EFI_MANAGED_NETWORK_TRANSMIT_DATA *TxData;
    } Packet;
} EFI_MANAGED_NETWORK_COMPLETION_TOKEN;
```

<i>Event</i>	This <i>Event</i> will be signaled after the <i>Status</i> field is updated by the MNP. The type of <i>Event</i> must be <b>EVT_NOTIFY_SIGNAL</b> . The Task Priority Level (TPL) of <i>Event</i> must be lower than or equal to <b>TPL_CALLBACK</b> .
<i>Status</i>	This field will be set to one of the following values: <b>EFI_SUCCESS</b> : The receive or transmit completed successfully. <b>EFI_ABORTED</b> : The receive or transmit was aborted. <b>EFI_TIMEOUT</b> : The transmit timeout expired. <b>EFI_DEVICE_ERROR</b> : There was an unexpected system or network error. <b>EFI_NO_MEDIA</b> : There was a media error
<i>RxData</i>	When this token is used for receiving, <i>RxData</i> is a pointer to the <b>EFI_MANAGED_NETWORK_RECEIVE_DATA</b> .
<i>TxData</i>	When this token is used for transmitting, <i>TxData</i> is a pointer to the <b>EFI_MANAGED_NETWORK_TRANSMIT_DATA</b> .

The **EFI\_MANAGED\_NETWORK\_COMPLETION\_TOKEN** structure is used for both transmit and receive operations.

When it is used for transmitting, the *Event* and *TxData* fields must be filled in by the MNP client. After the transmit operation completes, the MNP updates the *Status* field and the *Event* is signaled.

When it is used for receiving, only the *Event* field must be filled in by the MNP client. After a packet is received, the MNP fills in the *RxData* and *Status* fields and the *Event* is signaled.

```

//*****
// EFI_MANAGED_NETWORK_RECEIVE_DATA
//*****
typedef struct {
    EFI_TIME   Timestamp;
    EFI_EVENT  RecycleEvent;
    UINT32    PacketLength;
    UINT32    HeaderLength;
    UINT32    AddressLength;
    UINT32    DataLength;
    BOOLEAN   BroadcastFlag;
    BOOLEAN   MulticastFlag;
    BOOLEAN   PromiscuousFlag;
    UINT16    ProtocolType;
    VOID      *DestinationAddress;
    VOID      *SourceAddress;
    VOID      *MediaHeader;
    VOID      *PacketData;
} EFI_MANAGED_NETWORK_RECEIVE_DATA;

```

<i>Timestamp</i>	System time when the MNP received the packet. <i>Timestamp</i> is zero filled if receive timestamps are disabled or unsupported.
<i>RecycleEvent</i>	MNP clients must signal this event after the received data has been processed so that the receive queue storage can be reclaimed. Once <i>RecycleEvent</i> is signaled, this structure and the received data that is pointed to by this structure must not be accessed by the client.
<i>PacketLength</i>	Length of the entire received packet (media header plus the data).
<i>HeaderLength</i>	Length of the media header in this packet.
<i>AddressLength</i>	Length of a MAC address in this packet.
<i>DataLength</i>	Length of the data in this packet.
<i>BroadcastFlag</i>	Set to <b>TRUE</b> if this packet was received through the broadcast filter. (The destination MAC address is the broadcast MAC address.)
<i>MulticastFlag</i>	Set to <b>TRUE</b> if this packet was received through the multicast filter. (The destination MAC address is in the multicast filter list.)
<i>PromiscuousFlag</i>	Set to <b>TRUE</b> if this packet was received through the promiscuous filter. (The destination address does not match any of the other hardware or software filter lists.)

<i>ProtocolType</i>	16-bit protocol type in host byte order. Zero if there is no protocol type field in the packet header.
<i>DestinationAddress</i>	Pointer to the destination address in the media header.
<i>SourceAddress</i>	Pointer to the source address in the media header.
<i>MediaHeader</i>	Pointer to the first byte of the media header.
<i>PacketData</i>	Pointer to the first byte of the packet data (immediately following media header).

An **EFI\_MANAGED\_NETWORK\_RECEIVE\_DATA** structure is filled in for each packet that is received by the MNP.

If multiple instances of this MNP driver can receive a packet, then the receive data structure and the received packet are duplicated for each instance of the MNP driver that can receive the packet.

```

//*****
// EFI_MANAGED_NETWORK_TRANSMIT_DATA
//*****
typedef struct {
EFI_MAC_ADDRESS      *DestinationAddress OPTIONAL;
EFI_MAC_ADDRESS      *SourceAddress  OPTIONAL;
UINT16               ProtocolType  OPTIONAL;
UINT32               DataLength;
UINT16               HeaderLength  OPTIONAL;
UINT16               FragmentCount;
EFI_MANAGED_NETWORK_FRAGMENT_DATA FragmentTable[1];
} EFI_MANAGED_NETWORK_TRANSMIT_DATA;

```

<i>DestinationAddress</i>	Pointer to the destination MAC address if the media header is not included in <i>FragmentTable[]</i> . If <b>NULL</b> , then the media header is already filled in <i>FragmentTable[]</i> .
<i>SourceAddress</i>	Pointer to the source MAC address if the media header is not included in <i>FragmentTable[]</i> . Ignored if <i>DestinationAddress</i> is <b>NULL</b> .
<i>ProtocolType</i>	The protocol type of the media header in host byte order. Ignored if <i>DestinationAddress</i> is <b>NULL</b> .
<i>DataLength</i>	Sum of all <i>FragmentLength</i> fields in <i>FragmentTable[]</i> minus the media header length.
<i>HeaderLength</i>	Length of the media header if it is included in the <i>FragmentTable</i> . Must be zero if <i>DestinationAddress</i> is not <b>NULL</b> .
<i>FragmentCount</i>	Number of data fragments in <i>FragmentTable[]</i> . This field cannot be zero.

*FragmentTable*

Table of data fragments to be transmitted. The first byte of the first entry in *FragmentTable[]* is also the first byte of the media header or, if there is no media header, the first byte of payload. Type **EFI\_MANAGED\_NETWORK\_FRAGMENT\_DATA** is defined below.

The **EFI\_MANAGED\_NETWORK\_TRANSMIT\_DATA** structure describes a (possibly fragmented) packet to be transmitted.

The *DataLength* field plus the *HeaderLength* field must be equal to the sum of all of the *FragmentLength* fields in the *FragmentTable*.

If the media header is included in *FragmentTable[]*, then it cannot be split between fragments.

```

//*****
// EFI_MANAGED_NETWORK_FRAGMENT_DATA
//*****
typedef struct {
    UINT32  FragmentLength;
    VOID    *FragmentBuffer;
} EFI_MANAGED_NETWORK_FRAGMENT_DATA;
    
```

*FragmentLength*

Number of bytes in the *FragmentBuffer*. This field may not be set to zero.

*FragmentBuffer*

Pointer to the fragment data. This field may not be set to **NULL**.

The **EFI\_MANAGED\_NETWORK\_FRAGMENT\_DATA** structure describes the location and length of a packet fragment to be transmitted.

**Status Codes Returned**

EFI_SUCCESS	The transmit completion token was cached.
EFI_NOT_STARTED	This MNP child driver instance has not been configured.

EFI_INVALID_PARAMETER	<p>One or more of the following conditions is <b>TRUE</b>:</p> <ul style="list-style-type: none"> <li>• <i>This</i> is <b>NULL</b>.</li> <li>• <i>Token</i> is <b>NULL</b>.</li> <li>• <i>Token.Event</i> is <b>NULL</b>.</li> <li>• <i>Token.TxData</i> is <b>NULL</b>.</li> <li>• <i>Token.TxData.DestinationAddress</i> is not <b>NULL</b> and <i>Token.TxData.HeaderLength</i> is zero.</li> <li>• <i>Token.TxData.FragmentCount</i> is zero.</li> <li>• <i>(Token.TxData.HeaderLength + Token.TxData.DataLength)</i> is not equal to the sum of the <i>Token.TxData.FragmentTable[j].FragmentLength</i> fields.</li> <li>• One or more of the <i>Token.TxData.FragmentTable[j].FragmentLength</i> fields is zero.</li> <li>• One or more of the <i>Token.TxData.FragmentTable[j].FragmentBuffer</i> fields is <b>NULL</b>.</li> <li>• <i>Token.TxData.DataLength</i> is greater than <i>MTU</i></li> </ul>
EFI_ACCESS_DENIED	The transmit completion token is already in the transmit queue.
EFI_OUT_OF_RESOURCES	The transmit data could not be queued due to a lack of system resources (usually memory).
EFI_DEVICE_ERROR	An unexpected system or network error occurred. The MNP child driver instance has been reset to startup defaults.
EFI_NOT_READY	The transmit request could not be queued because the transmit queue is full.
EFI_NO_MEDIA	There was a media error.

## EFI\_MANAGED\_NETWORK\_PROTOCOL.Receive()

### Summary

Places an asynchronous receiving request into the receiving queue.

### Prototype

```
typedef
EFI_STATUS
(EFIAPI *EFI_MANAGED_NETWORK_RECEIVE) (
  IN EFI_MANAGED_NETWORK_PROTOCOL *This,
  IN EFI_MANAGED_NETWORK_COMPLETION_TOKEN *Token
);
```

### Parameters

<i>This</i>	Pointer to the <b>EFI_MANAGED_NETWORK_PROTOCOL</b> instance.
<i>Token</i>	Pointer to a token associated with the receive data descriptor. Type <b>EFI_MANAGED_NETWORK_COMPLETION_TOKEN</b> is defined in <b>EFI_MANAGED_NETWORK_PROTOCOL.Transmit()</b> .

### Description

The **Receive()** function places a completion token into the receive packet queue. This function is always asynchronous.

The caller must fill in the *Token.Event* field in the completion token, and this field cannot be **NULL**. When the receive operation completes, the MNP updates the *Token.Status* and *Token.RxData* fields and the *Token.Event* is signaled.

### Status Codes Returned

EFI_SUCCESS	The receive completion token was cached.
EFI_NOT_STARTED	This MNP child driver instance has not been configured.
EFI_INVALID_PARAMETER	One or more of the following conditions is <b>TRUE</b> : <ul style="list-style-type: none"> <li><i>This</i> is <b>NULL</b>.</li> <li><i>Token</i> is <b>NULL</b>.</li> <li><i>Token.Event</i> is <b>NULL</b>.</li> </ul>
EFI_OUT_OF_RESOURCES	The transmit data could not be queued due to a lack of system resources (usually memory).
EFI_DEVICE_ERROR	An unexpected system or network error occurred. The MNP child driver instance has been reset to startup defaults.
EFI_ACCESS_DENIED	The receive completion token was already in the receive queue.
EFI_NOT_READY	The receive request could not be queued because the receive queue is full.

EFI_NO_MEDIA	There was a media error.
--------------	--------------------------



## EFI\_MANAGED\_NETWORK\_PROTOCOL.Cancel()

### Summary

Aborts an asynchronous transmit or receive request.

### Prototype

```
typedef
EFI_STATUS
(EFIAPI *EFI_MANAGED_NETWORK_CANCEL)(
  IN EFI_MANAGED_NETWORK_PROTOCOL *This,
  IN EFI_MANAGED_NETWORK_COMPLETION_TOKEN *Token OPTIONAL
);
```

### Parameters

<i>This</i>	Pointer to the <b>EFI_MANAGED_NETWORK_PROTOCOL</b> instance.
<i>Token</i>	Pointer to a token that has been issued by <b>EFI_MANAGED_NETWORK_PROTOCOL.Transmit()</b> or <b>EFI_MANAGED_NETWORK_PROTOCOL.Receive()</b> . If <b>NULL</b> , all pending tokens are aborted. Type <b>EFI_MANAGED_NETWORK_COMPLETION_TOKEN</b> is defined in <b>EFI_MANAGED_NETWORK_PROTOCOL.Transmit()</b> .

### Description

The **Cancel()** function is used to abort a pending transmit or receive request. If the token is in the transmit or receive request queues, after calling this function, *Token.Status* will be set to **EFI\_ABORTED** and then *Token.Event* will be signaled. If the token is not in one of the queues, which usually means that the asynchronous operation has completed, this function will not signal the token and **EFI\_NOT\_FOUND** is returned.

### Status Codes Returned

EFI_SUCCESS	The asynchronous I/O request was aborted and <i>Token.Event</i> was signaled. When <i>Token</i> is <b>NULL</b> , all pending requests were aborted and their events were signaled.
EFI_NOT_STARTED	This MNP child driver instance has not been configured.
EFI_INVALID_PARAMETER	<i>This</i> is <b>NULL</b> .
EFI_NOT_FOUND	When <i>Token</i> is not <b>NULL</b> , the asynchronous I/O request was not found in the transmit or receive queue. It has either completed or was not issued by <b>Transmit()</b> and <b>Receive()</b> .

## EFI\_MANAGED\_NETWORK\_PROTOCOL.Poll()

### Summary

Polls for incoming data packets and processes outgoing data packets.

### Prototype

```
typedef
EFI_STATUS
(EFIAPI *EFI_MANAGED_NETWORK_POLL) (
    IN EFI_MANAGED_NETWORK_PROTOCOL *This
);
```

### Parameters

*This* Pointer to the **EFI\_MANAGED\_NETWORK\_PROTOCOL** instance.

### Description

The **Poll()** function can be used by network drivers and applications to increase the rate that data packets are moved between the communications device and the transmit and receive queues.

Normally, a periodic timer event internally calls the **Poll()** function. But, in some systems, the periodic timer event may not call **Poll()** fast enough to transmit and/or receive all data packets without missing packets. Drivers and applications that are experiencing packet loss should try calling the **Poll()** function more often.

### Status Codes Returned

EFI_SUCCESS	Incoming or outgoing data was processed.
EFI_NOT_STARTED	This MNP child driver instance has not been configured.
EFI_DEVICE_ERROR	An unexpected system or network error occurred. The MNP child driver instance has been reset to startup defaults.
EFI_NOT_READY	No incoming or outgoing data was processed. Consider increasing the polling rate.
EFI_TIMEOUT	Data was dropped out of the transmit and/or receive queue. Consider increasing the polling rate.

## 26 Network Protocols — VLAN, EAP, Wi-Fi and Supplicant

---

### 26.1 VLAN Configuration Protocol

#### EFI\_VLAN\_CONFIG\_PROTOCOL

##### Summary

This protocol is to provide manageability interface for VLAN configuration.

##### GUID

```
#define EFI_VLAN_CONFIG_PROTOCOL_GUID \
  {0x9e23d768, 0xd2f3, 0x4366, \
   {0x9f, 0xc3, 0x3a, 0x7a, 0xba, 0x86, 0x43, 0x74}}
```

##### Protocol Interface Structure

```
typedef struct _EFI_VLAN_CONFIG_PROTOCOL {
  EFI_VLAN_CONFIG_SET   Set;
  EFI_VLAN_CONFIG_FIND  Find;
  EFI_VLAN_CONFIG_REMOVE Remove;
} EFI_VLAN_CONFIG_PROTOCOL;
```

##### Parameters

<i>Set</i>	Create new VLAN device or modify configuration parameter of an already-configured VLAN
<i>Find</i>	Find configuration information for specified VLAN or all configured VLANs.
<i>Remove</i>	Remove a VLAN device.

##### Description

This protocol is to provide manageability interface for VLAN setting. The intended VLAN tagging implementation is IEEE802.1Q.

## EFI\_VLAN\_CONFIG\_PROTOCOL.Set ()

### Summary

Create a VLAN device or modify the configuration parameter of an already-configured VLAN

### Prototype

```
typedef
EFI_STATUS
(EFIAPI * EFI_VLAN_CONFIG_SET) (
  IN EFI_VLAN_CONFIG_PROTOCOL This,
  IN UINT16      VlanId,
  IN UINT8      Priority
);
```

### Parameters

<i>This</i>	Pointer to <b>EFI_VLAN_CONFIG_PROTOCOL</b> instance.
<i>VlanId</i>	A unique identifier (1-4094) of the VLAN which is being created or modified, or zero (0).
<i>Priority</i>	3 bit priority in VLAN header. Priority 0 is default value. If <i>VlanId</i> is zero (0), <i>Priority</i> is ignored.

### Description

The **Set()** function is used to create a new VLAN device or change the VLAN configuration parameters. If the *VlanId* hasn't been configured in the physical Ethernet device, a new VLAN device will be created. If a VLAN with this *VlanId* is already configured, then related configuration will be updated as the input parameters.

If *VlanId* is zero, the VLAN device will send and receive untagged frames. Otherwise, the VLAN device will send and receive VLAN-tagged frames containing the *VlanId*.

If *VlanId* is out of scope of (0-4094), **EFI\_INVALID\_PARAMETER** is returned

If *Priority* is out of the scope of (0-7), then **EFI\_INVALID\_PARAMETER** is returned.

If there is not enough system memory to perform the registration, then **EFI\_OUT\_OF\_RESOURCES** is returned.

### Status Codes Returned

EFI_SUCCESS	The VLAN is successfully configured
EFI_INVALID_PARAMETER	One or more of following conditions is TRUE <ul style="list-style-type: none"> <li>• <i>This</i> is NULL</li> <li>• <i>VlanId</i> is an invalid VLAN Identifier</li> <li>• <i>Priority</i> is invalid</li> </ul>

EFI_OUT_OF_RESOURCES	There is not enough system memory to perform the registration.
----------------------	--

## EFI\_VLAN\_CONFIG\_PROTOCOL.Find()

### Summary

Find configuration information for specified VLAN or all configured VLANs.

### Prototype

```
typedef
EFI_STATUS
(EFI_API *EFI_VLAN_CONFIG_FIND) (
  IN EFI_VLAN_CONFIG_PROTOCOL      *This,
  IN UINT16      *VlanId, OPTIONAL
  OUT UINT16      *NumberOfVlan,
  OUT EFI_VLAN_FIND_DATA  **Entries
);
```

### Parameters

<i>This</i>	Pointer to <b>EFI_VLAN_CONFIG_PROTOCOL</b> instance.
<i>VlanId</i>	Pointer to VLAN identifier. Set to <b>NULL</b> to find all configured VLANs
<i>NumberOfVlan</i>	The number of VLANs which is found by the specified criteria
<i>Entries</i>	The buffer which receive the VLAN configuration. Type <b>EFI_VLAN_FIND_DATA</b> is defined below.

### Description

The **Find()** function is used to find the configuration information for matching VLAN and allocate a buffer into which those entries are copied.

### Related Definitions

```
/**
//*****
// EFI_VLAN_FIND_DATA
//*****
typedef struct {
  UINT16  VlanId;
  UINT8   Priority;
} EFI_VLAN_FIND_DATA;
```

<i>VlanId</i>	Vlan Identifier
<i>Priority</i>	Priority of this VLAN

## Status Codes Returned

EFI_SUCCESS	The VLAN is successfully found
EFI_INVALID_PARAMETER	One or more of following conditions is <b>TRUE</b> <ul style="list-style-type: none"><li>• <i>This</i> is <b>NULL</b></li><li>• Specified <i>VlanId</i> is invalid</li></ul>
EFI_NOT_FOUND	No matching VLAN is found

## EFI\_VLAN\_CONFIG\_PROTOCOL.Remove ()

### Summary

Remove the configured VLAN device

### Prototype

```
typedef
EFI_STATUS
(EFIAPI * EFI_VLAN_CONFIG_REMOVE) (
  IN EFI_VLAN_CONFIG_PROTOCOL *This,
  IN UINT16      VlanId
);
```

### Parameters

*This* Pointer to **EFI\_VLAN\_CONFIG\_PROTOCOL** instance.

*VlanId* Identifier (0-4094) of the VLAN to be removed.

### Description

The **Remove()** function is used to remove the specified VLAN device. If the *VlanId* is out of the scope of (0-4094), **EFI\_INVALID\_PARAMETER** is returned. If specified VLAN hasn't been previously configured, **EFI\_NOT\_FOUND** is returned.

### Status Codes Returned

EFI_SUCCESS	The VLAN is successfully removed
EFI_INVALID_PARAMETER	One or more of following conditions is <b>TRUE</b> <ul style="list-style-type: none"> <li>• <i>This</i> is <b>NULL</b></li> <li>• <i>VlanId</i> is an invalid parameter.</li> </ul>
EFI_NOT_FOUND	The to-be-removed VLAN does not exist

## 26.2 EAP Protocol

This section defines the EAP protocol. This protocol is designed to make the EAP framework configurable and extensible. It is intended for the supplicant side.

### EFI\_EAP\_PROTOCOL

#### Summary

This protocol is used to abstract the ability to configure and extend the EAP framework.



## GUID

```
#define EFI_EAP_PROTOCOL_GUID \
  { 0x5d9f96db, 0xe731, 0x4caa, \
    {0xa0, 0x0d, 0x72, 0xe1, 0x87, 0xcd, 0x77, 0x62 } }
```

## Protocol Interface Structure

```
typedef struct _EFI_EAP_PROTOCOL {
  EFI_EAP_SET_DESIRED_AUTHENTICATION_METHOD SetDesiredAuthMethod;
  EFI_EAP_REGISTER_AUTHENTICATION_METHOD RegisterAuthMethod;
} EFI_EAP_PROTOCOL;
```

## Parameters

- SetDesiredAuthMethod* Set the desired EAP authentication method for the Port. See the **SetDesiredAuthMethod()** function description.
- RegisterAuthMethod* Register an EAP authentication method. See the **RegisterAuthMethod()** function description.

## Description

**EFI\_EAP\_PROTOCOL** is used to configure the desired EAP authentication method for the EAP framework and extend the EAP framework by registering new EAP authentication method on a Port. The EAP framework is built on a per-Port basis. Herein, a Port means a NIC. For the details of EAP protocol, please refer to RFC 2284.

## Related Definitions

```
//
// Type for the identification number assigned to the Port by the // System in which
// the Port resides.
//
typedef VOID * EFI_PORT_HANDLE;
```

## EFI\_EAP.SetDesiredAuthMethod()

### Summary

Set the desired EAP authentication method for the Port.

### Prototype

```
typedef
EFI_STATUS
(EFI_API *EFI_EAP_SET_DESIRED_AUTHENTICATION_METHOD) (
  IN struct _EFI_EAP_PROTOCOL *This,
  IN UINT8      EapAuthType
);
```

### Parameters

<i>This</i>	A pointer to the <b>EFI_EAP_PROTOCOL</b> instance that indicates the calling context. Type <b>EFI_EAP_PROTOCOL</b> is defined in Section 1.1.
<i>EapAuthType</i>	The type of the desired EAP authentication method for the Port. It should be the type value defined by RFC. See RFC 2284 for details. Current valid values are defined in "Related Definitions".

### Related Definitions

```
//
// EAP Authentication Method Type (RFC 3748)
//
#define EFI_EAP_TYPE_TLS 13 /* REQUIRED - RFC 5216 */
```

### Description

The **SetDesiredAuthMethod()** function sets the desired EAP authentication method indicated by *EapAuthType* for the Port.

If *EapAuthType* is an invalid EAP authentication type, then **EFI\_INVALID\_PARAMETER** is returned.

If the EAP authentication method of *EapAuthType* is unsupported, then it will return **EFI\_UNSUPPORTED**.

The cryptographic strength of **EFI\_EAP\_TYPE\_TLS** shall be at least of hash strength SHA-256 and RSA key length of at least 2048 bits.

### Status Codes Returned

EFI_SUCCESS	The desired EAP authentication method is set successfully.
EFI_INVALID_PARAMETER	<i>EapAuthType</i> is an invalid EAP authentication type.
EFI_UNSUPPORTED	The EAP authentication method of <i>EapAuthType</i> is unsupported by the Port.

## EFI\_EAP.RegisterAuthMethod()

### Summary

Register an EAP authentication method.

### Prototype

```
typedef
EFI_STATUS
(EFI_API *EFI_EAP_REGISTER_AUTHENTICATION_METHOD) (
    IN struct _EFI_EAP_PROTOCOL    *This,
    IN UINT8                      EapAuthType,
    IN EFI_EAP_BUILD_RESPONSE_PACKET Handler
);
```

### Parameters

<i>This</i>	A pointer to the <b>EFI_EAP_PROTOCOL</b> instance that indicates the calling context. Type <b>EFI_EAP_PROTOCOL</b> is defined in Section 1.1.
<i>EapAuthType</i>	The type of the EAP authentication method to register. It should be the type value defined by RFC. See RFC 2284 for details. Current valid values are defined in the <b>SetDesiredAuthMethod()</b> function description.
<i>Handler</i>	The handler of the EAP authentication method to register. Type <b>EFI_EAP_BUILD_RESPONSE_PACKET</b> is defined in “Related Definitions”.

## Related Definitions

```
typedef
EFI_STATUS
(EFIAPI *EFI_EAP_BUILD_RESPONSE_PACKET) (
IN EFI_PORT_HANDLE   PortNumber
IN UINT8             *RequestBuffer,
IN UINTN             RequestSize,
IN UINT8             *Buffer,
IN OUT UINTN         *BufferSize
)
```

```
/*++
```

### Routine Description:

Build EAP response packet in response to the EAP request packet specified by (RequestBuffer, RequestSize).

### Arguments:

PortNumber - Specified the Port where the EAP request packet comes.  
RequestBuffer - Pointer to the most recently received EAP-Request packet.  
RequestSize - Packet size in bytes for the most recently received EAP-Request packet.  
Buffer - Pointer to the buffer to hold the built packet.  
BufferSize - Pointer to the buffer size in bytes. On input, it is the buffer size provided by the caller. On output, it is the buffer size in fact needed to contain the packet.

### Returns:

EFI\_SUCCESS - The required EAP response packet is built successfully.  
others - Failures are encountered during the packet building process.

```
--*/
;
```

## Description

The **RegisterAuthMethod()** function registers the user provided EAP authentication method, the type of which is *EapAuthType* and the handler of which is *Handler*.

If *EapAuthType* is an invalid EAP authentication type, then **EFI\_INVALID\_PARAMETER** is returned.

If there is not enough system memory to perform the registration, then **EFI\_OUT\_OF\_RESOURCES** is returned.

## Status Codes Returned

EFI_SUCCESS	The EAP authentication method of <i>EapAuthType</i> is registered successfully.
EFI_INVALID_PARAMETER	<i>EapAuthType</i> is an invalid EAP authentication type.
EFI_OUT_OF_RESOURCES	There is not enough system memory to perform the registration.

### 26.2.1 EAPManagement Protocol

This section defines the EAP management protocol. This protocol is designed to provide ease of management and ease of test for EAPOL state machine. It is intended for the supplicant side. It conforms to IEEE 802.1x specification.

## EFI\_EAP\_MANAGEMENT\_PROTOCOL

### Summary

This protocol provides the ability to configure and control EAPOL state machine, and retrieve the status and the statistics information of EAPOL state machine.

### GUID

```
#define EFI_EAP_MANAGEMENT_PROTOCOL_GUID \
{ 0xbb62e663, 0x625d, 0x40b2, \
  { 0xa0, 0x88, 0xbb, 0xe8, 0x36, 0x23, 0xa2, 0x45 } }
```

### Protocol Interface Structure

```
typedef struct _EFI_EAP_MANAGEMENT_PROTOCOL {
  EFI_EAP_GET_SYSTEM_CONFIGURATION  GetSystemConfiguration;
  EFI_EAP_SET_SYSTEM_CONFIGURATION  SetSystemConfiguration;
  EFI_EAP_INITIALIZE_PORT           InitializePort;
  EFI_EAP_USER_LOGON                UserLogon;
  EFI_EAP_USER_LOGOFF               UserLogoff;
  EFI_EAP_GET_SUPPLICANT_STATUS     GetSupplicantStatus;
  EFI_EAP_SET_SUPPLICANT_CONFIGURATION SetSupplicantConfiguration;
  EFI_EAP_GET_SUPPLICANT_STATISTICS GetSupplicantStatistics;
} EFI_EAP_MANAGEMENT_PROTOCOL;
```

### Parameters

- GetSystemConfiguration* Read the system configuration information associated with the Port. See the **GetSystemConfiguration()** function description.
- SetSystemConfiguration* Set the system configuration information associated with the Port. See the **SetSystemConfiguration()** function description.
- InitializePort* Cause the EAPOL state machines for the Port to be initialized. See the **InitializePort()** function description.

<i>UserLogon</i>	Notify the EAPOL state machines for the Port that the user of the System has logged on. See the <b>UserLogon()</b> function description.
<i>UserLogoff</i>	Notify the EAPOL state machines for the Port that the user of the System has logged off. See the <b>UserLogoff()</b> function description.
<i>GetSupplicantStatus</i>	Read the status of the Supplicant PAE state machine for the Port, including the current state and the configuration of the operational parameters. See the <b>GetSupplicantStatus()</b> function description.
<i>SetSupplicantConfiguration</i>	Set the configuration of the operational parameter of the Supplicant PAE state machine for the Port. See the <b>SetSupplicantConfiguration()</b> function description.
<i>GetSupplicantStatistics</i>	Read the statistical information regarding the operation of the Supplicant associated with the Port. See the <b>GetSupplicantStatistics()</b> function description.

## Description

The **EFI\_EAP\_MANAGEMENT** protocol is used to control, configure and monitor EAPOL state machine on a Port. EAPOL state machine is built on a per-Port basis. Herein, a Port means a NIC. For the details of EAPOL, please refer to IEEE 802.1x specification.

## EFI\_EAP\_MANAGEMENT.GetSystemConfiguration()

### Summary

Read the system configuration information associated with the Port.

### Prototype

```
typedef
EFI_STATUS
(EFIAPI *EFI_EAP_GET_SYSTEM_CONFIGURATION) (
  IN struct _EFI_EAP_MANAGEMENT_PROTOCOL *This,
  OUT BOOLEAN          *SystemAuthControl,
  OUT EFI_EAPOL_PORT_INFO *PortInfo OPTIONAL
);
```

### Parameters

<i>This</i>	A pointer to the <b>EFI_EAP_MANAGEMENT_PROTOCOL</b> instance that indicates the calling context. Type <b>EFI_EAP_MANAGEMENT_PROTOCOL</b> is defined in <a href="#">Section 26.2.1</a> .
<i>SystemAuthControl</i>	Returns the value of the SystemAuthControl parameter of the System. <b>TRUE</b> means Enabled. <b>FALSE</b> means Disabled.
<i>PortInfo</i>	Returns <b>EFI_EAPOL_PORT_INFO</b> structure to describe the Port's information. This parameter can be <b>NULL</b> to ignore reading the Port's information. Type <b>EFI_EAPOL_PORT_INFO</b> is defined in "Related Definitions".

### Related Definitions

```
//
// PAE Capabilities
//
#define PAE_SUPPORT_AUTHENTICATOR  0x01
#define PAE_SUPPORT_SUPPLICANT    0x02

typedef struct _EFI_EAPOL_PORT_INFO {
  EFI_PORT_HANDLE  PortNumber;
  UINT8           ProtocolVersion;
  UINT8           PaeCapabilities;
} EFI_EAPOL_PORT_INFO;
```

<i>PortNumber</i>	The identification number assigned to the Port by the System in which the Port resides.
<i>ProtocolVersion</i>	The protocol version number of the EAPOL implementation supported by the Port.

*PaeCapabilities*

The capabilities of the PAE associated with the Port. This field indicates whether Authenticator functionality, Supplicant functionality, both, or neither, is supported by the Port's PAE.

**Description**

The **GetSystemConfiguration()** function reads the system configuration information associated with the Port, including the value of the SystemAuthControl parameter of the System is returned in *SystemAuthControl* and the Port's information is returned in the buffer pointed to by *PortInfo*. The Port's information is optional. If *PortInfo* is **NULL**, then reading the Port's information is ignored.

If *SystemAuthControl* is **NULL**, then **EFI\_INVALID\_PARAMETER** is returned.

**Status Codes Returned**

EFI_SUCCESS	The system configuration information of the Port is read successfully.
EFI_INVALID_PARAMETER	<i>SystemAuthControl</i> is <b>NULL</b> .



## EFI\_EAP\_MANAGEMENT.SetSystemConfiguration()

### Summary

Set the system configuration information associated with the Port.

### Prototype

```
typedef
EFI_STATUS
(EFIAPI *EFI_EAP_SET_SYSTEM_CONFIGURATION) (
  IN struct _EFI_EAP_MANAGEMENT_PROTOCOL *This,
  IN BOOLEAN      SystemAuthControl
);
```

### Parameters

<b>This</b>	A pointer to the <b>EFI_EAP_MANAGEMENT_PROTOCOL</b> instance that indicates the calling context. Type <b>EFI_EAP_MANAGEMENT_PROTOCOL</b> is defined in <a href="#">Section 26.2.1</a> .
<b>SystemAuthControl</b>	The desired value of the SystemAuthControl parameter of the System. <b>TRUE</b> means Enabled. <b>FALSE</b> means Disabled.

### Description

The **SetSystemConfiguration()** function sets the value of the SystemAuthControl parameter of the System to *SystemAuthControl*.

### Status Codes Returned

EFI_SUCCESS	The system configuration information of the Port is set successfully.
-------------	---

## EFI\_EAP\_MANAGEMENT.InitializePort()

### Summary

Cause the EAPOL state machines for the Port to be initialized.

### Prototype

```
typedef
EFI_STATUS
(EFI_API *EFI_EAP_INITIALIZE_PORT) (
  IN struct _EFI_EAP_MANAGEMENT_PROTOCOL *This
);
```

### Parameters

*This*

A pointer to the **EFI\_EAP\_MANAGEMENT\_PROTOCOL** instance that indicates the calling context. Type **EFI\_EAP\_MANAGEMENT\_PROTOCOL** is defined in [Section 26.2.1](#).

### Description

The **InitializePort()** function causes the EAPOL state machines for the Port.

### Status Codes Returned

EFI_SUCCESS	The Port is initialized successfully.
-------------	---------------------------------------

## EFI\_EAP\_MANAGEMENT.UserLogon()

### Summary

Notify the EAPOL state machines for the Port that the user of the System has logged on.

### Prototype

```
typedef
EFI_STATUS
(EFIAPI *EFI_EAP_USER_LOGON) (
  IN struct _EFI_EAP_MANAGEMENT_PROTOCOL *This,
);
```

### Parameters

*This*

A pointer to the **EFI\_EAP\_MANAGEMENT\_PROTOCOL** instance that indicates the calling context. Type **EFI\_EAP\_MANAGEMENT\_PROTOCOL** is defined in [Section 26.2.1](#).

### Description

The **UserLogon()** function notifies the EAPOL state machines for the Port.

### Status Codes Returned

EFI_SUCCESS	The Port is notified successfully.
-------------	------------------------------------

## EFI\_EAP\_MANAGEMENT.UserLogoff()

### Summary

Notify the EAPOL state machines for the Port that the user of the System has logged off.

### Prototype

```
typedef
EFI_STATUS
(EFIAPI *EFI_EAP_USER_LOGOFF) (
  IN struct _EFI_EAP_MANAGEMENT_PROTOCOL *This,
  );
```

### Parameters

*This*

A pointer to the **EFI\_EAP\_MANAGEMENT\_PROTOCOL** instance that indicates the calling context. Type **EFI\_EAP\_MANAGEMENT\_PROTOCOL** is defined in [Section 26.2.1](#).

### Description

The **UserLogoff()** function notifies the EAPOL state machines for the Port.

### Status Codes Returned

EFI_SUCCESS	The Port is notified successfully.
-------------	------------------------------------

## EFI\_EAP\_MANAGEMENT.GetSupplicantStatus()

### Summary

Read the status of the Supplicant PAE state machine for the Port, including the current state and the configuration of the operational parameters.

### Prototype

```
typedef
EFI_STATUS
(EFIAPI *EFI_EAP_GET_SUPPLICANT_STATUS) (
  IN struct _EFI_EAP_MANAGEMENT_PROTOCOL *This,
  OUT EFI_EAPOL_SUPPLICANT_PAE_STATE *CurrentState,
  IN OUT EFI_EAPOL_SUPPLICANT_PAE_CONFIGURATION *Configuration
  OPTIONAL
);
```

### Parameters

<i>This</i>	A pointer to the <b>EFI_EAP_MANAGEMENT_PROTOCOL</b> instance that indicates the calling context. Type <b>EFI_EAP_MANAGEMENT_PROTOCOL</b> is defined in <a href="#">Section 26.2.1</a> .
<i>CurrentState</i>	Returns the current state of the Supplicant PAE state machine for the Port. Type <b>EFI_EAPOL_SUPPLICANT_PAE_STATE</b> is defined in "Related Definitions".
<i>Configuration</i>	Returns the configuration of the operational parameters of the Supplicant PAE state machine for the Port as required. This parameter can be <b>NULL</b> to ignore reading the configuration. On input, <i>Configuration.ValidFieldMask</i> specifies the operational parameters to be read. On output, <i>Configuration</i> returns the configuration of the required operational parameters. Type <b>EFI_EAPOL_SUPPLICANT_PAE_CONFIGURATION</b> is defined in "Related Definitions".

## Related Definitions

```
//
// Supplicant PAE state machine (IEEE Std 802.1X Section 8.5.10)
//
typedef enum _EFI_EAPOL_SUPPLICANT_PAE_STATE {
  Logoff,
  Disconnected,
  Connecting,
  Acquired,
  Authenticating,
  Held,
  Authenticated,
  MaxSupplicantPaeState
} EFI_EAPOL_SUPPLICANT_PAE_STATE;

//
// Definitions for ValidFieldMask
//
#define AUTH_PERIOD_FIELD_VALID  0x01
#define HELD_PERIOD_FIELD_VALID  0x02
#define START_PERIOD_FIELD_VALID 0x04
#define MAX_START_FIELD_VALID    0x08

typedef struct _EFI_EAPOL_SUPPLICANT_PAE_CONFIGURATION {
  UINT8  ValidFieldMask;
  UINTN  AuthPeriod;
  UINTN  HeldPeriod;
  UINTN  StartPeriod;
  UINTN  MaxStart;
} EFI_EAPOL_SUPPLICANT_PAE_CONFIGURATION;
```

<b>ValidFieldMask</b>	Indicates which of the following fields are valid.
<b>AuthPeriod</b>	The initial value for the authWhile timer. Its default value is 30 s.
<b>HeldPeriod</b>	The initial value for the heldWhile timer. Its default value is 60 s.
<b>StartPeriod</b>	The initial value for the startWhen timer. Its default value is 30 s.
<b>MaxStart</b>	The maximum number of successive EAPOL-Start messages will be sent before the Supplicant assumes that there is no Authenticator present. Its default value is 3.

## Description

The **GetSupplicantStatus()** function reads the status of the Supplicant PAE state machine for the Port, including the current state *CurrentState* and the configuration of the

operational parameters *Configuration*. The configuration of the operational parameters is optional. If *Configuration* is **NULL**, then reading the configuration is ignored. The operational parameters in *Configuration* to be read can also be specified by *Configuration.ValidFieldMask*.

If *CurrentState* is **NULL**, then **EFI\_INVALID\_PARAMETER** is returned.

### Status Codes Returned

EFI_SUCCESS	The status of the Supplicant PAE state machine for the Port is read successfully.
EFI_INVALID_PARAMETER	<i>CurrentState</i> is <b>NULL</b> .

## EFI\_EAP\_MANAGEMENT.SetSupplicantConfiguration()

### Summary

Set the configuration of the operational parameter of the Supplicant PAE state machine for the Port.

### Prototype

```
typedef
EFI_STATUS
(EFIAPI *EFI_EAP_SET_SUPPLICANT_CONFIGURATION) (
  IN struct _EFI_EAP_MANAGEMENT_PROTOCOL *This,
  IN EFI_EAPOL_SUPPLICANT_PAE_CONFIGURATION *Configuration
);
```

### Parameters

*This*

A pointer to the **EFI\_EAP\_MANAGEMENT\_PROTOCOL** instance that indicates the calling context. Type **EFI\_EAP\_MANAGEMENT\_PROTOCOL** is defined in [Section 26.2.1](#).

*Configuration*

The desired configuration of the operational parameters of the Supplicant PAE state machine for the Port as required. Type **EFI\_EAPOL\_SUPPLICANT\_PAE\_CONFIGURATION** is defined in the **GetSupplicantStatus()** function description.

### Description

The **SetSupplicantConfiguration()** function sets the configuration of the operational parameter of the Supplicant PAE state machine for the Port to *Configuration*. The operational parameters in *Configuration* to be set can be specified by *Configuration.ValidFieldMask*.

If *Configuration* is **NULL**, then **EFI\_INVALID\_PARAMETER** is returned.

### Status Codes Returned

EFI_SUCCESS	The configuration of the operational parameter of the Supplicant PAE state machine for the Port is set successfully.
EFI_INVALID_PARAMETER	<i>Configuration</i> is <b>NULL</b> .



## EFI\_EAP\_MANAGEMENT.GetSupplicantStatistics()

### Summary

Read the statistical information regarding the operation of the Supplicant associated with the Port.

### Prototype

```
typedef
EFI_STATUS
(EFIAPI *EFI_EAP_GET_SUPPLICANT_STATISTICS) (
  IN struct _EFI_EAP_MANAGEMENT_PROTOCOL *This,
  OUT EFI_EAPOL_SUPPLICANT_PAE_STATISTICS *Statistics
);
```

### Parameters

<b>This</b>	A pointer to the <b>EFI_EAP_MANAGEMENT_PROTOCOL</b> instance that indicates the calling context. Type <b>EFI_EAP_MANAGEMENT_PROTOCOL</b> is defined in <a href="#">Section 26.2.1</a> .
<i>Statistics</i>	Returns the statistical information regarding the operation of the Supplicant for the Port. Type <b>EFI_EAPOL_SUPPLICANT_PAE_STATISTICS</b> is defined in "Related Definitions".

### Related Definitions

```
//
// Supplicant Statistics (IEEE Std 802.1X Section 9.5.2)
//
typedef struct _EFI_EAPOL_SUPPLICANT_PAE_STATISTICS {
  UINTN  EapolFramesReceived;
  UINTN  EapolFramesTransmitted;
  UINTN  EapolStartFramesTransmitted;
  UINTN  EapolLogoffFramesTransmitted;
  UINTN  EapolRespIdFramesTransmitted;
  UINTN  EapolResponseFramesTransmitted;
  UINTN  EapolReqIdFramesReceived;
  UINTN  EapolRequestFramesReceived;
  UINTN  InvalidEapolFramesReceived;
  UINTN  EapolLengthErrorFramesReceived;
  UINTN  LastEapolFrameVersion;
  UINTN  LastEapolFrameSource;
} EFI_EAPOL_SUPPLICANT_PAE_STATISTICS;
```

**EapolFramesReceived**

The number of EAPOL frames of any type that have been received by this Supplicant.

**EapolFramesTransmitted**

The number of EAPOL frames of any type that have been transmitted by this Supplicant.

**EapolStartFramesTransmitted**

The number of EAPOL Start frames that have been transmitted by this Supplicant.

**EapolLogoffFramesTransmitted**

The number of EAPOL Logoff frames that have been transmitted by this Supplicant.

**EapRespIdFramesTransmitted**

The number of EAP Resp/Id frames that have been transmitted by this Supplicant.

**EapResponseFramesTransmitted**

The number of valid EAP Response frames (other than Resp/Id frames) that have been transmitted by this Supplicant.

**EapReqIdFramesReceived**

The number of EAP Req/Id frames that have been received by this Supplicant.

**EapRequestFramesReceived**

The number of EAP Request frames (other than Rq/Id frames) that have been received by this Supplicant.

**InvalidEapolFramesReceived**

The number of EAPOL frames that have been received by this Supplicant in which the frame type is not recognized.

**EapLengthErrorFramesReceived**

The number of EAPOL frames that have been received by this Supplicant in which the Packet Body Length field (7.5.5) is invalid.

**LastEapolFrameVersion**

The protocol version number carried in the most recently received EAPOL frame.

**LastEapolFrameSource**

The source MAC address carried in the most recently received EAPOL frame.

**Description**

The **GetSupplicantStatistics()** function reads the statistical information *Statistics* regarding the operation of the Supplicant associated with the Port.

If *Statistics* is **NULL**, then **EFI\_INVALID\_PARAMETER** is returned.

## Status Codes Returned

EFI_SUCCESS	The statistical information regarding the operation of the Supplicant for the Port is read successfully.
EFI_INVALID_PARAMETER	<i>Statistics</i> is <b>NULL</b> .

## 26.2.2 EFI EAP Management2 Protocol

### EFI\_EAP\_MANAGEMENT2\_PROTOCOL

#### Summary

This protocol provides the ability to configure and control EAPOL state machine, and retrieve the information, status and the statistics information of EAPOL state machine.

#### GUID

```
#define EFI_EAP_MANAGEMENT2_PROTOCOL_GUID \
{ 0x5e93c847, 0x456d, 0x40b3, \
  { 0xa6, 0xb4, 0x78, 0xb0, 0xc9, 0xcf, 0x7f, 0x20 }}
```

#### Protocol Interface Structure

```
typedef struct _EFI_EAP_MANAGEMENT2_PROTOCOL {
  ..... // Same as EFI_EAP_MANAGEMENT_PROTOCOL
  EFI_EAP_GET_KEY    GetKey;
} EFI_EAP_MANAGEMENT2_PROTOCOL;
```

#### Parameters

*GetKey*

Provide Key information parsed from EAP packet. See the **GetKey()** function description.

#### Description

The **EFI\_EAP\_MANAGEMENT2\_PROTOCOL** is used to control, configure and monitor EAPOL state machine on a Port, and return information of the Port. EAPOL state machine is built on a per-Port basis. Herein, a Port means a NIC. For the details of EAPOL, please refer to IEEE 802.1x specification.

## EFI\_EAP\_MANAGEMENT2\_PROTOCOL.GetKey()

### Summary

Return key generated through EAP process.

### Prototype

```
typedef
EFI_STATUS
(EFI_API *EFI_EAP_GET_KEY)(
  IN EFI_EAP_MANAGEMENT2_PROTOCOL *This,
  IN OUT UINT8 *Msk,
  IN OUT UINTN *MskSize,
  IN OUT UINT8 *Emsk,
  IN OUT UINT8 *EmskSize
);
```

### Parameters

<i>This</i>	Pointer to the <b>EFI_EAP_MANAGEMENT2_PROTOCOL</b> instance.
<i>Msk</i>	Pointer to MSK (Master Session Key) buffer.
<i>MskSize</i>	MSK buffer size.
<i>Emsk</i>	Pointer to EMSK (Extended Master Session Key) buffer.
<i>EmskSize</i>	EMSK buffer size.

### Description

The **GetKey()** function return the key generated through EAP process, so that the 802.11 MAC layer driver can use MSK to derive more keys, e.g. PMK (Pairwise Master Key).

### Status Codes Returned

EFI_SUCCESS	The operation completed successfully.
EFI_INVALID_PARAMETER	One or more of the following conditions is TRUE: <ul style="list-style-type: none"> <li>• <i>Msk</i> is NULL.</li> <li>• <i>MskSize</i> is NULL.</li> <li>• <i>Emsk</i> is NULL.</li> <li>• <i>EmskSize</i> is NULL.</li> </ul>
EFI_NOT_READY	MSK and EMSK are not generated in current session yet.

## 26.2.3 EFI EAP Configuration Protocol

### EFI\_EAP\_CONFIGURATION\_PROTOCOL

#### Summary

This protocol provides a way to set and get EAP configuration.

## GUID

```
#define EFI_EAP_CONFIGURATION_PROTOCOL_GUID \
{ 0xe5b58dbb, 0x7688, 0x44b4, \
  { 0x97, 0xbf, 0x5f, 0x1d, 0x4b, 0x7c, 0xc8, 0xdb }}
```

## Protocol Interface Structure

```
typedef struct _EFI_EAP_CONFIGURATION_PROTOCOL {
  EFI_EAP_CONFIGURATION_SET_DATA  SetData;
  EFI_EAP_CONFIGURATION_GET_DATA  GetData;
} EFI_EAP_CONFIGURATION_PROTOCOL;
```

## Parameters

*SetData* Set EAP configuration data. See the **SetData()** function description.

*GetData* Get EAP configuration data. See the **GetData()** function description.

## Description

The **EFI\_EAP\_CONFIGURATION\_PROTOCOL** is designed to provide a way to set and get EAP configuration, such as Certificate, private key file.

## EFI\_EAP\_CONFIGURATION\_PROTOCOL.SetData()

### Summary

Set EAP configuration data.

### Prototype

```

typedef
EFI_STATUS
(EFI_API *EFI_EAP_CONFIGURATION_SET_DATA)(
  IN EFI_EAP_CONFIGURATION_PROTOCOL *This,
  IN EFI_EAP_TYPE      EapType,
  IN EFI_EAP_CONFIG_DATA_TYPE  DataType,
  IN VOID      *Data,
  IN UINTN     DataSize
);

```

### Parameters

<i>This</i>	Pointer to the <b>EFI_EAP_CONFIGURATION_PROTOCOL</b> instance.
<i>EapType</i>	EAP type. See <b>EFI_EAP_TYPE</b> .
<i>DataType</i>	Configuration data type. See <b>EFI_EAP_CONFIG_DATA_TYPE</b> .
<i>Data</i>	Pointer to configuration data.
<i>DataSize</i>	Total size of configuration data.

### Description

The **SetData()** function sets EAP configuration to non-volatile storage or volatile storage.

## Related Definitions

```

//
// Make sure it not conflict with any real EapTypeXXX
//
#define EFI_EAP_TYPE_ATTRIBUTE 0

typedef enum {
// EFI_EAP_TYPE_ATTRIBUTE
EfiEapConfigEapAuthMethod,
EfiEapConfigEapSupportedAuthMethod,
// EapTypeIdentity
EfiEapConfigIdentityString,
// EapTypeEAPTLS/EapTypePEAP
EfiEapConfigEapTlsCACert,
EfiEapConfigEapTlsClientCert,
EfiEapConfigEapTlsClientPrivateKeyFile,
EfiEapConfigEapTlsClientPrivateKeyFilePassword, \
// ASCII format, Volatile
EfiEapConfigEapTlsCipherSuite,
EfiEapConfigEapTlsSupportedCipherSuite,
// EapTypeMSChapV2
EfiEapConfigEapMSChapV2Password, // UNICODE format, Volatile
// EapTypePEAP
EfiEapConfigEap2ndAuthMethod,
// More...
} EFI_EAP_CONFIG_DATA_TYPE;

//
// EFI_EAP_TYPE
//
typedef UINT8 EFI_EAP_TYPE;
#define EFI_EAP_TYPE_ATTRIBUTE 0
#define EFI_EAP_TYPE_IDENTITY 1
#define EFI_EAP_TYPE_NOTIFICATION 2
#define EFI_EAP_TYPE_NAK 3
#define EFI_EAP_TYPE_MD5CHALLENGE 4
#define EFI_EAP_TYPE_OTP 5
#define EFI_EAP_TYPE_GTC 6
#define EFI_EAP_TYPE_EAPTLS 13
#define EFI_EAP_TYPE_EAPSIM 18
#define EFI_EAP_TYPE_TTLS 21
#define EFI_EAP_TYPE_PEAP 25
#define EFI_EAP_TYPE_MSCHAPV2 26
#define EFI_EAP_TYPE_EAP_EXTENSION 33
.....

```

## Status Codes Returned

EFI_SUCCESS	The EAP configuration data is set successfully.
EFI_INVALID_PARAMETER	One or more of the following conditions is TRUE: <ul style="list-style-type: none"><li>• <i>Data</i> is NULL.</li><li>• <i>DataSize</i> is 0.</li></ul>
EFI_UNSUPPORTED	The <i>EapType</i> or <i>DataType</i> is unsupported.
EFI_OUT_OF_RESOURCES	Required system resources could not be allocated.



## EFI\_EAP\_CONFIGURATION\_PROTOCOL.GetData()

### Summary

Get EAP configuration data.

### Prototype

```
typedef
EFI_STATUS
(EFI_API *EFI_EAP_CONFIGURATION_GET_DATA)(
  IN EFI_EAP_CONFIGURATION_PROTOCOL *This,
  IN EFI_EAP_TYPE      EapType,
  IN EFI_EAP_CONFIG_DATA_TYPE  DataType,
  IN OUT VOID          *Data,
  IN OUT UINTN         *DataSize
);
```

### Parameters

<i>This</i>	Pointer to the <b>EFI_EAP_CONFIGURATION_PROTOCOL</b> instance.
<i>EapType</i>	EAP type. See <b>EFI_EAP_TYPE</b> .
<i>DataType</i>	Configuration data type. See <b>EFI_EAP_CONFIG_DATA_TYPE</b>
<i>Data</i>	Pointer to configuration data.
<i>DataSize</i>	Total size of configuration data. On input, it means the size of <i>Data</i> buffer. On output, it means the size of copied <i>Data</i> buffer if <b>EFI_SUCCESS</b> , and means the size of desired <i>Data</i> buffer if <b>EFI_BUFFER_TOO_SMALL</b> .

### Description

The **GetData()** function gets EAP configuration.

- Status Codes Returned

EFI_SUCCESS	The EAP configuration data is got successfully.
EFI_INVALID_PARAMETER	One or more of the following conditions is TRUE: <ul style="list-style-type: none"> <li>• <i>Data</i> is NULL.</li> <li>• <i>DataSize</i> is NULL.</li> </ul>
EFI_UNSUPPORTED	The <i>EapType</i> or <i>DataType</i> is unsupported.
EFI_NOT_FOUND	The EAP configuration data is not found.
EFI_BUFFER_TOO_SMALL	The buffer is too small to hold the buffer.

## 26.3 EFI Wireless MAC Connection Protocol

### EFI\_WIRELESS\_MAC\_CONNECTION\_PROTOCOL

#### Summary

This protocol provides management service interfaces of 802.11 MAC layer. It is used by network applications (and drivers) to establish wireless connection with an access point (AP).

#### GUID

```
#define EFI_WIRELESS_MAC_CONNECTION_PROTOCOL_GUID \
{ 0xda55bc9, 0x45f8, 0x4bb4, \
  { 0x87, 0x19, 0x52, 0x24, 0xf1, 0x8a, 0x4d, 0x45 } }
```

#### Protocol Interface Structure

```
typedef struct _EFI_WIRELESS_MAC_CONNECTION_PROTOCOL {
  EFI_WIRELESS_MAC_CONNECTION_SCAN    Scan;
  EFI_WIRELESS_MAC_CONNECTION_ASSOCIATE Associate;
  EFI_WIRELESS_MAC_CONNECTION_DISASSOCIATE Disassociate;
  EFI_WIRELESS_MAC_CONNECTION_AUTHENTICATE Authenticate;
  EFI_WIRELESS_MAC_CONNECTION_DEAUTHENTICATE Deauthenticate;
} EFI_WIRELESS_MAC_CONNECTION_PROTOCOL;
```

#### Parameters

<i>Scan</i>	Determine the characteristics of the available BSSs. See the <b>Scan()</b> function description.
<i>Associate</i>	Places an association request with a specific peer MAC entity. See the <b>Associate()</b> function description.
<i>Disassociate</i>	Reports a disassociation with a specific peer MAC entity. See the <b>Disassociate()</b> function description.
<i>Authenticate</i>	Requests authentication with a specific peer MAC entity. See the <b>Authenticate()</b> function description.
<i>Deauthenticate</i>	Invalidates an authentication relationship with a peer MAC entity. See the <b>Deauthenticate()</b> function description.

#### Description

The **EFI\_WIRELESS\_MAC\_CONNECTION\_PROTOCOL** is designed to provide management service interfaces for the EFI wireless network stack to establish wireless connection with AP. An EFI Wireless MAC Connection Protocol instance will be installed on each communication device that the EFI wireless network stack runs on.

## EFI\_WIRELESS\_MAC\_CONNECTION\_PROTOCOL.Scan()

### Summary

Request a survey of potential BSSs that administrator can later elect to try to join.

### Prototype

```
typedef
EFI_STATUS
(EFI_API *EFI_WIRELESS_MAC_CONNECTION_SCAN)(
  IN EFI_WIRELESS_MAC_CONNECTION_PROTOCOL *This,
  IN EFI_80211_SCAN_DATA_TOKEN *Data
);
```

### Parameters

<i>This</i>	Pointer to the <b>EFI_WIRELESS_MAC_CONNECTION_PROTOCOL</b> instance.
<i>Data</i>	Pointer to the scan token. Type <b>EFI_80211_SCAN_DATA_TOKEN</b> is defined in “Related Definitions” below.

### Description

The **Scan()** function returns the description of the set of BSSs detected by the scan process. Passive scan operation is performed by default.

### Related Definitions

```
//*****
// EFI_80211_SCAN_DATA_TOKEN
//*****
typedef struct {
  EFI_EVENT      Event;
  EFI_STATUS     Status;
  EFI_80211_SCAN_DATA *Data;
  EFI_80211_SCAN_RESULT_CODE ResultCode;
  EFI_80211_SCAN_RESULT *Result;
} EFI_80211_SCAN_DATA_TOKEN;
```

<i>Event</i>	This <i>Event</i> will be signaled after the <i>Status</i> field is updated by the EFI Wireless MAC Connection Protocol driver. The type of <i>Event</i> must be <b>EFI_NOTIFY_SIGNAL</b> .
<i>Status</i>	Will be set to one of the following values: <b>EFI_SUCCESS</b> : Scan operation completed successfully. <b>EFI_NOT_FOUND</b> : Failed to find available BSS.

**EFI\_DEVICE\_ERROR:** An unexpected network or system error occurred.

**EFI\_ACCESS\_DENIED:** The scan operation is not completed due to some underlying hardware or software state.

**EFI\_NOT\_READY:** The scan operation is started but not yet completed.

*Data* Pointer to the scan data. Type **EFI\_80211\_SCAN\_DATA** is defined below.

*ResultCode* Indicates the scan state. Type **EFI\_80211\_SCAN\_RESULT\_CODE** is defined below.

*Result* Indicates the scan result. It is caller's responsibility to free this buffer. Type **EFI\_80211\_SCAN\_RESULT** is defined below.

The **EFI\_80211\_SCAN\_DATA\_TOKEN** structure is defined to support the process of determining the characteristics of the available BSSs. As input, the *Data* field must be filled in by the caller of EFI Wireless MAC Connection Protocol. After the scan operation completes, the EFI Wireless MAC Connection Protocol driver updates the *Status*, *ResultCode* and *Result* field and the *Event* is signaled.

```

//*****
// EFI_80211_SCAN_DATA
//*****
typedef struct {
    EFI_80211_BSS_TYPE  BSSType;
    EFI_80211_MAC_ADDRESS BSSId;
    UINT8               SSIdLen;
    UINT8               *SSId;
    BOOLEAN             PassiveMode;
    UINT32              ProbeDelay;
    UINT32              *ChannelList;
    UINT32              MinChannelTime;
    UINT32              MaxChannelTime;
    EFI_80211_ELEMENT_REQ *RequestInformation;
    EFI_80211_ELEMENT_SSID *SSIDList;
    EFI_80211_ACC_NET_TYPE AccessNetworkType;
    UINT8               *VendorSpecificInfo;
} EFI_80211_SCAN_DATA;

```

*BSSType* Determines whether infrastructure BSS, IBSS, MBSS, or all, are included in the scan. Type **EFI\_80211\_BSS\_TYPE** is defined below.

*BSSId* Indicates a specific or wildcard BSSID. Use all binary 1s to represent all SSIDs. Type **EFI\_80211\_MAC\_ADDRESS** is defined below.

<i>SSIdLen</i>	Length in bytes of the <i>SSId</i> . If <b>zero</b> , ignore <i>SSId</i> field.
<i>SSId</i>	Specifies the desired SSID or the wildcard SSID. Use NULL to represent all SSIDs.
<i>PassiveMode</i>	Indicates passive scanning if <b>TRUE</b> .
<i>ProbeDelay</i>	The delay in microseconds to be used prior to transmitting a Probe frame during active scanning. If <b>zero</b> , the value can be overridden by an implementation-dependent default value.
<i>ChannelList</i>	Specifies a list of channels that are examined when scanning for a BSS. If set to NULL, all valid channels will be scanned.
<i>MinChannelTime</i>	Indicates the minimum time in TU to spend on each channel when scanning. If <b>zero</b> , the value can be overridden by an implementation-dependent default value.
<i>MaxChannelTime</i>	Indicates the maximum time in TU to spend on each channel when scanning. If <b>zero</b> , the value can be overridden by an implementation-dependent default value.
<i>RequestInformation</i>	Points to an optionally present element. This is an optional parameter and may be NULL. Type <b>EFI_80211_ELEMENT_REQ</b> is defined below.
<i>SSIDList</i>	Indicates one or more SSID elements that are optionally present. This is an optional parameter and may be NULL. Type <b>EFI_80211_ELEMENT_SSID</b> is defined below.
<i>AccessNetworkType</i>	Specifies a desired specific access network type or the wildcard access network type. Use 15 as wildcard access network type. Type <b>EFI_80211_ACC_NET_TYPE</b> is defined below.
<i>VendorSpecificInfo</i>	Specifies zero or more elements. This is an optional parameter and may be NULL.

```

//*****
// EFI_80211_BSS_TYPE
//*****
typedef enum {
    IEEEInfrastructureBSS,
    IEEEIndependentBSS,
    IEEEMeshBSS,
    IEEEAnyBss
} EFI_80211_BSS_TYPE;

```

The **EFI\_80211\_BSS\_TYPE** is defined to enumerate BSS type.

```

//*****
// EFI_80211_MAC_ADDRESS
//*****
typedef struct {
    UINT8 Addr[6];
} EFI_80211_MAC_ADDRESS;

```

The **EFI\_80211\_MAC\_ADDRESS** is defined to record a 48-bit MAC address.

```

//*****
// EFI_80211_ELEMENT_REQ
//*****
typedef struct {
    EFI_80211_ELEMENT_HEADER Hdr;
    UINT8 RequestIDs[1];
} EFI_80211_ELEMENT_REQ;

```

*Hdr* Common header of an element. Type **EFI\_80211\_ELEMENT\_HEADER** is defined below.

*RequestIDs* Start of elements that are requested to be included in the Probe Response frame. The elements are listed in order of increasing element ID.

```

//*****
// EFI_80211_ELEMENT_HEADER
//*****
typedef struct {
    UINT8 ElementID;
    UINT8 Length;
} EFI_80211_ELEMENT_HEADER;

```

*ElementID* A unique element ID defined in IEEE 802.11 specification.

*Length* Specifies the number of octets in the element body.

```

//*****
// EFI_80211_ELEMENT_SSID
//*****
typedef struct {
    EFI_80211_ELEMENT_HEADER Hdr;
    UINT8 SSID[32];
} EFI_80211_ELEMENT_SSID;

```

*Hdr* Common header of an element.

*SSID* Service set identifier. If **Hdr.Length** is zero, this field is ignored.

```

//*****
// EFI_80211_ACC_NET_TYPE
//*****
typedef enum {
    IEEEPrivate = 0,
    IEEEPrivateWithGuest = 1,
    IEEEChargeablePublic = 2,
    IEEEFreePublic = 3,
    IEEEPersonal = 4,
    IEEEEmergencyServOnly = 5,
    IEEETestOrExp = 14,
    IEEEWildcard = 15
} EFI_80211_ACC_NET_TYPE;

```

The **EFI\_80211\_ACC\_NET\_TYPE** records access network types defined in IEEE 802.11 specification.

```

//*****
// EFI_80211_SCAN_RESULT_CODE
//*****
typedef enum {
    ScanSuccess,
    ScanNotSupported
} EFI_80211_SCAN_RESULT_CODE;

```

*ScanSuccess*                    The scan operation finished successfully.

*ScanNotSupported*            The scan operation is not supported in current implementation.

```

//*****
// EFI_80211_SCAN_RESULT
//*****
typedef struct {
    UINTN        NumOfBSSDesp;
    EFI_80211_BSS_DESCRIPTION **BSSDespSet;
    UINTN        NumofBSSDespFromPilot;
    EFI_80211_BSS_DESP_PILOT **BSSDespFromPilotSet;
    UINT8        *VendorSpecificInfo;
} EFI_80211_SCAN_RESULT;

```

*NumOfBSSDesp*                    The number of **EFI\_80211\_BSS\_DESCRIPTION** in BSSDespSet. If **zero**, *BSSDespSet* should be ignored.

*BSSDespSet*                      Points to zero or more instances of **EFI\_80211\_BSS\_DESCRIPTION**. Type **EFI\_80211\_BSS\_DESCRIPTION** is defined below.

*NumOfBSSDespFromPilot*

The number of **EFI\_80211\_BSS\_DESP\_PILOT** in *BSSDespFromPilotSet*. If **zero**, *BSSDespFromPilotSet* should be ignored.

*BSSDespFromPilotSet* Points to zero or more instances of **EFI\_80211\_BSS\_DESP\_PILOT**. Type **EFI\_80211\_BSS\_DESP\_PILOT** is defined below.

*VendorSpecificInfo* Specifies zero or more elements. This is an optional parameter and may be NULL.

```

//*****
// EFI_80211_BSS_DESCRIPTION
//*****
typedef struct {
  EFI_80211_MAC_ADDRESS  BSSId;
  UINT8                  *SSId;
  UINT8                  SSIdLen;
  EFI_80211_BSS_TYPE     BSSType;
  UINT16                 BeaconPeriod;
  UINT64                 Timestamp;
  UINT16                 CapabilityInfo;
  UINT8                  *BSSBasicRateSet;
  UINT8                  *OperationalRateSet;
  EFI_80211_ELEMENT_COUNTRY *Country;
  EFI_80211_ELEMENT_RSN  RSN;
  UINT8                  RSSI;
  UINT8                  RCPIMeasurement;
  UINT8                  RSNIMeasurement;
  UINT8                  *RequestedElements;
  UINT8                  *BSSMembershipSelectorSet;
  EFI_80211_ELEMENT_EXT_CAP *ExtCapElement;
} EFI_80211_BSS_DESCRIPTION;

```

*BSSId* Indicates a specific *BSSID* of the found BSS.

*SSId* Specifies the SSID of the found BSS. If NULL, ignore *SSIdLen* field.

*SSIdLen* Length in bytes of the *SSId*. If zero, ignore *SSId* field.

*BSSType* Specifies the type of the found BSS.

*BeaconPeriod* The beacon period in TU of the found BSS.

*Timestamp* The timestamp of the received frame from the found BSS.

*CapabilityInfo* The advertised capabilities of the BSS.

*BSSBasicRateSet* The set of data rates that shall be supported by all STAs that desire to join this BSS.

*OperationalRateSet* The set of data rates that the peer STA desires to use for communication within the BSS.



<i>Country</i>	The information required to identify the regulatory domain in which the peer STA is located. Type <b>EFI_80211_ELEMENT_COUNTRY</b> is defined below.
<i>RSN</i>	The cipher suites and AKM suites supported in the BSS. Type <b>EFI_80211_ELEMENT_RSN</b> is defined below.
<i>RSSI</i>	Specifies the <i>RSSI</i> of the received frame.
<i>RCPIMeasurement</i>	Specifies the <i>RCPI</i> of the received frame.
<i>RSNIMeasurement</i>	Specifies the <i>RSNI</i> of the received frame.
<i>RequestedElements</i>	Specifies the elements requested by the request element of the Probe Request frame. This is an optional parameter and may be NULL.
<i>BSSMembershipSelectorSet</i>	Specifies the BSS membership selectors that represent the set of features that shall be supported by all STAs to join this BSS.
<i>ExtCapElement</i>	Specifies the parameters within the Extended Capabilities element that are supported by the MAC entity. This is an optional parameter and may be NULL. Type <b>EFI_80211_ELEMENT_EXT_CAP</b> is defined below.

```

//*****
// EFI_80211_ELEMENT_COUNTRY
//*****
typedef struct {
    EFI_80211_ELEMENT_HEADER Hdr;
    UINT8    CountryStr[3];
    EFI_80211_COUNTRY_TRIPLET CountryTriplet[1];
} EFI_80211_ELEMENT_COUNTRY;

    Hdr                Common header of an element.
    CountryStr         Specifies country strings in 3 octets.
    CountryTriplet     Indicates a triplet that repeated in country element. The
                       number of triplets is determined by the Hdr.Length field.

//*****
// EFI_80211_COUNTRY_TRIPLET
//*****
typedef union {
    EFI_80211_COUNTRY_TRIPLET_SUBBAND Subband;
    EFI_80211_COUNTRY_TRIPLET_OPERATE Operating;
} EFI_80211_COUNTRY_TRIPLET;

    Subband           The subband triplet.
    Operating         The operating triplet.

```

```

//*****
// EFI_80211_COUNTRY_TRIPLET_SUBBAND
//*****
typedef struct {
    UINT8    FirstChannelNum;
    UINT8    NumOfChannels;
    UINT8    MaxTxPowerLevel;
} EFI_80211_COUNTRY_TRIPLET_SUBBAND;

```

*FirstChannelNum*            Indicates the lowest channel number in the subband. It has a positive integer value less than 201.

*NumOfChannels*            Indicates the number of channels in the subband.

*MaxTxPowerLevel*        Indicates the maximum power in dBm allowed to be transmitted.

```

//*****
// EFI_80211_COUNTRY_TRIPLET_OPERATE
//*****
typedef struct {
    UINT8    OperatingExtId;
    UINT8    OperatingClass;
    UINT8    CoverageClass;
} EFI_80211_COUNTRY_TRIPLET_OPERATE;

```

*OperatingExtId*           Indicates the operating extension identifier. It has a positive integer value of 201 or greater.

*OperatingClass*           Index into a set of values for radio equipment set of rules.

*CoverageClass*           Specifies aAirPropagationTime characteristics used in BSS operation. Refer the definition of aAirPropagationTime in IEEE 802.11 specification.

```

//*****
// EFI_80211_ELEMENT_RSN
//*****
typedef struct {
    EFI_80211_ELEMENT_HEADER    Hdr;
    EFI_80211_ELEMENT_DATA_RSN  *Data;
} EFI_80211_ELEMENT_RSN;

```

*Hdr*                        Common header of an element.

*Data*                      Points to RSN element. Type **EFI\_80211\_ELEMENT\_DATA\_RSN** is defined below. The size of a RSN element is limited to 255 octets.

```

//*****
// EFI_80211_ELEMENT_DATA_RSN
//*****
typedef struct {
    UINT16    Version;
    UINT32    GroupDataCipherSuite;
    //UINT16    PairwiseCipherSuiteCount;
    //UINT32    PairwiseCipherSuiteList[PairwiseCipherSuiteCount];
    //UINT16    AKMSuiteCount;
    //UINT32    AKMSuiteList[AKMSuiteCount];
    //UINT16    RSNCapabilities;
    //UINT16    PMKIDCount;
    //UINT8     PMKIDList[PMKIDCount][16];
    //UINT32    GroupManagementCipherSuite;
} EFI_80211_ELEMENT_DATA_RSN;

```

*Version* Indicates the version number of the RSNA protocol. Value 1 is defined in current IEEE 802.11 specification.

*GroupDataCipherSuite* Specifies the cipher suite selector used by the BSS to protect group address frames.

*PairwiseCipherSuiteCount* Indicates the number of pairwise cipher suite selectors that are contained in *PairwiseCipherSuiteList*.

*PairwiseCipherSuiteList* Contains a series of cipher suite selectors that indicate the pairwise cipher suites contained in this element.

*AKMSuiteCount* Indicates the number of AKM suite selectors that are contained in *AKMSuiteList*.

*AKMSuiteList* Contains a series of AKM suite selectors that indicate the AKM suites contained in this element.

*RSNCapabilities* Indicates requested or advertised capabilities.

*PMKIDCount* Indicates the number of PKMIDs in the *PMKIDList*.

*PMKIDList* Contains zero or more PKMIDs that the STA believes to be valid for the destination AP.

*GroupManagementCipherSuite* Specifies the cipher suite selector used by the BSS to protect group addressed robust management frames.

```

//*****
// EFI_80211_ELEMENT_EXT_CAP
//*****
typedef struct {
    EFI_80211_ELEMENT_HEADER Hdr;
    UINT8    Capabilities[1];
} EFI_80211_ELEMENT_EXT_CAP;

```

*Hdr* Common header of an element.

*Capabilities* Indicates the capabilities being advertised by the STA transmitting the element. This is a bit field with variable length. Refer to IEEE 802.11 specification for bit value.

```

//*****
// EFI_80211_BSS_DESP_PILOT
//*****
typedef struct {
  EFI_80211_MAC_ADDRESS  BSSId;
  EFI_80211_BSS_TYPE     BSSType;
  UINT8                  ConCapInfo;
  UINT8                  ConCountryStr[2];
  UINT8                  OperatingClass;
  UINT8                  Channel;
  UINT8                  Interval;
  EFI_80211_MULTIPLE_BSSID *MultipleBSSID;
  UINT8                  RCPIMeasurement;
  UINT8                  RSNIMeasurement;
} EFI_80211_BSS_DESP_PILOT;

```

*BSSId* Indicates a specific BSSID of the found BSS.

*BSSType* Specifies the type of the found BSS.

*ConCapInfo* One octet field to report condensed capability information.

*ConCountryStr* Two octet's field to report condensed country string.

*OperatingClass* Indicates the operating class value for the operating channel.

*Channel* Indicates the operating channel.

*Interval* Indicates the measurement pilot interval in TU.

*MultipleBSSID* Indicates that the BSS is within a multiple BSSID set.

*RCPIMeasurement* Specifies the RCPI of the received frame.

*RSNIMeasurement* Specifies the RSNM of the received frame.

```

//*****
// EFI_80211_MULTIPLE_BSSID
//*****
typedef struct {
  EFI_80211_ELEMENT_HEADER  Hdr;
  UINT8                      Indicator;
  EFI_80211_SUBELEMENT_INFO SubElement[1];
} EFI_80211_MULTIPLE_BSSID;

```

*Hdr* Common header of an element.

*Indicator* Indicates the maximum number of BSSIDs in the multiple BSSID set. When *Indicator* is set to n, 2<sup>n</sup> is the maximum number.

*SubElement* Contains zero or more sub-elements. Type **EFI\_80211\_SUBELEMENT\_INFO** is defined below.

```

//*****
// EFI_80211_SUBELEMENT_INFO
//*****
typedef struct {
    UINT8      SubElementID;
    UINT8      Length;
    UINT8      Data[1];
} EFI_80211_SUBELEMENT_INFO;
    
```

*SubElementID* Indicates the unique identifier within the containing element or sub-element.

*Length* Specifies the number of octets in the *Data* field.

*Data* A variable length data buffer.

### Status Codes Returned

EFI_SUCCESS	The operation completed successfully.
EFI_INVALID_PARAMETER	One or more of the following conditions is TRUE: <ul style="list-style-type: none"> <li>• <i>This</i> is NULL.</li> <li>• <i>Data</i> is NULL.</li> <li>• <i>Data-&gt;Data</i> is NULL.</li> </ul>
EFI_UNSUPPORTED	One or more of the input parameters are not supported by this implementation.
EFI_ALREADY_STARTED	The scan operation is already started.

## EFI\_WIRELESS\_MAC\_CONNECTION\_PROTOCOL.Associate()

### Summary

Request an association with a specified peer MAC entity that is within an AP.

### Prototype

```
typedef
EFI_STATUS
(EFI_API *EFI_WIRELESS_MAC_CONNECTION_ASSOCIATE)(
  IN EFI_WIRELESS_MAC_CONNECTION_PROTOCOL *This,
  IN EFI_80211_ASSOCIATE_DATA_TOKEN *Data
);
```

### Parameters

<i>This</i>	Pointer to the <b>EFI_WIRELESS_MAC_CONNECTION_PROTOCOL</b> instance.
<i>Data</i>	Pointer to the association token. Type <b>EFI_80211_ASSOCIATE_DATA_TOKEN</b> is defined in Related Definitions below.

### Description

The **Associate()** function provides the capability for MAC layer to become associated with an AP.

### Related Definitions

```
/**
*****
// EFI_80211_ASSOCIATE_DATA_TOKEN
*****
typedef struct {
  EFI_EVENT      Event;
  EFI_STATUS     Status;
  EFI_80211_ASSOCIATE_DATA *Data;
  EFI_80211_ASSOCIATE_RESULT_CODE ResultCode;
  EFI_80211_ASSOCIATE_RESULT *Result;
} EFI_80211_ASSOCIATE_DATA_TOKEN;
```

<i>Event</i>	This <i>Event</i> will be signaled after the <i>Status</i> field is updated by the EFI Wireless MAC Connection Protocol driver. The type of <i>Event</i> must be <b>EFI_NOTIFY_SIGNAL</b> .
<i>Status</i>	Will be set to one of the following values: <b>EFI_SUCCESS</b> : Association operation completed successfully. <b>EFI_DEVICE_ERROR</b> : An unexpected network or system error occurred.

<i>Data</i>	Pointer to the association data. Type <b>EFI_80211_ASSOCIATE_DATA</b> is defined below.
<i>ResultCode</i>	Indicates the association state. Type <b>EFI_80211_ASSOCIATE_RESULT_CODE</b> is defined below.
<i>Result</i>	Indicates the association result. It is caller's responsibility to free this buffer. Type <b>EFI_80211_ASSOCIATE_RESULT</b> is defined below.

The **EFI\_80211\_ASSOCIATE\_DATA\_TOKEN** structure is defined to support the process of association with a specified AP. As input, the *Data* field must be filled in by the caller of EFI Wireless MAC Connection Protocol. After the association operation completes, the EFI Wireless MAC Connection Protocol driver updates the *Status*, *ResultCode* and *Result* field and the *Event* is signaled.

```
//*****
// EFI_80211_ASSOCIATE_DATA
//*****
typedef struct {
    EFI_80211_MAC_ADDRESS  BSSId;
    UINT16                 CapabilityInfo;
    UINT32                 FailureTimeout;
    UINT32                 ListenInterval;
    EFI_80211_ELEMENT_SUPP_CHANNEL *Channels;
    EFI_80211_ELEMENT_RSN  RSN;
    EFI_80211_ELEMENT_EXT_CAP *ExtCapElement;
    UINT8                 *VendorSpecificInfo;
} EFI_80211_ASSOCIATE_DATA;
```

<i>BSSId</i>	Specifies the address of the peer MAC entity to associate with.
<i>CapabilityInfo</i>	Specifies the requested operational capabilities to the AP in 2 octets.
<i>FailureTimeout</i>	Specifies a time limit in TU, after which the associate procedure is terminated.
<i>ListenInterval</i>	Specifies if in power save mode, how often the STA awakes and listens for the next beacon frame in TU.
<i>Channels</i>	Indicates a list of channels in which the STA is capable of operating. . Type <b>EFI_80211_ELEMENT_SUPP_CHANNEL</b> is defined below.
<i>RSN</i>	The cipher suites and AKM suites selected by the STA.
<i>ExtCapElement</i>	Specifies the parameters within the Extended Capabilities element that are supported by the MAC entity. This is an optional parameter and may be NULL.
<i>VendorSpecificInfo</i>	Specifies zero or more elements. This is an optional parameter and may be NULL.

```

//*****
// EFI_80211_ELEMENT_SUPP_CHANNEL
//*****
typedef struct {
    EFI_80211_ELEMENT_HEADER    Hdr,
    EFI_80211_ELEMENT_SUPP_CHANNEL_TUPLE Subband[1];
} EFI_80211_ELEMENT_SUPP_CHANNEL;

    Hdr                Common header of an element.
    Subband            Indicates one or more tuples of (first channel, number of
                        channels). Type
                        EFI_80211_ELEMENT_SUPP_CHANNEL_TUPLE is
                        defined below.

//*****
// EFI_80211_ELEMENT_SUPP_CHANNEL_TUPLE
//*****
typedef struct {
    UINT8    FirstChannelNumber,
    UINT8    NumberOfChannels;
} EFI_80211_ELEMENT_SUPP_CHANNEL_TUPLE;

    FirstChannelNumber    The first channel number in a subband of supported
                        channels.
    NumberOfChannels      The number of channels in a subband of supported
                        channels.

//*****
// EFI_80211_ASSOCIATE_RESULT_CODE
//*****
typedef enum {
    AssociateSuccess,
    AssociateRefusedReasonUnspecified,
    AssociateRefusedCapsMismatch,
    AssociateRefusedExtReason,
    AssociateRefusedAPOutOfMemory,
    AssociateRefusedBasicRatesMismatch,
    AssociateRejectedEmergencyServicesNotSupported,
    AssociateRefusedTemporarily
} EFI_80211_ASSOCIATE_RESULT_CODE;

```

The **EFI\_80211\_ASSOCIATE\_RESULT\_CODE** records the result responses to the association request, which are defined in IEEE 802.11 specification.



```

//*****
// EFI_80211_ASSOCIATE_RESULT
//*****
typedef struct {
  EFI_80211_MAC_ADDRESS  BSSId;
  UINT16                  CapabilityInfo;
  UINT16                  AssociationID;
  UINT8                   RCPIValue;
  UINT8                   RSNIValue;
  EFI_80211_ELEMENT_EXT_CAP *ExtCapElement;
  EFI_80211_ELEMENT_TIMEOUT_VAL TimeoutInterval;
  UINT8                   *VendorSpecificInfo;
} EFI_80211_ASSOCIATE_RESULT;

```

<i>BSSId</i>	Specifies the address of the peer MAC entity from which the association request was received.
<i>CapabilityInfo</i>	Specifies the operational capabilities advertised by the AP.
<i>AssociationID</i>	Specifies the association ID value assigned by the AP.
<i>RCPIValue</i>	Indicates the measured RCPI of the corresponding association request frame. It is an optional parameter and is set to zero if unavailable.
<i>RSNIValue</i>	Indicates the measured RSN at the time the corresponding association request frame was received. It is an optional parameter and is set to zero if unavailable.
<i>ExtCapElement</i>	Specifies the parameters within the Extended Capabilities element that are supported by the MAC entity. This is an optional parameter and may be NULL.
<i>TimeoutInterval</i>	Specifies the timeout interval when the result code is <b>AssociateRefusedTemporarily</b> .
<i>VendorSpecificInfo</i>	Specifies zero or more elements. This is an optional parameter and may be NULL.

```

//*****
// EFI_80211_ELEMENT_TIMEOUT_VAL
//*****
typedef struct {
  EFI_80211_ELEMENT_HEADER Hdr;
  UINT8                    Type;
  UINT32                   Value;
} EFI_80211_ELEMENT_TIMEOUT_VAL;

```

<i>Hdr</i>	Common header of an element.
<i>Type</i>	Specifies the timeout interval type.
<i>Value</i>	Specifies the timeout interval value.

## Status Codes Returned

EFI_SUCCESS	The operation completed successfully.
EFI_INVALID_PARAMETER	One or more of the following conditions is TRUE: <ul style="list-style-type: none"><li>• <i>This</i> is NULL.</li><li>• <i>Data</i> is NULL.</li><li>• <i>Data-&gt;Data</i> is NULL.</li></ul>
EFI_UNSUPPORTED	One or more of the input parameters are not supported by this implementation.
EFI_ALREADY_STARTED	The association process is already started.
EFI_NOT_READY	Authentication is not performed before this association process.
EFI_NOT_FOUND	The specified peer MAC entity is not found.
EFI_OUT_OF_RESOURCES	Required system resources could not be allocated.

## EFI\_WIRELESS\_MAC\_CONNECTION\_PROTOCOL.Disassociate()

### Summary

Request a disassociation with a specified peer MAC entity.

### Prototype

```
typedef
EFI_STATUS
(EFI_API *EFI_WIRELESS_MAC_CONNECTION_DISASSOCIATE)(
  IN EFI_WIRELESS_MAC_CONNECTION_PROTOCOL *This,
  IN EFI_80211_DISASSOCIATE_DATA_TOKEN *Data
);
```

### Parameters

<i>This</i>	Pointer to the <b>EFI_WIRELESS_MAC_CONNECTION_PROTOCOL</b> instance.
<i>Data</i>	Pointer to the disassociation token. Type <b>EFI_80211_DISASSOCIATE_DATA_TOKEN</b> is defined in Related Definitions below.

### Description

The **Disassociate()** function is invoked to terminate an existing association. Disassociation is a notification and cannot be refused by the receiving peer except when management frame protection is negotiated and the message integrity check fails.

### Related Definitions

```
/**
//*****
// EFI_80211_DISASSOCIATE_DATA_TOKEN
//*****
typedef struct {
  EFI_EVENT      Event;
  EFI_STATUS     Status;
  EFI_80211_DISASSOCIATE_DATA *Data;
  EFI_80211_DISASSOCIATE_RESULT_CODE ResultCode;
} EFI_80211_DISASSOCIATE_DATA_TOKEN;
```

<i>Event</i>	This Event will be signaled after the <i>Status</i> field is updated by the EFI Wireless MAC Connection Protocol driver. The type of <i>Event</i> must be <b>EFI_NOTIFY_SIGNAL</b> .
<i>Status</i>	Will be set to one of the following values: <b>EFI_SUCCESS</b> : Disassociation operation completed successfully. <b>EFI_DEVICE_ERROR</b> : An unexpected network or system error occurred.

**EFI\_ACCESS\_DENIED**: The disassociation operation is not completed due to some underlying hardware or software state.

**EFI\_NOT\_READY**: The disassociation operation is started but not yet completed.

*Data*

Pointer to the disassociation data. Type **EFI\_80211\_DISASSOCIATE\_DATA** is defined below.

*ResultCode*

Indicates the disassociation state. Type **EFI\_80211\_DISASSOCIATE\_RESULT\_CODE** is defined below.

```
//*****
```

```
// EFI_80211_DISASSOCIATE_DATA
```

```
//*****
```

```
typedef struct {
```

```
EFI_80211_MAC_ADDRESS  BSSId;
```

```
EFI_80211_REASON_CODE ReasonCode;
```

```
UINT8      *VendorSpecificInfo;
```

```
} EFI_80211_DISASSOCIATE_DATA;
```

*BSSId*

Specifies the address of the peer MAC entity with which to perform the disassociation process.

*ReasonCode*

Specifies the reason for initiating the disassociation process.

*VendorSpecificInfo*

Zero or more elements, may be NULL.

```

//*****
// EFI_80211_REASON_CODE
//*****
typedef enum {
    IEEE80211UnspecifiedReason    = 1,
    IEEE80211PreviousAuthenticateInvalid = 2,
    IEEE80211DeauthenticatedSinceLeaving = 3,
    IEEE80211DisassociatedDueToInactive = 4,
    IEEE80211DisassociatedSinceApUnable = 5,
    IEEE80211Class2FrameNonauthenticated = 6,
    IEEE80211Class3FrameNonassociated = 7,
    IEEE80211DisassociatedSinceLeaving = 8,
    // ...
} EFI_80211_REASON_CODE;
    
```

**Note:** The reason codes are defined in chapter 8.4.1.7 Reason Code field, IEEE 802.11-2012.

```

//*****
// EFI_80211_DISASSOCIATE_RESULT_CODE
//*****
typedef enum {
    DisassociateSuccess,
    DisassociateInvalidParameters
} EFI_80211_DISASSOCIATE_RESULT_CODE;
    
```

*DisassociateSuccess* Disassociation process completed successfully.

*DisassociateInvalidParameters* Disassociation failed due to any input parameter is invalid.

### Status Codes Returned

EFI_SUCCESS	The operation completed successfully.
EFI_INVALID_PARAMETER	One or more of the following conditions is TRUE: <ul style="list-style-type: none"> <li>• <i>This</i> is NULL.</li> <li>• <i>Data</i> is NULL.</li> </ul>
EFI_ALREADY_STARTED	The disassociation process is already started.
EFI_NOT_READY	The disassociation service is invoked to a nonexistent association relationship.
EFI_NOT_FOUND	The specified peer MAC entity is not found.
EFI_OUT_OF_RESOURCES	Required system resources could not be allocated.

## EFI\_WIRELESS\_MAC\_CONNECTION\_PROTOCOL.Authenticate()

### Summary

Request the process of establishing an authentication relationship with a peer MAC entity.

### Prototype

```
typedef
EFI_STATUS
(EFIAPI *EFI_WIRELESS_MAC_CONNECTION_AUTHENTICATE)(
  IN EFI_WIRELESS_MAC_CONNECTION_PROTOCOL *This,
  IN EFI_80211_AUTHENTICATE_DATA_TOKEN *Data
);
```

### Parameters

<i>This</i>	Pointer to the <b>EFI_WIRELESS_MAC_CONNECTION_PROTOCOL</b> instance.
<i>Data</i>	Pointer to the authentication token. Type <b>EFI_80211_AUTHENTICATE_DATA_TOKEN</b> is defined in Related Definitions below.

### Description

The **Authenticate()** function requests authentication with a specified peer MAC entity. This service might be time-consuming thus is designed to be invoked independently of the association service.

### Related Definitions

```
//*****
// EFI_80211_AUTHENTICATE_DATA_TOKEN
//*****
typedef struct {
  EFI_EVENT      Event;
  EFI_STATUS     Status;
  EFI_80211_AUTHENTICATE_DATA *Data;
  EFI_80211_AUTHENTICATE_RESULT_CODE ResultCode;
  EFI_80211_AUTHENTICATE_RESULT *Result;
} EFI_80211_AUTHENTICATE_DATA_TOKEN;
```

<i>Event</i>	This <i>Event</i> will be signaled after the <i>Status</i> field is updated by the EFI Wireless MAC Connection Protocol driver. The type of <i>Event</i> must be <b>EFI_NOTIFY_SIGNAL</b> .
--------------	---

<i>Status</i>	Will be set to one of the following values: <b>EFI_SUCCESS</b> : Authentication operation completed successfully.
---------------	--

**EFI\_PROTOCOL\_ERROR:** Peer MAC entity rejects the authentication.

**EFI\_NO\_RESPONSE:** Peer MAC entity does not response the authentication request.

**EFI\_DEVICE\_ERROR:** An unexpected network or system error occurred.

**EFI\_ACCESS\_DENIED:** The authentication operation is not completed due to some underlying hardware or software state.

**EFI\_NOT\_READY:** The authentication operation is started but not yet completed.

*Data*

Pointer to the authentication data. Type **EFI\_80211\_AUTHENTICATE\_DATA** is defined below.

*ResultCode*

Indicates the association state. Type **EFI\_80211\_AUTHENTICATE\_RESULT\_CODE** is defined below.

*Result*

Indicates the association result. It is caller's responsibility to free this buffer. Type **EFI\_80211\_AUTHENTICATE\_RESULT** is defined below.

```

//*****
// EFI_80211_AUTHENTICATE_DATA
//*****
typedef struct {
    EFI_80211_MAC_ADDRESS  BSSId;
    EFI_80211_AUTHENTICATION_TYPE  AuthType;
    UINT32      FailureTimeout;
    UINT8      *FTContent;
    UINT8      *SAEContent;
    UINT8      *VendorSpecificInfo;
} EFI_80211_AUTHENTICATE_DATA;

```

*BSSId*

Specifies the address of the peer MAC entity with which to perform the authentication process.

*AuthType*

Specifies the type of authentication algorithm to use during the authentication process.

*FailureTimeout*

Specifies a time limit in TU after which the authentication procedure is terminated.

*FTContent*

Specifies the set of elements to be included in the first message of the FT authentication sequence, may be NULL.

*SAEContent*

Specifies the set of elements to be included in the SAE Commit Message or SAE Confirm Message, may be NULL.

*VendorSpecificInfo*

Zero or more elements, may be NULL.

```

//*****
// EFI_80211_AUTHENTICATION_TYPE
//*****
typedef enum {
  OpenSystem,
  SharedKey,
  FastBSSTransition,
  SAE
} EFI_80211_AUTHENTICATION_TYPE;

```

<i>OpenSystem</i>	Open system authentication, admits any STA to the DS.
<i>SharedKey</i>	Shared Key authentication relies on WEP to demonstrate knowledge of a WEP encryption key.
<i>FastBSSTransition</i>	FT authentication relies on keys derived during the initial mobility domain association to authenticate the stations.
<i>SAE</i>	SAE authentication uses finite field cryptography to prove knowledge of a shared password.

```

//*****
// EFI_80211_AUTHENTICATION_RESULT_CODE
//*****
typedef enum {
  AuthenticateSuccess,
  AuthenticateRefused,
  AuthenticateAnticLoggingTokenRequired,
  AuthenticateFiniteCyclicGroupNotSupported,
  AuthenticationRejected,
  AuthenticateInvalidParameter
} EFI_80211_AUTHENTICATE_RESULT_CODE;

```

The result code indicates the result response to the authentication request from the peer MAC entity.

```

//*****
// EFI_80211_AUTHENTICATION_RESULT
//*****
typedef struct {
  EFI_80211_MAC_ADDRESS  BSSId;
  UINT8                  *FTContent;
  UINT8                  *SAEContent;
  UINT8                  *VendorSpecificInfo;
} EFI_80211_AUTHENTICATE_RESULT;

```

<i>BSSId</i>	Specifies the address of the peer MAC entity from which the authentication request was received.
--------------	--



<i>FTContent</i>	Specifies the set of elements to be included in the second message of the FT authentication sequence, may be NULL.
<i>SAEContent</i>	Specifies the set of elements to be included in the SAE Commit Message or SAE Confirm Message, may be NULL.
<i>VendorSpecificInfo</i>	Zero or more elements, may be NULL.

### Status Codes Returned

EFI_SUCCESS	The operation completed successfully.
EFI_INVALID_PARAMETER	One or more of the following conditions is TRUE: <ul style="list-style-type: none"> <li>• <i>This</i> is NULL.</li> <li>• <i>Data</i> is NULL.</li> <li>• <i>Data.Data</i> is NULL.</li> </ul>
EFI_UNSUPPORTED	One or more of the input parameters are not supported by this implementation.
EFI_ALREADY_STARTED	The authentication process is already started.
EFI_NOT_FOUND	The specified peer MAC entity is not found.
EFI_OUT_OF_RESOURCES	Required system resources could not be allocated.

## EFI\_WIRELESS\_MAC\_CONNECTION\_PROTOCOL.Deauthenticate()

### Summary

Invalidate the authentication relationship with a peer MAC entity.

### Prototype

```
typedef
EFI_STATUS
(EFI_API *EFI_WIRELESS_MAC_CONNECTION_DEAUTHENTICATE)(
  IN EFI_WIRELESS_MAC_CONNECTION_PROTOCOL *This,
  IN EFI_80211_DEAUTHENTICATE_DATA_TOKEN *Data
);
```

### Parameters

<i>This</i>	Pointer to the <b>EFI_WIRELESS_MAC_CONNECTION_PROTOCOL</b> instance.
<i>Data</i>	Pointer to the deauthentication token. Type <b>EFI_80211_DEAUTHENTICATE_DATA_TOKEN</b> is defined in Related Definitions below.

### Description

The **Deauthenticate()** function requests that the authentication relationship with a specified peer MAC entity be invalidated. Deauthentication is a notification and when it is sent out the association at the transmitting station is terminated.

### Related Definitions

```
/**
//*****
// EFI_80211_DEAUTHENTICATE_DATA_TOKEN
//*****
typedef struct {
  EFI_EVENT      Event;
  EFI_STATUS     Status;
  EFI_80211_DEAUTHENTICATE_DATA *Data;
} EFI_80211_DEAUTHENTICATE_DATA_TOKEN;
```

<i>Event</i>	This <i>Event</i> will be signaled after the <i>Status</i> field is updated by the EFI Wireless MAC Connection Protocol driver. The type of <i>Event</i> must be <b>EFI_NOTIFY_SIGNAL</b> .
--------------	---

<i>Status</i>	Will be set to one of the following values: <b>EFI_SUCCESS</b> : Deauthentication operation completed successfully. <b>EFI_DEVICE_ERROR</b> : An unexpected network or system error occurred. <b>EFI_ACCESS_DENIED</b> : The deauthentication operation is not completed due to some underlying hardware or software state.
---------------	--

**EFI\_NOT\_READY**: The deauthentication operation is started but not yet completed.

*Data*

Pointer to the deauthentication data. Type **EFI\_80211\_DEAUTHENTICATE\_DATA** is defined below.

```

//*****
// EFI_80211_DEAUTHENTICATE_DATA
//*****
typedef struct {
    EFI_80211_MAC_ADDRESS    BSSId;
    EFI_80211_REASON_CODE    ReasonCode;
    UINT8                    *VendorSpecificInfo;
} EFI_80211_DEAUTHENTICATE_DATA;

```

*BSSId* Specifies the address of the peer MAC entity with which to perform the deauthentication process.

*ReasonCode* Specifies the reason for initiating the deauthentication process.

*VendorSpecificInfo* Zero or more elements, may be NULL.

## Status Codes Returned

EFI_SUCCESS	The operation completed successfully.
EFI_INVALID_PARAMETER	One or more of the following conditions is TRUE: <ul style="list-style-type: none"> <li><i>This</i> is NULL.</li> <li><i>Data</i> is NULL.</li> <li><i>Data.Data</i> is NULL.</li> </ul>
EFI_ALREADY_STARTED	The deauthentication process is already started.
EFI_NOT_READY	The deauthentication service is invoked to a nonexistent association or authentication relationship.
EFI_NOT_FOUND	The specified peer MAC entity is not found.
EFI_OUT_OF_RESOURCES	Required system resources could not be allocated.

## 26.4 EFI Wireless MAC Connection II Protocol

This section provides a detailed description of EFI Wireless MAC Connection II Protocol.

### EFI\_WIRELESS\_MAC\_CONNECTION\_II\_PROTOCOL

#### Summary

The **EFI\_WIRELESS\_MAC\_CONNECTION\_II\_PROTOCOL** provides network management service interfaces for 802.11 network stack. It is used by network applications (and drivers) to establish wireless connection with a wireless network.

## GUID

```
#define EFI_WIRELESS_MAC_CONNECTION_II_PROTOCOL_GUID \
  { 0x1b0fb9bf, 0x699d, 0x4fdd, \
    { 0xa7, 0xc3, 0x25, 0x46, 0x68, 0x1b, 0xf6, 0x3b } }
```

## Protocol Interface Structure

```
typedef struct _EFI_WIRELESS_MAC_CONNECTION_II_PROTOCOL {
  EFI_WIRELESS_MAC_CONNECTION_II_GET_NETWORKS  GetNetworks;
  EFI_WIRELESS_MAC_CONNECTION_II_CONNECT_NETWORK  ConnectNetwork;
  EFI_WIRELESS_MAC_CONNECTION_II_DISCONNECT_NETWORK  DisconnectNetwork;
} EFI_WIRELESS_MAC_CONNECTION_II_PROTOCOL;
```

## Parameters

<i>GetNetworks</i>	Get a list of nearby detectable wireless network. See the <b>GetNetworks()</b> function description.
<i>ConnectNetwork</i>	Places a connection request with a specific wireless network. See the <b>ConnectNetwork()</b> function description.
<i>DisconnectNetwork</i>	Places a disconnection request with a specific wireless network. See the <b>DisconnectNetwork()</b> function description.

## Description

The **EFI\_WIRELESS\_MAC\_CONNECTION\_II\_PROTOCOL** is designed to provide management service interfaces for the EFI wireless network stack to establish relationship with a wireless network (identified by **EFI\_80211\_NETWORK** defined below). An EFI Wireless MAC Connection II Protocol instance will be installed on each communication device that the EFI wireless network stack runs on.

## EFI\_WIRELESS\_MAC\_CONNECTION\_II\_PROTOCOL.GetNetworks()

### Summary

Request a survey of potential wireless networks that administrator can later elect to try to join.

### Prototype

```
typedef
EFI_STATUS
(EFI_API *EFI_WIRELESS_MAC_CONNECTION_II_GET_NETWORKS)(
    IN EFI_WIRELESS_MAC_CONNECTION_II_PROTOCOL *This,
    IN EFI_80211_GET_NETWORKS_TOKEN *Token
);
```

### Parameters

<i>This</i>	Pointer to the <b>EFI_WIRELESS_MAC_CONNECTION_II_PROTOCOL</b> instance.
<i>Token</i>	Pointer to the token for getting wireless network. Type <b>EFI_80211_GET_NETWORKS_TOKEN</b> is defined in Related Definitions below.

### Description

The **GetNetworks()** function returns the description of a list of wireless networks detected by wireless UEFI driver. This function is always non-blocking. If the operation succeeds or fails due to any error, the *Token->Event* will be signaled and *Token->Status* will be updated accordingly. The caller of this function is responsible for inputting SSIDs in case of searching hidden networks.

### Related Definitions

```
/**
//*****
// EFI_80211_GET_NETWORKS_TOKEN
//*****
typedef struct {
    EFI_EVENT      Event;
    EFI_STATUS     Status;
    EFI_80211_GET_NETWORKS_DATA *Data;
    EFI_80211_GET_NETWORKS_RESULT *Result;
} EFI_80211_GET_NETWORKS_TOKEN;
```

<i>Event</i>	If the status code returned by <b>GetNetworks()</b> is <b>EFI_SUCCESS</b> , then this Event will be signaled after the
--------------	--

<i>Status</i>	<p><i>Status</i> field is updated by the EFI Wireless MAC Connection Protocol II driver. The type of <i>Event</i> must be <b>EFI_NOTIFY_SIGNAL</b>.</p> <p>Will be set to one of the following values:</p> <p><b>EFI_SUCCESS</b>: The operation completed successfully.</p> <p><b>EFI_NOT_FOUND</b>: Failed to find available wireless networks.</p> <p><b>EFI_DEVICE_ERROR</b>: An unexpected network or system error occurred.</p> <p><b>EFI_ACCESS_DENIED</b>: The operation is not completed due to some underlying hardware or software state.</p> <p><b>EFI_NOT_READY</b>: The operation is started but not yet completed.</p>
<i>Data</i>	<p>Pointer to the input data for getting networks. Type <b>EFI_80211_GET_NETWORKS_DATA</b> is defined below.</p>
<i>Result</i>	<p>Indicates the scan result. It is caller's responsibility to free this buffer. Type <b>EFI_80211_GET_NETWORKS_RESULT</b> is defined below.</p>

```

//*****
// EFI_80211_GET_NETWORKS_DATA
//*****
typedef struct {
    UINT32    NumOfSSID;
    EFI_80211_SSID    SSIDList[1];
} EFI_80211_GET_NETWORKS_DATA;

```

<i>NumOfSSID</i>	<p>The number of <b>EFI_80211_SSID</b> in <i>SSIDList</i>. If zero, <i>SSIDList</i> should be ignored.</p>
<i>SSIDList</i>	<p>The <i>SSIDList</i> is a pointer to an array of <b>EFI_80211_SSID</b> instances. The number of entries is specified by <i>NumOfSSID</i>. The array should only include SSIDs of hidden networks. It is suggested that the caller inputs less than 10 elements in the <i>SSIDList</i>. It is the caller's responsibility to free this buffer. Type <b>EFI_80211_SSID</b> is defined below.</p>

```

#define EFI_MAX_SSID_LEN 32

//*****
// EFI_80211_SSID
//*****
typedef struct {
    UINT8    SSIdLen;
    UINT8    SSId[EFI_MAX_SSID_LEN];
} EFI_80211_SSID;

```

*SSIdLen* Length in bytes of the *SSId*. If zero, ignore SSId field.

*SSId* Specifies the service set identifier.

```

//*****
// EFI_80211_GET_NETWORKS_RESULT
//*****
typedef struct {
    UINT8    NumOfNetworkDesc;
    EFI_80211_NETWORK_DESCRIPTION NetworkDesc[1];
} EFI_80211_GET_NETWORKS_RESULT;

```

*NumOfNetworkDesc* The number of elements in *NetworkDesc*. If zero, *NetworkDesc* should be ignored.

*NetworkDesc* The *NetworkDesc* is a variable-length array of elements of type **EFI\_80211\_NETWORK\_DESCRIPTION**. Type **EFI\_80211\_NETWORK\_DESCRIPTION** is defined below.

```

//*****
// EFI_80211_NETWORK_DESCRIPTION
//*****
typedef struct {
    EFI_80211_NETWORK Network;
    UINT8    NetworkQuality;
} EFI_80211_NETWORK_DESCRIPTION;

```

*Network* Specifies the found wireless network. Type **EFI\_80211\_NETWORK** is defined below.

*NetworkQuality* Indicates the network quality as a value between 0 to 100, where 100 indicates the highest network quality.

```

//*****
// EFI_80211_NETWORK
//*****
typedef struct {
    EFI_80211_BSS_TYPE    BSSType;
    EFI_80211_SSID        SSID;
    EFI_80211_AKM_SUITE_SELECTOR *AKMSuite;
    EFI_80211_CIPHER_SUITE_SELECTOR *CipherSuite;
} EFI_80211_NETWORK;

```

<i>BSSType</i>	Specifies the type of the BSS. Type <b>EFI_80211_BSS_TYPE</b> is defined below.
<i>SSID</i>	Specifies the SSID of the BSS. Type <b>EFI_80211_SSID</b> is defined above.
<i>AKMSuite</i>	Pointer to the AKM suites supported in the wireless network. Type <b>EFI_80211_AKM_SUITE_SELECTOR</b> is defined below.
<i>CipherSuite</i>	Pointer to the cipher suites supported in the wireless network. Type <b>EFI_80211_CIPHER_SUITE_SELECTOR</b> is defined below.

```

//*****
// EFI_80211_BSS_TYPE
//*****
typedef enum {
    IEEEInfrastructureBSS,
    IEEEIndependentBSS,
    IEEEMeshBSS,
    IEEEAnyBss
} EFI_80211_BSS_TYPE;

```

The **EFI\_80211\_BSS\_TYPE** is defined to enumerate BSS type.



```

//*****
// EFI_80211_SUITE_SELECTOR
//*****
typedef struct {
  UINT8 Oui[3];
  UINT8 SuiteType;
} EFI_80211_SUITE_SELECTOR;

```

*Oui* Organization Unique Identifier, as defined in IEEE 802.11 standard, usually set to 00-0F-AC.

*SuiteType* Suites types, as defined in IEEE 802.11 standard.

```

//*****
// EFI_80211_AKM_SUITE_SELECTOR
//*****
typedef struct {
  UINT16 AKMSuiteCount;
  EFI_80211_SUITE_SELECTOR AKMSuiteList[1];
} EFI_80211_AKM_SUITE_SELECTOR;

```

*AKMSuiteCount* Indicates the number of AKM suite selectors that are contained in *AKMSuiteList*. If zero, the *AKMSuiteList* is ignored.

*AKMSuiteList* A variable-length array of AKM suites, as defined in IEEE 802.11 standard, Table 8-101. The number of entries is specified by *AKMSuiteCount*.

```

//*****
// EFI_80211_CIPHER_SUITE_SELECTOR
//*****
typedef struct {
  UINT16 CipherSuiteCount;
  EFI_80211_SUITE_SELECTOR CipherSuiteList[1];
} EFI_80211_CIPHER_SUITE_SELECTOR;

```

*CipherSuiteCount* Indicates the number of cipher suites that are contained in *CipherSuiteList*. If zero, the *CipherSuiteList* is ignored.

*CipherSuiteList* A variable-length array of cipher suites, as defined in IEEE 802.11 standard, Table 8-99. The number of entries is specified by *CipherSuiteCount*.

## Status Codes Returned

EFI_SUCCESS	The operation started, and an event will eventually be raised for the caller.
EFI_INVALID_PARAMETER	One or more of the following conditions is TRUE: This is NULL. Token is NULL.
EFI_UNSUPPORTED	One or more of the input parameters is not supported by this implementation.
EFI_ALREADY_STARTED	The operation of getting wireless network is already started.
EFI_OUT_OF_RESOURCES	Required system resources could not be allocated.

## EFI\_WIRELESS\_MAC\_CONNECTION\_II\_PROTOCOL.ConnectNetwork()

### Summary

Connect a wireless network specified by a particular SSID, BSS type and Security type.

### Prototype

```
typedef
EFI_STATUS
(EFI_API *EFI_WIRELESS_MAC_CONNECTION_II_CONNECT_NETWORK)(
    IN EFI_WIRELESS_MAC_CONNECTION_II_PROTOCOL *This,
    IN EFI_80211_CONNECT_NETWORK_TOKEN *Token
);
```

### Parameters

This	Pointer to the <b>EFI_WIRELESS_MAC_CONNECTION_II_PROTOCOL</b> instance.
Token	Pointer to the token for connecting wireless network. Type <b>EFI_80211_CONNECT_NETWORK_TOKEN</b> is defined in Related Definitions below.

### Description

The **ConnectNetwork()** function places a request to wireless UNDI driver to connect a wireless network specified by a particular SSID, BSS type, Authentication method and cipher. This function will trigger wireless UNDI driver to perform authentication and association process to establish connection with a particular Access Point for the specified network. This function is always non-blocking. If the connection succeeds or fails due to any error, the *Token->Event* will be signaled and *Token->Status* will be updated accordingly.

After having signaled a successful connection completion, the UNDI driver will update the network connection state using the network media state information type in the **EFI\_ADAPTER\_INFORMATION\_PROTOCOL**. If needed, the caller should use **EFI\_ADAPTER\_INFORMATION\_PROTOCOL** to regularly get the network media state to find if the UNDI driver is still connected to the wireless network (**EFI\_SUCCESS**) or not (**EFI\_NO\_MEDIA**).

Generally a driver or application in WiFi stack would provide user interface to end user to manage profiles for selecting which wireless network to join and other state management. This module should prompt the user to select a network and input WiFi security data such as certificate, private key file, password, etc. Then the module should deploy WiFi security data through EFI Supplicant Protocol and/ or EFI EAP Configuration Protocol before calling **ConnectNetwork()** function.

## Related Definitions

```

//*****
// EFI_80211_CONNECT_NETWORK_TOKEN
//*****
typedef struct {
    EFI_EVENT      Event;
    EFI_STATUS     Status;
    EFI_80211_CONNECT_NETWORK_DATA *Data;
    EFI_80211_CONNECT_NETWORK_RESULT_CODE ResultCode;
} EFI_80211_CONNECT_NETWORK_TOKEN;

```

<i>Event</i>	If the status code returned by <b>ConnectNetwork()</b> is <b>EFI_SUCCESS</b> , then this <i>Event</i> will be signaled after the Status field is updated by the EFI Wireless MAC Connection Protocol II driver. The type of <i>Event</i> must be <b>EFI_NOTIFY_SIGNAL</b> .
<i>Status</i>	Will be set to one of the following values: <b>EFI_SUCCESS</b> : The operation completed successfully. <b>EFI_DEVICE_ERROR</b> : An unexpected network or system error occurred. <b>EFI_ACCESS_DENIED</b> : The operation is not completed due to some underlying hardware or software state. <b>EFI_NOT_READY</b> : The operation is started but not yet completed.
<i>Data</i>	Pointer to the connection data. Type <b>EFI_80211_CONNECT_NETWORK_DATA</b> is defined below.
<i>ResultCode</i>	Indicates the connection state. Type <b>EFI_80211_CONNECT_NETWORK_RESULT_CODE</b> is defined below.

The **EFI\_80211\_CONNECT\_NETWORK\_TOKEN** structure is defined to support the process of determining the characteristics of the available networks. As input, the *Data* field must be filled in by the caller of EFI Wireless MAC Connection II Protocol. After the operation completes, the EFI Wireless MAC Connection II Protocol driver updates the *Status* and *ResultCode* field and the *Event* is signaled.

```

//*****
// EFI_80211_CONNECT_NETWORK_DATA //*****
typedef struct {
    EFI_80211_NETWORK *Network;
    UINT32 FailureTimeout;
} EFI_80211_CONNECT_NETWORK_DATA;
    
```

*Network* Specifies the wireless network to connect to. Type **EFI\_80211\_NETWORK** is defined above.

*FailureTimeout* Specifies a time limit in seconds that is optionally present, after *which* the connection establishment procedure is terminated by the UNDI driver. This is an optional parameter and may be 0. Values of 5 seconds or higher are recommended.

```

//*****
// EFI_80211_CONNECT_NETWORK_RESULT_CODE //*****
typedef enum {
    ConnectSuccess,
    ConnectRefused,
    ConnectFailed,
    ConnectFailureTimeout,
    ConnectFailedReasonUnspecified
} EFI_80211_CONNECT_NETWORK_RESULT_CODE;
    
```

*ConnectSuccess* The connection establishment operation finished successfully.

*ConnectRefused* The connection was refused by the *Network*.

*ConnectFailed* The connection establishment operation failed (i.e, *Network* is not detected).

*ConnectFailureTimeout* The connection establishment operation was terminated on timeout.

*ConnectFailedReasonUnspecified* The connection establishment operation failed on other reason.

### Status Codes Returned

EFI_SUCCESS	The operation started successfully. Results will be notified eventually.
-------------	--

EFI_INVALID_PARAMETER	One or more of the following conditions is TRUE: This is NULL. Token is NULL.
EFI_UNSUPPORTED	One or more of the input parameters are not supported by this implementation.
EFI_ALREADY_STARTED	The connection process is already started.
EFI_NOT_FOUND	The specified wireless network is not found.
EFI_OUT_OF_RESOURCES	Required system resources could not be allocated.

## EFI\_WIRELESS\_MAC\_CONNECTION\_II\_PROTOCOL.DisconnectNetwork( )

### Summary

Request a disconnection with current connected wireless network.

Prototype

typedef

EFI\_STATUS

```
(EFI_API *EFI_WIRELESS_MAC_CONNECTION_II_DISCONNECT_NETWORK)(
```

```
IN EFI_WIRELESS_MAC_CONNECTION_II_PROTOCOL *This,
```

```
IN EFI_80211_DISCONNECT_NETWORK_TOKEN *Token
```

```
);
```

### Parameters

*This*

Pointer to the **EFI\_WIRELESS\_MAC\_CONNECTION\_II\_PROTOCOL** instance.

*Token*

Pointer to the token for disconnecting wireless network. Type **EFI\_80211\_DISCONNECT\_NETWORK\_TOKEN** is defined in Related Definitions below.

### Description

The **DisconnectNetwork()** function places a request to wireless UNDI driver to disconnect from the wireless network it is connected to. This function will trigger the wireless UNDI driver to perform disassociation and deauthentication process to terminate an existing connection. This function is always non-blocking. After wireless UNDI driver received acknowledgment frame from AP and freed up corresponding resources, the *Token->Event* will be signaled and *Token->Status* will be updated accordingly.

### Related Definitions

```
//*****
// EFI_80211_DISCONNECT_NETWORK_TOKEN //*****
typedef struct {
    EFI_EVENT    Event;
    EFI_STATUS   Status;
} EFI_80211_DISCONNECT_NETWORK_TOKEN;
```

*Event*

If the status code returned by **DisconnectNetwork()** is **EFI\_SUCCESS**, then this Event will be signaled after the Status field is updated by the EFI Wireless MAC

*Status*

Connection Protocol II driver. The type of Event must be **EFI\_NOTIFY\_SIGNAL**.

Will be set to one of the following values:

**EFI\_SUCCESS**: The operation completed successfully

**EFI\_DEVICE\_ERROR**: An unexpected network or system error occurred.

**EFI\_ACCESS\_DENIED**: The operation is not completed due to some underlying hardware or software state.

## Status Codes Returned

EFI_SUCCESS	The operation started successfully. Results will be notified eventually.
EFI_INVALID_PARAMETER	One or more of the following conditions is TRUE: This is NULL. Token is NULL.
EFI_UNSUPPORTED	One or more of the input parameters are not supported by this implementation.
EFI_NOT_FOUND	Not connected to a wireless network.
EFI_OUT_OF_RESOURCES	Required system resources could not be allocated.

## 26.5 EFI Supplicant Protocol

This section defines the EFI Supplicant Protocol.

### 26.5.1 Supplicant Service Binding Protocol

#### EFI\_SUPPLICANT\_SERVICE\_BINDING\_PROTOCOL

##### Summary

The EFI Supplicant Service Binding Protocol is used to locate EFI Supplicant Protocol drivers to create and destroy child of the driver to communicate with other host using Supplicant protocol.

GUID

```
#define EFI_SUPPLICANT_SERVICE_BINDING_PROTOCOL_GUID \
{ 0x45bcd98e, 0x59ad, 0x4174, \
  { 0x95, 0x46, 0x34, 0x4a, 0x7, 0x48, 0x58, 0x98 } }
```

##### Description

A module that requires supplicant services can call one of the protocol handler services, such as **BS->LocateHandleBuffer()**, to search devices that publish an EFI Supplicant Service Binding Protocol GUID. Such device supports the EFI Supplicant Protocol and may be available for use. After a successful call to the



**EFI\_SUPPLICANT\_SERVICE\_BINDING\_PROTOCOL.CreateChild()** function, the newly created child EFI Supplicant Protocol driver is in an un-configured state; it is not ready to do any operation until configured via **SetData()**. Every successful call to the **EFI\_SUPPLICANT\_SERVICE\_BINDING\_PROTOCOL.CreateChild()** function must be matched with a call to the **EFI\_SUPPLICANT\_SERVICE\_BINDING\_PROTOCOL.DestroyChild()** function to release the protocol driver.

## 26.5.2 Supplicant Protocol

### EFI\_SUPPLICANT\_PROTOCOL

#### Summary

This protocol provides services to process authentication and data encryption/decryption for security management.

#### GUID

```
#define EFI_SUPPLICANT_PROTOCOL_GUID \
  { 0x54fcc43e, 0xaa89, 0x4333, \
    { 0x9a, 0x85, 0xcd, 0xea, 0x24, 0x5, 0x1e, 0x9e } }
```

#### Protocol Interface Structure

```
typedef struct _EFI_SUPPLICANT_PROTOCOL {
  EFI_SUPPLICANT_BUILD_RESPONSE_PACKET BuildResponsePacket;
  EFI_SUPPLICANT_PROCESS_PACKET ProcessPacket;
  EFI_SUPPLICANT_SET_DATA SetData;
  EFI_SUPPLICANT_GET_DATA GetData;
} EFI_SUPPLICANT_PROTOCOL;
```

#### Parameters

<i>BuildResponsePacket</i>	This API processes security data for handling key management. See the <b>BuildResponsePacket()</b> function description.
<i>ProcessPacket</i>	This API processes frame for encryption or decryption. See the <b>ProcessPacket()</b> function description.
<i>SetData</i>	This API sets the information needed during key generated in handshake. See the <b>SetData()</b> function description.
<i>GetData</i>	This API gets the information generated in handshake. See the <b>GetData()</b> function description.

#### Description

The **EFI\_SUPPLICANT\_PROTOCOL** is designed to provide unified place for WIFI and EAP security management. Both PSK authentication and 802.1X EAP authentication can be

managed via this protocol and driver or application as a consumer can only focus on about packet transmitting or receiving. For 802.1X EAP authentication, an instance of **EFI\_EAP\_CONFIGURATION\_PROTOCOL** must be installed to the same handle as the EFI Supplicant Protocol.

## EFI\_SUPPLICANT\_PROTOCOL.BuildResponsePacket()

### Summary

**BuildResponsePacket()** is called during STA and AP authentication is in progress. Supplicant derives the PTK or session keys depend on type of authentication is being employed.

### Prototype

```
typedef
EFI_STATUS
(EFI_API *EFI_SUPPLICANT_BUILD_RESPONSE_PACKET)(
  IN EFI_SUPPLICANT_PROTOCOL *This,
  IN UINT8      *RequestBuffer, OPTIONAL
  IN UINTN     RequestBufferSize, OPTIONAL
  OUT UINT8     *Buffer,
  IN OUT UINTN  *BufferSize
);
```

### Parameters

<i>This</i>	Pointer to the <b>EFI_SUPPLICANT_PROTOCOL</b> instance.
<i>RequestBuffer</i>	Pointer to the most recently received EAPOL packet. <b>NULL</b> means the supplicant need initiate the EAP authentication session and send EAPOL-Start message.
<i>RequestSize</i>	Packet size in bytes for the most recently received EAPOL packet. 0 is only valid when <i>RequestBuffer</i> is <b>NULL</b> .
<i>Buffer</i>	Pointer to the buffer to hold the built packet.
<i>BufferSize</i>	Pointer to the buffer size in bytes. On input, it is the buffer size provided by the caller. On output, it is the buffer size in fact needed to contain the packet.

### Description

The consumer calls **BuildResponsePacket()** when it receives the security frame. It simply passes the data to supplicant to process the data. It could be WPA-PSK which starts the 4-way handshake, or WPA-EAP first starts with Authentication process and then 4-way handshake, or 2-way group key handshake. In process of authentication, 4-way handshake or group key handshake, Supplicant needs to communicate with its peer (AP/AS) to fill the output buffer parameter. Once the 4 way handshake or group key handshake is over, and PTK (Pairwise Transient keys) and GTK (Group Temporal Key) are generated.

### Status Codes Returned

EFI_SUCCESS	The required EAPOL packet is built successfully.
-------------	--

EFI_INVALID_PARAMETER	One or more of the following conditions is TRUE: <ul style="list-style-type: none"><li>• <i>RequestBuffer</i> is <b>NULL</b>, but <i>RequestSize</i> is NOT 0.</li><li>• <i>RequestSize</i> is 0.</li><li>• <i>Buffer</i> is <b>NULL</b>, but <i>RequestBuffer</i> is NOT 0.</li><li>• <i>RequestSize</i> is 0.</li><li>• <i>BufferSize</i> is <b>NULL</b>.</li></ul>
EFI_BUFFER_TOO_SMALL	<i>BufferSize</i> is too small to hold the response packet.
EFI_NOT_READY	Current EAPOL session state is NOT ready to build <i>ResponsePacket</i> .

## EFI\_SUPPLICANT\_PROTOCOL.ProcessPacket()

### Summary

**ProcessPacket()** is called to Supplicant driver to encrypt or decrypt the data depending type of authentication type.

### Prototype

```
typedef
EFI_STATUS
(EFI_API *EFI_SUPPLICANT_PROCESS_PACKET)(
  IN EFI_SUPPLICANT_PROTOCOL  *This,
  IN OUT EFI_SUPPLICANT_FRAGMENT_DATA  **FragmentTable,
  IN UINT32  *FragmentCount,
  IN EFI_SUPPLICANT_CRYPT_MODE  CryptMode
);
```

### Parameters

<i>This</i>	Pointer to the <b>EFI_SUPPLICANT_PROTOCOL</b> instance.
<i>FragmentTable</i>	Pointer to a list of fragment. The caller will take responsible to handle the original <i>FragmentTable</i> while it may be reallocated in Supplicant driver.
<i>FragmentCount</i>	Number of fragment.
<i>CryptMode</i>	Crypt mode.

### Description

**ProcessPacket()** is responsible for encrypting or decrypting the data traffic as per authentication type. The consumer routes the data frame as it is to Supplicant module and encrypts or decrypts packet with updated length comes as output parameter. Supplicant holds the derived PTK and GTKs and uses this key to encrypt or decrypt the network traffic.

If the Supplicant driver does not support any encryption and decryption algorithm, then **EFI\_UNSUPPORTED** is returned.

### Related Definitions

```
/**
//*****
// EFI_SUPPLICANT_FRAGMENT_DATA
//*****
typedef struct {
  UINT32  FragmentLength;
  VOID  *FragmentBuffer;
} EFI_SUPPLICANT_FRAGMENT_DATA;
```

<i>FragmentLength</i>	Length of data buffer in the fragment.
<i>FragmentBuffer</i>	Pointer to the data buffer in the fragment.

```

//*****
// EFI_SUPPLICANT_CRYPT_MODE
//*****
typedef enum {
  EfiSupplicantEncrypt,
  EfiSupplicantDecrypt,
} EFI_SUPPLICANT_CRYPT_MODE;

  EfiSupplicantEncrypt    Encrypt data provided in the fragment buffers.
  EfiSupplicantDecrypt   Decrypt data provided in the fragment buffers.

```

### Status Codes Returned

EFI_SUCCESS	The operation completed successfully.
EFI_INVALID_PARAMETER	One or more of the following conditions is TRUE: <ul style="list-style-type: none"> <li>• <i>FragmentTable</i> is NULL.</li> <li>• <i>FragmentCount</i> is NULL.</li> <li>• <i>CryptMode</i> is invalid.</li> </ul>
EFI_NOT_READY	Current supplicant state is NOT <b>Authenticated</b> .
EFI_ABORTED	Something wrong decryption the message.
EFI_UNSUPPORTED	This API is not supported.

## EFI\_SUPPLICANT\_PROTOCOL.SetData()

### Summary

Set Supplicant configuration data.

### Prototype

```
typedef
EFI_STATUS
(EFIAPI *EFI_SUPPLICANT_SET_DATA)(
  IN EFI_SUPPLICANT_PROTOCOL  *This,
  IN EFI_SUPPLICANT_DATA_TYPE  DataType,
  IN VOID                      *Data,
  IN UINTN                     DataSize
);
```

### Parameters

<i>This</i>	Pointer to the <b>EFI_SUPPLICANT_PROTOCOL</b> instance.
<i>DataType</i>	The type of data.
<i>Data</i>	Pointer to the buffer to hold the data.
<i>DataSize</i>	Pointer to the buffer size in bytes.

### Description

The **SetData()** function sets Supplicant configuration. For example, Supplicant driver need to know Password and TargetSSIDName to calculate PSK. Supplicant driver need to know StationMac and TargetSSIDMac to calculate PTK. Then it can derive KCK(key confirmation key) which is needed to calculate MIC, and KEK(key encryption key) which is needed to unwrap GTK.

## Related Definitions

```

//*****
// EFI_SUPPLICANT_DATA_TYPE
//*****
typedef enum {
//
// Session Configuration
//
EfiSupplicant80211AKMSuite,
EfiSupplicant80211GroupDataCipherSuite,
EfiSupplicant80211PairwiseCipherSuite,
EfiSupplicant80211PskPassword,
EfiSupplicant80211TargetSSIDName,
EfiSupplicant80211StationMac,
EfiSupplicant80211TargetSSIDMac,
//
// Session Information
//
EfiSupplicant80211PTK,
EfiSupplicant80211GTK,
EfiSupplicantState,
EfiSupplicant80211LinkState,
EfiSupplicantKeyRefresh,

//
// Session Configuration
//
EfiSupplicant80211SupportedAKMSuites,
EfiSupplicant80211SupportedSoftwareCipherSuites,
EfiSupplicant80211SupportedHardwareCipherSuites,

//
// Session Information
//
EfiSupplicant80211IGTK,
EfiSupplicant80211PMK,
EfiSupplicantDataTypeMaximum
} EFI_SUPPLICANT_DATA_TYPE;

```

*EfiSupplicant80211AKMSuite*

Current authentication type in use. The corresponding *Data* is of type **EFI\_80211\_AKM\_SUITE\_SELECTOR**.

*EfiSupplicant80211GroupDataCipherSuite*

Group data encryption type in use. The corresponding *Data* is of type **EFI\_80211\_CIPHER\_SUITE\_SELECTOR**.



*EfiSupplicant80211PairwiseCipherSuite*

Pairwise encryption type in use. The corresponding *Data* is of type **EFI\_80211\_CIPHER\_SUITE\_SELECTOR**.

*EfiSupplicant80211PskPassword*

PSK password. The corresponding *Data* is a NULL-terminated ASCII string.

*EfiSupplicant80211TargetSSIDName*

Target SSID name. The corresponding *Data* is of type **EFI\_80211\_SSID**.

*EfiSupplicant80211StationMac*

Station MAC address. The corresponding *Data* is of type **EFI\_80211\_MAC\_ADDRESS**.

*EfiSupplicant80211TargetSSIDMac*

Target SSID MAC address. The corresponding *Data* is 6 bytes MAC address.

*EfiSupplicant80211PTK*

802.11 PTK. The corresponding *Data* is of type **EFI\_SUPPLICANT\_KEY**.

*EfiSupplicant80211GTK*

802.11 GTK. The corresponding *Data* is of type **EFI\_SUPPLICANT\_GTK\_LIST**.

*EfiSupplicantState*

Supplicant state. The corresponding *Data* is **EFI\_EAPOL\_SUPPLICANT\_PAE\_STATE**.

*EfiSupplicant80211LinkState*

802.11 link state. The corresponding *Data* is **EFI\_80211\_LINK\_STATE**.

*EfiSupplicantKeyRefresh*

Flag indicates key is refreshed. The corresponding *Data* is **EFI\_SUPPLICANT\_KEY\_REFRESH**.

*EfiSupplicant80211SupportedAKMSuites*

Supported authentication types. The corresponding *Data* is of type **EFI\_80211\_AKM\_SUITE\_SELECTOR**.

*EfiSupplicant80211SupportedSoftwareCipherSuites*

Supported software encryption types provided by supplicant driver. The corresponding *Data* is of type **EFI\_80211\_CIPHER\_SUITE\_SELECTOR**.

*EfiSupplicant80211SupportedHardwareCipherSuites*

Supported hardware encryption types provided by wireless UNDI driver. The corresponding *Data* is of type **EFI\_80211\_CIPHER\_SUITE\_SELECTOR**.

*EfiSupplicant80211IGTK*

802.11 Integrity GTK. The corresponding *Data* is of type **EFI\_SUPPLICANT\_GTK\_LIST**.

*EfiSupplicant80211IPMK*

802.11 PMK. The corresponding *Data* is 32 bytes pairwise master key.

```
//*****
```

```
// EFI_80211_LINK_STATE
```

```
//*****
```

```
typedef enum {
  IEEE80211UnauthenticatedUnassociated,
  IEEE80211AuthenticatedUnassociated,
  IEEE80211PendingRSNAAuthentication,
  IEEE80211AuthenticatedAssociated
} EFI_80211_LINK_STATE;
```

*IEEE80211UnauthenticatedUnassociated*

Indicates initial start state, unauthenticated, unassociated.

*IEEE80211AuthenticatedUnassociated*

Indicates authenticated, unassociated.

*IEEE80211PendingRSNAAuthentication*

Indicates authenticated and associated, but pending RSN authentication.

*IEEE80211AuthenticatedAssociated*

Indicates authenticated and associated.

```
//*****
```

```
// EFI_SUPPLICANT_KEY_REFRESH
```

```
//*****
```

```
typedef struct {
  BOOLEAN      GTKRefresh;
} EFI_SUPPLICANT_KEY_REFRESH;
```

*GTKRefresh*

If TRUE, indicates GTK is just refreshed after a successful call to **EFI\_SUPPLICANT\_PROTOCOL.BuildResponsePacket()**.

```

//*****
// EFI_SUPPLICANT_GTK_LIST
//*****
typedef struct {
    UINT8          GTKCount;
    EFI_SUPPLICANT_KEY GTKList[1];
} EFI_SUPPLICANT_GTK_LIST;

```

*GTKCount* Indicates the number of GTKs that are contained in *GTKList*.

*GTKList* A variable-length array of GTKs of type **EFI\_SUPPLICANT\_KEY**. The number of entries is specified by *GTKCount*.

```
#define EFI_MAX_KEY_LEN 64
```

```

//*****
// EFI_SUPPLICANT_KEY
//*****
typedef struct {
    UINT8      Key[EFI_MAX_KEY_LEN];
    UINT8      KeyLen;
    UINT8      KeyId;
    EFI_SUPPLICANT_KEY_TYPE KeyType;
    EFI_80211_MAC_ADDRESS Addr;
    UINT8      Rsc[8];
    UINT8      RscLen;
    BOOLEAN     IsAuthenticator;
    EFI_80211_SUITE_SELECTOR CipherSuite;
    EFI_SUPPLICANT_KEY_DIRECTION Direction;
} EFI_SUPPLICANT_KEY;

```

The **EFI\_SUPPLICANT\_KEY** descriptor is defined in the IEEE 802.11 standard, section 6.3.19.1.2.

*Key* The key value.

*KeyLen* Length in bytes of the *Key*. Should be up to **EFI\_MAX\_KEY\_LEN**.

*KeyId* The key identifier.

*KeyType* Defines whether this key is a group key, pairwise key, PeerKey, or Integrity Group.

*Addr* The value is set according to the *KeyType*.

*RSC* The Receive Sequence Count value.

*RscLen* Length in bytes of the *Rsc*. Should be up to 8.

*IsAuthenticator* Indicates whether the key is configured by the Authenticator or Supplicant. The value true indicates Authenticator.

*CipherSuite* The cipher suite required for this association.

*Direction* Indicates the direction for which the keys are to be installed.

```

//*****
// EFI_SUPPLICANT_KEY_TYPE (IEEE Std 802.11
//      Section 6.3.19.1.2)
//*****
typedef enum {
    Group,
    Pairwise,
    PeerKey,
    IGTK
} EFI_SUPPLICANT_KEY_TYPE;
    
```

The **EFI\_SUPPLICANT\_KEY\_TYPE** is defined in the IEEE 802.11 specification.

```

//*****
// EFI_SUPPLICANT_KEY_DIRECTION (IEEE Std 802.11
//      Section 6.3.19.1.2)
//*****
typedef enum {
    Receive,
    Transmit,
    Both
} EFI_SUPPLICANT_KEY_DIRECTION;
    
```

*Receive* Indicates that the keys are being installed for the receive direction.

*Transmit* Indicates that the keys are being installed for the transmit direction.

*Both* Indicates that the keys are being installed for both the receive and transmit directions.

### Status Codes Returned

EFI_SUCCESS	The Supplicant configuration data is set successfully.
EFI_INVALID_PARAMETER	One or more of the following conditions is TRUE: <ul style="list-style-type: none"> <li>• <i>Data</i> is NULL.</li> <li>• <i>DataSize</i> is 0.</li> </ul>
EFI_UNSUPPORTED	The <i>Data Type</i> is unsupported.

EFI_OUT_OF_RESOURCES	Required system resources could not be allocated.
----------------------	---

## EFI\_SUPPLICANT\_PROTOCOL.GetData()

### Summary

Get Supplicant configuration data.

### Prototype

```
typedef
EFI_STATUS
(EFI_API *EFI_SUPPLICANT_GET_DATA)(
  IN EFI_SUPPLICANT_PROTOCOL  *This,
  IN EFI_SUPPLICANT_DATA_TYPE  DataType,
  OUT UINT8                    *Data, OPTIONAL
  IN OUT UINTN                 *DataSize
);
```

### Parameters

<i>This</i>	Pointer to the <b>EFI_SUPPLICANT_PROTOCOL</b> instance.
<i>DataType</i>	The type of data.
<i>Data</i>	Pointer to the buffer to hold the data. Ignored if <i>DataSize</i> is 0.
<i>DataSize</i>	Pointer to the buffer size in bytes. On input, it is the buffer size provided by the caller. On output, it is the buffer size in fact needed to contain the packet.

### Description

The **GetData()** function gets Supplicant configuration. The typical example is PTK and GTK derived from handshake. The wireless NIC can support software encryption or hardware encryption. If the consumer uses software encryption, it can call **ProcessPacket()** to get result. If the consumer supports hardware encryption, it can get PTK and GTK via **GetData()** and program to hardware register.

### Status Codes Returned

EFI_SUCCESS	The Supplicant configuration data is got successfully.
EFI_INVALID_PARAMETER	One or more of the following conditions is TRUE: <ul style="list-style-type: none"> <li><i>This</i> is NULL.</li> <li><i>DataSize</i> is NULL.</li> <li><i>Data</i> is NULL if <i>*DataSize</i> is not zero.</li> </ul>
EFI_UNSUPPORTED	The <i>DataType</i> is unsupported.
EFI_NOT_FOUND	The Supplicant configuration data is not found.
EFI_BUFFER_TOO_SMALL	The size of <i>Data</i> is too small for the specified configuration data and the required size is returned in <i>DataSize</i> .

## 27 Network Protocols — Bluetooth

### 27.1 EFI Bluetooth Host Controller Protocol

#### EFI\_BLUETOOTH\_HC\_PROTOCOL

##### Summary

This protocol abstracts the Bluetooth host controller layer message transmit and receive.

##### GUID

```
#define EFI_BLUETOOTH_HC_PROTOCOL_GUID \
{ 0xb3930571, 0xbeba, 0x4fc5,
  { 0x92, 0x3, 0x94, 0x27, 0x24, 0x2e, 0x6a, 0x43 }}
```

##### Protocol Interface Structure

```
typedef struct _EFI_BLUETOOTH_HC_PROTOCOL {
  EFI_BLUETOOTH_HC_SEND_COMMAND    SendCommand;
  EFI_BLUETOOTH_HC_RECEIVE_EVENT    ReceiveEvent;
  EFI_BLUETOOTH_HC_ASYNC_RECEIVE_EVENT AsyncReceiveEvent;
  EFI_BLUETOOTH_HC_SEND_ACL_DATA    SendACLData;
  EFI_BLUETOOTH_HC_RECEIVE_ACL_DATA ReceiveACLData;
  EFI_BLUETOOTH_HC_ASYNC_RECEIVE_ACL_DATA AsyncReceiveACLData;
  EFI_BLUETOOTH_HC_SEND_SCO_DATA    SendSCOData;
  EFI_BLUETOOTH_HC_RECEIVE_SCO_DATA ReceiveSCOData;
  EFI_BLUETOOTH_HC_ASYNC_RECEIVE_SCO_DATA AsyncReceiveSCOData;
} EFI_BLUETOOTH_HC_PROTOCOL;
```

##### Parameters

<i>SendCommand</i>	Send HCI command packet. See the <b>SendCommand()</b> function description.
<i>ReceiveEvent</i>	Receive HCI event packets. See the <b>ReceiveEvent()</b> function description.
<i>AsyncReceiveEvent</i>	Non-blocking receive HCI event packets. See the <b>AsyncReceiveEvent()</b> function description.
<i>SendACLData</i>	Send HCI ACL (asynchronous connection-oriented) data packets. See the <b>SendACLData()</b> function description.
<i>ReceiveACLData</i>	Receive HCI ACL data packets. See the <b>ReceiveACLData()</b> function description.
<i>AsyncReceiveACLData</i>	Non-blocking receive HCI ACL data packets. See the <b>AsyncReceiveACLData()</b> function description.
<i>SendSCOData</i>	Send HCI synchronous (SCO and eSCO) data packets. See the <b>SendSCOData()</b> function description.

*ReceiveSCOData* Receive HCI synchronous data packets. See the **ReceiveSCOData()** function description.

*AsyncReceiveSCOData* Non-blocking receive HCI synchronous data packets. See the **AsyncReceiveSCOData()** function description.

## Description

The **EFI\_BLUETOOTH\_HC\_PROTOCOL** is used to transmit or receive HCI layer data packets. For detail of different HCI packet (command, event, ACL, SCO), please refer to Bluetooth specification.



## BLUETOOTH\_HC\_PROTOCOL.SendCommand()

### Summary

Send HCI command packet.

### Prototype

```
typedef
EFI_STATUS
(EFI_API *EFI_BLUETOOTH_HC_SEND_COMMAND)(
  IN EFI_BLUETOOTH_HC_PROTOCOL *This,
  IN OUT UINTN *BufferSize,
  IN VOID *Buffer,
  IN UINTN Timeout
);
```

### Parameters

<i>This</i>	Pointer to the <b>EFI_BLUETOOTH_HC_PROTOCOL</b> instance.
<i>BufferSize</i>	On input, indicates the size, in bytes, of the data buffer specified by <i>Buffer</i> . On output, indicates the amount of data actually transferred.
<i>Buffer</i>	A pointer to the buffer of data that will be transmitted to Bluetooth host controller.
<i>Timeout</i>	Indicating the transfer should be completed within this time frame. The units are in milliseconds. If <i>Timeout</i> is 0, then the caller must wait for the function to be completed until <b>EFI_SUCCESS</b> or <b>EFI_DEVICE_ERROR</b> is returned.

### Description

The **SendCommand()** function sends HCI command packet. *Buffer* holds the whole HCI command packet, including OpCode, OCF, OGF, parameter length, and parameters. When this function is returned, it just means the HCI command packet is sent, it does not mean the command is success or complete. Caller might need to wait a command status event to know the command status, or wait a command complete event to know if the command is completed. (see in Bluetooth specification, HCI Command Packet for more detail)

### Status Codes Returned

EFI_SUCCESS	The HCI command packet is sent successfully.
EFI_INVALID_PARAMETER	One or more of the following conditions is TRUE: <i>BufferSize</i> is NULL. <i>*BufferSize</i> is 0. <i>Buffer</i> is NULL.
EFI_TIMEOUT	Sending HCI command packet fail due to timeout.

EFI_DEVICE_ERROR	Sending HCI command packet fail due to host controller or device error.
------------------	---

## BLUETOOTH\_HC\_PROTOCOL.ReceiveEvent()

### Summary

Receive HCI event packet.

### Prototype

```
typedef
EFI_STATUS
(EFI_API *EFI_BLUETOOTH_HC_RECEIVE_EVENT)(
  IN EFI_BLUETOOTH_HC_PROTOCOL *This,
  IN OUT UINTN *BufferSize,
  OUT VOID *Buffer,
  IN UINTN Timeout
);
```

### Parameters

<i>This</i>	Pointer to the <b>EFI_BLUETOOTH_HC_PROTOCOL</b> instance.
<i>BufferSize</i>	On input, indicates the size, in bytes, of the data buffer specified by <i>Buffer</i> . On output, indicates the amount of data actually transferred.
<i>Buffer</i>	A pointer to the buffer of data that will be received from Bluetooth host controller.
<i>Timeout</i>	Indicating the transfer should be completed within this time frame. The units are in milliseconds. If <i>Timeout</i> is 0, then the caller must wait for the function to be completed until <b>EFI_SUCCESS</b> or <b>EFI_DEVICE_ERROR</b> is returned.

### Description

The **ReceiveEvent()** function receives HCI event packet. *Buffer* holds the whole HCI event packet, including *EventCode*, parameter length, and parameters. (See in Bluetooth specification, HCI Event Packet for more detail.)

### Status Codes Returned

EFI_SUCCESS	The HCI event packet is received successfully.
EFI_INVALID_PARAMETER	One or more of the following conditions is TRUE: <ul style="list-style-type: none"> <li><i>BufferSize</i> is NULL.</li> <li><i>*BufferSize</i> is 0.</li> <li><i>Buffer</i> is NULL.</li> </ul>
EFI_TIMEOUT	Receiving HCI event packet fail due to timeout.
EFI_DEVICE_ERROR	Receiving HCI event packet fail due to host controller or device error.

## BLUETOOTH\_HC\_PROTOCOL.AsyncReceiveEvent()

### Summary

Receive HCI event packet in non-blocking way.

### Prototype

```
typedef
EFI_STATUS
(EFI_API *EFI_BLUETOOTH_HC_ASYNC_RECEIVE_EVENT) (
  IN EFI_BLUETOOTH_HC_PROTOCOL    *This,
  IN BOOLEAN                       IsNewTransfer,
  IN UINTN                         PollingInterval,
  IN UINTN                         DataLength,
  IN EFI_BLUETOOTH_HC_ASYNC_FUNC_CALLBACK Callback,
  IN VOID                          *Context
);
```

### Parameters

<i>This</i>	Pointer to the <b>EFI_BLUETOOTH_HC_PROTOCOL</b> instance.
<i>IsNewTransfer</i>	If <b>TRUE</b> , a new transfer will be submitted. If <b>FALSE</b> , the request is deleted.
<i>PollingInterval</i>	Indicates the periodic rate, in milliseconds, that the transfer is to be executed.
<i>DataLength</i>	Specifies the length, in bytes, of the data to be received.
<i>Callback</i>	The callback function. This function is called if the asynchronous transfer is completed.
<i>Context</i>	Data passed into <i>Callback</i> function. This is optional parameter and may be <b>NULL</b> .

### Description

The **AsyncReceiveEvent()** function receives HCI event packet in non-blocking way. *Data* in *Callback* function holds the whole HCI event packet, including *EventCode*, parameter length, and parameters. (See in Bluetooth specification, HCI Event Packet for more detail.)

### Related Definitions

```
typedef
EFI_STATUS
(EFI_API *EFI_BLUETOOTH_HC_ASYNC_FUNC_CALLBACK) (
  IN VOID    *Data,
  IN UINTN   DataLength,
  IN VOID    *Context
);
```

<i>Data</i>	Data received via asynchronous transfer.
-------------	--

- DataLength* The length of *Data* in bytes, received via asynchronous transfer.
- Context* Context passed from asynchronous transfer request.

### Status Codes Returned

EFI_SUCCESS	The HCI asynchronous receive request is submitted successfully.
EFI_INVALID_PARAMETER	One or more of the following conditions is TRUE: <ul style="list-style-type: none"><li>• <i>DataLength</i> is 0.</li><li>• If <i>IsNewTransfer</i> is <b>TRUE</b>, and an asynchronous receive request already exists.</li></ul>

## BLUETOOTH\_HC\_PROTOCOL.SendACLData()

### Summary

Send HCI ACL data packet.

### Prototype

```
typedef
EFI_STATUS
(EFI_API *EFI_BLUETOOTH_HC_SEND_ACL_DATA)(
  IN EFI_BLUETOOTH_HC_PROTOCOL *This,
  IN OUT UINTN *BufferSize,
  IN VOID *Buffer,
  IN UINTN Timeout
);
```

### Parameters

<i>This</i>	Pointer to the <b>EFI_BLUETOOTH_HC_PROTOCOL</b> instance.
<i>BufferSize</i>	On input, indicates the size, in bytes, of the data buffer specified by <i>Buffer</i> . On output, indicates the amount of data actually transferred.
<i>Buffer</i>	A pointer to the buffer of data that will be transmitted to Bluetooth host controller.
<i>Timeout</i>	Indicating the transfer should be completed within this time frame. The units are in milliseconds. If <i>Timeout</i> is 0, then the caller must wait for the function to be completed until <b>EFI_SUCCESS</b> or <b>EFI_DEVICE_ERROR</b> is returned.

### Description

The **SendACLData()** function sends HCI ACL data packet. *Buffer* holds the whole HCI ACL data packet, including Handle, PB flag, BC flag, data length, and data. (see in Bluetooth specification, HCI ACL Data Packet for more detail)

The **SendACLData()** function and **ReceiveACLData()** function just send and receive data payload from application layer. In order to protect the payload data, the Bluetooth bus is required to call Hci\_Set\_Connection\_Encryption command to enable hardware based encryption after authentication completed, according to pairing mode and host capability.

### Status Codes Returned

EFI_SUCCESS	The HCI ACL data packet is sent successfully.
EFI_INVALID_PARAMETER	One or more of the following conditions is TRUE: <ul style="list-style-type: none"> <li><i>BufferSize</i> is NULL.</li> <li><i>*BufferSize</i> is 0.</li> <li><i>Buffer</i> is NULL.</li> </ul>

EFI_TIMEOUT	Sending HCI ACL data packet fail due to timeout.
EFI_DEVICE_ERROR	Sending HCI ACL data packet fail due to host controller or device error.

## BLUETOOTH\_HC\_PROTOCOL.ReceiveACLData()

### Summary

Receive HCI ACL data packet.

### Prototype

```
typedef
EFI_STATUS
(EFIAPI *EFI_BLUETOOTH_HC_RECEIVE_ACL_DATA)(
  IN EFI_BLUETOOTH_HC_PROTOCOL *This,
  IN OUT UINTN *BufferSize,
  OUT VOID *Buffer,
  IN UINTN Timeout
);
```

### Parameters

<i>This</i>	Pointer to the <b>EFI_BLUETOOTH_HC_PROTOCOL</b> instance.
<i>BufferSize</i>	On input, indicates the size, in bytes, of the data buffer specified by <i>Buffer</i> . On output, indicates the amount of data actually transferred.
<i>Buffer</i>	A pointer to the buffer of data that will be received from Bluetooth host controller.
<i>Timeout</i>	Indicating the transfer should be completed within this time frame. The units are in milliseconds. If <i>Timeout</i> is 0, then the caller must wait for the function to be completed until <b>EFI_SUCCESS</b> or <b>EFI_DEVICE_ERROR</b> is returned.

### Description

The **ReceiveACLData()** function receives HCI ACL data packet. *Buffer* holds the whole HCI ACL data packet, including Handle, PB flag, BC flag, data length, and data. (See in Bluetooth specification, HCI ACL Data Packet for more detail.)

### Status Codes Returned

EFI_SUCCESS	The HCI ACL data packet is received successfully.
EFI_INVALID_PARAMETER	One or more of the following conditions is TRUE: <ul style="list-style-type: none"> <li><i>BufferSize</i> is NULL.</li> <li><i>*BufferSize</i> is 0.</li> <li><i>Buffer</i> is NULL.</li> </ul>
EFI_TIMEOUT	Receiving HCI ACL data packet fail due to timeout.
EFI_DEVICE_ERROR	Receiving HCI ACL data packet fail due to host controller or device error.



## BLUETOOTH\_HC\_PROTOCOL.AsyncReceiveACLData()

### Summary

Receive HCI ACL data packet in non-blocking way.

### Prototype

```
typedef
EFI_STATUS
(EFIAPI *EFI_BLUETOOTH_HC_ASYNC_RECEIVE_ACL_DATA) (
  IN EFI_BLUETOOTH_HC_PROTOCOL  *This,
  IN BOOLEAN                    IsNewTransfer,
  IN UINTN                      PollingInterval,
  IN UINTN                      DataLength,
  IN EFI_BLUETOOTH_HC_ASYNC_FUNC_CALLBACK Callback,
  IN VOID                       *Context
);
```

### Parameters

<i>This</i>	Pointer to the <b>EFI_BLUETOOTH_HC_PROTOCOL</b> instance.
<i>IsNewTransfer</i>	If <b>TRUE</b> , a new transfer will be submitted. If <b>FALSE</b> , the request is deleted.
<i>PollingInterval</i>	Indicates the periodic rate, in milliseconds, that the transfer is to be executed.
<i>DataLength</i>	Specifies the length, in bytes, of the data to be received.
<i>Callback</i>	The callback function. This function is called if the asynchronous transfer is completed.
<i>Context</i>	Data passed into <i>Callback</i> function. This is optional parameter and may be NULL.

### Description

The **AsyncReceiveACLData()** function receives HCI ACL data packet in non-blocking way. *Data* in *Callback* holds the whole HCI ACL data packet, including Handle, PB flag, BC flag, data length, and data. (See in Bluetooth specification, HCI ACL Data Packet for more detail.)

### Status Codes Returned

EFI_SUCCESS	The HCI asynchronous receive request is submitted successfully.
EFI_INVALID_PARAMETER	One or more of the following conditions is TRUE: <ul style="list-style-type: none"> <li><i>DataLength</i> is 0.</li> <li>If <i>IsNewTransfer</i> is <b>TRUE</b>, and an asynchronous receive request already exists.</li> </ul>

## BLUETOOTH\_HC\_PROTOCOL.SendSCOData()

### Summary

Send HCI SCO data packet.

### Prototype

```
typedef
EFI_STATUS
(EFIAPI *EFI_BLUETOOTH_HC_SEND_SCO_DATA)(
  IN EFI_BLUETOOTH_HC_PROTOCOL *This,
  IN OUT UINTN *BufferSize,
  IN VOID *Buffer,
  IN UINTN Timeout
);
```

### Parameters

<i>This</i>	Pointer to the <b>EFI_BLUETOOTH_HC_PROTOCOL</b> instance.
<i>BufferSize</i>	On input, indicates the size, in bytes, of the data buffer specified by <i>Buffer</i> . On output, indicates the amount of data actually transferred.
<i>Buffer</i>	A pointer to the buffer of data that will be transmitted to Bluetooth host controller.
<i>Timeout</i>	Indicating the transfer should be completed within this time frame. The units are in milliseconds. If <i>Timeout</i> is 0, then the caller must wait for the function to be completed until <b>EFI_SUCCESS</b> or <b>EFI_DEVICE_ERROR</b> is returned.

### Description

The **SendSCOData()** function sends HCI SCO data packet. *Buffer* holds the whole HCI SCO data packet, including *ConnectionHandle*, *PacketStatus* flag, data length, and data. (See in Bluetooth specification, HCI Synchronous Data Packet for more detail.)

### Status Codes Returned

EFI_SUCCESS	The HCI SCO data packet is sent successfully.
EFI_UNSUPPORTED	The implementation does not support HCI SCO transfer.
EFI_INVALID_PARAMETER	One or more of the following conditions is TRUE: <ul style="list-style-type: none"> <li><i>BufferSize</i> is NULL.</li> <li><i>*BufferSize</i> is 0.</li> <li><i>Buffer</i> is NULL.</li> </ul>
EFI_TIMEOUT	Sending HCI SCO data packet fail due to timeout.
EFI_DEVICE_ERROR	Sending HCI SCO data packet fail due to host controller or device error.

## BLUETOOTH\_HC\_PROTOCOL.ReceiveSCOData()

### Summary

Receive HCI SCO data packet.

### Prototype

```
typedef
EFI_STATUS
(EFI_API *EFI_BLUETOOTH_HC_RECEIVE_SCO_DATA)(
  IN EFI_BLUETOOTH_HC_PROTOCOL *This,
  IN OUT UINTN *BufferSize,
  OUT VOID *Buffer,
  IN UINTN Timeout
);
```

### Parameters

<i>This</i>	Pointer to the <b>EFI_BLUETOOTH_HC_PROTOCOL</b> instance.
<i>BufferSize</i>	On input, indicates the size, in bytes, of the data buffer specified by <i>Buffer</i> . On output, indicates the amount of data actually transferred.
<i>Buffer</i>	A pointer to the buffer of data that will be received from Bluetooth host controller.
<i>Timeout</i>	Indicating the transfer should be completed within this time frame. The units are in milliseconds. If <i>Timeout</i> is 0, then the caller must wait for the function to be completed until <b>EFI_SUCCESS</b> or <b>EFI_DEVICE_ERROR</b> is returned.

### Description

The **ReceiveSCOData()** function receives HCI SCO data packet. *Buffer* holds the whole HCI SCO data packet, including ConnectionHandle, PacketStatus flag, data length, and data. (see in Bluetooth specification, HCI Synchronous Data Packet for more detail)

### Status Codes Returned

EFI_SUCCESS	The HCI SCO data packet is received successfully.
EFI_INVALID_PARAMETER	One or more of the following conditions is TRUE: <ul style="list-style-type: none"> <li><i>BufferSize</i> is NULL.</li> <li><i>*BufferSize</i> is 0.</li> <li><i>Buffer</i> is NULL.</li> </ul>
EFI_TIMEOUT	Receiving HCI SCO data packet fail due to timeout.
EFI_DEVICE_ERROR	Receiving HCI SCO data packet fail due to host controller or device error.

## BLUETOOTH\_HC\_PROTOCOL.AsyncReceiveSCOData()

### Summary

Receive HCI SCO data packet in non-blocking way.

### Prototype

```
typedef
EFI_STATUS
(EFI_API *EFI_BLUETOOTH_HC_ASYNC_RECEIVE_SCO_DATA) (
  IN EFI_BLUETOOTH_HC_PROTOCOL  *This,
  IN BOOLEAN                    IsNewTransfer,
  IN UINTN                      PollingInterval,
  IN UINTN                      DataLength,
  IN EFI_BLUETOOTH_HC_ASYNC_FUNC_CALLBACK Callback,
  IN VOID                       *Context
);
```

### Parameters

<i>This</i>	Pointer to the <b>EFI_BLUETOOTH_HC_PROTOCOL</b> instance.
<i>IsNewTransfer</i>	If <b>TRUE</b> , a new transfer will be submitted. If <b>FALSE</b> , the request is deleted.
<i>PollingInterval</i>	Indicates the periodic rate, in milliseconds, that the transfer is to be executed.
<i>DataLength</i>	Specifies the length, in bytes, of the data to be received.
<i>Callback</i>	The callback function. This function is called if the asynchronous transfer is completed.
<i>Context</i>	Data passed into <i>Callback</i> function. This is optional parameter and may be <b>NULL</b> .

### Description

The **AsyncReceiveSCOData()** function receives HCI SCO data packet in non-blocking way. *Data* in *Callback* holds the whole HCI SCO data packet, including *ConnectionHandle*, *PacketStatus* flag, data length, and data. (See in Bluetooth specification, HCI SCO Data Packet for more detail.)

## Status Codes Returned

EFI_SUCCESS	The HCI asynchronous receive request is submitted successfully.
EFI_INVALID_PARAMETER	One or more of the following conditions is TRUE: <ul style="list-style-type: none"> <li>• <i>DataLength</i> is 0.</li> <li>• If <i>IsNewTransfer</i> is <b>TRUE</b>, and an asynchronous receive request already exists.</li> </ul>

## 27.2 EFI Bluetooth Bus Protocol

### EFI\_BLUETOOTH\_IO\_SERVICE\_BINDING\_PROTOCOL

#### Summary

The EFI Bluetooth IO Service Binding Protocol is used to locate EFI Bluetooth IO Protocol drivers to create and destroy child of the driver to communicate with other Bluetooth device by using Bluetooth IO protocol.

#### GUID

```
#define EFI_BLUETOOTH_IO_SERVICE_BINDING_PROTOCOL_GUID \
{ 0x388278d3, 0x7b85, 0x42f0, \
  { 0xab, 0xa9, 0xfb, 0x4b, 0xfd, 0x69, 0xf5, 0xab } }
```

#### Description

The Bluetooth IO consumer need locate **EFI\_BLUETOOTH\_IO\_SERVICE\_BINDING\_PROTOCOL** and call **CreateChild()** to create a new child of **EFI\_BLUETOOTH\_IO\_PROTOCOL** instance. Then use **EFI\_BLUETOOTH\_IO\_PROTOCOL** for Bluetooth communication. After use, the Bluetooth IO consumer need call **DestroyChild()** to destroy it.

### EFI\_BLUETOOTH\_IO\_PROTOCOL

#### Summary

This protocol provides service for Bluetooth L2CAP (Logical Link Control and Adaptation Protocol) and SDP (Service Discovery Protocol).

## GUID

```
#define EFI_BLUETOOTH_IO_PROTOCOL_GUID \
{ 0x467313de, 0x4e30, 0x43f1, \
  { 0x94, 0x3e, 0x32, 0x3f, 0x89, 0x84, 0x5d, 0xb5 } }
```

## Protocol Interface Structure

```
typedef struct _EFI_BLUETOOTH_IO_PROTOCOL {
  EFI_BLUETOOTH_IO_GET_DEVICE_INFO    GetDeviceInfo;
  EFI_BLUETOOTH_IO_GET_SDP_INFO      GetSdpInfo;
  EFI_BLUETOOTH_IO_L2CAP_RAW_SEND    L2CapRawSend;
  EFI_BLUETOOTH_IO_L2CAP_RAW_RECEIVE L2CapRawReceive;
  EFI_BLUETOOTH_IO_L2CAP_RAW_ASYNC_RECEIVE\
    L2CapRawAsyncReceive;
  EFI_BLUETOOTH_IO_L2CAP_SEND        L2CapSend;
  EFI_BLUETOOTH_IO_L2CAP_RECEIVE     L2CapReceive;
  EFI_BLUETOOTH_IO_L2CAP_ASYNC_RECEIVE L2CapAsyncReceive;
  EFI_BLUETOOTH_IO_L2CAP_CONNECT     L2CapConnect;
  EFI_BLUETOOTH_IO_L2CAP_DISCONNECT L2CapDisconnect;
  EFI_BLUETOOTH_IO_L2CAP_REGISTER_SERVICE\
    L2CapRegisterService;
} EFI_BLUETOOTH_IO_PROTOCOL;
```

## Parameters

<i>GetDeviceInfo</i>	Get Bluetooth device Information. See the <b>GetDeviceInfo()</b> function description.
<i>GetSdpInfo</i>	Get Bluetooth device SDP information. See the <b>GetSdpInfo()</b> function description.
<i>L2CapRawSend</i>	Send L2CAP message (including L2CAP header). See the <b>L2CapRawSend()</b> function description.
<i>L2CapRawReceive</i>	Receive L2CAP message (including L2CAP header). See the <b>L2CapRawReceive()</b> function description.
<i>L2CapRawAsyncReceive</i>	Non-blocking receive L2CAP message (including L2CAP header). See the <b>L2CapRawAsyncReceive()</b> function description.
<i>L2CapSend</i>	Send L2CAP message (excluding L2CAP header) to a specific channel. See the <b>L2CapSend()</b> function description.
<i>L2CapReceive</i>	Receive L2CAP message (excluding L2CAP header) from a specific channel. See the <b>L2CapRawReceive()</b> function description.
<i>L2CapAsyncReceive</i>	Non-blocking receive L2CAP message (excluding L2CAP header) from a specific channel. See the <b>L2CapRawAsyncReceive()</b> function description.

<i>L2CapConnect</i>	Do L2CAP connection. See the <b>L2CapConnect()</b> function description.
<i>L2CapDisconnect</i>	Do L2CAP disconnection. See the <b>L2CapDisconnect()</b> function description.
<i>L2CapRegisterService</i>	Register L2CAP callback function for special channel. See the <b>L2CapRegisterService()</b> function description.

## Description

The **EFI\_BLUETOOTH\_IO\_PROTOCOL** provides services in L2CAP protocol and SDP protocol. For detail of L2CAP packet format, and SDP service, please refer to Bluetooth specification.

## BLUETOOTH\_IO\_PROTOCOL.GetDeviceInfo

### Summary

Get Bluetooth device information.

### Prototype

```
typedef
EFI_STATUS
(EFIAPI *EFI_BLUETOOTH_IO_GET_DEVICE_INFO)(
  IN EFI_BLUETOOTH_IO_PROTOCOL *This,
  OUT UINTN          *DeviceInfoSize,
  OUT VOID          **DeviceInfo
);
```

### Parameters

<i>This</i>	Pointer to the <b>EFI_BLUETOOTH_IO_PROTOCOL</b> instance.
<i>DeviceInfoSize</i>	A pointer to the size, in bytes, of the <i>DeviceInfo</i> buffer.
<i>DeviceInfo</i>	A pointer to a callee allocated buffer that returns Bluetooth device information. Callee allocates this buffer by using EFI Boot Service <b>AllocatePool()</b> .

### Description

The **GetDeviceInfo()** function returns Bluetooth device information. The size of *DeviceInfo* structure should never be assumed and the value of *DeviceInfoSize* is the only valid way to know the size of *DeviceInfo*.

### Related Definitions

```
typedef struct {
  UINT32      Version;
  BLUETOOTH_ADDRESS  BD_ADDR;
  UINT8      PageScanRepetitionMode;
  BLUETOOTH_CLASS_OF_DEVICE  ClassOfDevice;
  UINT16     ClockOffset;
  UINT8      RSSI;
  UINT8      ExtendedInquiryResponse[240];
} EFI_BLUETOOTH_DEVICE_INFO;
```

<i>Version</i>	The version of the structure. A value of zero represents the <b>EFI_BLUETOOTH_DEVICE_INFO</b> structure as defined here. Future version of this specification may extend this data structure in a backward compatible way and increase the value of <i>Version</i> .
<i>BD_ADDR</i>	48bit Bluetooth device address.
<i>PageScanRepetitionMode</i>	Bluetooth PageScanRepetitionMode. See Bluetooth specification for detail.



<i>ClassOfDevice</i>	Bluetooth ClassOfDevice. See Bluetooth specification for detail.
<i>ClockOffset</i>	Bluetooth CloseOffset. See Bluetooth specification for detail.
<i>RSSI</i>	Bluetooth RSSI. See Bluetooth specification for detail.
<i>ExtendedInquiryResponse</i>	Bluetooth ExtendedInquiryResponse. See Bluetooth specification for detail.

```
typedef struct {
  UINT8 Address[6];
} BLUETOOTH_ADDRESS;
```

```
typedef struct {
  UINT8 FormatType:2;
  UINT8 MinorDeviceClass: 6;
  UINT16 MajorDeviceClass: 5;
  UINT16 MajorServiceClass:11;
} BLUETOOTH_CLASS_OF_DEVICE;
```

### Status Codes Returned

EFI_SUCCESS	The Bluetooth device information is returned successfully.
EFI_DEVICE_ERROR	A hardware error occurred trying to retrieve the Bluetooth device information.

## BLUETOOTH\_IO\_PROTOCOL.GetSdpInfo

### Summary

Get Bluetooth SDP information.

### Prototype

```
typedef
EFI_STATUS
(EFI_API *EFI_BLUETOOTH_IO_GET_SDP_INFO)(
  IN EFI_BLUETOOTH_IO_PROTOCOL *This,
  OUT UINTN *SdpInfoSize,
  OUT VOID **SdpInfo
);
```

### Parameters

<i>This</i>	Pointer to the <b>EFI_BLUETOOTH_IO_PROTOCOL</b> instance.
<i>SdpInfoSize</i>	A pointer to the size, in bytes, of the <i>SdpInfo</i> buffer.
<i>SdpInfo</i>	A pointer to a callee allocated buffer that returns Bluetooth SDP information. Callee allocates this buffer by using EFI Boot Service <b>AllocatePool()</b> .

### Description

The **GetSdpInfo()** function returns Bluetooth SDP information. The size of *SdpInfo* structure should never be assumed and the value of *SdpInfoSize* is the only valid way to know the size of *SdpInfo*.

### Status Codes Returned

EFI_SUCCESS	The Bluetooth SDP information is returned successfully.
EFI_DEVICE_ERROR	A hardware error occurred trying to retrieve the Bluetooth SDP information.

## BLUETOOTH\_IO\_PROTOCOL.L2CapRawSend

### Summary

Send L2CAP message (including L2CAP header).

### Prototype

```
typedef
EFI_STATUS
(EFIAPI *EFI_BLUETOOTH_IO_L2CAP_RAW_SEND)(
  IN EFI_BLUETOOTH_IO_PROTOCOL *This,
  IN OUT UINTN *BufferSize,
  IN VOID *Buffer,
  IN UINTN Timeout
);
```

### Parameters

<i>This</i>	Pointer to the <b>EFI_BLUETOOTH_IO_PROTOCOL</b> instance.
<i>BufferSize</i>	On input, indicates the size, in bytes, of the data buffer specified by <i>Buffer</i> . On output, indicates the amount of data actually transferred.
<i>Buffer</i>	A pointer to the buffer of data that will be transmitted to Bluetooth L2CAP layer.
<i>Timeout</i>	Indicating the transfer should be completed within this time frame. The units are in milliseconds. If <i>Timeout</i> is 0, then the caller must wait for the function to be completed until <b>EFI_SUCCESS</b> or <b>EFI_DEVICE_ERROR</b> is returned.

### Description

The **L2CapRawSend()** function sends L2CAP layer message (including L2CAP header). *Buffer* holds the whole L2CAP message, including Length, ChannelID, and information payload. (see in Bluetooth specification, L2CAP Data Packet Format for more detail)

### Status Codes Returned

EFI_SUCCESS	The L2CAP message is sent successfully.
EFI_INVALID_PARAMETER	One or more of the following conditions is TRUE: <ul style="list-style-type: none"> <li><i>BufferSize</i> is NULL.</li> <li><i>*BufferSize</i> is 0.</li> <li><i>Buffer</i> is NULL.</li> </ul>
EFI_TIMEOUT	Sending L2CAP message fail due to timeout.
EFI_DEVICE_ERROR	Sending L2CAP message fail due to host controller or device error.

## BLUETOOTH\_IO\_PROTOCOL.L2CapRawReceive

### Summary

Receive L2CAP message (including L2CAP header).

### Prototype

```
typedef
EFI_STATUS
(EFIAPI *EFI_BLUETOOTH_IO_L2CAP_RAW_RECEIVE)(
  IN EFI_BLUETOOTH_IO_PROTOCOL *This,
  IN OUT UINTN *BufferSize,
  OUT VOID *Buffer,
  IN UINTN Timeout
);
```

### Parameters

<i>This</i>	Pointer to the <b>EFI_BLUETOOTH_IO_PROTOCOL</b> instance.
<i>BufferSize</i>	On input, indicates the size, in bytes, of the data buffer specified by <i>Buffer</i> . On output, indicates the amount of data actually transferred.
<i>Buffer</i>	A pointer to the buffer of data that will be received from Bluetooth L2CAP layer.
<i>Timeout</i>	Indicating the transfer should be completed within this time frame. The units are in milliseconds. If <i>Timeout</i> is 0, then the caller must wait for the function to be completed until <b>EFI_SUCCESS</b> or <b>EFI_DEVICE_ERROR</b> is returned.

### Description

The **L2CapRawReceive()** function receives L2CAP layer message (including L2CAP header). *Buffer* holds the whole L2CAP message, including Length, ChannelID, and information payload. (see in Bluetooth specification, L2CAP Data Packet Format for more detail)

### Status Codes Returned

EFI_SUCCESS	The L2CAP message is received successfully.
EFI_INVALID_PARAMETER	One or more of the following conditions is TRUE: <ul style="list-style-type: none"> <li><i>BufferSize</i> is NULL.</li> <li><i>*BufferSize</i> is 0.</li> <li><i>Buffer</i> is NULL.</li> </ul>
EFI_TIMEOUT	Receiving L2CAP message fail due to timeout.
EFI_DEVICE_ERROR	Receiving L2CAP message fail due to host controller or device error.

## BLUETOOTH\_IO\_PROTOCOL.L2CapRawAsyncReceive

### Summary

Receive L2CAP message (including L2CAP header) in non-blocking way.

### Prototype

```
typedef
EFI_STATUS
(EFI_API *EFI_BLUETOOTH_IO_L2CAP_RAW_ASYNC_RECEIVE)(
  IN EFI_BLUETOOTH_IO_PROTOCOL  *This,
  IN BOOLEAN                    IsNewTransfer,
  IN UINTN                      PollingInterval,
  IN UINTN                      DataLength,
  IN EFI_BLUETOOTH_IO_ASYNC_FUNC_CALLBACK Callback,
  IN VOID                       *Context
);
```

### Parameters

<i>This</i>	Pointer to the <b>EFI_BLUETOOTH_IO_PROTOCOL</b> instance.
<i>IsNewTransfer</i>	If <b>TRUE</b> , a new transfer will be submitted. If <b>FALSE</b> , the request is deleted.
<i>PollingInterval</i>	Indicates the periodic rate, in milliseconds, that the transfer is to be executed.
<i>DataLength</i>	Specifies the length, in bytes, of the data to be received.
<i>Callback</i>	The callback function. This function is called if the asynchronous transfer is completed.
<i>Context</i>	Data passed into <i>Callback</i> function. This is optional parameter and may be <b>NULL</b> .

### Description

The **L2CapRawAsyncReceive()** function receives L2CAP layer message (including L2CAP header) in non-blocking way. *Data* in *Callback* function holds the whole L2CAP message, including Length, ChannelID, and information payload. (see in Bluetooth specification, L2CAP Data Packet Format for more detail)

## Related Definitions

```
typedef
EFI_STATUS
(EFI_API *EFI_BLUETOOTH_IO_ASYNC_FUNC_CALLBACK) (
  IN UINT16      ChannelID,
  IN VOID        *Data,
  IN UINTN       DataLength,
  IN VOID        *Context
);
```

<i>ChannelID</i>	Bluetooth L2CAP message channel ID.
<i>Data</i>	Data received via asynchronous transfer.
<i>DataLength</i>	The length of <i>Data</i> in bytes, received via asynchronous transfer.
<i>Context</i>	Context passed from asynchronous transfer request.

## Status Codes Returned

EFI_SUCCESS	The L2CAP asynchronous receive request is submitted successfully.
EFI_INVALID_PARAMETER	One or more of the following conditions is TRUE: <ul style="list-style-type: none"> <li><i>DataLength</i> is 0.</li> <li>If <i>IsNewTransfer</i> is <b>TRUE</b>, and an asynchronous receive request already exists.</li> </ul>

## BLUETOOTH\_IO\_PROTOCOL.L2CapSend

### Summary

Send L2CAP message (excluding L2CAP header) to a specific channel.

### Prototype

```
typedef
EFI_STATUS
(EFIAPI *EFI_BLUETOOTH_IO_L2CAP_SEND)(
  IN EFI_BLUETOOTH_IO_PROTOCOL *This,
  IN EFI_HANDLE Handle,
  IN OUT UINTN *BufferSize,
  IN VOID *Buffer,
  IN UINTN Timeout
);
```

### Parameters

<i>This</i>	Pointer to the <b>EFI_BLUETOOTH_IO_PROTOCOL</b> instance.
<i>Handle</i>	A handle created by <b>EFI_BLUETOOTH_IO_PROTOCOL.L2CapConnect</b> indicates which channel to send.
<i>BufferSize</i>	On input, indicates the size, in bytes, of the data buffer specified by <i>Buffer</i> . On output, indicates the amount of data actually transferred.
<i>Buffer</i>	A pointer to the buffer of data that will be transmitted to Bluetooth L2CAP layer.
<i>Timeout</i>	Indicating the transfer should be completed within this time frame. The units are in milliseconds. If <i>Timeout</i> is 0, then the caller must wait for the function to be completed until <b>EFI_SUCCESS</b> or <b>EFI_DEVICE_ERROR</b> is returned.

### Description

The **L2CapSend()** function sends L2CAP layer message (excluding L2CAP header) to Bluetooth channel indicated by *Handle*. *Buffer* only holds information payload. (see in Bluetooth specification, L2CAP Data Packet Format for more detail). Handle

### Status Codes Returned

EFI_SUCCESS	The L2CAP message is sent successfully.
EFI_NOT_FOUND	<i>Handle</i> is invalid or not found.
EFI_INVALID_PARAMETER	One or more of the following conditions is TRUE: <ul style="list-style-type: none"> <li><i>BufferSize</i> is NULL.</li> <li><i>*BufferSize</i> is 0.</li> <li><i>Buffer</i> is NULL.</li> </ul>
EFI_TIMEOUT	Sending L2CAP message fail due to timeout.

EFI_DEVICE_ERROR	Sending L2CAP message fail due to host controller or device error.
------------------	--



## BLUETOOTH\_IO\_PROTOCOL.L2CapReceive

### Summary

Receive L2CAP message (excluding L2CAP header) from a specific channel.

### Prototype

```
typedef
EFI_STATUS
(EFI_API *EFI_BLUETOOTH_IO_L2CAP_RECEIVE)(
  IN EFI_BLUETOOTH_IO_PROTOCOL *This,
  IN EFI_HANDLE Handle,
  OUT UINTN *BufferSize,
  OUT VOID **Buffer,
  IN UINTN Timeout
);
```

### Parameters

<i>This</i>	Pointer to the <b>EFI_BLUETOOTH_IO_PROTOCOL</b> instance.
<i>Handle</i>	A handle created by <b>EFI_BLUETOOTH_IO_PROTOCOL.L2CapConnect</b> indicates which channel to receive.
<i>BufferSize</i>	Indicates the size, in bytes, of the data buffer specified by <i>Buffer</i> .
<i>Buffer</i>	A pointer to the buffer of data that will be received from Bluetooth L2CAP layer. Callee allocates this buffer by using EFI Boot Service <b>AllocatePool()</b> .
<i>Timeout</i>	Indicating the transfer should be completed within this time frame. The units are in milliseconds. If <i>Timeout</i> is 0, then the caller must wait for the function to be completed until <b>EFI_SUCCESS</b> or <b>EFI_DEVICE_ERROR</b> is returned.

### Description

The **L2CapReceive()** function receives L2CAP layer message (excluding L2CAP header) from Bluetooth channel indicated by *Handle*. *Buffer* only holds information payload. (see in Bluetooth specification, L2CAP Data Packet Format for more detail)

### Status Codes Returned

EFI_SUCCESS	The L2CAP message is received successfully.
EFI_NOT_FOUND	<i>Handle</i> is invalid or not found.
EFI_INVALID_PARAMETER	One or more of the following conditions is TRUE: <ul style="list-style-type: none"> <li><i>BufferSize</i> is NULL.</li> <li><i>*BufferSize</i> is 0.</li> <li><i>Buffer</i> is NULL.</li> </ul>

EFI_TIMEOUT	Receiving L2CAP message fail due to timeout.
EFI_DEVICE_ERROR	Receiving L2CAP message fail due to host controller or device error.

## BLUETOOTH\_IO\_PROTOCOL.L2CapAsyncReceive

### Summary

Receive L2CAP message (including L2CAP header) in non-blocking way from a specific channel.

### Prototype

```
typedef
EFI_STATUS
(EFIAPI *EFI_BLUETOOTH_IO_L2CAP_ASYNC_RECEIVE)(
  IN EFI_BLUETOOTH_IO_PROTOCOL      *This,
  IN EFI_HANDLE                      Handle,
  IN EFI_BLUETOOTH_IO_CHANNEL_SERVICE_CALLBACK Callback,
  IN VOID                            *Context
```

### Parameters

<i>This</i>	Pointer to the <b>EFI_BLUETOOTH_IO_PROTOCOL</b> instance.
<i>Handle</i>	A handle created by <b>EFI_BLUETOOTH_IO_PROTOCOL.L2CapConnect</b> indicates which channel to receive.
<i>Callback</i>	The callback function. This function is called if the asynchronous transfer is completed.
<i>Context</i>	Data passed into <i>Callback</i> function. This is optional parameter and may be <b>NULL</b> .

### Description

The **L2CapAsyncReceive()** function receives L2CAP layer message (excluding L2CAP header) in non-blocking way from Bluetooth channel indicated by *Handle*. *Data* in *Callback* function only holds information payload. (see in Bluetooth specification, L2CAP Data Packet Format for more detail)

### Related Definitions

```
typedef
EFI_STATUS
(EFIAPI *EFI_BLUETOOTH_IO_CHANNEL_SERVICE_CALLBACK) (
  IN VOID      *Data,
  IN UINTN     DataLength,
  IN VOID      *Context
);
```

<i>Data</i>	Data received via asynchronous transfer.
<i>DataLength</i>	The length of <i>Data</i> in bytes, received via asynchronous transfer.
<i>Context</i>	Context passed from asynchronous transfer request.

## Status Codes Returned

EFI_SUCCESS	The L2CAP asynchronous receive request is submitted successfully.
EFI_NOT_FOUND	<i>Handle</i> is invalid or not found.
EFI_INVALID_PARAMETER	One or more of the following conditions is TRUE: <ul style="list-style-type: none"><li>• <i>DataLength</i> is 0.</li><li>• If an asynchronous receive request already exists on same <i>Handle</i>.</li></ul>

## BLUETOOTH\_IO\_PROTOCOL.L2CapConnect

### Summary

Do L2CAP connection.

### Prototype

```
typedef
EFI_STATUS
(EFI_API *EFI_BLUETOOTH_IO_L2CAP_CONNECT)(
  IN EFI_BLUETOOTH_IO_PROTOCOL      *This,
  OUT EFI_HANDLE                    *Handle,
  IN UINT16                          Psm,
  IN UINT16                          Mtu,
  IN EFI_BLUETOOTH_IO_CHANNEL_SERVICE_CALLBACK Callback,
  IN VOID                            *Context
);
```

### Parameters

<i>This</i>	Pointer to the <b>EFI_BLUETOOTH_IO_PROTOCOL</b> instance.
<i>Handle</i>	A handle to indicate this L2CAP connection.
<i>Psm</i>	Bluetooth PSM. See Bluetooth specification for detail.
<i>Mtu</i>	Bluetooth MTU. See Bluetooth specification for detail.
<i>Callback</i>	The callback function. This function is called whenever there is message received in this channel.
<i>Context</i>	Data passed into <i>Callback</i> function. This is optional parameter and may be <b>NULL</b> .

### Description

The **L2CapConnect()** function does all necessary steps for Bluetooth L2CAP layer connection in blocking way. It might take long time. Once this function is returned *Handle* is created to indicate the connection.

### Status Codes Returned

EFI_SUCCESS	The Bluetooth L2CAP layer connection is created successfully.
EFI_INVALID_PARAMETER	One or more of the following conditions is TRUE: <ul style="list-style-type: none"> <li><i>Handle</i> is NULL.</li> </ul>
EFI_DEVICE_ERROR	A hardware error occurred trying to do Bluetooth L2CAP connection.

## BLUETOOTH\_IO\_PROTOCOL.L2CapDisconnect

### Summary

Do L2CAP disconnection.

### Prototype

```
typedef
EFI_STATUS
(EFIAPI *EFI_BLUETOOTH_IO_L2CAP_DISCONNECT)(
  IN EFI_BLUETOOTH_IO_PROTOCOL  *This,
  IN EFI_HANDLE                  Handle
);
```

### Parameters

*This* Pointer to the **EFI\_BLUETOOTH\_IO\_PROTOCOL** instance.

*Handle* A handle to indicate this L2CAP connection.

### Description

The **L2CapDisconnect()** function does all necessary steps for Bluetooth L2CAP layer disconnection in blocking way. It might take long time. Once this function is returned *Handle* is no longer valid.

### Status Codes Returned

EFI_SUCCESS	The Bluetooth L2CAP layer disconnection is created successfully.
EFI_NOT_FOUND	<i>Handle</i> is invalid or not found.
EFI_DEVICE_ERROR	A hardware error occurred trying to do Bluetooth L2CAP disconnection.

## BLUETOOTH\_IO\_PROTOCOL.L2CapRegisterService

### Summary

Register L2CAP callback function for special channel.

### Prototype

```
typedef
EFI_STATUS
(EFI_API *EFI_BLUETOOTH_IO_L2CAP_REGISTER_SERVICE)(
  IN EFI_BLUETOOTH_IO_PROTOCOL      *This,
  OUT EFI_HANDLE                    *Handle,
  IN UINT16                         Psm,
  IN UINT16                         Mtu,
  IN EFI_BLUETOOTH_IO_CHANNEL_SERVICE_CALLBACK Callback,
  IN VOID                           *Context
);
```

### Parameters

<i>This</i>	Pointer to the <b>EFI_BLUETOOTH_IO_PROTOCOL</b> instance.
<i>Handle</i>	A handle to indicate this L2CAP connection.
<i>Psm</i>	Bluetooth PSM. See Bluetooth specification for detail.
<i>Mtu</i>	Bluetooth MTU. See Bluetooth specification for detail.
<i>Callback</i>	The callback function. This function is called whenever there is message received in this channel. <b>NULL</b> means unregister.
<i>Context</i>	Data passed into <i>Callback</i> function. This is optional parameter and may be <b>NULL</b> .

### Description

The **L2CapRegisterService()** function registers L2CAP callback function for a special channel. Once this function is returned *Handle* is created to indicate the connection.

### Status Codes Returned

EFI_SUCCESS	The Bluetooth L2CAP callback function is registered successfully.
EFI_ALREADY_STARTED	The callback function already exists when register.
EFI_NOT_FOUND	The callback function does not exist when unregister.

## 27.3 EFI Bluetooth Configuration Protocol

### EFI\_BLUETOOTH\_CONFIG\_PROTOCOL

#### Summary

This protocol abstracts user interface configuration for Bluetooth device.

## GUID

```
#define EFI_BLUETOOTH_CONFIG_PROTOCOL_GUID \
{ 0x62960cf3, 0x40ff, 0x4263, \
  { 0xa7, 0x7c, 0xdf, 0xde, 0xbd, 0x19, 0x1b, 0x4b }}
```

## Protocol Interface Structure

```
typedef struct _EFI_BLUETOOTH_CONFIG_PROTOCOL {
  EFI_BLUETOOTH_CONFIG_INIT      Init;
  EFI_BLUETOOTH_CONFIG_SCAN      Scan;
  EFI_BLUETOOTH_CONFIG_CONNECT   Connect;
  EFI_BLUETOOTH_CONFIG_DISCONNECT Disconnect;
  EFI_BLUETOOTH_CONFIG_GET_DATA   GetData;
  EFI_BLUETOOTH_CONFIG_SET_DATA   SetData;
  EFI_BLUETOOTH_CONFIG_GET_REMOTE_DATA GetRemoteData;
  EFI_BLUETOOTH_CONFIG_REGISTER_PIN_CALLBACK
    RegisterPinCallback;
  EFI_BLUETOOTH_CONFIG_REGISTER_GET_LINK_KEY_CALLBACK
    RegisterGetLinkKeyCallback;
  EFI_BLUETOOTH_CONFIG_REGISTER_SET_LINK_KEY_CALLBACK
    RegisterSetLinkKeyCallback;
  EFI_BLUETOOTH_CONFIG_REGISTER_CONNECT_COMPLETE_CALLBACK
    RegisterLinkConnectCompleteCallback;
} EFI_BLUETOOTH_CONFIG_PROTOCOL;
```

## Parameters

<i>Init</i>	Initialize Bluetooth host controller and local device. See the <b>Init()</b> function description.
<i>Scan</i>	Scan Bluetooth device. See the <b>Scan()</b> function description.
<i>Connect</i>	Connect one Bluetooth device. See the <b>Connect()</b> function description.
<i>Disconnect</i>	Disconnect one Bluetooth device. See the <b>Disconnect()</b> function description.
<i>GetData</i>	Get Bluetooth configuration data. See the <b>GetData()</b> function description.
<i>SetData</i>	Set Bluetooth configuration data. See the <b>SetData()</b> function description.
<i>GetRemoteData</i>	Get remote Bluetooth device data. See the <b>GetRemoteData()</b> function description.
<i>RegisterPinCallback</i>	Register PIN callback function. See the <b>RegisterPinCallback()</b> function description.
<i>RegisterGetLinkKeyCallback</i>	Register get link key callback function. See the <b>RegisterGetLinkKeyCallback()</b> function description.



*RegisterSetLinkKeyCallback*

Register set link key callback function. See the **RegisterSetLinkKeyCallback()** function description.

*RegisterLinkConnectCompleteCallback*

Register link connect complete callback function. See the **RegisterLinkConnectCompleteCallback()** function description.

**Description**

The **EFI\_BLUETOOTH\_CONFIG\_PROTOCOL** abstracts the Bluetooth configuration. User can use Bluetooth configuration to interactive with Bluetooth bus driver.

## BLUETOOTH\_CONFIG\_PROTOCOL.Init

### Summary

Initialize Bluetooth host controller and local device.

### Prototype

```
typedef
EFI_STATUS
(EFI_API *EFI_BLUETOOTH_CONFIG_INIT)(
  IN EFI_BLUETOOTH_CONFIG_PROTOCOL *This
);
```

### Parameters

*This* Pointer to the **EFI\_BLUETOOTH\_CONFIG\_PROTOCOL** instance.

### Description

The **Init()** function initializes Bluetooth host controller and local device.

### Status Codes Returned

EFI_SUCCESS	The Bluetooth host controller and local device is initialized successfully.
EFI_DEVICE_ERROR	A hardware error occurred trying to initialize the Bluetooth host controller and local device.

## BLUETOOTH\_CONFIG\_PROTOCOL.Scan

### Summary

Scan Bluetooth device.

### Prototype

```
typedef
EFI_STATUS
(EFIAPI *EFI_BLUETOOTH_CONFIG_SCAN)(
  IN EFI_BLUETOOTH_CONFIG_PROTOCOL  *This,
  IN BOOLEAN                        ReScan,
  IN UINT8                          ScanType,
  IN EFI_BLUETOOTH_CONFIG_SCAN_CALLBACK_FUNCTION Callback
  IN VOID                            *Context
);
```

### Parameters

<i>This</i>	Pointer to the <b>EFI_BLUETOOTH_CONFIG_PROTOCOL</b> instance.
<i>ReScan</i>	If <b>TRUE</b> , a new scan request is submitted no matter there is scan result before. If <b>FALSE</b> and there is scan result, the previous scan result is returned and no scan request is submitted.
<i>ScanType</i>	Bluetooth scan type, Inquiry and/or Page. See Bluetooth specification for detail.
<i>Callback</i>	The callback function. This function is called if a Bluetooth device is found during scan process.
<i>Context</i>	Data passed into <i>Callback</i> function. This is optional parameter and may be <b>NULL</b> .

### Description

The **Scan()** function scans Bluetooth device. When this function is returned, it just means scan request is submitted. It does not mean scan process is started or finished. Whenever there is a Bluetooth device is found, the *Callback* function will be called. *Callback* function might be called before this function returns or after this function returns.

## Related Definitions

```
typedef
EFI_STATUS
(EFI_API *EFI_BLUETOOTH_CONFIG_SCAN_CALLBACK_FUNCTION) (
  IN EFI_BLUETOOTH_CONFIG_PROTOCOL    *This,
  IN VOID                             *Context,
  IN EFI_BLUETOOTH_SCAN_CALLBACK_INFORMATION *CallbackInfo
);
```

*This* Pointer to the **EFI\_BLUETOOTH\_CONFIG\_PROTOCOL** instance.

*Context* Context passed from scan request.

*CallbackInfo* Data related to scan result. **NULL** *CallbackInfo* means scan complete.

```
typedef
typedef struct{
  BLUETOOTH_ADDRESS    BAddr;
  UINT8                RemoteDeviceState;
  BLUETOOTH_CLASS_OF_DEVICE ClassOfDevice;
  UINT8
  RemoteDeviceName[BLUETOOTH_HCI_COMMAND_LOCAL_READABLE_NAME_MAX_SIZE];
}EFI_BLUETOOTH_SCAN_CALLBACK_INFORMATION;

#define BLUETOOTH_HCI_COMMAND_LOCAL_READABLE_NAME_MAX_SIZE 248
```

## Status Codes Returned

EFI_SUCCESS	The Bluetooth scan request is submitted.
EFI_DEVICE_ERROR	A hardware error occurred trying to scan the Bluetooth device.

## BLUETOOTH\_CONFIG\_PROTOCOL.Connect

### Summary

Connect a Bluetooth device.

### Prototype

```
typedef
EFI_STATUS
(EFIAPI *EFI_BLUETOOTH_CONFIG_CONNECT)(
  IN EFI_BLUETOOTH_CONFIG_PROTOCOL *This,
  IN BLUETOOTH_ADDRESS      *BD_ADDR
);
```

### Parameters

<i>This</i>	Pointer to the <b>EFI_BLUETOOTH_CONFIG_PROTOCOL</b> instance.
<i>BD_ADDR</i>	The address of Bluetooth device to be connected.

### Description

The **Connect()** function connects a Bluetooth device. When this function is returned successfully, a new **EFI\_BLUETOOTH\_IO\_PROTOCOL** is created.

### Status Codes Returned

EFI_SUCCESS	The Bluetooth device is connected successfully.
EFI_ALREADY_STARTED	The Bluetooth device is already connected.
EFI_NOT_FOUND	The Bluetooth device is not found.
EFI_DEVICE_ERROR	A hardware error occurred trying to connect the Bluetooth device.

## BLUETOOTH\_CONFIG\_PROTOCOL.Disconnect

### Summary

Disconnect a Bluetooth device.

### Prototype

```
typedef
EFI_STATUS
(EFIAPI *EFI_BLUETOOTH_CONFIG_DISCONNECT)(
  IN EFI_BLUETOOTH_CONFIG_PROTOCOL *This,
  IN BLUETOOTH_ADDRESS      *BD_ADDR,
  IN UINT8      Reason
);
```

### Parameters

<i>This</i>	Pointer to the <b>EFI_BLUETOOTH_CONFIG_PROTOCOL</b> instance.
<i>BD_ADDR</i>	The address of Bluetooth device to be connected.
<i>Reason</i>	Bluetooth disconnect reason. See Bluetooth specification for detail.

### Description

The **Disconnect()** function disconnects a Bluetooth device. When this function is returned successfully, the **EFI\_BLUETOOTH\_IO\_PROTOCOL** associated with this device is destroyed and all services associated are stopped.

### Status Codes Returned

EFI_SUCCESS	The Bluetooth device is disconnected successfully.
EFI_NOT_STARTED	The Bluetooth device is not connected.
EFI_NOT_FOUND	The Bluetooth device is not found.
EFI_DEVICE_ERROR	A hardware error occurred trying to disconnect the Bluetooth device.

## BLUETOOTH\_CONFIG\_PROTOCOL.GetData

### Summary

Get Bluetooth configuration data.

### Prototype

```
typedef
EFI_STATUS
(EFI_API *EFI_BLUETOOTH_CONFIG_GET_DATA) (
  IN EFI_BLUETOOTH_CONFIG_PROTOCOL *This,
  IN EFI_BLUETOOTH_CONFIG_DATA_TYPE DataType,
  IN OUT UINTN *DataSize,
  IN OUT VOID *Data
);
```

### Parameters

<i>This</i>	Pointer to the <b>EFI_BLUETOOTH_CONFIG_PROTOCOL</b> instance.
<i>DataType</i>	Configuration data type.
<i>DataSize</i>	On input, indicates the size, in bytes, of the data buffer specified by <i>Data</i> . On output, indicates the amount of data actually returned.
<i>Data</i>	A pointer to the buffer of data that will be returned.

### Description

The **GetData()** function returns Bluetooth configuration data. For remote Bluetooth device configuration data, please use **GetRemoteData()** function with valid BD\_ADDR.

## Related Definitions

```
typedef enum {
  EfiBluetoothConfigDataTypeDeviceName,      /* Relevant for LE*/
  EfiBluetoothConfigDataTypeClassOfDevice,
  EfiBluetoothConfigDataTypeRemoteDeviceState, /* Relevant for LE*/
  EfiBluetoothConfigDataTypeSdpInfo,
  EfiBluetoothConfigDataTypeBDADDR,         /* Relevant for LE*/
  EfiBluetoothConfigDataTypeDiscoverable,    /* Relevant for LE*/
  EfiBluetoothConfigDataTypeControllerStoredPairedDeviceList,
  EfiBluetoothConfigDataTypeAvailableDeviceList,
  EfiBluetoothConfigDataTypeRandomAddress,  /* Relevant for LE*/
  EfiBluetoothConfigDataTypeRSSI,           /* Relevant for LE*/
  EfiBluetoothConfigDataTypeAdvertisementData, /* Relevant for LE*/
  EfiBluetoothConfigDataTypeLoCapability,   /* Relevant for LE*/
  EfiBluetoothConfigDataTypeOOBDataFlag,    /* Relevant for LE*/
  EfiBluetoothConfigDataTypeKeyType,        /* Relevant for LE*/
  EfiBluetoothConfigDataTypeEncKeySize,     /* Relevant for LE*/
  EfiBluetoothConfigDataTypeMax,
} EFI_BLUETOOTH_CONFIG_DATA_TYPE;
```

*EfiBluetoothConfigDataTypeAdvertisementDataReport*

Advertisement report. Data structure is **UNIT8[]**.

*EfiBluetoothConfigDataTypeKeyType*

KeyType of Authentication Requirements flag of local device as **UINT8**, indicating requested security properties. See Bluetooth specification 3.H.3.5.1. BIT0: MITM, BIT1: SC.

*EfiBluetoothConfigDataTypeDeviceName*

Local/Remote Bluetooth device name. Data structure is zero terminated **CHAR8[]**.

*EfiBluetoothConfigDataTypeClassOfDevice*

Local/Remote Bluetooth device ClassOfDevice. Data structure is **BLUETOOTH\_CLASS\_OF\_DEVICE**.

*EfiBluetoothConfigDataTypeRemoteDeviceState*

Remove Bluetooth device state. Data structure is **EFI\_BLUETOOTH\_CONFIG\_REMOTE\_DEVICE\_STATE\_TY PE**.

*EfiBluetoothConfigDataTypeSdpInfo*

Local/Remote Bluetooth device SDP information. Data structure is **UNIT8[]**.

*EfiBluetoothConfigDataTypeBDADDR*

Local Bluetooth device address. Data structure is **BLUETOOTH\_ADDRESS**.



*EfiBluetoothConfigDataTypeDiscoverable*

Local Bluetooth discoverable state. Data structure is **UINT8**. (Page scan and/or Inquiry scan)

*EfiBluetoothConfigDataTypeControllerStoredPairedDeviceList*

Local Bluetooth controller stored paired device list. Data structure is **BLUETOOTH\_ADDRESS[]**.

*EfiBluetoothConfigDataTypeAvailableDeviceList*

Local available device list. Data structure is **BLUETOOTH\_ADDRESS[]**.

```
typedef EFI_BLUETOOTH_CONFIG_REMOTE_DEVICE_STATE_TYPE UINT32;
#define EFI_BLUETOOTH_CONFIG_REMOTE_DEVICE_STATE_CONNECTED 0x1
#define EFI_BLUETOOTH_CONFIG_REMOTE_DEVICE_STATE_PAIRRED 0x2

#define BLUETOOTH_HCI_LINK_KEY_SIZE 16
```

**Status Codes Returned**

EFI_SUCCESS	The Bluetooth configuration data is returned successfully.
EFI_INVALID_PARAMETER	One or more of the following conditions is TRUE: <ul style="list-style-type: none"> <li>• <i>DataSize</i> is NULL.</li> <li>• <i>*DataSize</i> is not 0 and Data is NULL</li> </ul>
EFI_UNSUPPORTED	The <i>Data Type</i> is unsupported.
EFI_NOT_FOUND	The <i>Data Type</i> is not found.
EFI_BUFFER_TOO_SMALL	The buffer is too small to hold the buffer. *DataSize has been updated with the size needed to complete the request.

## BLUETOOTH\_CONFIG\_PROTOCOL.SetData

### Summary

Set Bluetooth configuration data.

### Prototype

```
typedef
EFI_STATUS
(EFIAPI *EFI_BLUETOOTH_CONFIG_SET_DATA) (
  IN EFI_BLUETOOTH_CONFIG_PROTOCOL *This,
  IN EFI_BLUETOOTH_CONFIG_DATA_TYPE DataType,
  IN UINTN      DataSize,
  IN VOID      *Data
);
```

### Parameters

<i>This</i>	Pointer to the <b>EFI_BLUETOOTH_CONFIG_PROTOCOL</b> instance.
<i>DataType</i>	Configuration data type.
<i>DataSize</i>	Indicates the size, in bytes, of the data buffer specified by <i>Data</i> .
<i>Data</i>	A pointer to the buffer of data that will be set.

### Description

The **SetData()** function sets local Bluetooth device configuration data. Not all *DataType* can be set.

### Status Codes Returned

EFI_SUCCESS	The Bluetooth configuration data is set successfully.
EFI_INVALID_PARAMETER	One or more of the following conditions is TRUE: <ul style="list-style-type: none"> <li><i>DataSize</i> is 0.</li> <li><i>Data</i> is NULL.</li> </ul>
EFI_UNSUPPORTED	The <i>DataType</i> is unsupported.
EFI_WRITE_PROTECTED	Cannot set configuration data.

## BLUETOOTH\_CONFIG\_PROTOCOL.GetRemoteData

### Summary

Get remove Bluetooth device configuration data.

### Prototype

```
typedef
EFI_STATUS
(EFIAPI *EFI_BLUETOOTH_CONFIG_GET_REMOTE_DATA) (
  IN EFI_BLUETOOTH_CONFIG_PROTOCOL *This,
  IN EFI_BLUETOOTH_CONFIG_DATA_TYPE DataType,
  IN BLUETOOTH_ADDRESS *BDAddr,
  IN OUT UINTN *DataSize,
  IN OUT VOID *Data
);
```

### Parameters

<i>This</i>	Pointer to the <b>EFI_BLUETOOTH_CONFIG_PROTOCOL</b> instance.
<i>DataType</i>	Configuration data type.
<i>BDAddr</i>	Remote Bluetooth device address.
<i>DataSize</i>	On input, indicates the size, in bytes, of the data buffer specified by <i>Data</i> . On output, indicates the amount of data actually returned.
<i>Data</i>	A pointer to the buffer of data that will be returned.

### Description

The **GetRemoteData()** function returns remote Bluetooth device configuration data.

### Status Codes Returned

EFI_SUCCESS	The remote Bluetooth device configuration data is returned successfully.
EFI_INVALID_PARAMETER	One or more of the following conditions is TRUE: <ul style="list-style-type: none"> <li><i>DataSize</i> is NULL.</li> <li>*DataSize is not 0 and Data is NULL</li> </ul>
EFI_UNSUPPORTED	The <i>DataType</i> is unsupported.
EFI_NOT_FOUND	The <i>DataType</i> is not found.
EFI_BUFFER_TOO_SMALL	The buffer is too small to hold the buffer. *DataSize has been updated with the size needed to complete the request.

## BLUETOOTH\_CONFIG\_PROTOCOL.RegisterPinCallback

### Summary

Register PIN callback function.

### Prototype

```
typedef
EFI_STATUS
(EFIAPI *EFI_BLUETOOTH_CONFIG_REGISTER_PIN_CALLBACK) (
  IN EFI_BLUETOOTH_CONFIG_PROTOCOL      *This,
  IN EFI_BLUETOOTH_CONFIG_REGISTER_PIN_CALLBACK_FUNCTION Callback,
  IN VOID                               *Context
);
```

### Parameters

<i>This</i>	Pointer to the <b>EFI_BLUETOOTH_CONFIG_PROTOCOL</b> instance.
<i>Callback</i>	The callback function. <b>NULL</b> means unregister.
<i>Context</i>	Data passed into <i>Callback</i> function. This is optional parameter and may be <b>NULL</b> .

### Description

The **RegisterPinCallback()** function registers Bluetooth PIN callback function. The Bluetooth configuration driver must call **RegisterPinCallback()** to register a callback function. During pairing, Bluetooth bus driver must trigger this callback function, and Bluetooth configuration driver must handle callback function according to *CallbackType* during pairing. Both Legacy pairing and SSP (secure simple pairing) are required to be supported. See **EFI\_BLUETOOTH\_PIN\_CALLBACK\_TYPE** below for detail of each pairing mode.

### Related Definitions

```
typedef
EFI_STATUS
(EFIAPI *EFI_BLUETOOTH_CONFIG_REGISTER_PIN_CALLBACK_FUNCTION) (
  IN EFI_BLUETOOTH_CONFIG_PROTOCOL *This,
  IN VOID                          *Context,
  IN EFI_BLUETOOTH_PIN_CALLBACK_TYPE CallbackType,
  IN VOID                          *InputBuffer,
  IN UINTN                         InputBufferSize,
  OUT VOID                          **OutputBuffer,
  OUT UINTN                         *OutputBufferSize
);
```

<i>This</i>	Pointer to the <b>EFI_BLUETOOTH_CONFIG_PROTOCOL</b> instance.
<i>Context</i>	Context passed from registration.

<i>CallbackType</i>	Callback type in <b>EFI_BLUETOOTH_PIN_CALLBACK_TYPE</b> .
<i>InBuffer</i>	A pointer to the buffer of data that is input from callback caller.
<i>InputBufferSize</i>	Indicates the size, in bytes, of the data buffer specified by <i>InBuffer</i> .
<i>OutputBuffer</i>	A pointer to the buffer of data that will be output from callback callee. Callee allocates this buffer by using EFI Boot Service <b>AllocatePool()</b> .
<i>OutputBufferSize</i>	Indicates the size, in bytes, of the data buffer specified by <i>OutputBuffer</i> .

```
typedef enum {
  EfiBluetoothCallbackTypeUserPasskeyNotification,
  EfiBluetoothCallbackTypeUserConfirmationRequest,
  EfiBluetoothCallbackTypeOOBDataRequest,
  EfiBluetoothCallbackTypePinCodeRequest,
  EfiBluetoothCallbackTypeMax,
} EFI_BLUETOOTH_PIN_CALLBACK_TYPE;
```

*EfiBluetoothCallbackTypeUserPasskeyNotification*

For SSP – passkey entry. Input buffer is Passkey (4 bytes). No output buffer. See Bluetooth HCI command for detail.

*EfiBluetoothCallbackTypeUserConfirmationRequest*

For SSP – just work and numeric comparison. Input buffer is numeric value (4 bytes). Output buffer is BOOLEAN (1 byte). See Bluetooth HCI command for detail.

*EfiBluetoothCallbackTypeOOBDataRequest*

For SSP – OOB. See Bluetooth HCI command for detail.

*EfiBluetoothCallbackTypePinCodeRequest*

For legacy pairing. No input buffer. Output buffer is PIN code (<= 16 bytes). See Bluetooth HCI command for detail.

## Status Codes Returned

EFI_SUCCESS	The PIN callback function is registered successfully.
-------------	---

## BLUETOOTH\_CONFIG\_PROTOCOL.RegisterGetLinkKeyCallback

### Summary

Register get link key callback function.

### Prototype

```
typedef
EFI_STATUS
(EFI_API *EFI_BLUETOOTH_CONFIG_REGISTER_GET_LINK_KEY_CALLBACK) (
    IN EFI_BLUETOOTH_CONFIG_PROTOCOL          *This,
    IN EFI_BLUETOOTH_CONFIG_REGISTER_GET_LINK_KEY_CALLBACK_FUNCTION
    Callback,
    IN VOID                                  *Context
);
```

### Parameters

<i>This</i>	Pointer to the <b>EFI_BLUETOOTH_CONFIG_PROTOCOL</b> instance.
<i>Callback</i>	The callback function. <b>NULL</b> means unregister.
<i>Context</i>	Data passed into <i>Callback</i> function. This is optional parameter and may be <b>NULL</b> .

### Description

The **RegisterGetLinkKeyCallback()** function registers Bluetooth get link key callback function. The Bluetooth configuration driver may call **RegisterGetLinkKeyCallback()** to register a callback function. When Bluetooth bus driver get Link\_Key\_Request\_Event, Bluetooth bus driver must trigger this callback function if it is registered. Then the callback function in Bluetooth configuration driver must pass link key to Bluetooth bus driver. When the callback function is returned Bluetooth bus driver gets link key and must send HCI\_Link\_Key\_Request\_Reply to remote device. If this *GetLinkKey* callback function is not registered or Bluetooth configuration driver fails to return a valid link key, the Bluetooth bus driver must send HCI\_Link\_Key\_Request\_Negative\_Reply to remote device. The original link key is passed by Bluetooth bus driver to Bluetooth configuration driver by using **EFI\_BLUETOOTH\_CONFIG\_REGISTER\_SET\_LINK\_KEY\_CALLBACK\_FUNCTION**. The Bluetooth configuration driver need save link key to a non-volatile safe place. (See Bluetooth specification, HCI\_Link\_Key\_Request\_Reply)

## Related Definitions

```
typedef
EFI_STATUS
(EFIAPI
*EFI_BLUETOOTH_CONFIG_REGISTER_GET_LINK_KEY_CALLBACK_FUNCTION) (
  IN EFI_BLUETOOTH_CONFIG_PROTOCOL *This,
  IN VOID *Context,
  IN BLUETOOTH_ADDRESS *BDAAddr,
  OUT UINT8 LinkKey[BLUETOOTH_HCI_LINK_KEY_SIZE]
);
```

*This* Pointer to the **EFI\_BLUETOOTH\_CONFIG\_PROTOCOL** instance.

*Context* Context passed from registration.

*CallbackType* Callback type in **EFI\_BLUETOOTH\_PIN\_CALLBACK\_TYPE**.

*BDAAddr* A pointer to Bluetooth device address.

*LinkKey* A pointer to the buffer of link key.

## Status Codes Returned

EFI_SUCCESS	The link key callback function is registered successfully.
-------------	--

## BLUETOOTH\_CONFIG\_PROTOCOL.RegisterSetLinkKeyCallback

### Summary

Register set link key callback function.

### Prototype

```
typedef
EFI_STATUS
(EFIAPI *EFI_BLUETOOTH_CONFIG_REGISTER_SET_LINK_KEY_CALLBACK) (
  IN EFI_BLUETOOTH_CONFIG_PROTOCOL      *This,
  IN EFI_BLUETOOTH_CONFIG_REGISTER_SET_LINK_KEY_CALLBACK_FUNCTION
  Callback,
  IN VOID                               *Context
);
```

### Parameters

<i>This</i>	Pointer to the <b>EFI_BLUETOOTH_CONFIG_PROTOCOL</b> instance.
<i>Callback</i>	The callback function. <b>NULL</b> means unregister.
<i>Context</i>	Data passed into <i>Callback</i> function. This is optional parameter and may be <b>NULL</b> .

### Description

The **RegisterSetLinkKeyCallback()** function registers Bluetooth link key callback function. The Bluetooth configuration driver may call **RegisterSetLinkKeyCallback()** to register a callback function to get link key from Bluetooth bus driver. When Bluetooth bus driver gets Link\_Key\_Notification\_Event, Bluetooth bus driver must call this callback function if it is registered. Then the callback function in Bluetooth configuration driver must save link key to a safe place. This link key will be used by **EFI\_BLUETOOTH\_CONFIG\_REGISTER\_GET\_LINK\_KEY\_CALLBACK\_FUNCTION** later. (See Bluetooth specification, Link\_Key\_Notification\_Event)

### Related Definitions

```
typedef
EFI_STATUS
(EFIAPI
*EFI_BLUETOOTH_CONFIG_REGISTER_SET_LINK_KEY_CALLBACK_FUNCTION) (
  IN EFI_BLUETOOTH_CONFIG_PROTOCOL *This,
  IN VOID                          *Context,
  IN BLUETOOTH_ADDRESS             *BdAddr,
  IN UINT8                         LinkKey[BLUETOOTH_HCI_LINK_KEY_SIZE]
);
```

<i>This</i>	Pointer to the <b>EFI_BLUETOOTH_CONFIG_PROTOCOL</b> instance.
<i>Context</i>	Context passed from registration.



<i>CallbackType</i>	Callback type in <b>EFI_BLUETOOTH_PIN_CALLBACK_TYPE</b> .
<i>BDAAddr</i>	A pointer to Bluetooth device address.
<i>LinkKey</i>	A pointer to the buffer of link key.

### Status Codes Returned

EFI_SUCCESS	The link key callback function is registered successfully.
-------------	--

## BLUETOOTH\_CONFIG\_PROTOCOL.RegisterLinkConnectCompleteCallback

### Summary

Register link connect complete callback function.

### Prototype

```
typedef
EFI_STATUS
(EFI_API *EFI_BLUETOOTH_CONFIG_REGISTER_CONNECT_COMPLETE_CALLBACK)
(
    IN EFI_BLUETOOTH_CONFIG_PROTOCOL          *This,
    IN
    EFI_BLUETOOTH_CONFIG_REGISTER_CONNECT_COMPLETE_CALLBACK_FUNCTION Callback,
    IN VOID                                  *Context
);
```

### Parameters

<i>This</i>	Pointer to the <b>EFI_BLUETOOTH_CONFIG_PROTOCOL</b> instance.
<i>Callback</i>	The callback function. <b>NULL</b> means unregister.
<i>Context</i>	Data passed into <i>Callback</i> function. This is optional parameter and may be <b>NULL</b> .

### Description

The **RegisterLinkConnectCompleteCallback()** function registers Bluetooth link connect complete callback function. The Bluetooth Configuration driver may call **RegisterLinkConnectCompleteCallback()** to register a callback function. During pairing, Bluetooth bus driver must trigger this callback function to report device state, if it is registered. Then Bluetooth Configuration driver will get information on device connection, according to *CallbackType* defined by **EFI\_BLUETOOTH\_CONNECT\_COMPLETE\_CALLBACK\_TYPE**.

## Related Definitions

```
typedef
EFI_STATUS
(EFI_API
*EFI_BLUETOOTH_CONFIG_REGISTER_CONNECT_COMPLETE_CALLBACK_FUNC
TION) (
  IN EFI_BLUETOOTH_CONFIG_PROTOCOL    *This,
  IN VOID                             *Context,
  IN EFI_BLUETOOTH_CONNECT_COMPLETE_CALLBACK_TYPE CallbackType,
  IN BLUETOOTH_ADDRESS                BDAAddr,
  IN VOID                             *InputBuffer,
  IN UINTN                            InputBufferSize
);
```

<i>This</i>	Pointer to the <b>EFI_BLUETOOTH_CONFIG_PROTOCOL</b> instance.
<i>Context</i>	Context passed from registration.
<i>CallbackType</i>	Callback type in <b>EFI_BLUETOOTH_CONNECT_COMPLETE_CALLBACK_TYPE</b> .
<i>BDAAddr</i>	A pointer to Bluetooth device address.
<i>InBuffer</i>	A pointer to the buffer of data that is input from callback caller.
<i>InputBufferSize</i>	Indicates the size, in bytes, of the data buffer specified by <i>InBuffer</i> .

```
typedef enum {
  EfiBluetoothConnCallbackTypeDisconnected,
  EfiBluetoothConnCallbackTypeConnected,
  EfiBluetoothConnCallbackTypeAuthenticated,
  EfiBluetoothConnCallbackTypeEncrypted,
} EFI_BLUETOOTH_CONNECT_COMPLETE_CALLBACK_TYPE;
```

### *EfiBluetoothConnCallbackTypeDisconnected*

This callback is called when Bluetooth receive Disconnection\_Complete event. Input buffer is Event Parameters of Disconnection\_Complete Event defined in Bluetooth specification.

### *EfiBluetoothConnCallbackTypeConnected*

This callback is called when Bluetooth receive Connection\_Complete event. Input buffer is Event Parameters of Connection\_Complete Event defined in Bluetooth specification.

### *EfiBluetoothConnCallbackTypeAuthenticated*

This callback is called when Bluetooth receive Authentication\_Complete event. Input buffer is Event

Parameters of Authentication\_Complete Event defined in Bluetooth specification.

### *EfiBluetoothConnCallbackTypeEncrypted*

This callback is called when Bluetooth receive Encryption\_Change event. Input buffer is Event Parameters of Encryption\_Change Event defined in Bluetooth specification.

## Status Codes Returned

EFI_SUCCESS	The link connect complete callback function is registered successfully.
-------------	---

## 27.4 EFI Bluetooth Attribute Protocol

### EFI\_BLUETOOTH\_ATTRIBUTE\_PROTOCOL

#### Summary

This protocol provides service for Bluetooth ATT (Attribute Protocol) and GATT (Generic Attribute Profile) based protocol interfaces.

#### GUID

```
#define EFI_BLUETOOTH_ATTRIBUTE_PROTOCOL_GUID \
  { 0x898890e9, 0x84b2, 0x4f3a, { 0x8c, 0x58, 0xd8, 0x57, 0x78, 0x13, 0xe0, 0xac } }
```

#### Protocol Interface Structure

```
typedef struct _EFI_BLUETOOTH_ATTRIBUTE_PROTOCOL {
  EFI_BLUETOOTH_ATTRIBUTE_SEND_REQUEST      SendRequest;
  EFI_BLUETOOTH_ATTRIBUTE_REGISTER_FOR_SERVER_NOTIFICATION
  RegisterForServerNotification;
  EFI_BLUETOOTH_ATTRIBUTE_GET_SERVICE_INFO   GetServiceInfo;
  EFI_BLUETOOTH_ATTRIBUTE_GET_DEVICE_INFO   GetDeviceInfo;
} EFI_BLUETOOTH_ATTRIBUTE_PROTOCOL;
```

#### Parameters

##### *SendRequest*

Send a “REQUEST” or “COMMAND” message to remote server and receive a “RESPONSE” message for “REQUEST” from remote server according to Bluetooth attribute protocol data unit (PDU). See the *SendRequest( )* function description.

##### *RegisterForServerNotification*

Register or unregister a server initiated PDU, such as “NOTIFICATION” or “INDICATION” on a characteristic value on

	remote server. See the RegisterForServerInitiatedMessage() function description.
<i>GetServiceInfo</i>	Get discovered service data information from connected remote device. See <i>GetServiceInfo()</i> function description.
<i>GetDeviceInfo</i>	Get the device information. See <i>GetDeviceInfo()</i> function description.

## Description

The **EFI\_BLUETOOTH\_ATTRIBUTE\_PROTOCOL** provides services in ATT protocol and GATT profile. For detail of ATT protocol, and GATT profile, please refer to Bluetooth specification.

## BLUETOOTH\_ATTRIBUTE\_PROTOCOL.SendRequest

### Summary

Send a “REQUEST” or “COMMAND” message to remote server and receive a “RESPONSE” message for “REQUEST” from remote server according to Bluetooth attribute protocol data unit (PDU).

### Prototype

```
typedef
EFI_STATUS
(EFI_API *EFI_BLUETOOTH_ATTRIBUTE_SEND_REQUEST) (
    IN EFI_BLUETOOTH_ATTRIBUTE_PROTOCOL      *This,
    IN VOID                                  *Data,
    IN UINTN                                 DataLength,
    IN EFI_BLUETOOTH_ATTRIBUTE_CALLBACK_FUNCTION Callback,
    IN VOID                                  *Context
);
```

### Parameters

<i>This</i>	Pointer to the <b>EFI_BLUETOOTH_ATTRIBUTE_PROTOCOL</b> instance.
<i>Data</i>	Data of a REQUEST or COMMAND message. The first byte is the attribute PDU related opcode, followed by opcode specific fields. See Bluetooth specification, Vol 3, Part F, Attribute Protocol.
<i>DataLength</i>	The length of <i>Data</i> in bytes.

<i>Callback</i>	Callback function to notify the RESPONSE is received to the caller, with the response buffer. Caller must check the response buffer content to know if the request action is success or fail. It may be NULL if the data is a COMMAND.
<i>Context</i>	Data passed into <i>Callback</i> function. It is optional parameter and may be NULL.

## Description

The **SendRequest** ( ) function sends a “REQUEST” or “COMMAND” message to remote server and receive a “RESPONSE” message for “REQUEST” from remote server according to Bluetooth attribute protocol data unit (PDU). In most cases, this interface is used to read attributes from remote device, or write attributes to remote device.

## Related Definitions

```
typedef
EFI_STATUS
(EFIAPI *EFI_BLUETOOTH_ATTRIBUTE_CALLBACK_FUNCTION) (
    IN EFI_BLUETOOTH_ATTRIBUTE_PROTOCOL *This,
    IN VOID                            *Data,
    IN UINTN                           DataLength,
    IN VOID                            *Context
);
```

<i>This</i>	Pointer to the <b>EFI_BLUETOOTH_ATTRIBUTE_PROTOCOL</b> instance.
<i>Data</i>	Data received. The first byte is the attribute opcode, followed by opcode specific fields. See Bluetooth specification, Vol 3, Part F, Attribute Protocol. It might be a normal RESPONSE message, or ERROR RESPONSE message.
<i>DataLength</i>	The length of <i>Data</i> in bytes.
<i>Context</i>	The context passed from the callback registration request.

## Status Codes Returned

EFI_SUCCESS	The request is sent successfully.
EFI_INVALID_PARAMETER	One or more parameters are invalid due to following conditions: <ul style="list-style-type: none"> <li>  The <i>Buffer</i> is NULL.</li> <li>  The</li> <li>  <i>BufferLength</i> is 0.</li> <li>  The opcode in <i>Buffer</i> is not a valid OPCODE according to Bluetooth specification.</li> <li>  The</li> <li>  <i>Callback</i> is NULL.</li> </ul>
EFI_DEVICE_ERROR	Sending the request failed due to the host controller or the device error.
EFI_NOT_READY	A GATT operation is already underway for this device
EFI_UNSUPPORTED	The attribute does not support the corresponding operation

## BLUETOOTH\_ATTRIBUTE\_PROTOCOL.RegisterForServerNotification

### Summary

Register or unregister a server initiated message, such as NOTIFICATION or INDICATION, on a characteristic value on remote server.

### Prototype

```
typedef
EFI_STATUS
(EFIAPI *EFI_BLUETOOTH_ATTRIBUTE_REGISTER_FOR_SERVER_NOTIFICATION) (
    IN EFI_BLUETOOTH_ATTRIBUTE_PROTOCOL      *This,
    IN EFI_BLUETOOTH_ATTRIBUTE_CALLBACK_PARAMETER *CallbackParameter,
    IN EFI_BLUETOOTH_ATTRIBUTE_CALLBACK_FUNCTION Callback,
    IN VOID                                  *Context
);
```

### Parameters

*This*                      Pointer to the **EFI\_BLUETOOTH\_ATTRIBUTE\_PROTOCOL** instance.

*CallbackParameter*      The parameter of the callback.

*Callback*                 Callback function for server initiated attribute protocol. NULL callback function means unregister the server initiated callback.

*Context* Data passed into *Callback* function. It is optional parameter and may be NULL.

## Description

The **RegisterForServerNotification()** function can be issued to request Bluetooth to register or unregister a server initiated message, such as notification or indication, on a characteristic value on remote server. It can only be done if the characteristic supports that operation.

## Related Definitions

```
typedef struct {
    UINT16      AttributeHandle;
} EFI_BLUETOOTH_ATTRIBUTE_CALLBACK_PARAMETER_NOTIFICATION;
typedef struct {
    UINT16      AttributeHandle;
} EFI_BLUETOOTH_ATTRIBUTE_CALLBACK_PARAMETER_INDICATION;
typedef struct {
    UINT32      Version;
    UINT8       AttributeOpCode;
    union {
        EFI_BLUETOOTH_ATTRIBUTE_CALLBACK_PARAMETER_NOTIFICATION
Notification;
        EFI_BLUETOOTH_ATTRIBUTE_CALLBACK_PARAMETER_INDICATION Indication;
    } Parameter;
} EFI_BLUETOOTH_ATTRIBUTE_CALLBACK_PARAMETER;
```

*Version* The version of the structure. A value of zero represents the **EFI\_BLUETOOTH\_ATTRIBUTE\_CALLBACK\_PARAMETER** structure as defined here. Future version of this specification may extend this data structure in a backward compatible way and increase the value of *Version*.

*AttributeOpCode* The attribute opcode for server initiated attribute protocol. See Bluetooth specification, Vol 3, Part F, Attribute Protocol.

*AttributeHandle* The attribute handle for notification or indication.

## Status Codes Returned

EFI_SUCCESS	The callback function is registered or unregistered successfully
-------------	--



EFI_INVALID_PARAMETER	The attribute opcode is not server initiated message opcode. See Bluetooth specification, Vol 3, Part F, Attribute Protocol.
EFI_ALREADY_STARTED	A callback function is already registered on the same attribute opcode and attribute handle, when the <i>Callback</i> is not NULL.
EFI_NOT_STARTED	A callback function is not registered on the same attribute opcode and attribute handle, when the <i>Callback</i> is NULL.
EFI_NOT_READY	A GATT operation is already underway for this device
EFI_UNSUPPORTED	The attribute does not support notification

## BLUETOOTH\_ATTRIBUTE\_PROTOCOL.GetServiceInfo

### Summary

Get Bluetooth discovered service information.

### Prototype

```
typedef
EFI_STATUS
(EFI_API *EFI_BLUETOOTH_ATTRIBUTE_GET_SERVICE_INFO)(
IN EFI_BLUETOOTH_ATTRIBUTE_PROTOCOL *This,
OUT UINTN *ServiceInfoSize,
OUT VOID **ServiceInfo
);
```

### Parameters

<i>This</i>	Pointer to the <b>EFI_BLUETOOTH_ATTRIBUTE_PROTOCOL</b> instance.
<i>ServiceInfoSize</i>	A pointer to the size, in bytes, of the <i>ServiceInfo</i> buffer.
<i>ServiceInfo</i>	A pointer to a callee allocated buffer that returns Bluetooth discovered service information. Callee allocates this buffer by using EFI Boot Service <b>AllocatePool()</b> .

### Description

The **GetServiceInfo()** function returns Bluetooth discovered service information. The size of *ServiceInfo* structure should never be assumed and the value of *ServiceInfoSize* is the only valid way to know the size of *ServiceInfo*. The *ServiceInfo* buffer is a list Bluetooth service information structures defined below.

## Related Definitions

```
typedef struct {
    UINT8    Length;
    union {
        UINT16    Uuid16;
        UINT32    Uuid32;
        UINT8     Uuid128[16];
    } Data;
} EFI_BLUETOOTH_UUID;
```

<i>Length</i>	The length of Bluetooth UUID data. The valid value is 2, 4, or 16.
<i>Uuid16</i>	The 16-bit Bluetooth UUID data.
<i>Uuid32</i>	The 32-bit Bluetooth UUID data.
<i>Uuid128</i>	The 128-bit Bluetooth UUID data.

```
typedef struct {
    EFI_BLUETOOTH_UUID    Type;
    UINT16    Length;
    UINT16    AttributeHandle;
    EFI_BLUETOOTH_ATTRIBUTE_PERMISSION AttributePermission;
} EFI_BLUETOOTH_ATTRIBUTE_HEADER;
```

<i>Type</i>	The type of this structure. It must be <b>EFI_BLUETOOTH_UUID</b> . See Bluetooth GATT definition. Primary Service is 0x2800. Secondary Service is 0x2801. Include Service is 0x2802. Characteristic is 0x2803. Characteristic Descriptor is 0x2900.
<i>Length</i>	The length of this structure.
<i>AttributeHandle</i>	The handle of the service declaration. See Bluetooth specification.

*AttributePermission* The permission of the attribute. This field is only valid for the attribute of the local device. This field should be ignored for the attribute of the remote device.

```
//
// Bluetooth Attribute Permission
//
typedef union {
    struct {
        UINT16 Readable    : 1;
        UINT16 ReadEncryption : 1;
        UINT16 ReadAuthentication : 1;
        UINT16 ReadAuthorization : 1;
        UINT16 ReadKeySize   : 5;
```

```

UINT16 Reserved1    : 7;
UINT16 Writeable    : 1;
UINT16 WriteEncryption : 1;
UINT16 WriteAuthentication : 1;
UINT16 WriteAuthorization : 1;
UINT16 WriteKeySize : 5;
UINT16 Reserved2    : 7;
} Permission;
UINT32 Data32;
} EFI_BLUETOOTH_ATTRIBUTE_PERMISSION;

    Readable                The attribute is readable.
    ReadEncryption          The encryption is required on read.
    ReadAuthentication      The authentication is required on read.
    ReadAuthorization       The authorization is required on read.
    ReadKeySize             The size of key in bytes on read.
    Writeable               The attribute is writeable.
    WriteEncryption         The encryption is required on write.
    WriteAuthentication     The authentication is required on write.
    WriteAuthorization      The authorization is required on write.
    WriteKeySize           The size of key in bytes on write.

```

```

typedef struct {
    EFI_BLUETOOTH_ATTRIBUTE_HEADER Header;
    UINT16 EndGroupHandle;
    EFI_BLUETOOTH_UUID ServiceUuid;
} EFI_BLUETOOTH_GATT_PRIMARY_SERVICE_INFO;

    EndGroupHandle          The handle of the last attribute within the service definition. See
                           Bluetooth specification.
    Header                  The header of this structure.

```

```

typedef struct {
    EFI_BLUETOOTH_ATTRIBUTE_HEADER Header;
    UINT16 StartGroupHandle;
    UINT16 EndGroupHandle;
    EFI_BLUETOOTH_UUID ServiceUuid;
} EFI_BLUETOOTH_GATT_INCLUDE_SERVICE_INFO;

    Header                  The header of this structure.

```

```

typedef struct {
  EFI_BLUETOOTH_ATTRIBUTE_HEADER Header;
  UINT8 CharacteristicProperties;
  UINT16 CharacteristicValueHandle;
  EFI_BLUETOOTH_UUID CharacteristicUuid;
} EFI_BLUETOOTH_GATT_CHARACTERISTIC_INFO;

```

*Header* The header of this structure.

```

typedef struct {
  EFI_BLUETOOTH_ATTRIBUTE_HEADER Header;
  EFI_BLUETOOTH_UUID CharacteristicDescriptorUuid;
} EFI_BLUETOOTH_GATT_CHARACTERISTIC_DESCRIPTOR_INFO;

```

*Header*

The header of this structure.

## Status Codes Returned

EFI_SUCCESS	The Bluetooth discovered service information is returned successfully.
EFI_DEVICE_ERROR	A hardware error occurred trying to retrieve the Bluetooth discovered service information.

## BLUETOOTH\_ATTRIBUTE\_PROTOCOL.GetDeviceInfo

### Summary

Get Bluetooth device information.

### Prototype

```
typedef
EFI_STATUS
(EFIAPI *EFI_BLUETOOTH_ATTRIBUTE_GET_DEVICE_INFO)(
IN EFI_BLUETOOTH_ATTRIBUTE_PROTOCOL *This,
OUT UINTN                               *DeviceInfoSize,
OUT VOID                                **DeviceInfo
);
```

### Parameters

<i>This</i>	Pointer to the <b>EFI_BLUETOOTH_ATTRIBUTE_PROTOCOL</b> instance.
<i>DeviceInfoSize</i>	A pointer to the size, in bytes, of the <i>DeviceInfo</i> buffer.
<i>DeviceInfo</i>	A pointer to a callee allocated buffer that returns Bluetooth device information. Callee allocates this buffer by using EFI Boot Service <b>AllocatePool()</b> . If this device is Bluetooth classic device, <b>EFI_BLUETOOTH_DEVICE_INFO</b> should be used. If this device is Bluetooth LE device, <b>EFI_BLUETOOTH_LE_DEVICE_INFO</b> should be used.

### Description

The **GetDeviceInfo()** function returns Bluetooth device information. The size of *DeviceInfo* structure should never be assumed and the value of *DeviceInfoSize* is the only valid way to know the size of *DeviceInfo*.

## Related Definitions

```
typedef struct {
    UINT8    Address[6];
    UINT8    Type;
} BLUETOOTH_LE_ADDRESS;
```

```
typedef struct {
    UINT32    Version;
    BLUETOOTH_LE_ADDRESS  BD_ADDR;
    BLUETOOTH_LE_ADDRESS  DirectAddress;
    UINT8     RSSI;
    UINTN     AdvertisementDataSize;
    VOID      *AdvertisementData;
} EFI_BLUETOOTH_LE_DEVICE_INFO;
```

### *Version*

The version of the structure. A value of zero represents the `EFI_BLUETOOTH_LE_DEVICE_INFO` structure as defined here. Future version of this specification may

extend this data structure in a backward compatible way and increase the value of *Version*.

<i>BD_ADDR</i>	48bit Bluetooth device address and 1byte address type.
<i>DirectAddress</i>	48bit random device address and 1byte address type.
<i>RSSI</i>	Bluetooth RSSI. See Bluetooth specification for detail.
<i>AdvertisementDataSize</i>	The size of <i>AdvertisementData</i> in bytes.
<i>AdvertisementData</i>	Bluetooth LE advertisement data. See Bluetooth specification for detail.

### Status Codes Returned

EFI_SUCCESS	The Bluetooth device information is returned successfully.
EFI_DEVICE_ERROR	A hardware error occurred trying to retrieve the Bluetooth device information.

## EFI\_BLUETOOTH\_ATTRIBUTE\_SERVICE\_BINDING\_PROTOCOL

### Summary

The EFI Bluetooth ATTRIBUTE Service Binding Protocol is used to locate EFI Bluetooth ATTRIBUTE Protocol drivers to create and destroy child of the driver to communicate with other Bluetooth device by using Bluetooth ATTRIBUTE protocol.

### GUID

```
#define EFI_BLUETOOTH_ATTRIBUTE_SERVICE_BINDING_PROTOCOL_GUID \
{ \
    0x5639867a, 0x8c8e, 0x408d, 0xac, 0x2f, 0x4b, 0x61, 0xbd, 0xc0, 0xbb, 0xbb \
}
```

### Description

The Bluetooth ATTRIBUTE consumer need locate `EFI_BLUETOOTH_ATTRIBUTE_SERVICE_BINDING_PROTOCOL` and call `CreateChild()` to create a new child of `EFI_BLUETOOTH_ATTRIBUTE_PROTOCOL` instance. Then use `EFI_BLUETOOTH_ATTRIBUTE_PROTOCOL` for Bluetooth communication. After use, the Bluetooth ATTRIBUTE consumer need call `DestroyChild()` to destroy it.

## 27.5 EFI Bluetooth LE Configuration Protocol

### EFI\_BLUETOOTH\_LE\_CONFIG\_PROTOCOL

### Summary

This protocol abstracts user interface configuration for BluetoothLe device.

**GUID**

```
#define EFI_BLUETOOTH_LE_CONFIG_PROTOCOL_GUID \
  { 0x8f76da58, 0x1f99, 0x4275, { 0xa4, 0xec, 0x47, 0x56, 0x51, 0x5b,
    0x1c, 0xe8 }}
```

**Protocol Interface Structure**

```
typedef struct _EFI_BLUETOOTH_LE_CONFIG_PROTOCOL {
  EFI_BLUETOOTH_LE_CONFIG_INIT    Init;
  EFI_BLUETOOTH_LE_CONFIG_SCAN    Scan;
  EFI_BLUETOOTH_LE_CONFIG_CONNECT Connect;
  EFI_BLUETOOTH_LE_CONFIG_DISCONNECT Disconnect;
  EFI_BLUETOOTH_LE_CONFIG_GET_DATA  GetData;
  EFI_BLUETOOTH_LE_CONFIG_SET_DATA  SetData;
  EFI_BLUETOOTH_LE_CONFIG_GET_REMOTE_DATA GetRemoteData;
  EFI_BLUETOOTH_LE_CONFIG_REGISTER_SMP_AUTH_CALLBACK
  RegisterSmpAuthCallback;
  EFI_BLUETOOTH_LE_CONFIG_SEND_SMP_AUTH_DATA SendSmpAuthData;
  EFI_BLUETOOTH_LE_CONFIG_REGISTER_SMP_GET_DATA_CALLBACK
  RegisterSmpGetDataCallback;
  EFI_BLUETOOTH_LE_CONFIG_REGISTER_SMP_SET_DATA_CALLBACK
  RegisterSmpSetDataCallback;
  EFI_BLUETOOTH_LE_CONFIG_REGISTER_CONNECT_COMPLETE_CALLBACK
  RegisterLinkConnectCompleteCallback;
} EFI_BLUETOOTH_LE_CONFIG_PROTOCOL;
```



## Parameters

<i>Init</i>	Initialize BluetoothLE host controller and local device. See the <b>Init()</b> function description.
<i>Scan</i>	Scan BluetoothLE device. See the <b>Scan()</b> function description.
<i>Connect</i>	Connect one BluetoothLE device. See the <b>Connect()</b> function description.
<i>Disconnect</i>	Disconnect one BluetoothLE device. See the <b>Disconnect()</b> function description.
<i>GetData</i>	Get BluetoothLE configuration data. See the <b>GetData()</b> function description.
<i>SetData</i>	Set BluetoothLE configuration data. See the <b>SetData()</b> function description.
<i>GetRemoteData</i>	Get remote BluetoothLE device data. See the <b>GetRemoteData()</b> function description.
<i>RegisterSmpAuthCallback</i>	Register Security Manager Callback function. This function will be called from Bluetooth BUS driver whenever user interaction is required for security protocol authorization/authentication. See the <b>RegisterSmpAuthCallback()</b> function description.
<i>SendSmpAuthData</i>	Send user input (Authentication/Authorization) such as passkey, confirmation (yes/no) in response to pairing request. See the <b>SendSmpAuthData()</b> function description.
<i>RegisterSmpGetDataCallback</i>	Register a callback function to get SMP related data. See the <b>RegisterSmpGetDataCallback()</b> function description.
<i>RegisterSmpSetDataCallback</i>	Register a callback function to set SMP related data. See the <b>RegisterSmpGetDataCallback()</b> function description.
<i>RegisterLinkConnectCompleteCallback</i>	Register link connect complete callback function. See the <b>RegisterLinkConnectCompleteCallback()</b> function description.

## Description

The **EFI\_BLUETOOTH\_LE\_CONFIG\_PROTOCOL** abstracts the BluetoothLE configuration. User can use BluetoothLE configuration to interactive with BluetoothLE bus driver.

## BLUETOOTH\_LE\_CONFIG\_PROTOCOL.Init

### Summary

Initialize BluetoothLE host controller and local device.

### Prototype

```
typedef
EFI_STATUS
(EFIAPI *EFI_BLUETOOTH_LE_CONFIG_INIT)(
IN EFI_BLUETOOTH_LE_CONFIG_PROTOCOL *This
);
```

### Parameters

*This* Pointer to the **EFI\_BLUETOOTH\_LE\_CONFIG\_PROTOCOL** instance.

### Description

The **Init()** function initializes BluetoothLE host controller and local device.

### Status Codes Returned

EFI_SUCCESS	The BluetoothLE host controller and local device is initialized successfully.
EFI_DEVICE_ERROR	A hardware error occurred trying to initialize the BluetoothLE host controller and local device.

## BLUETOOTH\_LE\_CONFIG\_PROTOCOL.Scan

### Summary

Scan BluetoothLE device.

### Prototype

```
typedef
EFI_STATUS
(EFIAPI *EFI_BLUETOOTH_LE_CONFIG_SCAN)(
  IN EFI_BLUETOOTH_LE_CONFIG_PROTOCOL  *This,
  IN BOOLEAN                          ReScan,
  IN UIN32                             Timeout,
  IN EFI_BLUETOOTH_LE_CONFIG_SCAN_PARAMETER *ScanParameter,
  OPTIONAL
  IN EFI_BLUETOOTH_LE_CONFIG_SCAN_CALLBACK_FUNCTION Callback,
  IN VOID                               *Context
);
```

### Parameters

<i>This</i>	Pointer to the <b>EFI_BLUETOOTH_LE_CONFIG_PROTOCOL</b> instance.
<i>ReScan</i>	If <b>TRUE</b> , a new scan request is submitted no matter there is scan result before. If <b>FALSE</b> and there is scan result, the previous scan result is returned and no scan request is submitted.
<i>Timeout</i>	Duration in milliseconds for which to scan.
<i>ScanParameter</i>	If it is not <b>NULL</b> , the <i>ScanParameter</i> is used to perform a scan by the BluetoothLE bus driver. If it is <b>NULL</b> , the default parameter is used.
<i>Callback</i>	The callback function. This function is called if a BluetoothLE device is found during scan process.
<i>Context</i>	Data passed into <i>Callback</i> function. This is optional parameter and may be <b>NULL</b> .

### Description

The **Scan()** function scans BluetoothLE device. When this function is returned, it just means scan request is submitted. It does not mean scan process is started or finished. Whenever there is a

BluetoothLE device is found, the *Callback* function will be called. *Callback* function might be called before this function returns or after this function returns.

## Related Definitions

```
typedef struct {
// Scan parameter
    UINT32    Version;
    UINT8     ScanType;
    UINT16    ScanInterval;
    UINT16    ScanWindow;
    UINT8     ScanningFilterPolicy;
// Scan result filter
    UINT8     AdvertisementFlagFilter;
} EFI_BLUETOOTH_LE_CONFIG_SCAN_PARAMETER;
```

<i>Version</i>	The version of the structure. A value of zero represents the <b>EFI_BLUETOOTH_LE_CONFIG_SCAN_PARAMETER</b> structure as defined here. Future version of this specification may extend this data structure in a backward compatible way and increase the value of <i>Version</i> .
<i>ScanType</i>	Passive scanning or active scanning. See Bluetooth specification.
<i>ScanInterval</i>	Recommended scan interval to be used while performing scan.
<i>ScanWindow</i>	Recommended scan window to be used while performing a scan.
<i>ScanningFilterPolicy</i>	Recommended scanning filter policy to be used while performing a scan.
<i>AdvertisementFlagFilter</i>	This is one byte flag to serve as a filter to remove unneeded scan result. For example, set BIT0 means scan in LE Limited Discoverable Mode. Set BIT1 means scan in LE General Discoverable Mode. See Supplement to Bluetooth Core Specification.

```

typedef
EFI_STATUS
(EFI_API *EFI_BLUETOOTH_LE_CONFIG_SCAN_CALLBACK_FUNCTION) (
  IN EFI_BLUETOOTH_LE_CONFIG_PROTOCOL   *This,
  IN VOID                               *Context,
  IN EFI_BLUETOOTH_LE_SCAN_CALLBACK_INFORMATION *CallbackInfo
);

```

*This* Pointer to the **EFI\_BLUETOOTH\_LE\_CONFIG\_PROTOCOL** instance.

*Context* Context passed from scan request.

*CallbackInfo* Data related to scan result. **NULL** CallbackInfo means scan complete.

```

typedef struct{
  BLUETOOTH_LE_ADDRESS  BDAAddr;
  BLUETOOTH_LE_ADDRESS  DirectAddress;
  UINT8                 RemoteDeviceState;
  INT8                  RSSI;
  UINTN                 AdvertisementDataSize;
  VOID                  *AdvertisementData;
} EFI_BLUETOOTH_LE_SCAN_CALLBACK_INFORMATION;

```

## Status Codes Returned

EFI_SUCCESS	The Bluetooth scan request is submitted.
EFI_DEVICE_ERROR	A hardware error occurred trying to scan the Bluetooth device.

## BLUETOOTH\_LE\_CONFIG\_PROTOCOL.Connect

### Summary

Connect a BluetoothLE device.

### Prototype

```
typedef
EFI_STATUS
(EFI_API *EFI_BLUETOOTH_LE_CONFIG_CONNECT)(
  IN EFI_BLUETOOTH_LE_CONFIG_PROTOCOL  *This,
  IN BOOLEAN                          AutoReconnect,
  IN BOOLEAN                          DoBonding;
  IN EFI_BLUETOOTH_LE_CONFIG_CONNECT_PARAMETER *ConnectParameter,
  OPTIONAL
  IN BLUETOOTH_LE_ADDRESS              *BD_ADDR
);
```

### Parameters

<i>This</i>	Pointer to the <b>EFI_BLUETOOTH_LE_CONFIG_PROTOCOL</b> instance.
<i>AutoReconnect</i>	If <b>TRUE</b> , the BluetoothLE host controller needs to do an auto reconnect. If <b>FALSE</b> , the BluetoothLE host controller does not do an auto reconnect.
<i>DoBonding</i>	If <b>TRUE</b> , the BluetoothLE host controller needs to do a bonding. If <b>FALSE</b> , the BluetoothLE host controller does not do a bonding.
<i>ConnectParameter</i>	If it is not <b>NULL</b> , the <i>ConnectParameter</i> is used to perform a scan by the BluetoothLE bus driver. If it is <b>NULL</b> , the default parameter is used.
<i>BD_ADDR</i>	The address of the BluetoothLE device to be connected.

### Description

The **Connect()** function connects a Bluetooth device. When this function is returned successfully, a new **EFI\_BLUETOOTH\_IO\_PROTOCOL** is created.

## Related Definitions

```
typedef struct {
    UINT32    Version;
    UINT16    ScanInterval;
    UINT16    ScanWindow;
    UINT16    ConnIntervalMin;
    UINT16    ConnIntervalMax;
    UINT16    ConnLatency;
    UINT16    SupervisionTimeout;
} EFI_BLUETOOTH_LE_CONFIG_CONNECT_PARAMETER;
```

<i>Version</i>	The version of the structure. A value of zero represents the <b>EFI_BLUETOOTH_LE_CONFIG_CONNECT_PARAMETER</b> structure as defined here. Future version of this specification may extend this data structure in a backward compatible way and increase the value of <i>Version</i> .
<i>ScanInterval</i>	Recommended scan interval to be used while performing scan before connect.
<i>ScanWindow</i>	Recommended scan window to be used while performing a connection.
<i>ConnIntervalMin</i>	Minimum allowed connection interval. Shall be less than or equal to <i>ConnIntervalMax</i> .
<i>ConnIntervalMax</i>	Maximum allowed connection interval. Shall be greater than or equal to <i>ConnIntervalMin</i> .
<i>ConnLatency</i>	Slave latency for the connection in number of connection events.
<i>SupervisionTimeout</i>	Link supervision timeout for the connection.

## Status Codes Returned

EFI_SUCCESS	The BluetoothLE device is connected successfully.
EFI_ALREADY_STARTED	The BluetoothLE device is already connected.
EFI_NOT_FOUND	The BluetoothLE device is not found.
EFI_DEVICE_ERROR	A hardware error occurred trying to connect the BluetoothLE device.

## BLUETOOTH\_LE\_CONFIG\_PROTOCOL.Disconnect

### Summary

Disconnect a BluetoothLE device.

### Prototype

```
typedef
EFI_STATUS
(EFIAPI *EFI_BLUETOOTH_LE_CONFIG_DISCONNECT)(
  IN EFI_BLUETOOTH_LE_CONFIG_PROTOCOL *This,
  IN BLUETOOTH_LE_ADDRESS    *BD_ADDR,
  IN UINT8                    Reason
);
```

### Parameters

<i>This</i>	Pointer to the <b>EFI_BLUETOOTH_LE_CONFIG_PROTOCOL</b> instance.
<i>BD_ADDR</i>	The address of BluetoothLE device to be connected.
<i>Reason</i>	BluetoothLE disconnect reason. See Bluetooth specification for detail.

### Description

The **Disconnect()** function disconnects a BluetoothLE device. When this function is returned successfully, the **EFI\_BLUETOOTH\_ATTRIBUTE\_PROTOCOL** associated with this device is destroyed and all services associated are stopped.

### Status Codes Returned

EFI_SUCCESS	The BluetoothLE device is disconnected successfully.
EFI_NOT_STARTED	The BluetoothLE device is not connected.
EFI_NOT_FOUND	The BluetoothLE device is not found.
EFI_DEVICE_ERROR	A hardware error occurred trying to disconnect the BluetoothLE device.



## BLUETOOTH\_LE\_CONFIG\_PROTOCOL.GetData

### Summary

Get BluetoothLE configuration data.

### Prototype

```
typedef
EFI_STATUS
(EFIAPI *EFI_BLUETOOTH_LE_CONFIG_GET_DATA) (
  IN EFI_BLUETOOTH_LE_CONFIG_PROTOCOL  *This,
  IN EFI_BLUETOOTH_CONFIG_DATA_TYPE  DataType,
  IN OUT UINTN          *DataSize,
  IN OUT VOID          *Data
);
```

### Parameters

<i>This</i>	Pointer to the <b>EFI_BLUETOOTH_LE_CONFIG_PROTOCOL</b> instance.
<i>DataType</i>	Configuration data type.
<i>DataSize</i>	On input, indicates the size, in bytes, of the data buffer specified by <i>Data</i> . On output, indicates the amount of data actually returned.
<i>Data</i>	A pointer to the buffer of data that will be returned.

### Description

The **GetData()** function returns BluetoothLE configuration data. For remote BluetoothLE device configuration data, please use **GetRemoteData()** function with valid **BD\_ADDR**.

### Status Codes Returned

EFI_SUCCESS	The BluetoothLE configuration data is returned successfully.
EFI_INVALID_PARAMETER	One or more of the following conditions is TRUE: <ul style="list-style-type: none"> <li>· <i>DataSize</i> is NULL.</li> <li>· <i>*DataSize</i> is 0.</li> <li>· <i>Data</i> is NULL.</li> </ul>
EFI_UNSUPPORTED	The <i>DataType</i> is unsupported.
EFI_NOT_FOUND	The <i>DataType</i> is not found.
EFI_BUFFER_TOO_SMALL	The buffer is too small to hold the buffer.

## BLUETOOTH\_LE\_CONFIG\_PROTOCOL.SetData

### Summary

Set BluetoothLE configuration data.

### Prototype

```
typedef
EFI_STATUS
(EFIAPI *EFI_BLUETOOTH_LE_CONFIG_SET_DATA) (
  IN EFI_BLUETOOTH_LE_CONFIG_PROTOCOL *This,
  IN EFI_BLUETOOTH_CONFIG_DATA_TYPE  DataType,
  IN UINTN          DataSize,
  IN VOID          *Data
);
```

### Parameters

<i>This</i>	Pointer to the <b>EFI_BLUETOOTH_LE_CONFIG_PROTOCOL</b> instance.
<i>DataType</i>	Configuration data type.
<i>DataSize</i>	Indicates the size, in bytes, of the data buffer specified by <i>Data</i> .
<i>Data</i>	A pointer to the buffer of data that will be set.

### Description

The **SetData()** function sets local BluetoothLE device configuration data. Not all *DataType* can be set.

### Status Codes Returned

EFI_SUCCESS	The BluetoothLE configuration data is set successfully.
EFI_INVALID_PARAMETER	One or more of the following conditions is TRUE: <ul style="list-style-type: none"> <li>· <i>DataSize</i> is 0.</li> <li>· <i>Data</i> is NULL.</li> </ul>
EFI_UNSUPPORTED	The <i>DataType</i> is unsupported.
EFI_WRITE_PROTECTED	Cannot set configuration data.

## BLUETOOTH\_LE\_CONFIG\_PROTOCOL.GetRemoteData

### Summary

Get remove BluetoothLE device configuration data.

### Prototype

```
typedef
EFI_STATUS
(EFI_API *EFI_BLUETOOTH_LE_CONFIG_GET_REMOTE_DATA) (
  IN EFI_BLUETOOTH_LE_CONFIG_PROTOCOL  *This,
  IN EFI_BLUETOOTH_CONFIG_DATA_TYPE  DataType,
  IN BLUETOOTH_LE_ADDRESS             *BdAddr,
  IN OUT UINTN                         *DataSize,
  IN OUT VOID                          *Data
);
```

### Parameters

<i>This</i>	Pointer to the <b>EFI_BLUETOOTH_LE_CONFIG_PROTOCOL</b> instance.
<i>DataType</i>	Configuration data type.
<i>BdAddr</i>	Remote BluetoothLE device address.
<i>DataSize</i>	On input, indicates the size, in bytes, of the data buffer specified by <i>Data</i> . On output, indicates the amount of data actually returned.
<i>Data</i>	A pointer to the buffer of data that will be returned.

### Description

The **GetRemoteData()** function returns remote BluetoothLE device configuration data.

## Status Codes Returned

EFI_SUCCESS	The remote BluetoothLE device configuration data is returned successfully.
EFI_INVALID_PARAMETER	One or more of the following conditions is TRUE: <ul style="list-style-type: none"> <li>· <i>DataSize</i> is NULL.</li> <li>· <i>*DataSize</i> is 0.</li> <li>· <i>Data</i> is NULL.</li> </ul>
EFI_UNSUPPORTED	The <i>Data Type</i> is unsupported.
EFI_NOT_FOUND	The <i>Data Type</i> is not found.
EFI_BUFFER_TOO_SMALL	The buffer is too small to hold the buffer.

## BLUETOOTH\_LE\_CONFIG\_PROTOCOL.RegisterSmpAuthCallback

### Summary

Register Security Manager Protocol callback function for user authentication/authorization.

### Prototype

```
typedef
EFI_STATUS
(EFI_API *EFI_BLUETOOTH_LE_REGISTER_SMP_AUTH_CALLBACK)(
IN EFI_BLUETOOTH_LE_CONFIG_PROTOCOL *This,
IN EFI_BLUETOOTH_LE_SMP_CALLBACK Callback,
IN VOID *Context
);
```

### Parameters

<i>This</i>	Pointer to the <b>EFI_BLUETOOTH_LE_CONFIG_PROTOCOL</b> instance.
<i>Callback</i>	Callback function for user authentication/authorization.
<i>Context</i>	Data passed into callback function. This is optional parameter and may be NULL.

### Description

The **RegisterSmpAuthCallback()** function register Security Manager Protocol callback function for user authentication/authorization.

## Related Definitions

```
typedef
EFI_STATUS
(EFI_API *EFI_BLUETOOTH_LE_SMP_CALLBACK) (
  IN EFI_BLUETOOTH_LE_CONFIG_PROTOCOL *This,
  IN VOID *Context,
  IN BLUETOOTH_LE_ADDRESS *BdAddr,
  IN EFI_BLUETOOTH_LE_SMP_EVENT_DATA_TYPE EventDataType,
  IN UINTN DataSize,
  IN VOID *Data
);
```

<i>This</i>	Pointer to the <b>EFI_BLUETOOTH_LE_CONFIG_PROTOCOL</b> instance.
<i>Context</i>	Data passed into callback function. This is optional parameter and may be NULL.
<i>BdAddr</i>	Remote BluetoothLE device address.
<i>EventDataType</i>	Event data type in <b>EFI_BLUETOOTH_LE_SMP_EVENT_DATA_TYPE</b> .
<i>DataSize</i>	Indicates the size, in bytes, of the data buffer specified by <i>Data</i> .
<i>Data</i>	A pointer to the buffer of data.

```
typedef enum {
  EfiBluetoothSmpAuthorizationRequestEvent,
  EfiBluetoothSmpPasskeyReadyEvent,
  EfiBluetoothSmpPasskeyRequestEvent,
  EfiBluetoothSmpOOBDataRequestEvent,
  EfiBluetoothSmpNumericComparisonEvent,
} EFI_BLUETOOTH_LE_SMP_EVENT_DATA_TYPE;
```

### *EfiBluetoothSmpAuthorizationRequestEvent*

It indicates an authorization request. No data is associated with the callback input. In the output data, the application should return the authorization value. The data structure is **BOOLEAN**. **TRUE** means YES. **FALSE** means NO.

### *EfiBluetoothSmpPasskeyReadyEvent*

It indicates that a passkey has been generated locally by the driver, and the same passkey should be entered at the remote device. The callback input data is the passkey of type **UINT32**, to be displayed by the application. No output data should be returned.

### *EfiBluetoothSmpPasskeyRequestEvent*

It indicates that the driver is requesting for the passkey has been generated at the remote device. No data is associated with the callback input. The output data is the passkey of type **UINT32**, to be entered by the user.

*EfiBluetoothSmpOOBDataRequestEvent*

It indicates that the driver is requesting for the passkey that has been pre-shared out-of-band with the remote device. No data is associated with the callback input. The output data is the stored OOB data of type **UINT8 [ 16 ]**.

*EfiBluetoothSmpNumericComparisonEvent*

It indicates that a number have been generated locally by the bus driver, and also at the remote device, and the bus driver wants to know if the two numbers match. The callback input data is the number of type **UINT32**. The output data is confirmation value of type **BOOLEAN**. **TRUE** means comparison pass. **FALSE** means comparison fail.

## Status Codes Returned

EFI_SUCCESS	The SMP callback function is registered successfully.
EFI_ALREADY_STARTED	A callback function is already registered on the same attribute opcode and attribute handle, when the Callback is not NULL.
EFI_NOT_STARTED	A callback function is not registered on the same attribute opcode and attribute handle, when the Callback is NULL.

## BLUETOOTH\_LE\_CONFIG\_PROTOCOL.SendSmpAuthData

### Summary

Send user authentication/authorization to remote device.

### Prototype

```
typedef
EFI_STATUS
(EFIAPI *EFI_BLUETOOTH_LE_SEND_SMP_AUTH_DATA)(
  IN EFI_BLUETOOTH_LE_CONFIG_PROTOCOL *This,
  IN BLUETOOTH_LE_ADDRESS *BdAddr,
  IN EFI_BLUETOOTH_LE_SMP_EVENT_DATA_TYPE EventDataType,
  IN UINTN DataSize,
  IN VOID *Data
);
```

### Parameters

<i>This</i>	Pointer to the <b>EFI_BLUETOOTH_LE_CONFIG_PROTOCOL</b> instance.
<i>BdAddr</i>	Remote BluetoothLE device address.
<i>EventDataType</i>	Event data type in <b>EFI_BLUETOOTH_LE_SMP_EVENT_DATA_TYPE</b> .
<i>DataSize</i>	The size of <i>Data</i> in bytes, of the data buffer specified by <i>Data</i> .
<i>Data</i>	A pointer to the buffer of data that will be sent. The data format depends on the type of SMP event data being responded to. See <b>EFI_BLUETOOTH_LE_SMP_EVENT_DATA_TYPE</b> .

### Description

The **SendSmpAuthData()** function sends user authentication/authorization to remote device. It should be used to send these information after the caller gets the request data from the callback function by **RegisterSmpAuthCallback()**.

## Status Codes Returned

EFI_SUCCESS	The SMP authorization data is sent successfully.
EFI_NOT_READY	SMP is not in the correct state to receive the auth data

## BLUETOOTH\_LE\_CONFIG\_PROTOCOL.RegisterSmpGetDataCallback

### Summary

Register a callback function to get SMP related data.

### Prototype

```
typedef
EFI_STATUS
(EFIAPI * EFI_BLUETOOTH_LE_CONFIG_REGISTER_SMP_GET_DATA_CALLBACK
)(
  IN EFI_BLUETOOTH_LE_CONFIG_PROTOCOL    *This,
  IN EFI_BLUETOOTH_LE_CONFIG_SMP_GET_DATA_CALLBACK Callback,
  IN VOID                                *Context
);
```

### Parameters

<i>This</i>	Pointer to the <b>EFI_BLUETOOTH_LE_CONFIG_PROTOCOL</b> instance.
<i>Callback</i>	Callback function for SMP get data.
<i>Context</i>	Data passed into callback function. This is optional parameter and may be NULL.

### Description

The **RegisterSmpGetDataCallback()** function registers a callback function to get SMP related data.

### Related Definitions

```
typedef
EFI_STATUS
(EFIAPI * EFI_BLUETOOTH_LE_CONFIG_SMP_GET_DATA_CALLBACK) (
  IN EFI_BLUETOOTH_LE_CONFIG_PROTOCOL    *This,
```



```

IN VOID
IN BLUETOOTH_LE_ADDRESS
IN EFI_BLUETOOTH_LE_SMP_DATA_TYPE
IN OUT UINTN
OUT VOID
);

```

<i>This</i>	Pointer to the <b>EFI_BLUETOOTH_LE_CONFIG_PROTOCOL</b> instance.
<i>Context</i>	Data passed into callback function. This is optional parameter and may be NULL.
<i>BDAddr</i>	Remote BluetoothLE device address. For Local device setting, it should be NULL.
<i>DataType</i>	Data type in <b>EFI_BLUETOOTH_LE_SMP_DATA_TYPE</b> .
<i>DataSize</i>	On input, indicates the size, in bytes, of the data buffer specified by <i>Data</i> . On output, indicates the amount of data actually returned.
<i>Data</i>	A pointer to the buffer of data that will be returned.

```

typedef enum {
    // For local device only
    EfiBluetoothSmpLocalIR, /* If Key hierarchy is supported */
    EfiBluetoothSmpLocalER, /* If Key hierarchy is supported */
    EfiBluetoothSmpLocalDHK, /* If Key hierarchy is supported. OPTIONAL */

    // For peer specific
    EfiBluetoothSmpKeysDistributed = 0x1000,
    EfiBluetoothSmpKeySize,
    EfiBluetoothSmpKeyType,
    EfiBluetoothSmpPeerLTK,
    EfiBluetoothSmpPeerIRK,
    EfiBluetoothSmpPeerCSRK,
    EfiBluetoothSmpPeerRand,
    EfiBluetoothSmpPeerEDIV,
    EfiBluetoothSmpPeerSignCounter,
    EfiBluetoothSmpLocalLTK, /* If Key hierarchy not supported */
    EfiBluetoothSmpLocalIRK, /* If Key hierarchy not supported */
    EfiBluetoothSmpLocalCSRK, /* If Key hierarchy not supported */
    EfiBluetoothSmpLocalSignCounter,
    EfiBluetoothSmpLocalDIV,

} EFI_BLUETOOTH_LE_SMP_DATA_TYPE;

```

#### *EfiBluetoothSmpLocalIR*

It is a 128-bit Identity Root (IR) key to generate IRK. Data structure is **UINT8 [ 16 ]**. See Bluetooth specification. This is only required when Bluetooth key hierarchy is supported. This type is for the local device only.

#### *EfiBluetoothSmpLocalER*

It is a 128-bit Encryption Root (ER) key to generate LTK and CSRK. Data structure is **UINT8 [ 16 ]**. See Bluetooth specification. This is only required when Bluetooth key hierarchy is supported. This type is for the local device only.

#### *EfiBluetoothSmpLocalDHK*

It is a 128-bit Diversifier Hiding Key (DHK) to generate EDIV. Data structure is **UINT8 [ 16 ]**. See Bluetooth specification. This is only required when Bluetooth key hierarchy is supported. This type is for the local device only.

#### *EfiBluetoothSmpKeysDistributed*

It is LE Key Distribution Format. Data structure is **UINT8**. See Bluetooth specification. This is the peer device specific information.

*EfiBluetoothSmpKeySize*

It indicates the size of keys in bytes. It is the negotiated key size between local device and peer device. Data structure is **UINTN**. This is the peer device specific information.

*EfiBluetoothSmpKeyType*

Indicates support for MITM/Secure connection. It is the negotiated Authentication Requirements between local device and peer device. See Bluetooth Spec 3.H.3.5.1. Data structure is **UINT8**. BIT0: MITM, BIT1: SC. This is the peer device specific information.

*EfiBluetoothSmpPeerLTK*

It is a 128-bit Long-Term Key (LTK) to generate the contributory session key for an encrypted connection. Data structure is **UINT8 [ 16 ]**. See Bluetooth specification. This is the peer device specific information.

*EfiBluetoothSmpPeerIRK*

It is a 128-bit Identity Resolving Key (IRK) to generate and resolve random addresses. Data structure is **UINT8 [ 16 ]**. See Bluetooth specification. This is the peer device specific information.

*EfiBluetoothSmpPeerCSRK*

It is a 128-bit Connection-Signature Resolving Key (CSRK) to sign data and verify signatures on the receiving device. Data structure is **UINT8 [ 16 ]**. See Bluetooth specification. This is the peer device specific information.

*EfiBluetoothSmpPeerRand*

It is a 64-bit Random number (Rand) to identify the LTK distributed during LE legacy pairing. Data structure is **UINT64**. See Bluetooth specification. This is the peer device specific information.

*EfiBluetoothSmpPeerEDIV*

It is a 16-bit Encrypted Diversifier (EDIV) to identify the LTK distributed during LE legacy pairing. Data structure is **UINT16**. See Bluetooth specification. This is the peer device specific information.

*EfiBluetoothSmpPeerSignCounter*

It is a 32-bit Sign Counter to assist MAC generation. Data structure is **UINT32**. See Bluetooth specification. This is the peer device specific information.

*EfiBluetoothSmpLocalLTK*

It is a 128-bit Long-Term Key (LTK) to generate the contributory session key for an encrypted connection. Data structure is **UINT8 [ 16 ]**. See Bluetooth specification. This is only required when Bluetooth key hierarchy is not supported. This is the peer specific local device information.

*EfiBluetoothSmpLocalIRK*

It is a 128-bit Identity Resolving Key (IRK) to generate and resolve random addresses. Data structure is **UINT8[16]**. See Bluetooth specification. This is only required when Bluetooth key hierarchy is not supported. This is the peer specific local device information.

*EfiBluetoothSmpLocalCSRK*

It is a 128-bit Connection-Signature Resolving Key (CSRK) to sign data and verify signatures on the receiving device. Data structure is **UINT8[16]**. See Bluetooth specification. This is only required when Bluetooth key hierarchy is not supported. This is the peer specific local device information.

*EfiBluetoothSmpLocalSignCounter*

It is a 32-bit Sign Counter to assist MAC generation. Data structure is **UINT32**. See Bluetooth specification. This is the peer specific local device information.

*EfiBluetoothSmpLocalDIV*

It is a 16-bit Diversifier (DIV) to be used as index to recover LTK. Data structure is **UINT16**. See Bluetooth specification. This is the peer specific local device information.

**Status Codes Returned**

EFI_SUCCESS	The SMP get data callback function is registered successfully.
EFI_ALREADY_STARTED	A callback function is already registered on the same attribute opcode and attribute handle, when the Callback is not NULL.
EFI_NOT_STARTED	A callback function is not registered on the same attribute opcode and attribute handle, when the Callback is NULL.

## BLUETOOTH\_LE\_CONFIG\_PROTOCOL.RegisterSmpSetDataCallback

### Summary

Register a callback function to set SMP related data.

### Prototype

```
typedef
EFI_STATUS
(EFIAPI * EFI_BLUETOOTH_LE_CONFIG_REGISTER_SMP_SET_DATA_CALLBACK
)(
  IN EFI_BLUETOOTH_LE_CONFIG_PROTOCOL *This,
  IN EFI_BLUETOOTH_LE_CONFIG_SMP_SET_DATA_CALLBACK Callback,
  IN VOID *Context
);
```

### Parameters

<i>This</i>	Pointer to the <b>EFI_BLUETOOTH_LE_CONFIG_PROTOCOL</b> instance.
<i>Callback</i>	Callback function for SMP set data.
<i>Context</i>	Data passed into callback function. This is optional parameter and may be NULL.

### Description

The **RegisterSmpSetDataCallback()** function registers a callback function to set SMP related data.

### Related Definitions

```
typedef
EFI_STATUS
(EFIAPI * EFI_BLUETOOTH_LE_CONFIG_SMP_SET_DATA_CALLBACK) (
  IN EFI_BLUETOOTH_LE_CONFIG_PROTOCOL *This,
  IN VOID *Context,
  IN BLUETOOTH_LE_ADDRESS *BdAddr,
  IN EFI_BLUETOOTH_LE_SMP_DATA_TYPE Type,
  IN UINTN DataSize,
  IN VOID *Data
);
```

<i>This</i>	Pointer to the <b>EFI_BLUETOOTH_LE_CONFIG_PROTOCOL</b> instance.
-------------	--

<i>Context</i>	Data passed into callback function. This is optional parameter and may be NULL.
<i>BDAddr</i>	Remote BluetoothLE device address.
<i>DataType</i>	Data type in <b>EFI_BLUETOOTH_LE_SMP_DATA_TYPE</b> .
<i>DataSize</i>	Indicates the size, in bytes, of the data buffer specified by <i>Data</i> .
<i>Data</i>	A pointer to the buffer of data.

### Status Codes Returned

EFI_SUCCESS	The SMP get data callback function is registered successfully.
EFI_ALREADY_STARTED	A callback function is already registered on the same attribute opcode and attribute handle, when the Callback is not NULL.
EFI_NOT_STARTED	A callback function is not registered on the same attribute opcode and attribute handle, when the Callback is NULL.

## BLUETOOTH\_LE\_CONFIG\_PROTOCOL.RegisterLinkConnectCompleteCallback

### Summary

Register link connect complete callback function.

## Prototype

```
typedef
EFI_STATUS
(EFIAPI
*EFI_BLUETOOTH_LE_CONFIG_REGISTER_CONNECT_COMPLETE_CALLBACK) (
  IN EFI_BLUETOOTH_LE_CONFIG_PROTOCOL      *This,
  IN EFI_BLUETOOTH_CONFIG_CONNECT_COMPLETE_CALLBACK_FUNCTION
  Callback,
  IN VOID                                  *Context
);
```

## Parameters

<i>This</i>	Pointer to the <b>EFI_BLUETOOTH_LE_CONFIG_PROTOCOL</b> instance.
<i>Callback</i>	The callback function. <b>NULL</b> means unregister.
<i>Context</i>	Data passed into <i>Callback</i> function. This is optional parameter and may be <b>NULL</b> .

## Description

The **RegisterLinkConnectCompleteCallback()** function registers Bluetooth link connect complete callback function. The Bluetooth Configuration driver may call **RegisterLinkConnectCompleteCallback()** to register a callback function. During pairing, Bluetooth bus driver must trigger this callback function to report device state, if it is registered. Then Bluetooth Configuration driver will get information on device connection, according to *CallbackType* defined by **EFI\_BLUETOOTH\_CONNECT\_COMPLETE\_CALLBACK\_TYPE**.

## Status Codes Returned

EFI_SUCCESS	The link connect complete callback function is registered successfully.
EFI_ALREADY_STARTED	A callback function is already registered on the same attribute opcode and attribute handle, when the Callback is not NULL.
EFI_NOT_STARTED	A callback function is not registered on the same attribute opcode and attribute handle, when the Callback is NULL.





## 28 Network Protocols —TCP, IP, IPsec, FTP, TLS and Configurations

---

### 28.1 EFI TCPv4 Protocol

This section defines the EFI TCPv4 (Transmission Control Protocol version 4) Protocol.

#### 28.1.1 TCP4 Service Binding Protocol

##### EFI\_TCP4\_SERVICE\_BINDING\_PROTOCOL

###### Summary

The EFI TCPv4 Service Binding Protocol is used to locate EFI TCPv4 Protocol drivers to create and destroy child of the driver to communicate with other host using TCP protocol.

###### GUID

```
#define EFI_TCP4_SERVICE_BINDING_PROTOCOL_GUID \
  {0x00720665,0x67EB,0x4a99,\
   {0xBA,0xF7,0xD3,0xC3,0x3A,0x1C,0x7C,0xC9}}
```

###### Description

A network application that requires TCPv4 I/O services can call one of the protocol handler services, such as **BS->LocateHandleBuffer()**, to search devices that publish an EFI TCPv4 Service Binding Protocol GUID. Such device supports the EFI TCPv4 Protocol and may be available for use.

After a successful call to the **EFI\_TCP4\_SERVICE\_BINDING\_PROTOCOL.CreateChild()** function, the newly created child EFI TCPv4 Protocol driver is in an un-configured state; it is not ready to do any operation except **Poll()** send and receive data packets until configured as the purpose of the user and perhaps some other indispensable function belonged to TCPv4 Protocol driver is called properly.

Every successful call to the **EFI\_TCP4\_SERVICE\_BINDING\_PROTOCOL.CreateChild()** function must be matched with a call to the **EFI\_TCP4\_SERVICE\_BINDING\_PROTOCOL.DestroyChild()** function to release the protocol driver.

#### 28.1.2 TCP4 Protocol

##### EFI\_TCP4\_PROTOCOL

###### Summary

The EFI TCPv4 Protocol provides services to send and receive data stream.

## GUID

```
#define EFI_TCP4_PROTOCOL_GUID \
{0x65530BC7,0xA359,0x410f,\
{0xB0,0x10,0x5A,0xAD,0xC7,0xEC,0x2B,0x62}}
```

## Protocol Interface Structure

```
typedef struct _EFI_TCP4_PROTOCOL {
  EFI_TCP4_GET_MODE_DATA  GetModeData;
  EFI_TCP4_CONFIGURE      Configure;
  EFI_TCP4_ROUTES         Routes;
  EFI_TCP4_CONNECT        Connect;
  EFI_TCP4_ACCEPT         Accept;
  EFI_TCP4_TRANSMIT       Transmit;
  EFI_TCP4_RECEIVE        Receive;
  EFI_TCP4_CLOSE          Close;
  EFI_TCP4_CANCEL         Cancel;
  EFI_TCP4_POLL           Poll;
} EFI_TCP4_PROTOCOL;
```

## Parameters

<i>GetModeData</i>	Get the current operational status. See the <b>GetModeData()</b> function description.
<i>Configure</i>	Initialize, change, or brutally reset operational settings of the EFI TCPv4 Protocol. See the <b>Configure()</b> function description.
<i>Routes</i>	Add or delete routing entries for this TCP4 instance. See the <b>Routes()</b> function description.
<i>Connect</i>	Initiate the TCP three-way handshake to connect to the remote peer configured in this TCP instance. The function is a nonblocking operation. See the <b>Connect()</b> function description.
<i>Accept</i>	Listen for incoming TCP connection request. This function is a nonblocking operation. See the <b>Accept()</b> function description.
<i>Transmit</i>	Queue outgoing data to the transmit queue. This function is a nonblocking operation. See the <b>Transmit()</b> function description.
<i>Receive</i>	Queue a receiving request token to the receive queue. This function is a nonblocking operation. See the <b>Receive()</b> function description.
<i>Close</i>	Gracefully disconnecting a TCP connection follow RFC 793 or reset a TCP connection. This function is a nonblocking operation. See the <b>Close()</b> function description.
<i>Cancel</i>	Abort a pending connect, listen, transmit or receive request. See the <b>Cancel()</b> function description.

### *Poll*

Poll to receive incoming data and transmit outgoing TCP segments. See the **Poll()** function description.

## Description

The **EFI\_TCP4\_PROTOCOL** defines the EFI TCPv4 Protocol child to be used by any network drivers or applications to send or receive data stream. It can either listen on a specified port as a service or actively connected to remote peer as a client. Each instance has its own independent settings, such as the routing table.

**Note:** *In this document, all IPv4 addresses and incoming/outgoing packets are stored in network byte order. All other parameters in the functions and data structures that are defined in this document are stored in host byte order unless explicitly specified.*

## EFI\_TCP4\_PROTOCOL.GetModeData()

### Summary

Get the current operational status.

### Prototype

```
typedef
EFI_STATUS
(EFI_API *EFI_TCP4_GET_MODE_DATA) (
    IN EFI_TCP4_PROTOCOL      *This,
    OUT EFI_TCP4_CONNECTION_STATE *Tcp4State OPTIONAL,
    OUT EFI_TCP4_CONFIG_DATA   *Tcp4ConfigData OPTIONAL,
    OUT EFI_IPv4_MODE_DATA     *Ip4ModeData OPTIONAL,
    OUT EFI_MANAGED_NETWORK_CONFIG_DATA *MnpConfigData OPTIONAL,
    OUT EFI_SIMPLE_NETWORK_MODE *SnpModeData OPTIONAL
);
```

### Parameters

<i>This</i>	Pointer to the <b>EFI_TCP4_PROTOCOL</b> instance.
<i>Tcp4State</i>	Pointer to the buffer to receive the current TCP state. Type <b>EFI_TCP4_CONNECTION_STATE</b> is defined in “Related Definitions” below.
<i>Tcp4ConfigData</i>	Pointer to the buffer to receive the current TCP configuration. Type <b>EFI_TCP4_CONFIG_DATA</b> is defined in “Related Definitions” below.
<i>Ip4ModeData</i>	Pointer to the buffer to receive the current IPv4 configuration data used by the TCPv4 instance. Type <b>EFI_IP4_MODE_DATA</b> is defined in <b>EFI_IP4_PROTOCOL.GetModeData()</b> .
<i>MnpConfigData</i>	Pointer to the buffer to receive the current MNP configuration data used indirectly by the TCPv4 instance. Type <b>EFI_MANAGED_NETWORK_CONFIG_DATA</b> is defined in <b>EFI_MANAGED_NETWORK_PROTOCOL.GetModeData()</b> .
<i>SnpModeData</i>	Pointer to the buffer to receive the current SNP configuration data used indirectly by the TCPv4 instance. Type <b>EFI_SIMPLE_NETWORK_MODE</b> is defined in the <b>EFI_SIMPLE_NETWORK_PROTOCOL</b> .

### Description

The **GetModeData()** function copies the current operational settings of this EFI TCPv4 Protocol instance into user-supplied buffers. This function can also be used to retrieve the operational setting of underlying drivers such as IPv4, MNP, or SNP.

## Related Definition

```
typedef struct {
    BOOLEAN UseDefaultAddress;
    EFI_IPv4_ADDRESS StationAddress;
    EFI_IPv4_ADDRESS SubnetMask;
    UINT16 StationPort;
    EFI_IPv4_ADDRESS RemoteAddress;
    UINT16 RemotePort;
    BOOLEAN ActiveFlag;
} EFI_TCP4_ACCESS_POINT;
```

<i>UseDefaultAddress</i>	Set to <b>TRUE</b> to use the default IP address and default routing table. If the default IP address is not available yet, then the underlying EFI IPv4 Protocol driver will use <b>EFI_IP4_CONFIG2_PROTOCOL</b> to retrieve the IP address and subnet information.
<i>StationAddress</i>	The local IP address assigned to this EFI TCPv4 Protocol instance. The EFI TCPv4 and EFI IPv4 Protocol drivers will only deliver incoming packets whose destination addresses exactly match the IP address. Not used when <i>UseDefaultAddress</i> is <b>TRUE</b> .
<i>SubnetMask</i>	The subnet mask associated with the station address. Not used when <i>UseDefaultAddress</i> is <b>TRUE</b> .
<i>StationPort</i>	The local port number to which this EFI TCPv4 Protocol instance is bound. If the instance doesn't care the local port number, set <i>StationPort</i> to zero to use an ephemeral port.
<i>RemoteAddress</i>	The remote IP address to which this EFI TCPv4 Protocol instance is connected. If <i>ActiveFlag</i> is <b>FALSE</b> (i.e., a passive TCPv4 instance), the instance only accepts connections from the <i>RemoteAddress</i> . If <i>ActiveFlag</i> is <b>TRUE</b> the instance is connected to the <i>RemoteAddress</i> , i.e., outgoing segments will be sent to this address and only segments from this address will be delivered to the application. When <i>ActiveFlag</i> is <b>FALSE</b> it can be set to zero and means that incoming connection request from any address will be accepted.
<i>RemotePort</i>	The remote port to which this EFI TCPv4 Protocol instance is connects or connection request from which is accepted by this EFI TCPv4 Protocol instance. If <i>ActiveFlag</i> is <b>FALSE</b> it can be zero and means that incoming connection request from any port will be accepted. Its value can not be zero when <i>ActiveFlag</i> is <b>TRUE</b> .
<i>ActiveFlag</i>	Set it to <b>TRUE</b> to initiate an active open. Set it to <b>FALSE</b> to initiate a passive open to act as a server.

```

typedef struct {
    UINT32          ReceiveBufferSize;
    UINT32          SendBufferSize;
    UINT32          MaxSynBackLog;
    UINT32          ConnectionTimeout;
    UINT32          DataRetries;
    UINT32          FinTimeout;
    UINT32          TimeWaitTimeout;
    UINT32          KeepAliveProbes;
    UINT32          KeepAliveTime;
    UINT32          KeepAliveInterval;
    BOOLEAN         EnableNagle;
    BOOLEAN         EnableTimeStamp;
    BOOLEAN         EnableWindowScaling;
    BOOLEAN         EnableSelectiveAck;
    BOOLEAN         EnablePathMtuDiscovery;
} EFI_TCP4_OPTION;

```

<i>ReceiveBufferSize</i>	The size of the TCP receive buffer.
<i>SendBufferSize</i>	The size of the TCP send buffer.
<i>MaxSynBackLog</i>	The length of incoming connect request queue for a passive instance. When set to zero, the value is implementation specific.
<i>ConnectionTimeout</i>	The maximum seconds a TCP instance will wait for before a TCP connection established. When set to zero, the value is implementation specific.
<i>DataRetries</i>	The number of times TCP will attempt to retransmit a packet on an established connection. When set to zero, the value is implementation specific.
<i>FinTimeout</i>	How many seconds to wait in the FIN_WAIT_2 states for a final FIN flag before the TCP instance is closed. This timeout is in effective only if the application has called <b>Close()</b> to disconnect the connection completely. It is also called FIN_WAIT_2 timer in other implementations. When set to zero, it should be disabled because the FIN_WAIT_2 timer itself is against the standard.
<i>TimeWaitTimeout</i>	How many seconds to wait in TIME_WAIT state before the TCP instance is closed. The timer is disabled completely to provide a method to close the TCP connection quickly if it is set to zero. It is against the related RFC documents.
<i>KeepAliveProbes</i>	The maximum number of TCP keep-alive probes to send before giving up and resetting the connection if no response from the other end. Set to zero to disable keep-alive probe.

<i>KeepAliveTime</i>	The number of seconds a connection needs to be idle before TCP sends out periodical keep-alive probes. When set to zero, the value is implementation specific. It should be ignored if keep-alive probe is disabled.
<i>KeepAliveInterval</i>	The number of seconds between TCP keep-alive probes after the periodical keep-alive probe if no response. When set to zero, the value is implementation specific. It should be ignored if keep-alive probe is disabled.
<i>EnableNagle</i>	Set it to <b>TRUE</b> to enable the Nagle algorithm as defined in RFC896. Set it to <b>FALSE</b> to disable it.
<i>EnableTimeStamp</i>	Set it to <b>TRUE</b> to enable TCP timestamps option as defined in RFC1323. Set to <b>FALSE</b> to disable it.
<i>EnableWindowScaling</i>	Set it to <b>TRUE</b> to enable TCP window scale option as defined in RFC1323. Set it to <b>FALSE</b> to disable it.
<i>EnableSelectiveAck</i>	Set it to <b>TRUE</b> to enable selective acknowledge mechanism described in RFC 2018. Set it to <b>FALSE</b> to disable it. Implementation that supports SACK can optionally support DSAK as defined in RFC 2883.
<i>EnablePathMtuDiscovery</i>	Set it to <b>TRUE</b> to enable path MTU discovery as defined in RFC 1191. Set to <b>FALSE</b> to disable it.

Option setting with digital value will be modified by driver if it is set out of the implementation specific range and an implementation specific default value will be set accordingly.

```

//*****
// EFI_TCP4_CONFIG_DATA
//*****
typedef struct {
// Receiving Filters
// I/O parameters
UINT8    TypeOfService;
UINT8    TimeToLive;

// Access Point
EFI_TCP4_ACCESS_POINT AccessPoint;

// TCP Control Options
EFI_TCP4_OPTION *ControlOption;
} EFI_TCP4_CONFIG_DATA;

```

<i>TypeOfService</i>	<i>TypeOfService</i> field in transmitted IPv4 packets.
<i>TimeToLive</i>	<i>TimeToLive</i> field in transmitted IPv4 packets.

*AccessPoint* Used to specify TCP communication end settings for a TCP instance.

*ControlOption* Used to configure the advance TCP option for a connection. If set to **NULL**, implementation specific options for TCP connection will be used.

```

//*****
// EFI_TCP4_CONNECTION_STATE
//*****

typedef enum {
    Tcp4StateClosed    = 0,
    Tcp4StateListen    = 1,
    Tcp4StateSynSent   = 2,
    Tcp4StateSynReceived = 3,
    Tcp4StateEstablished = 4,
    Tcp4StateFinWait1  = 5,
    Tcp4StateFinWait2  = 6,
    Tcp4StateClosing   = 7,
    Tcp4StateTimeWait  = 8,
    Tcp4StateCloseWait = 9,
    Tcp4StateLastAck   = 10
} EFI_TCP4_CONNECTION_STATE;
    
```

**Status Codes Returned**

EFI_SUCCESS	The mode data was read.
EFI_NOT_STARTED	No configuration data is available because this instance hasn't been started.
EFI_INVALID_PARAMETER	<i>This is NULL.</i>



## EFI\_TCP4\_PROTOCOL.Configure()

### Summary

Initialize or brutally reset the operational parameters for this EFI TCPv4 instance.

### Prototype

```
typedef
EFI_STATUS
(EFI_API *EFI_TCP4_CONFIGURE) (
  IN EFI_TCP4_PROTOCOL *This,
  IN EFI_TCP4_CONFIG_DATA *TcpConfigData OPTIONAL
);
```

### Parameters

*This* Pointer to the **EFI\_TCP4\_PROTOCOL** instance.

*TcpConfigData* Pointer to the configure data to configure the instance.

### Description

The **Configure()** function does the following:

- Initialize this EFI TCPv4 instance, i.e., initialize the communication end setting, specify active open or passive open for an instance.
- Reset this TCPv4 instance brutally, i.e., cancel all pending asynchronous tokens, flush transmission and receiving buffer directly without informing the communication peer.

No other TCPv4 Protocol operation can be executed by this instance until it is configured properly. For an active TCP4 instance, after a proper configuration it may call **Connect()** to initiate the three-way handshake. For a passive TCP4 instance, its state will transit to **Tcp4StateListen** after configuration, and **Accept()** may be called to listen the incoming TCP connection request. If *TcpConfigData* is set to **NULL**, the instance is reset. Resetting process will be done brutally, the state machine will be set to **Tcp4StateClosed** directly, the receive queue and transmit queue will be flushed, and no traffic is allowed through this instance.

### Status Codes Returned

EFI_SUCCESS	The operational settings are set, changed, or reset successfully.
EFI_NO_MAPPING	When using a default address, configuration (through DHCP, BOOTP, RARP, etc.) is not finished yet.

EFI_INVALID_PARAMETER	<p>One or more following conditions are <b>TRUE</b>:</p> <ul style="list-style-type: none"> <li>• <i>This</i> is <b>NULL</b>.</li> <li>• <i>TcpConfigData</i> -&gt;<i>AccessPoint.StationAddress</i> isn't a valid unicast IPv4 address when <i>TcpConfigData</i> -&gt;<i>AccessPoint.UseDefaultAddress</i> is <b>FALSE</b>.</li> <li>• <i>TcpConfigData</i> -&gt;<i>AccessPoint.SubnetMask</i> isn't a valid IPv4 address mask when <i>TcpConfigData</i> -&gt; <i>AccessPoint.UseDefaultAddress</i> is <b>FALSE</b>. The subnet mask must be contiguous.</li> <li>• <i>TcpConfigData</i> -&gt;<i>AccessPoint.RemoteAddress</i> isn't a valid unicast IPv4 address.</li> <li>• <i>TcpConfigData</i> -&gt;<i>AccessPoint.RemoteAddress</i> is zero or <i>TcpConfigData</i> -&gt;<i>AccessPoint.RemotePort</i> is zero when <i>TcpConfigData</i> -&gt;<i>AccessPoint.ActiveFlag</i> is <b>TRUE</b>.</li> <li>• A same access point has been configured in other TCP instance properly.</li> </ul>
EFI_ACCESS_DENIED	Configuring TCP instance when it is configured without calling <b>Configure()</b> with <b>NULL</b> to reset it.
EFI_DEVICE_ERROR	An unexpected network or system error occurred.
EFI_UNSUPPORTED	One or more of the control options are not supported in the implementation.
EFI_OUT_OF_RESOURCES	Could not allocate enough system resources when executing <b>Configure()</b> .

## EFI\_TCP4\_PROTOCOL.Routes()

### Summary

Add or delete routing entries.

### Prototype

```
typedef
EFI_STATUS
(EFI_API *EFI_TCP4_ROUTES) (
  IN EFI_TCP4_PROTOCOL *This,
  IN BOOLEAN DeleteRoute,
  IN EFI_IPv4_ADDRESS *SubnetAddress,
  IN EFI_IPv4_ADDRESS *SubnetMask,
  IN EFI_IPv4_ADDRESS *GatewayAddress
);
```

### Parameters

<i>This</i>	Pointer to the <b>EFI_TCP4_PROTOCOL</b> instance.
<i>DeleteRoute</i>	Set it to <b>TRUE</b> to delete this route from the routing table. Set it to <b>FALSE</b> to add this route to the routing table. <i>DestinationAddress</i> and <i>SubnetMask</i> are used as the keywords to search route entry.
<i>SubnetAddress</i>	The destination network.
<i>SubnetMask</i>	The subnet mask of the destination network.
<i>GatewayAddress</i>	The gateway address for this route. It must be on the same subnet with the station address unless a direct route is specified.

### Description

The **Routes()** function adds or deletes a route from the instance's routing table.

The most specific route is selected by comparing the *SubnetAddress* with the destination IP address's arithmetical **AND** to the *SubnetMask*.

The default route is added with both *SubnetAddress* and *SubnetMask* set to 0.0.0.0. The default route matches all destination IP addresses if there is no more specific route.

Direct route is added with *GatewayAddress* set to 0.0.0.0. Packets are sent to the destination host if its address can be found in the Address Resolution Protocol (ARP) cache or it is on the local subnet. If the instance is configured to use default address, a direct route to the local network will be added automatically.

Each TCP instance has its own independent routing table. Instance that uses the default IP address will have a copy of the **EFI\_IP4\_CONFIG2\_PROTOCOL**'s routing table. The copy will be updated automatically whenever the IP driver reconfigures its instance. As a result, the previous modification to the instance's local copy will be lost.

The priority of checking the route table is specific with IP implementation and every IP implementation must comply with RFC 1122.

**Note:** *There is no way to set up routes to other network interface cards (NICs) because each NIC has its own independent network stack that shares information only through **EFI TCP4 variable**.*

## Status Codes Returned

EFI_SUCCESS	The operation completed successfully.
EFI_NOT_STARTED	The EFI TCPv4 Protocol instance has not been configured.
EFI_NO_MAPPING	When using a default address, configuration (DHCP, BOOTP, RARP, etc.) is not finished yet.
EFI_INVALID_PARAMETER	One or more of the following conditions is <b>TRUE</b> : <ul style="list-style-type: none"> <li>• <i>This</i> is <b>NULL</b>.</li> <li>• <i>SubnetAddress</i> is <b>NULL</b>.</li> <li>• <i>SubnetMask</i> is <b>NULL</b>.</li> <li>• <i>GatewayAddress</i> is <b>NULL</b>.</li> <li>• <i>*SubnetAddress</i> is not <b>NULL</b> a valid subnet address.</li> <li>• <i>*SubnetMask</i> is not a valid subnet mask.</li> <li>• <i>*GatewayAddress</i> is not a valid unicast IP address or it is not in the same subnet.</li> </ul>
EFI_OUT_OF_RESOURCES	Could not allocate enough resources to add the entry to the routing table.
EFI_NOT_FOUND	This route is not in the routing table.
EFI_ACCESS_DENIED	The route is already defined in the routing table.
EFI_UNSUPPORTED	The TCP driver does not support this operation.

## EFI\_TCP4\_PROTOCOL.Connect()

### Summary

Initiate a nonblocking TCP connection request for an active TCP instance.

### Prototype

```
typedef
EFI_STATUS
(EFI_API *EFI_TCP4_CONNECT) (
    IN EFI_TCP4_PROTOCOL *This,
    IN EFI_TCP4_CONNECTION_TOKEN *ConnectionToken,
);
```

### Parameters

<i>This</i>	Pointer to the <b>EFI_TCP4_PROTOCOL</b> instance.
<i>ConnectionToken</i>	Pointer to the connection token to return when the TCP three way handshake finishes. Type <b>EFI_TCP4_CONNECTION_TOKEN</b> is defined in “Related Definition” below.

### Description

The **Connect()** function will initiate an active open to the remote peer configured in current TCP instance if it is configured active. If the connection succeeds or fails due to any error, the *ConnectionToken->CompletionToken.Event* will be signaled and *ConnectionToken->CompletionToken.Status* will be updated accordingly. This function can only be called for the TCP instance in **Tcp4StateClosed** state. The instance will transfer into **Tcp4StateSynSent** if the function returns **EFI\_SUCCESS**. If TCP three way handshake succeeds, its state will become **Tcp4StateEstablished**, otherwise, the state will return to **Tcp4StateClosed**.

### Related Definitions

```
//*****
// EFI_TCP4_COMPLETION_TOKEN
//*****
typedef struct {
    EFI_EVENT      Event;
    EFI_STATUS     Status;
} EFI_TCP4_COMPLETION_TOKEN;
```

<i>Event</i>	The <i>Event</i> to signal after request is finished and <i>Status</i> field is updated by the EFI TCPv4 Protocol driver. The type of <i>Event</i> must be <b>EVT_NOTIFY_SIGNAL</b> , and its Task Priority Level (TPL) must be lower than or equal to <b>TPL_CALLBACK</b> .
--------------	--

<i>Status</i>	The variable to receive the result of the completed operation. <b>EFI_NO_MEDIA</b> . There was a media error
---------------	--

The **EFI\_TCP4\_COMPLETION\_TOKEN** is used as a common header for various asynchronous tokens.

```

//*****
// EFI_TCP4_CONNECTION_TOKEN
//*****
typedef struct {
  EFI_TCP4_COMPLETION_TOKEN CompletionToken;
} EFI_TCP4_CONNECTION_TOKEN;

```

### *Status*

The *Status* in the *CompletionToken* will be set to one of the following values if the active open succeeds or an unexpected error happens:

**EFI\_SUCCESS.** The active open succeeds and the instance is in **Tcp4StateEstablished**.

**EFI\_CONNECTION\_RESET.** The connect fails because the connection is reset either by instance itself or communication peer.

**EFI\_CONNECTION\_REFUSED:** The connect fails because this connection is initiated with an active open and the connection is refused.

**EFI\_ABORTED.** The active open was aborted.

**EFI\_TIMEOUT.** The connection establishment timer expired and no more specific information is available.

**EFI\_NETWORK\_UNREACHABLE.** The active open fails because an ICMP network unreachable error is received.

**EFI\_HOST\_UNREACHABLE.** The active open fails because an ICMP host unreachable error is received.

**EFI\_PROTOCOL\_UNREACHABLE.** The active open fails because an ICMP protocol unreachable error is received.

**EFI\_PORT\_UNREACHABLE.** The connection establishment timer times out and an ICMP port unreachable error is received.

**EFI\_ICMP\_ERROR.** The connection establishment timer timeout and some other ICMP error is received.

**EFI\_DEVICE\_ERROR.** An unexpected system or network error occurred.

## Status Codes Returned

EFI_SUCCESS	The connection request is successfully initiated and the state of this TCPv4 instance has been changed to <b>Tcp4StateSynSent</b> .
-------------	---

EFI_NOT_STARTED	This EFI TCPv4 Protocol instance has not been configured.
EFI_ACCESS_DENIED	One or more of the following conditions are <b>TRUE</b> : <ul style="list-style-type: none"><li>• This instance is not configured as an active one.</li><li>• This instance is not in <i>Tcp4StateClosed</i> state.</li></ul>
EFI_INVALID_PARAMETER	One or more of the following are <b>TRUE</b> : <ul style="list-style-type: none"><li>• <i>This</i> is <b>NULL</b>.</li><li>• <i>ConnectionToken</i> is <b>NULL</b>.</li><li>• <i>ConnectionToken</i> -&gt;<i>CompletionToken.Event</i> is <b>NULL</b>.</li></ul>
EFI_OUT_OF_RESOURCES	The driver can't allocate enough resource to initiate the active open.
EFI_DEVICE_ERROR	An unexpected system or network error occurred.

## EFI\_TCP4\_PROTOCOL.Accept()

### Summary

Listen on the passive instance to accept an incoming connection request. This is a nonblocking operation.

### Prototype

```
typedef
EFI_STATUS
(EFIAPI *EFI_TCP4_ACCEPT) (
  IN EFI_TCP4_PROTOCOL  *This,
  IN EFI_TCP4_LISTEN_TOKEN *ListenToken
);
```

### Parameters

<i>This</i>	Pointer to the <b>EFI_TCP4_PROTOCOL</b> instance.
<i>ListenToken</i>	Pointer to the listen token to return when operation finishes. Type <b>EFI_TCP4_LISTEN_TOKEN</b> is defined in “Related Definition” below.

### Related Definitions

```
//*****
// EFI_TCP4_LISTEN_TOKEN
//*****
typedef struct {
  EFI_TCP4_COMPLETION_TOKEN  CompletionToken;
  EFI_HANDLE                 NewChildHandle;
} EFI_TCP4_LISTEN_TOKEN;
```

*Status* The *Status* in *CompletionToken* will be set to the following value if accept finishes:

**EFI\_SUCCESS.** A remote peer has successfully established a connection to *this* instance. A new TCP instance has also been created for the connection.

**EFI\_CONNECTION\_RESET.** The accept fails because the connection is reset either by instance itself or communication peer.

**EFI\_ABORTED.** The accept request has been aborted.

*NewChildHandle* The new TCP instance handle created for the established connection.

### Description

The **Accept()** function initiates an asynchronous accept request to wait for an incoming connection on the passive TCP instance. If a remote peer successfully establishes a connection with this instance, a new TCP instance will be created and its handle will be returned in *ListenToken->NewChildHandle*. The newly created instance is configured by



inheriting the passive instance's configuration and is ready for use upon return. The instance is in the **Tcp4StateEstablished** state.

The *ListenToken->CompletionToken.Event* will be signaled when a new connection is accepted, user aborts the listen or connection is reset.

This function only can be called when current TCP instance is in **Tcp4StateListen** state.

## Status Codes Returned

EFI_SUCCESS	The listen token has been queued successfully.
EFI_NOT_STARTED	This EFI TCPv4 Protocol instance has not been configured.
EFI_ACCESS_DENIED	One or more of the following are <b>TRUE</b> : <ul style="list-style-type: none"> <li>This instance is not a passive instance.</li> <li>This instance is not in <i>Tcp4StateListen</i> state.</li> <li>The same listen token has already existed in the listen token queue of this TCP instance.</li> </ul>
EFI_INVALID_PARAMETER	One or more of the following are <b>TRUE</b> : <ul style="list-style-type: none"> <li><i>This</i> is <b>NULL</b>.</li> <li><i>ListenToken</i> is <b>NULL</b>.</li> <li><i>ListenToken-&gt;CompletionToken.Event</i> is <b>NULL</b>.</li> </ul>
EFI_OUT_OF_RESOURCES	Could not allocate enough resource to finish the operation.
EFI_DEVICE_ERROR	Any unexpected and not belonged to above category error.

## EFI\_TCP4\_PROTOCOL.Transmit()

### Summary

Queues outgoing data into the transmit queue.

### Prototype

```
typedef
EFI_STATUS
(EFI_API *EFI_TCP4_TRANSMIT) (
    IN EFI_TCP4_PROTOCOL    *This,
    IN EFI_TCP4_IO_TOKEN    *Token
);
```

### Parameters

<i>This</i>	Pointer to the <b>EFI_TCP4_PROTOCOL</b> instance.
<i>Token</i>	Pointer to the completion token to queue to the transmit queue. Type <b>EFI_TCP4_IO_TOKEN</b> is defined in “Related Definitions” below.

### Description

The **Transmit()** function queues a sending request to this TCPv4 instance along with the user data. The status of the token is updated and the event in the token will be signaled once the data is sent out or some error occurs.

### Related Definitions

```
/**
//*****
// EFI_TCP4_IO_TOKEN
//*****
typedef struct {
    EFI_TCP4_COMPLETION_TOKEN    CompletionToken;
    union {
        EFI_TCP4_RECEIVE_DATA    *RxData;
        EFI_TCP4_TRANSMIT_DATA    *TxData;
    } Packet;
} EFI_TCP4_IO_TOKEN;
```

<i>Status</i>	When transmission finishes or meets any unexpected error it will be set to one of the following values: <b>EFI_SUCCESS</b> : The receiving or transmission operation completes successfully. <b>EFI_CONNECTION_FIN</b> : The receiving operation fails because the communication peer has closed the connection and there is no more data in the receive buffer of the instance.
---------------	--

**EFI\_CONNECTION\_RESET.** The receiving or transmission operation fails because this connection is reset either by instance itself or communication peer.

**EFI\_ABORTED.** The receiving or transmission is aborted.

**EFI\_TIMEOUT.** The transmission timer expires and no more specific information is available.

**EFI\_NETWORK\_UNREACHABLE.** The transmission fails because an ICMP network unreachable error is received.

**EFI\_HOST\_UNREACHABLE.** The transmission fails because an ICMP host unreachable error is received.

**EFI\_PROTOCOL\_UNREACHABLE.** The transmission fails because an ICMP protocol unreachable error is received.

**EFI\_PORT\_UNREACHABLE.** The transmission fails and an ICMP port unreachable error is received.

**EFI\_ICMP\_ERROR.** The transmission fails and some other ICMP error is received.

**EFI\_DEVICE\_ERROR.** An unexpected system or network error occurs.

**EFI\_NO\_MEDIA.** There was a media error

*RxData*

When this token is used for receiving, *RxData* is a pointer to **EFI\_TCP4\_RECEIVE\_DATA**. Type **EFI\_TCP4\_RECEIVE\_DATA** is defined below.

*TxData*

When this token is used for transmitting, *TxData* is a pointer to **EFI\_TCP4\_TRANSMIT\_DATA**. Type **EFI\_TCP4\_TRANSMIT\_DATA** is defined below.

The **EFI\_TCP4\_IO\_TOKEN** structures are used for both transmit and receive operations.

When used for transmitting, the *CompletionToken.Event* and *TxData* fields must be filled in by the user. After the transmit operation completes, the *CompletionToken.Status* field is updated by the instance and the *Event* is signaled.

- When used for receiving, the *CompletionToken.Event* and *RxData* fields must be filled in by the user. After a receive operation completes, *RxData* and *Status* are updated by the instance and the *Event* is signaled.

```
*****
// TCP4 Token Status definition
//
*****
#define EFI_CONNECTION_FIN      EFIERR(104)
#define EFI_CONNECTION_RESET   EFIERR(105)
#define EFI_CONNECTION_REFUSED EFIERR(106)
```

**Note:** *EFIERR()* sets the maximum bit. Similar to how error codes are described in [Appendix D](#).

```

//*****
// EFI_TCP4_RECEIVE_DATA
//*****
typedef struct {
    BOOLEAN    UrgentFlag;
    UINT32     DataLength;
    UINT32     FragmentCount;
    EFI_TCP4_FRAGMENT_DATA FragmentTable[1];
} EFI_TCP4_RECEIVE_DATA;

```

<i>UrgentFlag</i>	Whether those data are urgent. When this flag is set, the instance is in urgent mode. The implementations of this specification should follow RFC793 to process urgent data, and should NOT mix the data across the urgent point in one token.
<i>DataLength</i>	When calling <b>Receive()</b> function, it is the byte counts of all <i>Fragmentbuffer</i> in <i>FragmentTable</i> allocated by user. When the token is signaled by TCPv4 driver it is the length of received data in the fragments.
<i>FragmentCount</i>	Number of fragments.
<i>FragmentTable</i>	An array of fragment descriptors. Type <b>EFI_TCP4_FRAGMENT_DATA</b> is defined below.

When TCPv4 driver wants to deliver received data to the application, it will pick up the first queued receiving token, update its *Token->Packet.RxData* then signal the *Token->CompletionToken.Event*.

- The *FragmentBuffers* in *FragmentTable* are allocated by the application when calling **Receive()** function and received data will be copied to those buffers by the driver. *FragmentTable* may contain multiple buffers that are NOT in the continuous memory locations. The application should combine those buffers in the *FragmentTable* to process data if necessary.

```

//*****
// EFI_TCP4_FRAGMENT_DATA
//*****
typedef struct {
    UINT32    FragmentLength;
    VOID     *FragmentBuffer;
} EFI_TCP4_FRAGMENT_DATA;

```

<i>FragmentLength</i>	Length of data buffer in the fragment.
<i>FragmentBuffer</i>	Pointer to the data buffer in the fragment.

**EFI\_TCP4\_FRAGMENT\_DATA** allows multiple receive or transmit buffers to be specified. The purpose of this structure is to provide scattered read and write.

```

//*****
// EFI_TCP4_TRANSMIT_DATA
//*****
typedef struct {
    BOOLEAN    Push;
    BOOLEAN    Urgent;
    UINT32     DataLength;
    UINT32     FragmentCount;
    EFI_TCP4_FRAGMENT_DATA FragmentTable[1];
} EFI_TCP4_TRANSMIT_DATA;
    
```

- Push* If **TRUE**, data must be transmitted promptly, and the PUSH bit in the last TCP segment created will be set. If **FALSE**, data transmission may be delay to combine with data from subsequent **Transmit()**s for efficiency.
- Urgent* The data in the fragment table are urgent and urgent point is in effect if **TRUE**. Otherwise those data are NOT considered urgent.
- DataLength* Length of the data in the fragments.
- FragmentCount* Number of fragments.
- FragmentTable* A array of fragment descriptors. Type **EFI\_TCP4\_FRAGMENT\_DATA** is defined above.

The EFI TCPv4 Protocol user must fill this data structure before sending a packet. The packet may contain multiple buffers in non-continuous memory locations.

### Status Codes Returned

EFI_SUCCESS	The data has been queued for transmission.
EFI_NOT_STARTED	This EFI TCPv4 Protocol instance has not been configured.
EFI_NO_MAPPING	When using a default address, configuration (DHCP, BOOTP, RARP, etc.) is not finished yet.
EFI_INVALID_PARAMETER	One or more of the following are <b>TRUE</b> : <ul style="list-style-type: none"> <li>• <i>This</i> is <b>NULL</b>.</li> <li>• <i>Token</i> is <b>NULL</b>.</li> <li>• <i>Token-&gt;CompletionToken.Event</i> is <b>NULL</b>.</li> <li>• <i>Token-&gt;Packet.TxData</i> is <b>NULL</b>.</li> <li>• <i>Token-&gt;Packet.FragmentCount</i> is zero.</li> <li>• <i>Token-&gt;Packet.DataLength</i> is not equal to the sum of fragment lengths.</li> </ul>

EFI_ACCESS_DENIED	<p>One or more of the following conditions is <b>TRUE</b>:</p> <ul style="list-style-type: none"> <li>• A transmit completion token with the same <i>Token-&gt;CompletionToken.Event</i> was already in the transmission queue.</li> <li>• The current instance is in <i>Tcp4StateClosed</i> state.</li> <li>• The current instance is a passive one and it is in <i>Tcp4StateListen</i> state.</li> <li>• User has called <b>Close()</b> to disconnect this connection.</li> </ul>
EFI_NOT_READY	The completion token could not be queued because the transmit queue is full.
EFI_OUT_OF_RESOURCES	Could not queue the transmit data because of resource shortage.
EFI_NETWORK_UNREACHABLE	There is no route to the destination network or address.
EFI_NO_MEDIA	There was a media error.

## EFI\_TCP4\_PROTOCOL.Receive()

### Summary

Places an asynchronous receive request into the receiving queue.

### Prototype

```
typedef
EFI_STATUS
(EFIAPI *EFI_TCP4_RECEIVE) (
    IN EFI_TCP4_PROTOCOL *This,
    IN EFI_TCP4_IO_TOKEN *Token
);
```

### Parameters

<i>This</i>	Pointer to the <b>EFI_TCP4_PROTOCOL</b> instance.
<i>Token</i>	Pointer to a token that is associated with the receive data descriptor. Type <b>EFI_TCP4_IO_TOKEN</b> is defined in <b>EFI_TCP4_PROTOCOL.Transmit()</b> .

### Description

The **Receive()** function places a completion token into the receive packet queue. This function is always asynchronous. The caller must allocate the *Token->CompletionToken.Event* and the *FragmentBuffer* used to receive data. He also must fill the *DataLength* which represents the whole length of all *FragmentBuffer*. When the receive operation completes, the EFI TCPv4 Protocol driver updates the *Token->CompletionToken.Status* and *Token->Packet.RxData* fields and the *Token->CompletionToken.Event* is signaled. If got data the data and its length will be copy into the *FragmentTable*, in the same time the full length of received data will be recorded in the *DataLength* fields. Providing a proper notification function and context for the event will enable the user to receive the notification and receiving status. That notification function is guaranteed to not be re-entered.

### Status Codes Returned

EFI_SUCCESS	The receive completion token was cached.
EFI_NOT_STARTED	This EFI TCPv4 Protocol instance has not been configured.
EFI_NO_MAPPING	When using a default address, configuration (DHCP, BOOTP, RARP, etc.) is not finished yet.

EFI_INVALID_PARAMETER	<p>One or more of the following conditions is <b>TRUE</b>:</p> <ul style="list-style-type: none"> <li>• <i>This</i> is <b>NULL</b>.</li> <li>• <i>Token</i> is <b>NULL</b>.</li> <li>• <i>Token-&gt;CompletionToken.Event</i> is <b>NULL</b>.</li> <li>• <i>Token-&gt;Packet.RxData</i> is <b>NULL</b>.</li> <li>• <i>Token-&gt;Packet.RxData-&gt;DataLength</i> is <b>0</b>.</li> <li>• The <i>Token-&gt;Packet.RxData-&gt;DataLength</i> is not the sum of all <i>FragmentBuffer</i> length in <i>FragmentTable</i>.</li> </ul>
EFI_OUT_OF_RESOURCES	The receive completion token could not be queued due to a lack of system resources (usually memory).
EFI_DEVICE_ERROR	An unexpected system or network error occurred. The EFI TCPv4 Protocol instance has been reset to startup defaults.
EFI_ACCESS_DENIED	<p>One or more of the following conditions is <b>TRUE</b>:</p> <ul style="list-style-type: none"> <li>• A receive completion token with the same <i>Token-&gt;CompletionToken.Event</i> was already in the receive queue.</li> <li>• The current instance is in <i>Tcp4StateClosed</i> state.</li> <li>• The current instance is a passive one and it is in <i>Tcp4StateListen</i> state.</li> <li>• User has called <b>Close()</b> to disconnect this connection.</li> </ul>
EFI_CONNECTION_FIN	The communication peer has closed the connection and there is no any buffered data in the receive buffer of this instance.
EFI_NOT_READY	The receive request could not be queued because the receive queue is full.
EFI_NO_MEDIA	There was a media error.



## EFI\_TCP4\_PROTOCOL.Close()

### Summary

Disconnecting a TCP connection gracefully or reset a TCP connection. This function is a nonblocking operation.

### Prototype

```
typedef
EFI_STATUS
(EFIAPI *EFI_TCP4_CLOSE)(
  IN EFI_TCP4_PROTOCOL  *This,
  IN EFI_TCP4_CLOSE_TOKEN *CloseToken
);
```

### Parameters

<i>This</i>	Pointer to the <b>EFI_TCP4_PROTOCOL</b> instance.
<i>CloseToken</i>	Pointer to the close token to return when operation finishes. Type <b>EFI_TCP4_CLOSE_TOKEN</b> is defined in “Related Definition” below.

### Related Definitions

```
/*******
// EFI_TCP4_CLOSE_TOKEN
//*****
typedef struct {
  EFI_TCP4_COMPLETION_TOKEN  CompletionToken;
  BOOLEAN                    AbortOnClose;
} EFI_TCP4_CLOSE_TOKEN;
```

<i>Status</i>	When close finishes or meets any unexpected error it will be set to one of the following values: <b>EFI_SUCCESS</b> . The close operation completes successfully. <b>EFI_ABORTED</b> . User called configure with NULL without close stopping.
<i>AbortOnClose</i>	Abort the TCP connection on close instead of the standard TCP close process when it is set to <b>TRUE</b> . This option can be used to satisfy a fast disconnect.

### Description

Initiate an asynchronous close token to TCP driver. After **Close()** is called, any buffered transmission data will be sent by TCP driver and the current instance will have a graceful close working flow described as RFC 793 if *AbortOnClose* is set to **FALSE**, otherwise, a reset packet will be sent by TCP driver to fast disconnect this connection. When the close operation completes successfully the TCP instance is in **Tcp4StateClosed** state, all

pending asynchronous operation is signaled and any buffers used for TCP network traffic is flushed.

### Status Codes Returned

EFI_SUCCESS	The <b>Close()</b> is called successfully.
EFI_NOT_STARTED	This EFI TCPv4 Protocol instance has not been configured.
EFI_ACCESS_DENIED	One or more of the following are <b>TRUE</b> : <ul style="list-style-type: none"> <li>• <b>Configure()</b> has been called with <i>TcpConfigData</i> set to <b>NULL</b> and this function has not returned.</li> <li>• Previous <b>Close()</b> call on this instance has not finished.</li> </ul>
EFI_INVALID_PARAMETER	One or more of the following are <b>TRUE</b> : <ul style="list-style-type: none"> <li>• <i>This</i> is <b>NULL</b>.</li> <li>• <i>CloseToken</i> is <b>NULL</b>.</li> <li>• <i>CloseToken-&gt;CompletionToken.Event</i> is <b>NULL</b>.</li> </ul>
EFI_OUT_OF_RESOURCES	Could not allocate enough resource to finish the operation.
EFI_DEVICE_ERROR	Any unexpected and not belonged to above category error.

## EFI\_TCP4\_PROTOCOL.Cancel()

### Summary

Abort an asynchronous connection, listen, transmission or receive request.

### Prototype

```
typedef
EFI_STATUS
(EFIAPI *EFI_TCP4_CANCEL)(
    IN EFI_TCP4_PROTOCOL *This,
    IN EFI_TCP4_COMPLETION_TOKEN *Token OPTIONAL
);
```

### Parameters

<i>This</i>	Pointer to the <b>EFI_TCP4_PROTOCOL</b> instance.
<i>Token</i>	Pointer to a token that has been issued by <b>EFI_TCP4_PROTOCOL.Connect()</b> , <b>EFI_TCP4_PROTOCOL.Accept()</b> , <b>EFI_TCP4_PROTOCOL.Transmit()</b> or <b>EFI_TCP4_PROTOCOL.Receive()</b> . If <b>NULL</b> , all pending tokens issued by above four functions will be aborted. Type <b>EFI_TCP4_COMPLETION_TOKEN</b> is defined in <b>EFI_TCP4_PROTOCOL.Connect()</b> .

### Description

The **Cancel()** function aborts a pending connection, listen, transmit or receive request. If *Token* is not **NULL** and the token is in the connection, listen, transmission or receive queue when it is being cancelled, its *Token->Status* will be set to **EFI\_ABORTED** and then *Token->Event* will be signaled. If the token is not in one of the queues, which usually means that the asynchronous operation has completed, **EFI\_NOT\_FOUND** is returned. If *Token* is **NULL** all asynchronous token issued by **Connect()**, **Accept()**, **Transmit()** and **Receive()** will be aborted.

### Status Codes Returned

EFI_SUCCESS	The asynchronous I/O request is aborted and <i>Token-&gt;Event</i> is signaled.
EFI_INVALID_PARAMETER	<i>This</i> is <b>NULL</b> .
EFI_NOT_STARTED	This instance hasn't been configured.
EFI_NO_MAPPING	When using the default address, configuration (DHCP, BOOTP, RARP, etc.) hasn't finished yet.
EFI_NOT_FOUND	The asynchronous I/O request isn't found in the transmission or receive queue. It has either completed or wasn't issued by <b>Transmit()</b> and <b>Receive()</b> .
EFI_UNSUPPORTED	The implementation does not support this function.

## EFI\_TCP4\_PROTOCOL.Poll()

### Summary

Poll to receive incoming data and transmit outgoing segments.

### Prototype

```
typedef
EFI_STATUS
(EFI_API *EFI_TCP4_POLL) (
    IN EFI_TCP4_PROTOCOL  *This
);
```

### Parameters

*This* Pointer to the **EFI\_TCP4\_PROTOCOL** instance.

### Description

The **Poll()** function increases the rate that data is moved between the network and application and can be called when the TCP instance is created successfully. Its use is optional.

In some implementations, the periodical timer in the MNP driver may not poll the underlying communications device fast enough to avoid drop packets. Drivers and applications that are experiencing packet loss should try calling the **Poll()** function in a high frequency.

### Status Codes Returned

EFI_SUCCESS	Incoming or outgoing data was processed.
EFI_INVALID_PARAMETER	<i>This</i> is <b>NULL</b> .
EFI_DEVICE_ERROR	An unexpected system or network error occurred.
EFI_NOT_READY	No incoming or outgoing data is processed.
EFI_TIMEOUT	Data was dropped out of the transmission or receive queue. Consider increasing the polling rate.

## 28.2 EFI TCPv6 Protocol

This section defines the EFI TCPv6 (Transmission Control Protocol version 6) Protocol.

## 28.2.1 TCPv6 Service Binding Protocol

### EFI\_TCP6\_SERVICE\_BINDING\_PROTOCOL

#### Summary

The EFI TCPv6 Service Binding Protocol is used to locate EFI TCPv6 Protocol drivers to create and destroy protocol child instance of the driver to communicate with other host using TCP protocol.

#### GUID

```
#define EFI_TCP6_SERVICE_BINDING_PROTOCOL_GUID \
{0xec20eb79,0x6c1a,0x4664,\
{0x9a,0x0d,0xd2,0xe4,0xcc,0x16,0xd6, 0x64}}
```

#### Description

A network application that requires TCPv6 I/O services can call one of the protocol handler services, such as **BS->LocateHandleBuffer()**, to search devices that publish an EFI TCPv6 Service Binding Protocol GUID. Such device supports the EFI TCPv6 Protocol and may be available for use.

After a successful call to the **EFI\_TCP6\_SERVICE\_BINDING\_PROTOCOL.CreateChild()** function, the newly created child EFI TCPv6 Protocol driver is in an un-configured state; it is not ready to do any operation except **Poll()** send and receive data packets until configured.

Every successful call to the **EFI\_TCP6\_SERVICE\_BINDING\_PROTOCOL.CreateChild()** function must be matched with a call to the **EFI\_TCP6\_SERVICE\_BINDING\_PROTOCOL.DestroyChild()** function to release the protocol driver.

## 28.2.2 TCPv6 Protocol

### EFI\_TCP6\_PROTOCOL

#### Summary

The EFI TCPv6 Protocol provides services to send and receive data stream.

#### GUID

```
#define EFI_TCP6_PROTOCOL_GUID \
  {0x46e44855,0xbd60,0x4ab7,\
   {0xab,0x0d,0xa6,0x79,0xb9,0x44,0x7d,0x77}}
```

#### Protocol Interface Structure

```
typedef struct _EFI_TCP6_PROTOCOL {
  EFI_TCP6_GET_MODE_DATA GetModeData;
  EFI_TCP6_CONFIGURE Configure;
  EFI_TCP6_CONNECT Connect;
  EFI_TCP6_ACCEPT Accept;
  EFI_TCP6_TRANSMIT Transmit;
  EFI_TCP6_RECEIVE Receive;
  EFI_TCP6_CLOSE Close;
  EFI_TCP6_CANCEL Cancel;
  EFI_TCP6_POLL Poll;
} EFI_TCP6_PROTOCOL;
```

#### Parameters

<i>GetModeData</i>	Get the current operational status. See the <b>GetModeData()</b> function description.
<i>Configure</i>	Initialize, change, or brutally reset operational settings of the EFI TCPv6 Protocol. See the <b>Configure()</b> function description.
<i>Connect</i>	Initiate the TCP three-way handshake to connect to the remote peer configured in this TCP instance. The function is a nonblocking operation. See the <b>Connect()</b> function description.
<i>Accept</i>	Listen for incoming TCP connection requests. This function is a nonblocking operation. See the <b>Accept()</b> function description.
<i>Transmit</i>	Queue outgoing data to the transmit queue. This function is a nonblocking operation. See the <b>Transmit()</b> function description.
<i>Receive</i>	Queue a receiving request token to the receive queue. This function is a nonblocking operation. See the <b>Receive()</b> function description.

<i>Close</i>	Gracefully disconnect a TCP connection follow RFC 793 or reset a TCP connection. This function is a nonblocking operation. See the <b>Close()</b> function description.
<i>Cancel</i>	Abort a pending connect, listen, transmit or receive request. See the <b>Cancel()</b> function description.
<i>Poll</i>	Poll to receive incoming data and transmit outgoing TCP segments. See the <b>Poll()</b> function description.

## Description

The **EFI\_TCP6\_PROTOCOL** defines the EFI TCPv6 Protocol child to be used by any network drivers or applications to send or receive data stream. It can either listen on a specified port as a service or actively connect to remote peer as a client. Each instance has its own independent settings.

**Note:** *Byte Order. In this document, all IPv6 addresses and incoming/outgoing packets are stored in network byte order. All other parameters in the functions and data structures that are defined in this document are stored in host byte order unless explicitly specified.*

## EFI\_TCP6\_PROTOCOL.GetModeData()

### Summary

Get the current operational status.

### Prototype

```
typedef
EFI_STATUS
(EFI_API *EFI_TCP6_GET_MODE_DATA) (
  IN EFI_TCP6_PROTOCOL      *This,
  OUT EFI_TCP6_CONNECTION_STATE *Tcp6State OPTIONAL,
  OUT EFI_TCP6_CONFIG_DATA   *Tcp6ConfigData OPTIONAL,
  OUT EFI_IPv6_MODE_DATA     *Ip6ModeData OPTIONAL,
  OUT EFI_MANAGED_NETWORK_CONFIG_DATA *MnpConfigData OPTIONAL,
  OUT EFI_SIMPLE_NETWORK_MODE  *SnpModeData OPTIONAL
);
```

### Parameters

<i>This</i>	Pointer to the <b>EFI_TCP6_PROTOCOL</b> instance.
<i>Tcp6State</i>	The buffer in which the current TCP state is returned. Type <b>EFI_TCP6_CONNECTION_STATE</b> is defined in "Related Definitions" below.
<i>Tcp6ConfigData</i>	The buffer in which the current TCP configuration is returned. Type <b>EFI_TCP6_CONFIG_DATA</b> is defined in "Related Definitions" below.
<i>Ip6ModeData</i>	The buffer in which the current IPv6 configuration data used by the TCP instance is returned. Type <b>EFI_IP6_MODE_DATA</b> is defined in <b>EFI_IP6_PROTOCOL.GetModeData()</b> .
<i>MnpConfigData</i>	The buffer in which the current MNP configuration data used indirectly by the TCP instance is returned. Type <b>EFI_MANAGED_NETWORK_CONFIG_DATA</b> is defined in <b>EFI_MANAGED_NETWORK_PROTOCOL.GetModeData()</b> .
<i>SnpModeData</i>	The buffer in which the current SNP mode data used indirectly by the TCP instance is returned. Type <b>EFI_SIMPLE_NETWORK_MODE</b> is defined in the <b>EFI_SIMPLE_NETWORK_PROTOCOL</b> .

### Description

The **GetModeData()** function copies the current operational settings of this EFI TCPv6 Protocol instance into user-supplied buffers. This function can also be used to retrieve the operational setting of underlying drivers such as IPv6, MNP, or SNP.



## Related Definition

```
typedef struct {
  EFI_IPv6_ADDRESS StationAddress;
  UINT16 StationPort;
  EFI_IPv6_ADDRESS RemoteAddress;
  UINT16 RemotePort;
  BOOLEAN ActiveFlag;
} EFI_TCP6_ACCESS_POINT;
```

<i>StationAddress</i>	The local IP address assigned to this TCP instance. The EFI TCPv6 driver will only deliver incoming packets whose destination addresses exactly match the IP address. Set to zero to let the underlying IPv6 driver choose a source address. If not zero it must be one of the configured IP addresses in the underlying IPv6 driver.
<i>StationPort</i>	The local port number to which this EFI TCPv6 Protocol instance is bound. If the instance doesn't care the local port number, set <i>StationPort</i> to zero to use an ephemeral port.
<i>RemoteAddress</i>	The remote IP address to which this EFI TCPv6 Protocol instance is connected. If <i>ActiveFlag</i> is <b>FALSE</b> (i.e., a passive TCPv6 instance), the instance only accepts connections from the <i>RemoteAddress</i> . If <i>ActiveFlag</i> is <b>TRUE</b> the instance will connect to the <i>RemoteAddress</i> , i.e., outgoing segments will be sent to this address and only segments from this address will be delivered to the application. When <i>ActiveFlag</i> is <b>FALSE</b> , it can be set to zero and means that incoming connection requests from any address will be accepted.
<i>RemotePort</i>	The remote port to which this EFI TCPv6 Protocol instance connects or from which connection request will be accepted by this EFI TCPv6 Protocol instance. If <i>ActiveFlag</i> is <b>FALSE</b> it can be zero and means that incoming connection request from any port will be accepted. Its value can not be zero when <i>ActiveFlag</i> is <b>TRUE</b> .
<i>ActiveFlag</i>	Set it to <b>TRUE</b> to initiate an active open. Set it to <b>FALSE</b> to initiate a passive open to act as a server.

```

//*****
// EFI_TCP6_OPTION
//*****
typedef struct {
    UINT32    ReceiveBufferSize;
    UINT32    SendBufferSize;
    UINT32    MaxSynBackLog;
    UINT32    ConnectionTimeout;
    UINT32    DataRetries;
    UINT32    FinTimeout;
    UINT32    TimeWaitTimeout;
    UINT32    KeepAliveProbes;
    UINT32    KeepAliveTime;
    UINT32    KeepAliveInterval;
    BOOLEAN   EnableNagle;
    BOOLEAN   EnableTimeStamp;
    BOOLEAN   EnableWindowScaling;
    BOOLEAN   EnableSelectiveAck;
    BOOLEAN   EnablePathMtuDiscovery;
} EFI_TCP6_OPTION;

```

<i>ReceiveBufferSize</i>	The size of the TCP receive buffer.
<i>SendBufferSize</i>	The size of the TCP send buffer.
<i>MaxSynBackLog</i>	The length of incoming connect request queue for a passive instance. When set to zero, the value is implementation specific.
<i>ConnectionTimeout</i>	The maximum seconds a TCP instance will wait for before a TCP connection established. When set to zero, the value is implementation specific.
<i>DataRetries</i>	The number of times TCP will attempt to retransmit a packet on an established connection. When set to zero, the value is implementation specific.
<i>FinTimeout</i>	How many seconds to wait in the FIN_WAIT_2 states for a final FIN flag before the TCP instance is closed. This timeout is in effective only if the application has called <b>Close()</b> to disconnect the connection completely. It is also called FIN_WAIT_2 timer in other implementations. When set to zero, it should be disabled because the FIN_WAIT_2 timer itself is against the standard.
<i>TimeWaitTimeout</i>	How many seconds to wait in TIME_WAIT state before the TCP instance is closed. The timer is disabled completely to provide a method to close the TCP connection quickly if it is set to zero. It is against the related RFC documents.
<i>KeepAliveProbes</i>	The maximum number of TCP keep-alive probes to send before giving up and resetting the connection if no

	response from the other end. Set to zero to disable keep-alive probe.
<i>KeepAliveTime</i>	The number of seconds a connection needs to be idle before TCP sends out periodical keep-alive probes. When set to zero, the value is implementation specific. It should be ignored if keep-alive probe is disabled.
<i>KeepAliveInterval</i>	The number of seconds between TCP keep-alive probes after the periodical keep-alive probe if no response. When set to zero, the value is implementation specific. It should be ignored if keep-alive probe is disabled.
<i>EnableNagle</i>	Set it to <b>TRUE</b> to enable the Nagle algorithm as defined in RFC896. Set it to <b>FALSE</b> to disable it.
<i>EnableTimeStamp</i>	Set it to <b>TRUE</b> to enable TCP timestamps option as defined in RFC1323. Set to <b>FALSE</b> to disable it.
<i>EnableWindowScaling</i>	Set it to <b>TRUE</b> to enable TCP window scale option as defined in RFC1323. Set it to <b>FALSE</b> to disable it.
<i>EnableSelectiveAck</i>	Set it to <b>TRUE</b> to enable selective acknowledge mechanism described in RFC 2018. Set it to <b>FALSE</b> to disable it. Implementation that supports SACK can optionally support DSAK as defined in RFC 2883.
<i>EnablePathMtdiscovery</i>	Set it to <b>TRUE</b> to enable path MTU discovery as defined in RFC 1191. Set to <b>FALSE</b> to disable it.

Option setting with digital value will be modified by driver if it is set out of the implementation specific range and an implementation specific default value will be set accordingly.

```

//*****
// EFI_TCP6_CONFIG_DATA
//*****
typedef struct {
  UINT8    TrafficClass;
  UINT8    HopLimit;
  EFI_TCP6_ACCESS_POINT AccessPoint;
  EFI_TCP6_OPTION *ControlOption;
} EFI_TCP6_CONFIG_DATA;

```

<i>TrafficClass</i>	<i>TrafficClass</i> field in transmitted IPv6 packets.
<i>HopLimit</i>	<i>HopLimit</i> field in transmitted IPv6 packets.
<i>AccessPoint</i>	Used to specify TCP communication end settings for a TCP instance.
<i>ControlOption</i>	Used to configure the advance TCP option for a connection. If set to <b>NULL</b> , implementation specific options for TCP connection will be used.

```

//*****
// EFI_TCP6_CONNECTION_STATE
//*****

typedef enum {
    Tcp6StateClosed = 0,
    Tcp6StateListen = 1,
    Tcp6StateSynSent = 2,
    Tcp6StateSynReceived = 3,
    Tcp6StateEstablished = 4,
    Tcp6StateFinWait1 = 5,
    Tcp6StateFinWait2 = 6,
    Tcp6StateClosing = 7,
    Tcp6StateTimeWait = 8,
    Tcp6StateCloseWait = 9,
    Tcp6StateLastAck = 10
} EFI_TCP6_CONNECTION_STATE;
    
```

### Status Codes Returned

EFI_SUCCESS	The mode data was read.
EFI_NOT_STARTED	No configuration data is available because this instance hasn't been started.
EFI_INVALID_PARAMETER	<i>This is NULL.</i>

## EFI\_TCP6\_PROTOCOL.Configure()

### Summary

Initialize or brutally reset the operational parameters for this TCP instance.

### Prototype

```
typedef
EFI_STATUS
(EFI_API *EFI_TCP6_CONFIGURE) (
  IN EFI_TCP6_PROTOCOL *This,
  IN EFI_TCP6_CONFIG_DATA *Tcp6ConfigData OPTIONAL
);
```

### Parameters

*This* Pointer to the **EFI\_TCP6\_PROTOCOL** instance.

*Tcp6ConfigData* Pointer to the configure data to configure the instance.

### Description

The **Configure()** function does the following:

- Initialize this TCP instance, i.e., initialize the communication end settings and specify active open or passive open for an instance.
- Reset this TCP instance brutally, i.e., cancel all pending asynchronous tokens, flush transmission and receiving buffer directly without informing the communication peer.

No other TCPv6 Protocol operation except **Poll()** can be executed by this instance until it is configured properly. For an active TCP instance, after a proper configuration it may call **Connect()** to initiate the three-way handshake. For a passive TCP instance, its state will transit to *Tcp6StateListen* after configuration, and **Accept()** may be called to listen the incoming TCP connection requests. If *Tcp6ConfigData* is set to **NULL**, the instance is reset. Resetting process will be done brutally, the state machine will be set to *Tcp6StateClosed* directly, the receive queue and transmit queue will be flushed, and no traffic is allowed through this instance.

### Status Codes Returned

EFI_SUCCESS	The operational settings are set, changed, or reset successfully.
EFI_NO_MAPPING	The underlying IPv6 driver was responsible for choosing a source address for this instance, but no source address was available for use.

EFI_INVALID_PARAMETER	<p>One or more of the following conditions are <b>TRUE</b>:</p> <ul style="list-style-type: none"> <li>• <i>This</i> is <b>NULL</b>.</li> <li>• <i>Tcp6ConfigData-&gt;AccessPoint.StationAddress</i> is neither zero nor one of the configured IP addresses in the underlying IPv6 driver.</li> <li>• <i>Tcp6ConfigData-&gt;AccessPoint.RemoteAddress</i> isn't a valid unicast IPv6 address.</li> <li>• <i>Tcp6ConfigData-&gt;AccessPoint.RemoteAddress</i> is zero or <i>Tcp6ConfigData-&gt;AccessPoint.RemotePort</i> is zero when <i>Tcp6ConfigData-&gt;AccessPoint.ActiveFlag</i> is <b>TRUE</b>.</li> <li>• A same access point has been configured in other TCP instance properly.</li> </ul>
EFI_ACCESS_DENIED	Configuring TCP instance when it is configured without calling <b>Configure()</b> with <b>NULL</b> to reset it.
EFI_UNSUPPORTED	One or more of the control options are not supported in the implementation.
EFI_OUT_OF_RESOURCES	Could not allocate enough system resources when executing <b>Configure()</b> .
EFI_DEVICE_ERROR	An unexpected network or system error occurred.

## EFI\_TCP6\_PROTOCOL.Connect()

### Summary

Initiate a nonblocking TCP connection request for an active TCP instance.

### Prototype

```
typedef
EFI_STATUS
(EFI_API *EFI_TCP6_CONNECT) (
  IN EFI_TCP6_PROTOCOL *This,
  IN EFI_TCP6_CONNECTION_TOKEN *ConnectionToken
);
```

### Parameters

<i>This</i>	Pointer to the <b>EFI_TCP6_PROTOCOL</b> instance.
<i>ConnectionToken</i>	Pointer to the connection token to return when the TCP three-way handshake finishes. Type <b>EFI_TCP6_CONNECTION_TOKEN</b> is defined in Related Definition below.

### Description

The **Connect()** function will initiate an active open to the remote peer configured in current TCP instance if it is configured active. If the connection succeeds or fails due to any error, the *ConnectionToken->CompletionToken.Event* will be signaled and *ConnectionToken->CompletionToken.Status* will be updated accordingly. This function can only be called for the TCP instance in *Tcp6StateClosed* state. The instance will transfer into *Tcp6StateSynSent* if the function returns **EFI\_SUCCESS**. If TCP three-way handshake succeeds, its state will become *Tcp6StateEstablished*, otherwise, the state will return to *Tcp6StateClosed*.

### Related Definitions

```
//*****
// EFI_TCP6_COMPLETION_TOKEN
//*****
typedef struct {
  EFI_EVENT      Event;
  EFI_STATUS     Status;
} EFI_TCP6_COMPLETION_TOKEN;
```

<i>Event</i>	The Event to signal after request is finished and <i>Status</i> field is updated by the EFI TCPv6 Protocol driver. The type of Event must be <b>EVT_NOTIFY_SIGNAL</b> .
<i>Status</i>	The result of the completed operation. <b>EFI_NO_MEDIA</b> . There was a media error

The **EFI\_TCP6\_COMPLETION\_TOKEN** is used as a common header for various asynchronous tokens.

```

//*****
// EFI_TCP6_CONNECTION_TOKEN
//*****
typedef struct {
    EFI_TCP6_COMPLETION_TOKEN CompletionToken;
} EFI_TCP6_CONNECTION_TOKEN;

```

### *Status*

The *Status* in the *CompletionToken* will be set to one of the following values if the active open succeeds or an unexpected error happens:

**EFI\_SUCCESS:** The active open succeeds and the instance's state is *Tcp6StateEstablished*.

**EFI\_CONNECTION\_RESET:** The connect fails because the connection is reset either by instance itself or the communication peer.

**EFI\_CONNECTION\_REFUSED:** The receiving or transmission operation fails because this connection is refused.

**EFI\_ABORTED:** The active open is aborted.

**EFI\_TIMEOUT:** The connection establishment timer expires and no more specific information is available.

**EFI\_NETWORK\_UNREACHABLE:** The active open fails because an ICMP network unreachable error is received.

**EFI\_HOST\_UNREACHABLE:** The active open fails because an ICMP host unreachable error is received.

**EFI\_PROTOCOL\_UNREACHABLE:** The active open fails because an ICMP protocol unreachable error is received.

**EFI\_PORT\_UNREACHABLE:** The connection establishment timer times out and an ICMP port unreachable error is received.

**EFI\_ICMP\_ERROR:** The connection establishment timer times out and some other ICMP error is received.

**EFI\_DEVICE\_ERROR:** An unexpected system or network error occurred.

**EFI\_SECURITY\_VIOLATION:** The active open was failed because of IPsec policy check.



## Status Codes Returned

EFI_SUCCESS	The connection request is successfully initiated and the state of this TCP instance has been changed to <i>Tcp6StateSynSent</i> .
EFI_NOT_STARTED	This EFI TCPv6 Protocol instance has not been configured.
EFI_ACCESS_DENIED	One or more of the following conditions are <b>TRUE</b> : <ul style="list-style-type: none"> <li>• This instance is not configured as an active one.</li> <li>• This instance is not in <i>Tcp6StateClosed</i> state.</li> </ul>
EFI_INVALID_PARAMETER	One or more of the following are <b>TRUE</b> : <ul style="list-style-type: none"> <li>• <i>This</i> is <i>NULL</i>.</li> <li>• <i>ConnectionToken</i> is <i>NULL</i>.</li> <li>• <i>ConnectionToken-&gt;CompletionToken.Event</i> is <b>NULL</b>.</li> </ul>
EFI_OUT_OF_RESOURCES	The driver can't allocate enough resource to initiate the active open.
EFI_DEVICE_ERROR	An unexpected system or network error occurred.

## EFI\_TCP6\_PROTOCOL.Accept()

### Summary

Listen on the passive instance to accept an incoming connection request. This is a non-blocking operation.

### Prototype

```
typedef
EFI_STATUS
(EFI_API *EFI_TCP6_ACCEPT) (
  IN EFI_TCP6_PROTOCOL  *This,
  IN EFI_TCP6_LISTEN_TOKEN *ListenToken
);
```

### Parameters

<i>This</i>	Pointer to the <b>EFI_TCP6_PROTOCOL</b> instance.
<i>ListenToken</i>	Pointer to the listen token to return when operation finishes. Type <b>EFI_TCP6_LISTEN_TOKEN</b> is defined in Related Definition below.

### Related Definitions

```
/**
//*****
// EFI_TCP6_LISTEN_TOKEN
//*****
typedef struct {
  EFI_TCP6_COMPLETION_TOKEN  CompletionToken;
  EFI_HANDLE                 NewChildHandle;
} EFI_TCP6_LISTEN_TOKEN;
```

*Status* The *Status* in *CompletionToken* will be set to the following value if accept finishes:

**EFI\_SUCCESS**: A remote peer has successfully established a connection to this instance. A new TCP instance has also been created for the connection.

**EFI\_CONNECTION\_RESET**: The accept fails because the connection is reset either by instance itself or communication peer.

**EFI\_ABORTED**: The accept request has been aborted.

**EFI\_SECURITY\_VIOLATION**: The accept operation was failed because of IPsec policy check.

*NewChildHandle* The new TCP instance handle created for the established connection.

## Description

The **Accept()** function initiates an asynchronous accept request to wait for an incoming connection on the passive TCP instance. If a remote peer successfully establishes a connection with this instance, a new TCP instance will be created and its handle will be returned in *ListenToken->NewChildHandle*. The newly created instance is configured by inheriting the passive instance's configuration and is ready for use upon return. The new instance is in the *Tcp6StateEstablished* state.

The *ListenToken->CompletionToken.Event* will be signaled when a new connection is accepted, user aborts the listen or connection is reset.

This function only can be called when current TCP instance is in *Tcp6StateListen* state.

## Status Codes Returned

EFI_SUCCESS	The listen token has been queued successfully.
EFI_NOT_STARTED	This EFI TCPv6 Protocol instance has not been configured.
EFI_ACCESS_DENIED	One or more of the following are <b>TRUE</b> : <ul style="list-style-type: none"> <li>• This instance is not a passive instance.</li> <li>• This instance is not in <i>Tcp6StateListen</i> state.</li> <li>• The same listen token has already existed in the listen token queue of this TCP instance.</li> </ul>
EFI_INVALID_PARAMETER	One or more of the following are <b>TRUE</b> : <ul style="list-style-type: none"> <li>• <i>This</i> is <b>NULL</b>.</li> <li>• <i>ListenToken</i> is <b>NULL</b>.</li> <li>• <i>ListenToken-&gt;CompletionToken.Event</i> is <b>NULL</b>.</li> </ul>
EFI_OUT_OF_RESOURCES	Could not allocate enough resource to finish the operation.
EFI_DEVICE_ERROR	Any unexpected and not belonged to above category error.

## EFI\_TCP6\_PROTOCOL.Transmit()

### Summary

Queues outgoing data into the transmit queue.

### Prototype

```
typedef
EFI_STATUS
(EFIAPI *EFI_TCP6_TRANSMIT) (
  IN EFI_TCP6_PROTOCOL  *This,
  IN EFI_TCP6_IO_TOKEN  *Token
);
```

### Parameters

<i>This</i>	Pointer to the <b>EFI_TCP6_PROTOCOL</b> instance.
<i>Token</i>	Pointer to the completion token to queue to the transmit queue. Type <b>EFI_TCP6_IO_TOKEN</b> is defined in "Related Definitions" below.

### Description

The **Transmit()** function queues a sending request to this TCP instance along with the user data. The status of the token is updated and the event in the token will be signaled once the data is sent out or some error occurs.

### Related Definitions

```
/**
//*****
// EFI_TCP6_IO_TOKEN
//*****
typedef struct {
  EFI_TCP6_COMPLETION_TOKEN  CompletionToken;
  union {
    EFI_TCP6_RECEIVE_DATA  *RxData;
    EFI_TCP6_TRANSMIT_DATA *TxData;
  } Packet;
} EFI_TCP6_IO_TOKEN;
```

<i>Status</i>	When transmission finishes or meets any unexpected error it will be set to one of the following values: <b>EFI_SUCCESS</b> : The receiving or transmission operation completes successfully. <b>EFI_CONNECTION_FIN</b> : The receiving operation fails because the communication peer has closed the connection and there is no more data in the receive buffer of the instance.
---------------	--

**EFI\_CONNECTION\_RESET:** The receiving or transmission operation fails because this connection is reset either by instance itself or the communication peer.

**EFI\_ABORTED:** The receiving or transmission is aborted.

**EFI\_TIMEOUT:** The transmission timer expires and no more specific information is available.

**EFI\_NETWORK\_UNREACHABLE:** The transmission fails because an ICMP network unreachable error is received.

**EFI\_HOST\_UNREACHABLE:** The transmission fails because an ICMP host unreachable error is received.

**EFI\_PROTOCOL\_UNREACHABLE:** The transmission fails because an ICMP protocol unreachable error is received.

**EFI\_PORT\_UNREACHABLE:** The transmission fails and an ICMP port unreachable error is received.

**EFI\_ICMP\_ERROR:** The transmission fails and some other ICMP error is received.

**EFI\_DEVICE\_ERROR:** An unexpected system or network error occurs.

**EFI\_SECURITY\_VIOLATION:** The receiving or transmission operation was failed because of IPsec policy check.

*RxData*

When this token is used for receiving, *RxData* is a pointer to **EFI\_TCP6\_RECEIVE\_DATA**. Type **EFI\_TCP6\_RECEIVE\_DATA** is defined below.

*TxData*

When this token is used for transmitting, *TxData* is a pointer to **EFI\_TCP6\_TRANSMIT\_DATA**. Type **EFI\_TCP6\_TRANSMIT\_DATA** is defined below.

The **EFI\_TCP6\_IO\_TOKEN** structure is used for both transmit and receive operations.

When used for transmitting, the *CompletionToken.Event* and *TxData* fields must be filled in by the user. After the transmit operation completes, the *CompletionToken.Status* field is updated by the instance and the *Event* is signaled.

When used for receiving, the *CompletionToken.Event* and *RxData* fields must be filled in by the user. After a receive operation completes, *RxData* and *Status* are updated by the instance and the *Event* is signaled.

```

//*****
// EFI_TCP6_RECEIVE_DATA
//*****
typedef struct {
    BOOLEAN    UrgentFlag;
    UINT32     DataLength;
    UINT32     FragmentCount;
    EFI_TCP6_FRAGMENT_DATA FragmentTable[1];
} EFI_TCP6_RECEIVE_DATA;

```

<i>UrgentFlag</i>	Whether the data is urgent. When this flag is set, the instance is in urgent mode. The implementations of this specification should follow RFC793 to process urgent data, and should NOT mix the data across the urgent point in one token.
<i>DataLength</i>	When calling <b>Receive()</b> function, it is the byte counts of all <i>Fragmentbuffer</i> in <i>FragmentTable</i> allocated by user. When the token is signaled by TCPv6 driver it is the length of received data in the fragments.
<i>FragmentCount</i>	Number of fragments.
<i>FragmentTable</i>	An array of fragment descriptors. Type <b>EFI_TCP6_FRAGMENT_DATA</b> is defined below.

When TCPv6 driver wants to deliver received data to the application, it will pick up the first queued receiving token, update its *Token->Packet.RxData* then signal the *Token->CompletionToken.Event*.

The *FragmentBuffer* in *FragmentTable* is allocated by the application when calling **Receive()** function and received data will be copied to those buffers by the driver. *FragmentTable* may contain multiple buffers that are NOT in the continuous memory locations. The application should combine those buffers in the *FragmentTable* to process data if necessary.

```

//*****
// EFI_TCP6_FRAGMENT_DATA
//*****
typedef struct {
    UINT32 FragmentLength;
    VOID *FragmentBuffer;
} EFI_TCP6_FRAGMENT_DATA;

```

<i>FragmentLength</i>	Length of data buffer in the fragment.
<i>FragmentBuffer</i>	Pointer to the data buffer in the fragment.

**EFI\_TCP6\_FRAGMENT\_DATA** allows multiple receive or transmit buffers to be specified. The purpose of this structure is to provide scattered read and write.

```

//*****
// EFI_TCP6_TRANSMIT_DATA
//*****
typedef struct {
    BOOLEAN      Push;
    BOOLEAN      Urgent;
    UINT32       DataLength;
    UINT32       FragmentCount;
    EFI_TCP6_FRAGMENT_DATA  FragmentTable[1];
} EFI_TCP6_TRANSMIT_DATA;
    
```

- Push* If **TRUE**, data must be transmitted promptly, and the PUSH bit in the last TCP segment created will be set. If **FALSE**, data transmission may be delayed to combine with data from subsequent **Transmit()**s for efficiency.
- Urgent* The data in the fragment table are urgent and urgent point is in effect if **TRUE**. Otherwise those data are NOT considered urgent.
- DataLength* Length of the data in the fragments.
- FragmentCount* Number of fragments.
- FragmentTable* An array of fragment descriptors. Type **EFI\_TCP6\_FRAGMENT\_DATA** is defined above.

The EFI TCPv6 Protocol user must fill this data structure before sending a packet. The packet may contain multiple buffers in non-continuous memory locations.

### Status Codes Returned

EFI_SUCCESS	The data has been queued for transmission.
EFI_NOT_STARTED	This EFI TCPv6 Protocol instance has not been configured.
EFI_NO_MAPPING	The underlying IPv6 driver was responsible for choosing a source address for this instance, but no source address was available for use.
EFI_INVALID_PARAMETER	One or more of the following are <b>TRUE</b> : <ul style="list-style-type: none"> <li>• <i>This</i> is <b>NULL</b>.</li> <li>• <i>Token</i> is <b>NULL</b>.</li> <li>• <i>Token-&gt;CompletionToken.Event</i> is <b>NULL</b>.</li> <li>• <i>Token-&gt;Packet.TxData</i> is <b>NULL</b>.</li> <li>• <i>Token-&gt;Packet.FragmentCount</i> is zero.</li> <li>• <i>Token-&gt;Packet.DataLength</i> is not equal to the sum of fragment lengths.</li> </ul>

EFI_ACCESS_DENIED	<p>One or more of the following conditions are <b>TRUE</b>:</p> <ul style="list-style-type: none"> <li>• A transmit completion token with the same <i>Token-&gt;CompletionToken.Event</i> was already in the transmission queue.</li> <li>• The current instance is in <i>Tcp6StateClosed</i> state.</li> <li>• The current instance is a passive one and it is in <i>Tcp6StateListen</i> state.</li> <li>• User has called <b>Close()</b> to disconnect this connection.</li> </ul>
EFI_NOT_READY	The completion token could not be queued because the transmit queue is full.
EFI_OUT_OF_RESOURCES	Could not queue the transmit data because of resource shortage.
EFI_NETWORK_UNREACHABLE	There is no route to the destination network or address.
EFI_NO_MEDIA	There was a media error.



## EFI\_TCP6\_PROTOCOL.Receive()

### Summary

Places an asynchronous receive request into the receiving queue.

### Prototype

```
typedef
EFI_STATUS
(EFIAPI *EFI_TCP6_RECEIVE) (
  IN EFI_TCP6_PROTOCOL *This,
  IN EFI_TCP6_IO_TOKEN *Token
);
```

### Parameters

*This*

Pointer to the **EFI\_TCP6\_PROTOCOL** instance.

*Token*

Pointer to a token that is associated with the receive data descriptor. Type **EFI\_TCP6\_IO\_TOKEN** is defined in **EFI\_TCP6\_PROTOCOL.Transmit()**.

### Description

The **Receive()** function places a completion token into the receive packet queue. This function is always asynchronous. The caller must allocate the **Token->CompletionToken.Event** and the **FragmentBuffer** used to receive data. The caller also must fill the **DataLength** which represents the whole length of all **FragmentBuffer**. When the receive operation completes, the EFI TCPv6 Protocol driver updates the **Token->CompletionToken.Status** and **Token->Packet.RxData** fields and the **Token->CompletionToken.Event** is signaled. If got data the data and its length will be copied into the **FragmentTable**, at the same time the full length of received data will be recorded in the **DataLength** fields. Providing a proper notification function and context for the event will enable the user to receive the notification and receiving status. That notification function is guaranteed to not be re-entered.

### Status Codes Returned

EFI_SUCCESS	The receive completion token was cached.
EFI_NOT_STARTED	This EFI TCPv6 Protocol instance has not been configured.
EFI_NO_MAPPING	The underlying IPv6 driver was responsible for choosing a source address for this instance, but no source address was available for use.

EFI_INVALID_PARAMETER	<p>One or more of the following conditions is <b>TRUE</b>:</p> <ul style="list-style-type: none"> <li>• <i>This</i> is <b>NULL</b>.</li> <li>• Token is <b>NULL</b>.</li> <li>• <i>Token-&gt;CompletionToken.Event</i> is <b>NULL</b>.</li> <li>• <i>Token-&gt;Packet.RxData</i> is <b>NULL</b>.</li> <li>• <i>Token-&gt;Packet.RxData-&gt;DataLength</i> is 0.</li> <li>• The <i>Token-&gt;Packet.RxData-&gt;DataLength</i> is not the sum of all <i>FragmentBuffer</i> length in <i>FragmentTable</i>.</li> </ul>
EFI_OUT_OF_RESOURCES	The receive completion token could not be queued due to a lack of system resources (usually memory).
EFI_DEVICE_ERROR	An unexpected system or network error occurred. The EFI TCPv6 Protocol instance has been reset to startup defaults.
EFI_ACCESS_DENIED	<p>One or more of the following conditions is <b>TRUE</b>:</p> <ul style="list-style-type: none"> <li>• A receive completion token with the same <i>Token-&gt;CompletionToken.Event</i> was already in the receive queue.</li> <li>• The current instance is in <i>Tcp6StateClosed</i> state.</li> <li>• The current instance is a passive one and it is in <i>Tcp6StateListen</i> state.</li> <li>• User has called <b>Close()</b> to disconnect this connection.</li> </ul>
EFI_CONNECTION_FIN	The communication peer has closed the connection and there is no any buffered data in the receive buffer of this instance.
EFI_NOT_READY	The receive request could not be queued because the receive queue is full.
EFI_NO_MEDIA	There was a media error.

## EFI\_TCP6\_PROTOCOL.Close()

### Summary

Disconnecting a TCP connection gracefully or reset a TCP connection. This function is a nonblocking operation.

### Prototype

```
typedef
EFI_STATUS
(EFIAPI *EFI_TCP6_CLOSE)(
  IN EFI_TCP6_PROTOCOL  *This,
  IN EFI_TCP6_CLOSE_TOKEN *CloseToken
);
```

### Parameters

<i>This</i>	Pointer to the <b>EFI_TCP6_PROTOCOL</b> instance.
<i>CloseToken</i>	Pointer to the close token to return when operation finishes. Type <b>EFI_TCP6_CLOSE_TOKEN</b> is defined in Related Definition below.

### Related Definitions

```
//*****
// EFI_TCP6_CLOSE_TOKEN
//*****
typedef struct {
  EFI_TCP6_COMPLETION_TOKEN CompletionToken;
  BOOLEAN AbortOnClose;
} EFI_TCP6_CLOSE_TOKEN;
```

<i>Status</i>	When close finishes or meets any unexpected error it will be set to one of the following values: <b>EFI_SUCCESS</b> : The close operation completes successfully. <b>EFI_ABORTED</b> : User called configure with NULL without close stopping. <b>EFI_SECURITY_VIOLATION</b> : The close operation was failed because of IPsec policy check
<i>AbortOnClose</i>	Abort the TCP connection on close instead of the standard TCP close process when it is set to <b>TRUE</b> . This option can be used to satisfy a fast disconnect.

### Description

Initiate an asynchronous close token to TCP driver. After **Close()** is called, any buffered transmission data will be sent by TCP driver and the current instance will have a graceful close working flow described as RFC 793 if *AbortOnClose* is set to **FALSE**, otherwise, a

rest packet will be sent by TCP driver to fast disconnect this connection. When the close operation completes successfully the TCP instance is in *Tcp6StateClosed* state, all pending asynchronous operations are signaled and any buffers used for TCP network traffic are flushed.

## Status Codes Returned

EFI_SUCCESS	The <b>Close()</b> is called successfully.
EFI_NOT_STARTED	This EFI TCPv6 Protocol instance has not been configured.
EFI_ACCESS_DENIED	One or more of the following conditions are <b>TRUE</b> : <ul style="list-style-type: none"> <li>• <b>CloseToken</b> or <i>CloseToken-&gt;CompletionToken.Event</i> is already in use.</li> <li>• Previous <b>Close()</b> call on this instance has not finished.</li> </ul>
EFI_INVALID_PARAMETER	One or more of the following conditions are <b>TRUE</b> : <ul style="list-style-type: none"> <li>• <i>This</i> is <b>NULL</b>.</li> <li>• <i>CloseToken</i> is <b>NULL</b>.</li> <li>• <i>CloseToken-&gt;CompletionToken.Event</i> is <b>NULL</b>.</li> </ul>
EFI_OUT_OF_RESOURCES	Could not allocate enough resource to finish the operation.
EFI_DEVICE_ERROR	Any unexpected and not belonged to above category error.

## EFI\_TCP6\_PROTOCOL.Cancel()

### Summary

Abort an asynchronous connection, listen, transmission or receive request.

### Prototype

```
typedef
EFI_STATUS
(EFIAPI *EFI_TCP6_CANCEL)(
    IN EFI_TCP6_PROTOCOL *This,
    IN EFI_TCP6_COMPLETION_TOKEN *Token OPTIONAL
);
```

### Parameters

<i>This</i>	Pointer to the <b>EFI_TCP6_PROTOCOL</b> instance.
<i>Token</i>	Pointer to a token that has been issued by <b>EFI_TCP6_PROTOCOL.Connect()</b> , <b>EFI_TCP6_PROTOCOL.Accept()</b> , <b>EFI_TCP6_PROTOCOL.Transmit()</b> or <b>EFI_TCP6_PROTOCOL.Receive()</b> . If <b>NULL</b> , all pending tokens issued by above four functions will be aborted. Type <b>EFI_TCP6_COMPLETION_TOKEN</b> is defined in <b>EFI_TCP6_PROTOCOL.Connect()</b> .

### Description

The **Cancel()** function aborts a pending connection, listen, transmit or receive request. If *Token* is not **NULL** and the token is in the connection, listen, transmission or receive queue when it is being cancelled, its *Token->Status* will be set to **EFI\_ABORTED** and then *Token->Event* will be signaled. If the token is not in one of the queues, which usually means that the asynchronous operation has completed, **EFI\_NOT\_FOUND** is returned. If *Token* is **NULL** all asynchronous token issued by **Connect()**, **Accept()**, **Transmit()** and **Receive()** will be aborted.

### Status Codes Returned

EFI_SUCCESS	The asynchronous I/O request is aborted and <i>Token-&gt;Event</i> is signaled.
EFI_INVALID_PARAMETER	<i>This</i> is <b>NULL</b> .
EFI_NOT_STARTED	This instance hasn't been configured.
EFI_NOT_FOUND	The asynchronous I/O request isn't found in the transmission or receive queue. It has either completed or wasn't issued by <b>Transmit()</b> and <b>Receive()</b> .
EFI_UNSUPPORTED	The implementation does not support this function.

## EFI\_TCP6\_PROTOCOL.Poll()

### Summary

Poll to receive incoming data and transmit outgoing segments.

### Prototype

```
typedef
EFI_STATUS
(EFIAPI *EFI_TCP6_POLL) (
    IN EFI_TCP6_PROTOCOL *This
);
```

### Parameters

*This* Pointer to the **EFI\_TCP6\_PROTOCOL** instance.

### Description

The **Poll()** function increases the rate that data is moved between the network and application and can be called when the TCP instance is created successfully. Its use is optional.

In some implementations, the periodical timer in the MNP driver may not poll the underlying communications device fast enough to avoid drop packets. Drivers and applications that are experiencing packet loss should try calling the **Poll()** function in a high frequency.

### Status Codes Returned

EFI_SUCCESS	Incoming or outgoing data was processed.
EFI_INVALID_PARAMETER	<i>This</i> is <b>NULL</b> .
EFI_DEVICE_ERROR	An unexpected system or network error occurred.
EFI_NOT_READY	No incoming or outgoing data is processed.
EFI_TIMEOUT	Data was dropped out of the transmission or receive queue. Consider increasing the polling rate.

## 28.3 EFI IPv4 Protocol

This section defines the EFI IPv4 (Internet Protocol version 4) Protocol interface. It is split into the following three main sections:

- EFI IPv4 Service Binding Protocol
- EFI IPv4 Variable
- EFI IPv4 Protocol

The EFI IPv4 Protocol provides basic network IPv4 packet I/O services, which includes support for a subset of the Internet Control Message Protocol (ICMP) and may include support for the Internet Group Management Protocol (IGMP).

## 28.3.1 IP4 Service Binding Protocol

### EFI\_IP4\_SERVICE\_BINDING\_PROTOCOL

#### Summary

The EFI IPv4 Service Binding Protocol is used to locate communication devices that are supported by an EFI IPv4 Protocol driver and to create and destroy instances of the EFI IPv4 Protocol child protocol driver that can use the underlying communications device.

#### GUID

```
#define EFI_IP4_SERVICE_BINDING_PROTOCOL_GUID \
{0xc51711e7,0xb4bf,0x404a,\
{0xbf,0xb8,0x0a,0x04,0x8e,0xf1,0xff,0xe4}}
```

#### Description

A network application that requires basic IPv4 I/O services can use one of the protocol handler services, such as **BS->LocateHandleBuffer()**, to search for devices that publish an EFI IPv4 Service Binding Protocol GUID. Each device with a published EFI IPv4 Service Binding Protocol GUID supports the EFI IPv4 Protocol and may be available for use.

After a successful call to the **EFI\_IP4\_SERVICE\_BINDING\_PROTOCOL.CreateChild()** function, the newly created child EFI IPv4 Protocol driver is in an unconfigured state; it is not ready to send and receive data packets.

Before a network application terminates execution, every successful call to the **EFI\_IP4\_SERVICE\_BINDING\_PROTOCOL.CreateChild()** function must be matched with a call to the **EFI\_IP4\_SERVICE\_BINDING\_PROTOCOL.DestroyChild()** function.

## 28.3.2 IP4 Protocol

### EFI\_IP4\_PROTOCOL

#### Summary

The EFI IPv4 Protocol implements a simple packet-oriented interface that can be used by drivers, daemons, and applications to transmit and receive network packets.

## GUID

```
#define EFI_IP4_PROTOCOL_GUID \
{0x41d94cd2,0x35b6,0x455a,\
{0x82,0x58,0xd4,0xe5,0x13,0x34,0xaa,0xdd}}
```

## Protocol Interface Structure

```
typedef struct _EFI_IP4_PROTOCOL {
  EFI_IP4_GET_MODE_DATA  GetModeData;
  EFI_IP4_CONFIGURE      Configure;
  EFI_IP4_GROUPS         Groups;
  EFI_IP4_ROUTES         Routes;
  EFI_IP4_TRANSMIT       Transmit;
  EFI_IP4_RECEIVE        Receive;
  EFI_IP4_CANCEL         Cancel;
  EFI_IP4_POLL           Poll;
} EFI_IP4_PROTOCOL;
```

## Parameters

<i>GetModeData</i>	Gets the current operational settings for this instance of the EFI IPv4 Protocol driver. See the <b>GetModeData()</b> function description.
<i>Configure</i>	Changes or resets the operational settings for the EFI IPv4 Protocol. See the <b>Configure()</b> function description.
<i>Groups</i>	Joins and leaves multicast groups. See the <b>Groups()</b> function description.
<i>Routes</i>	Adds and deletes routing table entries. See the <b>Routes()</b> function description.
<i>Transmit</i>	Places outgoing data packets into the transmit queue. See the <b>Transmit()</b> function description.
<i>Receive</i>	Places a receiving request into the receiving queue. See the <b>Receive()</b> function description.
<i>Cancel</i>	Aborts a pending transmit or receive request. See the <b>Cancel()</b> function description.
<i>Poll</i>	Polls for incoming data packets and processes outgoing data packets. See the <b>Poll()</b> function description.

## Description

The **EFI\_IP4\_PROTOCOL** defines a set of simple IPv4, ICMPv4, and IGMPv4 services that can be used by any network protocol driver, daemon, or application to transmit and receive IPv4 data packets.

**Note:** All the IPv4 addresses that are described in **EFI\_IP4\_PROTOCOL** are stored in network byte order. Both incoming and outgoing IP packets are also in network byte order. All other parameters that are defined in functions or data structures are stored in host byte order.



## EFI\_IP4\_PROTOCOL.GetModeData()

### Summary

Gets the current operational settings for this instance of the EFI IPv4 Protocol driver.

### Prototype

```
typedef
EFI_STATUS
(EFI_API *EFI_IP4_GET_MODE_DATA) (
    IN EFI_IP4_PROTOCOL      *This,
    OUT EFI_IP4_MODE_DATA    *Ip4ModeData OPTIONAL,
    OUT EFI_MANAGED_NETWORK_CONFIG_DATA *MnpConfigData OPTIONAL,
    OUT EFI_SIMPLE_NETWORK_MODE *SnpModeData OPTIONAL
);
```

### Parameters

<i>This</i>	Pointer to the <b>EFI_IP4_PROTOCOL</b> instance.
<i>Ip4ModeData</i>	Pointer to the EFI IPv4 Protocol mode data structure. Type <b>EFI_IP4_MODE_DATA</b> is defined in “Related Definitions” below.
<i>MnpConfigData</i>	Pointer to the managed network configuration data structure. Type <b>EFI_MANAGED_NETWORK_CONFIG_DATA</b> is defined in <b>EFI_MANAGED_NETWORK_PROTOCOL.GetModeData()</b> .
<i>SnpData</i>	Pointer to the simple network mode data structure. Type <b>EFI_SIMPLE_NETWORK_MODE</b> is defined in the <b>EFI_SIMPLE_NETWORK_PROTOCOL</b> .

### Description

The **GetModeData()** function returns the current operational mode data for this driver instance. The data fields in **EFI\_IP4\_MODE\_DATA** are read only. This function is used optionally to retrieve the operational mode data of underlying networks or drivers.

## Related Definitions

```

//*****
// EFI_IP4_MODE_DATA
//*****
typedef struct {
    BOOLEAN    IsStarted;
    UINT32     MaxPacketSize;
    EFI_IP4_CONFIG_DATA ConfigData;
    BOOLEAN    IsConfigured;
    UINT32     GroupCount;
    EFI_IPv4_ADDRESS *GroupTable;
    UINT32     RouteCount;
    EFI_IP4_ROUTE_TABLE *RouteTable;
    UINT32     IcmpTypeCount;
    EFI_IP4_ICMP_TYPE *IcmpTypeList;
} EFI_IP4_MODE_DATA;

```

<i>IsStarted</i>	Set to <b>TRUE</b> after this EFI IPv4 Protocol instance has been successfully configured with operational parameters by calling the <b>Configure()</b> interface when EFI IPv4 Protocol instance is stopped All other fields in this structure are undefined until this field is <b>TRUE</b> . Set to <b>FALSE</b> when the instance's operational parameter has been reset.
<i>MaxPacckeSize</i>	The maximum packet size, in bytes, of the packet which the upper layer driver could feed.
<i>ConfigData</i>	Current configuration settings. Undefined until <i>IsStarted</i> is <b>TRUE</b> . Type <b>EFI_IP4_CONFIG_DATA</b> is defined below.
<i>IsConfigured</i>	Set to <b>TRUE</b> when the EFI IPv4 Protocol instance has a station address and subnet mask. If it is using the default address, the default address has been acquired. Set to <b>FALSE</b> when the EFI IPv4 Protocol driver is not configured.
<i>GroupCount</i>	Number of joined multicast groups. Undefined until <i>IsConfigured</i> is <b>TRUE</b> .
<i>GroupTable</i>	List of joined multicast group addresses. Undefined until <i>IsConfigured</i> is <b>TRUE</b> .
<i>RouteCount</i>	Number of entries in the routing table. Undefined until <i>IsConfigured</i> is <b>TRUE</b> .
<i>RouteTable</i>	Routing table entries. Undefined until <i>IsConfigured</i> is <b>TRUE</b> . Type <b>EFI_IP4_ROUTE_TABLE</b> is defined below.
<i>IcmpTypeCount</i>	Number of entries in the supported ICMP types list.
<i>IcmpTypeList</i>	Array of ICMP types and codes that are supported by this EFI IPv4 Protocol driver. Type <b>EFI_IP4_ICMP_TYPE</b> is defined below.

The **EFI\_IP4\_MODE\_DATA** structure describes the operational state of this IPv4 interface.

```

//*****
// EFI_IP4_CONFIG_DATA
//*****
typedef struct {
    UINT8    DefaultProtocol;
    BOOLEAN  AcceptAnyProtocol;
    BOOLEAN  AcceptIcmpErrors;
    BOOLEAN  AcceptBroadcast;
    BOOLEAN  AcceptPromiscuous;
    BOOLEAN  UseDefaultAddress;
    EFI_IPv4_ADDRESS StationAddress;
    EFI_IPv4_ADDRESS SubnetMask;
    UINT8    TypeOfService;
    UINT8    TimeToLive;
    BOOLEAN  DoNotFragment;
    BOOLEAN  RawData;
    UINT32   ReceiveTimeout;
    UINT32   TransmitTimeout;
} EFI_IP4_CONFIG_DATA;

```

<i>DefaultProtocol</i>	The default IPv4 protocol packets to send and receive. Ignored when <i>AcceptPromiscuous</i> is <b>TRUE</b> . An updated list of protocol numbers can be found at “Links to UEFI-Related Documents” ( <a href="http://uefi.org/uefi">http://uefi.org/uefi</a> ) under the heading “IANA Assigned Internet Protocol Numbers list”.
<i>AcceptAnyProtocol</i>	Set to <b>TRUE</b> to receive all IPv4 packets that get through the receive filters. Set to <b>FALSE</b> to receive only the <i>DefaultProtocol</i> IPv4 packets that get through the receive filters. Ignored when <i>AcceptPromiscuous</i> is <b>TRUE</b> .
<i>AcceptIcmpErrors</i>	Set to <b>TRUE</b> to receive ICMP error report packets. Ignored when <i>AcceptPromiscuous</i> or <i>AcceptAnyProtocol</i> is <b>TRUE</b> .
<i>AcceptBroadcast</i>	Set to <b>TRUE</b> to receive broadcast IPv4 packets. Ignored when <i>AcceptPromiscuous</i> is <b>TRUE</b> . Set to <b>FALSE</b> to stop receiving broadcast IPv4 packets.
<i>AcceptPromiscuous</i>	Set to <b>TRUE</b> to receive all IPv4 packets that are sent to any hardware address or any protocol address. Set to <b>FALSE</b> to stop receiving all promiscuous IPv4 packets.
<i>UseDefaultAddress</i>	Set to <b>TRUE</b> to use the default IPv4 address and default routing table. If the default IPv4 address is not available yet, then the EFI IPv4 Protocol driver will use <b>EFI_IP4_CONFIG2_PROTOCOL</b> to retrieve the IPv4

address and subnet information. (This field can be set and changed only when the EFI IPv4 driver is transitioning from the stopped to the started states.)

*StationAddress*

The station IPv4 address that will be assigned to this EFI IPv4Protocol instance. The EFI IPv4 Protocol driver will deliver only incoming IPv4 packets whose destination matches this IPv4 address exactly. Address 0.0.0.0 is also accepted as a special case in which incoming packets destined to any station IP address are always delivered. When **EFI\_IP4\_CONFIG\_DATA** is used in **Configure ()**, it is ignored if *UseDefaultAddress* is **TRUE**; When **EFI\_IP4\_CONFIG\_DATA** is used in **GetModeData ()**, it contains the default address if *UseDefaultAddress* is **TRUE** and the default address has been acquired.

*SubnetMask*

The subnet address mask that is associated with the station address. When **EFI\_IP4\_CONFIG\_DATA** is used in **Configure ()**, it is ignored if *UseDefaultAddress* is **TRUE**; When **EFI\_IP4\_CONFIG\_DATA** is used in **GetModeData ()**, it contains the default subnet mask if *UseDefaultAddress* is **TRUE** and the default address has been acquired.

*TypeOfService*

*TypeOfService* field in transmitted IPv4 packets.

*TimeToLive*

*TimeToLive* field in transmitted IPv4 packets.

*DoNotFragment*

State of the *DoNotFragment* bit in transmitted IPv4 packets.

*RawData*

Set to **TRUE** to send and receive unformatted packets. The other IPv4 receive filters are still applied. Fragmentation is disabled for *RawData* mode. NOTE: Unformatted packets include the IP header and payload. The media header is appended automatically for outgoing packets by underlying network drivers.

*ReceiveTimeout*

The timer timeout value (number of microseconds) for the receive timeout event to be associated with each assembled packet. Zero means do not drop assembled packets.

*TransmitTimeout*

The timer timeout value (number of microseconds) for the transmit timeout event to be associated with each outgoing packet. Zero means do not drop outgoing packets.

The **EFI\_IP4\_CONFIG\_DATA** structure is used to report and change IPv4 session parameters.

```

//*****
// EFI_IP4_ROUTE_TABLE
//*****
typedef struct {
  EFI_IPv4_ADDRESS  SubnetAddress;
  EFI_IPv4_ADDRESS  SubnetMask;
  EFI_IPv4_ADDRESS  GatewayAddress;
} EFI_IP4_ROUTE_TABLE;

```

*SubnetAddress*            The subnet address to be routed.

*SubnetMask*             The subnet mask. If (*DestinationAddress & SubnetMask == SubnetAddress*), then the packet is to be directed to the *GatewayAddress*.

*GatewayAddress*         The IPv4 address of the gateway that redirects packets to this subnet. If the IPv4 address is 0.0.0.0, then packets to this subnet are not redirected.

**EFI\_IP4\_ROUTE\_TABLE** is the entry structure that is used in routing tables.

```

//*****
// EFI_IP4_ICMP_TYPE
//*****
typedef struct {
  UINT8   Type;
  UINT8   Code;
} EFI_IP4_ICMP_TYPE

```

*Type*                    The type of ICMP message. See RFC 792 and RFC 950.

*Code*                    The code of the ICMP message, which further describes the different ICMP message formats under the same *Type*. See RFC 792 and RFC 950.

**EFI\_IP4\_ICMP\_TYPE** is used to describe those ICMP messages that are supported by this EFI IPv4 Protocol driver.

## Status Codes Returned

EFI_SUCCESS	The operation completed successfully.
EFI_INVALID_PARAMETER	<i>This is NULL.</i>
EFI_OUT_OF_RESOURCES	The required mode data could not be allocated.

## EFI\_IP4\_PROTOCOL.Configure()

### Summary

Assigns an IPv4 address and subnet mask to this EFI IPv4 Protocol driver instance.

### Prototype

```
typedef
EFI_STATUS
(EFIAPI *EFI_IP4_CONFIGURE) (
    IN EFI_IP4_PROTOCOL  *This,
    IN EFI_IP4_CONFIG_DATA *IpConfigData OPTIONAL
);
```

### Parameters

<i>This</i>	Pointer to the <b>EFI_IP4_PROTOCOL</b> instance.
<i>IpConfigData</i>	Pointer to the EFI IPv4 Protocol configuration data structure. Type <b>EFI_IP4_CONFIG_DATA</b> is defined in <b>EFI_IP4_PROTOCOL.GetModeData()</b> .

### Description

The **Configure()** function is used to set, change, or reset the operational parameters and filter settings for this EFI IPv4 Protocol instance. Until these parameters have been set, no network traffic can be sent or received by this instance. Once the parameters have been reset (by calling this function with *IpConfigData* set to **NULL**), no more traffic can be sent or received until these parameters have been set again. Each EFI IPv4 Protocol instance can be started and stopped independently of each other by enabling or disabling their receive filter settings with the **Configure()** function.

When *IpConfigData.UseDefaultAddress* is set to **FALSE**, the new station address will be appended as an alias address into the addresses list in the EFI IPv4 Protocol driver. While set to **TRUE**, **Configure()** will trigger the **EFI\_IP4\_CONFIG2\_PROTOCOL** to retrieve the default IPv4 address if it is not available yet. Clients could frequently call **GetModeData()** to check the status to ensure that the default IPv4 address is ready.

If operational parameters are reset or changed, any pending transmit and receive requests will be cancelled. Their completion token status will be set to **EFI\_ABORTED** and their events will be signaled.

### Status Codes Returned

EFI_SUCCESS	The driver instance was successfully opened.
EFI_NO_MAPPING	When using the default address, configuration (DHCP, BOOTP, RARP, etc.) is not finished yet.
EFI_IP_ADDRESS_CONFLICT	There is an address conflict in response to the Arp invocation

EFI_INVALID_PARAMETER	<p>One or more of the following conditions is <b>TRUE</b>:</p> <ul style="list-style-type: none"> <li>• <i>This</i> is <b>NULL</b>.</li> <li>• <i>IpConfigData.StationAddress</i> is not a unicast IPv4 address.</li> <li>• <i>IpConfigData.SubnetMask</i> is not a valid IPv4 subnet mask.</li> </ul>
EFI_UNSUPPORTED	<p>One or more of the following conditions is <b>TRUE</b>:</p> <ul style="list-style-type: none"> <li>• A configuration protocol (DHCP, BOOTP, RARP, etc.) could not be located when clients choose to use the default IPv4 address. This EFI IPv4 Protocol implementation does not support this requested filter or timeout setting.</li> </ul>
EFI_OUT_OF_RESOURCES	The EFI IPv4 Protocol driver instance data could not be allocated.
EFI_ALREADY_STARTED	The interface is already open and must be stopped before the IPv4 address or subnet mask can be changed. The interface must also be stopped when switching to/from raw packet mode.
EFI_DEVICE_ERROR	An unexpected system or network error occurred. The EFI IPv4 Protocol driver instance is not opened.

## EFI\_IP4\_PROTOCOL.Groups()

### Summary

Joins and leaves multicast groups.

### Prototype

```
typedef
EFI_STATUS
(EFI_API *EFI_IP4_GROUPS) (
  IN EFI_IP4_PROTOCOL *This,
  IN BOOLEAN JoinFlag,
  IN EFI_IPv4_ADDRESS *GroupAddress OPTIONAL
);
```

### Parameters

<i>This</i>	Pointer to the <b>EFI_IP4_PROTOCOL</b> instance.
<i>JoinFlag</i>	Set to <b>TRUE</b> to join the multicast group session and <b>FALSE</b> to leave.
<i>GroupAddress</i>	Pointer to the IPv4 multicast address.

### Description

The **Groups()** function is used to join and leave multicast group sessions. Joining a group will enable reception of matching multicast packets. Leaving a group will disable the multicast packet reception.

If *JoinFlag* is **FALSE** and *GroupAddress* is **NULL**, all joined groups will be left.

### Status Codes Returned

EFI_SUCCESS	The operation completed successfully.
EFI_INVALID_PARAMETER	One or more of the following is <b>TRUE</b> : <ul style="list-style-type: none"> <li><i>This</i> is <b>NULL</b>.</li> <li><i>JoinFlag</i> is <b>TRUE</b> and <i>GroupAddress</i> is <b>NULL</b>.</li> <li><i>GroupAddress</i> is not <b>NULL</b> and <i>*GroupAddress</i> is not a multicast IPv4 address.</li> </ul>
EFI_NOT_STARTED	This instance has not been started.
EFI_NO_MAPPING	When using the default address, configuration (DHCP, BOOTP, RARP, etc.) is not finished yet.
EFI_OUT_OF_RESOURCES	System resources could not be allocated.
EFI_UNSUPPORTED	This EFI IPv4 Protocol implementation does not support multicast groups.
EFI_ALREADY_STARTED	The group address is already in the group table (when <i>JoinFlag</i> is <b>TRUE</b> ).
EFI_NOT_FOUND	The group address is not in the group table (when <i>JoinFlag</i> is <b>FALSE</b> ).



EFI_DEVICE_ERROR	An unexpected system or network error occurred.
------------------	---

## EFI\_IP4\_PROTOCOL.Routes()

### Summary

Adds and deletes routing table entries.

### Prototype

```
typedef
EFI_STATUS
(EFI_API *EFI_IP4_ROUTES) (
  IN EFI_IP4_PROTOCOL *This,
  IN BOOLEAN DeleteRoute,
  IN EFI_IPv4_ADDRESS *SubnetAddress,
  IN EFI_IPv4_ADDRESS *SubnetMask,
  IN EFI_IPv4_ADDRESS *GatewayAddress
);
```

### Parameters

<i>This</i>	Pointer to the <b>EFI_IP4_PROTOCOL</b> instance.
<i>DeleteRoute</i>	Set to <b>TRUE</b> to delete this route from the routing table. Set to <b>FALSE</b> to add this route to the routing table. <i>SubnetAddress</i> and <i>SubnetMask</i> are used as the key to each route entry.
<i>SubnetAddress</i>	The address of the subnet that needs to be routed.
<i>SubnetMask</i>	The subnet mask of <i>SubnetAddress</i> .
<i>GatewayAddress</i>	The unicast gateway IPv4 address for this route.

### Description

The **Routes()** function adds a route to or deletes a route from the routing table.

Routes are determined by comparing the *SubnetAddress* with the destination IPv4 address arithmetically **AND**-ed with the *SubnetMask*. The gateway address must be on the same subnet as the configured station address.

The default route is added with *SubnetAddress* and *SubnetMask* both set to 0.0.0.0. The default route matches all destination IPv4 addresses that do not match any other routes.

A *GatewayAddress* that is zero is a nonroute. Packets are sent to the destination IP address if it can be found in the ARP cache or on the local subnet. One automatic nonroute entry will be inserted into the routing table for outgoing packets that are addressed to a local subnet (gateway address of 0.0.0.0).

Each EFI IPv4 Protocol instance has its own independent routing table. Those EFI IPv4 Protocol instances that use the default IPv4 address will also have copies of the routing table that was provided by the **EFI\_IP4\_CONFIG2\_PROTOCOL**, and these copies will be updated whenever the EIF IPv4 Protocol driver reconfigures its instances. As a result, client modification to the routing table will be lost.

**Note:** *There is no way to set up routes to other network interface cards because each network interface card has its own independent network stack that shares information only through **EFI IPv4 variable**.*

### Status Codes Returned

EFI_SUCCESS	The operation completed successfully.
EFI_NOT_STARTED	The driver instance has not been started.
EFI_NO_MAPPING	When using the default address, configuration (DHCP, BOOTP, RARP, etc.) is not finished yet.
EFI_INVALID_PARAMETER	One or more of the following conditions is <b>TRUE</b> : <ul style="list-style-type: none"> <li>• <i>This</i> is <b>NULL</b>.</li> <li>• <i>SubnetAddress</i> is <b>NULL</b>.</li> <li>• <i>SubnetMask</i> is <b>NULL</b>.</li> <li>• <i>GatewayAddress</i> is <b>NULL</b>.</li> <li>• <i>*SubnetAddress</i> is not a valid subnet address.</li> <li>• <i>*SubnetMask</i> is not a valid subnet mask.</li> <li>• <i>*GatewayAddress</i> is not a valid unicast IPv4 address.</li> </ul>
EFI_OUT_OF_RESOURCES	Could not add the entry to the routing table.
EFI_NOT_FOUND	This route is not in the routing table (when <i>DeleteRoute</i> is <b>TRUE</b> ).
EFI_ACCESS_DENIED	The route is already defined in the routing table (when <i>DeleteRoute</i> is <b>FALSE</b> ).

## EFI\_IP4\_PROTOCOL.Transmit()

### Summary

Places outgoing data packets into the transmit queue.

### Prototype

```
typedef
EFI_STATUS
(EFI_API *EFI_IP4_TRANSMIT) (
  IN EFI_IP4_PROTOCOL  *This,
  IN EFI_IP4_COMPLETION_TOKEN *Token
);
```

### Parameters

<i>This</i>	Pointer to the <b>EFI_IP4_PROTOCOL</b> instance.
<i>Token</i>	Pointer to the transmit token. Type <b>EFI_IP4_COMPLETION_TOKEN</b> is defined in “Related Definitions” below.

### Description

The **Transmit()** function places a sending request in the transmit queue of this EFI IPv4 Protocol instance. Whenever the packet in the token is sent out or some errors occur, the event in the token will be signaled and the status is updated.

### Related Definitions

```
/**
//*****
// EFI_IP4_COMPLETION_TOKEN
//*****
typedef struct {
  EFI_EVENT      Event;
  EFI_STATUS     Status;
  union {
    EFI_IP4_RECEIVE_DATA  *RxData;
    EFI_IP4_TRANSMIT_DATA *TxData;
  } Packet;
} EFI_IP4_COMPLETION_TOKEN;
```

<i>Event</i>	This <i>Event</i> will be signaled after the <i>Status</i> field is updated by the EFI IPv4 Protocol driver. The type of <i>Event</i> must be <b>EFI_NOTIFY_SIGNAL</b> . The Task Priority Level (TPL) of <i>Event</i> must be lower than or equal to <b>TPL_CALLBACK</b> .
--------------	---

<i>Status</i>	Will be set to one of the following values: <b>EFI_SUCCESS</b> . The receive or transmit completed successfully. <b>EFI_ABORTED</b> . The receive or transmit was aborted.
---------------	--

**EFI\_TIMEOUT.** The transmit timeout expired.

**EFI\_ICMP\_ERROR.** An ICMP error packet was received.

**EFI\_DEVICE\_ERROR.** An unexpected system or network error occurred.

**EFI\_NO\_MEDIA.** There was a media error

*RxData*

When this token is used for receiving, *RxData* is a pointer to the **EFI\_IP4\_RECEIVE\_DATA**. Type **EFI\_IP4\_RECEIVE\_DATA** is defined below.

*TxData*

When this token is used for transmitting, *TxData* is a pointer to the **EFI\_IP4\_TRANSMIT\_DATA**. Type **EFI\_IP4\_TRANSMIT\_DATA** is defined below.

**EFI\_IP4\_COMPLETION\_TOKEN** structures are used for both transmit and receive operations.

When the structure is used for transmitting, the *Event* and *TxData* fields must be filled in by the EFI IPv4 Protocol client. After the transmit operation completes, EFI IPv4 Protocol updates the *Status* field and the *Event* is signaled.

When the structure is used for receiving, only the **Event** field must be filled in by the EFI IPv4 Protocol client. After a packet is received, the EFI IPv4 Protocol fills in the **RxData** and **Status** fields and the **Event** is signaled. If the packet is an ICMP error message, the **Status** is set to **EFI\_ICMP\_ERROR**, and the packet is delivered up as usual. The protocol from the IP head in the ICMP error message is used to de-multiplex the packet.

```

//*****
// EFI_IP4_RECEIVE_DATA
//*****
typedef struct {
    EFI_TIME    TimeStamp;
    EFI_EVENT   RecycleSignal;
    UINT32     HeaderLength;
    EFI_IP4_HEADER *Header;
    UINT32     OptionsLength;
    VOID       *Options;
    UINT32     DataLength;
    UINT32     FragmentCount;
    EFI_IP4_FRAGMENT_DATA FragmentTable[1];
} EFI_IP4_RECEIVE_DATA;

```

*TimeStamp*

Time when the EFI IPv4 Protocol driver accepted the packet. *TimeStamp* is zero filled if receive timestamps are disabled or unsupported.

*RecycleSignal*

After this event is signaled, the receive data structure is released and must not be referenced.

*HeaderLength*

Length of the IPv4 packet header. Zero if *ConfigData.RawData* is **TRUE**.

<i>Header</i>	Pointer to the IPv4 packet header. If the IPv4 packet was fragmented, this argument is a pointer to the header in the first fragment. <b>NULL</b> if <i>ConfigData.RawData</i> is <b>TRUE</b> . Type <b>EFI_IP4_HEADER</b> is defined below.
<i>OptionsLength</i>	Length of the IPv4 packet header options. May be zero.
<i>Options</i>	Pointer to the IPv4 packet header options. If the IPv4 packet was fragmented, this argument is a pointer to the options in the first fragment. May be <b>NULL</b> .
<i>DataLength</i>	Sum of the lengths of IPv4 packet buffers in <i>FragmentTable</i> . May be zero.
<i>FragmentCount</i>	Number of IPv4 payload (or raw) fragments. If <i>ConfigData.RawData</i> is <b>TRUE</b> , this count is the number of raw IPv4 fragments received so far. May be zero.
<i>FragmentTable</i>	Array of payload (or raw) fragment lengths and buffer pointers. If <i>ConfigData.RawData</i> is <b>TRUE</b> , each buffer points to a raw IPv4 fragment and thus IPv4 header and options are included in each buffer. Otherwise, IPv4 headers and options are not included in these buffers. Type <b>EFI_IP4_FRAGMENT_DATA</b> is defined below.

The EFI IPv4 Protocol receive data structure is filled in when IPv4 packets have been assembled (or when raw packets have been received). In the case of IPv4 packet assembly, the individual packet fragments are only verified and are not reorganized into a single linear buffer.

The *FragmentTable* contains a sorted list of zero or more packet fragment descriptors. The referenced packet fragments may not be in contiguous memory locations.

```

//*****
// EFI_IP4_HEADER
//*****
#pragma pack(1)
typedef struct {
    UINT8    HeaderLength:4;
    UINT8    Version:4;
    UINT8    TypeOfService;
    UINT16   TotalLength;
    UINT16   Identification;
    UINT16   Fragmentation;
    UINT8    TimeToLive;
    UINT8    Protocol;
    UINT16   Checksum;
    EFI_IPv4_ADDRESS SourceAddress;
    EFI_IPv4_ADDRESS DestinationAddress;
} EFI_IP4_HEADER;
#pragma pack()

```

The fields in the IPv4 header structure are defined in the Internet Protocol version 4 specification, which can be found at “Links to UEFI-Related Documents” (<http://uefi.org/uefi>) under the heading “Internet Protocol version 4 Specification”.

```

//*****
// EFI_IP4_FRAGMENT_DATA
//*****
typedef struct {
    UINT32  FragmentLength;
    VOID    *FragmentBuffer;
} EFI_IP4_FRAGMENT_DATA;

```

<i>FragmentLength</i>	Length of fragment data. This field may not be set to zero.
<i>FragmentBuffer</i>	Pointer to fragment data. This field may not be set to <b>NULL</b> .

The **EFI\_IP4\_FRAGMENT\_DATA** structure describes the location and length of the IPv4 packet fragment to transmit or that has been received.

```

//*****
// EFI_IP4_TRANSMIT_DATA
//*****
typedef struct {
    EFI_IPv4_ADDRESS  DestinationAddress;
    EFI_IP4_OVERRIDE_DATA *OverrideData;
    UINT32            OptionsLength;
    VOID              *OptionsBuffer;
    UINT32            TotalDataLength;
    UINT32            FragmentCount;
    EFI_IP4_FRAGMENT_DATA FragmentTable[1];
} EFI_IP4_TRANSMIT_DATA;

```

<i>DestinationAddress</i>	The destination IPv4 address. Ignored if <i>RawData</i> is <b>TRUE</b> .
<i>OverrideData</i>	If not <b>NULL</b> , the IPv4 transmission control override data. Ignored if <i>RawData</i> is <b>TRUE</b> . Type <b>EFI_IP4_OVERRIDE_DATA</b> is defined below.
<i>OptionsLength</i>	Length of the IPv4 header options data. Must be zero if the IPv4 driver does not support IPv4 options. Ignored if <i>RawData</i> is <b>TRUE</b> .
<i>OptionsBuffer</i>	Pointer to the IPv4 header options data. Ignored if <i>OptionsLength</i> is zero. Ignored if <i>RawData</i> is <b>TRUE</b> .
<i>TotalDataLength</i>	Total length of the <i>FragmentTable</i> data to transmit.
<i>FragmentCount</i>	Number of entries in the fragment data table.
<i>FragmentTable</i>	Start of the fragment data table. Type <b>EFI_IP4_FRAGMENT_DATA</b> is defined above.

The **EFI\_IP4\_TRANSMIT\_DATA** structure describes a possibly fragmented packet to be transmitted.

```

//*****
// EFI_IP4_OVERRIDE_DATA
//*****
typedef struct {
    EFI_IPv4_ADDRESS  SourceAddress;
    EFI_IPv4_ADDRESS  GatewayAddress;
    UINT8             Protocol;
    UINT8             TypeOfService;
    UINT8             TimeToLive;
    BOOLEAN           DoNotFragment;
} EFI_IP4_OVERRIDE_DATA;
    
```

- SourceAddress*                      Source address override.
- GatewayAddress*                    Gateway address to override the one selected from the routing table. This address must be on the same subnet as this station address. If set to 0.0.0.0, the gateway address selected from routing table will not be overridden.
- Protocol*                            Protocol type override.
- TypeOfService*                      Type-of-service override.
- TimeToLive*                         Time-to-live override.
- DoNotFragment*                    Do-not-fragment override.

The information and flags in the override data structure will override default parameters or settings for one **Transmit()** function call.

### Status Codes Returned

EFI_SUCCESS	The data has been queued for transmission.
EFI_NOT_STARTED	This instance has not been started.
EFI_NO_MAPPING	When using the default address, configuration (DHCP, BOOTP, RARP, etc.) is not finished yet.



EFI_INVALID_PARAMETER	<p>One or more of the following is <b>TRUE</b>:</p> <ul style="list-style-type: none"> <li>• <i>This</i> is <b>NULL</b>.</li> <li>• <i>Token</i> is <b>NULL</b>.</li> <li>• <i>Token.Event</i> is <b>NULL</b>.</li> <li>• <i>Token.Packet.TxData</i> is <b>NULL</b>.</li> <li>• <i>Token.Packet.TxData.OverrideData.GatewayAddress</i> in the override data structure is not a unicast IPv4 address if <i>OverrideData</i> is not <b>NULL</b>.</li> <li>• <i>Token.Packet.TxData.OverrideData.SourceAddress</i> is not a unicast IPv4 address if <i>OverrideData</i> is not <b>NULL</b>.</li> <li>• <i>Token.Packet.OptionsLength</i> is not zero and <i>Token.Packet.OptionsBuffer</i> is <b>NULL</b>.</li> <li>• <i>Token.Packet.FragmentCount</i> is zero.</li> <li>• One or more of the <i>Token.Packet.TxData.FragmentTable[]</i>. <i>FragmentLength</i> fields is zero.</li> <li>• One or more of the <i>Token.Packet.TxData.FragmentTable[]</i>. <i>FragmentBuffer</i> fields is <b>NULL</b>.</li> <li>• <i>Token.Packet.TxData.TotalDataLength</i> is zero or not equal to the sum of fragment lengths.</li> <li>• The IP header in <i>FragmentTable</i> is not a well-formed header when <i>RawData</i> is <b>TRUE</b>.</li> </ul>
EFI_ACCESS_DENIED	The transmit completion token with the same <i>Token.Event</i> was already in the transmit queue.
EFI_NOT_READY	The completion token could not be queued because the transmit queue is full.
EFI_NOT_FOUND	Not route is found to destination address.
EFI_OUT_OF_RESOURCES	Could not queue the transmit data.
EFI_BUFFER_TOO_SMALL	<i>Token.Packet.TxData.TotalDataLength</i> is too short to transmit.
EFI_BAD_BUFFER_SIZE	The length of the IPv4 header + option length + total data length is greater than MTU (or greater than the maximum packet size if <i>Token.Packet.TxData.OverrideData.DoNotFragment</i> is <b>TRUE</b> .)
EFI_NO_MEDIA	There was a media error.

## EFI\_IP4\_PROTOCOL.Receive()

### Summary

Places a receiving request into the receiving queue.

### Prototype

```
typedef
EFI_STATUS
(EFI_API *EFI_IP4_RECEIVE) (
    IN EFI_IP4_PROTOCOL *This,
    IN EFI_IP4_COMPLETION_TOKEN *Token
);
```

### Parameters

<i>This</i>	Pointer to the <b>EFI_IP4_PROTOCOL</b> instance.
<i>Token</i>	Pointer to a token that is associated with the receive data descriptor. Type <b>EFI_IP4_COMPLETION_TOKEN</b> is defined in “Related Definitions” of above <b>Transmit()</b> .

### Description

The **Receive()** function places a completion token into the receive packet queue. This function is always asynchronous.

The *Token.Event* field in the completion token must be filled in by the caller and cannot be **NULL**. When the receive operation completes, the EFI IPv4 Protocol driver updates the *Token.Status* and *Token.Packet.RxData* fields and the *Token.Event* is signaled.

### Status Codes Returned

EFI_SUCCESS	The receive completion token was cached.
EFI_NOT_STARTED	This EFI IPv4 Protocol instance has not been started.
EFI_NO_MAPPING	When using the default address, configuration (DHCP, BOOTP, RARP, etc.) is not finished yet.
EFI_INVALID_PARAMETER	One or more of the following conditions is <b>TRUE</b> : <ul style="list-style-type: none"> <li>• <i>This</i> is <b>NULL</b>.</li> <li>• <i>Token</i> is <b>NULL</b>.</li> <li>• <i>Token.Event</i> is <b>NULL</b>.</li> </ul>
EFI_OUT_OF_RESOURCES	The receive completion token could not be queued due to a lack of system resources (usually memory).
EFI_DEVICE_ERROR	An unexpected system or network error occurred. The EFI IPv4 Protocol instance has been reset to startup defaults.
EFI_ACCESS_DENIED	The receive completion token with the same <i>Token.Event</i> was already in the receive queue.
EFI_NOT_READY	The receive request could not be queued because the receive queue is full.

EFI_ICMP_ERROR	An ICMP error packet was received.
EFI_NO_MEDIA	There was a media error.

## EFI\_IP4\_PROTOCOL.Cancel()

### Summary

Abort an asynchronous transmit or receive request.

### Prototype

```
typedef
EFI_STATUS
(EFI_API *EFI_IP4_CANCEL)(
  IN EFI_IP4_PROTOCOL *This,
  IN EFI_IP4_COMPLETION_TOKEN *Token OPTIONAL
);
```

### Parameters

*This* Pointer to the **EFI\_IP4\_PROTOCOL** instance.

*Token* Pointer to a token that has been issued by **EFI\_IP4\_PROTOCOL.Transmit()** or **EFI\_IP4\_PROTOCOL.Receive()**. If **NULL**, all pending tokens are aborted. Type **EFI\_IP4\_COMPLETION\_TOKEN** is defined in **EFI\_IP4\_PROTOCOL.Transmit()**.

### Description

The **Cancel()** function is used to abort a pending transmit or receive request. If the token is in the transmit or receive request queues, after calling this function, *Token->Status* will be set to **EFI\_ABORTED** and then *Token->Event* will be signaled. If the token is not in one of the queues, which usually means the asynchronous operation has completed, this function will not signal the token and **EFI\_NOT\_FOUND** is returned.

### Status Codes Returned

EFI_SUCCESS	The asynchronous I/O request was aborted and <i>Token-&gt;Event</i> was signaled. When <i>Token</i> is <b>NULL</b> , all pending requests were aborted and their events were signaled.
EFI_INVALID_PARAMETER	<i>This</i> is <b>NULL</b> .
EFI_NOT_STARTED	This instance has not been started.
EFI_NO_MAPPING	When using the default address, configuration (DHCP, BOOTP, RARP, etc.) is not finished yet.
EFI_NOT_FOUND	When <i>Token</i> is not <b>NULL</b> , the asynchronous I/O request was not found in the transmit or receive queue. It has either completed or was not issued by <b>Transmit()</b> and <b>Receive()</b> .

## EFI\_IP4\_PROTOCOL.Poll()

### Summary

Polls for incoming data packets and processes outgoing data packets.

### Prototype

```
typedef
EFI_STATUS
(EFI_API *EFI_IP4_POLL) (
    IN EFI_IP4_PROTOCOL *This
);
```

### Parameters

*This* Pointer to the **EFI\_IP4\_PROTOCOL** instance.

### Description

The **Poll()** function polls for incoming data packets and processes outgoing data packets. Network drivers and applications can call the **EFI\_IP4\_PROTOCOL.Poll()** function to increase the rate that data packets are moved between the communications device and the transmit and receive queues.

In some systems the periodic timer event may not poll the underlying communications device fast enough to transmit and/or receive all data packets without missing incoming packets or dropping outgoing packets. Drivers and applications that are experiencing packet loss should try calling the **EFI\_IP4\_PROTOCOL.Poll()** function more often.

### Status Codes Returned

EFI_SUCCESS	Incoming or outgoing data was processed.
EFI_NOT_STARTED	This EFI IPv4 Protocol instance has not been started.
EFI_INVALID_PARAMETER	<i>This</i> is <b>NULL</b> .
EFI_DEVICE_ERROR	An unexpected system or network error occurred.
EFI_NOT_READY	No incoming or outgoing data is processed.
EFI_TIMEOUT	Data was dropped out of the transmit and/or receive queue. Consider increasing the polling rate.

## 28.4 EFI IPv4 Configuration Protocol

This section provides a detailed description of the EFI IPv4 Configuration Protocol.

**IMPORTANT NOTICE:** The **EFI\_IP4\_CONFIG\_PROTOCOL** has been replaced with the new **EFI\_IP4\_CONFIG2\_PROTOCOL**.

- All new designs based on this specification should exclusively use [EFI\\_IP4\\_CONFIG2\\_PROTOCOL](#).
- The **EFI\_IP4\_CONFIG\_PROTOCOL** will be removed in the next revision of this specification.

## EFI\_IP4\_CONFIG\_PROTOCOL

**IMPORTANT NOTICE:** The **EFI\_IP4\_CONFIG\_PROTOCOL** has been replaced with the new **EFI\_IP4\_CONFIG2\_PROTOCOL**.

- All new designs based on this specification should exclusively use [EFI\\_IP4\\_CONFIG2\\_PROTOCOL](#).
- The **EFI\_IP4\_CONFIG\_PROTOCOL** will be removed in the next revision of this specification.

### Summary

The **EFI\_IP4\_CONFIG\_PROTOCOL** driver performs platform- and policy-dependent configuration for the EFI IPv4 Protocol driver.

### GUID

```
#define EFI_IP4_CONFIG_PROTOCOL_GUID \
  {0x3b95aa31,0x3793,0x434b,\
   {0x86,0x67,0xc8,0x07,0x08,0x92,0xe0,0x5e}}
```

### Protocol Interface Structure

```
typedef struct _EFI_IP4_CONFIG_PROTOCOL {
  EFI_IP4_CONFIG_START  Start;
  EFI_IP4_CONFIG_STOP   Stop;
  EFI_IP4_CONFIG_GET_DATA  GetData;
} EFI_IP4_CONFIG_PROTOCOL;
```

### Parameters

<i>Start</i>	Starts running the configuration policy for the EFI IPv4 Protocol driver. See the <b>Start()</b> function description.
<i>Stop</i>	Stops running the configuration policy for the EFI IPv4 Protocol driver. See the <b>Stop()</b> function description.
<i>GetData</i>	Returns the default configuration data (if any) for the EFI IPv4 Protocol driver. See the <b>GetData()</b> function description.

### Description

In an effort to keep platform policy code out of the EFI IPv4 Protocol driver, the **EFI\_IP4\_CONFIG\_PROTOCOL** driver will be used as the central repository of any platform- and policy-specific configuration for the EFI IPv4 Protocol driver.

An EFI IPv4 Configuration Protocol interface will be installed on each communications device handle that is managed by the platform setup policy. The driver that is responsible for creating EFI IPv4 variable must open the EFI IPv4 Configuration Protocol driver interface **BY\_DRIVER|EXCLUSIVE**.

An example of a configuration policy decision for the EFI IPv4 Protocol driver would be to use a static IP address/subnet mask pair on the platform management network interface

and then use dynamic IP addresses that are configured by DHCP on the remaining network interfaces.

## EFI\_IP4\_CONFIG\_PROTOCOL.Start()

**IMPORTANT NOTICE:** The **EFI\_IP4\_CONFIG\_PROTOCOL** has been replaced with the new **EFI\_IP4\_CONFIG2\_PROTOCOL**.

- All new designs based on this specification should exclusively use [EFI\\_IP4\\_CONFIG2\\_PROTOCOL](#).
- The **EFI\_IP4\_CONFIG\_PROTOCOL** will be removed in the next revision of this specification.

### Summary

Starts running the configuration policy for the EFI IPv4 Protocol driver.

### Prototype

```
typedef
EFI_STATUS
(EFI_API *EFI_IP4_CONFIG_START) (
  IN EFI_IP4_CONFIG_PROTOCOL *This,
  IN EFI_EVENT DoneEvent,
  IN EFI_EVENT ReconfigEvent
);
```

### Parameters

<i>This</i>	Pointer to the <b>EFI_IP4_CONFIG_PROTOCOL</b> instance.
<i>DoneEvent</i>	Event that will be signaled when the EFI IPv4 Protocol driver configuration policy completes execution. This event must be of type <b>EVT_NOTIFY_SIGNAL</b> .
<i>ReconfigEvent</i>	Event that will be signaled when the EFI IPv4 Protocol driver configuration needs to be updated. This event must be of type <b>EVT_NOTIFY_SIGNAL</b> .

### Description

The **Start()** function is called to determine and to begin the platform configuration policy by the EFI IPv4 Protocol driver. This determination may be as simple as returning **EFI\_UNSUPPORTED** if there is no EFI IPv4 Protocol driver configuration policy. It may be as involved as loading some defaults from nonvolatile storage, downloading dynamic data from a DHCP server, and checking permissions with a site policy server.

Starting the configuration policy is just the beginning. It may finish almost instantly or it may take several minutes before it fails to retrieve configuration information from one or more servers. Once the policy is started, drivers should use the *DoneEvent* parameter to determine when the configuration policy has completed.

**EFI\_IP4\_CONFIG\_PROTOCOL.GetData()** must then be called to determine if the configuration succeeded or failed.

Until the configuration completes successfully, EFI IPv4 Protocol driver instances that are attempting to use default configurations must return **EFI\_NO\_MAPPING**.



Once the configuration is complete, the EFI IPv4 Configuration Protocol driver signals *DoneEvent*. The configuration may need to be updated in the future, however; in this case, the EFI IPv4 Configuration Protocol driver must signal *ReconfigEvent*, and all EFI IPv4 Protocol driver instances that are using default configurations must return **EFI\_NO\_MAPPING** until the configuration policy has been rerun.

### Status Codes Returned

EFI_SUCCESS	The configuration policy for the EFI IPv4 Protocol driver is now running.
EFI_INVALID_PARAMETER	One or more of the following parameters is <b>NULL</b> : <ul style="list-style-type: none"> <li>• <i>This</i></li> <li>• <i>DoneEvent</i></li> <li>• <i>ReconfigEvent</i></li> </ul>
EFI_OUT_OF_RESOURCES	Required system resources could not be allocated.
EFI_ALREADY_STARTED	The configuration policy for the EFI IPv4 Protocol driver was already started.
EFI_DEVICE_ERROR	An unexpected system error or network error occurred.
EFI_UNSUPPORTED	This interface does not support the EFI IPv4 Protocol driver configuration.

## EFI\_IP4\_CONFIG\_PROTOCOL.Stop()

**IMPORTANT NOTICE:** The **EFI\_IP4\_CONFIG\_PROTOCOL** has been replaced with the new **EFI\_IP4\_CONFIG2\_PROTOCOL**.

- All new designs based on this specification should exclusively use [EFI\\_IP4\\_CONFIG2\\_PROTOCOL](#).
- The **EFI\_IP4\_CONFIG\_PROTOCOL** will be removed in the next revision of this specification.

### Summary

Stops running the configuration policy for the EFI IPv4 Protocol driver.

### Prototype

```
typedef
EFI_STATUS
(EFI_API *EFI_IP4_CONFIG_STOP) (
    IN EFI_IP4_CONFIG_PROTOCOL *This
);
```

### Parameters

*This* Pointer to the **EFI\_IP4\_CONFIG\_PROTOCOL** instance.

### Description

The **Stop()** function stops the configuration policy for the EFI IPv4 Protocol driver. All configuration data will be lost after calling **Stop()**.

### Status Codes Returned

EFI_SUCCESS	The configuration policy for the EFI IPv4 Protocol driver has been stopped.
EFI_INVALID_PARAMETER	<i>This</i> is <b>NULL</b> .
EFI_NOT_STARTED	The configuration policy for the EFI IPv4 Protocol driver was not started.

## EFI\_IP4\_CONFIG\_PROTOCOL.GetData()

**IMPORTANT NOTICE:** The **EFI\_IP4\_CONFIG\_PROTOCOL** has been replaced with the new **EFI\_IP4\_CONFIG2\_PROTOCOL**.

- All new designs based on this specification should exclusively use [EFI\\_IP4\\_CONFIG2\\_PROTOCOL](#).
- The **EFI\_IP4\_CONFIG\_PROTOCOL** will be removed in the next revision of this specification.

### Summary

Returns the default configuration data (if any) for the EFI IPv4 Protocol driver.

### Prototype

```
typedef
EFI_STATUS
(EFI_API *EFI_IP4_CONFIG_GET_DATA) (
  IN EFI_IP4_CONFIG_PROTOCOL *This,
  IN OUT UINTN *IpConfigDataSize,
  OUT EFI_IP4_IPCONFIG_DATA *IpConfigData OPTIONAL
);
```

### Parameters

<i>This</i>	Pointer to the <b>EFI_IP4_CONFIG_PROTOCOL</b> instance.
<i>IpConfigDataSize</i>	On input, the size of the <i>IpConfigData</i> buffer. On output, the count of bytes that were written into the <i>IpConfigData</i> buffer.
<i>IpConfigData</i>	Pointer to the EFI IPv4 Configuration Protocol driver configuration data structure. Type <b>EFI_IP4_IPCONFIG_DATA</b> is defined in “Related Definitions” below.

### Description

The **GetData()** function returns the current configuration data for the EFI IPv4 Protocol driver after the configuration policy has completed.

## Related Definitions

```

//*****
// EFI_IP4_IPCONFIG_DATA
//*****
typedef struct {
    EFI_IPv4_ADDRESS  StationAddress;
    EFI_IPv4_ADDRESS  SubnetMask;
    UINT32             RouteTableSize;
    EFI_IP4_ROUTE_TABLE *RouteTable OPTIONAL;
} EFI_IP4_IPCONFIG_DATA;

```

<i>StationAddress</i>	Default station IP address, stored in network byte order.
<i>SubnetMask</i>	Default subnet mask, stored in network byte order.
<i>RouteTableSize</i>	Number of entries in the following <i>RouteTable</i> . May be zero.
<i>RouteTable</i>	Default routing table data (stored in network byte order). Ignored if <i>RouteTableSize</i> is zero. Type <b>EFI_IP4_ROUTE_TABLE</b> is defined in <b>EFI_IP4_PROTOCOL.GetModeData()</b> .

**EFI\_IP4\_IPCONFIG\_DATA** contains the minimum IPv4 configuration data that is needed to start basic network communication. The *StationAddress* and *SubnetMask* must be a valid unicast IP address and subnet mask.

If *RouteTableSize* is not zero, then *RouteTable* contains a properly formatted routing table for the *StationAddress/SubnetMask*, with the last entry in the table being the default route.

## Status Codes Returned

EFI_SUCCESS	The EFI IPv4 Protocol driver configuration has been returned.
EFI_INVALID_PARAMETER	<i>This</i> is <b>NULL</b> .
EFI_NOT_STARTED	The configuration policy for the EFI IPv4 Protocol driver is not running.
EFI_NOT_READY	EFI IPv4 Protocol driver configuration is still running.
EFI_ABORTED	EFI IPv4 Protocol driver configuration could not complete.
EFI_BUFFER_TOO_SMALL	<i>*IpConfigDataSize</i> is smaller than the configuration data buffer or <i>IpConfigData</i> is <b>NULL</b> .

## 28.5 EFI IPv4 Configuration II Protocol

This section provides a detailed description of the EFI IPv4 Configuration II Protocol.

## EFI\_IP4\_CONFIG2\_PROTOCOL

### Summary

The **EFI\_IP4\_CONFIG2\_PROTOCOL** provides the mechanism to set and get various types of configurations for the EFI IPv4 network stack.

### GUID

```
#define EFI_IP4_CONFIG2_PROTOCOL_GUID \
{ 0x5b446ed1, 0xe30b, 0x4faa, \
  { 0x87, 0x1a, 0x36, 0x54, 0xec, 0xa3, 0x60, 0x80 } }
```

### Protocol Interface Structure

```
typedef struct _EFI_IP4_CONFIG2_PROTOCOL {
  EFI_IP4_CONFIG2_SET_DATA  SetData;
  EFI_IP4_CONFIG2_GET_DATA  GetData;
  EFI_IP4_CONFIG2_REGISTER_NOTIFY RegisterDataNotify;
  EFI_IP4_CONFIG2_UNREGISTER_NOTIFY UnregisterDataNotify;
} EFI_IP4_CONFIG2_PROTOCOL;
```

### Parameters

<i>SetData</i>	Set the configuration for the EFI IPv4 network stack running on the communication device this EFI IPv4 Configuration II Protocol instance manages. See the <b>SetData()</b> function description.
<i>GetData</i>	Get the configuration for the EFI IPv4 network stack running on the communication device this EFI IPv4 Configuration II Protocol instance manages. See the <b>GetData()</b> function description.
<i>RegisterDataNotify</i>	Register an event that is to be signaled whenever a configuration process on the specified configuration data is done.
<i>UnregisterDataNotify</i>	Remove a previously registered event for the specified configuration data.

### Description

The **EFI\_IP4\_CONFIG2\_PROTOCOL** is designed to be the central repository for the common configurations and the administrator configurable settings for the EFI IPv4 network stack.

An EFI IPv4 Configuration II Protocol instance will be installed on each communication device that the EFI IPv4 network stack runs on.

**Note:** *All the network addresses described in **EFI\_IP4\_CONFIG2\_PROTOCOL** are stored in network byte order. All other parameters defined in functions or data structures are stored in host byte order.*

## EFI\_IP4\_CONFIG2\_PROTOCOL.SetData()

### Summary

Set the configuration for the EFI IPv4 network stack running on the communication device this EFI IPv4 Configuration II Protocol instance manages.

### Prototype

```
typedef
EFI_STATUS
(EFIAPI *EFI_IP4_CONFIG2_SET_DATA) (
  IN EFI_IP4_CONFIG2_PROTOCOL *This,
  IN EFI_IP4_CONFIG2_DATA_TYPE DataType,
  IN UINTN      DataSize,
  IN VOID      *Data
);
```

### Parameters

<i>This</i>	Pointer to the <b>EFI_IP4_CONFIG2_PROTOCOL</b> instance.
<i>DataType</i>	The type of data to set. Type <b>EFI_IP4_CONFIG2_DATA_TYPE</b> is defined in "Related Definitions" below.
<i>DataSize</i>	Size of the buffer pointed to by <i>Data</i> in bytes.
<i>Data</i>	The data buffer to set. The type of the data buffer is associated with the <i>DataType</i> . The various types are defined in "Related Definitions" below.

### Description

This function is used to set the configuration data of type *DataType* for the EFI IPv4 network stack running on the communication device this EFI IPv4 Configuration II Protocol instance manages. The successfully configured data is valid after system reset or power-off.

The *DataSize* is used to calculate the count of structure instances in the *Data* for some *DataType* that multiple structure instances are allowed.

This function is always non-blocking. When setting some type of configuration data, an asynchronous process is invoked to check the correctness of the data, such as doing address conflict detection on the manually set local IPv4 address. **EFI\_NOT\_READY** is returned immediately to indicate that such an asynchronous process is invoked and the process is not finished yet. The caller willing to get the result of the asynchronous process is required to call **RegisterDataNotify()** to register an event on the specified configuration data. Once the event is signaled, the caller can call **GetData()** to get back the configuration data in order to know the result. For other types of configuration data that do not require an asynchronous configuration process, the result of the operation is immediately returned.

## Related Definitions

```

//*****
// EFI_IP4_CONFIG2_DATA_TYPE
//*****
typedef enum {
  Ip4Config2DataTypeInterfaceInfo,
  Ip4Config2DataTypePolicy,
  Ip4Config2DataTypeManualAddress,
  Ip4Config2DataTypeGateway,
  Ip4Config2DataTypeDnsServer,
  Ip4Config2DataTypeMaximum
} EFI_IP4_CONFIG2_DATA_TYPE;

```

### *Ip4Config2DataTypeInterfaceInfo*

The interface information of the communication device this EFI IPv4 Configuration II Protocol instance manages. This type of data is read only. The corresponding *Data* is of type **EFI\_IP4\_CONFIG2\_INTERFACE\_INFO**.

### *Ip4Config2DataTypePolicy*

The general configuration policy for the EFI IPv4 network stack running on the communication device this EFI IPv4 Configuration II Protocol instance manages. The policy will affect other configuration settings. The corresponding *Data* is of type **EFI\_IP4\_CONFIG2\_POLICY**.

### *Ip4Config2DataTypeManualAddress*

The station addresses set manually for the EFI IPv4 network stack. It is only configurable when the policy is *Ip4Config2PolicyStatic*. The corresponding *Data* is of type **EFI\_IP4\_CONFIG2\_MANUAL\_ADDRESS**. When *DataSize* is 0 and *Data* is **NULL**, the existing configuration is cleared from the EFI IPv4 Configuration II Protocol instance.

### *Ip4Config2DataTypeGateway*

The gateway addresses set manually for the EFI IPv4 network stack running on the communication device this EFI IPv4 Configuration II Protocol manages. It is not configurable when the policy is *Ip4Config2PolicyDhcp*. The gateway addresses must be unicast IPv4 addresses. The corresponding *Data* is a pointer to an array of **EFI\_IPv4\_ADDRESS** instances. When *DataSize* is 0 and *Data* is **NULL**, the existing configuration is cleared from the EFI IPv4 Configuration II Protocol instance.



*Ip4Config2DataTypeDnsServer*

The DNS server list for the EFI IPv4 network stack running on the communication device this EFI IPv4 Configuration II Protocol manages. It is not configurable when the policy is *Ip4Config2PolicyDhcp*. The DNS server addresses must be unicast IPv4 addresses. The corresponding *Data* is a pointer to an array of **EFI\_IPv4\_ADDRESS** instances. When *DataSize* is 0 and *Data* is **NULL**, the existing configuration is cleared from the EFI IPv4 Configuration II Protocol instance.

```

//*****
// EFI_IP4_CONFIG2_INTERFACE_INFO related definitions
//*****
#define EFI_IP4_CONFIG2_INTERFACE_INFO_NAME_SIZE 32//

*****

// EFI_IP4_CONFIG2_INTERFACE_INFO
//*****
typedef struct {
  CHAR16      Name[EFI_IP4_CONFIG2_INTERFACE_INFO_NAME_SIZE];
  UINT8       IfType;
  UINT32      HwAddressSize;
  EFI_MAC_ADDRESS  HwAddress;
  EFI_IPv4_ADDRESS  StationAddress;
  EFI_IPv4_ADDRESS  SubnetMask;
  UINT32      RouteTableSize;
  EFI_IP4_ROUTE_TABLE *RouteTable OPTIONAL;
} EFI_IP4_CONFIG2_INTERFACE_INFO;

```

<i>Name</i>	The name of the interface. It is a NULL-terminated Unicode string.
<i>IfType</i>	The interface type of the network interface. See RFC 1700, section "Number Hardware Type".
<i>HwAddressSize</i>	The size, in bytes, of the network interface's hardware address.
<i>HwAddress</i>	The hardware address for the network interface.
<i>StationAddress</i>	The station IPv4 address of this EFI IPv4 network stack.
<i>SubnetMask</i>	The subnet address mask that is associated with the station address.
<i>RouteTableSize</i>	Size of the following <i>RouteTable</i> , in bytes. May be zero.
<i>RouteTable</i>	The route table of the IPv4 network stack runs on this interface. Set to <b>NULL</b> if <i>RouteTableSize</i> is zero. Type <b>EFI_IP4_ROUTE_TABLE</b> is defined in <b>EFI_IP4_PROTOCOL.GetModeData()</b> .

The **EFI\_IP4\_CONFIG2\_INTERFACE\_INFO** structure describes the operational state of the interface this EFI IPv4 Configuration II Protocol instance manages. This type of data is read-only. When reading, the caller allocated buffer is used to return all of the data, i.e., the first part of the buffer is **EFI\_IP4\_CONFIG2\_INTERFACE\_INFO** and the followings are the route table if present. The caller should NOT free the buffer pointed to by *RouteTable*, and the caller is only required to free the whole buffer if the data is not needed any more.

```

//*****
// EFI_IP4_CONFIG2_POLICY
//*****
typedef enum {
    Ip4Config2PolicyStatic,
    Ip4Config2PolicyDhcp,
    Ip4Config2PolicyMax
} EFI_IP4_CONFIG2_POLICY;

```

#### *Ip4Config2PolicyStatic*

Under this policy, the *Ip4Config2DataTypeManualAddress*, *Ip4Config2DataTypeGateway* and *Ip4Config2DataTypeDnsServer* configuration data are required to be set manually. The EFI IPv4 Protocol will get all required configuration such as IPv4 address, subnet mask and gateway settings from the EFI IPv4 Configuration II protocol.

#### *Ip4Config2PolicyDhcp*

Under this policy, the *Ip4Config2DataTypeManualAddress*, *Ip4Config2DataTypeGateway* and *Ip4Config2DataTypeDnsServer* configuration data are not allowed to set via **SetData()**. All of these configurations are retrieved from DHCP server or other auto-configuration mechanism.

The **EFI\_IP4\_CONFIG2\_POLICY** defines the general configuration policy the EFI IPv4 Configuration II Protocol supports. The default policy for a newly detected communication device is beyond the scope of this document. An implementation might leave it to platform to choose the default policy.

The configuration data of type *Ip4Config2DataTypeManualAddress*, *Ip4Config2DataTypeGateway* and *Ip4Config2DataTypeDnsServer* will be flushed if the policy is changed from *Ip4Config2PolicyStatic* to *Ip4Config2PolicyDhcp*.

```

//*****
// EFI_IP4_CONFIG2_MANUAL_ADDRESS
//*****
typedef struct {
    EFI_IPv4_ADDRESS Address;
    EFI_IPv4_ADDRESS SubnetMask;
} EFI_IP4_CONFIG2_MANUAL_ADDRESS;

    Address                The IPv4 unicast address.
    SubnetMask              The subnet mask.

```

The **EFI\_IP4\_CONFIG2\_MANUAL\_ADDRESS** structure is used to set the station address information for the EFI IPv4 network stack manually when the policy is *Ip4Config2PolicyStatic*.

The **EFI\_IP4\_CONFIG2\_DATA\_TYPE** includes current supported data types; this specification allows future extension to support more data types.

## Status Codes Returned

EFI_SUCCESS	The specified configuration data for the EFI IPv4 network stack is set successfully.
EFI_INVALID_PARAMETER	One or more of the following are <b>TRUE</b> : <ul style="list-style-type: none"> <li><i>This</i> is <b>NULL</b>.</li> <li>One or more fields in <i>Data</i> and <i>DataSize</i> do not match the requirement of the data type indicated by <i>DataType</i>.</li> </ul>
EFI_WRITE_PROTECTED	The specified configuration data is read-only or the specified configuration data can not be set under the current policy.
EFI_ACCESS_DENIED	Another set operation on the specified configuration data is already in process.
EFI_NOT_READY	An asynchronous process is invoked to set the specified configuration data and the process is not finished yet.
EFI_BAD_BUFFER_SIZE	The <i>DataSize</i> does not match the size of the type indicated by <i>DataType</i> .
EFI_UNSUPPORTED	This <i>DataType</i> is not supported.
EFI_OUT_OF_RESOURCES	Required system resources could not be allocated.
EFI_DEVICE_ERROR	An unexpected system error or network error occurred.

## EFI\_IP4\_CONFIG2\_PROTOCOL.GetData()

### Summary

Get the configuration data for the EFI IPv4 network stack running on the communication device this EFI IPv4 Configuration II Protocol instance manages.

### Prototype

```
typedef
EFI_STATUS
(EFI_API *EFI_IP4_CONFIG2_GET_DATA) (
  IN EFI_IP4_CONFIG2_PROTOCOL *This,
  IN EFI_IP4_CONFIG2_DATA_TYPE DataType,
  IN OUT UINTN *DataSize,
  IN VOID *Data OPTIONAL
);
```

### Parameters

<i>This</i>	Pointer to the <b>EFI_IP4_CONFIG2_PROTOCOL</b> instance.
<i>DataType</i>	The type of data to get. Type <b>EFI_IP4_CONFIG2_DATA_TYPE</b> is defined in <b>EFI_IP4_CONFIG2_PROTOCOL.SetData()</b> .
<i>DataSize</i>	On input, in bytes, the size of <i>Data</i> . On output, in bytes, the size of buffer required to store the specified configuration data.
<i>Data</i>	The data buffer in which the configuration data is returned. The type of the data buffer is associated with the <i>DataType</i> . Ignored if <i>DataSize</i> is 0. The various types are defined in <b>EFI_IP4_CONFIG2_PROTOCOL.SetData()</b> .

### Description

This function returns the configuration data of type *DataType* for the EFI IPv4 network stack running on the communication device this EFI IPv4 Configuration II Protocol instance manages.

The caller is responsible for allocating the buffer used to return the specified configuration data and the required size will be returned to the caller if the size of the buffer is too small.

**EFI\_NOT\_READY** is returned if the specified configuration data is not ready due to an already in progress asynchronous configuration process. The caller can call **RegisterDataNotify()** to register an event on the specified configuration data. Once the asynchronous configuration process is finished, the event will be signaled and a subsequent **GetData()** call will return the specified configuration data.

### Status Codes Returned

EFI_SUCCESS	The specified configuration data is got successfully.
-------------	---

EFI_INVALID_PARAMETER	One or more of the followings are <b>TRUE</b> : <ul style="list-style-type: none"><li>• <i>This</i> is NULL.</li><li>• <i>DataSize</i> is NULL.</li><li>• <i>Data</i> is NULL if <i>*DataSize</i> is not zero.</li></ul>
EFI_BUFFER_TOO_SMALL	The size of <i>Data</i> is too small for the specified configuration data and the required size is returned in <i>DataSize</i> .
EFI_NOT_READY	The specified configuration data is not ready due to an already in progress asynchronous configuration process.
EFI_NOT_FOUND	The specified configuration data is not found.

## EFI\_IP4\_CONFIG2\_PROTOCOL.RegisterDataNotify ()

### Summary

Register an event that is to be signaled whenever a configuration process on the specified configuration data is done.

### Prototype

```
typedef
EFI_STATUS
(EFI_API *EFI_IP4_CONFIG2_REGISTER_NOTIFY) (
    IN EFI_IP4_CONFIG2_PROTOCOL *This,
    IN EFI_IP4_CONFIG2_DATA_TYPE DataType,
    IN EFI_EVENT Event
);
```

### Parameters

<i>This</i>	Pointer to the <b>EFI_IP4_CONFIG2_PROTOCOL</b> instance.
<i>DataType</i>	The type of data to unregister the event for. Type <b>EFI_IP4_CONFIG2_DATA_TYPE</b> is defined in <b>EFI_IP4_CONFIG2_PROTOCOL.SetData()</b> .
<i>Event</i>	The event to register.

### Description

This function registers an event that is to be signaled whenever a configuration process on the specified configuration data is done. An event can be registered for different *DataType* simultaneously and the caller is responsible for determining which type of configuration data causes the signaling of the event in such case.

### Status Codes Returned

EFI_SUCCESS	The notification event for the specified configuration data is registered.
EFI_INVALID_PARAMETER	<i>This</i> is <b>NULL</b> or <i>Event</i> is <b>NULL</b> .
EFI_UNSUPPORTED	The configuration data type specified by <i>DataType</i> is not supported.
EFI_OUT_OF_RESOURCES	Required system resources could not be allocated.
EFI_ACCESS_DENIED	The <i>Event</i> is already registered for the <i>DataType</i> .

## EFI\_IP4\_CONFIG2\_PROTOCOL.UnregisterDataNotify ()

### Summary

Remove a previously registered event for the specified configuration data.

### Prototype

```
typedef
EFI_STATUS
(EFI_API *EFI_IP4_CONFIG2_UNREGISTER_NOTIFY) (
  IN EFI_IP4_CONFIG2_PROTOCOL *This,
  IN EFI_IP4_CONFIG2_DATA_TYPE DataType,
  IN EFI_EVENT Event
);
```

### Parameters

<i>This</i>	Pointer to the <b>EFI_IP4_CONFIG2_PROTOCOL</b> instance.
<i>DataType</i>	The type of data to remove the previously registered event for. Type <b>EFI_IP4_CONFIG2_DATA_TYPE</b> is defined in <b>EFI_IP4_CONFIG2_PROTOCOL.SetData()</b> .
<i>Event</i>	The event to unregister.

### Description

This function removes a previously registered event for the specified configuration data.

### Status Codes Returned

EFI_SUCCESS	The event registered for the specified configuration data is removed.
EFI_INVALID_PARAMETER	<i>This</i> is NULL or <i>Event</i> is NULL.
EFI_NOT_FOUND	The <i>Event</i> has not been registered for the specified <i>DataType</i> .

## 28.6 EFI IPv6 Protocol

This section defines the EFI IPv6 (Internet Protocol version 6) Protocol interface. It is split into the following three main sections:

- EFI IPv6 Service Binding Protocol
- EFI IPv6 Variable
- EFI IPv6 Protocol

The EFI IPv6 Protocol provides basic network IPv6 packet I/O services, which includes support for Neighbor Discovery Protocol (ND), Multicast Listener Discovery Protocol (MLD), and a subset of the Internet Control Message Protocol (ICMPv6).

## 28.6.1 IPv6 Service Binding Protocol

### EFI\_IP6\_SERVICE\_BINDING\_PROTOCOL

#### Summary

The EFI IPv6 Service Binding Protocol is used to locate communication devices that are supported by an EFI IPv6 Protocol driver and to create and destroy EFI IPv6 Protocol child instances of the IP6 driver that can use the underlying communications device.

#### GUID

```
#define EFI_IP6_SERVICE_BINDING_PROTOCOL_GUID \
{0xec835dd3,0xfe0f,0x617b,\
{0xa6,0x21,0xb3,0x50,0xc3,0xe1,0x33,0x88}}
```

#### Description

A network application that requires basic IPv6 I/O services can use one of the protocol handler services, such as **BS->LocateHandleBuffer()**, to search for devices that publish an EFI IPv6 Service Binding Protocol GUID. Each device with a published EFI IPv6 Service Binding Protocol GUID supports the EFI IPv6 Protocol and may be available for use.

After a successful call to the **EFI\_IP6\_SERVICE\_BINDING\_PROTOCOL.CreateChild()** function, the newly created child EFI IPv6 Protocol driver is in an un-configured state; it is not ready to send and receive data packets.

Before a network application terminates execution, every successful call to the **EFI\_IP6\_SERVICE\_BINDING\_PROTOCOL.CreateChild()** function must be matched with a call to the **EFI\_IP6\_SERVICE\_BINDING\_PROTOCOL.DestroyChild()** function.

## 28.6.2 IPv6 Protocol

### EFI\_IP6\_PROTOCOL

#### Summary

The EFI IPv6 Protocol implements a simple packet-oriented interface that can be used by drivers, daemons, and applications to transmit and receive network packets.



## GUID

```
#define EFI_IP6_PROTOCOL_GUID \
  {0x2c8759d5,0x5c2d,0x66ef,\
  {0x92,0x5f,0xb6,0x6c,0x10,0x19,0x57,0xe2}}
```

## Protocol Interface Structure

```
typedef struct _EFI_IP6_PROTOCOL {
  EFI_IP6_GET_MODE_DATA GetModeData;
  EFI_IP6_CONFIGURE Configure;
  EFI_IP6_GROUPS Groups;
  EFI_IP6_ROUTES Routes;
  EFI_IP6_NEIGHBORS Neighbors;
  EFI_IP6_TRANSMIT Transmit;
  EFI_IP6_RECEIVE Receive;
  EFI_IP6_CANCEL Cancel;
  EFI_IP6_POLL Poll;
} EFI_IP6_PROTOCOL;
```

## Parameters

<i>GetModeData</i>	Gets the current operational settings for this instance of the EFI IPv6 Protocol driver. See the <b>GetModeData()</b> function description.
<i>Configure</i>	Changes or resets the operational settings for the EFI IPv6 Protocol. See the <b>Configure()</b> function description.
<i>Groups</i>	Joins and leaves multicast groups. See the <b>Groups()</b> function description.
<i>Routes</i>	Adds and deletes routing table entries. See the <b>Routes()</b> function description.
<i>Neighbors</i>	Adds and deletes neighbor cache entries. See the <b>Neighbors()</b> function description.
<i>Transmit</i>	Places outgoing data packets into the transmit queue. See the <b>Transmit()</b> function description.
<i>Receive</i>	Places a receiving request into the receiving queue. See the <b>Receive()</b> function description.
<i>Cancel</i>	Aborts a pending transmit or receive request. See the <b>Cancel()</b> function description.
<i>Poll</i>	Polls for incoming data packets and processes outgoing data packets. See the <b>Poll()</b> function description.

## Description

The **EFI\_IP6\_PROTOCOL** defines a set of simple IPv6, and ICMPv6 services that can be used by any network protocol driver, daemon, or application to transmit and receive IPv6 data packets.

**Note:** *Byte Order: All the IPv6 addresses that are described in EFI\_IP6\_PROTOCOL are stored in network byte order. Both incoming and outgoing IP packets are also in network byte order. All other parameters that are defined in functions or data structures are stored in host byte order.*

## EFI\_IP6\_PROTOCOL.GetModeData()

### Summary

Gets the current operational settings for this instance of the EFI IPv6 Protocol driver.

### Prototype

```
typedef
EFI_STATUS
(EFI_API *EFI_IP6_GET_MODE_DATA) (
  IN EFI_IP6_PROTOCOL      *This,
  OUT EFI_IP6_MODE_DATA    *Ip6ModeData OPTIONAL,
  OUT EFI_MANAGED_NETWORK_CONFIG_DATA *MnpConfigData OPTIONAL,
  OUT EFI_SIMPLE_NETWORK_MODE *SnpModeData OPTIONAL
);
```

### Parameters

<i>This</i>	Pointer to the <b>EFI_IP6_PROTOCOL</b> instance.
<i>Ip6ModeData</i>	Pointer to the EFI IPv6 Protocol mode data structure. Type <b>EFI_IP6_MODE_DATA</b> is defined in "Related Definitions" below.
<i>MnpConfigData</i>	Pointer to the managed network configuration data structure. Type <b>EFI_MANAGED_NETWORK_CONFIG_DATA</b> is defined in <b>EFI_MANAGED_NETWORK_PROTOCOL.GetModeData()</b> .
<i>SnpData</i>	Pointer to the simple network mode data structure. Type <b>EFI_SIMPLE_NETWORK_MODE</b> is defined in the <b>EFI_SIMPLE_NETWORK_PROTOCOL</b> .

### Description

The **GetModeData()** function returns the current operational mode data for this driver instance. The data fields in **EFI\_IP6\_MODE\_DATA** are read only. This function is used optionally to retrieve the operational mode data of underlying networks or drivers.

## Related Definitions

```

//*****
// EFI_IP6_MODE_DATA
//*****
typedef struct {
    BOOLEAN    IsStarted;
    UINT32     MaxPacketSize;
    EFI_IP6_CONFIG_DATA  ConfigData;
    BOOLEAN    IsConfigured;
    UINT32     AddressCount;
    EFI_IP6_ADDRESS_INFO  *AddressList;
    UINT32     GroupCount;
    EFI_IPv6_ADDRESS  *GroupTable;
    UINT32     RouteCount;
    EFI_IP6_ROUTE_TABLE  *RouteTable;
    UINT32     NeighborCount;
    EFI_IP6_NEIGHBOR_CACHE  *NeighborCache;
    UINT32     PrefixCount;
    EFI_IP6_ADDRESS_INFO  *PrefixTable;
    UINT32     IcmpTypeCount;
    EFI_IP6_ICMP_TYPE  *IcmpTypeList;
} EFI_IP6_MODE_DATA;

```

*IsStarted*

Set to **TRUE** after this EFI IPv6 Protocol instance is started. All other fields in this structure are undefined until this field is **TRUE**. Set to **FALSE** when the EFI IPv6 Protocol instance is stopped.

*MaxPacckeSize*

The maximum packet size, in bytes, of the packet which the upper layer driver could feed.

*ConfigData*

Current configuration settings. Undefined until *IsStarted* is **TRUE**. Type **EFI\_IP6\_CONFIG\_DATA** is defined below.

*IsConfigured*

Set to **TRUE** when the EFI IPv6 Protocol instance is configured. The instance is configured when it has a station address and corresponding prefix length. Set to **FALSE** when the EFI IPv6 Protocol instance is not configured.

*AddressCount*

Number of configured IPv6 addresses on this interface.

*AddressList*

List of currently configured IPv6 addresses and corresponding prefix lengths assigned to this interface. It is caller's responsibility to free this buffer. Type **EFI\_IP6\_ADDRESS\_INFO** is defined below.

*GroupCount*

Number of joined multicast groups. Undefined until *IsConfigured* is **TRUE**.

*GroupTable*

List of joined multicast group addresses. It is caller's responsibility to free this buffer. Undefined until *IsConfigured* is **TRUE**.

<i>RouteCount</i>	Number of entries in the routing table. Undefined until <i>IsConfigured</i> is <b>TRUE</b> .
<i>RouteTable</i>	Routing table entries. It is caller's responsibility to free this buffer. Type <b>EFI_IP6_ROUTE_TABLE</b> is defined below.
<i>NeighborCount</i>	Number of entries in the neighbor cache. Undefined until <i>IsConfigured</i> is <b>TRUE</b> .
<i>NeighborCache</i>	Neighbor cache entries. It is caller's responsibility to free this buffer. Undefined until <i>IsConfigured</i> is <b>TRUE</b> . Type <b>EFI_IP6_NEIGHBOR_CACHE</b> is defined below.
<i>PrefixCount</i>	Number of entries in the prefix table. Undefined until <i>IsConfigured</i> is <b>TRUE</b> .
<i>PrefixTable</i>	On-link Prefix table entries. It is caller's responsibility to free this buffer. Undefined until <i>IsConfigured</i> is <b>TRUE</b> . Type <b>EFI_IP6_ADDRESS_INFO</b> is defined below.
<i>IcmpTypeCount</i>	Number of entries in the supported ICMP types list.
<i>IcmpTypeList</i>	Array of ICMP types and codes that are supported by this EFI IPv6 Protocol driver. It is caller's responsibility to free this buffer. Type <b>EFI_IP6_ICMP_TYPE</b> is defined below.

```

//*****
// EFI_IP6_CONFIG_DATA
//*****
typedef struct {
    UINT8    DefaultProtocol;
    BOOLEAN  AcceptAnyProtocol;
    BOOLEAN  AcceptIcmpErrors;
    BOOLEAN  AcceptPromiscuous;
    EFI_IPv6_ADDRESS DestinationAddress;
    EFI_IPv6_ADDRESS StationAddress;
    UINT8    TrafficClass;
    UINT8    HopLimit;
    UINT32   FlowLabel;
    UINT32   ReceiveTimeout;
    UINT32   TransmitTimeout;
} EFI_IP6_CONFIG_DATA;

```

<i>DefaultProtocol</i>	For the IPv6 packet to send and receive, this is the default value of the 'Next Header' field in the last IPv6 extension header or in the IPv6 header if there are no extension headers. Ignored when <b>AcceptPromiscuous</b> is <b>TRUE</b> . An updated list of protocol numbers can be found at "Links to UEFI-Related Documents" ( <a href="http://uefi.org/uefi">http://uefi.org/uefi</a> ) under the heading "IANA Assigned Internet Protocol Numbers". The following values are illegal: 0 (IPv6 Hop-by-Hop Option), 1(ICMP), 2(IGMP), 41(IPv6), 43(Routing Header for IPv6), 44(Fragment Header for IPv6), 59(No Next Header for
------------------------	---

	IPv6), 60(Destination Options for IPv6), 124(ISIS over IPv4).
<i>AcceptAnyProtocol</i>	Set to <b>TRUE</b> to receive all IPv6 packets that get through the receive filters. Set to <b>FALSE</b> to receive only the <i>DefaultProtocol</i> IPv6 packets that get through the receive filters. Ignored when <i>AcceptPromiscuous</i> is <b>TRUE</b> .
<i>AcceptIcmpErrors</i>	Set to <b>TRUE</b> to receive ICMP error report packets. Ignored when <i>AcceptPromiscuous</i> or <i>AcceptAnyProtocol</i> is <b>TRUE</b> .
AcceptPromiscuous	Set to <b>TRUE</b> to receive all IPv6 packets that are sent to any hardware address or any protocol address. Set to <b>FALSE</b> to stop receiving all promiscuous IPv6 packets.
<i>DestinationAddress</i>	The destination address of the packets that will be transmitted. Ignored if it is unspecified.
<i>StationAddress</i>	The station IPv6 address that will be assigned to this EFI IPv6 Protocol instance. This field can be set and changed only when the EFI IPv6 driver is transitioning from the stopped to the started states. If the <i>StationAddress</i> is specified, the EFI IPv6 Protocol driver will deliver only incoming IPv6 packets whose destination matches this IPv6 address exactly. The <i>StationAddress</i> is required to be one of currently configured IPv6 addresses. An address containing all zeroes is also accepted as a special case. Under this situation, the IPv6 driver is responsible for binding a source address to this EFI IPv6 protocol instance according to the source address selection algorithm. Only incoming packets destined to the selected address will be delivered to the user. And the selected station address can be retrieved through later <i>GetModeData()</i> call. If no address is available for selecting, <b>EFI_NO_MAPPING</b> will be returned, and the station address will only be successfully bound to this EFI IPv6 protocol instance after <i>IP6ModeData.IsConfigured</i> changed to <b>TRUE</b> .
<i>TrafficClass</i>	<i>TrafficClass</i> field in transmitted IPv6 packets. Default value is zero.
<i>HopLimit</i>	<i>HopLimit</i> field in transmitted IPv6 packets.
<i>FlowLabel</i>	<i>FlowLabel</i> field in transmitted IPv6 packets. Default value is zero.
<i>ReceiveTimeout</i>	The timer timeout value (number of microseconds) for the receive timeout event to be associated with each assembled packet. Zero means do not drop assembled packets.
<i>TransmitTimeout</i>	The timer timeout value (number of microseconds) for the transmit timeout event to be associated with each outgoing packet. Zero means do not drop outgoing packets.

The **EFI\_IP6\_CONFIG\_DATA** structure is used to report and change IPv6 session parameters.

```

//*****
// EFI_IP6_ADDRESS_INFO //*****
typedef struct {
    EFI_IPv6_ADDRESS Address;
    UINT8 PrefixLength;
} EFI_IP6_ADDRESS_INFO;

```

*Address*                      The IPv6 address.  
*PrefixLength*                The length of the prefix associated with the *Address*.

```

//*****
// EFI_IP6_ROUTE_TABLE
//*****
typedef struct {
    EFI_IPv6_ADDRESS Gateway;
    EFI_IPv6_ADDRESS Destination;
    UINT8 PrefixLength;
} EFI_IP6_ROUTE_TABLE;

```

*Gateway*                      The IPv6 address of the gateway to be used as the next hop for packets to this prefix. If the IPv6 address is all zeros, then the prefix is on-link.  
*Destination*                The destination prefix to be routed.  
*PrefixLength*                The length of the prefix associated with the *Destination*.

**EFI\_IP6\_ROUTE\_TABLE** is the entry structure that is used in routing tables.

```

//*****
// EFI_IP6_NEIGHBOR_CACHE
//*****
typedef struct {
    EFI_IPv6_ADDRESS Neighbor;
    EFI_MAC_ADDRESS LinkAddress;
    EFI_IP6_NEIGHBOR_STATE State;
} EFI_IP6_NEIGHBOR_CACHE;

```

*Neighbor*                      The on-link unicast / anycast IP address of the neighbor.  
*LinkAddress*                Link-layer address of the neighbor.  
*State*                        State of this neighbor cache entry.

**EFI\_IP6\_NEIGHBOR\_CACHE** is the entry structure that is used in neighbor cache. It records a set of entries about individual neighbors to which traffic has been sent recently.

```

//*****
// EFI_IP6_NEIGHBOR_STATE
//*****
typedef enum {
  EfiNeighborInComplete,
  EfiNeighborReachable,
  EfiNeighborStale,
  EfiNeighborDelay,
  EfiNeighborProbe
} EFI_IP6_NEIGHBOR_STATE;

```

Following is a description of the fields in the above enumeration.

<i>EfiNeighborInComplete</i>	Address resolution is being performed on this entry. Specially, Neighbor Solicitation has been sent to the solicited-node multicast address of the target, but corresponding Neighbor Advertisement has not been received.
<i>EfiNeighborReachable</i>	Positive confirmation was received that the forward path to the neighbor was functioning properly.
<i>EfiNeighborStale</i>	Reachable Time has elapsed since the last positive confirmation was received. In this state, the forward path to the neighbor was functioning properly.
<i>EfiNeighborDelay</i>	This state is an optimization that gives upper-layer protocols additional time to provide reachability confirmation.
<i>EfiNeighborProbe</i>	A reachability confirmation is actively sought by retransmitting Neighbor Solicitations every RetransTimer milliseconds until a reachability confirmation is received.

```

//*****
// EFI_IP6_ICMP_TYPE
//*****
typedef struct {
  UINT8   Type;
  UINT8   Code;
} EFI_IP6_ICMP_TYPE;

```

<i>Type</i>	The type of ICMP message. See, "Links to UEFI-Related Documents" ( <a href="http://uefi.org/uefi">http://uefi.org/uefi</a> ) under the heading "Internet Control Message Protocol Version 6 (ICMPv6) Parameters" for the complete list of ICMP message type.
-------------	--



*Code*

The code of the ICMP message, which further describes the different ICMP message formats under the same **Type**. See “Links to UEFI-Related Documents” (<http://uefi.org/uefi>) under the heading “Internet Control Message Protocol Version 6 (ICMPv6) Parameters” for details for code of ICMP message.

**EFI\_IP6\_ICMP\_TYPE** is used to describe those ICMP messages that are supported by this EFI IPv6 Protocol driver.

```

//*****
// ICMPv6 type definitions for error messages
//*****
#define ICMP_V6_DEST_UNREACHABLE    0x1
#define ICMP_V6_PACKET_TOO_BIG     0x2
#define ICMP_V6_TIME_EXCEEDED      0x3
#define ICMP_V6_PARAMETER_PROBLEM   0x4

//*****
// ICMPv6 type definition for informational messages
//*****
#define ICMP_V6_ECHO_REQUEST        0x80
#define ICMP_V6_ECHO_REPLY          0x81
#define ICMP_V6_LISTENER_QUERY      0x82
#define ICMP_V6_LISTENER_REPORT     0x83
#define ICMP_V6_LISTENER_DONE       0x84
#define ICMP_V6_ROUTER_SOLICIT      0x85
#define ICMP_V6_ROUTER_ADVERTISE    0x86
#define ICMP_V6_NEIGHBOR_SOLICIT    0x87
#define ICMP_V6_NEIGHBOR_ADVERTISE  0x88
#define ICMP_V6_REDIRECT             0x89
#define ICMP_V6_LISTENER_REPORT_2   0x8F

//*****
// ICMPv6 code definitions for ICMP_V6_DEST_UNREACHABLE
//*****
#define ICMP_V6_NO_ROUTE_TO_DEST    0x0
#define ICMP_V6_COMM_PROHIBITED     0x1
#define ICMP_V6_BEYOND_SCOPE        0x2
#define ICMP_V6_ADDR_UNREACHABLE    0x3
#define ICMP_V6_PORT_UNREACHABLE    0x4
#define ICMP_V6_SOURCE_ADDR_FAILED  0x5
#define ICMP_V6_ROUTE_REJECTED      0x6

//*****
// ICMPv6 code definitions for ICMP_V6_TIME_EXCEEDED
//*****
#define ICMP_V6_TIMEOUT_HOP_LIMIT   0x0
#define ICMP_V6_TIMEOUT_REASSEMBLE  0x1

```

```
/**
//*****
// ICMPv6 code definitions for ICMP_V6_PARAMETER_PROBLEM
//*****
#define ICMP_V6_ERRONEOUS_HEADER    0x0
#define ICMP_V6_UNRECOGNIZE_NEXT_HDR  0x1
#define ICMP_V6_UNRECOGNIZE_OPTION    0x2
```

## Status Codes Returned

EFI_SUCCESS	The operation completed successfully.
EFI_INVALID_PARAMETER	<i>This is</i> <b>NULL</b>
EFI_OUT_OF_RESOURCES	The required mode data could not be allocated.

## EFI\_IP6\_PROTOCOL.Configure()

### Summary

Assign IPv6 address and other configuration parameter to this EFI IPv6 Protocol driver instance.

### Prototype

```
typedef
EFI_STATUS
(EFI_API *EFI_IP6_CONFIGURE) (
  IN EFI_IP6_PROTOCOL *This,
  IN EFI_IP6_CONFIG_DATA *Ip6ConfigData OPTIONAL
);
```

### Parameters

<i>This</i>	Pointer to the <b>EFI_IP6_PROTOCOL</b> instance.
<i>Ip6ConfigData</i>	Pointer to the EFI IPv6 Protocol configuration data structure. Type <b>EFI_IP6_CONFIG_DATA</b> is defined in <b>EFI_IP6_PROTOCOL.GetModeData()</b> .

### Description

The **Configure()** function is used to set, change, or reset the operational parameters and filter settings for this EFI IPv6 Protocol instance. Until these parameters have been set, no network traffic can be sent or received by this instance. Once the parameters have been set, no network traffic can be sent or received by this instance. Once the parameters have been reset (by calling this function with *Ip6ConfigData* set to **NULL**), no more traffic can be sent or received until these parameters have been set again. Each EFI IPv6 Protocol instance can be started and stopped independently of each other by enabling or disabling their receive filter settings with the **Configure()** function.

If *Ip6ConfigData.StationAddress* is a valid non-zero IPv6 unicast address, it is required to be one of the currently configured IPv6 addresses list in the EFI IPv6 drivers, or else **EFI\_INVALID\_PARAMETER** will be returned. If *Ip6ConfigData.StationAddress* is unspecified, the IPv6 driver will bind a source address according to the source address selection algorithm. Clients could frequently call **GetModeData()** to check get currently configured IPv6 address list in the EFI IPv6 driver. If both *Ip6ConfigData.StationAddress* and *Ip6ConfigData.Destination* are unspecified, when transmitting the packet afterwards, the source address filled in each outgoing IPv6 packet is decided based on the destination of this packet.

If operational parameters are reset or changed, any pending transmit and receive requests will be cancelled. Their completion token status will be set to **EFI\_ABORTED** and their events will be signaled.

## Status Codes Returned

EFI_SUCCESS	The driver instance was successfully opened.
EFI_INVALID_PARAMETER	One or more of the following conditions is <b>TRUE</b> : <i>This is NULL.</i> <i>Ip6ConfigData.StationAddress</i> is neither zero nor a unicast IPv6 address. <i>Ip6ConfigData.StationAddress</i> is neither zero nor one of the configured IP addresses in the EFI IPv6 driver. <i>Ip6ConfigData.DefaultProtocol</i> is illegal.
EFI_OUT_OF_RESOURCES	The EFI IPv6 Protocol driver instance data could not be allocated.
EFI_NO_MAPPING	The IPv6 driver was responsible for choosing a source address for this instance, but no source address was available for use.
EFI_ALREADY_STARTED	The interface is already open and must be stopped before the IPv6 address or prefix length can be changed.
EFI_DEVICE_ERROR	An unexpected system or network error occurred. The EFI IPv6 Protocol driver instance is not opened.
EFI_UNSUPPORTED	Default protocol specified through <i>Ip6ConfigData.DefaultProtocol</i> isn't supported.

## EFI\_IP6\_PROTOCOL.Groups()

### Summary

Joins and leaves multicast groups.

### Prototype

```
typedef
EFI_STATUS
(EFI_API *EFI_IP6_GROUPS) (
  IN EFI_IP6_PROTOCOL *This,
  IN BOOLEAN   JoinFlag,
  IN EFI_IPv6_ADDRESS *GroupAddress OPTIONAL
);
```

### Parameters

<i>This</i>	Pointer to the <b>EFI_IP6_PROTOCOL</b> instance.
<i>JoinFlag</i>	Set to <b>TRUE</b> to join the multicast group session and <b>FALSE</b> to leave.
<i>GroupAddress</i>	Pointer to the IPv6 multicast address.

### Description

The **Groups()** function is used to join and leave multicast group sessions. Joining a group will enable reception of matching multicast packets. Leaving a group will disable reception of matching multicast packets. Source-Specific Multicast isn't required to be supported.

If *JoinFlag* is **FALSE** and *GroupAddress* is **NULL**, all joined groups will be left.

### Status Codes Returned

EFI_SUCCESS	The operation completed successfully.
EFI_INVALID_PARAMETER	One or more of the following is <b>TRUE</b> : <i>This</i> is <b>NULL</b> . <i>JoinFlag</i> is <b>TRUE</b> and <i>GroupAddress</i> is <b>NULL</b> . <i>GroupAddress</i> is not <b>NULL</b> and * <i>GroupAddress</i> is not a multicast IPv6 address. <i>GroupAddress</i> is not <b>NULL</b> and * <i>GroupAddress</i> is in the range of SSM destination address.
EFI_NOT_STARTED	This instance has not been started.
EFI_OUT_OF_RESOURCES	System resources could not be allocated.
EFI_UNSUPPORTED	This EFI IPv6 Protocol implementation does not support multicast groups.
EFI_ALREADY_STARTED	The group address is already in the group table (when <i>JoinFlag</i> is <b>TRUE</b> ).

EFI_NOT_FOUND	The group address is not in the group table (when <i>JoinFlag</i> is <b>FALSE</b> ).
EFI_DEVICE_ERROR	An unexpected system or network error occurred.

## EFI\_IP6\_PROTOCOL.Routes()

### Summary

Adds and deletes routing table entries.

### Prototype

```
typedef
EFI_STATUS
(EFIAPI *EFI_IP6_ROUTES) (
  IN EFI_IP6_PROTOCOL *This,
  IN BOOLEAN DeleteRoute,
  IN EFI_IPv6_ADDRESS *Destination OPTIONAL,
  IN UINT8 PrefixLength,
  IN EFI_IPv6_ADDRESS *GatewayAddress OPTIONAL
);
```

### Parameters

<i>This</i>	Pointer to the <b>EFI_IP6_PROTOCOL</b> instance.
<i>DeleteRoute</i>	Set to <b>TRUE</b> to delete this route from the routing table. Set to <b>FALSE</b> to add this route to the routing table. <i>Destination</i> , <i>PrefixLength</i> and <i>Gateway</i> are used as the key to each route entry.
<i>Destination</i>	The address prefix of the subnet that needs to be routed.
<i>PrefixLength</i>	The prefix length of <i>Destination</i> . Ignored if <i>Destination</i> is <b>NULL</b> .
<i>GatewayAddress</i>	The unicast gateway IPv6 address for this route.

### Description

The `Routes()` function adds a route to or deletes a route from the routing table.

Routes are determined by comparing the leftmost *PrefixLength* bits of *Destination* with the destination IPv6 address arithmetically. The gateway address must be on the same subnet as the configured station address.

The default route is added with *Destination* and *PrefixLength* both set to all zeros. The default route matches all destination IPv6 addresses that do not match any other routes.

All EFI IPv6 Protocol instances share a routing table.

**Note:** *There is no way to set up routes to other network interface cards because each network interface card has its own independent network stack that shares information only through the EFI IPv6 variable.*

### Status Codes Returned

EFI_SUCCESS	The operation completed successfully.
EFI_NOT_STARTED	The driver instance has not been started.



EFI_INVALID_PARAMETER	<p>One or more of the following conditions is <b>TRUE</b>:</p> <p><i>This</i> is <b>NULL</b>.</p> <p>When <i>DeleteRoute</i> is <b>TRUE</b>, both <i>Destination</i> and <i>GatewayAddress</i> are <b>NULL</b></p> <p>When <i>DeleteRoute</i> is <b>FALSE</b>, either <i>Destination</i> or <i>GatewayAddress</i> is <b>NULL</b></p> <p>* <i>GatewayAddress</i> is not a valid unicast IPv6 address.</p> <p>* <i>GatewayAddress</i> is one of the local configured IPv6 addresses.</p>
EFI_OUT_OF_RESOURCES	Could not add the entry to the routing table.
EFI_NOT_FOUND	This route is not in the routing table (when <i>DeleteRoute</i> is <b>TRUE</b> ).
EFI_ACCESS_DENIED	The route is already defined in the routing table (when <i>DeleteRoute</i> is <b>FALSE</b> ).

## EFI\_IP6\_PROTOCOL.Neighbors()

### Summary

Add or delete Neighbor cache entries.

### Prototype

```
typedef
EFI_STATUS
(EFIAPI *EFI_IP6_NEIGHBORS) (
  IN EFI_IP6_PROTOCOL *This,
  IN BOOLEAN DeleteFlag,
  IN EFI_IPv6_ADDRESS *TargetIp6Address,
  IN EFI_MAC_ADDRESS *TargetLinkAddress OPTIONAL
  IN UINT32 Timeout,
  IN BOOLEAN Override
);
```

### Parameters

<i>This</i>	Pointer to the <b>EFI_IP6_PROTOCOL</b> instance.
<i>DeleteFlag</i>	Set to <b>TRUE</b> to delete the specified cache entry, set to <b>FALSE</b> to add (or update, if it already exists and <i>Override</i> is <b>TRUE</b> ) the specified cache entry. <i>TargetIp6Address</i> is used as the key to find the requested cache entry.
<i>TargetIp6Address</i>	Pointer to Target IPv6 address.
<i>TargetLinkAddress</i>	Pointer to link-layer address of the target. Ignored if <b>NULL</b> .
<i>Timeout</i>	Time in 100-ns units that this entry will remain in the neighbor cache, it will be deleted after Timeout. A value of zero means that the entry is permanent. A non-zero value means that the entry is dynamic.
<i>Override</i>	If <b>TRUE</b> , the cached link-layer address of the matching entry will be overridden and updated; if <b>FALSE</b> , <b>EFI_ACCESS_DENIED</b> will be returned if a corresponding cache entry already existed.

### Description

The **Neighbors()** function is used to add, update, or delete an entry from neighbor cache. IPv6 neighbor cache entries are typically inserted and updated by the network protocol driver as network traffic is processed. Most neighbor cache entries will time out and be deleted if the network traffic stops. Neighbor cache entries that were inserted by **Neighbors()** may be static (will not timeout) or dynamic (will time out).

The implementation should follow the neighbor cache timeout mechanism which is defined in RFC4861. The default neighbor cache timeout value should be tuned for the expected network environment.

## Status Codes Returned

EFI_SUCCESS	The operation completed successfully.
EFI_NOT_STARTED	The driver instance has not been started.
EFI_INVALID_PARAMETER	One or more of the following conditions is <b>TRUE</b> : <i>This is NULL.</i> <i>TargetIpAddress</i> is <b>NULL</b> . <i>* TargetLinkAddress</i> is invalid when not <b>NULL</b> . <i>* TargetIpAddress</i> is not a valid unicast IPv6 address. <i>* TargetIpAddress</i> is one of the local configured IPv6 addresses.
EFI_OUT_OF_RESOURCES	Could not add the entry to the neighbor cache.
EFI_NOT_FOUND	This entry is not in the neighbor cache (when <i>DeleteFlag</i> is <b>TRUE</b> or when <i>DeleteFlag</i> is <b>FALSE</b> while <i>TargetLinkAddress</i> is <b>NULL</b> .).
EFI_ACCESS_DENIED	The to-be-added entry is already defined in the neighbor cache, and that entry is tagged as un-overridden (when <i>DeleteFlag</i> is <b>FALSE</b> ).

## EFI\_IP6\_PROTOCOL.Transmit()

### Summary

Places outgoing data packets into the transmit queue.

### Prototype

```
typedef
EFI_STATUS
(EFIAPI *EFI_IP6_TRANSMIT) (
  IN EFI_IP6_PROTOCOL *This,
  IN EFI_IP6_COMPLETION_TOKEN *Token
);
```

### Parameters

<i>This</i>	Pointer to the <b>EFI_IP6_PROTOCOL</b> instance.
<i>Token</i>	Pointer to the transmit token. Type <b>EFI_IP6_COMPLETION_TOKEN</b> is defined in "Related Definitions" below.

### Description

The **Transmit()** function places a sending request in the transmit queue of this EFI IPv6 Protocol instance. Whenever the packet in the token is sent out or some errors occur, the event in the token will be signaled and the status is updated.

### Related Definitions

```
/**
//*****
// EFI_IP6_COMPLETION_TOKEN
//*****
typedef struct {
  EFI_EVENT      Event;
  EFI_STATUS     Status;
  union {
    EFI_IP6_RECEIVE_DATA *RxData;
    EFI_IP6_TRANSMIT_DATA *TxData;
  } Packet;
} EFI_IP6_COMPLETION_TOKEN;
```

<i>Event</i>	This <i>Event</i> will be signaled after the <i>Status</i> field is updated by the EFI IPv6 Protocol driver. The type of <i>Event</i> must be <b>EFI_NOTIFY_SIGNAL</b> .
--------------	--

<i>Status</i>	Will be set to one of the following values: <b>EFI_SUCCESS</b> : The receive or transmit completed successfully. <b>EFI_ABORTED</b> : The receive or transmit was aborted.
---------------	--

**EFI\_TIMEOUT:** The transmit timeout expired.

**EFI\_ICMP\_ERROR:** An ICMP error packet was received.

**EFI\_DEVICE\_ERROR:** An unexpected system or network error occurred.

**EFI\_SECURITY\_VIOLATION:** The transmit or receive was failed because of an IPsec policy check.

### *RxData*

When the Token is used for receiving, *RxData* is a pointer to the **EFI\_IP6\_RECEIVE\_DATA**. Type **EFI\_IP6\_RECEIVE\_DATA** is defined below.

### *TxData*

When the Token is used for transmitting, *TxData* is a pointer to the **EFI\_IP6\_TRANSMIT\_DATA**. Type **EFI\_IP6\_TRANSMIT\_DATA** is defined below.

**EFI\_IP6\_COMPLETION\_TOKEN** structures are used for both transmit and receive operations.

When the structure is used for transmitting, the *Event* and *TxData* fields must be filled in by the EFI IPv6 Protocol client. After the transmit operation completes, the EFI IPv6 Protocol driver updates the *Status* field and the *Event* is signaled.

When the structure is used for receiving, only the *Event* field must be filled in by the EFI IPv6 Protocol client. After a packet is received, the EFI IPv6 Protocol driver fills in the *RxData* and *Status* fields and the *Event* is signaled

```

//*****
// EFI_IP6_RECEIVE_DATA
//*****
typedef struct _EFI_IP6_RECEIVE_DATA {
    EFI_TIME      TimeStamp;
    EFI_EVENT     RecycleSignal;
    UINT32        HeaderLength;
    EFI_IP6_HEADER *Header;
    UINT32        DataLength;
    UINT32        FragmentCount;
    EFI_IP6_FRAGMENT_DATA FragmentTable[1];
} EFI_IP6_RECEIVE_DATA;

```

*TimeStamp* Time when the EFI IPv6 Protocol driver accepted the packet. *TimeStamp* is zero filled if timestamps are disabled or unsupported.

*RecycleSignal* After this event is signaled, the receive data structure is released and must not be referenced.

*HeaderLength* Length of the IPv6 packet headers, including both the IPv6 header and any extension headers.

<i>Header</i>	Pointer to the IPv6 packet header. If the IPv6 packet was fragmented, this argument is a pointer to the header in the first fragment. Type <b>EFI_IP6_HEADER</b> is defined below.
<i>DataLength</i>	Sum of the lengths of IPv6 packet buffers in <b>FragmentTable</b> . May be zero.
<i>FragmentCount</i>	Number of IPv6 payload fragments. May be zero.
<i>FragmentTable</i>	Array of payload fragment lengths and buffer pointers. Type <b>EFI_IP6_FRAGMENT_DATA</b> is defined below.

The EFI IPv6 Protocol receive data structure is filled in when IPv6 packets have been assembled. In the case of IPv6 packet assembly, the individual packet fragments are only verified and are not reorganized into a single linear buffer.

The *FragmentTable* contains a sorted list of zero or more packet fragment descriptors. The referenced packet fragments may not be in contiguous memory locations.

```

//*****
// EFI_IP6_HEADER
//*****
#pragma pack(1)
typedef struct _EFI_IP6_HEADER {
    UINT8      TrafficClassH:4;
    UINT8      Version:4;
    UINT8      FlowLabelH:4;
    UINT8      TrafficClassL:4;
    UINT16     FlowLabelL;
    UINT16     PayloadLength;
    UINT8      NextHeader;
    UINT8      HopLimit;
    EFI_IPv6_ADDRESS SourceAddress;
    EFI_IPv6_ADDRESS DestinationAddress;
} EFI_IP6_HEADER;
#pragma pack

```

The fields in the IPv6 header structure are defined in the Internet Protocol version 6 specification, which can be found at “Links to UEFI-Related Documents” (<http://uefi.org/uefi>) under the heading “Internet Protocol version 6 Specification”.

```

//*****
// EFI_IP6_FRAGMENT_DATA
//*****
typedef struct _EFI_IP6_FRAGMENT_DATA {
    UINT32    FragmentLength;
    VOID      *FragmentBuffer;
} EFI_IP6_FRAGMENT_DATA;

    FragmentLength        Length of fragment data. This field may not be set to zero.
    FragmentBuffer       Pointer to fragment data. This field may not be set to
                        NULL.

```

The **EFI\_IP6\_FRAGMENT\_DATA** structure describes the location and length of the IPv6 packet fragment to transmit or that has been received.

```

//*****
// EFI_IP6_TRANSMIT_DATA
//*****
typedef struct _EFI_IP6_TRANSMIT_DATA {
    EFI_IPv6_ADDRESS  DestinationAddress;
    EFI_IP6_OVERRIDE_DATA *OverrideData;
    UINT32    ExtHdrsLength;
    VOID      *ExtHdrs;
    UINT8     NextHeader;
    UINT32    DataLength;
    UINT32    FragmentCount;
    EFI_IP6_FRAGMENT_DATA FragmentTable[1];
} EFI_IP6_TRANSMIT_DATA;

    DestinationAddress    The destination IPv6 address. If it is unspecified,
                        ConfigData.DestinationAddress will be used instead.
    OverrideData         If not NULL, the IPv6 transmission control override data.
                        Type EFI_IP6_OVERRIDE_DATA is defined below.
    ExtHdrsLength       Total length in byte of the IPv6 extension headers
                        specified in ExtHdrs
    ExtHdrs            Pointer to the IPv6 extension headers. The IP layer will
                        append the required extension headers if they are not
                        specified by ExtHdrs. Ignored if ExtHdrsLength is zero.
    NextHeader         The protocol of first extension header in ExtHdrs. Ignored
                        if ExtHdrsLength is zero.
    DataLength         Total length in bytes of the FragmentTable data to
                        transmit.
    FragmentCount     Number of entries in the fragment data table.
    FragmentTable     Start of the fragment data table. Type
                        EFI_IP6_FRAGMENT_DATA is defined above.

```

The **EFI\_IP6\_TRANSMIT\_DATA** structure describes a possibly fragmented packet to be transmitted.

```
/**
 * *****
 * // EFI_IP6_OVERRIDE_DATA
 * *****
 */
typedef struct _EFI_IP6_OVERRIDE_DATA {
    UINT8    Protocol;
    UINT8    HopLimit;
    UINT32   FlowLabel;
} EFI_IP6_OVERRIDE_DATA;
```

*Protocol*                      Protocol type override.

*HopLimit*                     Hop-Limit override.

*FlowLabel*                    Flow-Label override.

The information and flags in the override data structure will override default parameters or settings for one **Transmit()** function call.



## Status Codes Returned

EFI_SUCCESS	The data has been queued for transmission.
EFI_NOT_STARTED	This instance has not been started.
EFI_NO_MAPPING	The IPv6 driver was responsible for choosing a source address for this transmission, but no source address was available for use.
EFI_INVALID_PARAMETER	One or more of the following is <b>TRUE</b> : <ul style="list-style-type: none"> <li>• <i>This</i> is <b>NULL</b>.</li> <li>• <i>Token</i> is <b>NULL</b>.</li> <li>• <i>Token.Event</i> is <b>NULL</b>.</li> <li>• <i>Token.Packet.TxData</i> is <b>NULL</b>.</li> <li>• <i>Token.Packet.ExtHdrsLength</i> is not zero and <i>Token.Packet.ExtHdrs</i> is <b>NULL</b>.</li> <li>• <i>Token.Packet.FragmentCount</i> is zero.</li> <li>• One or more of the <i>Token.Packet.TxData.FragmentTable[].FragmentLength</i> fields is zero.</li> <li>• One or more of the <i>Token.Packet.TxData.FragmentTable[].FragmentBuffer</i> fields is <b>NULL</b>.</li> <li>• <i>Token.Packet.TxData.DataLength</i> is zero or not equal to the sum of fragment lengths.</li> <li>• <i>Token.Packet.TxData.DestinationAddress</i> is non-zero when <i>DestinationAddress</i> is configured as non-zero when doing <b>Configure()</b> for this EFI IPv6 protocol instance.</li> <li>• <i>Token.Packet.TxData.DestinationAddress</i> is unspecified when <i>DestinationAddress</i> is unspecified when doing <b>Configure()</b> for this EFI IPv6 protocol instance.</li> </ul>
EFI_ACCESS_DENIED	The transmit completion token with the same <i>Token.Event</i> was already in the transmit queue.
EFI_NOT_READY	The completion token could not be queued because the transmit queue is full.
EFI_NOT_FOUND	No route was found to destination address.
EFI_OUT_OF_RESOURCES	Could not queue the transmit data.
EFI_BUFFER_TOO_SMALL	<i>Token.Packet.TxData.DataLength</i> is too short to transmit.
EFI_BAD_BUFFER_SIZE	If <i>Token.Packet.TxData.DataLength</i> is beyond the maximum that which can be described through the Fragment Offset field in Fragment header when performing fragmentation.
EFI_DEVICE_ERROR	An unexpected system or network error occurred.
EFI_NO_MEDIA	There was a media error.

## EFI\_IP6\_PROTOCOL.Receive()

### Summary

Places a receiving request into the receiving queue.

### Prototype

```
typedef
EFI_STATUS
(EFI_API *EFI_IP6_RECEIVE) (
    IN EFI_IP6_PROTOCOL *This,
    IN EFI_IP6_COMPLETION_TOKEN *Token
);
```

### Parameters

*This*

Pointer to the **EFI\_IP6\_PROTOCOL** instance.

*Token*

Pointer to a token that is associated with the receive data descriptor. Type **EFI\_IP6\_COMPLETION\_TOKEN** is defined in "Related Definitions" of above **Transmit()**.

### Description

The **Receive()** function places a completion token into the receive packet queue. This function is always asynchronous.

The *Token.Event* field in the completion token must be filled in by the caller and cannot be **NULL**. When the receive operation completes, the EFI IPv6 Protocol driver updates the *Token.Status* and *Token.Packet.RxData* fields and the *Token.Event* is signaled.

## Status Codes Returned

EFI_SUCCESS	The receive completion token was cached.
EFI_NOT_STARTED	This EFI IPv6 Protocol instance has not been started.
EFI_NO_MAPPING	When IP6 driver responsible for binding source address to this instance, while no source address is available for use.
EFI_INVALID_PARAMETER	One or more of the following conditions is <b>TRUE</b> : <i>This</i> is <b>NULL</b> . <i>Token</i> is <b>NULL</b> . <i>Token.Event</i> is <b>NULL</b> .
EFI_OUT_OF_RESOURCES	The receive completion token could not be queued due to a lack of system resources (usually memory).
EFI_DEVICE_ERROR	An unexpected system or network error occurred. The EFI IPv6 Protocol instance has been reset to startup defaults.
EFI_ACCESS_DENIED	The receive completion token with the same <i>Token.Event</i> was already in the receive queue.
EFI_NOT_READY	The receive request could not be queued because the receive queue is full.
EFI_DEVICE_ERROR	An unexpected system or network error occurred.
EFI_NO_MEDIA	There was a media error.

## EFI\_IP6\_PROTOCOL.Cancel()

### Summary

Abort an asynchronous transmits or receive request.

### Prototype

```
typedef
EFI_STATUS
(EFI_API *EFI_IP6_CANCEL)(
    IN EFI_IP6_PROTOCOL *This,
    IN EFI_IP6_COMPLETION_TOKEN *Token OPTIONAL
);
```

### Parameters

*This* Pointer to the **EFI\_IP6\_PROTOCOL** instance.

*Token* Pointer to a token that has been issued by **EFI\_IP6\_PROTOCOL.Transmit()** or **EFI\_IP6\_PROTOCOL.Receive()**. If **NULL**, all pending tokens are aborted. Type **EFI\_IP6\_COMPLETION\_TOKEN** is defined in **EFI\_IP6\_PROTOCOL.Transmit()**.

### Description

The **Cancel()** function is used to abort a pending transmit or receive request. If the token is in the transmit or receive request queues, after calling this function, *Token->Status* will be set to **EFI\_ABORTED** and then *Token->Event* will be signaled. If the token is not in one of the queues, which usually means the asynchronous operation has completed, this function will not signal the token and **EFI\_NOT\_FOUND** is returned.

### Status Codes Returned

EFI_SUCCESS	The asynchronous I/O request was aborted and <i>Token-&gt;Event</i> was signaled. When <i>Token</i> is <b>NULL</b> , all pending requests were aborted and their events were signaled.
EFI_INVALID_PARAMETER	<i>This</i> is <b>NULL</b> .
EFI_NOT_STARTED	This instance has not been started.
EFI_NOT_FOUND	When <i>Token</i> is not <b>NULL</b> , the asynchronous I/O request was not found in the transmit or receive queue. It has either completed or was not issued by <b>Transmit()</b> and <b>Receive()</b> .
EFI_DEVICE_ERROR	An unexpected system or network error occurred.

## EFI\_IP6\_PROTOCOL.Poll()

### Summary

Polls for incoming data packets and processes outgoing data packets.

### Prototype

```
typedef
EFI_STATUS
(EFI_API *EFI_IP6_POLL) (
    IN EFI_IP6_PROTOCOL          *This
);
```

### Description

The **Poll()** function polls for incoming data packets and processes outgoing data packets. Network drivers and applications can call the **EFI\_IP6\_PROTOCOL.Poll()** function to increase the rate that data packets are moved between the communications device and the transmit and receive queues.

In some systems the periodic timer event may not poll the underlying communications device fast enough to transmit and/or receive all data packets without missing incoming packets or dropping outgoing packets. Drivers and applications that are experiencing packet loss should try calling the **EFI\_IP6\_PROTOCOL.Poll()** function more often.

### Status Codes Returned

EFI_SUCCESS	Incoming or outgoing data was processed.
EFI_NOT_STARTED	This EFI IPv6 Protocol instance has not been started.
EFI_INVALID_PARAMETER	<i>This</i> is <b>NULL</b> .
EFI_DEVICE_ERROR	An unexpected system or network error occurred.
EFI_NOT_READY	No incoming or outgoing data is processed.
EFI_TIMEOUT	Data was dropped out of the transmit and/or receive queue. Consider increasing the polling rate.

## 28.7 EFI IPv6 Configuration Protocol

This section provides a detailed description of the EFI IPv6 Configuration Protocol.

### EFI\_IP6\_CONFIG\_PROTOCOL

#### Summary

The **EFI\_IP6\_CONFIG\_PROTOCOL** provides the mechanism to set and get various types of configurations for the EFI IPv6 network stack.

## GUID

```
#define EFI_IP6_CONFIG_PROTOCOL_GUID \
{0x937fe521,0x95ae,0x4d1a,\
{0x89,0x29,0x48,0xbc,0xd9,0x0a,0xd3,0x1a}}
```

## Protocol Interface Structure

```
typedef struct _EFI_IP6_CONFIG_PROTOCOL {
  EFI_IP6_CONFIG_SET_DATA  SetData;
  EFI_IP6_CONFIG_GET_DATA  GetData;
  EFI_IP6_CONFIG_REGISTER_NOTIF  RegisterDataNotify;
  EFI_IP6_CONFIG_UNREGISTER_NOTIFY  UnregisterDataNotify;
} EFI_IP6_CONFIG_PROTOCOL;
```

## Parameters

<i>SetData</i>	Set the configuration for the EFI IPv6 network stack running on the communication device this EFI IPv6 Configuration Protocol instance manages. See the <b>SetData()</b> function description.
<i>GetData</i>	Get the configuration or register an event to monitor the change of the configuration for the EFI IPv6 network stack running on the communication device this EFI IPv6 Configuration Protocol instance manages. See the <b>GetData()</b> function description.
<i>RegisterDataNotify</i>	Register an event that is to be signaled whenever a configuration process on the specified configuration data is done.
<i>UnregisterDataNotify</i>	Remove a previously registered event for the specified configuration data.

## Description

The **EFI\_IP6\_CONFIG\_PROTOCOL** is designed to be the central repository for the common configurations and the administrator configurable settings for the EFI IPv6 network stack.

An EFI IPv6 Configuration Protocol instance will be installed on each communication device that the EFI IPv6 network stack runs on.

## EFI\_IP6\_CONFIG\_PROTOCOL.SetData()

### Summary

Set the configuration for the EFI IPv6 network stack running on the communication device this EFI IPv6 Configuration Protocol instance manages.

### Prototype

```
typedef
EFI_STATUS
(EFI_API *EFI_IP6_CONFIG_SET_DATA) (
  IN EFI_IP6_CONFIG_PROTOCOL *This,
  IN EFI_IP6_CONFIG_DATA_TYPE DataType,
  IN UINTN DataSize,
  IN VOID *Data
);
```

### Parameters

<i>This</i>	Pointer to the <b>EFI_IP6_CONFIG_PROTOCOL</b> instance.
<i>Data</i> Type	The type of data to set. Type <b>EFI_IP6_CONFIG_DATA_TYPE</b> is defined in "Related Definitions" below.
<i>Data</i> Size	Size of the buffer pointed to by <i>Data</i> in bytes.
<i>Data</i>	The data buffer to set. The type of the data buffer is associated with the <i>Data</i> Type. The various types are defined in "Related Definitions" below.

### Description

This function is used to set the configuration data of type *Data*Type for the EFI IPv6 network stack running on the communication device this EFI IPv6 Configuration Protocol instance manages.

The *Data*Size is used to calculate the count of structure instances in the *Data* for some *Data*Type that multiple structure instances are allowed.

This function is always non-blocking. When setting some type of configuration data, an asynchronous process is invoked to check the correctness of the data, such as doing Duplicate Address Detection on the manually set local IPv6 addresses. **EFI\_NOT\_READY** is returned immediately to indicate that such an asynchronous process is invoked and the process is not finished yet. The caller willing to get the result of the asynchronous process is required to call **RegisterDataNotify()** to register an event on the specified configuration data. Once the event is signaled, the caller can call **GetData()** to get back the configuration data in order to know the result. For other types of configuration data that do not require an asynchronous configuration process, the result of the operation is immediately returned.

## Related Definitions

```

//*****
// EFI_IP6_CONFIG_DATA_TYPE
//*****
typedef enum {
  Ip6ConfigDataTypeInterfaceInfo,
  Ip6ConfigDataTypeAltInterfaceId,
  Ip6ConfigDataTypePolicy,
  Ip6ConfigDataTypeDupAddrDetectTransmits,
  Ip6ConfigDataTypeManualAddress,
  Ip6ConfigDataTypeGateway,
  Ip6ConfigDataTypeDnsServer,
  Ip6ConfigDataTypeMaximum
} EFI_IP6_CONFIG_DATA_TYPE;

```

*Ip6ConfigDataTypeInterfaceInfo* The interface information of the communication device this EFI IPv6 Configuration Protocol instance manages. This type of data is read only. The corresponding *Data* is of type **EFI\_IP6\_CONFIG\_INTERFACE\_INFO**.

*Ip6ConfigDataTypeAltInterfaceId* The alternative interface ID for the communication device this EFI IPv6 Configuration Protocol instance manages if the link local IPv6 address generated from the interfaced ID based on the default source the EFI IPv6 Protocol uses is a duplicate address. The length of the interface ID is 64 bit. The corresponding *Data* is of type **EFI\_IP6\_CONFIG\_INTERFACE\_ID**.

*Ip6ConfigDataTypePolicy* The general configuration policy for the EFI IPv6 network stack running on the communication device this EFI IPv6 Configuration Protocol instance manages. The policy will affect other configuration settings. The corresponding *Data* is of type **EFI\_IP6\_CONFIG\_POLICY**.

*Ip6ConfigDataTypeDupAddrDetectTransmits* The number of consecutive Neighbor Solicitation messages sent while performing Duplicate Address Detection on a tentative address. A value of zero indicates that Duplicate Address Detection will not be performed on tentative addresses. The corresponding *Data* is of type **EFI\_IP6\_CONFIG\_DUP\_ADDR\_DETECT\_TRANSMITS**.

*Ip6ConfigDataTypeManualAddress* The station addresses set manually for the EFI IPv6 network stack. It is only configurable when the policy is *Ip6ConfigPolicyManual*. The corresponding *Data* is a pointer to an array of **EFI\_IPv6\_ADDRESS** instances. When *DataSize* is 0 and *Data* is **NULL**, the existing configuration is cleared from the EFI IPv6 Configuration Protocol instance.



*Ip6ConfigDataTypeGateway* The gateway addresses set manually for the EFI IPv6 network stack running on the communication device this EFI IPv6 Configuration Protocol manages. It is not configurable when the policy is *Ip6ConfigPolicyAutomatic*. The gateway addresses must be unicast IPv6 addresses. The corresponding *Data* is a pointer to an array of **EFI\_IPv6\_ADDRESS** instances. When *DataSize* is 0 and *Data* is **NULL**, the existing configuration is cleared from the EFI IPv6 Configuration Protocol instance.

*Ip6ConfigDataTypeDnsServer* The DNS server list for the EFI IPv6 network stack running on the communication device this EFI IPv6 Configuration Protocol manages. It is not configurable when the policy is *Ip6ConfigPolicyAutomatic*. The DNS server addresses must be unicast IPv6 addresses. The corresponding *Data* is a pointer to an array of **EFI\_IPv6\_ADDRESS** instances. When *DataSize* is 0 and *Data* is **NULL**, the existing configuration is cleared from the EFI IPv6 Configuration Protocol instance.

```

//*****
// EFI_IP6_CONFIG_INTERFACE_INFO
//*****
typedef struct {
  CHAR16      Name[32];
  UINT8      IfType;
  UINT32      HwAddressSize;
  EFI_MAC_ADDRESS HwAddress;
  UINT32      AddressInfoCount;
  EFI_IP6_ADDRESS_INFO *AddressInfo;
  UINT32      RouteCount;
  EFI_IP6_ROUTE_TABLE *RouteTable;
} EFI_IP6_CONFIG_INTERFACE_INFO;

```

<i>Name</i>	The name of the interface. It is a NULL-terminated string.
<i>IfType</i>	The interface type of the network interface. See RFC 3232, section “Number Hardware Type”.
<i>HwAddressSize</i>	The size, in bytes, of the network interface’s hardware address.
<i>HwAddress</i>	The hardware address for the network interface.
<i>AddressInfoCount</i>	Number of <b>EFI_IP6_ADDRESS_INFO</b> structures pointed to by <i>AddressInfo</i> .
<i>AddressInfo</i>	Pointer to an array of <b>EFI_IP6_ADDRESS_INFO</b> instances which contain the local IPv6 addresses and the corresponding prefix length information. Set to <b>NULL</b> if <i>AddressInfoCount</i> is zero. Type <b>EFI_IP6_ADDRESS_INFO</b> is defined in <b>EFI_IP6_PROTOCOL.GetModeData()</b> .
<i>RouteCount</i>	Number of route table entries in the following <i>RouteTable</i> .

*RouteTable* The route table of the IPv6 network stack runs on this interface. Set to **NULL** if *RouteCount* is zero. Type **EFI\_IP6\_ROUTE\_TABLE** is defined in **EFI\_IP6\_PROTOCOL.GetModeData()**.

The **EFI\_IP6\_CONFIG\_INTERFACE\_INFO** structure describes the operational state of the interface this EFI IPv6 Configuration Protocol instance manages. This type of data is read-only. When reading, the caller allocated buffer is used to return all of the data, i.e., the first part of the buffer is **EFI\_IP6\_CONFIG\_INTERFACE\_INFO** and the followings are the array of **EFI\_IP6\_ADDRESS\_INFO** and the route table if present. The caller should NOT free the buffer pointed to by *AddressInfo* or *RouteTable*, and the caller is only required to free the whole buffer if the data is not needed any more.

```

//*****
// EFI_IP6_CONFIG_INTERFACE_ID
//*****
typedef struct {
    UINT8  Id[8];
} EFI_IP6_CONFIG_INTERFACE_ID;

```

The **EFI\_IP6\_CONFIG\_INTERFACE\_ID** structure describes the 64-bit interface ID.

```

//*****
// EFI_IP6_CONFIG_POLICY
//*****
typedef enum {
    Ip6ConfigPolicyManual,
    Ip6ConfigPolicyAutomatic
} EFI_IP6_CONFIG_POLICY;

```

*Ip6ConfigPolicyManual* Under this policy, the *Ip6ConfigDataTypeManualAddress*, *Ip6ConfigDataTypeGateway* and *Ip6ConfigDataTypeDnsServer* configuration data are required to be set manually. The EFI IPv6 Protocol will get all required configuration such as address, prefix and gateway settings from the EFI IPv6 Configuration protocol.

*Ip6ConfigPolicyAutomatic* Under this policy, the *Ip6ConfigDataTypeManualAddress*, *Ip6ConfigDataTypeGateway* and *Ip6ConfigDataTypeDnsServer* configuration data are not allowed to set via **SetData()**. All of these configurations are retrieved from some auto configuration mechanism. The EFI IPv6 Protocol will use the IPv6 stateless address autoconfiguration mechanism and/or the IPv6 stateful address autoconfiguration mechanism described in the related RFCs to get address and other configuration information.

The **EFI\_IP6\_CONFIG\_POLICY** defines the general configuration policy the EFI IPv6 Configuration Protocol supports. The default policy for a newly detected communication device is beyond the scope of this document. An implementation might leave it to platform to choose the default policy.

The configuration data of type *Ip6ConfigDataTypeManualAddress*, *Ip6ConfigDataTypeGateway* and *Ip6ConfigDataTypeDnsServer* will be flushed if the policy is changed from *Ip6ConfigPolicyManual* to *Ip6ConfigPolicyAutomatic*.

```

//*****
// EFI_IP6_CONFIG_DUP_ADDR_DETECT_TRANSMITS
//*****
typedef struct {
    UINT32    DupAddrDetectTransmits;
} EFI_IP6_CONFIG_DUP_ADDR_DETECT_TRANSMITS;

```

The **EFI\_IP6\_CONFIG\_DUP\_ADDR\_DETECT\_TRANSMITS** structure describes the number of consecutive Neighbor Solicitation messages sent while performing Duplicate Address Detection on a tentative address. The default value for a newly detected communication device is 1.

```

//*****
// EFI_IP6_CONFIG_MANUAL_ADDRESS
//*****
typedef struct {
    EFI_IPv6_ADDRESS    Address;
    BOOLEAN             IsAnycast;
    UINT8               PrefixLength;
} EFI_IP6_CONFIG_MANUAL_ADDRESS;

```

<i>Address</i>	The IPv6 unicast address.
<i>IsAnycast</i>	Set to <b>TRUE</b> if <i>Address</i> is anycast.
<i>PrefixLength</i>	The length, in bits, of the prefix associated with this <i>Address</i> .

The **EFI\_IP6\_CONFIG\_MANUAL\_ADDRESS** structure is used to set the station address information for the EFI IPv6 network stack manually when the policy is *Ip6ConfigPolicy-Manual*.

## Status Codes Returned

EFI_SUCCESS	The specified configuration data for the EFI IPv6 network stack is set successfully.
EFI_INVALID_PARAMETER	One or more of the following are <b>TRUE</b> : <ul style="list-style-type: none"> <li>• <i>This</i> is <b>NULL</b>.</li> <li>• One or more fields in <i>Data</i> and <i>DataSize</i> do not match the requirement of the data type indicated by <i>Data Type</i>.</li> </ul>
EFI_WRITE_PROTECTED	The specified configuration data is read-only or the specified configuration data can not be set under the current policy.
EFI_ACCESS_DENIED	Another set operation on the specified configuration data is already in process.
EFI_NOT_READY	An asynchronous process is invoked to set the specified configuration data and the process is not finished yet.
EFI_BAD_BUFFER_SIZE	The <i>DataSize</i> does not match the size of the type indicated by <i>Data Type</i> .
EFI_UNSUPPORTED	This <i>Data Type</i> is not supported.
EFI_OUT_OF_RESOURCES	Required system resources could not be allocated.
EFI_DEVICE_ERROR	An unexpected system error or network error occurred.

## EFI\_IP6\_CONFIG\_PROTOCOL.GetData()

### Summary

Get the configuration data for the EFI IPv6 network stack running on the communication device this EFI IPv6 Configuration Protocol instance manages.

### Prototype

```
typedef
EFI_STATUS
(EFI_API *EFI_IP6_CONFIG_GET_DATA) (
  IN EFI_IP6_CONFIG_PROTOCOL *This,
  IN EFI_IP6_CONFIG_DATA_TYPE DataType,
  IN OUT UINTN *DataSize,
  IN VOID *Data OPTIONAL
);
```

### Parameters

<i>This</i>	Pointer to the <b>EFI_IP6_CONFIG_PROTOCOL</b> instance.
<i>DataType</i>	The type of data to get. Type <b>EFI_IP6_CONFIG_DATA_TYPE</b> is defined in <b>EFI_IP6_CONFIG_PROTOCOL.SetData()</b> .
<i>DataSize</i>	On input, in bytes, the size of <i>Data</i> . On output, in bytes, the size of buffer required to store the specified configuration data.
<i>Data</i>	The data buffer in which the configuration data is returned. The type of the data buffer is associated with the <i>DataType</i> . Ignored if <i>DataSize</i> is 0. The various types are defined in <b>EFI_IP6_CONFIG_PROTOCOL.SetData()</b> .

### Description

This function returns the configuration data of type *DataType* for the EFI IPv6 network stack running on the communication device this EFI IPv6 Configuration Protocol instance manages.

The caller is responsible for allocating the buffer used to return the specified configuration data and the required size will be returned to the caller if the size of the buffer is too small.

**EFI\_NOT\_READY** is returned if the specified configuration data is not ready due to an already in progress asynchronous configuration process. The caller can call **RegisterDataNotify()** to register an event on the specified configuration data. Once the asynchronous configuration process is finished, the event will be signaled and a subsequent **GetData()** call will return the specified configuration data.

## Status Codes Returned

EFI_SUCCESS	The specified configuration data is got successfully.
EFI_INVALID_PARAMETER	One or more of the followings are <b>TRUE</b> : <ul style="list-style-type: none"> <li>• <i>This</i> is <b>NULL</b>.</li> <li>• <i>DataSize</i> is <b>NULL</b>.</li> <li>• <i>Data</i> is <b>NULL</b> if <i>*DataSize</i> is not zero.</li> </ul>
EFI_BUFFER_TOO_SMALL	The size of <i>Data</i> is too small for the specified configuration data and the required size is returned in <i>DataSize</i> .
EFI_NOT_READY	The specified configuration data is not ready due to an already in progress asynchronous configuration process.
EFI_NOT_FOUND	The specified configuration data is not found.

## EFI\_IP6\_CONFIG\_PROTOCOL.RegisterDataNotify ()

### Summary

Register an event that is to be signaled whenever a configuration process on the specified configuration data is done.

### Prototype

```
typedef
EFI_STATUS
(EFI_API *EFI_IP6_CONFIG_REGISTER_NOTIFY) (
  IN EFI_IP6_CONFIG_PROTOCOL *This,
  IN EFI_IP6_CONFIG_DATA_TYPE DataType,
  IN EFI_EVENT Event
);
```

### Parameters

<i>This</i>	Pointer to the <b>EFI_IP6_CONFIG_PROTOCOL</b> instance.
<i>DataType</i>	The type of data to unregister the event for. Type <b>EFI_IP6_CONFIG_DATA_TYPE</b> is defined in <b>EFI_IP6_CONFIG_PROTOCOL.SetData()</b> .
<i>Event</i>	The event to register.

### Description

This function registers an event that is to be signaled whenever a configuration process on the specified configuration data is done. An event can be registered for different *DataType* simultaneously and the caller is responsible for determining which type of configuration data causes the signaling of the event in such case.

### Status Codes Returned

EFI_SUCCESS	The notification event for the specified configuration data is registered.
EFI_INVALID_PARAMETER	<i>This</i> is <b>NULL</b> or <i>Event</i> is <b>NULL</b> .
EFI_UNSUPPORTED	The configuration data type specified by <i>DataType</i> is not supported.
EFI_OUT_OF_RESOURCES	Required system resources could not be allocated.
EFI_ACCESS_DENIED	The <i>Event</i> is already registered for the <i>DataType</i> .

## EFI\_IP6\_CONFIG\_PROTOCOL.UnregisterDataNotify ()

### Summary

Remove a previously registered event for the specified configuration data.

### Prototype

```
typedef
EFI_STATUS
(EFI_API *EFI_IP6_CONFIG_UNREGISTER_NOTIFY) (
  IN EFI_IP6_CONFIG_PROTOCOL *This,
  IN EFI_IP6_CONFIG_DATA_TYPE DataType,
  IN EFI_EVENT Event
);
```

### Parameters

<i>This</i>	Pointer to the <b>EFI_IP6_CONFIG_PROTOCOL</b> instance.
<i>DataType</i>	The type of data to remove the previously registered event for. Type <b>EFI_IP6_CONFIG_DATA_TYPE</b> is defined in <b>EFI_IP6_CONFIG_PROTOCOL.SetData()</b> .
<i>Event</i>	The event to unregister.

### Description

This function removes a previously registered event for the specified configuration data.

### Status Codes Returned

EFI_SUCCESS	The event registered for the specified configuration data is removed.
EFI_INVALID_PARAMETER	<i>This</i> is <b>NULL</b> or <i>Event</i> is <b>NULL</b> .
EFI_NOT_FOUND	The <i>Event</i> has not been registered for the specified <i>DataType</i> .

## 28.8 IPsec

### 28.8.1 IPsec Overview

IPsec is a framework of open standards that provides data confidentiality, data integrity, data authentication and replay protection between participating peers. A set of security services is provided by IPsec for traffic at the IP layer, in both the IPv4 and IPv6 environment. To the stronger, IPV6 requires IPsec support.

IPsec is documented in a series of Internet RFCs. The overall IPsec architecture and implementation are guided by "Security Architecture for the Internet Protocol", RFC 4301.



Two different security protocols – Authentication Header (AH, described in RFC 4302) and Encapsulated Security Payload (ESP, described in RFC 4303) – are used to provide package-level security for IP datagram.

This section attempts to capture the generic configuration for an IPsec implementation in an EFI environment.

## 28.8.2 EFI IPsec Configuration Protocol

This section provides a detailed description of the EFI IPsec Configuration Protocol. This protocol sets and obtains the IPsec configuration information.

### EFI\_IPSEC\_CONFIG\_PROTOCOL

#### Summary

The **EFI\_IPSEC\_CONFIG\_PROTOCOL** provides the mechanism to set and retrieve security and policy related information for the EFI IPsec protocol driver.

#### GUID

```
#define EFI_IPSEC_CONFIG_PROTOCOL_GUID \
{0xce5e5929,0xc7a3,0x4602,\
{0xad,0x9e,0xc9,0xda,0xf9,0x4e,0xbf,0xcf}}
```

#### Protocol Interface Structure

```
typedef struct _EFI_IPSEC_CONFIG_PROTOCOL {
  EFI_IPSEC_CONFIG_SET_DATA    SetData;
  EFI_IPSEC_CONFIG_GET_DATA    GetData;
  EFI_IPSEC_CONFIG_GET_NEXT_SELECTOR GetNextSelector;
  EFI_IPSEC_CONFIG_REGISTER_NOTIFY RegisterDataNotify;
  EFI_IPSEC_CONFIG_UNREGISTER_NOTIFY UnregisterDataNotify;
} EFI_IPSEC_CONFIG_PROTOCOL;
```

#### Parameters

<i>SetData</i>	Set the configuration and control information for the EFI IPsec protocol driver. See the <b>SetData()</b> function description.
<i>GetData</i>	Look up and retrieve the IPsec configuration data. See the <b>GetData()</b> function description.
<i>GetNextSelector</i>	Enumerates the current IPsec configuration data entry selector. See the <b>GetNextSelector()</b> function description.
<i>RegisterNotify</i>	Register an event that is to be signaled whenever a configuration process on the specified IPsec configuration data is done.

*UnregisterNotify*

Remove a registered event for the specified IPsec configuration data.

**Description**

The **EFI\_IPSEC\_CONFIG\_PROTOCOL** provides the ability to set and lookup the IPsec SAD (Security Association Database), SPD (Security Policy Database) data entry and configure the security association management protocol such as IKEv2. This protocol is used as the central repository of any policy-specific configuration for EFI IPsec driver.

**EFI\_IPSEC\_CONFIG\_PROTOCOL** can be bound to both IPv4 and IPv6 stack. User can use this protocol for IPsec configuration in both IPv4 and IPv6 environment.

## EFI\_IPSEC\_CONFIG\_PROTOCOL.SetData()

### Summary

Set the security association, security policy and peer authorization configuration information for the EFI IPsec driver.

### Prototype

```
typedef
EFI_STATUS
(EFIAPI *EFI_IPSEC_CONFIG_SET_DATA) (
  IN EFI_IPSEC_CONFIG_PROTOCOL *This,
  IN EFI_IPSEC_CONFIG_DATA_TYPE DataType,
  IN EFI_IPSEC_CONFIG_SELECTOR *Selector,
  IN VOID *Data
  IN EFI_IPSEC_CONFIG_SELECTOR *InsertBefore OPTIONAL
);
```

### Parameters

<i>This</i>	Pointer to the <b>EFI_IPSEC_CONFIG_PROTOCOL</b> instance.
<i>InsertBefore</i>	Pointer to one entry selector which describes the expected position the new data entry will be added. If <i>InsertBefore</i> is <b>NULL</b> , the new entry will be appended the end of database.
<i>DataType</i>	The type of data to be set. Type <b>EFI_IPSEC_CONFIG_DATA_TYPE</b> is defined in "Related Definitions" below.
<i>Selector</i>	Pointer to an entry selector on operated configuration data specified by <i>DataType</i> . A <b>NULL</b> <i>Selector</i> causes the entire specified-type configuration information to be flushed.
<i>Data</i>	The data buffer to be set. The structure of the data buffer is associated with the <i>DataType</i> . The various types are defined in "Related Definitions" below.

### Description

This function is used to set the IPsec configuration information of type *DataType* for the EFI IPsec driver.

The IPsec configuration data has a unique selector/identifier separately to identify a data entry. The selector structure depends on *DataType's* definition.

Using **SetData()** with a *Data* of **NULL** causes the IPsec configuration data entry identified by *DataType* and *Selector* to be deleted.

## Related Definitions

```
//*****
// EFI_IPSEC_CONFIG_DATA_TYPE
//*****
typedef enum {
  IPsecConfigDataTypeSpd,
  IPsecConfigDataTypeSad,
  IPsecConfigDataTypePad,
  IPsecConfigDataTypeMaximum
} EFI_IPSEC_CONFIG_DATA_TYPE;
```

### *IPsecConfigDataTypeSpd*

The IPsec Security Policy Database (aka SPD) setting. In IPsec, an essential element of Security Association (SA) processing is underlying SPD that specifies what services are to be offered to IP datagram and in what fashion. The SPD must be consulted during the processing of all traffic (inbound and outbound), including traffic not protected by IPsec, that traverses the IPsec boundary. With this *Data Type*, **SetData()** function is to set the SPD entry information, which may add one new entry, delete one existed entry or flush the whole database according to the parameter values. The corresponding *Data* is of type **EFI\_IPSEC\_SPD\_DATA**.

### *IPsecConfigDataTypeSad*

The IPsec Security Association Database (aka SAD) setting. A SA is a simplex connection that affords security services to the traffic carried by it. Security services are afforded to an SA by the use of AH, or ESP, but not both. The corresponding *Data* is of type **EFI\_IPSEC\_SA\_DATA2** or **EFI\_IPSEC\_SAD\_DATA**. Compared with **EFI\_IPSEC\_SA\_DATA**, the **EFI\_IPSEC\_SA\_DATA2** contains the extra Tunnel Source Address and Tunnel Destination Address thus it is recommended to be use if the implementation supports tunnel mode.

### *IPsecConfigDataTypePad*

The IPsec Peer Authorization Database (aka PAD) setting, which provides the link between the SPD and a security association management protocol. The PAD entry specifies the authentication protocol (e.g. IKEv1, IKEv2) method used and the authentication data. The corresponding *Data* is of type **EFI\_IPSEC\_PAD\_DATA**.

```

//*****
// EFI_IPSEC_CONFIG_SELECTOR
//*****
typedef union {
  EFI_IPSEC_SPD_SELECTOR   SpdSelector;
  EFI_IPSEC_SA_ID         Sald;
  EFI_IPSEC_PAD_ID        PadId;
} EFI_IPSEC_CONFIG_SELECTOR;

```

The **EFI\_IPSEC\_CONFIG\_SELECTOR** describes the expected IPsec configuration data selector of type **EFI\_IPSEC\_CONFIG\_DATA\_TYPE**.

```

//*****
// EFI_IPSEC_SPD_SELECTOR
//*****
typedef struct _EFI_IPSEC_SPD_SELECTOR {
  UINT32      LocalAddressCount;
  EFI_IP_ADDRESS_INFO  *LocalAddress;
  UINT32      RemoteAddressCount;
  EFI_IP_ADDRESS_INFO  *RemoteAddress;
  UINT16      NextLayerProtocol;

  // Several additional selectors depend on the ProtoFamily
  UINT16      LocalPort;
  UINT16      LocalPortRange;
  UINT16      RemotePort;
  UINT16      RemotePortRange;
} EFI_IPSEC_SPD_SELECTOR;

```

*LocalAddressCount* Specifies the actual number of entries in *LocalAddress*.

*LocalAddress* A list of ranges of IPv4 or IPv6 addresses, which refers to the addresses being protected by IPsec policy.

*RemoteAddressCount* Specifies the actual number of entries in *RemoteAddress*.

*RemoteAddress* A list of ranges of IPv4 or IPv6 addresses, which are peer entities to *LocalAddress*.

*NextLayerProtocol* Next layer protocol. Obtained from the IPv4 Protocol or the IPv6 Next Header fields. The next layer protocol is whatever comes after any IP extension headers that are present. A zero value is a wildcard that matches any value in *NextLayerProtocol* field.

*LocalPort* Local Port if the Next Layer Protocol uses two ports (as do TCP, UDP, and others). A zero value is a wildcard that matches any value in *LocalPort* field.

*LocalPortRange* A designed port range size. The start port is *LocalPort*, and the total number of ports is described by *LocalPortRange*.

	This field is ignored if <i>NextLayerProtocol</i> does not use ports.
<i>RemotePort</i>	Remote Port if the Next Layer Protocol uses two ports. A zero value is a wildcard that matches any value in <i>RemotePort</i> field.
<i>RemotePortRange</i>	A designed port range size. The start port is <i>RemotePort</i> , and the total number of ports is described by <i>RemotePortRange</i> . This field is ignored if <i>NextLayerProtocol</i> does not use ports.

**Note:** The *LocalPort* and *RemotePort* selectors have different meaning depending on the *NextLayerProtocol* field. for example, if *NextLayerProtocol* value is ICMP, *LocalPort* and *RemotePort* describe the ICMP message type and code. This is described in section 4.4.1.1 of RFC 4301).

```

//*****
// EFI_IP_ADDRESS_INFO
//*****
typedef struct _EFI_IP_ADDRESS_INFO {
    EFI_IP_ADDRESS    Address;
    UINT8             PrefixLength;
} EFI_IP_ADDRESS_INFO;

    Address                The IPv4 or IPv6 address.
    PrefixLength           The length of the prefix associated with the Address.

```

```
#define MAX_PEERID_LEN 128
```

```

//*****
// EFI_IPSEC_SPD_DATA
//*****
typedef struct _EFI_IPSEC_SPD_DATA {
    UINT8             *Name[MAX_PEERID_LEN];
    UINT32            PackageFlag;
    EFI_IPSEC_TRAFFIC_DIR    TrafficDirection;
    EFI_IPSEC_ACTION    Action;
    EFI_IPSEC_PROCESS_POLICY *ProcessingPolicy;
    UINTN             SaldCount;
    EFI_IPSEC_SA_ID    *Sald[1];
} EFI_IPSEC_SPD_DATA;

```

<i>Name</i>	A null-terminated ASCII name string which is used as a symbolic identifier for an IPsec Local or Remote address. The <i>Name</i> is optional, and can be <b>NULL</b> .
<i>PackageFlag</i>	Bit-mapped list describing Populate from Packet flags. When creating a SA, if <i>PackageFlag</i> bit is set to <b>TRUE</b> , instantiate the selector from the corresponding field in the package that triggered the creation of the SA, else from the value(s) in the corresponding SPD entry. The

*PackageFlag* bit setting for corresponding selector field of **EFI\_IPSEC\_SPD\_SELECTOR**:

Bit 0: **EFI\_IPSEC\_SPD\_SELECTOR.LocalAddress**  
 Bit 1: **EFI\_IPSEC\_SPD\_SELECTOR.RemoteAddress**  
 Bit 2: **EFI\_IPSEC\_SPD\_SELECTOR.NextLayerProtocol**  
 Bit 3: **EFI\_IPSEC\_SPD\_SELECTOR.LocalPort**  
 Bit 4: **EFI\_IPSEC\_SPD\_SELECTOR.RemotePort**  
 Others: Reserved.

*TrafficDirection*

The traffic direction of data gram.

*Action*

Processing choices to indicate which action is required by this policy.

*ProcessingPolicy*

The policy and rule information for a SPD entry. The type **EFI\_IPSEC\_PROCESSPOLICY** is defined in below.

*SaldCount*

Specifies the actual number of entries in *Sald* list.

*Sald*

Pointer to the SAD entry used for the traffic processing. The existed SAD entry links indicate this is the manual key case.

```

//*****
// EFI_IPSEC_TRAFFIC_DIR
//*****
typedef enum {
    EfiIPsecInBound,
    EfiIPsecOutBound
} EFI_IPSEC_TRAFFIC_DIR;

```

The **EFI\_IPSEC\_TRAFFIC\_DIR** represents the directionality in an SPD entry. The **EfiIPsecInBound** refers to traffic entering an IPsec implementation via the unprotected interface or emitted by the implementation on the unprotected side of the boundary and directed towards the protected interface. The **EfiIPsecOutBound** refers to traffic entering the implementation via the protected interface, or emitted by the implementation on the protected side of the boundary and directed toward the unprotected interface.

```

//*****
// EFI_IPSEC_ACTION
//*****
typedef enum {
    EfiIPsecActionDiscard,
    EfiIPsecActionBypass,
    EfiIPsecActionProtect
} EFI_IPSEC_ACTION;

```

For any inbound or outbound datagram, **EFI\_IPSEC\_ACTION** represents three possible processing choices:

*EfiIPsecActionDiscard*

Refers to traffic that is not allowed to traverse the IPsec boundary (in the direction specified by **EFI\_IPSEC\_TRAFFIC\_DIR**;

*EfiIPsecActionByPass*

Refers to traffic that is allowed to cross the IPsec boundary without protection.

*EfiIPsecActionProtect*

Refers to traffic that is afforded IPsec protection, and for such traffic the SPD must specify the security protocols to be employed, their mode, security service options, and the cryptographic algorithms to be used.

```

//*****
// EFI_IPSEC_PROCESS_POLICY
//*****
typedef struct _EFI_IPSEC_PROCESS_POLICY {
    BOOLEAN    ExtSeqNum;
    BOOLEAN    SeqOverflow;
    BOOLEAN    FragCheck;
    EFI_IPSEC_SA_LIFETIME SaLifetime;
    EFI_IPSEC_MODE Mode;
    EFI_IPSEC_TUNNEL_OPTION *TunnelOption;
    EFI_IPSEC_PROTOCOL_TYPE Proto;
    UINT8      AuthAlgId;
    UINT8      EncAlgId;
} EFI_IPSEC_PROCESS_POLICY;

```

If required action of an SPD entry is *EfiIPsecActionProtect*, the **EFI\_IPSEC\_PROCESS\_POLICY** structure describes a policy list for traffic processing.

<i>ExtSeqNum</i>	Extended Sequence Number. Is this SA using extended sequence numbers. 64 bit counter is used if <b>TRUE</b> .
<i>SeqOverflow</i>	A flag indicating whether overflow of the sequence number counter should generate an auditable event and prevent transmission of additional packets on the SA, or whether rollover is permitted.
<i>FragCheck</i>	Is this SA using stateful fragment checking. <b>TRUE</b> represents stateful fragment checking.
<i>SaLifetime</i>	A time interval after which a SA must be replaced with a new SA (and new SPI) or terminated. The type <b>EFI_IPSEC_SA_LIFETIME</b> is defined in below.
<i>Mode</i>	IPsec mode: tunnel or transport
<i>TunnelOption</i>	Tunnel Option. <i>TunnelOption</i> is ignored if <i>Mode</i> is <b>EfiIPsecTransport</b> . The type <b>EFI_IPSEC_TUNNEL_OPTION</b> is defined in below



*Proto* IPsec protocol: AH or ESP  
*AuthAlgoId* Cryptographic algorithm type used for authentication  
*EncAlgoId* Cryptographic algorithm type used for encryption.  
*EncAlgo* is **NULL** when IPsec protocol is AH. For ESP protocol, *EncAlgo* can also be used to describe the algorithm if a combined mode algorithm is used.

```

//*****
// EFI_IPSEC_SA_LIFETIME
//*****
typedef struct _EFI_IPSEC_SA_LIFETIME {
    UINT64  ByteCount;
    UINT64  SoftLifetime;
    UINT64  HardLifetime
} EFI_IPSEC_SA_LIFETIME;

```

**EFI\_IPSEC\_SA\_LIFETIME** defines the lifetime of an SA, which represents when a SA must be replaced or terminated. A value of all 0 for each field removes the limitation of a SA lifetime.

*ByteCount* The number of bytes to which the IPsec cryptographic algorithm can be applied. For ESP, this is the encryption algorithm and for AH, this is the authentication algorithm. The *ByteCount* includes pad bytes for cryptographic operations.

*SoftLifetime* A time interval in second that warns the implementation to initiate action such as setting up a replacement SA.

*HardLifetime* A time interval in second when the current SA ends and is destroyed.

```

//*****
// EFI_IPSEC_MODE
//*****
typedef enum {
    EfiIPsecTransport,
    EfiIPsecTunnel
} EFI_IPSEC_MODE;

```

There are two modes of IPsec operation: transport mode and tunnel mode. In **EfiIPsecTransport** mode, AH and ESP provide protection primarily for next layer protocols; In **EfiIPsecTunnel** mode, AH and ESP are applied to tunneled IP packets.

```
typedef enum {
    EfiIPsecTunnelClearDf,
    EfiIPsecTunnelSetDf,
    EfiIPsecTunnelCopyDf
} EFI_IPSEC_TUNNEL_DF_OPTION;
```

The option of copying the DF bit from an outbound package to the tunnel mode header that it emits, when traffic is carried via a tunnel mode SA. This applies to SAs where both inner and outer headers are IPv4. The value can be:

**EfiIPsecTunnelClearDf**: Clear DF bit from inner header

**EfiIPsecTunnelSetDf**: Set DF bit from inner header

**EfiIPsecTunnelCopyDf**: Copy DF bit from inner header

```

//*****
// EFI_IPSEC_TUNNEL_OPTION
//*****
typedef struct _EFI_IPSEC_TUNNEL_OPTION {
    EFI_IP_ADDRESS    LocalTunnelAddress;
    EFI_IP_ADDRESS    RemoteTunnelAddress;
    EFI_IPSEC_TUNNEL_DF_OPTION DF;
} EFI_IPSEC_TUNNEL_OPTION;

    LocalTunnelAddress    Local tunnel address when IPsec mode is EfiIPsecTunnel
    RemoteTunnelAddress    Remote tunnel address when IPsec mode is
                           EfiIPsecTunnel

    DF                    The option of copying the DF bit from an outbound
                           package to the tunnel mode header that it emits, when
                           traffic is carried via a tunnel mode SA.

//*****
// EFI_IPSEC_PROTOCOL_TYPE
//*****
typedef enum {
    EfiIPsecAH,
    EfiIPsecESP
} EFI_IPSEC_PROTOCOL_TYPE;
```

IPsec protocols definition. **EfiIPsecAH** is the IP Authentication Header protocol which is specified in RFC 4302. **EfiIPsecESP** is the IP Encapsulating Security Payload which is specified in RFC 4303.

```

//*****
// EFI_IPSEC_SA_ID
//*****
typedef struct _EFI_IPSEC_SA_ID {
    UINT32      Spi;
    EFI_IPSEC_PROTOCOL_TYPE  Proto;
    EFI_IP_ADDRESS  DestAddress;
} EFI_IPSEC_SA_ID;

```

A triplet to identify an SA, consisting of the following members:

<i>Spi</i>	Security Parameter Index (aka SPI). An arbitrary 32-bit value that is used by a receiver to identify the SA to which an incoming package should be bound.
<i>Proto</i>	IPsec protocol: AH or ESP
<i>DestAddress</i>	Destination IP address.

```

//*****
// EFI_IPSEC_SA_DATA
//*****
typedef struct _EFI_IPSEC_SA_DATA {
    EFI_IPSEC_MODE      Mode;
    UINT64      SNCount;
    UINT8      AntiReplayWindows;
    EFI_IPSEC_ALGO_INFO  AlgInfo;
    EFI_IPSEC_SA_LIFETIME  SaLifetime;
    UINT32      PathMTU;
    EFI_IPSEC_SPD_SELECTOR  *SpdSelector;
    BOOLEAN      ManualSet
} EFI_IPSEC_SA_DATA;

```

The data items defined in one SAD entry:

<i>Mode</i>	IPsec mode: tunnel or transport
<i>SNCount</i>	Sequence Number Counter. A 64-bit counter used to generate the sequence number field in AH or ESP headers.
<i>ReplayWindows</i>	Anti-Replay Window. A 64-bit counter and a bit-map used to determine whether an inbound AH or ESP packet is a replay.
<i>AlgInfo</i>	AH/ESP cryptographic algorithm, key and parameters.
<i>SaLifeTime</i>	Lifetime of this SA.
<i>PathMTU</i>	Any observed path MTU and aging variables. The Path MTU processing is defined in section 8 of RFC 4301.
<i>SpdSelector</i>	Link to one SPD entry.

*ManualSet* Indication of whether it's manually set or negotiated automatically. If *ManualSet* is **FALSE**, the corresponding SA entry is inserted through IKE protocol negotiation

```

//*****
// EFI_IPSEC_SA_DATA2
//*****
typedef struct _EFI_IPSEC_SA_DATA2 {
    EFI_IPSEC_MODE      Mode;
    UINT64              SNCount;
    UINT8               AntiReplayWindows;
    EFI_IPSEC_ALGO_INFO AlgoInfo;
    EFI_IPSEC_SA_LIFETIME SaLifetime;
    UINT32              PathMTU;
    EFI_IPSEC_SPD_SELECTOR *SpdSelector;
    BOOLEAN             ManualSet;
    EFI_IP_ADDRESS      TunnelSourceAddress;
    EFI_IP_ADDRESS      TunnelDestinationAddress;
} EFI_IPSEC_SA_DATA2;

```

The data items defined in one SAD entry:

<i>Mode</i>	IPsec mode: tunnel or transport
<i>SNCount</i>	Sequence Number Counter. A 64-bit counter used to generate the sequence number field in AH or ESP headers.
<i>ReplayWindows</i>	Anti-Replay Window. A 64-bit counter and a bit-map used to determine whether an inbound AH or ESP packet is a replay.
<i>AlgoInfo</i>	AH/ESP cryptographic algorithm, key and parameters.
<i>SaLifeTime</i>	Lifetime of this SA.
<i>PathMTU</i>	Any observed path MTU and aging variables. The Path MTU processing is defined in section 8 of RFC 4301.
<i>SpdSelector</i>	Link to one SPD entry.
<i>ManualSet</i>	Indication of whether it's manually set or negotiated automatically. If <i>ManualSet</i> is <b>FALSE</b> , the corresponding SA entry is inserted through IKE protocol negotiation
<i>TunnelSourceAddress</i>	The tunnel header IP source address.
<i>TunnelDestinationAddress</i>	The tunnel header IP destination address.

```

//*****
// EFI_IPSEC_ALGO_INFO
//*****
typedef union {
    EFI_IPSEC_AH_ALGO_INFO    AhAlgInfo;
    EFI_IPSEC_ESP_ALGO_INFO   EspAlgInfo;
} EFI_IPSEC_ALGO_INFO;

//*****
// EFI_IPSEC_AH_ALGO_INFO
//*****
typedef struct _EFI_IPSEC_AH_ALGO_INFO {
    UINT8        AuthAlgId;
    UINTN        KeyLength;
    VOID         *Key;
} EFI_IPSEC_AH_ALGO_INFO;

```

The security algorithm selection for IPsec AH authentication. The required authentication algorithm is specified in RFC 4305.

```

//*****
// EFI_IPSEC_ESP_ALGO_INFO
//*****
typedef struct _EFI_IPSEC_ESP_ALGO_INFO {
    UINT8        EncAlgId;
    UINTN        EncKeyLength;
    VOID         *EncKey;
    UINT8        AuthAlgId;
    UINTN        AuthKeyLength;
    VOID         *AuthKey;
} EFI_IPSEC_ESP_ALGO_INFO;

```

The security algorithm selection for IPsec ESP encryption and authentication. The required authentication algorithm is specified in RFC 4305. *EncAlgId* fields can also specify an ESP combined mode algorithm (e.g. AES with CCM mode, specified in RFC 4309), which provides both confidentiality and authentication services.

```

//*****
// EFI_IPSEC_PAD_ID
//*****
typedef struct _EFI_IPSEC_PAD_ID {
    BOOLEAN    PeerIdValid;
    union {
        EFI_IP_ADDRESS_INFO IpAddress;
        UINT8    PeerId[MAX_PEERID_LEN];
    } Id;
} EFI_IPSEC_PAD_ID;

```

The entry selector for IPsec PAD that represents how to authenticate each peer.

**EFI\_IPSEC\_PAD\_ID** specifies the identifier for PAD entry, which is also used for SPD lookup.

<i>IpAddress</i>	Pointer to the IPv4 or IPv6 address range.
<i>PeerId</i>	Pointer to a null-terminated ASCII string representing the symbolic names. A <i>PeerId</i> can be a DNS name, Distinguished Name, RFC 822 email address or Key ID (specified in section 4.4.3.1 of RFC 4301)

```

//*****
// EFI_IPSEC_PAD_DATA
//*****
typedef struct _EFI_IPSEC_PAD_DATA {
    EFI_IPSEC_AUTH_PROTOCOL_TYPE AuthProtocol;
    EFI_IPSEC_AUTH_METHOD AuthMethod;
    BOOLEAN    IkeldFlag;
    UINTN      AuthDataSize;
    VOID       *AuthData;
    UINTN      RevocationDataSize;
    VOID       *RevocationData;
} EFI_IPSEC_PAD_DATA;

```

The data items defined in one PAD entry:

<i>AuthProtocol</i>	Authentication Protocol for IPsec security association management
<i>AuthMethod</i>	Authentication method used.
<i>IkeldFlag</i>	The IKE ID payload will be used as a symbolic name for SPD lookup if <i>IkeldFlag</i> is <b>TRUE</b> . Otherwise, the remote IP address provided in traffic selector payloads will be used.
<i>AuthDataSize</i>	The size of Authentication data buffer, in bytes.
<i>AuthData</i>	Buffer for Authentication data, (e.g., the pre-shared secret or the trust anchor relative to which the peer's certificate will be validated).
<i>RevocationDataSize</i>	The size of <i>RevocationData</i> , in bytes.

*RevocationData* Pointer to CRL or OCSP data, if certificates are used for authentication method.

```

//*****
// EFI_IPSEC_AUTH_PROTOCOL
//*****
typedef enum {
    EfiIPsecAuthProtocolIkev1,
    EfiIPsecAuthProtocolIkev2,
    EfiIPsecAuthProtocolMaximum
} EFI_IPSEC_AUTH_PROTOCOL_TYPE;
    
```

**EFI\_IPSEC\_AUTH\_PROTOCOL\_TYPE** defines the possible authentication protocol for IPsec security association management.

```

//*****
// EFI_IPSEC_AUTH_METHOD
//*****
typedef enum {
    EfiIPsecAuthMethodPreSharedSecret,
    EfiIPsecAuthMethodCertificates,
    EfiIPsecAuthMethodMaximum
} EFI_IPSEC_AUTH_METHOD;
    
```

*EfiIPsecAuthMethodPreSharedScret*  
Using Pre-shared Keys for manual security associations.

*EfiIPsecAuthMethodCertificates*  
IKE employs X.509 certificates for SA establishment.

### Status Codes Returned

EFI_SUCCESS	The specified configuration entry data is set successfully.
EFI_INVALID_PARAMETER	One or more of the following are <b>TRUE</b> : <ul style="list-style-type: none"> <li><i>This</i> is <b>NULL</b>..</li> </ul>
EFI_UNSUPPORTED	The specified <i>Data Type</i> is not supported.
EFI_OUT_OF_RESOURCES	The required system resource could not be allocated.

## EFI\_IPSEC\_CONFIG\_PROTOCOL.GetData()

### Summary

Return the configuration value for the EFI IPsec driver.

### Prototype

```
typedef
EFI_STATUS
(EFI_API *EFI_IPSEC_CONFIG_GET_DATA) (
  IN EFI_IPSEC_CONFIG_PROTOCOL *This,
  IN EFI_IPSEC_CONFIG_DATA_TYPE DataType,
  IN EFI_IPSEC_CONFIG_SELECTOR *Selector,
  IN OUT UINTN *DataSize,
  OUT VOID *Data
);
```

### Parameters

<i>This</i>	Pointer to the <b>EFI_IPSEC_CONFIG_PROTOCOL</b> instance.
<i>DataType</i>	The type of data to retrieve. Type <b>EFI_IPSEC_CONFIG_DATA_TYPE</b> is defined in <b>EFI_IPSEC_CONFIG_PROTOCOL.SetData()</b> .
<i>Selector</i>	Pointer to an entry selector which is an identifier of the IPsec configuration data entry. Type <b>EFI_IPSEC_CONFIG_SELECTOR</b> is defined in the <b>EFI_IPSEC_CONFIG_PROTOCOL.SetData()</b> function description.
<i>DataSize</i>	On output the size of data returned in <i>Data</i> .
<i>Data</i>	The buffer to return the contents of the IPsec configuration data. The type of the data buffer is associated with the <i>DataType</i> .

### Description

This function lookup the data entry from IPsec database or IKEv2 configuration information. The expected data type and unique identification are described in *DataType* and *Selector* parameters.

### Status Codes Returned

EFI_SUCCESS	The specified configuration data is got successfully.
EFI_INVALID_PARAMETER	One or more of the followings are <b>TRUE</b> : <ul style="list-style-type: none"> <li>• <i>This</i> is <b>NULL</b>.</li> <li>• <i>Selector</i> is <b>NULL</b>.</li> <li>• <i>DataSize</i> is <b>NULL</b>.</li> <li>• <i>Data</i> is <b>NULL</b>.</li> </ul>



EFI_NOT_FOUND	The configuration data specified by <i>Selector</i> is not found.
EFI_UNSUPPORTED	The specified <i>Data Type</i> is not supported.
EFI_BUFFER_TOO_SMALL	The <i>DataSize</i> is too small for the result. <i>DataSize</i> has been updated with the size needed to complete the request.

## EFI\_IPSEC\_CONFIG\_PROTOCOL.GetNextSelector()

### Summary

Enumerates the current selector for IPsec configuration data entry.

### Prototype

```
typedef
EFI_STATUS
(EFI_API *EFI_IPSEC_CONFIG_GET_NEXT_SELECTOR) (
  IN EFI_IPSEC_CONFIG_PROTOCOL *This,
  IN EFI_IPSEC_CONFIG_DATA_TYPE DataType,
  IN OUT UINTN *SelectorSize,
  IN OUT EFI_IPSEC_CONFIG_SELECTOR *Selector,
);
```

### Parameters

<i>This</i>	Pointer to the <b>EFI_IPSEC_CONFIG_PROTOCOL</b> instance.
<i>DataType</i>	The type of IPsec configuration data to retrieve. Type <b>EFI_IPSEC_CONFIG_DATA_TYPE</b> is defined in <b>EFI_IPSEC_CONFIG_PROTOCOL.SetData()</b> .
<i>SelectorSize</i>	The size of the <i>Selector</i> buffer.
<i>Selector</i>	On input, supplies the pointer to last <i>Selector</i> that was returned by <b>GetNextSelector()</b> . On output, returns one copy of the current entry <i>Selector</i> of a given <i>DataType</i> . Type <b>EFI_IPSEC_CONFIG_SELECTOR</b> is defined in the <b>EFI_IPSEC_CONFIG_PROTOCOL.SetData()</b> function description.

### Description

This function is called multiple times to retrieve the entry *Selector* in IPsec configuration database. On each call to **GetNextSelector()**, the next entry *Selector* are retrieved into the output interface. If the entire IPsec configuration database has been iterated, the error **EFI\_NOT\_FOUND** is returned. If the *Selector* buffer is too small for the next *Selector* copy, an **EFI\_BUFFER\_TOO\_SMALL** error is returned, and *SelectorSize* is updated to reflect the size of buffer needed.

On the initial call to **GetNextSelector()** to start the IPsec configuration database search, a pointer to the buffer with all zero value is passed in *Selector*. Calls to **SetData()** between calls to *GetNextSelector* may produce unpredictable results.

### Status Codes Returned

EFI_SUCCESS	The specified configuration data is got successfully.
-------------	---

EFI_INVALID_PARAMETER	One or more of the followings are <b>TRUE</b> : <ul style="list-style-type: none"><li>• <i>This</i> is <b>NULL</b>.</li><li>• <i>SelectorSize</i> is <b>NULL</b>.</li><li>• <i>Selector</i> is <b>NULL</b>.</li></ul>
EFI_NOT_FOUND	The next configuration data entry was not found.
EFI_UNSUPPORTED	The specified <i>Data Type</i> is not supported.
EFI_BUFFER_TOO_SMALL	The <i>SelectorSize</i> is too small for the result. This parameter has been updated with the size needed to complete the search request.

## EFI\_IPSEC\_CONFIG\_PROTOCOL.RegisterDataNotify ()

### Summary

Register an event that is to be signaled whenever a configuration process on the specified IPsec configuration information is done.

### Prototype

```
typedef
EFI_STATUS
(EFI_API *EFI_IPSEC_CONFIG_REGISTER_NOTIFY) (
  IN EFI_IPSEC_CONFIG_PROTOCOL *This,
  IN EFI_IPSEC_CONFIG_DATA_TYPE DataType,
  IN EFI_EVENT Event
);
```

### Parameters

<i>This</i>	Pointer to the <b>EFI_IPSEC_CONFIG_PROTOCOL</b> instance.
<i>DataType</i>	The type of data to be registered the event for. Type <b>EFI_IPSEC_CONFIG_DATA_TYPE</b> is defined in <b>EFI_IPSEC_CONFIG_PROTOCOL.SetData()</b> function description.
<i>Event</i>	The event to be registered.

### Description

This function registers an event that is to be signaled whenever a configuration process on the specified IPsec configuration data is done (e.g. IPsec security policy database configuration is ready). An event can be registered for different *DataType* simultaneously and the caller is responsible for determining which type of configuration data causes the signaling of the event in such case.

### Status Codes Returned

EFI_SUCCESS	The event is registered successfully.
EFI_INVALID_PARAMETER	<i>This</i> is <b>NULL</b> or <i>Event</i> is <b>NULL</b> .
EFI_ACCESS_DENIED	The <i>Event</i> is already registered for the <i>DataType</i> .
EFI_UNSUPPORTED	The notify registration unsupported or the specified <i>DataType</i> is not supported.

## EFI\_IPSEC\_CONFIG\_PROTOCOL.UnregisterDataNotify ()

### Summary

Remove the specified event that is previously registered on the specified IPsec configuration data.

### Prototype

```
typedef
EFI_STATUS
(EFIAPI *EFI_IPSEC_CONFIG_UNREGISTER_NOTIFY) (
  IN EFI_IPSEC_CONFIG_PROTOCOL *This,
  IN EFI_IPSEC_CONFIG_DATA_TYPE DataType,
  IN EFI_EVENT Event
);
```

### Parameters

<i>This</i>	Pointer to the <b>EFI_IPSEC_CONFIG_PROTOCOL</b> instance.
<i>DataType</i>	The configuration data type to remove the registered event for. Type <b>EFI_IPSEC_CONFIG_DATA_TYPE</b> is defined in <b>EFI_IPSEC_CONFIG_PROTOCOL.SetData()</b> function description.
<i>Event</i>	The event to be unregistered.

### Description

This function removes a previously registered event for the specified configuration data.

### Status Codes Returned

EFI_SUCCESS	The event is removed successfully.
EFI_NOT_FOUND	The <i>Event</i> specified by <i>DataType</i> could not be found in the database.
EFI_INVALID_PARAMETER	<i>This</i> is <b>NULL</b> or <i>Event</i> is <b>NULL</b> .
EFI_UNSUPPORTED	The notify registration unsupported or the specified <i>DataType</i> is not supported.

## 28.8.3 EFI IPsec Protocol

This section provides a detailed description of the **EFI\_IPSEC\_PROTOCOL**. This protocol handles IPsec-protected traffic.

## EFI\_IPSEC\_PROTOCOL

### Summary

The **EFI\_IPSEC\_PROTOCOL** is used to abstract the ability to deal with the individual packets sent and received by the host and provide packet-level security for IP datagram.

## GUID

```
#define EFI_IPSEC_PROTOCOL_GUID \
  {0xdfb386f7,0xe100,0x43ad,\
   {0x9c,0x9a,0xed,0x90,0xd0,0x8a,0x5e,0x12 }}
```

## Protocol Interface Structure

```
typedef struct _EFI_IPSEC_PROTOCOL {
  EFI_IPSEC_PROCESS Process;
  EFI_EVENT DisabledEvent;
  BOOLEAN DisabledFlag;
} EFI_IPSEC_PROTOCOL;
```

## Parameters

<i>Process</i>	Handle the IPsec message.
<i>DisabledEvent</i>	Event signaled when the interface is disabled.
<i>DisabledFlag</i>	State of the interface.

## Description

The [EFI\\_IPSEC\\_PROTOCOL](#) provides the ability for securing IP communications by authenticating and/or encrypting each IP packet in a data stream.

[EFI\\_IPSEC\\_PROTOCOL](#) can be consumed by both the IPv4 and IPv6 stack. A user can employ this protocol for IPsec package handling in both IPv4 and IPv6 environment.

## EFI\_IPSEC\_PROTOCOL.Process()

### Summary

Handles IPsec packet processing for inbound and outbound IP packets.

### Prototype

```
typedef
EFI_STATUS
(EFI_API *EFI_IPSEC_PROCESS) (
  IN EFI_IPSEC_PROTOCOL  *This,
  IN EFI_HANDLE          NicHandle,
  IN UINT8               IpVer,
  IN OUT VOID             *IpHead,
  IN UINT8               *LastHead,
  IN VOID                 *OptionsBuffer,
  IN UINT32               OptionsLength,
  IN OUT EFI_IPSEC_FRAGMENT_DATA **FragmentTable,
  IN UINT32               *FragmentCount,
  IN EFI_IPSEC_TRAFFIC_DIR TrafficDirection,
  OUT EFI_EVENT           *RecycleSignal
)
```

### Related definitions

```
/**
//*****
// EFI_IPSEC_FRAGMENT_DATA //
*****
typedef struct _EFI_IPSEC_FRAGMENT_DATA {
  UINT32 FragmentLength;
  VOID *FragmentBuffer;
} EFI_IPSEC_FRAGMENT_DATA;
```

**EFI\_IPSEC\_FRAGMENT\_DATA** defines the instances of packet fragments.

### Parameters

<i>This</i>	Pointer to the <b>EFI_IPSEC_PROTOCOL</b> instance.
<i>NicHandle</i>	Instance of the network interface.
<i>IpVer</i>	IPV4 or IPV6.
<i>IpHead</i>	Pointer to the IP Header.
<i>LastHead</i>	The protocol of the next layer to be processed by IPsec.
<i>OptionsBuffer</i>	Pointer to the options buffer.
<i>OptionsLength</i>	Length of the options buffer.

<i>FragmentTable</i>	Pointer to a list of fragments.
<i>FragmentCount</i>	Number of fragments.
<i>TrafficDirection</i>	Traffic direction.
<i>RecycleSignal</i>	Event for recycling of resources.

## Description

The **EFI\_IPSEC\_PROCESS** process routine handles each inbound or outbound packet. The behavior is that it can perform one of the following actions: bypass the packet, discard the packet, or protect the packet.

## Status Codes Returned

EFI_SUCCESS	The packet was bypassed and all buffers remain the same.
EFI_SUCCESS	The packet was protected.
EFI_ACCESS_DENIED	The packet was discarded.

## 28.8.4 EFI IPsec2 Protocol

This section provides a detailed description of the **EFI\_IPSEC2\_PROTOCOL**. This protocol handles IPsec-protected traffic.

### EFI\_IPSEC2\_PROTOCOL

#### Summary

The **EFI\_IPSEC2\_PROTOCOL** is used to abstract the ability to deal with the individual packets sent and received by the host and provide packet-level security for IP datagram..

#### GUID

```
#define EFI_IPSEC2_PROTOCOL_GUID \
{0xa3979e64, 0xace8, 0x4ddc, \
 {0xbc, 0x07, 0x4d, 0x66, 0xb8, 0xfd, 0x09, 0x77}};
```

#### Protocol Interface Structure

```
typedef struct _EFI_IPSEC2_PROTOCOL {
    EFI_IPSEC_PROCESSEXT ProcessExt;
    EFI_EVENT DisabledEvent;
    BOOLEAN DisabledFlag;
} EFI_IPSEC2_PROTOCOL;
```

#### Parameters

<i>ProcessExt</i>	Handle the IPsec message with the extension header processing support.
<i>DisabledEvent</i>	Event signaled when the interface is disabled.
<i>DisabledFlag</i>	State of the interface.



## Description

The **EFI\_IPSEC2\_PROTOCOL** provides the ability for securing IP communications by authenticating and/or encrypting each IP packet in a data stream.

**EFI\_IPSEC2\_PROTOCOL** can be consumed by both the IPv4 and IPv6 stack. A user can employ this protocol for IPsec package handling in both IPv4 and IPv6 environment.

## EFI\_IPSEC2\_PROTOCOL.ProcessExt()

### Summary

Handles IPsec processing for both inbound and outbound IP packets. Compare with **Process()** in **EFI\_IPSEC\_PROTOCOL**, this interface has the capability to process Option(Extension Header).

### Prototype

```

Typedef
EFI_STATUS
(EFIAPI *EFI_IPSEC_PROCESSEXT) (
IN EFI_IPSEC2_PROTOCOL *This,
IN EFI_HANDLE NicHandle,
IN UINT8 IpVer,
IN OUT VOID *IpHead,
IN OUT UINT8 *LastHead,
IN OUT VOID **OptionsBuffer,
IN OUT UINT32 *OptionsLength,
IN OUT EFI_IPSEC_FRAGMENT_DATA **FragmentTable,
IN OUT UINT32 *FragmentCount,
IN EFI_IPSEC_TRAFFIC_DIR TrafficDirection,
OUT EFI_EVENT *RecycleSignal
)

```

### Parameters

<i>This</i>	Pointer to the <b>EFI_IPSEC2_PROTOCOL</b> instance.
<i>NicHandle</i>	Instance of the network interface.
<i>IpVer</i>	IP version.IPV4 or IPV6.
<i>IpHead</i>	Pointer to the IP Header it is either the <b>EFI_IP4_HEADER</b> or <b>EFI_IP6_HEADER</b> .On input, it contains the IP header. On output, <ol style="list-style-type: none"> <li>1) in tunnel mode and the traffic direction is inbound, the buffer will be reset to zero by IPsec;</li> <li>2) in tunnel mode and the traffic direction is outbound, the buffer will reset to be the tunnel IP header.</li> <li>3) in transport mode, the related fielders (like payload length, Next header) in IP header will be modified according to the condition.</li> </ol>
<i>LastHead</i>	For IP4, it is the next protocol in IP header. For IP6 it is the Next Header of the last extension header.
<i>OptionsBuffer</i>	On input, it contains the options (extensions header) to be processed by IPsec. On output, <ol style="list-style-type: none"> <li>1) in tunnel mode and the traffic direction is outbound, it will be set to <b>NULL</b>, and that means this contents was</li> </ol>

wrapped after inner header and should not be concatenated after tunnel header again;

2) in transport mode and the traffic direction is inbound, if there are IP options (extension headers) protected by IPsec, IPsec will concatenate the those options after the input options (extension headers);

3) on other situations, the output of contents of *OptionsBuffer* might be same with input's. The caller should take the responsibility to free the buffer both on input and on output.

*OptionsLength*

On input, the input length of the options buffer. On output, the output length of the options buffer.

*FragmentTable*

Pointer to a list of fragments. On input, these fragments contain the IP payload. On output,

1) in tunnel mode and the traffic direction is inbound, the fragments contain the whole IP payload which is from the IP inner header to the last byte of the packet;

2) in tunnel mode and the traffic direction is the outbound, the fragments contains the whole encapsulated payload which encapsulates the whole IP payload between the encapsulated header and encapsulated trailer fields.

3) in transport mode and the traffic direction is inbound, the fragments contains the IP payload which is from the next layer protocol to the last byte of the packet;

4) in transport mode and the traffic direction is outbound, the fragments contains the whole encapsulated payload which encapsulates the next layer protocol information between the encapsulated header and encapsulated trailer fields.

*FragmentCount*

Number of fragments.

*TrafficDirection*

Traffic direction.

*RecycleSignal*

Event for recycling of resources.

## Description

The **EFI\_IPSEC\_PROCESSEXT** process routine handles each inbound or outbound packet with the support of options (extension headers) processing. The behavior is that it can perform one of the following actions: bypass the packet, discard the packet, or protect the packet.

## Status Codes Returned

EFI_SUCCESS	The packet was bypassed and all buffers remain the same.
EFI_SUCCESS	The packet was processed by IPsec successfully.
EFI_ACCESS_DENIED	The packet was discarded.
EFI_NOT_READY	The IKE negotiation is invoked and the packet was discarded.
EFI_INVALID_PARAMETER	One of more of following are <b>TRUE</b> If <i>OptionsBuffer</i> is <b>NULL</b> ; If <i>OptionsLength</i> is <b>NULL</b> ; If <i>FragmentTable</i> is <b>NULL</b> ; If <i>FragmentCount</i> is <b>NULL</b> ;

## 28.9 Network Protocol - EFI FTP Protocol

This section defines the EFI FTPv4 (File Transfer Protocol version 4) Protocol that interfaces over EFI FTPv4 Protocol

## EFI\_FTP4\_SERVICE\_BINDING\_PROTOCOL Summary

### Summary

The **EFI\_FTP4\_SERVICE\_BINDING\_PROTOCOL** is used to locate communication devices that are supported by an EFI FTPv4 Protocol driver and to create and destroy instances of the EFI FTPv4 Protocol child protocol driver that can use the underlying communication device.

### GUID

```
#define EFI_FTP4_SERVICE_BINDING_PROTOCOL_GUID \
  {0xfaaecb1, 0x226e, 0x4782, \
   {0xaa, 0xce, 0x7d, 0xb9, 0xbc, 0xbf, 0x4d, 0xaf}}
```

### Description

A network application or driver that requires FTPv4 I/O services can use one of the protocol handler services, such as **BS->LocateHandleBuffer()**, to search for devices that publish an EFI FTPv4 Service Binding Protocol GUID. Each device with a published EFI FTPv4 Service Binding Protocol GUID supports the EFI FTPv4 Protocol service and may be available for use.

After a successful call to the **EFI\_FTP4\_SERVICE\_BINDING\_PROTOCOL.CreateChild()** function, the newly created child EFI FTPv4 Protocol driver instance is in an unconfigured state; it is not ready to transfer data.

Before a network application terminates execution, every successful call to the **EFI\_FTP4\_SERVICE\_BINDING\_PROTOCOL.CreateChild()** function must be matched with a call to the **EFI\_FTP4\_SERVICE\_BINDING\_PROTOCOL.DestroyChild()** function.

Each instance of the EFI FTPv4 Protocol driver can support one file transfer operation at a time. To download two files at the same time, two instances of the EFI FTPv4 Protocol driver will need to be created.

**Note:** *Byte Order: if not specifically specified, the IP addresses used in the **EFI\_FTP4\_PROTOCOL** are in network byte order and the ports are in host byte order.*

## EFI FTP4\_PROTOCOL

### Summary

The EFI FTPv4 Protocol provides basic services for client-side FTP (File Transfer Protocol) operations.

### GUID`

```
#define EFI FTP4_PROTOCOL_GUID \
{0xeb338826, 0x681b, 0x4295, \
{0xb3, 0x56, 0x2b, 0x36, 0x4c, 0x75, 0x7b, 0x09}}
```

### Protocol Interface Structure

```
typedef struct _EFI FTP4_PROTOCOL {
EFI FTP4_GET_MODE_DATA GetModeData;
EFI FTP4_CONNECT Connect;
EFI FTP4_CLOSE Close;
EFI FTP4_CONFIGURE Configure;
EFI FTP4_READ_FILE ReadFile;
EFI FTP4_WRITE_FILE WriteFile;
EFI FTP4_READ_DIRECTORY ReadDirectory;
EFI FTP4_POLL Poll;
} EFI FTP4_PROTOCOL;
```

### Parameters

<i>GetModeData</i>	Reads the current operational settings. See the <b>GetModeData()</b> function description.
<i>Connect</i>	Establish control connection with the FTP server by using the TELNET protocol according to FTP protocol definition. See the <b>Connect()</b> function description.
<i>Close</i>	Gracefully disconnecting a FTP control connection. This function is a nonblocking operation. See the <b>Close()</b> function description.
<i>Configure</i>	Sets and clears operational parameters for an FTP child driver. See the <b>Configure()</b> function description.
<i>ReadFile</i>	Downloads a file from an FTPv4 server. See the <b>ReadFile()</b> function description.
<i>WriteFile</i>	Uploads a file to an FTPv4 server. This function may be unsupported in some EFI implementations. See the <b>WriteFile()</b> function description.
<i>ReadDirectory</i>	Download a related file "directory" from an FTPv4 server. This function may be unsupported in some implementations. See the <b>ReadDirectory()</b> function description.
<i>Poll</i>	Polls for incoming data packets and processes outgoing data packets. See the <b>Poll()</b> function description.



## EFI\_FTP4\_PROTOCOL.GetModeData()

### Summary

Gets the current operational settings

### Prototype

```
typedef
EFI_STATUS
(EFIAPI *EFI_FTP4_GET_MODE_DATA)(
  IN EFI_FTP4_PROTOCOL *This,
  OUT EFI_FTP4_CONFIG_DATA *ModeData
);
```

### Parameters

<i>This</i>	Pointer to the <b>EFI_FTP4_PROTOCOL</b> instance.
<i>ModeData</i>	Pointer to storage for the EFI FTPv4 Protocol driver mode data. Type <b>EFI_FTP4_CONFIG_DATA</b> is defined in "Related Definitions" below. The string buffers for Username and Password in <b>EFI_FTP4_CONFIG_DATA</b> are allocated by the function, and the caller should take the responsibility to free the buffer later.

### Description

The GetModeData() function reads the current operational settings of this EFI FTPv4 Protocol driver instance. **EFI\_FTP4\_CONFIG\_DATA** is defined in the **EFI\_FTP4\_PROTOCOL.Configure**.

### Status Codes Returned

EFI_SUCCESS	This function is called successfully.
EFI_INVALID_PARAMETER	One or more of the following are <b>TRUE</b> : <ul style="list-style-type: none"> <li><i>This is NULL.</i></li> <li><i>ModeData is NULL.</i></li> </ul>
EFI_NOT_STARTED	The EFI FTPv4 Protocol driver has not been started.
EFI_OUT_OF_RESOURCES	Could not allocate enough resource to finish the operation.
EFI_DEVICE_ERROR	An unexpected system or network error occurred.



## EFI\_FTP4\_PROTOCOL.Connect()

### Summary

Initiate a FTP connection request to establish a control connection with FTP server

### Prototype

```
typedef
EFI_STATUS
(EFI_API *EFI_FTP4_CONNECT) (
  IN EFI_FTP4_PROTOCOL *This,
  IN EFI_FTP4_CONNECTION_TOKEN *Token
);
```

### Parameters

*This* Pointer to the **EFI\_FTP4\_PROTOCOL** instance.

*Token* Pointer to the token used to establish control connection.

### Related Definitions

```
/**
//*****
// EFI_FTP4_CONNECTION_TOKEN
//*****
typedef struct {
  EFI_EVENT      Event;
  EFI_STATUS     Status;
} EFI_FTP4_CONNECTION_TOKEN;
```

#### *Event*

The Event to signal after the connection is established and *Status* field is updated by the EFI FTP v4 Protocol driver. The type of *Event* must be **EVENT\_NOTIFY\_SIGNAL**, and its Task Priority Level (TPL) must be lower than or equal to **TPL\_CALLBACK**. If it is set to NULL, this function will not return until the function completes

*Status* The variable to receive the result of the completed operation.

### Status Codes Returned

EFI_SUCCESS	The FTP connection is established successfully.
EFI_ACCESS_DENIED	The FTP server denied the access the user's request to access it.
EFI_CONNECTION_RESET	The connect fails because the connection is reset either by instance itself or communication peer.
EFI_TIMEOUT	The connection establishment timer expired and no more specific information is available.
EFI_NETWORK_UNREACHABLE	The active open fails because an ICMP network unreachable error is received.

EFI_HOST_UNREACHABLE	The active open fails because an ICMP host unreachable error is received.
EFI_PROTOCOL_UNREACHABLE	The active open fails because an ICMP protocol unreachable error is received.
EFI_PORT_UNREACHABLE	The connection establishment timer times out and an ICMP port unreachable error is received.
EFI_ICMP_ERROR	The connection establishment timer timeout and some other ICMP error is received.
EFI_DEVICE_ERROR	An unexpected system or network error occurred.

## Description

The Connect() function will initiate a connection request to the remote FTP server with the corresponding connection token. If this function returns EFI\_SUCCESS, the connection sequence is initiated successfully. If the connection succeeds or failed due to any error, the Token->Event will be signaled and Token->Status will be updated accordingly.

## Status Codes Returned

EFI_SUCCESS	The connection sequence is successfully initiated.
EFI_INVALID_PARAMETER	One or more of the following are <b>TRUE</b> : <i><sup>2</sup> This is NULL.</i> <i><sup>2</sup> Token is NULL.</i> <i><sup>2</sup> Token-&gt;Event is NULL.</i>
EFI_NOT_STARTED	The EFI FTPv4 Protocol driver has not been started.
EFI_NO_MAPPING	When using a default address, configuration (DHCP, BOOTP, RARP, etc.) is not finished yet.
EFI_OUT_OF_RESOURCES	Could not allocate enough resource to finish the operation.
EFI_DEVICE_ERROR	An unexpected system or network error occurred.

## EFI\_FTP4\_PROTOCOL.Close()

### Summary

Disconnecting a FTP connection gracefully.

### Prototype

```
typedef
EFI_STATUS
(EFI_API *EFI_FTP4_CLOSE)(
  IN EFI_FTP4_PROTOCOL *This,
  IN EFI_FTP4_CONNECTION_TOKEN *Token
);
```

### Parameters

*This* Pointer to the **EFI\_FTP4\_PROTOCOL** instance.

*Token* Pointer to the token used to close control connection.

### Description

The **Close()** function will initiate a close request to the remote FTP server with the corresponding connection token. If this function returns **EFI\_SUCCESS**, the control connection with the remote FTP server is closed.

### Status Codes Returned

EFI_SUCCESS	The close request is successfully initiated.
EFI_INVALID_PARAMETER	One or more of the following are <b>TRUE</b> : <ul style="list-style-type: none"> <li><i>This</i> is <b>NULL</b>.</li> <li><i>ConnectionToken</i> is <b>NULL</b>.</li> <li><i>ConnectionToken-&gt;Event</i> is <b>NULL</b>.</li> </ul>
EFI_NOT_STARTED	The EFI FTPv4 Protocol driver has not been started.
EFI_NO_MAPPING	When using a default address, configuration (DHCP, BOOTP, RARP, etc.) is not finished yet.
EFI_OUT_OF_RESOURCES	Could not allocate enough resource to finish the operation.
EFI_DEVICE_ERROR	An unexpected system or network error occurred.

## EFI\_FTP4\_PROTOCOL.Configure()

### Summary

Sets or clears the operational parameters for the FTP child driver.

### Prototype

```
typedef
EFI_STATUS
(EFIAPI *EFI_FTP4_CONFIGURE) (
    IN EFI_FTP4_PROTOCOL *This,
    IN EFI_FTP4_CONFIG_DATA *FtpConfigData OPTIONAL
);
```

### Parameters

<i>This</i>	Pointer to the <b>EFI_FTP4_PROTOCOL</b> instance.
<i>FtpConfigData</i>	Pointer to configuration data that will be assigned to the FTP child driver instance. If <b>NULL</b> , the FTP child driver instance is reset to startup defaults and all pending transmit and receive requests are flushed.

### Related Definitions

```

//*****
// EFI_FTP4_CONFIG_DATA
//*****
typedef struct {
    UINT8      *Username;
    UINT8      *Password;
    BOOLEAN    Active;
    BOOLEAN    UseDefaultSetting;
    EFI_IPv4_ADDRESS    StationIp;
    EFI_IPv4_ADDRESS    SubnetMask;
    EFI_IPv4_ADDRESS    GatewayIp;
    EFI_IPv4_ADDRESS    ServerIp;
    UINT16     ServerPort;
    UINT16     AltDataPort;
    UINT8      RepType;
    UINT8      FileStruct;
    UINT8      TransMode;
} EFI_FTP4_CONFIG_DATA;
```

<i>Username</i>	Pointer to a ASCII string that contains user name. The caller is responsible for freeing <i>Username</i> after <b>GetModeData()</b> is called.
-----------------	--

<i>Password</i>	Pointer to a ASCII string that contains password. The caller is responsible for freeing <i>Password</i> after <b>GetModeData()</b> is called.
<i>Active</i>	Set it to <b>TRUE</b> to initiate an active data connection. Set it to <b>FALSE</b> to initiate a passive data connection.
<i>UseDefaultSetting</i>	Boolean value indicating if default network setting used.
<i>StationIp</i>	IP address of station if <i>UseDefaultSetting</i> is <b>FALSE</b> .
<i>SubnetMask</i>	Subnet mask of station if <i>UseDefaultSetting</i> is <b>FALSE</b> .
<i>GatewayIp</i>	IP address of gateway if <i>UseDefaultSetting</i> is <b>FALSE</b> .
<i>ServerIp</i>	IP address of FTPv4 server.
<i>ServerPort</i>	FTPv4 server port number of control connection, and the default value is 21 as convention.
<i>ALtDataPort</i>	FTPv4 server port number of data connection. If it is zero, use ( <i>ServerPort</i> - 1) by convention.
<i>RepType</i>	A byte indicate the representation type. The right 4 bit is used for first parameter, the left 4 bit is use for second parameter <ul style="list-style-type: none"> <li>• For the first parameter, 0x0 = image, 0x1 = EBCDIC, 0x2 = ASCII, 0x3 = local</li> <li>• For the second parameter, 0x0 = Non-print, 0x1 = Telnet format effectors, 0x2 = Carriage Control</li> <li>• If it is a local type, the second parameter is the local byte byte size.</li> <li>• If it is a image type, the second parameter is undefined.</li> </ul>
<i>FileStruct</i>	Defines the file structure in FTP used. 0x00 = file, 0x01 = record, 0x02 = page
<i>TransMode</i>	Defines the transfer mode used in FTP. 0x00 = stream, 0x01 = Block, 0x02 = Compressed

## Description

The **Configure()** function will configure the connected FTP session with the configuration setting specified in *FtpConfigData*. The configuration data can be reset by calling **Configure()** with *FtpConfigData* set to **NULL**.

## Status Codes Returned.

EFI_SUCCESS	The FTPv4 driver was configured successfully.
EFI_INVALID_PARAMETER	One or more following conditions are <b>TRUE</b> : <ul style="list-style-type: none"> <li>• <i>This</i> is <b>NULL</b>.</li> <li>• <i>FtpConfigData.RepType</i> is invalid.</li> <li>• <i>FtpConfigData.FileStruct</i> is invalid.</li> <li>• <b>FtpConfigData.TransMode</b> is invalid.</li> <li>• IP address in <i>FtpConfigData</i> is invalid.</li> </ul>

EFI_NO_MAPPING	When using a default address, configuration (DHCP, BOOTP, RARP, etc.) has not finished yet.
EFI_UNSUPPORTED	One or more of the configuration parameters are not supported by this implementation.
EFI_OUT_OF_RESOURCES	The EFI FTPv4 Protocol driver instance data could not be allocated.
EFI_DEVICE_ERROR	An unexpected system or network error occurred. The EFI FTPv4 Protocol driver instance is not configured.

## EFI\_FTP4\_PROTOCOL.ReadFile()

### Summary

Downloads a file from an FTPv4 server.

### Prototype

```
typedef
EFI_STATUS
(EFIAPI *EFI_FTP4_READ_FILE)(
  IN EFI_FTP4_PROTOCOL *This,
  IN EFI_FTP4_COMMAND_TOKEN *Token
);
```

### Parameters

<i>This</i>	Pointer to the <b>EFI_FTP4_PROTOCOL</b> instance.
<i>Token</i>	Pointer to the token structure to provide the parameters that are used in this operation. Type <b>EFI_FTP4_COMMAND_TOKEN</b> is defined in "Related Definitions" below.

### Related Definitions

```
/*******
// EFI_FTP4_COMMAND_TOKEN
//*****
typedef struct {
  EFI_EVENT          Event;
  UINT8              *Pathname;
  UINT64             DataBufferSize;
  VOID               *DataBuffer;
  EFI_FTP4_DATA_CALLBACK DataCallback;
  VOID               *Context;
  EFI_STATUS         Status;
} EFI_FTP4_COMMAND_TOKEN;
```

<i>Event</i>	The <i>Event</i> to signal after request is finished and <i>Status</i> field is updated by the EFI FTP v4 Protocol driver. The type of <i>Event</i> must be <b>EVT_NOTIFY_SIGNAL</b> , and its Task Priority Level (TPL) must be lower than or equal to <b>TPL_CALLBACK</b> . If it is set to <b>NULL</b> , related function must wait until the function completes
<i>Pathname</i>	Pointer to a null-terminated ASCII name string.
<i>DataBufferSize</i>	The size of data buffer in bytes
<i>DataBuffer</i>	Pointer to the data buffer. Data downloaded from FTP server through connection is downloaded here.
<i>DataCallback</i>	Pointer to a callback function. If it is receiving function that leads to inbound data, the callback function is called when

databuffer is full. Then, old data in the data buffer should be flushed and new data is stored from the beginning of data buffer. If it is a transmit function that lead to outbound data and *DataBufferSize* of *Data* in *DataBuffer* has been transmitted, this callback function is called to supply additional data to be transmitted. The size of additional data to be transmitted is indicated in *DataBufferSize*, again. If there is no data remained, *DataBufferSize* should be set to 0

*Context* Pointer to the parameter for *DataCallback*.  
*Status* The variable to receive the result of the completed operation.

### **EFI\_SUCCESS**

The FTP command is completed successfully.

### **EFI\_ACCESS\_DENIED**

The FTP server denied the access to the requested file.

### **EFI\_CONNECTION\_RESET**

The connect fails because the connection is reset either by instance itself or communication peer.

### **EFI\_TIMEOUT**

The connection establishment timer expired and no more specific information is available.

### **EFI\_NETWORK\_UNREACHABLE**

The active open fails because an ICMP network unreachable error is received.

### **EFI\_HOST\_UNREACHABLE**

The active open fails because an ICMP host unreachable error is received.

### **EFI\_PROTOCOL\_UNREACHABLE**

The active open fails because an ICMP protocol unreachable error is received.

### **EFI\_PORT\_UNREACHABLE**

The connection establishment timer times out and an ICMP port unreachable error is received.

### **EFI\_ICMP\_ERROR**

The connection establishment timer timeout and some other ICMP error is received.

### **EFI\_DEVICE\_ERROR**

An unexpected system or network error occurred.



## Related Definitions

```

//*****
// EFI_FTP4_DATA_CALLBACK
//*****
typedef
EFI_STATUS
(EFI_API *EFI_FTP4_DATA_CALLBACK)(
  IN EFI_FTP4_PROTOCOL *This,
  IN EFI_FTP4_COMMAND_TOKEN *Token,
);

```

*This* Pointer to the **EFI\_FTP4\_PROTOCOL** instance.

*Token* Pointer to the token structure to provide the parameters that are used in this operation. Type **EFI\_FTP4\_COMMAND\_TOKEN** is defined in "Related Definitions" above.

## Description

The **ReadFile()** function is used to initialize and start an FTPv4 download process and optionally wait for completion. When the download operation completes, whether successfully or not, the *Token.Status* field is updated by the EFI FTPv4 Protocol driver and then *Token.Event* is signaled (if it is not **NULL**).

Data will be downloaded from the FTPv4 server into *Token.DataBuffer*. If the file size is larger than *Token.DataBufferSize*, *Token.DataCallback* will be called to allow for processing data and then new data will be placed at the beginning of *Token.DataBuffer*.

## Status Codes Returned

EFI_SUCCESS	The data file is being downloaded successfully.
EFI_INVALID_PARAMETER	One or more of the parameters is not valid. <ul style="list-style-type: none"> <li><i>This</i> is <b>NULL</b>.</li> <li><i>Token</i> is <b>NULL</b>.</li> <li><i>Token.Pathname</i> is <b>NULL</b>.</li> <li><i>Token.DataBuffer</i> is <b>NULL</b>.</li> <li><i>Token.DataBufferSize</i> is 0.</li> </ul>
EFI_NOT_STARTED	The EFI FTPv4 Protocol driver has not been started.
EFI_NO_MAPPING	When using a default address, configuration (DHCP, BOOTP, RARP, etc.) is not finished yet.
EFI_OUT_OF_RESOURCES	Required system resources could not be allocated.
EFI_DEVICE_ERROR	An unexpected network error or system error occurred.

## EFI\_FTP4\_PROTOCOL.WriteFile()

### Summary

Uploads a file from an FTPv4 server.

### Prototype

```
typedef
EFI_STATUS
(EFIAPI *EFI_FTP4_WRITE_FILE)(
  IN EFI_FTP4_PROTOCOL *This,
  IN EFI_FTP4_COMMAND_TOKEN *Token
);
```

### Parameters

*This* Pointer to the **EFI\_FTP4\_PROTOCOL** instance.

*Token* Pointer to the token structure to provide the parameters that are used in this operation. Type **EFI\_FTP4\_COMMAND\_TOKEN** is defined in "EFI\_FTP4\_READ\_FILE" .

### Description

The **WriteFile()** function is used to initialize and start an FTPv4 upload process and optionally wait for completion. When the upload operation completes, whether successfully or not, the *Token.Status* field is updated by the EFI FTPv4 Protocol driver and then *Token.Event* is signaled (if it is not **NULL**).

Data to be uploaded to server is stored into *Token.DataBuffer*. *Token.DataBufferSize* is the number bytes to be transferred. If the file size is larger than *Token.DataBufferSize*, *Token.DataCallback* will be called to allow for processing data and then new data will be placed at the beginning of *Token.DataBuffer*. *Token.DataBufferSize* is updated to reflect the actual number of bytes to be transferred. *Token.DataBufferSize* is set to 0 by the call back to indicate the completion of data transfer.

### Status Codes Returned

EFI_SUCCESS	The data file is being uploaded successfully.
EFI_UNSUPPORTED	The operation is not supported by this implementation.
EFI_INVALID_PARAMETER	One or more of the parameters is not valid. <ul style="list-style-type: none"> <li>• <i>This</i> is <b>NULL</b>.</li> <li>• <i>Token</i> is <b>NULL</b>.</li> <li>• <i>Token.Pathname</i> is <b>NULL</b>.</li> <li>• <i>Token.DataBuffer</i> is <b>NULL</b>.</li> <li>• <i>Token.DataBufferSize</i> is 0.</li> </ul>
EFI_NOT_STARTED	The EFI FTPv4 Protocol driver has not been started.
EFI_NO_MAPPING	When using a default address, configuration (DHCP, BOOTP, RARP, etc.) is not finished yet.

EFI_OUT_OF_RESOURCES	Required system resources could not be allocated.
EFI_DEVICE_ERROR	An unexpected network error or system error occurred.

## EFI\_FTP4\_PROTOCOL.ReadDirectory()

### Summary

Download a data file "directory" from a FTPv4 server. May be unsupported in some EFI implementations.

### Prototype

```
typedef
EFI_STATUS
(EFI_API *EFI_FTP4_READ_DIRECTORY) (
    IN EFI_FTP4_PROTOCOL *This,
    IN EFI_FTP4_COMMAND_TOKEN *Token
);
```

### Parameters

<i>This</i>	Pointer to the <b>EFI_FTP4_PROTOCOL</b> instance.
<i>Token</i>	Pointer to the token structure to provide the parameters that are used in this operation. Type <b>EFI_FTP4_COMMAND_TOKEN</b> is defined in "EFI_FTP4_READ_FILE" .

### Description

The **ReadDirectory()** function is used to return a list of files on the FTPv4 server that logically (or operationally) related to *Token.Pathname*, and optionally wait for completion. When the download operation completes, whether successfully or not, the *Token.Status* field is updated by the EFI FTPv4 Protocol driver and then *Token.Event* is signaled (if it is not **NULL**).

Data will be downloaded from the FTPv4 server into *Token.DataBuffer*. If the file size is larger than *Token.DataBufferSize*, *Token.DataCallback* will be called to allow for processing data and then new data will be placed at the beginning of *Token.DataBuffer*.

## Status Codes Returned

EFI_SUCCESS	The file list information is being downloaded successfully.
EFI_UNSUPPORTED	The operation is not supported by this implementation.
EFI_INVALID_PARAMETER	One or more of the parameters is not valid. <ul style="list-style-type: none"><li>• <i>This</i> is <b>NULL</b>.</li><li>• <b>Token</b> is <b>NULL</b>.</li><li>• <b>Token. DataBuffer</b> is <b>NULL</b>.</li><li>• <b>Token. DataBufferSize</b> is <b>0</b>.</li></ul>
EFI_NOT_STARTED	The EFI FTPv4 Protocol driver has not been started.
EFI_NO_MAPPING	When using a default address, configuration (DHCP, BOOTP, RARP, etc.) is not finished yet.
EFI_OUT_OF_RESOURCES	Required system resources could not be allocated.
EFI_DEVICE_ERROR	An unexpected network error or system error occurred.

## EFI FTP4\_PROTOCOL.Poll()

### Summary

Polls for incoming data packets and processes outgoing data packets.

### Prototype

```
typedef
EFI_STATUS
(EFI_API *EFI FTP4_POLL) (
    IN EFI FTP4_PROTOCOL *This
);
```

### Parameters

*This* Pointer to the **EFI FTP4\_PROTOCOL** instance.

### Description

The **Poll()** function can be used by network drivers and applications to increase the rate that data packets are moved between the communications device and the transmit and receive queues.

In some systems, the periodic timer event in the managed network driver may not poll the underlying communications device fast enough to transmit and/or receive all data packets without missing incoming packets or dropping outgoing packets. Drivers and applications that are experiencing packet loss should try calling the **Poll()** function more often.

### Status Codes Returned

EFI_SUCCESS	Incoming or outgoing data was processed.
EFI_NOT_STARTED	This EFI FTPv4 Protocol instance has not been started.
EFI_INVALID_PARAMETER	<i>This</i> is <b>NULL</b> .
EFI_DEVICE_ERROR	An unexpected system or network error occurred.
EFI_TIMEOUT	Data was dropped out of the transmit and/or receive queue. Consider increasing the polling rate.

## 28.10 EFI TLS Protocols

### 28.10.1 EFI TLS Service Binding Protocol

#### EFI\_TLS\_SERVICE\_BINDING\_PROTOCOL

### Summary

The EFI TLS Service Binding Protocol is used to locate EFI TLS Protocol drivers to create and destroy child of the driver to communicate with other host using TLS protocol.

**GUID**

```
#define EFI_TLS_SERVICE_BINDING_PROTOCOL_GUID \
{ \
  0x952cb795, 0xff36, 0x48cf, 0xa2, 0x49, 0x4d, 0xf4, 0x86, 0xd6, 0xab, 0x8d \
}
```

**Description**

The TLS consumer need locate **EFI\_TLS\_SERVICE\_BINDING\_PROTOCOL** and call **CreateChild()** to create a new child of **EFI\_TLS\_PROTOCOL** instance. Then use **EFI\_TLS\_PROTOCOL** to start TLS session. After use, the TLS consumer need call **DestroyChild()** to destroy it.

**28.10.2 EFI TLS Protocol****EFI\_TLS\_PROTOCOL****Summary**

This protocol provides the ability to manage TLS session.

**GUID**

```
#define EFI_TLS_PROTOCOL_GUID \
{ 0xca959f, 0x6cfa, 0x4db1, \
  {0x95, 0xbc, 0xe4, 0x6c, 0x47, 0x51, 0x43, 0x90} }
```

**Protocol Interface Structure**

```
typedef struct _EFI_TLS_PROTOCOL {
  EFI_TLS_SET_SESSION_DATA    SetSessionData;
  EFI_TLS_GET_SESSION_DATA    GetSessionData;
  EFI_TLS_BUILD_RESPONSE_PACKET BuildResponsePacket;
  EFI_TLS_PROCESS_PACKET      ProcessPacket;
} EFI_TLS_PROTOCOL;
```

**Parameters**

<i>SetSessionData</i>	Set TLS session data. See the <b>SetSessionData ()</b> function description.
<i>GetSessionData</i>	Get TLS session data. See the <b>GetSessionData ()</b> function description.
<i>BuildResponsePacket</i>	Build response packet according to TLS state machine. This function is only valid for alert, handshake and change_cipher_spec content type. See the <b>BuildResponsePacket ()</b> function description.
<i>ProcessPacket</i>	Decrypt or encrypt TLS packet during session. This function is only valid after session connected and for application_data content type. See the <b>ProcessPacket ()</b> function description.

## Description

The **EFI\_TLS\_PROTOCOL** is used to create, destroy and manage TLS session. For detail of TLS, please refer to TLS related RFC.



## EFI\_TLS\_PROTOCOL.SetSessionData ()

### Summary

Set TLS session data.

### Prototype

```
typedef
EFI_STATUS
(EFI_API *EFI_TLS_SET_SESSION_DATA)(
  IN EFI_TLS_PROTOCOL      *This,
  IN EFI_TLS_SESSION_DATA_TYPE  DataType,
  IN VOID                  *Data,
  IN UINTN                 DataSize
);
```

### Parameters

<i>This</i>	Pointer to the <b>EFI_TLS_PROTOCOL</b> instance.
<i>DataType</i>	TLS session data type. See <b>EFI_TLS_SESSION_DATA_TYPE</b>
<i>Data</i>	Pointer to session data.
<i>DataSize</i>	Total size of session data.

### Description

The **SetSessionData()** function set data for a new TLS session. All session data should be set before **BuildResponsePacket()** invoked.

## Related Definitions

```

//*****
// EFI_TLS_SESSION_DATA_TYPE
//*****
typedef enum {
//
// Session Configuration
//
EfiTlsVersion,
EfiTlsConnectionEnd,
EfiTlsCipherList,
EfiTlsCompressionMethod,
EfiTlsExtensionData,
EfiTlsVerifyMethod,
EfiTlsSessionID,
EfiTlsSessionState,
//
// Session information
//
EfiTlsClientRandom,
EfiTlsServerRandom,
EfiTlsKeyMaterial,
EfiTlsSessionDataTypeMaximum
} EFI_TLS_SESSION_DATA_TYPE;

```

<i>EfiTlsVersion</i>	TLS session Version. The corresponding <i>Data</i> is of type <b>EFI_TLS_VERSION</b> .
<i>EfiTlsConnectionEnd</i>	TLS session as client or as server. The corresponding <i>Data</i> is of <b>EFI_TLS_CONNECTION_END</b> .
<i>EfiTlsCipherList</i>	A priority list of preferred algorithms for the TLS session. The corresponding <i>Data</i> is a list of <b>EFI_TLS_CIPHER</b> .
<i>EfiTlsCompressionMethod</i>	TLS session compression method. The corresponding <i>Data</i> is of type <b>EFI_TLS_COMPRESSION</b> .
<i>EfiTlsExtensionData</i>	TLS session extension data. The corresponding <i>Data</i> is a list of type <b>EFI_TLS_EXTENDION</b> .
<i>EfiTlsVerifyMethod</i>	TLS session verify method. The corresponding <i>Data</i> is of type <b>EFI_TLS_VERIFY</b> .
<i>EfiTlsSessionID</i>	TLS session data session ID. For <b>SetSessionData()</b> , it is TLS session ID used for session resumption. For <b>GetSessionData()</b> , it is the TLS session ID used for current session. The corresponding <i>Data</i> is of type <b>EFI_TLS_SESSION_ID</b> .
<i>EfiTlsSessionState</i>	TLS session data session state. The corresponding <i>Data</i> is of type <b>EFI_TLS_SESSION_STATE</b> .

*EfiTlsClientRandom* TLS session data client random. The corresponding *Data* is of type **EFI\_TLS\_RANDOM**.

*EfiTlsServerRandom* TLS session data server random. The corresponding *Data* is of type **EFI\_TLS\_RANDOM**.

*EfiTlsKeyMaterial* TLS session data key material. The corresponding *Data* is of type **EFI\_TLS\_MASTER\_SECRET**.

```

//*****
// EFI_TLS_VERSION
//*****
typedef struct {
    UINT8 Major;
    UINT8 Minor;
} EFI_TLS_VERSION;

```

**Note:** The TLS version definition is from SSL3.0 to latest TLS (e.g. 1.2). SSL2.0 is obsolete and should not be used.

```

//*****
// EFI_TLS_CONNECTION_END
//*****
typedef enum {
    EfiTlsClient,
    EfiTlsServer,
} EFI_TLS_CONNECTION_END;

```

TLS connection end is to define TLS session as client or as server.

```

//*****
// EFI_TLS_CIPHER
//*****
typedef struct {
    UINT8 Data1;
    UINT8 Data2;
} EFI_TLS_CIPHER;

```

**Note:** The definition of *EFI\_TLS\_CIPHER* is from RFC 5246 A.4.1.Hello Messages. The value of *EFI\_TLS\_CIPHER* is from TLS Cipher Suite Registry of IANA.

```

//*****
// EFI_TLS_COMPRESSION
//*****
typedef UINT8 EFI_TLS_COMPRESSION;

```

**Note:** The value of *EFI\_TLS\_COMPRESSION* definition is from RFC 3749.

```

//*****
// EFI_TLS_EXTENSION
//*****
typedef struct {
    UINT16 ExtensionType;
    UINT16 Length;
    UINT8 Data[];
} EFI_TLS_EXTENSION;

```

**Note:** The definition of *EFI\_TLS\_EXTENSION* is from RFC 5246 A.4.1. Hello Messages.

```

//*****
// EFI_TLS_VERIFY
//*****
typedef UINT32 EFI_TLS_VERIFY;
#define EFI_TLS_VERIFY_NONE    0x0
#define EFI_TLS_VERIFY_PEER    0x1
#define EFI_TLS_VERIFY_FAIL_IF_NO_PEER_CERT 0x2
#define EFI_TLS_VERIFY_CLIENT_ONCE 0x4

```

The consumer needs to use either *EFI\_TLS\_VERIFY\_NONE* or *EFI\_TLS\_VERIFY\_PEER*. *EFI\_TLS\_VERIFY\_FAIL\_IF\_NO\_PEER\_CERT* and *EFI\_TLS\_VERIFY\_CLIENT\_ONCE* can be ORed with *EFI\_TLS\_VERIFY\_PEER*. *EFI\_TLS\_VERIFY\_FAIL\_IF\_NO\_PEER\_CERT* means TLS session will fail peer certificate is absent. *EFI\_TLS\_VERIFY\_CLIENT\_ONCE* means TLS session only verify client once, and doesn't request certificate during re-negotiation.

```

//*****
// EFI_TLS_RANDOM
//*****
typedef struct {
    UINT32 GmtUnixTime;
    UINT8 RandomBytes[28];
} EFI_TLS_RANDOM;

```

**Note:** The definition of *EFI\_TLS\_RANDOM* is from RFC 5246 A.4.1. Hello Messages.

```

//*****
// EFI_TLS_MASTER_SECRET
//*****
typedef struct {
    UINT8  Data[48];
} EFI_TLS_MASTER_SECRET;

```

**Note:** The definition of **EFI\_TLS\_MASTER\_SECRET** is from RFC 5246 8.1. Computing the Master Secret.

```

//*****
// EFI_TLS_SESSION_ID
//*****
#define MAX_TLS_SESSION_ID_LENGTH 32
typedef struct {
    UINT16 Length;
    UINT8  Data[MAX_TLS_SESSION_ID_LENGTH];
} EFI_TLS_SESSION_ID;

```

**Note:** The definition of **EFI\_TLS\_SESSION\_ID** is from RFC 5246 A.4.1. Hello Messages.

```

//*****
// EFI_TLS_SESSION_STATE
//*****
typedef enum {
    EfiTlsSessionNotStarted,
    EfiTlsSessionHandShaking,
    EfiTlsSessionDataTransferring,
    EfiTlsSessionClosing,
    EfiTlsSessionError,
    EfiTlsSessionStateMaximum
} EFI_TLS_SESSION_STATE;

```

The definition of **EFI\_TLS\_SESSION\_STATE** is below:

When a new child of TLS protocol is created, the initial state of TLS session is **EfiTlsSessionNotStarted**.

The consumer can call **BuildResponsePacket()** with NULL to get ClientHello to start the TLS session. Then the status is **EfiTlsSessionHandShaking**.

During handshake, the consumer need call **BuildResponsePacket()** with input data from peer, then get response packet and send to peer. After handshake finish, the TLS session status becomes **EfiTlsSessionDataTransferring**, and consume can use **ProcessPacket()** for data transferring.

Finally, if consumer wants to active close TLS session, consumer need call **SetSessionData** to set TLS session state to **EfiTlsSessionClosing**, and call **BuildResponsePacket()** with NULL to get CloseNotify alert message, and sent it out.

If any error happen during parsing ApplicationData content type, EFI\_ABORT will be returned by **ProcessPacket()**, and TLS session state will become **EfiTlsSessionError**. Then consumer need call **BuildResponsePacket()** with NULL to get alert message and sent it out.

## Status Codes Returned

EFI_SUCCESS	The TLS session data is set successfully.
EFI_INVALID_PARAMETER	One or more of the following conditions is TRUE: <ul style="list-style-type: none"> <li>• <i>This</i> is NULL</li> <li>• <i>Data</i> is NULL.</li> <li>• <i>DataSize</i> is 0.</li> </ul>
EFI_UNSUPPORTED	The <i>Data Type</i> is unsupported.
EFI_ACCESS_DENIED	If the <i>Data Type</i> is one of below: <ul style="list-style-type: none"> <li>• <i>EfiTlsClientRandom</i></li> <li>• <i>EfiTlsServerRandom</i></li> <li>• <i>EfiTlsKeyMaterial</i></li> </ul>
EFI_NOT_READY	Current TLS session state is NOT <b>EfiTlsSessionStateNotStarted</b> .
EFI_OUT_OF_RESOURCES	Required system resources could not be allocated.

## EFI\_TLS\_PROTOCOL.GetSessionData ()

### Summary

Get TLS session data.

### Prototype

```
typedef
EFI_STATUS
(EFI_API *EFI_TLS_GET_SESSION_DATA)(
  IN EFI_TLS_PROTOCOL      *This,
  IN EFI_TLS_SESSION_DATA_TYPE  DataType,
  IN OUT VOID              *Data, OPTIONAL
  IN OUT UINTN             *DataSize
);
```

### Parameters

<i>This</i>	Pointer to the <b>EFI_TLS_PROTOCOL</b> instance.
<i>DataType</i>	TLS session data type. See <b>EFI_TLS_SESSION_DATA_TYPE</b>
<i>Data</i>	Pointer to session data.
<i>DataSize</i>	Total size of session data. On input, it means the size of <i>Data</i> buffer. On output, it means the size of copied <i>Data</i> buffer if <b>EFI_SUCCESS</b> , and means the size of desired <i>Data</i> buffer if <b>EFI_BUFFER_TOO_SMALL</b> .

### Description

The **GetSessionData()** function return the TLS session information.

### Status Codes Returned

EFI_SUCCESS	The TLS session data is got successfully.
EFI_INVALID_PARAMETER	One or more of the following conditions is TRUE: <ul style="list-style-type: none"> <li><i>This</i> is NULL.</li> <li><i>DataSize</i> is NULL.</li> <li><i>Data</i> is NULL if <i>*DataSize</i> is not zero.</li> </ul>
EFI_UNSUPPORTED	The <i>DataType</i> is unsupported.
EFI_NOT_FOUND	The TLS session data is not found.
EFI_NOT_READY	The <i>DataType</i> is not ready in current session state.
EFI_BUFFER_TOO_SMALL	The buffer is too small to hold the data.

## EFI\_TLS\_PROTOCOL.BuildResponsePacket ()

### Summary

Build response packet according to TLS state machine. This function is only valid for alert, handshake and change\_cipher\_spec content type.

### Prototype

```
typedef
EFI_STATUS
(EFI_API *EFI_TLS_BUILD_RESPONSE_PACKET)(
  IN EFI_TLS_PROTOCOL    *This,
  IN UINT8               *RequestBuffer, OPTIONAL
  IN UINTN               RequestSize, OPTIONAL
  OUT UINT8              *Buffer, OPTIONAL
  IN OUT UINTN          *BufferSize
);
```

### Parameters

<i>This</i>	Pointer to the <b>EFI_TLS_PROTOCOL</b> instance.
<i>RequestBuffer</i>	Pointer to the most recently received TLS packet. NULL means TLS need initiate the TLS session and response packet need to be ClientHello.
<i>RequestSize</i>	Packet size in bytes for the most recently received TLS packet. 0 is only valid when <i>RequestBuffer</i> is NULL.
<i>Buffer</i>	Pointer to the buffer to hold the built packet.
<i>BufferSize</i>	Pointer to the buffer size in bytes. On input, it is the buffer size provided by the caller. On output, it is the buffer size in fact needed to contain the packet.

### Description

The **BuildResponsePacket()** function builds TLS response packet in response to the TLS request packet specified by *RequestBuffer* and *RequestSize*. If *RequestBuffer* is NULL and *RequestSize* is 0, and TLS session status is **EfiTlsSessionNotStarted**, the TLS session will be initiated and the response packet needs to be ClientHello. If *RequestBuffer* is NULL and *RequestSize* is 0, and TLS session status is **EfiTlsSessionClosing**, the TLS session will be closed and response packet needs to be CloseNotify. If *RequestBuffer* is NULL and *RequestSize* is 0, and TLS session status is **EfiTlsSessionError**, the TLS session has errors and the response packet needs to be Alert message based on error type.

### Status Codes Returned

EFI_SUCCESS	The required TLS packet is built successfully.
-------------	--



EFI_INVALID_PARAMETER	One or more of the following conditions is TRUE: <ul style="list-style-type: none"><li>• <i>This</i> is NULL.</li><li>• <i>RequestBuffer</i> is NULL but <i>RequestSize</i> is NOT 0.</li><li>• <i>RequestSize</i> is 0 but <i>RequestBuffer</i> is NOT NULL.</li><li>• <i>BufferSize</i> is NULL.</li><li>• <i>Buffer</i> is NULL.if <i>*BufferSize</i> is not zero.</li></ul>
EFI_BUFFER_TOO_SMALL	<i>BufferSize</i> is too small to hold the response packet.
EFI_NOT_READY	Current TLS session state is NOT ready to build <i>ResponsePacket</i> .
EFI_ABORTED	Something wrong build response packet.

## EFI\_TLS\_PROTOCOL.ProcessPacket ()

### Summary

Decrypt or encrypt TLS packet during session. This function is only valid after session connected and for application\_data content type.

### Prototype

```
typedef
EFI_STATUS
(EFIAPI *EFI_TLS_PROCESS_PACKET)(
  IN EFI_TLS_PROTOCOL  *This,
  IN OUT EFI_TLS_FRAGMENT_DATA **FragmentTable,
  IN UINT32             *FragmentCount,
  IN EFI_TLS_CRYPT_MODE  CryptMode
);
```

### Parameters

<i>This</i>	Pointer to the <b>EFI_TLS_PROTOCOL</b> instance.
<i>FragmentTable</i>	Pointer to a list of fragment. The caller will take responsible to handle the original <i>FragmentTable</i> while it may be reallocated in TLS driver. If <i>CryptMode</i> is <b>EfiTlsEncrypt</b> , on input these fragments contain the TLS header and plain text TLS APP payload; on output these fragments contain the TLS header and cypher text TLS APP payload. If <i>CryptMode</i> is <b>EfiTlsDecrypt</b> , on input these fragments contain the TLS header and cypher text TLS APP payload; on output these fragments contain the TLS header and plain text TLS APP payload.
<i>FragmentCount</i>	Number of fragment.
<i>CryptMode</i>	Crypt mode.

### Description

The **ProcessPacket ()** function process each inbound or outbound TLS APP packet.

### Related Definitions

```
/**
//*****
// EFI_TLS_FRAGMENT_DATA
//*****
typedef struct {
  UINT32  FragmentLength;
  VOID    *FragmentBuffer;
} EFI_TLS_FRAGMENT_DATA;

  FragmentLength      Length of data buffer in the fragment.
  FragmentBuffer     Pointer to the data buffer in the fragment.
```

```

//*****
// EFI_TLS_CRYPT_MODE
//*****
typedef enum {
  EfiTlsEncrypt,
  EfiTlsDecrypt,
} EFI_TLS_CRYPT_MODE;

  EfiTlsEncrypt           Encrypt data provided in the fragment buffers.
  EfiTlsDecrypt           Decrypt data provided in the fragment buffers.

```

### Status Codes Returned

EFI_SUCCESS	The operation completed successfully.
EFI_INVALID_PARAMETER	One or more of the following conditions is TRUE: <ul style="list-style-type: none"> <li>• <i>This</i> is NULL.</li> <li>• <i>FragmentTable</i> is NULL.</li> <li>• <i>FragmentCount</i> is NULL.</li> <li>• <i>CryptoMode</i> is invalid.</li> </ul>
EFI_NOT_READY	Current TLS session state is NOT <b>EfiTlsSessionDataTransferring</b> .
EFI_ABORTED	Something wrong decryption the message. TLS session status will become <b>EfiTlsSessionError</b> . The caller need call <b>BuildResponsePacket()</b> to generate Error Alert message and send it out.
EFI_OUT_OF_RESOURCES	No enough resource to finish the operation.

## 28.10.3 EFI TLS Configuration Protocol

### EFI\_TLS\_CONFIGURATION\_PROTOCOL

#### Summary

This protocol provides a way to set and get TLS configuration.

#### GUID

```

#define EFI_TLS_CONFIGURATION_PROTOCOL_GUID \
  { 0x1682fe44, 0xbd7a, 0x4407, \
    {0xb7, 0xc7, 0xdc, 0xa3, 0x7c, 0xa3, 0x92, 0x2d} }

```

#### Protocol Interface Structure

```

typedef struct _EFI_TLS_CONFIGURATION_PROTOCOL {
  EFI_TLS_CONFIGURATION_SET_DATA  SetData;
  EFI_TLS_CONFIGURATION_GET_DATA  GetData;
} EFI_TLS_CONFIGURATION_PROTOCOL;

```

## Parameters

*SetData*

Set TLS configuration data. See the **SetData()** function description.

*GetData*

Get TLS configuration data. See the **GetData()** function description.

## Description

The **EFI\_TLS\_CONFIGURATION\_PROTOCOL** is designed to provide a way to set and get TLS configuration, such as Certificate, private key file.

## EFI\_TLS\_CONFIGURATION\_PROTOCOL.SetData()

### Summary

Set TLS configuration data.

### Prototype

```
typedef
EFI_STATUS
(EFI_API *EFI_TLS_CONFIGURATION_SET_DATA)(
  IN EFI_TLS_CONFIGURATION_PROTOCOL *This,
  IN EFI_TLS_CONFIG_DATA_TYPE  DataType,
  IN VOID          *Data,
  IN UINTN        DataSize
);
```

### Parameters

<i>This</i>	Pointer to the <b>EFI_TLS_CONFIGURATION_PROTOCOL</b> instance.
<i>DataType</i>	Configuration data type. See <b>EFI_TLS_CONFIG_DATA_TYPE</b>
<i>Data</i>	Pointer to configuration data.
<i>DataSize</i>	Total size of configuration data.

### Description

The **SetData()** function sets TLS configuration to non-volatile storage or volatile storage.

### Related Definitions

```
/**
//*****
// EFI_TLS_CONFIG_DATA_TYPE
//*****
typedef enum {
  EfiTlsConfigDataTypeHostPublicCert,
  EfiTlsConfigDataTypeHostPrivateKey,
  EfiTlsConfigDataTypeCACertificate,
  EfiTlsConfigDataTypeCertRevocationList,
  EfiTlsConfigDataTypeMaximum

```

```
} EFI_TLS_CONFIG_DATA_TYPE;
```

*EfiTlsConfigDataTypeHostPublicCert*

Local host configuration data: public certificate data. This data should be DER-encoded binary X.509 certificate or PEM-encoded X.509 certificate.

**EfiTlsConfigDataTypeHostPrivateKey**

Local host configuration data: private key data.

**EfiTlsConfigDataTypeCACertificate**

CA certificate to verify peer. This data should be PEM-encoded RSA or PKCS#8 private key.

*EfiTlsConfigDataTypeCertRevocationList*

CA-supplied Certificate Revocation List data. This data should be DER-encoded CRL data.

**Status Codes Returned**

EFI_SUCCESS	The TLS configuration data is set successfully.
EFI_INVALID_PARAMETER	One or more of the following conditions is TRUE: <ul style="list-style-type: none"> <li>• <i>This</i> is NULL.</li> <li>• <i>Data</i> is NULL.</li> <li>• <i>DataSize</i> is 0.</li> </ul>
EFI_UNSUPPORTED	The <i>DataType</i> is unsupported.
EFI_OUT_OF_RESOURCES	Required system resources could not be allocated.

## EFI\_TLS\_CONFIGURATION\_PROTOCOL.GetData()

### Summary

Get TLS configuration data.

### Prototype

```
typedef
EFI_STATUS
(EFIAPI *EFI_TLS_CONFIGURATION_GET_DATA)(
  IN EFI_TLS_CONFIGURATION_PROTOCOL *This,
  IN EFI_TLS_CONFIG_DATA_TYPE  DataType,
  IN OUT VOID          *Data, OPTIONAL
  IN OUT UINTN        *DataSize
);
```

### Parameters

<i>This</i>	Pointer to the <b>EFI_TLS_CONFIGURATION_PROTOCOL</b> instance.
<i>DataType</i>	Configuration data type. See <b>EFI_TLS_CONFIG_DATA_TYPE</b>
<i>Data</i>	Pointer to configuration data.
<i>DataSize</i>	Total size of configuration data. On input, it means the size of <i>Data</i> buffer. On output, it means the size of copied <i>Data</i> buffer if <b>EFI_SUCCESS</b> , and means the size of desired <i>Data</i> buffer if <b>EFI_BUFFER_TOO_SMALL</b> .

### Description

The **GetData()** function gets TLS configuration.

### Status Codes Returned

EFI_SUCCESS	The TLS configuration data is got successfully.
EFI_INVALID_PARAMETER	One or more of the following conditions is TRUE: <ul style="list-style-type: none"> <li><i>This</i> is NULL.</li> <li><i>DataSize</i> is NULL</li> <li><i>Data</i> is NULL if <i>*DataSize</i> is not zero.</li> </ul>
EFI_UNSUPPORTED	The <i>DataType</i> is unsupported.
EFI_NOT_FOUND	The TLS configuration data is not found.
EFI_BUFFER_TOO_SMALL	The buffer is too small to hold the data.





## 29 Network Protocols — ARP, DHCP, DNS, HTTP and REST

---

### 29.1 ARP Protocol

This section defines the EFI Address Resolution Protocol (ARP) Protocol interface. It is split into the following two main sections:

- ARP Service Binding Protocol (ARPSBP)
- ARP Protocol (ARP)

ARP provides a generic implementation of the Address Resolution Protocol that is described in RFCs 826 and 1122. For RFCs can be found see “Links to UEFI-Related Documents” (<http://uefi.org/uefi>) under the heading “IETF” (RFCs 826 and 1122) for details for code of ICMP message..

#### EFI\_ARP\_SERVICE\_BINDING\_PROTOCOL

##### Summary

The ARPSBP is used to locate communication devices that are supported by an ARP driver and to create and destroy instances of the ARP child protocol driver.

The EFI Service Binding Protocol in [Section 2.5.8](#) defines the generic Service Binding Protocol functions. This section discusses the details that are specific to the ARP.

##### GUID

```
#define EFI_ARP_SERVICE_BINDING_PROTOCOL_GUID \
  {0xf44c00ee,0x1f2c,0x4a00,\
   {0xaa,0x09,0x1c,0x9f,0x3e,0x08,0x00,0xa3}}
```

##### Description

A network application (or driver) that requires network address resolution can use one of the protocol handler services, such as **BS->LocateHandleBuffer()**, to search for devices that publish a ARPSBP GUID. Each device with a published ARPSBP GUID supports ARP and may be available for use.

After a successful call to the **EFI\_ARP\_SERVICE\_BINDING\_PROTOCOL.CreateChild()** function, the child ARP driver instance is in an unconfigured state; it is not ready to resolve addresses.

All child ARP driver instances that are created by one **EFI\_ARP\_SERVICE\_BINDING\_PROTOCOL** instance will share an ARP cache to improve efficiency.

Before a network application terminates execution, every successful call to the **EFI\_ARP\_SERVICE\_BINDING\_PROTOCOL.CreateChild()** function must be matched with a call to the **EFI\_ARP\_SERVICE\_BINDING\_PROTOCOL.DestroyChild()** function.

**Note:** All the network addresses that are described in **EFI\_ARP\_PROTOCOL** are stored in network byte order. Both incoming and outgoing ARP packets are also in network byte order. All other parameters that are defined in functions or data structures are stored in host byte order.

## EFI\_ARP\_PROTOCOL

### Summary

ARP is used to resolve local network protocol addresses into network hardware addresses.

### GUID

```
#define EFI_ARP_PROTOCOL_GUID \
{0xf4b427bb,0xba21,0x4f16,\
 {0xbc,0x4e,0x43,0xe4,0x16,0xab,0x61,0x9c}}
```

### Protocol Interface Structure

```
typedef struct _EFI_ARP_PROTOCOL {
  EFI_ARP_CONFIGURE  Configure;
  EFI_ARP_ADD        Add;
  EFI_ARP_FIND       Find;
  EFI_ARP_DELETE     Delete;
  EFI_ARP_FLUSH      Flush;
  EFI_ARP_REQUEST    Request;
  EFI_ARP_CANCEL     Cancel;
} EFI_ARP_PROTOCOL;
```

### Parameters

<i>Configure</i>	Adds a new station address (protocol type and network address) to the ARP cache. See the <b>Configure()</b> function description.
<i>Add</i>	Manually inserts an entry to the ARP cache for administrative purpose. See the <b>Add()</b> function description.
<i>Find</i>	Locates one or more entries in the ARP cache. See the <b>Find()</b> function description.
<i>Delete</i>	Removes an entry from the ARP cache. See the <b>Delete()</b> function description.
<i>Flush</i>	Removes all dynamic ARP cache entries of a specified protocol type. See the <b>Flush()</b> function description.
<i>Request</i>	Starts an ARP request session. See the <b>Request()</b> function description.
<i>Cancel</i>	Abort previous ARP request session. See the <b>Cancel()</b> function description.

## Description

The **EFI\_ARP\_PROTOCOL** defines a set of generic ARP services that can be used by any network protocol driver to resolve subnet local network addresses into hardware addresses. Normally, a periodic timer event internally sends and receives packets for ARP. But in some systems where the periodic timer is not supported, drivers and applications that are experiencing packet loss should try calling the **Poll()** function of the EFI Managed Network Protocol frequently.

**Note:** **Add()** and **Delete()** are typically used for administrative purposes, such as denying traffic to and from a specific remote machine, preventing ARP requests from coming too fast, and providing static address pairs to save time. **Find()** is also used to update an existing ARP cache entry.

## EFI\_ARP\_PROTOCOL.Configure()

### Summary

Assigns a station address (protocol type and network address) to this instance of the ARP cache.

### Prototype

```
typedef
EFI_STATUS
(EFIAPI *EFI_ARP_CONFIGURE) (
  IN EFI_ARP_PROTOCOL  *This,
  IN EFI_ARP_CONFIG_DATA *ConfigData OPTIONAL
);
```

### Parameters

<i>This</i>	A pointer to the <b>EFI_ARP_PROTOCOL</b> instance.
<i>ConfigData</i>	A pointer to the <b>EFI_ARP_CONFIG_DATA</b> structure. Type <b>EFI_ARP_CONFIG_DATA</b> is defined in “Related Definitions” below.

### Description

The **Configure()** function is used to assign a station address to the ARP cache for this instance of the ARP driver. Each ARP instance has one station address. The **EFI\_ARP\_PROTOCOL** driver will respond to ARP requests that match this registered station address. A call to **Configure()** with the *ConfigData* field set to **NULL** will reset this ARP instance.

Once a protocol type and station address have been assigned to this ARP instance, all the following ARP functions will use this information. Attempting to change the protocol type or station address to a configured ARP instance will result in errors.

### Related Definitions

```
/**
//*****
// EFI_ARP_CONFIG_DATA
//*****
typedef struct {
  UINT16      SwAddressType;
  UINT8       SwAddressLength;
  VOID        *StationAddress;
  UINT32      EntryTimeout;
  UINT32      RetryCount;
  UINT32      RetryTimeout;
} EFI_ARP_CONFIG_DATA;
```

<i>SwAddressType</i>	16-bit protocol type number in host byte order. For more information see “Links to UEFI-Related Documents” ( <a href="http://uefi.org/uefi">http://uefi.org/uefi</a> ) under the heading “16-bit protocol type numbers”.
<i>SwAddressLength</i>	Length in bytes of the station’s protocol address to register.
<i>StationAddress</i>	Pointer to the first byte of the protocol address to register. For example, if <i>SwAddressType</i> is 0x0800 (IP), then <i>StationAddress</i> points to the first byte of this station’s IP address stored in network byte order.
<i>EntryTimeOut</i>	The timeout value in 100-ns units that is associated with each new dynamic ARP cache entry. If it is set to zero, the value is implementation-specific.
<i>RetryCount</i>	The number of retries before a MAC address is resolved. If it is set to zero, the value is implementation-specific.
<i>RetryTimeOut</i>	The timeout value in 100-ns units that is used to wait for the ARP reply packet or the timeout value between two retries. Set to zero to use implementation-specific value.

### Status Codes Returned

EFI_SUCCESS	The new station address was successfully registered.
EFI_INVALID_PARAMETER	<ul style="list-style-type: none"> <li>One or more of the following conditions is <b>TRUE</b>:</li> <li><i>This</i> is <b>NULL</b>.</li> <li><i>SwAddressLength</i> is zero when <i>ConfigData</i> is not <b>NULL</b>.</li> <li><i>StationAddress</i> is <b>NULL</b> when <i>ConfigData</i> is not <b>NULL</b>.</li> </ul>
EFI_ACCESS_DENIED	The <i>SwAddressType</i> , <i>SwAddressLength</i> , or <i>StationAddress</i> is different from the one that is already registered.
EFI_OUT_OF_RESOURCES	Storage for the new <i>StationAddress</i> could not be allocated.

## EFI\_ARP\_PROTOCOL.Add()

### Summary

Inserts an entry to the ARP cache.

### Prototype

```
typedef
EFI_STATUS
(EFI_API *EFI_ARP_ADD) (
  IN EFI_ARP_PROTOCOL *This,
  IN BOOLEAN    DenyFlag,
  IN VOID      *TargetSwAddress OPTIONAL,
  IN VOID      *TargetHwAddress OPTIONAL,
  IN UINT32    TimeoutValue,
  IN BOOLEAN    Overwrite
);
```

### Parameters

<i>This</i>	A pointer to the <b>EFI_ARP_PROTOCOL</b> instance..
<i>DenyFlag</i>	Set to <b>TRUE</b> if this entry is a “deny” entry. Set to <b>FALSE</b> if this entry is a “normal” entry.
<i>TargetSwAddress</i>	Pointer to a protocol address to add (or deny). May be set to <b>NULL</b> if <i>DenyFlag</i> is <b>TRUE</b> .
<i>TargetHwAddress</i>	Pointer to a hardware address to add (or deny). May be set to <b>NULL</b> if <i>DenyFlag</i> is <b>TRUE</b> .
<i>TimeoutValue</i>	Time in 100-ns units that this entry will remain in the ARP cache. A value of zero means that the entry is permanent. A nonzero value will override the one given by <b>Configure()</b> if the entry to be added is dynamic entry.
<i>Overwrite</i>	If <b>TRUE</b> , the matching cache entry will be overwritten with the supplied parameters. If <b>FALSE</b> , <b>EFI_ACCESS_DENIED</b> is returned if the corresponding cache entry already exists.

### Description

The **Add()** function is used to insert entries into the ARP cache.

ARP cache entries are typically inserted and updated by network protocol drivers as network traffic is processed. Most ARP cache entries will time out and be deleted if the network traffic stops. ARP cache entries that were inserted by the **Add()** function may be static (will not time out) or dynamic (will time out).

Default ARP cache timeout values are not covered in most network protocol specifications (although RFC 1122 comes pretty close) and will only be discussed in general in this specification. The timeout values that are used in the EFI Sample

Implementation should be used only as a guideline. Final product implementations of the EFI network stack should be tuned for their expected network environments.

The **Add()** function can insert the following two types of entries into the ARP cache:

- “Normal” entries
- “Deny” entries

“Normal” entries must have both a *TargetSwAddress* and *TargetHwAddress* and are used to resolve network protocol addresses into network hardware addresses. Entries are keyed by *TargetSwAddress*. Each *TargetSwAddress* can have only one *TargetHwAddress*. A *TargetHwAddress* may be referenced by multiple *TargetSwAddress* entries.

“Deny” entries may have a *TargetSwAddress* or a *TargetHwAddress*, but not both. These entries tell the ARP driver to ignore any traffic to and from (and to) these addresses. If a request comes in from an address that is being denied, then the request is ignored.

If a normal entry to be added matches a deny entry of this driver, *Overwrite* decides whether to remove the matching deny entry. On the other hand, an existing normal entry can be removed based on the value of *Overwrite* if a deny entry to be added matches the existing normal entry. Two entries are matched only when they have the same addresses or when one of the normal entry addresses is the same as the address of a deny entry.

## Status Codes Returned

EFI_SUCCESS	The entry has been added or updated.
EFI_INVALID_PARAMETER	One or more of the following conditions is <b>TRUE</b> : <i>This is NULL.</i> <i>DenyFlag</i> is <b>FALSE</b> and <i>TargetHwAddress</i> is <b>NULL</b> . <i>DenyFlag</i> is <b>FALSE</b> and <i>TargetSwAddress</i> is <b>NULL</b> . <i>TargetHwAddress</i> is <b>NULL</b> and <i>TargetSwAddress</i> is <b>NULL</b> . Both <i>TargetSwAddress</i> and <i>TargetHwAddress</i> are not <b>NULL</b> when <i>DenyFlag</i> is <b>TRUE</b> .
EFI_OUT_OF_RESOURCES	The new ARP cache entry could not be allocated.
EFI_ACCESS_DENIED	The ARP cache entry already exists and <i>Overwrite</i> is not <b>TRUE</b> .
EFI_NOT_STARTED	The ARP driver instance has not been configured.

## EFI\_ARP\_PROTOCOL.Find()

### Summary

Locates one or more entries in the ARP cache.

### Prototype

```
typedef
EFI_STATUS
(EFI_API *EFI_ARP_FIND) (
  IN EFI_ARP_PROTOCOL *This,
  IN BOOLEAN BySwAddress,
  IN VOID *AddressBuffer OPTIONAL,
  OUT UINT32 *EntryLength OPTIONAL,
  OUT UINT32 *EntryCount OPTIONAL,
  OUT EFI_ARP_FIND_DATA **Entries OPTIONAL,
  IN BOOLEAN Refresh
);
```

### Parameters

<i>This</i>	A pointer to the <b>EFI_ARP_PROTOCOL</b> instance.
<i>BySwAddress</i>	Set to <b>TRUE</b> to look for matching software protocol addresses. Set to <b>FALSE</b> to look for matching hardware protocol addresses.
<i>AddressBuffer</i>	Pointer to address buffer. Set to <b>NULL</b> to match all addresses.
<i>EntryLength</i>	The size of an entry in the entries buffer. To keep the <b>EFI_ARP_FIND_DATA</b> structure properly aligned, this field may be longer than <b>sizeof(EFI_ARP_FIND_DATA)</b> plus the length of the software and hardware addresses.
<i>EntryCount</i>	The number of ARP cache entries that are found by the specified criteria.
<i>Entries</i>	Pointer to the buffer that will receive the ARP cache entries. Type <b>EFI_ARP_FIND_DATA</b> is defined in “Related Definitions” below.
<i>Refresh</i>	Set to <b>TRUE</b> to refresh the timeout value of the matching ARP cache entry.

### Description

The **Find()** function searches the ARP cache for matching entries and allocates a buffer into which those entries are copied. The first part of the allocated buffer is **EFI\_ARP\_FIND\_DATA**, following which are protocol address pairs and hardware address pairs.



When finding a specific protocol address (*BySwAddress* is **TRUE** and *AddressBuffer* is not **NULL**), the ARP cache timeout for the found entry is reset if *Refresh* is set to **TRUE**. If the found ARP cache entry is a permanent entry, it is not affected by *Refresh*.

## Related Definitions

```

//*****
// EFI_ARP_FIND_DATA
//*****
typedef struct {
    UINT32    Size;
    BOOLEAN   DenyFlag;
    BOOLEAN   StaticFlag;
    UINT16    HwAddressType;
    UINT16    SwAddressType;
    UINT8     HwAddressLength;
    UINT8     SwAddressLength;
} EFI_ARP_FIND_DATA;

```

<i>Size</i>	Length in bytes of this entry.
<i>DenyFlag</i>	Set to <b>TRUE</b> if this entry is a “deny” entry. Set to <b>FALSE</b> if this entry is a “normal” entry.
<i>StaticFlag</i>	Set to <b>TRUE</b> if this entry will not time out. Set to <b>FALSE</b> if this entry will time out.
<i>HwAddressType</i>	16-bit ARP hardware identifier number.
<i>SwAddressType</i>	16-bit protocol type number.
<i>HwAddressLength</i>	Length of the hardware address.
<i>SwAddressLength</i>	Length of the protocol address.

## Status Codes Returned

EFI_SUCCESS	The requested ARP cache entries were copied into the buffer.
EFI_INVALID_PARAMETER	One or more of the following conditions is <b>TRUE</b> : <ul style="list-style-type: none"> <li><i>This</i> is <b>NULL</b>.</li> <li>Both <i>EntryCount</i> and <i>EntryLength</i> are <b>NULL</b>, when <i>Refresh</i> is <b>FALSE</b>.</li> </ul>
EFI_NOT_FOUND	No matching entries were found.
EFI_NOT_STARTED	The ARP driver instance has not been configured.

## EFI\_ARP\_PROTOCOL.Delete()

### Summary

Removes entries from the ARP cache.

### Prototype

```
typedef
EFI_STATUS
(EFI_API *EFI_ARP_DELETE) (
  IN EFI_ARP_PROTOCOL *This,
  IN BOOLEAN BySwAddress,
  IN VOID *AddressBuffer OPTIONAL
);
```

### Parameters

<i>This</i>	A pointer to the <b>EFI_ARP_PROTOCOL</b> instance.
<i>BySwAddress</i>	Set to <b>TRUE</b> to delete matching protocol addresses. Set to <b>FALSE</b> to delete matching hardware addresses.
<i>AddressBuffer</i>	Pointer to the address buffer that is used as a key to look for the cache entry. Set to <b>NULL</b> to delete all entries.

### Description

The **Delete()** function removes specified ARP cache entries.

### Status Codes Returned

EFI_SUCCESS	The entry was removed from the ARP cache.
EFI_INVALID_PARAMETER	<i>This</i> is <b>NULL</b> .
EFI_NOT_FOUND	The specified deletion key was not found.
EFI_NOT_STARTED	The ARP driver instance has not been configured.

## EFI\_ARP\_PROTOCOL.Flush()

### Summary

Removes all dynamic ARP cache entries that were added by this interface.

### Prototype

```
typedef
EFI_STATUS
(EFIAPI *EFI_ARP_FLUSH) (
    IN EFI_ARP_PROTOCOL *This
);
```

### Parameters

*This* A pointer to the **EFI\_ARP\_PROTOCOL** instance.

### Description

The **Flush()** function deletes all dynamic entries from the ARP cache that match the specified software protocol type.

### Status Codes Returned

EFI_SUCCESS	The cache has been flushed.
EFI_INVALID_PARAMETER	<i>This</i> is <b>NULL</b> .
EFI_NOT_FOUND	There are no matching dynamic cache entries.
EFI_NOT_STARTED	The ARP driver instance has not been configured.

## EFI\_ARP\_PROTOCOL.Request()

### Summary

Starts an ARP request session.

### Prototype

```
typedef
EFI_STATUS
(EFI_API *EFI_ARP_REQUEST) (
  IN EFI_ARP_PROTOCOL *This,
  IN VOID      *TargetSwAddress OPTIONAL,
  IN EFI_EVENT  ResolvedEvent OPTIONAL,
  OUT VOID      *TargetHwAddress
);
```

### Parameters

<i>This</i>	A pointer to the <b>EFI_ARP_PROTOCOL</b> instance..
<i>TargetSwAddress</i>	Pointer to the protocol address to resolve.
<i>ResolvedEvent</i>	Pointer to the event that will be signaled when the address is resolved or some error occurs.
<i>TargetHwAddress</i>	Pointer to the buffer for the resolved hardware address in network byte order. The buffer must be large enough to hold the resulting hardware address. <i>TargetHwAddress</i> must not be <b>NULL</b> .

### Description

The **Request()** function tries to resolve the *TargetSwAddress* and optionally returns a *TargetHwAddress* if it already exists in the ARP cache.

If the registered *SwAddressType* (see **EFI\_ARP\_PROTOCOL.Add()**) is IPv4 or IPv6 and the *TargetSwAddress* is a multicast address, then the *TargetSwAddress* is resolved using the underlying **EFI\_MANAGED\_NETWORK\_PROTOCOL.McastIpToMac()** function.

If the *TargetSwAddress* is **NULL**, then the network interface hardware broadcast address is returned immediately in *TargetHwAddress*.

If the *ResolvedEvent* is not **NULL** and the address to be resolved is not in the ARP cache, then the event will be signaled when the address request completes and the requested hardware address is returned in the *TargetHwAddress*. If the timeout expires and the retry count is exceeded or an unexpected error occurs, the event will be signaled to notify the caller, which should check the *TargetHwAddress* to see if the requested hardware address is available. If it is not available, the *TargetHwAddress* is filled by zero.

If the address to be resolved is already in the ARP cache and resolved, then the event will be signaled immediately if it is not **NULL**, and the requested hardware address is also returned in *TargetHwAddress*.

## Status Codes Returned

EFI_SUCCESS	The data was copied from the ARP cache into the <i>TargetHwAddress</i> buffer.
EFI_INVALID_PARAMETER	One or more of the following conditions is <b>TRUE</b> : <i>This</i> is <b>NULL</b> <i>TargetHwAddress</i> is <b>NULL</b>
EFI_ACCESS_DENIED	The requested address is not present in the normal ARP cache but is present in the deny address list. Outgoing traffic to that address is forbidden.
EFI_NOT_STARTED	The ARP driver instance has not been configured.
EFI_NOT_READY	The request has been started and is not finished.
EFI_UNSUPPORTED	The requested conversion is not supported in this implementation or configuration.

## EFI\_ARP\_PROTOCOL.Cancel()

### Summary

Cancels an ARP request session.

### Prototype

```
typedef
EFI_STATUS
(EFI_API *EFI_ARP_CANCEL) (
  IN EFI_ARP_PROTOCOL *This,
  IN VOID *TargetSwAddress OPTIONAL,
  IN EFI_EVENT ResolvedEvent OPTIONAL
);
```

### Parameters

<i>This</i>	A pointer to the <b>EFI_ARP_PROTOCOL</b> instance.
<i>TargetSwAddress</i>	Pointer to the protocol address in previous request session.
<i>ResolvedEvent</i>	Pointer to the event that is used as the notification event in previous request session.

### Description

The **Cancel()** function aborts the previous ARP request (identified by *This*, *TargetSwAddress* and *ResolvedEvent*) that is issued by **EFI\_ARP\_PROTOCOL.Request()**. If the request is in the internal ARP request queue, the request is aborted immediately and its *ResolvedEvent* is signaled. Only an asynchronous address request needs to be canceled. If *TargetSwAddress* and *ResolvedEvent* are both **NULL**, all the pending asynchronous requests that have been issued by *This* instance will be cancelled and their corresponding events will be signaled.

### Status Codes Returned

EFI_SUCCESS	The pending request session(s) is/are aborted and corresponding event(s) is/are signaled.
EFI_INVALID_PARAMETER	One or more of the following conditions is <b>TRUE</b> : <ul style="list-style-type: none"> <li><i>This</i> is <b>NULL</b>.</li> <li><i>TargetSwAddress</i> is not <b>NULL</b> and <i>ResolvedEvent</i> is <b>NULL</b>.</li> <li><i>TargetSwAddress</i> is <b>NULL</b> and <i>ResolvedEvent</i> is not <b>NULL</b>.</li> </ul>
EFI_NOT_STARTED	The ARP driver instance has not been configured.
EFI_NOT_FOUND	The request is not issued by <b>EFI_ARP_PROTOCOL.Request()</b> .

## 29.2 EFI DHCPv4 Protocol

This section provides a detailed description of the **EFI\_DHCP4\_PROTOCOL** and the **EFI\_DHCP4\_SERVICE\_BINDING\_PROTOCOL**. The EFI DHCPv4 Protocol is used to collect configuration information for the EFI IPv4 Protocol drivers and to provide DHCPv4 server and PXE boot server discovery services.

### EFI\_DHCP4\_SERVICE\_BINDING\_PROTOCOL

#### Summary

The EFI DHCPv4 Service Binding Protocol is used to locate communication devices that are supported by an EFI DHCPv4 Protocol driver and to create and destroy EFI DHCPv4 Protocol child driver instances that can use the underlying communications device.

#### GUID

```
#define EFI_DHCP4_SERVICE_BINDING_PROTOCOL_GUID \
  {0x9d9a39d8,0xbd42,0x4a73,\
   {0xa4,0xd5,0x8e,0xe9,0x4b,0xe1,0x13,0x80}}
```

#### Description

A network application or driver that requires basic DHCPv4 services can use one of the protocol handler services, such as **BS->LocateHandleBuffer()**, to search for devices that publish an EFI DHCPv4 Service Binding Protocol GUID. Each device with a published EFI DHCPv4 Service Binding Protocol GUID supports the EFI DHCPv4 Protocol and may be available for use.

After a successful call to the **EFI\_DHCP4\_SERVICE\_BINDING\_PROTOCOL.CreateChild()** function, the newly created EFI DHCPv4 Protocol child driver instance is ready to be used by a network application or driver.

Before a network application or driver terminates execution, every successful call to the **EFI\_DHCP4\_SERVICE\_BINDING\_PROTOCOL.CreateChild()** function must be matched with a call to the **EFI\_DHCP4\_SERVICE\_BINDING\_PROTOCOL.DestroyChild()** function.

### EFI\_DHCP4\_PROTOCOL

#### Summary

This protocol is used to collect configuration information for the EFI IPv4 Protocol drivers and to provide DHCPv4 server and PXE boot server discovery services.

## GUID

```
#define EFI_DHCP4_PROTOCOL_GUID \
{0x8a219718,0x4ef5,0x4761,\
{0x91,0xc8,0xc0,0xf0,0x4b,0xda,0x9e,0x56}}
```

## Protocol Interface Structure

```
typedef struct _EFI_DHCP4_PROTOCOL {
  EFI_DHCP4_GET_MODE_DATA  GetModeData;
  EFI_DHCP4_CONFIGURE      Configure;
  EFI_DHCP4_START          Start;
  EFI_DHCP4_RENEW_REBIND   RenewRebind;
  EFI_DHCP4_RELEASE        Release;
  EFI_DHCP4_STOP           Stop;
  EFI_DHCP4_BUILD          Build;
  EFI_DHCP4_TRANSMIT_RECEIVE TransmitReceive;
  EFI_DHCP4_PARSE          Parse;
} EFI_DHCP4_PROTOCOL;
```

## Parameters

<i>GetModeData</i>	Gets the EFI DHCPv4 Protocol driver status and operational data. See the <b>GetModeData()</b> function description.
<i>Configure</i>	Initializes, changes, or resets operational settings for the EFI DHCPv4 Protocol driver. See the <b>Configure()</b> function description.
<i>Start</i>	Starts the DHCP configuration process. See the <b>Start()</b> function description.
<i>RenewRebind</i>	Tries to manually extend the lease time by sending a request packet. See the <b>RenewRebind()</b> function description.
<i>Release</i>	Releases the current configuration and returns the EFI DHCPv4 Protocol driver to the initial state. See the <b>Release()</b> function description.
<i>Stop</i>	Stops the DHCP configuration process no matter what state the driver is in. After being stopped, this driver will not automatically communicate with the DHCP server. See the <b>Stop()</b> function description.
<i>Build</i>	Puts together a DHCP or PXE packet. See the <b>Build()</b> function description.
<i>TransmitReceive</i>	Transmits a DHCP or PXE packet and waits for response packets. See the <b>TransmitReceive()</b> function description.
<i>Parse</i>	Parses the packed DHCP or PXE option data. See the <b>Parse()</b> function description.



## Description

The **EFI\_DHCP4\_PROTOCOL** is used to collect configuration information for the EFI IPv4 Protocol driver and provide DHCP server and PXE boot server discovery services.

## Byte Order Note

All the IPv4 addresses that are described in **EFI\_DHCP4\_PROTOCOL** are stored in network byte order. Both incoming and outgoing DHCP packets are also in network byte order. All other parameters that are defined in functions or data structures are stored in host byte order.

## EFI\_DHCP4\_PROTOCOL.GetModeData()

### Summary

Returns the current operating mode and cached data packet for the EFI DHCPv4 Protocol driver.

### Prototype

```
typedef
EFI_STATUS
(EFI_API *EFI_DHCP4_GET_MODE_DATA)(
  IN EFI_DHCP4_PROTOCOL *This,
  OUT EFI_DHCP4_MODE_DATA *Dhcp4ModeData
);
```

### Parameters

<i>This</i>	Pointer to the <b>EFI_DHCP4_PROTOCOL</b> instance.
<i>Dhcp4ModeData</i>	Pointer to storage for the <b>EFI_DHCP4_MODE_DATA</b> structure. Type <b>EFI_DHCP4_MODE_DATA</b> is defined in “Related Definitions” below.

### Description

The **GetModeData()** function returns the current operating mode and cached data packet for the EFI DHCPv4 Protocol driver.

### Related Definitions

```
/**
//*****
// EFI_DHCP4_MODE_DATA
//*****
typedef struct {
  EFI_DHCP4_STATE   State;
  EFI_DHCP4_CONFIG_DATA ConfigData;
  EFI_IPv4_ADDRESS  ClientAddress;
  EFI_MAC_ADDRESS   ClientMacAddress;
  EFI_IPv4_ADDRESS  ServerAddress;
  EFI_IPv4_ADDRESS  RouterAddress;
  EFI_IPv4_ADDRESS  SubnetMask;
  UINT32            LeaseTime;
  EFI_DHCP4_PACKET  *ReplyPacket;
} EFI_DHCP4_MODE_DATA;
```

<i>State</i>	The EFI DHCPv4 Protocol driver operating state. Type <b>EFI_DHCP4_STATE</b> is defined below.
--------------	---

<i>ConfigData</i>	The configuration data of the current EFI DHCPv4 Protocol driver instance. Type <b>EFI_DHCP4_CONFIG_DATA</b> is defined in <b>EFI_DHCP4_PROTOCOL.Configure()</b> .
<i>ClientAddress</i>	The client IP address that was acquired from the DHCP server. If it is zero, the DHCP acquisition has not completed yet and the following fields in this structure are undefined.
<i>ClientMacAddress</i>	The local hardware address.
<i>ServerAddress</i>	The server IP address that is providing the DHCP service to this client.
<i>RouterAddress</i>	The router IP address that was acquired from the DHCP server. May be zero if the server does not offer this address.
<i>SubnetMask</i>	The subnet mask of the connected network that was acquired from the DHCP server.
<i>LeaseTime</i>	The lease time (in 1-second units) of the configured IP address. The value 0xFFFFFFFF means that the lease time is infinite. A default lease of 7 days is used if the DHCP server does not provide a value.
<i>ReplyPacket</i>	The cached latest DHCPACK or DHCPNAK or BOOTP REPLY packet. May be <b>NULL</b> if no packet is cached.

The **EFI\_DHCP4\_MODE\_DATA** structure describes the operational data of the current DHCP procedure.

```

//*****
// EFI_DHCP4_STATE
//*****
typedef enum {
  Dhcp4Stopped   = 0x0,
  Dhcp4Init      = 0x1,
  Dhcp4Selecting = 0x2,
  Dhcp4Requesting = 0x3,
  Dhcp4Bound     = 0x4
  Dhcp4Renewing  = 0x5,
  Dhcp4Rebinding = 0x6,
  Dhcp4InitReboot = 0x7,
  Dhcp4Rebooting = 0x8
} EFI_DHCP4_STATE;

```

[Table 195](#) describes the fields in the above enumeration.

Table 195. DHCP4 Enumerations

Field	Description
<i>Dhcp4Stopped</i>	The EFI DHCPv4 Protocol driver is stopped and <b>EFI_DHCP4_PROTOCOL.Configure()</b> needs to be called. The rest of the <b>EFI_DHCP4_MODE_DATA</b> structure is undefined in this state.
<i>Dhcp4Init</i>	The EFI DHCPv4 Protocol driver is inactive and <b>EFI_DHCP4_PROTOCOL.Start()</b> needs to be called. The rest of the <b>EFI_DHCP4_MODE_DATA</b> structure is undefined in this state.
<i>Dhcp4Selecting</i>	The EFI DHCPv4 Protocol driver is collecting DHCP offer packets from DHCP servers. The rest of the <b>EFI_DHCP4_MODE_DATA</b> structure is undefined in this state.
<i>Dhcp4Requesting</i>	The EFI DHCPv4 Protocol driver has sent the request to the DHCP server and is waiting for a response. The rest of the <b>EFI_DHCP4_MODE_DATA</b> structure is undefined in this state.
<i>Dhcp4Bound</i>	The DHCP configuration has completed. All of the fields in the <b>EFI_DHCP4_MODE_DATA</b> structure are defined.
<i>Dhcp4Renewing</i>	The DHCP configuration is being renewed and another request has been sent out, but it has not received a response from the server yet. All of the fields in the <b>EFI_DHCP4_MODE_DATA</b> structure are available but may change soon.
<i>Dhcp4Rebinding</i>	The DHCP configuration has timed out and the EFI DHCPv4 Protocol driver is trying to extend the lease time. The rest of the <b>EFI_DHCP4_MODE</b> structure is undefined in this state.
<i>Dhcp4InitReboot</i>	The EFI DHCPv4 Protocol driver is initialized with a previously allocated or known IP address. <b>EFI_DHCP4_PROTOCOL.Start()</b> needs to be called to start the configuration process. The rest of the <b>EFI_DHCP4_MODE_DATA</b> structure is undefined in this state.
<i>Dhcp4Rebooting</i>	The EFI DHCPv4 Protocol driver is seeking to reuse the previously allocated IP address by sending a request to the DHCP server. The rest of the <b>EFI_DHCP4_MODE_DATA</b> structure is undefined in this state.

**EFI\_DHCP4\_STATE** defines the DHCP operational states that are described in RFC 2131, which can be obtained at “Links to UEFI-Related Documents” (<http://uefi.org/uefi>) under the heading “RFC 2131”.

A variable number of EFI DHCPv4 Protocol driver instances can coexist but they share the same state machine. More precisely, each communication device has a separate DHCP state machine if there are multiple communication devices. Each EFI DHCPv4 Protocol driver instance that is created by the same EFI DHCPv4 Service Binding Protocol driver instance shares the same state machine. In this document, when we refer to the state of EFI DHCPv4 Protocol driver, we actually refer to the state of the communication device from which the current EFI DHCPv4 Protocol Driver instance is created.

```

//*****
// EFI_DHCP4_PACKET
//*****
#pragma pack(1)
typedef struct {
  UINT32    Size;
  UINT32    Length;
  struct{
    EFI_DHCP4_HEADER Header;
    UINT32    Magik;
    UINT8     Option[1];
  } Dhcp4;
} EFI_DHCP4_PACKET;
#pragma pack()

```

<i>Size</i>	Size of the <b>EFI_DHCP4_PACKET</b> buffer.
<i>Length</i>	Length of the <b>EFI_DHCP4_PACKET</b> from the first byte of the <i>Header</i> field to the last byte of the <i>Option</i> [ <i>j</i> ] field.
<i>Header</i>	DHCP packet header.
<i>Magik</i>	DHCP magik cookie in network byte order.
<i>Option</i>	Start of the DHCP packed option data.

**EFI\_DHCP4\_PACKET** defines the format of DHCPv4 packets. See RFC 2131 for more information.

### Status Codes Returned

EFI_SUCCESS	The mode data was returned.
EFI_INVALID_PARAMETER	<i>This</i> is <b>NULL</b> .

## EFI\_DHCP4\_PROTOCOL.Configure()

### Summary

Initializes, changes, or resets the operational settings for the EFI DHCPv4 Protocol driver.

### Prototype

```
typedef
EFI_STATUS
(EFIAPI *EFI_DHCP4_CONFIGURE) (
    IN EFI_DHCP4_PROTOCOL *This,
    IN EFI_DHCP4_CONFIG_DATA *Dhcp4CfgData OPTIONAL
);
```

### Parameters

<i>This</i>	Pointer to the <b>EFI_DHCP4_PROTOCOL</b> instance.
<i>Dhcp4CfgData</i>	Pointer to the <b>EFI_DHCP4_CONFIG_DATA</b> . Type <b>EFI_DHCP4_CONFIG_DATA</b> is defined in “Related Definitions” below.

### Description

The **Configure()** function is used to initialize, change, or reset the operational settings of the EFI DHCPv4 Protocol driver for the communication device on which the EFI DHCPv4 Service Binding Protocol is installed. This function can be successfully called only if both of the following are true:

- This instance of the EFI DHCPv4 Protocol driver is in the *Dhcp4Stopped*, *Dhcp4Init*, *Dhcp4InitReboot*, or *Dhcp4Bound* states.
- No other EFI DHCPv4 Protocol driver instance that is controlled by this EFI DHCPv4 Service Binding Protocol driver instance has configured this EFI DHCPv4 Protocol driver.

When this driver is in the *Dhcp4Stopped* state, it can transfer into one of the following two possible initial states:

- *Dhcp4Init*
- *Dhcp4InitReboot*

The driver can transfer into these states by calling **Configure()** with a non-**NULL** *Dhcp4CfgData*. The driver will transfer into the appropriate state based on the supplied client network address in the *ClientAddress* parameter and DHCP options in the *OptionList* parameter as described in RFC 2131.

When **Configure()** is called successfully while *Dhcp4CfgData* is set to **NULL**, the default configuring data will be reset in the EFI DHCPv4 Protocol driver and the state of the EFI DHCPv4 Protocol driver will not be changed. If one instance wants to make it possible for another instance to configure the EFI DHCPv4 Protocol driver, it must call this function with *Dhcp4CfgData* set to **NULL**.

## Related Definitions

```

//*****
// EFI_DHCP4_CONFIG_DATA
//*****
typedef struct {
    UINT32    DiscoverTryCount;
    UINT32    *DiscoverTimeout;
    UINT32    RequestTryCount;
    UINT32    *RequestTimeout;
    EFI_IPv4_ADDRESS ClientAddress;
    EFI_DHCP4_CALLBACK Dhcp4Callback;
    VOID      *CallbackContext;
    UINT32    OptionCount;
    EFI_DHCP4_PACKET_OPTION **OptionList;
} EFI_DHCP4_CONFIG_DATA;

```

<i>DiscoverTryCount</i>	Number of times to try sending a packet during the <i>Dhcp4SendDiscover</i> event and waiting for a response during the <i>Dhcp4RcvdOffer</i> event. (This value is also the number of entries in the <i>DiscoverTimeout</i> array.) Set to zero to use the default try counts and timeout values.
<i>DiscoverTimeout</i>	Maximum amount of time (in seconds) to wait for returned packets in each of the retries. Timeout values of zero will default to a timeout value of one second. Set to <b>NULL</b> to use default timeout values.
<i>RequestTryCount</i>	Number of times to try sending a packet during the <i>Dhcp4SendRequest</i> event and waiting for a response during the <i>Dhcp4RcvdAck</i> event before accepting failure. (This value is also the number of entries in the <i>RequestTimeout</i> array.) Set to zero to use the default try counts and timeout values.
<i>RequestTimeout</i>	Maximum amount of time (in seconds) to wait for return packets in each of the retries. Timeout values of zero will default to a timeout value of one second. Set to <b>NULL</b> to use default timeout values.
<i>ClientAddress</i>	For a DHCPDISCOVER, setting this parameter to the previously allocated IP address will cause the EFI DHCPv4 Protocol driver to enter the <i>Dhcp4InitReboot</i> state. Also, set this field to 0.0.0.0 to enter the <i>Dhcp4Init</i> state. For a DHCPINFORM this parameter should be set to the client network address which was assigned to the client during a DHCPDISCOVER.
<i>Dhcp4Callback</i>	The callback function to intercept various events that occurred in the DHCP configuration process. Set to <b>NULL</b>

to ignore all those events. Type **EFI\_DHCP4\_CALLBACK** is defined below.

<i>CallbackContext</i>	Pointer to the context that will be passed to <i>Dhcp4Callback</i> when it is called.
<i>OptionCount</i>	Number of DHCP options in the <i>OptionList</i> .
<i>OptionList</i>	List of DHCP options to be included in every packet that is sent during the <i>Dhcp4SendDiscover</i> event. Pad options are appended automatically by DHCP driver in outgoing DHCP packets. If <i>OptionList</i> itself contains pad option, they are ignored by the driver. <i>OptionList</i> can be freed after <b>EFI_DHCP4_PROTOCOL.Configure()</b> returns. Ignored if <i>OptionCount</i> is zero. Type <b>EFI_DHCP4_PACKET_OPTION</b> is defined below.

```

//*****
// EFI_DHCP4_CALLBACK
//*****
typedef EFI_STATUS (*EFI_DHCP4_CALLBACK)(
  IN EFI_DHCP4_PROTOCOL *This,
  IN VOID *Context,
  IN EFI_DHCP4_STATE CurrentState,
  IN EFI_DHCP4_EVENT Dhcp4Event,
  IN EFI_DHCP4_PACKET *Packet, OPTIONAL
  OUT EFI_DHCP4_PACKET **NewPacket OPTIONAL
);

```

<i>This</i>	Pointer to the EFI DHCPv4 Protocol instance that is used to configure this callback function.
<i>Context</i>	Pointer to the context that is initialized by <b>EFI_DHCP4_PROTOCOL.Configure()</b> .
<i>CurrentState</i>	The current operational state of the EFI DHCPv4 Protocol driver. Type <b>EFI_DHCP4_STATE</b> is defined in <b>EFI_DHCP4_PROTOCOL.GetModeData()</b> .
<i>Dhcp4Event</i>	The event that occurs in the current state, which usually means a state transition. Type <b>EFI_DHCP4_EVENT</b> is defined below.
<i>Packet</i>	The DHCP packet that is going to be sent or already received. May be <b>NULL</b> if the event has no associated packet. Do not cache this packet except for copying it. Type <b>EFI_DHCP4_PACKET</b> is defined in <b>EFI_DHCP4_PROTOCOL.GetModeData()</b> .
<i>NewPacket</i>	The packet that is used to replace the above <i>Packet</i> . Do not set this pointer exactly to the above <i>Packet</i> or a



modified *Packet*. *NewPacket* can be **NULL** if the EFI DHCPv4 Protocol driver does not expect a new packet to be returned. The user may set *\*NewPacket* to **NULL** if no replacement occurs.

**EFI\_DHCP4\_CALLBACK** is provided by the consumer of the EFI DHCPv4 Protocol driver to intercept events that occurred in the configuration process. This structure provides advanced control of each state transition of the DHCP process. The returned status code determines the behavior of the EFI DHCPv4 Protocol driver. There are three possible returned values, which are described in the following table.

EFI_SUCCESS	Tells the EFI DHCPv4 Protocol driver to continue the DHCP process. When it is in the <i>Dhcp4Selecting</i> state, it tells the EFI DHCPv4 Protocol driver to stop collecting additional packets. The driver will exit the <i>Dhcp4Selecting</i> state and enter the <i>Dhcp4Requesting</i> state.
EFI_NOT_READY	Only used in the <i>Dhcp4Selecting</i> state. The EFI DHCPv4 Protocol driver will continue to wait for more packets until the retry timeout expires.
EFI_ABORTED	Tells the EFI DHCPv4 Protocol driver to abort the current process and return to the <i>Dhcp4Init</i> or <i>Dhcp4InitReboot</i> state.

```

//*****
// EFI_DHCP4_EVENT
//*****
typedef enum {
  Dhcp4SendDiscover   = 0x01,
  Dhcp4RcvdOffer      = 0x02,
  Dhcp4SelectOffer    = 0x03,
  Dhcp4SendRequest    = 0x04,
  Dhcp4RcvdAck        = 0x05,
  Dhcp4RcvdNak        = 0x06,
  Dhcp4SendDecline    = 0x07,
  Dhcp4BoundCompleted = 0x08,
  Dhcp4EnterRenewing  = 0x09,
  Dhcp4EnterRebinding = 0x0a,
  Dhcp4AddressLost    = 0x0b,
  Dhcp4Fail           = 0x0c
} EFI_DHCP4_EVENT;

```

Following is a description of the fields in the above enumeration.

*Dhcp4SendDiscover*      The packet to start the configuration sequence is about to be sent. The packet is passed to *Dhcp4Callback* and can be modified or replaced in *Dhcp4Callback*.

*Dhcp4RcvdOffer*         A reply packet was just received. This packet is passed to *Dhcp4Callback*, which may copy this packet and cache it

for selecting a task later. If the callback returns **EFI\_SUCCESS**, this driver will finish the selecting state. If **EFI\_NOT\_READY** is returned, this driver will continue to wait for additional reply packets until the timer expires. In either case, *Dhcp4SelectOffer* will occur for the user to select an offer.

- Dhcp4SelectOffer* It is time for *Dhcp4Callback* to select an offer. This driver passes the latest received DHCPOFFER packet to the callback. The *Dhcp4Callback* may store one packet in the *NewPacket* parameter of the function that was selected from previously received DHCPOFFER packets. If the latest packet is the selected one or if the user does not care about it, no extra overhead is needed. Simply skipping this event is enough.
- Dhcp4SendRequest* A request packet is about to be sent. The user can modify or replace this packet.
- Dhcp4RcvdAck* A DHCPACK packet was received and will be passed to *Dhcp4Callback*. The callback may decline this DHCPACK packet by returning **EFI\_ABORTED**. In this case, the EFI DHCPv4 Protocol driver will proceed to the *Dhcp4SendDecline* event.
- Dhcp4RcvdNak* A DHCPNAK packet was received and will be passed to *Dhcp4Callback*. The EFI DHCPv4 Protocol driver will then return to the *Dhcp4Init* state no matter what status code is returned from the callback function.
- Dhcp4SendDecline* A decline packet is about to be sent. *Dhcp4Callback* can modify or replace this packet. The EFI DHCPv4 Protocol driver will then be set to the *Dhcp4Init* state.
- Dhcp4BoundCompleted* The DHCP configuration process has completed. No packet is associated with this event.
- Dhcp4EnterRenewing* It is time to enter the *Dhcp4Renewing* state and to contact the server that originally issued the network address. No packet is associated with this event.
- Dhcp4EnterRebinding* It is time to enter the *Dhcp4Rebinding* state and to contact any server. No packet is associated with this event.
- Dhcp4AddressLost* The configured IP address was lost either because the lease has expired, the user released the configuration, or a DHCPNAK packet was received in the *Dhcp4Renewing* or *Dhcp4Rebinding* state. No packet is associated with this event.
- Dhcp4Fail* The DHCP process failed because a DHCPNAK packet was received or the user aborted the DHCP process at a time when the configuration was not available yet. No packet is associated with this event.

```

//*****
// EFI_DHCP4_HEADER
//*****
#pragma pack(1)
typedef struct{
    UINT8    OpCode;
    UINT8    HwType;
    UINT8    HwAddrLen;
    UINT8    Hops;
    UINT32   Xid;
    UINT16   Seconds;
    UINT16   Reserved;
    EFI_IPv4_ADDRESS ClientAddr;
    EFI_IPv4_ADDRESS YourAddr;
    EFI_IPv4_ADDRESS ServerAddr;
    EFI_IPv4_ADDRESS GatewayAddr;
    UINT8    ClientHwAddr[16];
    CHAR8    ServerName[64];
    CHAR8    BootFileName[128];
} EFI_DHCP4_HEADER;
#pragma pack()

```

<i>OpCode</i>	Message type. 1 = BOOTREQUEST, 2 = BOOTREPLY.
<i>HwType</i>	Hardware address type.
<i>HwAddrLen</i>	Hardware address length.
<i>Hops</i>	Maximum number of hops (routers, gateways, or relay agents) that this DHCP packet can go through before it is dropped.
<i>Xid</i>	DHCP transaction ID.
<i>Seconds</i>	Number of seconds that have elapsed since the client began address acquisition or the renewal process.
<i>Reserved</i>	Reserved for future use.
<i>ClientAddr</i>	Client IP address from the client.
<i>YourAddr</i>	Client IP address from the server.
<i>ServerAddr</i>	IP address of the next server in bootstrap.
<i>GatewayAddr</i>	Relay agent IP address.
<i>ClientHwAddr</i>	Client hardware address.
<i>ServerName</i>	Optional server host name.
<i>BootFileName</i>	Boot file name.

**EFI\_DHCP4\_HEADER** describes the semantics of the DHCP packet header. This packet header is in network byte order.

```

//*****
// EFI_DHCP4_PACKET_OPTION
//*****
#pragma pack(1)
typedef struct {
    UINT8  OpCode;
    UINT8  Length;
    UINT8  Data[1];
} EFI_DHCP4_PACKET_OPTION;
#pragma pack()
    
```

*OpCode* DHCP option code.

*Length* Length of the DHCP option data. Not present if *OpCode* is 0 or 255.

*Data* Start of the DHCP option data. Not present if *OpCode* is 0 or 255 or if *Length* is zero.

The DHCP packet option data structure is used to reference option data that is packed in the DHCP packets. Use caution when accessing multibyte fields because the information in the DHCP packet may not be properly aligned for the machine architecture.

### Status Codes Returned

EFI_SUCCESS	The EFI DHCPv4 Protocol driver is now in the <i>Dhcp4Init</i> or <i>Dhcp4InitReboot</i> state, if the original state of this driver was <i>Dhcp4Stopped</i> , <i>Dhcp4Init</i> , <i>Dhcp4InitReboot</i> , or <i>Dhcp4Bound</i> and the value of <i>Dhcp4CfgData</i> was not <b>NULL</b> . Otherwise, the state was left unchanged.
EFI_ACCESS_DENIED	This instance of the EFI DHCPv4 Protocol driver was not in the <i>Dhcp4Stopped</i> , <i>Dhcp4Init</i> , <i>Dhcp4InitReboot</i> , or <i>Dhcp4Bound</i> state.
EFI_ACCESS_DENIED	Another instance of this EFI DHCPv4 Protocol driver is already in a valid configured state.
EFI_INVALID_PARAMETER	<ul style="list-style-type: none"> <li>One or more following conditions are <b>TRUE</b>:</li> <li><i>This</i> is <b>NULL</b>.</li> <li><i>DiscoverTryCount</i> &gt; 0 and <i>DiscoverTimeout</i> is <b>NULL</b>.</li> <li><i>RequestTryCount</i> &gt; 0 and <i>RequestTimeout</i> is <b>NULL</b>.</li> <li><i>OptionCount</i> &gt; 0 and <i>OptionList</i> is <b>NULL</b>.</li> <li><i>ClientAddress</i> is not a valid unicast address.</li> </ul>
EFI_OUT_OF_RESOURCES	Required system resources could not be allocated.
EFI_DEVICE_ERROR	An unexpected system or network error occurred.

## EFI\_DHCP4\_PROTOCOL.Start()

### Summary

Starts the DHCP configuration process.

### Prototype

```
typedef
EFI_STATUS
(EFIAPI *EFI_DHCP4_START) (
  IN EFI_DHCP4_PROTOCOL *This,
  IN EFI_EVENT CompletionEvent OPTIONAL
);
```

### Parameters

<i>This</i>	Pointer to the <b>EFI_DHCP4_PROTOCOL</b> instance.
<i>CompletionEvent</i>	If not <b>NULL</b> , indicates the event that will be signaled when the EFI DHCPv4 Protocol driver is transferred into the <i>Dhcp4Bound</i> state or when the DHCP process is aborted. <b>EFI_DHCP4_PROTOCOL.GetModeData()</b> can be called to check the completion status. If <b>NULL</b> , <b>EFI_DHCP4_PROTOCOL.Start()</b> will wait until the driver is transferred into the <i>Dhcp4Bound</i> state or the process fails.

### Description

The **Start()** function starts the DHCP configuration process. This function can be called only when the EFI DHCPv4 Protocol driver is in the *Dhcp4Init* or *Dhcp4InitReboot* state.

If the DHCP process completes successfully, the state of the EFI DHCPv4 Protocol driver will be transferred through *Dhcp4Selecting* and *Dhcp4Requesting* to the *Dhcp4Bound* state. The *CompletionEvent* will then be signaled if it is not **NULL**.

If the process aborts, either by the user or by some unexpected network error, the state is restored to the *Dhcp4Init* state. The **Start()** function can be called again to restart the process.

Refer to RFC 2131 for precise state transitions during this process. At the time when each event occurs in this process, the callback function that was set by **EFI\_DHCP4\_PROTOCOL.Configure()** will be called and the user can take this opportunity to control the process.

### Status Codes Returned

EFI_SUCCESS	The DHCP configuration process has started, or it has completed when <i>CompletionEvent</i> is <b>NULL</b> .
EFI_NOT_STARTED	The EFI DHCPv4 Protocol driver is in the <i>Dhcp4Stopped</i> state. <b>EFI_DHCP4_PROTOCOL.Configure()</b> needs to be called.
EFI_INVALID_PARAMETER	<i>This</i> is <b>NULL</b> .

EFI_OUT_OF_RESOURCES	Required system resources could not be allocated.
EFI_TIMEOUT	The DHCP configuration process failed because no response was received from the server within the specified timeout value.
EFI_ABORTED	The user aborted the DHCP process.
EFI_ALREADY_STARTED	Some other EFI DHCPv4 Protocol instance already started the DHCP process.
EFI_DEVICE_ERROR	An unexpected network or system error occurred.
EFI_NO_MEDIA	There was a media error.

## EFI\_DHCP4\_PROTOCOL.RenewRebind()

### Summary

Extends the lease time by sending a request packet.

### Prototype

```
typedef
EFI_STATUS
(EFIAPI *EFI_DHCP4_RENEW_REBIND) (
  IN EFI_DHCP4_PROTOCOL *This,
  IN BOOLEAN      RebindRequest,
  IN EFI_EVENT    CompletionEvent OPTIONAL
);
```

### Parameters

<i>This</i>	Pointer to the <b>EFI_DHCP4_PROTOCOL</b> instance.
<i>RebindRequest</i>	If <b>TRUE</b> , this function broadcasts the request packets and enters the <i>Dhcp4Rebinding</i> state. Otherwise, it sends a unicast request packet and enters the <i>Dhcp4Renewing</i> state.
<i>CompletionEvent</i>	If not <b>NULL</b> , this event is signaled when the renew/rebind phase completes or some error occurs. <b>EFI_DHCP4_PROTOCOL.GetModeData()</b> can be called to check the completion status. If <b>NULL</b> , <b>EFI_DHCP4_PROTOCOL.RenewRebind()</b> will busy-wait until the DHCP process finishes.

### Description

The **RenewRebind()** function is used to manually extend the lease time when the EFI DHCPv4 Protocol driver is in the *Dhcp4Bound* state and the lease time has not expired yet. This function will send a request packet to the previously found server (or to any server when *RebindRequest* is **TRUE**) and transfer the state into the *Dhcp4Renewing* state (or *Dhcp4Rebinding* when *RebindingRequest* is **TRUE**). When a response is received, the state is returned to *Dhcp4Bound*.

If no response is received before the try count is exceeded (the *RequestTryCount* field that is specified in **EFI\_DHCP4\_CONFIG\_DATA**) but before the lease time that was issued by the previous server expires, the driver will return to the *Dhcp4Bound* state and the previous configuration is restored. The outgoing and incoming packets can be captured by the **EFI\_DHCP4\_CALLBACK** function.

### Status Codes Returned

EFI_SUCCESS	The EFI DHCPv4 Protocol driver is now in the <i>Dhcp4Renewing</i> state or is back to the <i>Dhcp4Bound</i> state.
-------------	--

EFI_NOT_STARTED	The EFI DHCPv4 Protocol driver is in the <i>Dhcp4Stopped</i> state. <b>EFI_DHCP4_PROTOCOL.Configure()</b> needs to be called.
EFI_INVALID_PARAMETER	<i>This</i> is <b>NULL</b> .
EFI_TIMEOUT	There was no response from the server when the try count was exceeded.
EFI_ACCESS_DENIED	The driver is not in the <i>Dhcp4Bound</i> state.
EFI_DEVICE_ERROR	An unexpected network or system error occurred.



## EFI\_DHCP4\_PROTOCOL.Release()

### Summary

Releases the current address configuration.

### Prototype

```
typedef
EFI_STATUS
(EFIAPI *EFI_DHCP4_RELEASE) (
    IN EFI_DHCP4_PROTOCOL *This
);
```

### Parameters

*This* Pointer to the **EFI\_DHCP4\_PROTOCOL** instance.

### Description

The **Release()** function releases the current configured IP address by doing either of the following:

- Sending a DHCPRELEASE packet when the EFI DHCPv4 Protocol driver is in the *Dhcp4Bound* state
- Setting the previously assigned IP address that was provided with the **EFI\_DHCP4\_PROTOCOL.Configure()** function to 0.0.0.0 when the driver is in *Dhcp4InitReboot* state

After a successful call to this function, the EFI DHCPv4 Protocol driver returns to the *Dhcp4Init* state and any subsequent incoming packets will be discarded silently.

### Status Codes Returned

EFI_SUCCESS	The EFI DHCPv4 Protocol driver is now in the <i>Dhcp4Init</i> phase.
EFI_INVALID_PARAMETER	<i>This</i> is <b>NULL</b> .
EFI_ACCESS_DENIED	The EFI DHCPv4 Protocol driver is not in the <i>Dhcp4Bound</i> or <i>Dhcp4InitReboot</i> state.
EFI_DEVICE_ERROR	An unexpected network or system error occurred.

## EFI\_DHCP4\_PROTOCOL.Stop()

### Summary

Stops the DHCP configuration process.

### Prototype

```
typedef
EFI_STATUS
(EFI_API *EFI_DHCP4_STOP) (
    IN EFI_DHCP4_PROTOCOL *This
);
```

### Parameters

*This* Pointer to the **EFI\_DHCP4\_PROTOCOL** instance.

### Description

The **Stop()** function is used to stop the DHCP configuration process. After this function is called successfully, the EFI DHCPv4 Protocol driver is transferred into the *Dhcp4Stopped* state. **EFI\_DHCP4\_PROTOCOL.Configure()** needs to be called before DHCP configuration process can be started again. This function can be called when the EFI DHCPv4 Protocol driver is in any state.

### Status Codes Returned

EFI_SUCCESS	The EFI DHCPv4 Protocol driver is now in the <i>Dhcp4Stopped</i> state.
EFI_INVALID_PARAMETER	<i>This</i> is <b>NULL</b> .
EFI_NO_MEDIA	There was a media error.

## EFI\_DHCP4\_PROTOCOL.Build()

### Summary

Builds a DHCP packet, given the options to be appended or deleted or replaced.

### Prototype

```
typedef
EFI_STATUS
(EFIAPI *EFI_DHCP4_BUILD) (
  IN EFI_DHCP4_PROTOCOL  *This,
  IN EFI_DHCP4_PACKET    *SeedPacket,
  IN UINT32               DeleteCount,
  IN UINT8                *DeleteList  OPTIONAL,
  IN UINT32               AppendCount,
  IN EFI_DHCP4_PACKET_OPTION *AppendList[]  OPTIONAL,
  OUT EFI_DHCP4_PACKET    **NewPacket
);
```

### Parameters

<i>This</i>	Pointer to the <b>EFI_DHCP4_PROTOCOL</b> instance.
<i>SeedPacket</i>	Initial packet to be used as a base for building new packet. Type <b>EFI_DHCP4_PACKET</b> is defined in <b>EFI_DHCP4_PROTOCOL.GetModeData()</b> .
<i>DeleteCount</i>	Number of opcodes in the <i>DeleteList</i> .
<i>DeleteList</i>	List of opcodes to be deleted from the seed packet. Ignored if <i>DeleteCount</i> is zero.
<i>AppendCount</i>	Number of entries in the <i>OptionList</i> .
<i>AppendList</i>	Pointer to a DHCP option list to be appended to <i>SeedPacket</i> . If <i>SeedPacket</i> also contains options in this list, they are replaced by new options (except pad option). Ignored if <i>AppendCount</i> is zero. Type <b>EFI_DHCP4_PACKET_OPTION</b> is defined in <b>EFI_DHCP4_PROTOCOL.Configure()</b> .
<i>NewPacket</i>	Pointer to storage for the pointer to the new allocated packet. Use the EFI Boot Service <b>FreePool()</b> on the resulting pointer when done with the packet.

### Description

The **Build()** function is used to assemble a new packet from the original packet by replacing or deleting existing options or appending new options. This function does not change any state of the EFI DHCPv4 Protocol driver and can be used at any time.

## Status Codes Returned

EFI_SUCCESS	The new packet was built.
EFI_OUT_OF_RESOURCES	Storage for the new packet could not be allocated.
EFI_INVALID_PARAMETER	One or more of the following conditions is <b>TRUE</b> : <ul style="list-style-type: none"><li>• <i>This</i> is <b>NULL</b>.</li><li>• <i>SeedPacket</i> is <b>NULL</b>.</li><li>• <i>SeedPacket</i> is not a well-formed DHCP packet.</li><li>• <i>AppendCount</i> is not zero and <i>AppendList</i> is <b>NULL</b>.</li><li>• <i>DeleteCount</i> is not zero and <i>DeleteList</i> is <b>NULL</b>.</li><li>• <i>NewPacket</i> is <b>NULL</b></li><li>• Both <i>DeleteCount</i> and <i>AppendCount</i> are zero and <i>NewPacket</i> is not <b>NULL</b>.</li></ul>

## EFI\_DHCP4\_PROTOCOL.TransmitReceive()

### Summary

Transmits a DHCP formatted packet and optionally waits for responses.

### Prototype

```
typedef
EFI_STATUS
(EFI_API *EFI_DHCP4_TRANSMIT_RECEIVE) (
    IN EFI_DHCP4_PROTOCOL      *This,
    IN EFI_DHCP4_TRANSMIT_RECEIVE_TOKEN *Token
);
```

### Parameters

<i>This</i>	Pointer to the <b>EFI_DHCP4_PROTOCOL</b> instance.
<i>Token</i>	Pointer to the <b>EFI_DHCP4_TRANSMIT_RECEIVE_TOKEN</b> structure. Type <b>EFI_DHCP4_TRANSMIT_RECEIVE_TOKEN</b> is defined in “Related Definitions” below.

### Description

The **TransmitReceive()** function is used to transmit a DHCP packet and optionally wait for the response from servers. This function does not change the state of the EFI DHCPv4 Protocol driver and thus can be used at any time.

### Related Definitions

```

//*****
// EFI_DHCP4_TRANSMIT_RECEIVE_TOKEN
//*****
typedef struct {
    EFI_STATUS      Status;
    EFI_EVENT      CompletionEvent;
    EFI_IPv4_ADDRESS RemoteAddress;
    UINT16         RemotePort;
    EFI_IPv4_ADDRESS GatewayAddress;
    UINT32         ListenPointCount;
    EFI_DHCP4_LISTEN_POINT *ListenPoints;
    UINT32         TimeoutValue;
    EFI_DHCP4_PACKET *Packet;
    UINT32         ResponseCount;
    EFI_DHCP4_PACKET *ResponseList;
} EFI_DHCP4_TRANSMIT_RECEIVE_TOKEN;
```

<i>Status</i>	The completion status of transmitting and receiving. Possible values are described in the “Status Codes Returned” table below. When <i>CompletionEvent</i> is <b>NULL</b> ,
---------------	---

	this status is the same as the one returned by the <b>TransmitReceive()</b> function.
<i>CompletionEvent</i>	If not <b>NULL</b> , the event that will be signaled when the collection process completes. If <b>NULL</b> , this function will busy-wait until the collection process competes.
<i>RemoteAddress</i>	Pointer to the server IP address. This address may be a unicast, multicast, or broadcast address.
<i>RemotePort</i>	Server listening port number. If zero, the default server listening port number (67) will be used.
<i>GatewayAddress</i>	Pointer to the gateway address to override the existing setting.
<i>ListenPointCount</i>	The number of entries in <i>ListenPoints</i> . If zero, the default station address and port number 68 are used.
<i>ListenPoints</i>	An array of station address and port number pairs that are used as receiving filters. The first entry is also used as the source address and source port of the outgoing packet. Type <b>EFI_DHCP4_LISTEN_POINT</b> is defined below.
<i>TimeoutValue</i>	Number of seconds to collect responses. Zero is invalid.
<i>Packet</i>	Pointer to the packet to be transmitted. Type <b>EFI_DHCP4_PACKET</b> is defined in <b>EFI_DHCP4_PROTOCOL.GetModeData()</b> .
<i>ResponseCount</i>	Number of received packets.
<i>ResponseList</i>	Pointer to the allocated list of received packets. The caller must use the EFI Boot Service <b>FreePool()</b> when done using the received packets.

```

//*****
// EFI_DHCP4_LISTEN_POINT
//*****
typedef struct {
    EFI_IPv4_ADDRESS ListenAddress;
    EFI_IPv4_ADDRESS SubnetMask;
    UINT16 ListenPort;
} EFI_DHCP4_LISTEN_POINT;

```

<i>ListenAddress</i>	Alternate listening address. It can be a unicast, multicast, or broadcast address. The <b>TransmitReceive()</b> function will collect only those packets that are destined to this address.
<i>SubnetMask</i>	The subnet mask of above listening unicast/broadcast IP address. Ignored if <i>ListenAddress</i> is a multicast address. If it is <b>0.0.0.0</b> , the subnet mask is automatically computed

*ListenPort*

from unicast *ListenAddress*. Cannot be **0.0.0.0** if *ListenAddress* is direct broadcast address on subnet.  
 Alternate station source (or listening) port number. If zero, then the default station port number (68) will be used.

**Status Codes Returned**

EFI_SUCCESS	The packet was successfully queued for transmission.
EFI_INVALID_PARAMETER	One or more of the following conditions is <b>TRUE</b> : <ul style="list-style-type: none"> <li>• <i>This</i> is <b>NULL</b>.</li> <li>• <i>Token.RemoteAddress</i> is zero.</li> <li>• <i>Token.Packet</i> is <b>NULL</b>.</li> <li>• <i>Token.Packet</i> is not a well-formed DHCP packet.</li> <li>• The transaction ID in <i>Token.Packet</i> is in use by another DHCP process.</li> </ul>
EFI_NOT_READY	The previous call to this function has not finished yet. Try to call this function after collection process completes.
EFI_NO_MAPPING	The default station address is not available yet.
EFI_OUT_OF_RESOURCES	Required system resources could not be allocated.
EFI_UNSUPPORTED	The implementation doesn't support this function
EFI_NO_MEDIA	There was a media error.
Others	Some other unexpected error occurred.

## EFI\_DHCP4\_PROTOCOL.Parse()

### Summary

Parses the packed DHCP option data.

### Prototype

```
typedef
EFI_STATUS
(EFI_API *EFI_DHCP4_PARSE) (
  IN EFI_DHCP4_PROTOCOL *This,
  IN EFI_DHCP4_PACKET *Packet
  IN OUT UINT32 *OptionCount,
  IN OUT EFI_DHCP4_PACKET_OPTION *PacketOptionList[] OPTIONAL
);
```

### Parameters

<i>This</i>	Pointer to the <b>EFI_DHCP4_PROTOCOL</b> instance.
<i>Packet</i>	Pointer to packet to be parsed. Type <b>EFI_DHCP4_PACKET</b> is defined in <b>EFI_DHCP4_PROTOCOL.GetModeData()</b> .
<i>OptionCount</i>	On input, the number of entries in the <i>PacketOptionList</i> . On output, the number of entries that were written into the <i>PacketOptionList</i> .
<i>PacketOptionList</i>	List of packet option entries to be filled in. End option or pad options are not included. Type <b>EFI_DHCP4_PACKET_OPTION</b> is defined in <b>EFI_DHCP4_PROTOCOL.Configure()</b> .

### Description

The **Parse()** function is used to retrieve the option list from a DHCP packet. If **\*OptionCount** isn't zero, and there is enough space for all the DHCP options in the **Packet**, each element of **PacketOptionList** is set to point to somewhere in the **Packet->Dhcp4.Option** where a new DHCP option begins. If RFC3396 is supported, the caller should reassemble the parsed DHCP options to get the final result. If **\*OptionCount** is zero or there isn't enough space for all of them, the number of DHCP options in the **Packet** is returned in **OptionCount**.

### Status Codes Returned

EFI_SUCCESS	The packet was successfully parsed.
-------------	-------------------------------------



EFI_INVALID_PARAMETER	One or more of the following conditions is <b>TRUE</b> : <ul style="list-style-type: none"> <li>• <i>This</i> is <b>NULL</b>.</li> <li>• <i>Packet</i> is <b>NULL</b>.</li> <li>• <i>Packet</i> is not a well-formed DHCP packet.</li> <li>• <i>OptionCount</i> is <b>NULL</b>.</li> </ul>
EFI_BUFFER_TOO_SMALL	One or more of the following conditions is <b>TRUE</b> : <ul style="list-style-type: none"> <li>• <i>*OptionCount</i> is smaller than the number of options that were found in the <i>Packet</i>.</li> <li>• <i>PacketOptionList</i> is <b>NULL</b>.</li> </ul>
EFI_OUT_OF_RESOURCE	The packet is failed to parse because of resource shortage.

## 29.3 EFI DHCP6 Protocol

This section provides a detailed description of the **EFI\_DHCP6\_PROTOCOL** and the **EFI\_DHCP6\_SERVICE\_BINDING\_PROTOCOL**.

### 29.3.1 DHCP6 Service Binding Protocol

#### EFI\_DHCP6\_SERVICE\_BINDING\_PROTOCOL

##### Summary

The EFI DHCPv6 Service Binding Protocol is used to locate communication devices that are supported by an EFI DHCPv6 Protocol driver and to create and destroy EFI DHCPv6 Protocol child instances that can use the underlying communications device.

##### GUID

```
#define EFI_DHCP6_SERVICE_BINDING_PROTOCOL_GUID \
  {0x9fb9a8a1,0x2f4a,0x43a6,\
  {0x88,0x9c,0xd0,0xf7,0xb6,0xc4,0x7a,0xd5}}
```

##### Description

A network application or driver that requires basic DHCPv6 services can use one of the protocol handler services, such as **BS->LocateHandleBuffer()**, to search for devices that publish an EFI DHCPv6 Service Binding Protocol GUID. Each device with a published EFI DHCPv6 Service Binding Protocol GUID supports the EFI DHCPv6 Protocol and may be available for use.

After a successful call to the **EFI\_DHCP6\_SERVICE\_BINDING\_PROTOCOL.CreateChild()** function, the newly created EFI DHCPv6 Protocol child instance is ready to be used by a network application or driver.

Before a network application or driver terminates execution, every successful call to the **EFI\_DHCP6\_SERVICE\_BINDING\_PROTOCOL.CreateChild()** function must be matched with a call to the **EFI\_DHCP6\_SERVICE\_BINDING\_PROTOCOL.DestroyChild()** function.

## 29.3.2 DHCP6 Protocol

### EFI\_DHCP6\_PROTOCOL

#### Summary

The EFI DHCPv6 Protocol is used to get IPv6 addresses and other configuration parameters from DHCPv6 servers.

#### GUID

```
#define EFI_DHCP6_PROTOCOL_GUID \
  {0x87c8bad7,0x595,0x4053,\
   {0x82,0x97,0xde,0xde,0x39,0x5f,0x5d,0x5b}}
```

#### Protocol Interface Structure

```
typedef struct _EFI_DHCP6_PROTOCOL {
  EFI_DHCP6_GET_MODE_DATA GetModeData;
  EFI_DHCP6_CONFIGURE Configure;
  EFI_DHCP6_START Start;
  EFI_DHCP6_INFO_REQUEST InfoRequest;
  EFI_DHCP6_RENEW_REBIND RenewRebind;
  EFI_DHCP6_DECLINE Decline;
  EFI_DHCP6_RELEASE Release;
  EFI_DHCP6_STOP Stop;
  EFI_DHCP6_PARSE Parse;
} EFI_DHCP6_PROTOCOL;
```

#### Parameters

##### *GetModeData*

Get the current operating mode data and configuration data for the EFI DHCPv6 Protocol instance. See the **GetModeData()** function description.

##### *Configure*

Initialize or clean up the configuration data for the EFI DHCPv6 Protocol instance. See the **Configure()** function description.

##### *Start*

Start the DHCPv6 S.A.R.R process. See the **Start()** function description.

##### *InfoRequest*

Request configuration parameters without the assignment of any IPv6 addresses to the client. See the **InfoRequest()** function description.

##### *RenewRebind*

Tries to manually extend the valid and preferred lifetimes for the IPv6 addresses of the configured IA by sending Renew or Rebind packet. See the **RenewRebind()** function description.

*Decline*

Inform that one or more addresses assigned by a DHCPv6 server are already in use by another node. See the **Decline()** function description.

*Release*

Release one or more addresses associated with the configured IA. See the **Release()** function description.

*Stop*

Stop the DHCPv6 S.A.R.R process. See the **Stop()** function description.

*Parse*

Parses the option data in the DHCPv6 packet. See the **Parse()** function description.

## Description

The EFI DHCPv6 Protocol is used to get IPv6 addresses and other configuration parameters from DHCPv6 servers.

**Note:** *Byte Order: All the IPv6 addresses that are described in EFI\_DHCP6\_PROTOCOL are stored in network byte order. Both incoming and outgoing DHCPv6 packets are also in network byte order. All other parameters that are defined in functions or data structures are stored in host byte order*

## EFI\_DHCP6\_PROTOCOL.GetModeData ()

### Summary

Retrieve the current operating mode data and configuration data for the EFI DHCPv6 Protocol instance.

### Prototype

```
typedef
EFI_STATUS
(EFIAPI *EFI_DHCP6_GET_MODE_DATA)(
  IN EFI_DHCP6_PROTOCOL *This,
  OUT EFI_DHCP6_MODE_DATA *Dhcp6ModeData OPTIONAL,
  OUT EFI_DHCP6_CONFIG_DATA *Dhcp6ConfigData OPTIONAL
);
```

### Parameters

*This*

Pointer to the **EFI\_DHCP6\_PROTOCOL** instance.

*Dhcp6ModeData*

Pointer to the DHCPv6 mode data structure. The caller is responsible for freeing this structure and each reference buffer. Type

**EFI\_DHCP6\_MODE\_DATA** is defined in “Related Definitions” below.

*Dhcp6ConfigData*

Pointer to the DHCPv6 configuration data structure. The caller is responsible for freeing this structure and each reference buffer. Type

**EFI\_DHCP6\_CONFIG\_DATA** is defined in **EFI\_DHCP6\_PROTOCOL.Configure()**.

### Description

Retrieve the current operating mode data and configuration data for the EFI DHCPv6 Protocol instance.

### Related Definitions

```
/**
// EFI_DHCP6_MODE_DATA
//
typedef struct {
  EFI_DHCP6_DUID *ClientId;
  EFI_DHCP6_IA *Ia;
} EFI_DHCP6_MODE_DATA;
```

*ClientId*

Pointer to the DHCPv6 unique identifier. The caller is responsible for freeing this buffer. Type **EFI\_DHCP6\_DUID** is defined below.

*la*

Pointer to the configured IA of current instance. The caller can free this buffer after using it. Type **EFI\_DHCP6\_IA** is defined below.

```

//*****
// EFI_DHCP6_DUID
//*****
typedef struct {
    UINT16 Length;
    UINT8 Duid[1];
} EFI_DHCP6_DUID;

```

*Length*

Length of DUID in octets.

*Duid*

Array of DUID octets.

The *EFI\_DHCP6\_DUID* structure is to specify DHCPv6 unique identifier for either DHCPv6 client or DHCPv6 server. The DUID-UUID shall be used for all transactions.

```

//*****
// EFI_DHCP6_IA
//*****
typedef struct {
    EFI_DHCP6_IA_DESCRIPTOR Descriptor;
    EFI_DHCP6_STATE State;
    EFI_DHCP6_PACKACT *ReplyPacket;
    UINT32 IaAddressCount;
    EFI_DHCP6_IA_ADDRESS IaAddress[1];
} EFI_DHCP6_IA;

```

*Descriptor*

The descriptor for IA. Type **EFI\_DHCP6\_IA\_DESCRIPTOR** is defined below.

*State*

The state of the configured IA. Type **EFI\_DHCP6\_STATE** is defined below.

*ReplyPacket*

Pointer to the cached latest Reply packet. May be **NULL** if no packet is cached.

*IaAddressCount*

Number of IPv6 addresses of the configured IA.

*laAddress*

List of the IPv6 addresses of the configured IA. When the state of the configured IA is in *Dhcp6Bound*, *Dhcp6Renewing* and *Dhcp6Rebinding*, the IPv6 addresses are usable. Type **EFI\_DHCP6\_IA\_ADDRESS** is defined below.

```

//*****
// EFI_DHCP6_IA_DESCRIPTOR
//*****
typedef struct {
    UINT16    Type;
    UINT32    laId;
} EFI_DHCP6_IA_DESCRIPTOR;

```

*Type*

Type for an IA.

*laId*

The identifier for an IA.

```
#define EFI_DHCP6_IA_TYPE_NA 3
```

```
#define EFI_DHCP6_IA_TYPE_TA 4
```

*EFI\_DHCP6\_IA\_TYPE\_NA*

An IA which carries assigned not temporary address.

*EFI\_DHCP6\_IA\_TYPE\_TA*

An IA which carries assigned temporary address.

```

//*****
// EFI_DHCP6_STATE
//*****
typedef enum {
    Dhcp6Init      = 0x0,
    Dhcp6Selecting = 0x1,
    Dhcp6Requesting = 0x2,
    Dhcp6Declining = 0x3,
    Dhcp6Confirming = 0x4,
    Dhcp6Releasing = 0x5,
    Dhcp6Bound     = 0x6,
    Dhcp6Renewing  = 0x7,
    Dhcp6Rebinding = 0x8
} EFI_DHCP6_STATE;

```

[Table 196](#) describes the fields in the above enumeration.

**Table 196. Field Descriptions**

<b>Dhcp6Init</b>	The EFI DHCPv6 Protocol instance is configured, and <code>start()</code> needs to be called
<b>Dhcp6Selecting</b>	A Solicit packet is sent out to discover DHCPv6 server, and the EFI DHCPv6 Protocol instance is collecting Advertise packets.
<b>Dhcp6Requesting</b>	A Request is sent out to the DHCPv6 server, and the EFI DHCPv6 Protocol instance is waiting for Reply packet.
<b>Dhcp6Declining</b>	A Decline packet is sent out to indicate one or more addresses of the configured IA are in use by another node, and the EFI DHCPv6 Protocol instance is waiting for Reply packet.
<b>Dhcp6Confirming</b>	A Confirm packet is sent out to confirm the IPv6 addresses of the configured IA, and the EFI DHCPv6 Protocol instance is waiting for Reply packet
<b>Dhcp6Releasing</b>	A Release packet is sent out to release one or more IPv6 addresses of the configured IA, and the EFI DHCPv6 Protocol instance is waiting for Reply packet.
<b>Dhcp6Bound</b>	The DHCPv6 S.A.R.R process is completed for the configured IA.
<b>Dhcp6Renewing</b>	A Renew packet is sent out to extend lifetime for the IPv6 addresses of the configured IA, and the EFI DHCPv6 Protocol instance is waiting for Reply packet.
<b>Dhcp6Rebinding</b>	A Rebind packet is sent out to extend lifetime for the IPv6 addresses of the configured IA, and the EFI DHCPv6 Protocol instance is waiting for Reply packet.

```

//*****
// EFI_DHCP6_IA_ADDRESS
//*****
typedef struct {
    EFI_IPv6_ADDRESS IpAddress;
    UINT32 PreferredLifetime;
    UINT32 ValidLifetime;
} EFI_DHCP6_IA_ADDRESS;

```

*IpAddress*

The IPv6 address.

*PreferredLifetime*

The preferred lifetime in unit of seconds for the IPv6 address.

*ValidLifetime*

The valid lifetime in unit of seconds for the IPv6 address.

The **EFI\_DHCP6\_IA\_ADDRESS** structure is specify IPv6 address associated with an IA.

```

//*****
// EFI_DHCP6_PACKET
//*****
#pragma pack(1)
typedef struct {
    UINT32 Size;
    UINT32 Length;
    struct{
        EFI_DHCP6_HEADER Header;
        UINT8 Option[1];
    } Dhcp6;
} EFI_DHCP6_PACKET;
#pragma pack()

```

*Size*

Size of the **EFI\_DHCP6\_PACKET** buffer.

*Length*

Length of the **EFI\_DHCP6\_PACKET** from the first byte of the **Header** field to the last byte of the *Option[]* field.

*Header*

The DHCPv6 packet header.

*Option*

Start of the DHCPv6 packed option data.

**EFI\_DHCP6\_PACKET** defines the format of the DHCPv6 packet. See RFC 3315 for more information.



```

//*****
// EFI_DHCP6_HEADER
//*****
#pragma pack(1)
typedef struct{
  UINT32    TransactionId:24;
  UINT32    MessageType:8;
} EFI_DHCP6_HEADER;
#pragma pack()

```

*TransactionId*

The DHCPv6 transaction ID.

*MessageType*

The DHCPv6 message type.

**EFI\_DHCP6\_HEADER** defines the format of the DHCPv6 header. See RFC 3315 for more information.

## Status Codes Returned

EFI_SUCCESS	The mode data was returned.
EFI_ACCESS_DENIED	The EFI DHCPv6 Protocol instance has not been configured when <i>Dhcp6ConfigData</i> is not <b>NULL</b> .
EFI_INVALID_PARAMETER	One or more following conditions are <b>TRUE</b> : <ul style="list-style-type: none"> <li>• <i>This</i> is <b>NULL</b>.</li> <li>• Both <i>Dhcp6ConfigData</i> and <i>Dhcp6ModeData</i> are <b>NULL</b>.</li> </ul>

## EFI\_DHCP6\_PROTOCOL.Configure ()

### Summary

Initialize or clean up the configuration data for the EFI DHCPv6 Protocol instance.

### Prototype

```
typedef
EFI_STATUS
(EFIAPI *EFI_DHCP6_CONFIGURE) (
    IN EFI_DHCP6_PROTOCOL *This,
    IN EFI_DHCP6_CONFIG_DATA *Dhcp6CfgData OPTIONAL
);
```

### Parameters

*This*

Pointer to the **EFI\_DHCP6\_PROTOCOL** instance.

*Dhcp6CfgData*

Pointer to the DHCPv6 configuration data structure. Type **EFI\_DHCP6\_CONFIG\_DATA** is defined in “Related Definitions” below.

### Description

The **Configure()** function is used to initialize or clean up the configuration data of the EFI DHCPv6 Protocol instance.

- When *Dhcp6CfgData* is not **NULL** and **Configure()** is called successfully, the configuration data will be initialized in the EFI DHCPv6 Protocol instance and the state of the configured IA will be transferred into *Dhcp6Init*.
- When *Dhcp6CfgData* is **NULL** and **Configure()** is called successfully, the configuration data will be cleaned up and no IA will be associated with the EFI DHCPv6 Protocol instance.

To update the configuration data for an EFI DHCPv6 Protocol instance, the original data must be cleaned up before setting the new configuration data.

## Related Definitions

```

//*****
// EFI_DHCP6_CONFIG_DATA
//*****
typedef struct {
EFI_DHCP6_CALLBACK  Dhcp6Callback;
VOID                *CallbackContext;
UINT32              OptionCount;
EFI_DHCP6_PACKET_OPTION **OptionList;
EFI_DHCP6_IA_DESCRIPTOR IaDescriptor;
EFI_EVENT           IaInfoEvent;
BOOLEAN             ReconfigureAccept;
BOOLEAN             RapidCommit;
EFI_DHCP6_RETRANSMISSION *SolicitRetransmission;
} EFI_DHCP6_CONFIG_DATA;

```

### *Dhcp6Callback*

The callback function is to intercept various events that occur in the DHCPv6 S.A.R.R process. Set to **NULL** to ignore all those events. Type **EFI\_DHCP6\_CALLBACK** is defined below.

### *CallbackContext*

Pointer to the context that will be passed to *Dhcp6Callback*.

### *OptionCount*

Number of the DHCPv6 options in the *OptionList*.

### *OptionList*

List of the DHCPv6 options to be included in Solicit and Request packet. The buffer can be freed after **EFI\_DHCP6\_PROTOCOL.Configure()** returns. Ignored if *OptionCount* is zero. *OptionList* should not contain Client Identifier option and any IA option, which will be appended by EFI DHCPv6 Protocol instance automatically. Type **EFI\_DHCP6\_PACKET\_OPTION** is defined below.

### *IaDescriptor*

The descriptor for the IA of the EFI DHCPv6 Protocol instance. Type **EFI\_DHCP6\_IA\_DESCRIPTOR** is defined below.

### *IaInfoEvent*

If not **NULL**, the event will be signaled when any IPv6 address information of the configured IA is updated, including IPv6 address, preferred lifetime and valid lifetime, or the DHCPv6 S.A.R.R process fails. Otherwise, **Start()**, **renewrebind()**, **decline()**, **release()** and **stop()** will be blocking operations, and they will wait for the exchange process completion or failure.

*ReconfigureAccept*

If **TRUE**, the EFI DHCPv6 Protocol instance is willing to accept Reconfigure packet. Otherwise, it will ignore it. Reconfigure Accept option can not be specified through *OptionList* parameter.

*RapidCommit*

If **TRUE**, the EFI DHCPv6 Protocol instance will send Solicit packet with Rapid Commit option. Otherwise, Rapid Commit option will not be included in Solicit packet. Rapid Commit option can not be specified through *OptionList* parameter.

*SolicitRetransmission*

Parameter to control Solicit packet retransmission behavior. Type **EFI\_DHCP6\_RETRANSMISSION** is defined in “Related Definition” below. The buffer can be freed after **EFI\_DHCP6\_PROTOCOL.Configure()** returns.

```

//*****
// EFI_DHCP6_CALLBACK
//*****
typedef EFI_STATUS (EFI_API *EFI_DHCP6_CALLBACK)(
  IN EFI_DHCP6_PROTOCOL          *This,
  IN VOID          *Context,
  IN EFI_DHCP6_STATE   CurrentState,
  IN EFI_DHCP6_EVENT   Dhcp6Event,
  IN EFI_DHCP6_PACKET  *Packet,
  OUT EFI_DHCP6_PACKET **NewPacket OPTIONAL
);

```

*This*

Pointer to the **EFI\_DHCP6\_PROTOCOL** instance that is used to configure this callback function.

*Context*

Pointer to the context that is initialized by **EFI\_DHCP6\_PROTOCOL.Configure()**.

*CurrentState*

The current state of the configured IA. Type **EFI\_DHCP6\_STATE** is defined in **EFI\_DHCP6\_PROTOCOL.GetModeData()**.

*Dhcp6Event*

The event that occurs in the current state, which usually means a state transition. Type **EFI\_DHCP6\_EVENT** is defined below.

*Packet*

Pointer to the DHCPv6 packet that is about to be sent or has been received. The EFI DHCPv6 Protocol instance is responsible for freeing the buffer. Type **EFI\_DHCP6\_PACKET** is defined in **EFI\_DHCP6\_PROTOCOL.GetModeData()**.

*NewPacket*

Pointer to the new DHCPv6 packet to overwrite the *Packet*. *NewPacket* can not share the buffer with **Packet**. If *\*NewPacket* is not **NULL**, the EFI DHCPv6 Protocol instance is responsible for freeing the buffer.

**EFI\_DHCP6\_CALLBACK** is provided by the consumer of the EFI DHCPv6 Protocol instance to intercept events that occurs in the DHCPv6 S.A.R.R process. There are two possible returned values, which are described in the following table.

**Table 197. Callback Return Values**

EFI_SUCCESS	Tell the EFI DHCPv6 Protocol instance to continue the DHCPv6 S.A.R.R process.
EFI_ABORTED	Tell the EFI DHCPv6 Protocol instance to abort the DHCPv6 S.A.R.R process, and the state of the configured IA will be transferred to <i>Dhcp6Init</i> .

```

//*****
// EFI_DHCP6_PACKET_OPTION
//*****
#pragma pack(1)
typedef struct {
    UINT16    OpCode;
    UINT16    OpLen;
    UINT8     Data[1];
} EFI_DHCP6_PACKET_OPTION;
#pragma pack()

```

*OpCode*

The DHCPv6 option code, stored in network order.

*OpLen*

Length of the DHCPv6 option data, stored in network order. From the first byte to the last byte of the **Data** field.

*Data*

The data for the DHCPv6 option.

**EFI\_DHCP6\_PACKET\_OPTION** defines the format of the DHCPv6 option, stored in network order. See RFC 3315 for more information. This data structure is used to reference option data that is packed in the DHCPv6 packet.

```

//*****
// EFI_DHCP6_EVENT
//*****
typedef enum {
  Dhcp6SendSolicit = 0x0,
  Dhcp6RcvdAdvertise = 0x1,
  Dhcp6SelectAdvertise = 0x2,
  Dhcp6SendRequest = 0x3,
  Dhcp6RcvdReply = 0x4,
  Dhcp6RcvdReconfigure = 0x5,
  Dhcp6SendDecline = 0x6,
  Dhcp6SendConfirm = 0x7,
  Dhcp6SendRelease = 0x8,
  Dhcp6SendRenew = 0x9,
  Dhcp6SendRebind = 0xa
} EFI_DHCP6_EVENT;

```

#### *Dhcp6SendSolicit*

A Solicit packet is about to be sent. The packet is passed to *Dhcp6Callback* and can be modified or replaced in *Dhcp6Callback*.

#### *Dhcp6RcvdAdvertise*

An Advertise packet is received and will be passed to *Dhcp6Callback*.

#### *Dhcp6SelectAdvertise*

It is time for *Dhcp6Callback* to determine whether select the default Advertise packet by RFC 3315 policy, or overwrite it by specific user policy.

#### *Dhcp6SendRequest*

A Request packet is about to be sent. The packet is passed to *Dhcp6Callback* and can be modified or replaced in *Dhcp6Callback*.

#### *Dhcp6RcvdReply*

A Reply packet is received and will be passed to *Dhcp6Callback*.

#### *Dhcp6RcvdReconfigure*

A Reconfigure packet is received and will be passed to *Dhcp6Callback*.

#### *Dhcp6SendDecline*

A Decline packet is about to be sent. The packet is passed to *Dhcp6Callback* and can be modified or replaced in *Dhcp6Callback*.

#### *Dhcp6SendConfirm*

A Confirm packet is about to be sent. The packet is passed to *Dhcp6Callback* and can be modified or replaced in *Dhcp6Callback*.

#### *Dhcp6SendRelease*

A Release packet is about to be sent. The packet is passed to *Dhcp6Callback* and can be modified or replaced in *Dhcp6Callback*.

*Dhcp6SendRenew*

A Renew packet is about to be sent. The packet is passed to *Dhcp6Callback* and can be modified or replaced in *Dhcp6Callback*.

*Dhcp6SendRebind*

A Rebind packet is about to be sent. The packet is passed to *Dhcp6Callback* and can be modified or replaced in *Dhcp6Callback*.

```

//*****
// EFI_DHCP6_RETRANSMISSION
//*****
typedef struct {
  UINT32  Irt;
  UINT32  Mrc;
  UINT32  Mrt;
  UINT32  Mrd;
} EFI_DHCP6_RETRANSMISSION;

```

*Irt*

Initial retransmission timeout.

*Mrc*

Maximum retransmission count for one packet. If *Mrc* is zero, there's no upper limit for retransmission count.

*Mrt*

Maximum retransmission timeout for each retry. It's the upper bound of the number of retransmission timeout. If *Mrt* is zero, there is no upper limit for retransmission timeout.

*Mrd*

Maximum retransmission duration for one packet. It's the upper bound of the numbers the client may retransmit a message. If *Mrd* is zero, there's no upper limit for retransmission duration.

**Status Codes Returned**

EFI_SUCCESS	The mode data was returned.
-------------	-----------------------------

EFI_INVALID_PARAMETER	<p>One or more following conditions are <b>TRUE</b></p> <ul style="list-style-type: none"> <li>• This is <b>NULL</b>.</li> <li>• <i>OptionCount</i> &gt; 0 and <i>optionList</i> is <b>NULL</b>.</li> <li>• <i>OptionList</i> is not <b>NULL</b>, and Client Id option, Reconfigure Accept option, Rapid Commit option or any IA option is specified in the <i>OptionList</i>.</li> <li>• <i>laDescriptor.Type</i> is neither <b>EFI_DHCP6_IA_TYPE_NA</b> nor <b>EFI_DHCP6_IA_TYPE_NA</b>.</li> <li>• <i>laDescriptor</i> is not unique.</li> <li>• Both <i>laInfoEvent</i> and <i>SolicitRetransmission</i> are <b>NULL</b>.</li> <li>• <i>SolicitRetransmission</i> is not <b>NULL</b>, and both <i>SolicitRetransmission-&gt;Mrc</i> and <i>SolicitRetransmission-&gt;Mrd</i> are zero.</li> </ul>
EFI_ACCESS_DENIED	<p>The EFI DHCPv6 Protocol instance has been already configured when <i>Dhcp6CfgData</i> is not <b>NULL</b>. The EFI DHCPv6 Protocol instance has already started the DHCPv6 S.A.R.R when <i>Dhcp6CfgData</i> is <b>NULL</b>.</p>
EFI_OUT_OF_RESOURCES	<p>Required system resources could not be allocated.</p>
EFI_DEVICE_ERROR	<p>An unexpected system or network error occurred.</p>



## EFI\_DHCP6\_PROTOCOL.Start ()

### Summary

Start the DHCPv6 S.A.R.R process.

### Prototype

```
typedef
EFI_STATUS
(EFIAPI *EFI_DHCP6_START) (
    IN EFI_DHCP6_PROTOCOL *This
);
```

### Parameters

*This*

Pointer to the **EFI\_DHCP6\_PROTOCOL** instance.

### Description

The **Start()** function starts the DHCPv6 S.A.R.R process. This function can be called only when the state of the configured IA is in the *Dhcp6Init* state. If the DHCPv6 S.A.R.R process completes successfully, the state of the configured IA will be transferred through *Dhcp6Selecting* and *Dhcp6Requesting* to *Dhcp6Bound* state. The update of the IPv6 addresses will be notified through **EFI\_DHCP6\_CONFIG\_DATA.IaInfoEvent**. At the time when each event occurs in this process, the callback function set by **EFI\_DHCP6\_PROTOCOL.Configure()** will be called and the user can take this opportunity to control the process. If **EFI\_DHCP6\_CONFIG\_DATA.IaInfoEvent** is **NULL**, the **Start()** function call is a blocking operation. It will return after the DHCPv6 S.A.R.R process completes or aborted by users. If the process is aborted by system or network error, the state of the configured IA will be transferred to *Dhcp6Init*. The **Start()** function can be called again to restart the process.

### Status Codes Returned

EFI_SUCCESS	The DHCPv6 S.A.R.R process is completed and at least one IPv6 address has been bound to the configured IA when <b>EFI_DHCP6_CONFIG_DATA.IaInfoEvent</b> is <b>NULL</b> . The DHCPv6 S.A.R.R process is started when <b>EFI_DHCP6_CONFIG_DATA.IaInfoEvent</b> is not <b>NULL</b> .
EFI_ACCESS_DENIED	The EFI DHCPv6 Child instance hasn't been configured.
EFI_INVALID_PARAMETER	<i>This</i> is <b>NULL</b> .
EFI_OUT_OF_RESOURCES	Required system resources could not be allocated.
EFI_ALREADY_STARTED	The DHCPv6 S.A.R.R process has already started.
EFI_DEVICE_ERROR	An unexpected network or system error occurred.
EFI_NO_RESPONSE	The DHCPv6 S.A.R.R process failed because of no response.

EFI_NO_MAPPING	No IPv6 address has been bound to the configured IA after the DHCPv6 S.A.R.R process.
EFI_ABORTED	The DHCPv6 S.A.R.R process aborted by user.
EFI_NO_MEDIA	There was a media error.

## EFI\_DHCP6\_PROTOCOL.InfoRequest ()

### Summary

Request configuration information without the assignment of any IA addresses of the client.

### Prototype

```

Typedef
EFI_STATUS
(EFIAPI *EFI_DHCP6_INFO_REQUEST) (
IN EFI_DHCP6_PROTOCOL *This,
IN BOOLEAN SendClientId,
IN EFI_DHCP6_PACKET_OPTION *OptionRequest,
IN UINT32 OptionCount,
IN EFI_DHCP6_PACKET_OPTION *OptionList[] OPTIONAL,
IN EFI_DHCP6_RETRANSMISSION *Retransmission,
IN EFI_EVENT TimeoutEvent OPTIONAL,
IN EFI_DHCP6_INFO_CALLBACK ReplyCallback,
IN VOID *CallbackContext OPTIONAL
);

```

### Parameters

*This*

Pointer to the **EFI\_DHCP6\_PROTOCOL** instance.

*SendClientId*

If **TRUE**, the EFI DHCPv6 Protocol instance will build Client Identifier option and include it into Information Request packet. If **FALSE**, Client Identifier option will not be included. Client Identifier option can not be specified through *OptionList* parameter.

*OptionRequest*

Pointer to the Option Request option in the Information Request packet. Option Request option can not be specified through *OptionList* parameter.

*OptionCount*

Number of options in *OptionList*.

*OptionList*

List of other DHCPv6 options. These options will be appended to the Option Request option. The caller is responsible for freeing this buffer. Type is defined in **EFI\_DHCP6\_PROTOCOL.GetModeData()**.

*Retransmission*

Parameter to control Information Request packet retransmission behavior. Type **EFI\_DHCP6\_RETRANSMISSION** is defined in "Related Definition" below. The buffer can be freed after **EFI\_DHCP6\_PROTOCOL.InfoRequest()** returns.

*TimeoutEvent*

If not **NULL**, this event is signaled when the information request exchange aborted because of no response. If **NULL**, the function call is a blocking operation; and it will return after the information-request exchange process finish or aborted by users.

*ReplyCallback*

The callback function is to intercept various events that occur in the Information Request exchange process. It should not be set to **NULL**. Type **EFI\_DHCP6\_INFO\_CALLBACK** is defined below.

*CallbackContext*

Pointer to the context that will be passed to *ReplyCallback*.

**Description**

The **InfoRequest()** function is used to request configuration information without the assignment of any IPv6 address of the client. Client sends out Information Request packet to obtain the required configuration information, and DHCPv6 server responds with Reply packet containing the information for the client. The received Reply packet will be passed to the user by *ReplyCallback* function. If user returns **EFI\_NOT\_READY** from *ReplyCallback*, the EFI DHCPv6 Protocol instance will continue to receive other Reply packets unless timeout according to the *Retransmission* parameter. Otherwise, the Information Request exchange process will be finished successfully if user returns **EFI\_SUCCESS** from *ReplyCallback*.

**Related Definitions**

```

//*****
// EFI_DHCP6_CALLBACK
//*****
typedef EFI_STATUS (EFI_API *EFI_DHCP6_INFO_CALLBACK)(
    IN EFI_DHCP6_PROTOCOL *This,
    IN VOID *Context,
    IN EFI_DHCP6_PACKET *Packet,
);

```

*This*

Pointer to the **EFI\_DHCP6\_PROTOCOL** instance that is used to configure this callback function.

*Context*

Pointer to the context that is initialized in the **EFI\_DHCP6\_PROTOCOL.InfoRequest()**.

*Packet*

Pointer to Reply packet that has been received. The EFI DHCPv6 Protocol instance is responsible for freeing the buffer. Type **EFI\_DHCP6\_PACKET** is defined in **EFI\_DHCP6\_PROTOCOL.GetModeData()**.

**EFI\_DHCP6\_INFO\_CALLBACK** is provided by the consumer of the EFI DHCPv6 Protocol instance to intercept events that occurs in the DHCPv6 Information Request exchange process. There are three possible returned values, which are described in the following table.

EFI_SUCCESS	Tell the EFI DHCPv6 Protocol instance to finish Information Request exchange process.
EFI_NOT_READY	Tell the EFI DHCPv6 Protocol instance to continue Information Request exchange process.
EFI_ABORTED	Tell the EFI DHCPv6 Protocol instance to abort the Information Request exchange process

### Status Codes Returned

EFI_SUCCESS	The DHCPv6 information request exchange process completed when <i>TimeoutEvent</i> is <b>NULL</b> . Information Request packet has been sent to DHCPv6 server when <i>TimeoutEvent</i> is not <b>NULL</b> .
EFI_INVALID_PARAMETER	One or more following conditions are <b>TRUE</b> : <ul style="list-style-type: none"> <li>• <i>This</i> is <b>NULL</b>.</li> <li>• <i>OptionRequest</i> is <b>NULL</b> or <i>OptionRequest-&gt;OpCode</i> is invalid.</li> <li>• <i>OptionCount</i> &gt; 0 and <i>OptionList</i> is <b>NULL</b>.</li> <li>• <i>OptionList</i> is not <b>NULL</b>, and Client Identify option or Option Request option is specified in the <i>OptionList</i>.</li> <li>• <i>Retransmission</i> is <b>NULL</b>.</li> <li>• Both <i>Retransmission-&gt;Mrc</i> and <i>Retransmission-&gt;Mrd</i> are zero.</li> <li>• <i>ReplyCallback</i> is <b>NULL</b>.</li> </ul>
EFI_DEVICE_ERROR	An unexpected network or system error occurred.
EFI_NO_RESPONSE	The DHCPv6 information request exchange process failed because of no response, or not all requested-options are responded by DHCPv6 servers when Timeout happened.
EFI_ABORTED	The DHCPv6 information request exchange process aborted by user.

## EFI\_DHCP6\_PROTOCOL.RenewRebind ()

### Summary

Manually extend the valid and preferred lifetimes for the IPv6 addresses of the configured IA and update other configuration parameters by sending Renew or Rebind packet.

### Prototype

```
typedef
EFI_STATUS
(EFI_API *EFI_DHCP6_RENEW_REBIND) (
  IN EFI_DHCP6_PROTOCOL *This,
  IN BOOLEAN      RebindRequest
);
```

### Parameters

*This*

Pointer to the **EFI\_DHCP6\_PROTOCOL** instance.

*RebindRequest*

If **TRUE**, it will send Rebind packet and enter the *Dhcp6Rebinding* state. Otherwise, it will send Renew packet and enter the *Dhcp6Renewing* state.

### Description

The **RenewRebind()** function is used to manually extend the valid and preferred lifetimes for the IPv6 addresses of the configured IA and update other configuration parameters by sending Renew or Rebind packet.

- When *RebindRequest* is **FALSE** and the state of the configured IA is *Dhcp6Bound*, it will send Renew packet to the previously DHCPv6 server and transfer the state of the configured IA to *Dhcp6Renewing*. If valid Reply packet received, the state transfers to *Dhcp6Bound* and the valid and preferred timer restarts. If fails, the state transfers to *Dhcp6Bound* but the timer continues.
- When *RebindRequest* is **TRUE** and the state of the configured IA is *Dhcp6Bound*, it will send Rebind packet. If valid Reply packet received, the state transfers to *Dhcp6Bound* and the valid and preferred timer restarts. If fails, the state transfers to *Dhcp6Init* and the IA can't be used.

## Status Codes Returned

EFI_SUCCESS	The DHCPv6 renew/rebind exchange process has completed and at least one IPv6 address of the configured IA has been bound again when <b>EFI_DHCP6_CONFIG_DATA.IaInfoEvent</b> is <b>NULL</b> . The EFI DHCPv6 Protocol instance has sent Renew or Rebind packet when <b>EFI_DHCP6_CONFIG_DATA.IaInfoEvent</b> is not <b>NULL</b> .
EFI_ACCESS_DENIED	The EFI DHCPv6 Child instance hasn't been configured, or the state of the configured IA is not in <i>Dhcp6Bound</i> .
EFI_ALREADY_STARTED	The state of the configured IA has already entered <i>Dhcp6Renewing</i> when <i>RebindRequest</i> is <b>FALSE</b> . The state of the configured IA has already entered <i>Dhcp6Rebinding</i> when <i>RebindRequest</i> is <b>TRUE</b> .
EFI_INVALID_PARAMETER	<i>This</i> is <b>NULL</b> .
EFI_DEVICE_ERROR	An unexpected network or system error occurred.
EFI_NO_RESPONSE	The DHCPv6 renew/rebind exchange process failed because of no response.
EFI_NO_MAPPING	No IPv6 address has been bound to the configured IA after the DHCPv6 renew/rebind exchange process.
EFI_ABORTED	The DHCPv6 renew/rebind exchange process aborted by user.

## EFI\_DHCP6\_PROTOCOL.Decline ()

### Summary

Inform that one or more IPv6 addresses assigned by a server are already in use by another node.

### Prototype

```
typedef
EFI_STATUS
(EFIAPI *EFI_DHCP6_DECLINE) (
  IN EFI_DHCP6_PROTOCOL *This,
  IN UINT32      AddressCount,
  IN EFI_IPv6_ADDRESS *Addresses
);
```

### Parameters

*This*

Pointer to the **EFI\_DHCP6\_PROTOCOL** instance.

*AddressCount*

Number of declining IPv6 addresses.

*Addresses*

Pointer to the buffer stored all the declining IPv6 addresses.

### Description

The **Decline()** function is used to manually decline the assignment of IPv6 addresses, which have been already used by another node. If all IPv6 addresses of the configured IA are declined through this function, the state of the IA will switch through *Dhcp6Declining* to *Dhcp6Init*, otherwise, the state of the IA will restore to *Dhcp6Bound* after the declining process. The **Decline()** can only be called when the IA is in *Dhcp6Bound* state. If the **EFI\_DHCP6\_CONFIG\_DATA.IaInfoEvent** is **NULL**, this function is a blocking operation. It will return after the declining process finishes, or aborted by user.

### Status Codes Returned

EFI_SUCCESS	The DHCPv6 decline exchange process has completed when <b>EFI_DHCP6_CONFIG_DATA.IaInfoEvent</b> is <b>NULL</b> . The EFI DHCPv6 Protocol instance has sent Decline packet when <b>EFI_DHCP6_CONFIG_DATA.IaInfoEvent</b> is not <b>NULL</b> .
EFI_INVALID_PARAMETER	One or more following conditions are <b>TRUE</b> <ul style="list-style-type: none"> <li>• <i>This</i> is <b>NULL</b>.</li> <li>• <i>AddressCount</i> is zero or <i>Addresses</i> is <b>NULL</b>.</li> </ul>
EFI_NOT_FOUND	Any specified IPv6 address is not correlated with the configured IA for this instance.



EFI_ACCESS_DENIED	The EFI DHCPv6 Child instance hasn't been configured, or the state of the configured IA is not in <i>Dhcp6Bound</i> .
EFI_DEVICE_ERROR	An unexpected network or system error occurred.
EFI_ABORTED	The DHCPv6 decline exchange process aborted by user.

## EFI\_DHCP6\_PROTOCOL.Release ()

### Summary

Release one or more IPv6 addresses associated with the configured IA for current instance.

### Prototype

```
typedef
EFI_STATUS
(EFIAPI *EFI_DHCP6_RELEASE) (
  IN EFI_DHCP6_PROTOCOL *This,
  IN UINT32      AddressCount,
  IN EFI_IPv6_ADDRESS *Addresses
);
```

### Parameters

*This*

Pointer to the **EFI\_DHCP6\_PROTOCOL** instance.

*AddressCount*

Number of releasing IPv6 addresses.

*Addresses*

Pointer to the buffer stored all the releasing IPv6 addresses. Ignored if *AddressCount* is zero.

### Description

The **Release()** function is used to manually release the one or more IPv6 address. If *AddressCount* is zero, it will release all IPv6 addresses of the configured IA. If all IPv6 addresses of the IA are released through this function, the state of the IA will switch through *Dhcp6Releasing* to *Dhcp6Init*, otherwise, the state of the IA will restore to *Dhcp6Bound* after the releasing process. The **Release()** can only be called when the IA is in *Dhcp6Bound* state. If the **EFI\_DHCP6\_CONFIG\_DATA.IaInfoEvent** is **NULL**, the function is a blocking operation. It will return after the releasing process finishes, or aborted by user.

### Status Codes Returned

EFI_SUCCESS	The DHCPv6 release exchange process has completed when <b>EFI_DHCP6_CONFIG_DATA.IaInfoEvent</b> is <b>NULL</b> . The EFI DHCPv6 Protocol instance has sent Release packet when <b>EFI_DHCP6_CONFIG_DATA.IaInfoEvent</b> is not <b>NULL</b> .
EFI_INVALID_PARAMETER	One or more following conditions are <b>TRUE</b> <ul style="list-style-type: none"> <li>• <i>This</i> is <b>NULL</b>.</li> <li>• <i>AddressCount</i> is not zero and <i>Addresses</i> is <b>NULL</b>.</li> </ul>

EFI_NOT_FOUND	Any specified IPv6 address is not correlated with the configured IA for this instance.
EFI_ACCESS_DENIED	The EFI DHCPv6 Child instance hasn't been configured, or the state of the configured IA is not in <i>Dhcp6Bound</i> .
EFI_DEVICE_ERROR	An unexpected network or system error occurred.
EFI_ABORTED	The DHCPv6 release exchange process aborted by user.

## EFI\_DHCP6\_PROTOCOL.Stop ()

### Summary

Stop the DHCPv6 S.A.R.R process.

### Prototype

```
typedef
EFI_STATUS
(EFIAPI *EFI_DHCP6_STOP) (
    IN EFI_DHCP6_PROTOCOL *This
);
```

### Parameters

*This*

Pointer to the **EFI\_DHCP6\_PROTOCOL** instance.

### Description

The **Stop()** function is used to stop the DHCPv6 S.A.R.R process. If this function is called successfully, all the IPv6 addresses of the configured IA will be released and the state of the configured IA will be transferred to *Dhcp6Init*.

### Status Codes Returned

EFI_SUCCESS	The DHCPv6 S.A.R.R process has been stopped when <b>EFI_DHCP6_CONFIG_DATA.IaInfoEvent</b> is <b>NULL</b> . The EFI DHCPv6 Protocol instance has sent Release packet if need release or has been stopped if needn't, when <b>EFI_DHCP6_CONFIG_DATA.IaInfoEvent</b> is not <b>NULL</b> .
EFI_INVALID_PARAMETER	<i>This</i> is <b>NULL</b> .
EFI_NO_MEDIA	There was a media error.

## EFI\_DHCP6\_PROTOCOL.Parse ()

### Summary

Parse the option data in the DHCPv6 packet.

### Prototype

```
typedef
EFI_STATUS
(EFI_API *EFI_DHCP6_PARSE) (
    IN EFI_DHCP6_PROTOCOL  *This,
    IN EFI_DHCP6_PACKET    *Packet,
    IN OUT UINT32          *OptionCount,
    IN EFI_DHCP6_PACKET_OPTION *PacketOptionList[] OPTIONAL
);
```

### Parameters

*This*

Pointer to the **EFI\_DHCP6\_PROTOCOL** instance.

*Packet*

\Pointer to packet to be parsed. Type **EFI\_DHCP6\_PACKET** is defined in **EFI\_DHCP6\_PROTOCOL.GetModeData()**.

*OptionCount*

On input, the number of entries in the **PacketOptionList**. On output, the number of DHCPv6 options in the **Packet**.

*PacketOptionList*

List of pointers to the DHCPv6 options in the **Packet**. Type **EFI\_DHCP6\_PACKET\_OPTION** is defined in **EFI\_DHCP6\_PROTOCOL.Configure()**. The *OpCode* and *OpLen* in **EFI\_DHCP6\_PACKET\_OPTION** are both stored in network byte order.

### Description

The **Parse()** function is used to retrieve the option list in the DHCPv6 packet.

## Status Codes Returned

EFI_SUCCESS	The packet was successfully parsed.
EFI_INVALID_PARAMETER	One or more following conditions are <b>TRUE</b> <ul style="list-style-type: none"> <li>• <i>This</i> is <b>NULL</b>.</li> <li>• <i>Packet</i> is <b>NULL</b>.</li> <li>• <i>Packet</i> is not a well-formed DHCPv6 packet.</li> <li>• <i>OptionCount</i> is <b>NULL</b>.</li> <li>• <i>*OptionCount</i> is not zero and <i>PacketOptionList</i> is <b>NULL</b>.</li> </ul>
EFI_BUFFER_TOO_SMALL	<i>*OptionCount</i> is smaller than the number of options that were found in the <i>Packet</i> .

## 29.4 EFI DNSv4 Protocol

This section defines the EFI Domain Name Service Binding Protocol interface. It is split into the following two main sections.

- DNSv4 Service Binding Protocol (DNSv4SB)
- DNSv4 Protocol (DNSv4)

### EFI\_DNS4\_SERVICE\_BINDING\_PROTOCOL

#### Summary

The DNSv4SB is used to locate communication devices that are supported by a DNS driver and to create and destroy instances of the DNS child protocol driver.

The EFI Service Binding Protocol in [Section 2.5.8](#) defines the generic Service Binding Protocol functions. This section discusses the details that are specific to the DNSv4.

#### GUID

```
#define EFI_DNS4_SERVICE_BINDING_PROTOCOL_GUID \
{ 0xb625b186, 0xe063, 0x44f7, \
  { 0x89, 0x5, 0x6a, 0x74, 0xdc, 0x6f, 0x52, 0xb4}}
```

#### Description

A network application (or driver) that requires network address resolution can use one of the protocol handler services, such as **BS->LocateHandleBuffer()**, to search for devices that publish a DNSV4SB GUID. Each device with a published DNSV4SB GUID supports DNS and may be available for use.

After a successful call to the **EFI\_DNS4\_SERVICE\_BINDING\_PROTOCOL.CreateChild()** function, the child DNS driver instance is in an unconfigured state; it is not ready to resolve addresses.

Before a network application terminates execution, every successful call to the **EFI\_DNS4\_SERVICE\_BINDING\_PROTOCOL.CreateChild()** function must be matched with a call to the **EFI\_DNS4\_SERVICE\_BINDING\_PROTOCOL.DestroyChild()** function.

**Note:** All the network addresses that are described in **EFI\_DNS4\_PROTOCOL** are stored in network byte order. Both incoming and outgoing DNS packets are also in network byte order. All other parameters that are defined in functions or data structures are stored in host byte order.

## EFI\_DNS4\_PROTOCOL

### Summary

This protocol provides the function to get the host name and address mapping, also provides pass through interface to retrieve arbitrary information from DNS.

The EFI\_DNS4\_Protocol is primarily intended to retrieve host addresses using the standard DNS protocol (RFC1035), and support for this protocol is required.

Implementations may optionally also support local network name resolution methods such as LLMNR (RFC4795) however DNS queries shall always take precedence, and any use of local network name protocols would be restricted to cases where resolution using DNS protocol fails.

As stated above, all instances of EFI\_DNS4\_Protocol will utilize a common DNS cache containing the successful results of previous queries on any interface. However, it should be noted that every instance of EFI\_DNS4\_Protocol is associated with a specific network device or interface, and that all network actions initiated using a specific instance of the DNS protocol will occur only via use of the associated network interface. This means, in a system with multiple network interfaces, that a specific DNS server will often only be reachable using a specific network instance, and therefore the protocol user will need to take steps to insure the DNS instance associated with the proper network interface is used. Or alternatively, the caller may perform DNS functions against all interfaces until successful result is achieved.

### GUID

```
#define EFI_DNS4_PROTOCOL_GUID \
{ 0xae3d28cc, 0xe05b, 0x4fa1, \
  {0xa0, 0x11, 0x7e, 0xb5, 0x5a, 0x3f, 0x14, 0x1 } }
```

### Protocol Interface Structure

```
typedef struct _EFI_DNS4_PROTOCOL {
  EFI_DNS4_GET_MODE_DATA    GetModeData;
  EFI_DNS4_CONFIGURE        Configure;
  EFI_DNS4_HOST_NAME_TO_IP  HostNameToIp;
  EFI_DNS4_IP_TO_HOST_NAME  IpToHostName;
  EFI_DNS4_GENERAL_LOOKUP   GeneralLookUp;
  EFI_DNS4_UPDATE_DNS_CACHE UpdateDnsCache;
  EFI_DNS4_POLL             Poll;
  EFI_DNS4_CANCEL           Cancel;
} EFI_DNS4_PROTOCOL;
```

## EFI\_DNS4\_PROTOCOL.GetModeData()

### Summary

Retrieve the current mode data of this DNS instance.

### Prototype

```
typedef
EFI_STATUS
(EFI_API *EFI_DNS4_GET_MODE_DATA)(
IN EFI_DNS4_PROTOCOL *This,
OUT EFI_DNS4_MODE_DATA *DnsModeData
);
```

### Description

This function is used to retrieve DNS mode data for this DNS instance.

### Parameter

<i>This</i>	Pointer to <b>EFI_DNS4_PROTOCOL</b> instance.
<i>DnsModeData</i>	Pointer to the caller-allocated storage for the <b>EFI_DNS4_MODE_DATA</b> structure.

### Related Definitions

```
//*****
// EFI_DNS4_MODE_DATA
//*****
typedef struct {
EFI_DNS4_CONFIG_DATA DnsConfigData;
UINT32 DnsServerCount;
EFI_IPv4_ADDRESS *DnsServerList;
UINT32 DnsCacheCount;
EFI_DNS4_CACHE_ENTRY *DnsCacheList;
} EFI_DNS4_MODE_DATA;
```

*DnsConfigData* The current configuration data of this instance. Type **EFI\_DNS4\_CONFIG\_DATA** is defined below.

*DnsServerCount* Number of configured DNS servers.

*DnsServerList* Pointer to common list of addresses of all configured DNS server used by **EFI\_DNS4\_PROTOCOL** instances. List will include DNS servers configured by this or any other **EFI\_DNS4\_PROTOCOL** instance. The storage for this list is allocated by the driver publishing this protocol, and must be freed by the caller.

*DnsCacheCount* Number of DNS Cache entries. The DNS Cache is shared among all DNS instances.



*DnsCacheList* Pointer to a buffer containing *DnsCacheCount* DNS Cache entry structures. The storage for this list is allocated by the driver publishing this protocol and must be freed by caller.

```

//*****
// EFI_DNS4_CONFIG_DATA
//*****
typedef struct {
    UINTN    DnsServerListCount;
    EFI_IPv4_ADDRESS *DnsServerList;
    BOOLEAN  UseDefaultSetting;
    BOOLEAN  EnableDnsCache;
    UINT8    Protocol;
    EFI_IPv4_ADDRESS StationIp;
    EFI_IPv4_ADDRESS SubnetMask;
    UINT16   LocalPort;
    UINT32   RetryCount;
    UINT32   RetryInterval;
} EFI_DNS4_CONFIG_DATA;

```

*DnsServerListCount* Count of the DNS servers. When used with **GetModeData()**, this field is the count of originally configured servers when **Configure()** was called for this instance. When used with **Configure()** this is the count of caller-supplied servers. If the *DnsServerListCount* is zero, the DNS server configuration will be retrieved from DHCP server automatically.

*DnsServerList* Pointer to DNS server list containing *DnsServerListCount* entries or NULL if *DnsServerListCount* is 0. For **Configure()**, this will be NULL when there are no caller-supplied server addresses, and, the DNS instance will retrieve DNS server from DHCP Server. The provided DNS server list is recommended to be filled up in the sequence of preference. When used with **GetModeData()**, the buffer containing the list will be allocated by the driver implementing this protocol and must be freed by the caller. When used with **Configure()**, the buffer containing the list will be allocated and released by the caller.

*UseDefaultSetting* Set to **TRUE** to use the default IP address/subnet mask and default routing table.

*EnableDnsCache* If **TRUE**, enable DNS cache function for this DNS instance. If **FALSE**, all DNS query will not lookup local DNS cache.

*Protocol* Use the protocol number defined in "Links to UEFI-Related Documents" (<http://uefi.org/uefi>) under the heading "IANA Protocol Numbers". Only TCP or UDP are supported, and other protocol values are invalid. An

implementation can choose to support only UDP, or both TCP and UDP.

- StationIp* If *UseDefaultSetting* is **FALSE** indicates the station address to use.
- SubnetMask* If *UseDefaultSetting* is **FALSE** indicates the subnet mask to use.
- LocalPort* Local port number. Set to zero to use the automatically assigned port number.
- RetryCount* Retry number if no response received after *RetryInterval*.
- RetryInterval* Minimum interval of retry is 2 second. If the retry interval is less than 2 second, then use the 2 second.

```

//*****
// EFI_DNS4_CACHE_ENTRY //*****
typedef struct {
    CHAR16    *HostName;
    EFI_IPv4_ADDRESS *IpAddress;
    UINT32    Timeout;
} EFI_DNS4_CACHE_ENTRY;
    
```

- HostName* Host name.
- IpAddress* IP address of this host.
- Timeout* Time in second unit that this entry will remain in DNS cache. A value of zero means that this entry is permanent. A nonzero value will override the existing one if this entry to be added is dynamic entry. Implementations may set its default timeout value for the dynamically created DNS cache entry after one DNS resolve succeeds.

### Status Codes Returned

EFI_SUCCESS	The operation completed successfully.
EFI_NOT_STARTED	When <i>DnsConfigData</i> is queried, no configuration data is available because this instance has not been configured.
EFI_INVALID_PARAMETER	<i>This</i> is <b>NULL</b> or <i>DnsModeData</i> is <b>NULL</b> .
EFI_OUT_OF_RESOURCES	Failed to allocate needed resources.

## EFI\_DNS4\_PROTOCOL.Configure()

### Summary

Configures this DNS instance.

### Prototype

```
typedef
EFI_STATUS
(EFI_API *EFI_DNS4_CONFIGURE)(
    IN EFI_DNS4_PROTOCOL *This,
    IN EFI_DNS4_CONFIG_DATA *DnsConfigData
);
```

### Descriptions

This function is used to configure DNS mode data for this DNS instance.

### Parameters

<i>This</i>	Pointer to <b>EFI_DNS4_PROTOCOL</b> instance.
<i>DnsConfigData</i>	Pointer to caller-allocated buffer containing <b>EFI_DNS4_CONFIG_DATA</b> structure containing the desired Configuration data. If NULL, the driver will reinitialize the protocol instance to the unconfigured state.

### Status Codes Returned

EFI_SUCCESS	The operation completed successfully.
EFI_UNSUPPORTED	The designated protocol is not supported.
EFI_INVALID_PARAMETER	<i>This</i> is NULL. The StationIp address provided in <i>DnsConfigData</i> is not a valid unicast. <i>DnsServerList</i> is NULL while <i>DnsServerListCount</i> is not ZERO. <i>DnsServerListCount</i> is ZERO while <i>DnsServerList</i> is not NULL.
EFI_OUT_OF_RESOURCES	The DNS instance data or required space could not be allocated.
EFI_DEVICE_ERROR	An unexpected system or network error occurred. The EFI DNSv4 Protocol instance is not configured.
EFI_ALREADY_STARTED	Second call to <b>Configure()</b> with <i>DnsConfigData</i> . To reconfigure the instance the caller must call <b>Configure()</b> with NULL first to return driver to unconfigured state.

## EFI\_DNS4\_PROTOCOL.HostNameToIp()

### Summary

Host name to host address translation.

### Prototype

```
typedef
EFI_STATUS
(EFI_API *EFI_DNS4_HOST_NAME_TO_IP) (
    IN EFI_DNS4_PROTOCOL *This,
    IN CHAR16             *HostName,
    IN EFI_DNS4_COMPLETION_TOKEN *Token
);
```

### Parameter

<i>This</i>	Pointer to <b>EFI_DNS4_PROTOCOL</b> instance.
<i>HostName</i>	Pointer to buffer containing fully-qualified Domain Name including Hostname. To resolve successfully, characters within the FQDN string must be chosen according to the format and from within the set of ASCII characters authorized by DNS specifications. Any translation required for reference to domains or hostnames defined as containing Unicode characters, for example use of Punycode, must be performed by caller.
<i>Token</i>	Pointer to the caller-allocated completion token to return at the completion of the process to translate host name to host address. Type <b>EFI_DNS4_COMPLETION_TOKEN</b> is defined in "Related Definitions" below.

## Related Definition

```

//*****
// EFI_DNS4_COMPLETION_TOKEN
//*****
typedef struct {
    EFI_EVENT    Event;
    EFI_STATUS   Status;
    UINT32       RetryCount;
    UINT32       RetryInterval;
    union {
        DNS_HOST_TO_ADDR_DATA *H2AData;
        DNS_ADDR_TO_HOST_DATA *A2HData;
        DNS_GENERAL_LOOKUP_DATA *GLookupData;
    } RspData;
} EFI_DNS4_COMPLETION_TOKEN;

```

*Event* This *Event* will be signaled after the *Status* field is updated by the EFI DNS protocol driver. The type of *Event* must be **EFI\_NOTIFY\_SIGNAL**.

*Status* Will be set to one of the following values.  
**EFI\_SUCCESS**: The host name to address translation completed successfully.  
**EFI\_NOT\_FOUND**: No matching Resource Record (RR) is found.  
**EFI\_TIMEOUT**: No DNS server reachable, or *RetryCount* was exhausted without response from all specified DNS servers.  
**EFI\_DEVICE\_ERROR**: An unexpected system or network error occurred.  
**EFI\_NO\_MEDIA**: There was a media error.

*RetryCount* Retry number if no response received after *RetryInterval*. If zero, use the parameter configured through `Dns.Configure()` interface.

*RetryInterval* Minimum interval of retry is 2 second. If the retry interval is less than 2 second, then use the 2 second. If zero, use the parameter configured through `Dns.Configure()` interface.

*H2AData* When the Token is used for host name to address translation, *H2AData* is a pointer to the **DNS\_HOST\_TO\_ADDR\_DATA**. Type **DNS\_HOST\_TO\_ADDR\_DATA** is defined below.

*A2HData* When the Token is used for host address to host name translation, *A2HData* is a pointer to the **DNS\_ADDR\_TO\_HOST\_DATA**. Type **DNS\_ADDR\_TO\_HOST\_DATA** is defined below.

*GLookupDATA* When the Token is used for a general lookup function, *GLookupDATA* is a pointer to the **DNS\_GENERAL\_LOOKUP\_DATA**. Type **DNS\_GENERAL\_LOOKUP\_DATA** is defined below.

**EFI\_DNS4\_COMPLETION\_TOKEN** structures are used for host name to address translation, host address to name translation and general lookup operation, the *Event*, *RetryCount* and *RetryInterval* fields filed must be filled by the EFI DNS4 Protocol Client. After the operation completes, the EFI DNS4 protocol driver fill in the *RspData* and *Status* field and the *Event* is signaled.

```

//*****
// DNS_HOST_TO_ADDR_DATA
//*****
typedef struct {
    UINT32      IpCount;
    EFI_IPv4_Address *IpList;
} DNS_HOST_TO_ADDR_DATA;

```

*IpCount* Number of the returned IP addresses.  
*IpList* Pointer to the all the returned IP addresses.

```

//*****
// DNS_ADDR_TO_HOST_DATA
//*****
typedef struct {
    CHAR16      *HostName;
} DNS_ADDR_TO_HOST_DATA;

```

*HostName* Pointer to the primary name for this host address. It's the caller's responsibility to free the response memory.

```

//*****
// DNS_GENERAL_LOOKUP_DATA
//*****
typedef struct {
    UINTN      RRCount;
    DNS_RESOURCE_RECORD *RRLList;
} DNS_GENERAL_LOOKUP_DATA;

```

*RRCount* Number of returned matching RRs.  
*RRLList* Pointer to the all the returned matching RRs. It's caller responsibility to free the allocated memory to hold the returned RRs.

```

//*****
// DNS_RESOURCE_RECORD
//*****
typedef struct {
  CHAR8 *QName;
  UINT16 QType;
  UINT16 QClass;
  UINT32 TTL;
  UINT16 DataLength;
  CHAR8 *RData;
} DNS_RESOURCE_RECORD;

  QName           The Owner name.
  QType           The Type Code of this RR.
  QClass          The CLASS code of this RR.
  TTL             32 bit integer which specify the time interval that the
                 resource record may be cached before the source of the
                 information should again be consulted. Zero means this
                 RR cannot be cached.

  DataLength      16 big integer which specify the length of RData.
  RData           A string of octets that describe the resource, the format of
                 this information varies according to QType and QClass
                 difference.

```

### Description

The **HostNameToIp ()** function is used to translate the host name to host IP address. A type A query is used to get the one or more IP addresses for this host.

### Status Codes Returned

EFI_SUCCESS	The operation was queued successfully.
EFI_INVALID_PARAMETER	One or more of the following conditions is TRUE <i>This</i> is <b>NULL</b> . <i>Token</i> is <b>NULL</b> . <i>Token</i> .Event is <b>NULL</b> . <i>HostName</i> is <b>NULL</b> . <i>HostName</i> string is unsupported format.
EFI_NO_MAPPING	There's no source address is available for use.
EFI_NOT_STARTED	This instance has not been started.

## EFI\_DNS4\_PROTOCOL.IpToHostName()

### Summary

IPv4 address to host name translation also known as Reverse DNS lookup.

### Prototype

```
typedef
EFI_STATUS
(EFI_API *EFI_DNS4_IP_TO_HOST_NAME) (
    IN EFI_DNS4_PROTOCOL    *This,
    IN EFI_IPv4_ADDRESS     IpAddress,
    IN EFI_DNS4_COMPLETION_TOKEN *Token
);
```

### Parameter

<i>This</i>	Pointer to <b>EFI_DNS4_PROTOCOL</b> instance.
<i>IpAddress</i>	IP address.
<i>Token</i>	Pointer to the caller-allocated completion used token to translate host address to host name. Type <b>EFI_DNS4_COMPLETION_TOKEN</b> is defined in "Related Definitions" of above <b>HostNameToIp()</b> .

### Description

The **IpToHostName ()** function is used to translate the host address to host name. A type PTR query is used to get the primary name of the host. Support of this function is optional.

### Status Codes Returned

EFI_SUCCESS	The operation was queued successfully.
EFI_UNSUPPORTED	This function is not supported
EFI_INVALID_PARAMETER	One or more of the following conditions is TRUE <i>This</i> is <b>NULL</b> . <i>Token</i> is <b>NULL</b> . <i>Token</i> .Event is <b>NULL</b> . <i>IpAddress</i> is not valid IP address.
EFI_NO_MAPPING	There's no source address is available for use.
EFI_ALREADY_STARTED	This <i>Token</i> is being used in another DNS session.
EFI_OUT_OF_RESOURCES	Failed to allocate needed resources.



## EFI\_DNS4\_PROTOCOL.GeneralLookUp()

### Summary

Retrieve arbitrary information from the DNS server.

### Prototype

```
typedef
EFI_STATUS
(EFI_API *EFI_DNS4_GENERAL_LOOKUP) (
    IN EFI_DNS4_PROTOCOL    *This,
    IN CHAR8                *QName,
    IN UINT16               QType,
    IN UINT16               QClass,
    IN EFI_DNS4_COMPLETION_TOKEN *Token
);
```

### Description

This **GeneralLookUp()** function retrieves arbitrary information from the DNS. The caller supplies a *QNAME*, *QTYPE*, and *QCLASS*, and all of the matching RRs are returned. All RR content (e.g., TTL) was returned. The caller need parse the returned RR to get required information. This function is optional.

### Parameters

<i>This</i>	Pointer to <b>EFI_DNS4_PROTOCOL</b> instance.
<i>QName</i>	Pointer to Query Name.
<i>QType</i>	Query Type.
<i>QClass</i>	Query Name.
<i>Token</i>	Point to the caller-allocated completion token to retrieve arbitrary information. Type <b>EFI_DNS4_COMPLETION_TOKEN</b> is defined in "Related Definitions" of above <b>HostNameToIp ()</b> .

### Status Codes Returned

EFI_SUCCESS	The operation was queued successfully.
EFI_UNSUPPORTED	This function is not supported. Or the requested <i>QType</i> is not supported
EFI_INVALID_PARAMETER	One or more of the following conditions is TRUE <i>This</i> is <b>NULL</b> . <i>Token</i> is <b>NULL</b> . <i>Token</i> .Event is <b>NULL</b> . <i>QName</i> is <b>NULL</b> .
EFI_NO_MAPPING	There's no source address is available for use.
EFI_ALREADY_STARTED	This <i>Token</i> is being used in another DNS session.

EFI_OUT_OF_RESOURCES	Failed to allocate needed resources.
----------------------	--------------------------------------

## EFI\_DNS4\_PROTOCOL.UpdateDnsCache()

### Summary

This function is used to update the DNS Cache.

### Prototype

```
typedef
EFI_STATUS
(EFI_API *EFI_DNS4_UPDATE_DNS_CACHE) (
  IN EFI_DNS4_PROTOCOL *This,
  IN BOOLEAN DeleteFlag,
  IN BOOLEAN Override,
  IN EFI_DNS4_CACHE_ENTRY DnsCacheEntry
);
```

### Parameters

<i>This</i>	Pointer to <b>EFI_DNS4_PROTOCOL</b> instance.
<i>DeleteFlag</i>	If <b>FALSE</b> , this function is to add one entry to the DNS Cache. If <b>TRUE</b> , this function will delete matching DNS Cache entry.
<i>Override</i>	If <b>TRUE</b> , the matching DNS cache entry will be overwritten with the supplied parameter. If <b>FALSE</b> , <b>EFI_ACCESS_DENIED</b> will be returned if the entry to be added is already exists.
<i>DnsCacheEntry</i>	Pointer to DNS Cache entry.

### Description

The **UpdateDnsCache()** function is used to add/delete/modify DNS cache entry. DNS cache can be normally dynamically updated after the DNS resolve succeeds. This function provided capability to manually add/delete/modify the DNS cache.

### Status Codes Returned

EFI_SUCCESS	The operation completed successfully.
EFI_INVALID_PARAMETER	One or more of the following conditions is true: <i>This</i> is <b>NULL</b> . <i>DnsCacheEntry.HostName</i> is <b>NULL</b> . <i>DnsCacheEntry.IpAddress</i> is <b>NULL</b> . <i>DnsCacheEntry.Timeout</i> is zero.
EFI_ACCESS_DENIED	The DNS cache entry already exists and <b>Override</b> is not <b>TRUE</b> .

## EFI\_DNS4\_PROTOCOL.Poll()

### Summary

Polls for incoming data packets and processes outgoing data packets.

### Prototype

```
typedef
EFI_STATUS
(EFI_API *EFI_DNS4_POLL) (
    IN EFI_DNS4_PROTOCOL *This
);
```

### Parameters

*This* Pointer to **EFI\_DNS4\_PROTOCOL** instance.

### Description

The **Poll()** function can be used by network drivers and applications to increase the rate that data packets are moved between the communications device and the transmit and receive queues.

In some systems, the periodic timer event in the managed network driver may not poll the underlying communications device fast enough to transmit and/or receive all data packets without missing incoming packets or dropping outgoing packets. Drivers and applications that are experiencing packet loss should try calling the Poll() function more often.

### Status Codes Returned

EFI_SUCCESS	Incoming or outgoing data was processed.
EFI_NOT_STARTED	This EFI DNS Protocol instance has not been started.
EFI_INVALID_PARAMETER	<i>This</i> is <b>NULL</b> .
EFI_DEVICE_ERROR	An unexpected system or network error occurred.
EFI_TIMEOUT	Data was dropped out of the transmit and/or receive queue. Consider increasing the polling rate.

## EFI\_DNS4\_PROTOCOL.Cancel()

### Summary

Abort an asynchronous DNS operation, including translation between IP and Host, and general look up behavior.

### Prototype

#### EFI Protocol

```
typedef
EFI_STATUS
(EFI_API *EFI_DNS4_CANCEL) (
  IN EFI_DNS4_PROTOCOL *This,
  IN EFI_DNS4_COMPLETION_TOKEN *Token
);
```

### Parameters

*This*

Pointer to **EFI\_DNS4\_PROTOCOL** instance.

*Token*

Pointer to a token that has been issued by **EFI\_DNS4\_PROTOCOL.HostNameToIp()**, **EFI\_DNS4\_PROTOCOL.IpToHostName()** or **EFI\_DNS4\_PROTOCOL.GeneralLookup()**. If NULL, all pending tokens are aborted.

### Description

The **Cancel()** function is used to abort a pending resolution request. After calling this function, **Token.Status** will be set to **EFI\_ABORTED** and then **Token.Event** will be signaled. If the token is not in one of the queues, which usually means that the asynchronous operation has completed, this function will not signal the token and **EFI\_NOT\_FOUND** is returned.

## Status Codes Returned

EFI_SUCCESS	The asynchronous DNS operation was aborted and <i>Token-&gt;Event</i> is signaled.
EFI_NOT_STARTED	This EFI DNS4 Protocol instance has not been started.
EFI_INVALID_PARAMETER	<i>This</i> is NULL.
EFI_NOT_FOUND	When <i>Token</i> is not NULL, and the asynchronous DNS operation was not found in the transmit queue. It was either completed or was not issued by <b>HostNameToIp()</b> , <b>IpToHostName()</b> or <b>GeneralLookup()</b> .

## 29.5 EFI DNSv6 Protocol

This section defines the EFI DNSv6 (Domain Name Service version 6) Protocol. It is split into the following two main sections.

- DNSv6 Service Binding Protocol (DNSv6SB)
- DNSv6 Protocol (DNSv6)

### 29.5.1 DNS6 Service Binding Protocol

#### EFI\_DNS6\_SERVICE\_BINDING\_PROTOCOL

##### Summary

The DNSv6SB is used to locate communication devices that are supported by a DNS driver and to create and destroy instances of the DNS child protocol driver.

The EFI Service Binding Protocol in [Section 2.5.8](#) defines the generic Service Binding Protocol functions. This section discusses the details that are specific to the DNSv6.

##### GUID

```
#define EFI_DNS6_SERVICE_BINDING_PROTOCOL_GUID \
{ 0x7f1647c8, 0xb76e, 0x44b2, \
  { 0xa5, 0x65, 0xf7, 0xf, 0xf1, 0x9c, 0xd1, 0x9e}}
```

##### Description

A network application (or driver) that requires network address resolution can use one of the protocol handler services, such as **BS->LocateHandleBuffer()**, to search for devices that publish a DNSv6SB GUID. Each device with a published DNSv6SB GUID supports DNSv6 and may be available for use.

After a successful call to the **EFI\_DNS6\_SERVICE\_BINDING\_PROTOCOL.CreateChild()** function, the child DNS driver instance is in an un-configured state; it is not ready to resolve addresses.

Before a network application terminates execution, every successful call to the **EFI\_DNS6\_SERVICE\_BINDING\_PROTOCOL.CreateChild()** function must be matched with a call to the **EFI\_DNS6\_SERVICE\_BINDING\_PROTOCOL.DestroyChild()** function.

*Note: All the network addresses that are described in **EFI\_DNS6\_PROTOCOL** are stored in network byte order. Both incoming and outgoing DNS packets are also in network byte order. All other parameters that are defined in functions or data structures are stored in host byte order.*

## 29.5.2 DNS6 Protocol

### EFI\_DNS6\_PROTOCOL

#### Summary

This protocol provides the function to get the host name and address mapping, also provide pass through interface to retrieve arbitrary information from DNSv6.

The **EFI\_DNS6\_Protocol** is primarily intended to retrieve host addresses using the standard DNS protocol (RFC3596), and support for this protocol is required.

Implementations may optionally also support local network name resolution methods such as LLMNR (RFC4795) however DNS queries shall always take precedence, and any use of local network name protocols would be restricted to cases where resolution using DNS protocol fails.

As stated above, all instances of **EFI\_DNS6\_Protocol** will utilize a common DNS cache containing the successful results of previous queries on any interface. However, it should be noted that every instance of **EFI\_DNS6\_Protocol** is associated with a specific network device or interface, and that all network actions initiated using a specific instance of the DNS protocol will occur only via use of the associated network interface. This means, in a system with multiple network interfaces, that a specific DNS server will often only be reachable using a specific network instance, and therefore the protocol user will need to take steps to insure the DNS instance associated with the proper network interface is used. Or alternatively, the caller may perform DNS functions against all interfaces until successful result is achieved.

## GUID

```
#define EFI_DNS6_PROTOCOL_GUID \
{ 0xca37bc1f, 0xa327, 0x4ae9, \
  { 0x82, 0x8a, 0x8c, 0x40, 0xd8, 0x50, 0x6a, 0x17 } }
```

## Protocol Interface Structure

```
typedef struct _EFI_DNS6_PROTOCOL {
  EFI_DNS6_GET_MODE_DATA      GetModeData;
  EFI_DNS6_CONFIGURE          Configure;
  EFI_DNS6_HOST_NAME_TO_IP    HostNameToIp;
  EFI_DNS6_IP_TO_HOST_NAME    IpToHostName;
  EFI_DNS6_GENERAL_LOOKUP     GeneralLookUp;
  EFI_DNS6_UPDATE_DNS_CACHE   UpdateDnsCache;
  EFI_DNS6_POLL               Poll;
  EFI_DNS6_CANCEL             Cancel;
} EFI_DNS6_PROTOCOL;
```



## EFI\_DNS6\_PROTOCOL.GetModeData()

### Summary

Retrieve mode data of this DNS instance.

### Prototype

```
typedef
EFI_STATUS
(EFI_API *EFI_DNS6_GET_MODE_DATA)(
  IN EFI_DNS6_PROTOCOL *This,
  OUT EFI_DNS6_MODE_DATA *DnsModeData
);
```

### Description

This function is used to retrieve DNS mode data for this DNS instance.

### Parameter

<i>This</i>	Pointer to <b>EFI_DNS6_PROTOCOL</b> instance.
<i>DnsModeData</i>	Pointer to the caller-allocated storage for the <b>EFI_DNS6_MODE_DATA</b> data.

### Related Definitions

```
//*****
// EFI_DNS6_MODE_DATA
//*****
typedef struct {
  EFI_DNS6_CONFIG_DATA DnsConfigData;
  UINT32 DnsServerCount;
  EFI_IPv6_ADDRESS *DnsServerList;
  UINT32 DnsCacheCount;
  EFI_DNS6_CACHE_ENTRY *DnsCacheList;
} EFI_DNS6_MODE_DATA;
```

*DnsConfigData* The configuration data of this instance. Type **EFI\_DNS6\_CONFIG\_DATA** is defined below.

*DnsServerCount* Number of configured DNS6 servers.

*DnsServerList* Pointer to common list of addresses of all configured DNS server used by **EFI\_DNS6\_PROTOCOL** instances. List will include DNS servers configured by this or any other **EFI\_DNS6\_PROTOCOL** instance. The storage for this list is allocated by the driver publishing this protocol, and must be freed by the caller

*DnsCacheCount* Number of DNS Cache entries. The DNS Cache is shared among all DNS6 instances.

*DnsCacheList* Pointer to a buffer containing *DnsCacheCount* DNS Cache entry structures. The storage for this list is allocated by the driver publishing this protocol and must be freed by caller.

```

//*****
// EFI_DNS6_CONFIG_DATA
//*****
typedef struct {
    BOOLEAN    EnableDnsCache;
    UINT8      Protocol;
    EFI_IPv6_ADDRESS StationIp;
    UINT16     LocalPort;
    UINT32     DnsServerCount;
    EFI_IPv6_ADDRESS *DnsServerList;
    UINT32     RetryCount;
    UINT32     RetryInterval;
} EFI_DNS6_CONFIG_DATA;

```

*IsDnsServerAuto* If **TRUE**, the DNS server configuration will be retrieved from DHCP server. If **FALSE**, the DNS server configuration will be manually configured through call of **DNSv6.Configure()** interface.

*EnableDnsCache* If **TRUE**, enable DNS cache function for this DNS instance. If **FALSE**, all DNS query will not lookup local DNS cache.

*Protocol* Use the protocol number defined in Links to UEFI-Related Documents" (<http://uefi.org/uefi>) under the heading "IANA Protocol Numbers". Only TCP or UDP are supported, and other protocol values are invalid. An implementation can choose to support only UDP, or both TCP and UDP.

*StationIp* The local IP address to use. Set to zero to let the underlying IPv6 driver choose a source address. If not zero it must be one of the configured IP addresses in the underlying IPv6 driver.

*DnsServerCount* Count of the DNS servers. When used with **GetModeData()**, this field is the count of originally configured servers when **Configure()** was called for this instance. When used with **Configure()** this is the count of caller-supplied servers. If the *DnsServerListCount* is zero, the DNS server configuration will be retrieved from DHCP server automatically.

*DnsServerList* Pointer to DNS server list containing *DnsServerListCount* entries or NULL if *DnsServerListCount* is 0. For **Configure()**, this will be NULL when there are no caller-supplied server addresses and the DNS instance will retrieve DNS server from DHCP Server. The provided DNS server list is recommended to be filled up in the sequence of preference. When used with **GetModeData()**, the buffer containing the list will be allocated by the driver

implementing this protocol and must be freed by the caller. When used with **Configure()**, the buffer containing the list will be allocated and released by the caller.

*LocalPort*

Local port number. Set to zero to use the automatically assigned port number.

*RetryCount*

Retry number if no response received after *RetryInterval*.

*RetryInterval*

Minimum interval of retry is 2 second. If the retry interval is less than 2 second, then use the 2 second.

```

//*****
// EFI_DNS6_CACHE_ENTRY
//*****
typedef struct {
    CHAR16    *HostName;
    EFI_IPv6_ADDRESS *IpAddress;
    UINT32    Timeout;
} EFI_DNS6_CACHE_ENTRY;
    
```

*HostName*

Host name. This should be interpreted as Unicode characters.

*IpAddress*

IP address of this host.

*Timeout*

Time in second unit that this entry will remain in DNS cache. A value of zero means that this entry is permanent. A nonzero value will override the existing one if this entry to be added is dynamic entry. Implementations may set its default timeout value for the dynamically created DNS cache entry after one DNS resolve succeeds.

### Status Codes Returned

EFI_SUCCESS	The operation completed successfully.
EFI_NOT_STARTED	When <i>DnsConfigData</i> is queried, no configuration data is available because this instance has not been configured.
EFI_INVALID_PARAMETER	<i>This</i> is NULL or <i>DnsModeData</i> is NULL.
EFI_OUT_OF_RESOURCE	Failed to allocate needed resources.

## EFI\_DNS6\_PROTOCOL.Configure()

### Summary

Configure this DNS instance

### Prototype

```
typedef
EFI_STATUS
(EFI_API * EFI_DNS6_CONFIGURE)(
    IN EFI_DNS6_PROTOCOL *This,
    IN EFI_DNS6_CONFIG_DATA *DnsConfigData
);
```

### Descriptions

The **Configure()** function is used to set and change the configuration data for this EFI DNSv6 Protocol driver instance. Reset the DNS instance if *DnsConfigData* is NULL.

### Parameters

*This* Pointer to **EFI\_DNS6\_PROTOCOL** instance.

*DnsConfigData* Pointer to the configuration data structure. Type **EFI\_DNS6\_CONFIG\_DATA** is defined in **EFI\_DNS6\_PROTOCOL.GetModeData()**. All associated storage to be allocated and released by caller.

### Status Codes Returned

EFI_SUCCESS	The operation completed successfully.
EFI_INVALID_PARAMETER	<i>This</i> is NULL. The StationIp address provided in <i>DnsConfigData</i> is not zero and not a valid unicast. <i>DnsServerList</i> is NULL while <i>DnsServerListCount</i> is not ZERO. <i>DnsServerListCount</i> is ZERO while <i>DnsServerList</i> is not NULL.
EFI_OUT_OF_RESOURCES	The DNS instance data or required space could not be allocated.
EFI_DEVICE_ERROR	An unexpected system or network error occurred. The EFI DNSv6 Protocol instance is not configured.
EFI_UNSUPPORTED	The designated protocol is not supported.
EFI_ALREADY_STARTED	Second call to <b>Configure()</b> with <i>DnsConfigData</i> . To reconfigure the instance the caller must call <b>Configure()</b> with NULL first to return driver to unconfigured state.

## EFI\_DNS6\_PROTOCOL.HostNameToIp()

### Summary

Host name to host address translation

### Prototype

```
typedef
EFI_STATUS
(EFI_API *EFI_DNS6_HOST_NAME_TO_IP) (
    IN EFI_DNS6_PROTOCOL *This,
    IN CHAR16 *HostName,
    IN EFI_DNS6_COMPLETION_TOKEN *Token
);
```

### Parameter

<i>This</i>	Pointer to <b>EFI_DNS6_PROTOCOL</b> instance.
<i>HostName</i>	Pointer to buffer containing fully-qualified Domain Name including <i>HostName</i> . To resolve successfully, characters within the FQDN string must be chosen according to the format and from within the set of ASCII characters authorized by DNS specifications. Any translation required for reference to domains or hostnames defined as containing Unicode characters, for example use of Punycode, must be performed by caller.
<i>Token</i>	Point to the completion token to translate host name to host address. Type <b>EFI_DNS6_COMPLETION_TOKEN</b> is defined in "Related Definitions" below.

### Related Definition

```
/**
// EFI_DNS6_COMPLETION_TOKEN
//
typedef struct {
    EFI_EVENT Event;
    EFI_STATUS Status;
    UINT32 RetryCount;
    UINT32 RetryInterval;
    union {
        DNS6_HOST_TO_ADDR_DATA *H2AData;
        DNS6_ADDR_TO_HOST_DATA *A2HData;
        DNS6_GENERAL_LOOKUP_DATA *GLookupData;
    } RspData;
} EFI_DNS6_COMPLETION_TOKEN;
```

<i>Event</i>	This <i>Event</i> will be signaled after the <b>Status</b> field is updated by the EFI DNSv6 protocol driver. The type of <i>Event</i> must be <b>EFI_NOTIFY_SIGNAL</b> .
--------------	---

<i>Status</i>	<p>Will be set to one of the following values.</p> <p><b>EFI_SUCCESS:</b> The host name to address translation completed successfully.</p> <p><b>EFI_NOT_FOUND:</b> No matching Resource Record (RR) is found.</p> <p><b>EFI_TIMEOUT:</b> No DNS server reachable, or <i>RetryCount</i> was exhausted without response from all specified DNS servers.</p> <p><b>EFI_DEVICE_ERROR:</b> An unexpected system or network error occurred.</p> <p><b>EFI_NO_MEDIA:</b> There was a media error.</p>
<i>RetryCount</i>	The parameter configured through <b>DNSv6.Configure()</b> interface. Retry number if no response received after <i>RetryInterval</i> .
<i>RetryInterval</i>	The parameter configured through <b>DNSv6.Configure()</b> interface. Minimum interval of retry is 2 second. If the retry interval is less than 2 second, then use the 2 second.
<i>H2AData</i>	When the <i>Token</i> is used for host name to address translation, <i>H2AData</i> is a pointer to the <b>DNS6_HOST_TO_ADDR_DATA</b> . Type <b>DNS6_HOST_TO_ADDR_DATA</b> is defined below.
<i>A2HData</i>	When the <i>Token</i> is used for host address to host name translation, <i>A2HData</i> is a pointer to the <b>DNS6_ADDR_TO_HOST_DATA</b> . Type <b>DNS6_ADDR_TO_HOST_DATA</b> is defined below.
<i>GLookupDATA</i>	When the <i>Token</i> is used for a general lookup function, <i>GLookupDATA</i> is a pointer to the <b>DNS6_GENERAL_LOOKUP_DATA</b> . Type <b>DNS6_GENERAL_LOOKUP_DATA</b> is defined below.

**EFI\_DNS6\_COMPLETION\_TOKEN** structures are used for host name to address translation, host address to name translation and general lookup operation, the *Event* field must be filled by the EFI DNSv6 Protocol Client. If the caller attempts to reuse *Token* before the completion event is triggered or canceled, **EFI\_ALREADY\_STARTED** will be returned. After the operation completes, the EFI DNSv6 protocol driver fill in the *RspData* and *Status* field and the *Event* is signaled.

```

//*****
// DNS6_HOST_TO_ADDR_DATA
//*****

typedef struct {
    UINT32      IpCount;
    EFI_IPv6_ADDRESS  *IpList;

```

```

} DNS6_HOST_TO_ADDR_DATA;
    IpCount           Number of the returned IP address
    IpList            Pointer to the all the returned IP address

//*****
// DNS6_ADDR_TO_HOST_DATA
//*****
typedef struct {
    CHAR16      *HostName;
} DNS6_ADDR_TO_HOST_DATA;
    HostName           Pointer to the primary name for this host address. It's the
                       caller's responsibility to free the response memory.

//*****
// DNS6_GENERAL_LOOKUP_DATA
//*****
typedef struct {
    UINTN      RRCount;
    DNS6_RESOURCE_RECORD *RRLList;
} DNS6_GENERAL_LOOKUP_DATA;
    RRCount           Number of returned matching RRs.
    RRLList           Pointer to the all the returned matching RRs. It's caller
                       responsibility to free the allocated memory to hold the
                       returned RRs

//*****
// DNS6_RESOURCE_RECORD
//*****
typedef struct {
    CHAR8      *QName;
    UINT16     QType;
    UINT16     QClass;
    UINT32     TTL;
    UINT16     DataLength;
    CHAR8      *RData;
} DNS6_RESOURCE_RECORD;
    QName             The Owner name.
    QType             The Type Code of this RR
    QClass            The CLASS code of this RR.

```

<i>TTL</i>	32 bit integer which specify the time interval that the resource record may be cached before the source of the information should again be consulted. Zero means this RR cannot be cached.
<i>DataLength</i>	16 big integer which specify the length of <i>RData</i> .
<i>RData</i>	A string of octets that describe the resource, the format of this information varies according to <i>QType</i> and <i>QClass</i> difference.

## Description

The **HostNameToIp ()** function is used to translate the host name to host IP address. A type AAAA record query is used to get the one or more IPv6 addresses for this host.

## Status Codes Returned

EFI_SUCCESS	The operation was queued successfully.
EFI_INVALID_PARAMETER	One or more of the following conditions is TRUE <i>This</i> is <b>NULL</b> . <i>Token</i> is <b>NULL</b> . <i>Token</i> . Event is <b>NULL</b> . <i>HostName</i> is <b>NULL</b> or buffer contained unsupported characters.
EFI_NO_MAPPING	There's no source address is available for use.
EFI_ALREADY_STARTED	This <i>Token</i> is being used in another DNS session.
EFI_NOT_STARTED	This instance has not been started.
EFI_OUT_OF_RESOURCES	Failed to allocate needed resources.



## EFI\_DNS6\_PROTOCOL.IpToHostName()

### Summary

Host address to host name translation

### Prototype

```
typedef
EFI_STATUS
(EFI_API *EFI_DNS6_IP_TO_HOST_NAME) (
    IN EFI_DNS6_PROTOCOL *This,
    IN EFI_IPv6_ADDRESS IpAddress,
    IN EFI_DNS6_COMPLETION_TOKEN *Token
);
```

### Parameter

<i>This</i>	Pointer to <b>EFI_DNS6_PROTOCOL</b> instance.
<i>IpAddress</i>	IP address.
<i>Token</i>	Point to the completion token to translate host address to host name. Type <b>EFI_DNS6_COMPLETION_TOKEN</b> is defined in "Related Definitions" of above <b>HostNameToIp ()</b> .

### Description

The **IpToHostName ()** function is used to translate the host address to host name. A type PTR query is used to get the primary name of the host. Implementation can choose to support this function or not.

### Status Codes Returned

EFI_SUCCESS	The operation was queued successfully.
EFI_UNSUPPORTED	This function is not supported
EFI_INVALID_PARAMETER	One or more of the following conditions is TRUE <i>This</i> is NULL. <i>Token</i> is NULL. <i>Token.Event</i> is NULL <i>IpAddress</i> is not valid IP address .
EFI_NO_MAPPING	There's no source address is available for use.
EFI_NOT_STARTED	This instance has not been started.
EFI_OUT_OF_RESOURCES	Failed to allocate needed resources.

## EFI\_DNS6\_PROTOCOL.GeneralLookUp()

### Summary

This function provides capability to retrieve arbitrary information from the DNS server.

### Prototype

```
typedef
EFI_STATUS
(EFI_API *EFI_DNS6_GENERAL_LOOKUP) (
    IN EFI_DNS6_PROTOCOL    *This,
    IN CHAR8                *QName,
    IN UINT16               QType,
    IN UINT16               QClass,
    IN EFI_DNS6_COMPLETION_TOKEN *Token
);
```

### Description

This **GeneralLookUp()** function retrieves arbitrary information from the DNS. The caller supplies a *QNAME*, *QTYPE*, and *QCLASS*, and all of the matching RRs are returned. All RR content (e.g., TTL) was returned. The caller need parse the returned RR to get required information. The function is optional. Implementation can choose to support it or not.

### Parameters

<i>This</i>	Pointer to <b>EFI_DNS6_PROTOCOL</b> instance.
<i>QName</i>	Pointer to Query Name.
<i>QType</i>	Query Type.
<i>QClass</i>	Query Name.
<i>Token</i>	Point to the completion token to retrieve arbitrary information. Type <b>EFI_DNS6_COMPLETION_TOKEN</b> is defined in "Related Definitions" of above <b>HostNameToIp()</b> .

### Status Codes Returned

EFI_SUCCESS	The operation was queued successfully.
EFI_UNSUPPORTED	This function is not supported. Or the requested QType is not supported
EFI_INVALID_PARAMETER	One or more of the following conditions is TRUE <i>This</i> is <b>NULL</b> . <i>Token</i> is <b>NULL</b> . <i>Token.Event</i> is <b>NULL</b> . <i>QName</i> is <b>NULL</b> .
EFI_NO_MAPPING	There's no source address is available for use.
EFI_NOT_STARTED	This instance has not been started.

EFI_OUT_OF_RESOURCES	Failed to allocate needed resources.
----------------------	--------------------------------------

## EFI\_DNS6\_PROTOCOL.UpdateDnsCache()

### Summary

This function is to update the DNS Cache.

### Prototype

```
typedef
EFI_STATUS
(EFI_API *EFI_DNS6_UPDATE_DNS_CACHE) (
    IN EFI_DNS6_PROTOCOL *This,
    IN BOOLEAN DeleteFlag,
    IN BOOLEAN Override,
    IN EFI_DNS6_CACHE_ENTRY DnsCacheEntry
);
```

### Parameters

<i>This</i>	Pointer to <b>EFI_DNS6_PROTOCOL</b> instance.
<i>DeleteFlag</i>	If FALSE, this function is to add one entry to the DNS Cache. If TRUE, this function will delete matching DNS Cache entry.
<i>Override</i>	If TRUE, the matching DNS cache entry will be overwritten with the supplied parameter. If FALSE, <b>EFI_ACCESS_DENIED</b> will be returned if the entry to be added is already existed.
<i>DnsCacheEntry</i>	Pointer to DNS Cache entry.

### Description

The **UpdateDnsCache()** function is used to add/delete/modify DNS cache entry. DNS cache can be normally dynamically updated after the DNS resolve succeeds. This function provided capability to manually add/delete/modify the DNS cache.

### Status Codes Returned

EFI_SUCCESS	The operation completed successfully.
EFI_INVALID_PARAMETER	One or more of the following conditions is <b>TRUE</b> : <i>This</i> is NULL. <i>DnsCacheEntry.HostName</i> is NULL. <i>DnsCacheEntry.IpAddress</i> is NULL. <i>DnsCacheEntry.Timeout</i> is ZERO.
EFI_ACCESS_DENIED	The DNS cache entry already exists and <b>Override</b> is not <b>TRUE</b> .
EFI_OUT_OF_RESOURCE	Failed to allocate needed resources.

## EFI\_DNS6\_PROTOCOL.POLL()

### Summary

Polls for incoming data packets and processes outgoing data packets.

### Prototype

```
typedef
EFI_STATUS
(EFI_API *EFI_DNS6_POLL) (
    IN EFI_DNS6_PROTOCOL *This
);
```

### Parameters

*This* Pointer to **EFI\_DNS6\_PROTOCOL** instance.

### Description

The **POLL()** function can be used by network drivers and applications to increase the rate that data packets are moved between the communications device and the transmit and receive queues.

In some systems, the periodic timer event in the managed network driver may not poll the underlying communications device fast enough to transmit and/or receive all data packets without missing incoming packets or dropping outgoing packets. Drivers and applications that are experiencing packet loss should try calling the **POLL()** function more often.

### Status Codes Returned

EFI_SUCCESS	Incoming or outgoing data was processed.
EFI_NOT_STARTED	This EFI DNS Protocol instance has not been started.
EFI_INVALID_PARAMETER	<i>This</i> is <b>NULL</b> .
EFI_NO_MAPPING	There's no source address is available for use.
EFI_DEVICE_ERROR	An unexpected system or network error occurred.
EFI_TIMEOUT	Data was dropped out of the transmit and/or receive queue. Consider increasing the polling rate.

## EFI\_DNS6\_PROTOCOL.Cancel()

Abort an asynchronous DNS operation, including translation between IP and Host, and general look up behavior.

### EFI Protocol

```
typedef
EFI_STATUS
(EFIAPI *EFI_DNS6_CANCEL) (
    IN EFI_DNS6_PROTOCOL *This,
    IN EFI_DNS6_COMPLETION_TOKEN *Token
);
```

### Parameters

<i>This</i>	Pointer to <b>EFI_DNS6_PROTOCOL</b> instance.
<i>Token</i>	Pointer to a token that has been issued by <b>EFI_DNS6_PROTOCOL.HostNameToIp()</b> , <b>EFI_DNS6_PROTOCOL.IpToHostName()</b> or <b>EFI_DNS6_PROTOCOL.GeneralLookUp()</b> . If NULL, all pending tokens are aborted.

### Description

The **Cancel()** function is used to abort a pending resolution request. After calling this function, *Token.Status* will be set to **EFI\_ABORTED** and then *Token.Event* will be signaled. If the token is not in one of the queues, which usually means that the asynchronous operation has completed, this function will not signal the token and **EFI\_NOT\_FOUND** is returned.

### Status Codes Returned

EFI_SUCCESS	The asynchronous DNS operation was aborted and <i>Token-&gt;Event</i> is signaled.
EFI_NOT_STARTED	This EFI DNS6 Protocol instance has not been started.
EFI_INVALID_PARAMETER	<i>This</i> is NULL.
EFI_NO_MAPPING	There's no source address is available for use.
EFI_NOT_FOUND	When <i>Token</i> is not NULL and the asynchronous DNS operation was not found in the transmit queue, It is either completed or was not issued by <b>HostNameToIp()</b> , <b>IpToHostName()</b> or <b>GeneralLookUp()</b> .

## 29.6 EFI HTTP Protocols

This section defines the EFI HTTP Protocol interface. It is split into the following two main sections.

- HTTP Service Binding Protocol (HTTSPB)
- HTTP Protocol (HTTP)

## 29.6.1 HTTP Service Binding Protocol

### EFI\_HTTP\_SERVICE\_BINDING\_PROTOCOL

#### Summary

The HTTSPB is used to locate communication devices that are supported by a HTTP driver and to create and destroy instances of the HTTP child protocol driver.

The EFI Service Binding Protocol in [Section 2.5.8](#) defines the generic Service Binding Protocol functions. This section discusses the details that are specific to the HTTP.

#### GUID

```
#define EFI_HTTP_SERVICE_BINDING_PROTOCOL_GUID \
  {0xbdc8e6af, 0xd9bc, 0x4379, \
   {0xa7, 0x2a, 0xe0, 0xc4, 0xe7, 0x5d, 0xae, 0x1c}}
```

#### Description

A network application (or driver) that requires HTTP communication service can use one of the protocol handler services, such as **BS->LocateHandleBuffer()**, to search for devices that publish a HTTSPB GUID. Each device with a published HTTP SB GUID supports HTTP Service Binding Protocol and may be available for use.

After a successful call to the **EFI\_HTTP\_SERVICE\_BINDING\_PROTOCOL.CreateChild()** function, the child HTTP driver instance is in an uninitialized state; it is not ready to initiate HTTP data transfer.

Before a network application terminates execution, every successful call to the **EFI\_HTTP\_SERVICE\_BINDING\_PROTOCOL.CreateChild()** function must be matched with a call to the **EFI\_HTTP\_SERVICE\_BINDING\_PROTOCOL.DestroyChild()** function.

## 29.6.2 EFI HTTP Protocol Specific Definitions

### EFI\_HTTP\_PROTOCOL

#### Protocol GUID

```
#define EFI_HTTP_PROTOCOL_GUID \
  {0x7A59B29B, 0x910B, 0x4171, \
   {0x82, 0x42, 0xA8, 0x5A, 0x0D, 0xF2, 0x5B, 0x5B}}
```

#### Protocol Interface Structure

```
typedef struct _EFI_HTTP_PROTOCOL {
  EFI_HTTP_GET_MODE_DATA GetModeData;
  EFI_HTTP_CONFIGURE Configure;
  EFI_HTTP_REQUEST Request;
  EFI_HTTP_CANCEL Cancel;
  EFI_HTTP_RESPONSE Response;
  EFI_HTTP_POLL Poll;
} EFI_HTTP_PROTOCOL;
```

#### Parameters

<i>GetModeData</i>	Gets the current operational status. See the <b>GetModeData()</b> function description.
<i>Configure</i>	Initialize, change, or reset operational settings in the EFI HTTP protocol instance. See <b>Configure()</b> for function description.
<i>Request</i>	Queue a request token into the transmit queue. This function is a non-blocking operation. See <b>Request()</b> for function description.
<i>Cancel</i>	Abort a pending request or response operation. See <b>Cancel()</b> for function description.
<i>Response</i>	Queue a response token into the receive queue. This function is a non-blocking operation. See <b>Response()</b> for function description.
<i>Poll</i>	Poll to receive incoming HTTP response and transmit outgoing HTTP request. See <b>Poll()</b> for function description.

#### Description

The EFI HTTP protocol is designed to be used by EFI drivers and applications to create and transmit HTTP Requests, as well as handle HTTP responses that are returned by a remote host. This EFI protocol uses and relies on an underlying EFI TCP protocol.



## EFI\_HTTP\_PROTOCOL.GetModeData()

### Summary

Returns the operational parameters for the current HTTP child instance.

### EFI Protocol

```
typedef
EFI_STATUS
(EFIAPI * EFI_HTTP_GET_MODE_DATA)(
  IN EFI_HTTP_PROTOCOL *This,
  OUT EFI_HTTP_CONFIG_DATA *HttpConfigData
);
```

### Parameters

*This*

Pointer to **EFI\_HTTP\_PROTOCOL** instance.

*HttpConfigData*

Point to buffer for operational parameters of this HTTP instance. Type **EFI\_HTTP\_CONFIG\_DATA** is defined in “Related Definitions” below.

### Description

The **GetModeData()** function is used to read the current mode data (operational parameters) for this HTTP protocol instance.

### Status Codes Returned

EFI_SUCCESS	Operation succeeded
EFI_INVALID_PARAMETER	<i>This</i> is NULL. <i>HttpConfigData</i> is NULL. <i>HttpConfigData-&gt;LocalAddressIsIPv6</i> is FALSE and <i>HttpConfigData-&gt;IPv4Node</i> is NULL. <i>HttpConfigData-&gt;LocalAddressIsIPv6</i> is TRUE and <i>HttpConfigData-&gt;IPv6Node</i> is NULL.
EFI_NOT_STARTED	This EFI HTTP Protocol instance has not been started.

```

//*****
// EFI_HTTP_CONFIG_DATA
//*****
typedef struct {
  EFI_HTTP_VERSION   HttpVersion;
  UINT32             TimeOutMillisec;
  BOOLEAN            LocalAddressIsIPv6;
  union {
    EFI_HTTPv4_ACCESS_POINT *IPv4Node;
    EFI_HTTPv6_ACCESS_POINT *IPv6Node;
  } AccessPoint;
} EFI_HTTP_CONFIG_DATA;

```

<i>HttpVersion</i>	HTTP version that this instance will support.
<i>TimeOutMillisec</i>	Time out (in milliseconds) when blocking for requests.
<i>LocalAddressIsIPv6</i>	Defines behavior of EFI DNS and TCP protocols consumed by this instance. If FALSE, this instance will use <b>EFI_DNS4_PROTOCOL</b> and <b>EFI_TCP4_PROTOCOL</b> . If TRUE, this instance will use <b>EFI_DNS6_PROTOCOL</b> and <b>EFI_TCP6_PROTOCOL</b> .
<i>IPv4Node</i>	When <i>LocalAddressIsIPv6</i> is FALSE, this points to the local address, subnet, and port used by the underlying TCP protocol.
<i>IPv6Node</i>	When <i>LocalAddressIsIPv6</i> is TRUE, this points to the local IPv6 address and port used by the underlying TCP protocol.

```

//*****
// EFI_HTTP_VERSION
//*****
typedef enum {
    HttpVersion10,
    HttpVersion11,
    HttpVersionUnsupported
} EFI_HTTP_VERSION;

//*****
// EFI_HTTPv4_ACCESS_POINT
//*****
typedef struct {
    BOOLEAN    UseDefaultAddress;
    EFI_IPv4_ADDRESS LocalAddress;
    EFI_IPv4_ADDRESS LocalSubnet;
    UINT16    LocalPort;
} EFI_HTTPv4_ACCESS_POINT;

```

<i>UseDefaultAddress</i>	Set to TRUE to instruct the EFI HTTP instance to use the default address information in every TCP connection made by this instance. In addition, when set to TRUE, <i>LocalAddress</i> and <i>LocalSubnet</i> are ignored.
<i>LocalAddress</i>	If <i>UseDefaultAddress</i> is set to FALSE, this defines the local IP address to be used in every TCP connection opened by this instance.
<i>LocalSubnet</i>	If <i>UseDefaultAddress</i> is set to FALSE, this defines the local subnet to be used in every TCP connection opened by this instance.
<i>LocalPort</i>	This defines the local port to be used in every TCP connection opened by this instance.

```

//*****
// EFI_HTTPv6_ACCESS_POINT
//*****
typedef struct {
    EFI_IPv6_ADDRESS LocalAddress;
    UINT16    LocalPort;
} EFI_HTTPv6_ACCESS_POINT;

```

<i>LocalAddress</i>	Local IP address to be used in every TCP connection opened by this instance.
<i>LocalPort</i>	Local port to be used in every TCP connection opened by this instance.

## EFI\_HTTP\_PROTOCOL.Configure()

### Summary

Initialize or brutally reset the operational parameters for this EFI HTTP instance.

### EFI Protocol

```
typedef
EFI_STATUS
(EFIAPI *EFI_HTTP_CONFIGURE)(
  IN EFI_HTTP_PROTOCOL          *This,
  IN EFI_HTTP_CONFIG_DATA      *HttpConfigData OPTIONAL
);
```

### Parameters

*This* Pointer to **EFI\_HTTP\_PROTOCOL** instance.

*HttpConfigData* Pointer to the configure data to configure the instance.

### Description

The **Configure()** function does the following:

- When *HttpConfigData* is not **NULL** Initialize this EFI HTTP instance by configuring timeout, local address, port, etc.
- When *HttpConfigData* is **NULL**, reset this EFI HTTP instance by closing all active connections with remote hosts, canceling all asynchronous tokens, and flush request and response buffers without informing the appropriate hosts.

No other EFI HTTP function can be executed by this instance until the **Configure()** function is executed and returns successfully.

### Status Codes Returned

EFI_SUCCESS	Operation succeeded.
EFI_INVALID_PARAMETER	One or more of the following conditions is <b>TRUE</b> : <i>This</i> is <b>NULL</b> . <i>HttpConfigData-&gt;LocalAddressIsIPv6</i> is <b>FALSE</b> and <i>HttpConfigData-&gt;IPv4Node</i> is <b>NULL</b> . <i>HttpConfigData-&gt;LocalAddressIsIPv6</i> is <b>TRUE</b> and <i>HttpConfigData-&gt;IPv6Node</i> is <b>NULL</b> .
EFI_NOT_STARTED	This EFI HTTP Protocol instance has not been started.
EFI_ALREADY_STARTED	Reinitialize this HTTP instance without calling <b>Configure()</b> with <b>NULL</b> to reset it.
EFI_DEVICE_ERROR	An unexpected system or network error occurred.
EFI_OUT_OF_RESOURCES	Could not allocate enough system resources when executing <b>Configure()</b> .

EFI_UNSUPPORTED	One or more options in <i>ConfigData</i> are not supported in the implementation.
-----------------	---

## EFI\_HTTP\_PROTOCOL.Request()

### Summary

The **Request()** function queues an HTTP request to this HTTP instance, similar to **Transmit()** function in the EFI TCP driver. When the HTTP request is sent successfully, or if there is an error, *Status* in token will be updated and *Event* will be signaled.

### EFI Protocol

```

Typedef
EFI_STATUS
(EFIAPI *EFI_HTTP_REQUEST) (
  IN EFI_HTTP_PROTOCOL *This,
  IN EFI_HTTP_TOKEN *Token
);

```

### Parameters

<i>This</i>	Pointer to <b>EFI_HTTP_PROTOCOL</b> instance.
<i>Token</i>	Pointer to storage containing HTTP request token. Type <b>EFI_HTTP_TOKEN</b> is defined in "Related Definitions" below.

### Related Definition

```

//*****
// EFI_HTTP_TOKEN
//*****
typedef struct {
  EFI_EVENT Event;
  EFI_STATUS Status;
  EFI_HTTP_MESSAGE *Message;
} EFI_HTTP_TOKEN;

```

<i>Event</i>	This <i>Event</i> will be signaled after the <i>Status</i> field is updated by the EFI HTTP Protocol driver. The type of <i>Event</i> must be <b>EFI_NOTIFY_SIGNAL</b> . The Task Priority Level (TPL) of Event must be lower than or equal to <b>TPL_CALLBACK</b> .
--------------	--

<i>Status</i>	<b>Status</b> will be set to one of the following value if the HTTP request is successfully sent or if an unexpected error occurs:
---------------	--

**EFI\_SUCCESS:** The HTTP request was successfully sent to the remote host.

**EFI\_HTTP\_ERROR:** The response message was successfully received but contains a HTTP error. The response status code is returned in Token.

**EFI\_ABORTED:** The HTTP request was canceled by the caller and removed from the transmit queue.

**EFI\_TIMEOUT:** The HTTP request timed out before reaching the remote host.

**EFI\_DEVICE\_ERROR:** An unexpected system or network error occurred.

*Message*

Pointer to storage containing HTTP message data.

```

//*****
// EFI_HTTP_MESSAGE
//*****
typedef struct {
    union {
        EFI_HTTP_REQUEST_DATA *Request;
        EFI_HTTP_RESPONSE_DATA *Response;
    } Data;
    UINTN HeaderCount;
    EFI_HTTP_HEADER *Headers;
    UINTN BodyLength;
    VOID *Body;
} EFI_HTTP_MESSAGE;

```

*Request* When the token is used to send a HTTP request, *Request* is a pointer to storage that contains such data as URL and HTTP method.

*Response* When used to await a response, *Response* points to storage containing HTTP response status code.

*HeaderCount* Number of HTTP header structures in *Headers* list. On request, this count is provided by the caller. On response, this count is provided by the HTTP driver.

*Headers* Array containing list of HTTP headers. On request, this array is populated by the caller. On response, this array is allocated and populated by the HTTP driver. It is the responsibility of the caller to free this memory on both request and response.

*BodyLength* Length in bytes of the HTTP body. This can be zero depending on the *HttpMethod* type.

*Body* Body associated with the HTTP request or response. This can be NULL depending on the *HttpMethod* type.

The HTTP driver will prepare a request string from the information contained in and queue it to the underlying TCP instance to be sent to the remote host. Typically, all fields in the structure will contain content (except *Body* and *BodyLength* when HTTP method is not POST or PUT), but there is a special case when using PUT or POST to send large amounts of data. Depending on the size of the data, it may not be able to be stored in a contiguous block of memory, so the data will need to be provided in chunks. In this case, if *Body* is not NULL and *BodyLength* is non-zero and all other fields are **NULL** or **0**, the HTTP driver will queue the data to be sent to the last remote host that a token was

successfully sent. If no previous token was sent successfully, this function will return **EFI\_INVALID\_PARAMETER**.

The HTTP driver is expected to close existing (if any) underlying TCP instance and create new TCP instance if the host name in the request URL is different from previous calls to **Request()**. This is consistent with RFC 2616 recommendation that HTTP clients should attempt to maintain an open TCP connection between client and host.

```

//*****
// EFI_HTTP_REQUEST_DATA
//*****
typedef struct {
    EFI_HTTP_METHOD Method;
    CHAR16 *Url;
} EFI_HTTP_REQUEST_DATA;

```

<i>Method</i>	The HTTP method (e.g. GET, POST) for this HTTP Request.
<i>Url</i>	The URI of a remote host. From the information in this field, the HTTP instance will be able to determine whether to use HTTP or HTTPS and will also be able to determine the port number to use. If no port number is specified, port 80 (HTTP) is assumed. See RFC 3986 for more details on URI syntax.

```

//*****
// EFI_HTTP_METHOD
//*****
typedef enum {
    HttpMethodGet,
    HttpMethodPost,
    HttpMethodPatch,
    HttpMethodOptions,
    HttpMethodConnect,
    HttpMethodHead,
    HttpMethodPut,
    HttpMethodDelete,
    HttpMethodTrace,
    HttpMethodMax
} EFI_HTTP_METHOD;

```

```

//*****
// EFI_HTTP_RESPONSE_DATA
//*****
typedef struct {
    EFI_HTTP_STATUS_CODE StatusCode;
} EFI_HTTP_RESPONSE_DATA;

```

<i>StatusCode</i>	Response status code returned by the remote host.
-------------------	---



```
/*******  
// EFI_HTTP_HEADER  
/*******  
typedef struct {  
  CHAR8      *FieldName;  
  CHAR8      *FieldValue;  
} EFI_HTTP_HEADER;
```

*FieldName*

Null terminated string which describes a field name. See RFC 2616 Section 14 for detailed information about field names.

*FieldValue*

Null terminated string which describes the corresponding field value. See RFC 2616 Section 14 for detailed information about field values.

```
typedef enum {
    HTTP_STATUS_UNSUPPORTED_STATUS = 0,
    HTTP_STATUS_100_CONTINUE,
    HTTP_STATUS_101_SWITCHING_PROTOCOLS,
    HTTP_STATUS_200_OK,
    HTTP_STATUS_201_CREATED,
    HTTP_STATUS_202_ACCEPTED,
    HTTP_STATUS_203_NON_AUTHORITATIVE_INFORMATION,
    HTTP_STATUS_204_NO_CONTENT,
    HTTP_STATUS_205_RESET_CONTENT,
    HTTP_STATUS_206_PARTIAL_CONTENT,
    HTTP_STATUS_300_MULTIPLE_CHOICES,
    HTTP_STATUS_301_MOVED_PERMANENTLY,
    HTTP_STATUS_302_FOUND,
    HTTP_STATUS_303_SEE_OTHER,
    HTTP_STATUS_304_NOT_MODIFIED,
    HTTP_STATUS_305_USE_PROXY,
    HTTP_STATUS_307_TEMPORARY_REDIRECT,
    HTTP_STATUS_400_BAD_REQUEST,
    HTTP_STATUS_401_UNAUTHORIZED,
    HTTP_STATUS_402_PAYMENT_REQUIRED,
    HTTP_STATUS_403_FORBIDDEN,
    HTTP_STATUS_404_NOT_FOUND,
    HTTP_STATUS_405_METHOD_NOT_ALLOWED,
    HTTP_STATUS_406_NOT_ACCEPTABLE,
    HTTP_STATUS_407_PROXY_AUTHENTICATION_REQUIRED,
    HTTP_STATUS_408_REQUEST_TIME_OUT,
    HTTP_STATUS_409_CONFLICT,
    HTTP_STATUS_410_GONE,
    HTTP_STATUS_411_LENGTH_REQUIRED,
    HTTP_STATUS_412_PRECONDITION_FAILED,
    HTTP_STATUS_413_REQUEST_ENTITY_TOO_LARGE,
```

```

HTTP_STATUS_414_REQUEST_URI_TOO_LARGE,
HTTP_STATUS_415_UNSUPPORTED_MEDIA_TYPE,
HTTP_STATUS_416_REQUESTED_RANGE_NOT_SATISFIED,
HTTP_STATUS_417_EXPECTATION_FAILED,
HTTP_STATUS_500_INTERNAL_SERVER_ERROR,
HTTP_STATUS_501_NOT_IMPLEMENTED,
HTTP_STATUS_502_BAD_GATEWAY,
HTTP_STATUS_503_SERVICE_UNAVAILABLE,
HTTP_STATUS_504_GATEWAY_TIME_OUT,
HTTP_STATUS_505_HTTP_VERSION_NOT_SUPPORTED,
HTTP_STATUS_308_PERMANENT_REDIRECT
} EFI_HTTP_STATUS_CODE;

```

## Status Codes Returned

EFI_SUCCESS	Outgoing data was processed.
EFI_NOT_STARTED	This EFI HTTP Protocol instance has not been started.
EFI_DEVICE_ERROR	An unexpected system or network error occurred.
EFI_TIMEOUT	Data was dropped out of the transmit or receive queue.
EFI_INVALID_PARAMETER	One or more of the following conditions is <b>TRUE</b> <i>This</i> is NULL. <i>Token</i> is NULL. <i>Token-&gt;Message</i> is NULL. <i>Token-&gt;Message-&gt;Body</i> is not NULL, <i>Token-&gt;Message-&gt;BodyLength</i> is non-zero, and <i>Token-&gt;Message-&gt;Data</i> is NULL, but a previous call to <b>Request()</b> has not been completed successfully.
EFI_OUT_OF_RESOURCES	Could not allocate enough system resources.
EFI_UNSUPPORTED	The HTTP method is not supported in current implementation.

## EFI\_HTTP\_PROTOCOL.Cancel()

### Summary

Abort an asynchronous HTTP request or response token.

### EFI Protocol

```
typedef
EFI_STATUS
(EFI_API * EFI_HTTP_CANCEL)(
  IN EFI_HTTP_PROTOCOL *This,
  IN EFI_HTTP_TOKEN *Token,
  );
```

### Parameters

<i>This</i>	Pointer to <b>EFI_HTTP_PROTOCOL</b> instance.
<i>Token</i>	Point to storage containing HTTP request or response token.

### Description

The **Cancel()** function aborts a pending HTTP request or response transaction. If *Token* is not **NULL** and the token is in transmit or receive queues when it is being cancelled, its *Token->Status* will be set to **EFI\_ABORTED** and then *Token->Event* will be signaled. If the token is not in one of the queues, which usually means that the asynchronous operation has completed, **EFI\_NOT\_FOUND** is returned. If *Token* is **NULL**, all asynchronous tokens issued by **Request()** or **Response()** will be aborted.

### Status Codes Returned

EFI_SUCCESS	Request and Response queues are successfully flushed.
EFI_INVALID_PARAMETER	<i>This</i> is <b>NULL</b> .
EFI_NOT_STARTED	This instance hasn't been configured.
EFI_NOT_FOUND	The asynchronous request or response token is not found.
EFI_UNSUPPORTED	The implementation does not support this function.

## EFI\_HTTP\_PROTOCOL.Response()

### Summary

The **Response()** function queues an HTTP response to this HTTP instance, similar to **Receive()** function in the EFI TCP driver. When the HTTP response is received successfully, or if there is an error, *Status* in token will be updated and *Event* will be signaled.

### EFI Protocol

```
typedef
EFI_STATUS
(EFI_API *EFI_HTTP_RESPONSE) (
    IN EFI_HTTP_PROTOCOL *This,
    IN EFI_HTTP_TOKEN *Token
);
```

### Parameters

<i>This</i>	Pointer to <b>EFI_HTTP_PROTOCOL</b> instance.
<i>Token</i>	Pointer to storage containing HTTP response token. See <b>Request()</b> function for the definition of <b>EFI_HTTP_TOKEN</b> .

### Description

The HTTP driver will queue a receive token to the underlying TCP instance. When data is received in the underlying TCP instance, the data will be parsed and Token will be populated with the response data. If the data received from the remote host contains an incomplete or invalid HTTP header, the HTTP driver will continue waiting (asynchronously) for more data to be sent from the remote host before signaling Event in Token.

It is the responsibility of the caller to allocate a buffer for *Body* and specify the size in *BodyLength*. If the remote host provides a response that contains a content body, up to *BodyLength* bytes will be copied from the receive buffer into *Body* and *BodyLength* will be updated with the amount of bytes received and copied to *Body*. This allows the client to download a large file in chunks instead of into one contiguous block of memory. Similar to HTTP request, if *Body* is not **NULL** and *BodyLength* is non-zero and all other fields are **NULL** or **0**, the HTTP driver will queue a receive token to underlying TCP instance. If data arrives in the receive buffer, up to *BodyLength* bytes of data will be copied to *Body*. The HTTP driver will then update *BodyLength* with the amount of bytes received and copied to *Body*.

If the HTTP driver does not have an open underlying TCP connection with the host specified in the response URL, **Response()** will return **EFI\_ACCESS\_DENIED**. This is

consistent with RFC 2616 recommendation that HTTP clients should attempt to maintain an open TCP connection between client and host.

### Status Codes Returned

EFI_SUCCESS	Allocation succeeded
EFI_NOT_STARTED	This EFI HTTP Protocol instance has not been initialized.
EFI_INVALID_PARAMETER	One or more of the following conditions is <b>TRUE</b> <i>This is NULL.</i> <i>Token is NULL.</i> <i>Token-&gt;Message is NULL.</i> <i>Token-&gt;Message-&gt;Body is not NULL, Token-&gt;Message-&gt;BodyLength is non-zero, and Token-&gt;Message-&gt;Data is NULL, but a previous call to <b>Response()</b> has not been completed successfully</i>
EFI_OUT_OF_RESOURCES	Could not allocate enough system resources.
EFI_ACCESS_DENIED	An open TCP connection is not present with the host specified by response URL.

## EFI\_HTTP\_PROTOCOL.Poll()

Polls for incoming data packets and processes outgoing data packets.

```
typedef
EFI_STATUS
(EFIAPI *EFI_HTTP_POLL) (
    IN EFI_HTTP_PROTOCOL* This
);
```

### Parameters

*This* Pointer to **EFI\_HTTP\_PROTOCOL** instance.

### Description

The **Poll()** function can be used by network drivers and applications to increase the rate that data packets are moved between the communication devices and the transmit and receive queues. In some systems, the periodic timer event in the managed network driver may not poll the underlying communications device fast enough to transmit and/or receive all data packets without missing incoming packets or dropping outgoing packets. Drivers and applications that are experiencing packet loss should try calling the **Poll()** function more often.

### Status Codes Returned

EFI_SUCCESS	Incoming or outgoing data was processed.
EFI_INVALID_PARAMETER	<i>This</i> is <b>NULL</b>
EFI_DEVICE_ERROR	An unexpected system or network error occurred.
EFI_NOT_READY	No incoming or outgoing data is processed.
EFI_NOT_STARTED	This EFI HTTP Protocol instance has not been started.

#### 29.6.2.1 Usage Examples

Here is an example of a client making a HTTP Request to download a driver bundle from Intel Driver Download Center. This example includes sample code for how to support a client that is behind a HTTP proxy server.

```
#include <Uefi.h>
#include <HttpProtocol.h>

BOOLEAN gRequestCallbackComplete = FALSE;
BOOLEAN gResponseCallbackComplete = FALSE;

VOID
EFIAPI
RequestCallback(
  IN EFI_EVENT Event,
  IN VOID *Context
)
{
  gRequestCallbackComplete = TRUE;
}

VOID
EFIAPI
ResponseCallback(
  IN EFI_EVENT Event,
  IN VOID *Context
)
{
  gResponseCallbackComplete = TRUE;
}

EFI_STATUS
EFIAPI
HttpClientMain(
  IN EFI_HANDLE ImageHandle,
  IN EFI_SYSTEM_TABLE *SystemTable
)
{
  EFI_STATUS Status;
  EFI_SERVICE_BINDING_PROTOCOL *ServiceBinding;
  EFI_HANDLE *Handle;
  EFI_HTTP_PROTOCOL *HttpProtocol;
  EFI_HTTP_CONFIG_DATA ConfigData;
  EFI_HTTPV4_ACCESS_POINT IPv4Node;
  EFI_HTTP_REQUEST_DATA RequestData;
  EFI_HTTP_HEADER RequestHeader;
```



```
EFI_HTTP_MESSAGE  RequestMessage;
EFI_HTTP_TOKEN    RequestToken;
EFI_HTTP_RESPONSE_DATA  ResponseData;
EFI_HTTP_MESSAGE  ResponseMessage;
EFI_HTTP_TOKEN    ResponseToken;
UINT8             Buffer[0x100000];
EFI_TIME          Baseline;
EFI_TIME          Current;
UINTN             Timer;
UINTN             Index;
UINTN             ContentDownloaded;
UINTN             ContentLength;

Status = gBS->LocateProtocol(
    &gEfiHttpServiceBindingProtocolGuid,
    NULL,
    &ServiceBinding
);
// TODO: Handle error...

Status = ServiceBinding->CreateChild(ServiceBinding, &Handle);
// TODO: Handle error...

Status = gBS->HandleProtocol(Handle, &gEfiHttpProtocolGuid, &HttpProtocol);
// TODO: Handle error...

ConfigData.HttpVersion = HttpVersion11;
ConfigData.TimeOutMillisec = 0; // Indicates default timeout period
ConfigData.LocalAddressesIPv6 = FALSE;

ZeroMem(&IPv4Node, sizeof(IPv4Node));
IPv4Node.UseDefaultAddress = TRUE; // Obtain IP address from DHCP
ConfigData.AccessPoint.IPv4Node = &IPv4Node;

// The HTTP driver must first be configured before requests or responses can
// be processed. This is the same for other network protocols such as TCP.
Status = HttpProtocol->Configure(HttpProtocol, &ConfigData);

// This request message is initialized to request a sample driver bundle
// from Intel's driver download center. To download a file, we use HTTP GET.
RequestData.Method = HttpMethodGet;
```

```
// URI where the file is located that we want to download.
RequestData.Url = L"\
http://downloadmirror.intel.com/23418/a08/FYKH-Win8.1-64bit-Driver-Bundle-Sep2014.zip";
// This header tells the HTTP driver to relay the HTTP request
// via a proxy server. This header is just used to demonstrate
// how to relay through a proxy with this driver. The method
// for obtaining the proxy address is up to the client. The
// HTTP driver does NOT resolve this on its own.
RequestHeader.FieldName = "Host";
RequestHeader.FieldValue = "my.proxyserver.com";
// Message format just contains a pointer to the request data
// and body info, if applicable. In the case of HTTP GET, body
// is not relevant.
RequestMessage.Data.Request = &RequestData;
// Just one header being provided in the HTTP message.
RequestMessage.HeaderCount = 1;
RequestMessage.Headers = &RequestHeader;
RequestMessage.BodyLength = 0;
RequestMessage.Body = NULL;
// Token format is similar to the token format in EFI TCP protocol.
RequestToken.Event = NULL;
Status = gBS->CreateEvent(
    EVT_NOTIFY_SIGNAL,
    TPL_CALLBACK,
    RequestCallback,
    NULL,
    &RequestToken.Event
);
// TODO: Handle error...
RequestToken.Status = EFI_SUCCESS;
RequestToken.Message = &RequestMessage;

gRequestCallbackComplete = FALSE;
// Finally, make HTTP request.
Status = HttpProtocol->Request(HttpProtocol, &RequestToken);
// TODO: Handle error...

Status = gRT->GetTime(&Baseline, NULL);
// TODO: Handle error...

// Optionally, wait for a certain amount of time before cancelling
```

```
// the request. In this case, we'll allow the network stack 10
// seconds to send the request successfully.
for (Timer = 0; !gRequestCallbackComplete && Timer < 10;) {
    // Give the HTTP driver some motivation...
    HttpProtocol->Poll(HttpProtocol);
    // In practice, a call to GetTime() only fails when the total
    // elapsed time between the last call to to GetTime() is less
    // than the resolution of one tick (e.g. 1 second, depending
    // on capabilities of hardware). We only care to check the time
    // when the call succeeds.
    if (!EFI_ERROR(gRT->GetTime(&Current, NULL)) &&
        Current.Second != Baseline.Second)
    {
        // One second has passed, so update Current time and
        // increment the counter.
        Baseline = Current;
        ++Timer;
    }
}

// Cancel request if we did not get a notification from the HTTP
// driver in a timely manner.
if (!gRequestCallbackComplete) {
    Status = HttpProtocol->Cancel(HttpProtocol, &RequestToken);
    // TODO: Handle error and exit condition...
}
// Assuming we succeed in our request...

// This response message is different that request in that the
// HTTP driver is responsible for allocating the headers during
// a response instead of the caller.
ResponseData.StatusCode = HTTP_STATUS_UNSUPPORTED_STATUS;
ResponseMessage.Data.Response = &ResponseData;
// HeaderCount will be updated by the HTTP driver on response.
ResponseMessage.HeaderCount = 0;
// Headers will be populated by the driver on response.
ResponseMessage.Headers = NULL;
// BodyLength maximum limit is defined by the caller. On response,
// the HTTP driver will update BodyLength to the total number of
// bytes copied to Body. This number will never exceed the initial
// maximum provided by the caller.
```

```
    ResponseMessage.BodyLength = sizeof(Buffer);
    ResponseMessage.Body = Buffer;
    // Token format is similar to the token format in EFI TCP protocol.
    ResponseToken.Event = NULL;
    Status = gBS->CreateEvent(
        EVT_NOTIFY_SIGNAL,
        TPL_CALLBACK,
        NULL,
        &ResponseToken,
        &ResponseToken.Event
    );
    ResponseToken.Status = EFI_SUCCESS;
    ResponseToken.Message = &ResponseMessage;

    gResponseCallbackComplete = FALSE;
    // Finally, make HTTP request.
    Status = HttpProtocol->Response(HttpProtocol, &ResponseToken);
    // TODO: Handle error...

    Status = gRT->GetTime(&Baseline, NULL);
    // TODO: Handle error...

    // Optionally, wait for a certain amount of time before cancelling.
    for (Timer = 0; !gResponseCallbackComplete && Timer < 10;) {
        HttpProtocol->Poll(HttpProtocol);
        if (!EFI_ERROR(gRT->GetTime(&Current, NULL)) &&
            Current.Second != Baseline.Second)
        {
            // One second has passed, so update Current time and
            // increment the counter.
            Baseline = Current;
            ++Timer;
        }
    }

    // Remove response token from queue if we did not get a notification
    // from the remote host in a timely manner.
    if (!gResponseCallbackComplete) {
        Status = HttpProtocol->Cancel(HttpProtocol, &ResponseToken);
        // TODO: Handle error and exit condition...
    }
}
```

```
// Assuming we successfully received a response...
for (Index = 0; Index < ResponseMessage.HeaderCount; ++Index) {
    // We can parse the length of the file from the ContentLength header.
    if (!AsciiStrCmp(ResponseMessage.Headers[Index].FieldName, "Content-Length")) {
        ContentLength =
            AsciiStrDecimalToUintn(ResponseMessage.Headers[Index].FieldValue);
    }
}
```

```
ContentDownloaded = ResponseMessage.BodyLength;
// TODO:
// Downloaded data exists in Buffer[0..ResponseMessage.BodyLength].
// At this point, depending on business use case, the content can
// be written to a file, stored on the heap, etc.
```

```
while (ContentDownloaded < ContentLength) {
    // If we make it here, we haven't yet downloaded the whole file and
    // need to keep going.
    ResponseMessage.Data.Response = NULL;
    if (ResponseMessage.Headers != NULL) {
        // No sense hanging onto this anymore.
        FreePool(ResponseMessage.Headers);
    }
    ResponseMessage.HeaderCount = 0;
    ResponseMessage.BodyLength = sizeof(Buffer);
    ZeroMem(Buffer, sizeof(Buffer));
    // ResponseMessage.Body still points to Buffer.
```

```
gResponseCallbackComplete = FALSE;
// The HTTP driver accepts a token where Data, Headers, and
// HeaderCount are all 0 or NULL. The driver will wait for a
// response from the last remote host which a transaction occurred
// and copy the response directly into Body, updating BodyLength
// with the total amount copied (downloaded).
Status = HttpProtocol->Response(HttpProtocol, &ResponseToken);
// TODO: Handle error...
```

```
Status = gRT->GetTime(&Baseline, NULL);
// TODO: Handle error...
```

```
// Optionally, wait for a certain amount of time before cancelling.
for (Timer = 0; !gResponseCallbackComplete && Timer < 10;) {
    HttpProtocol->Poll(HttpProtocol);
    if (!EFI_ERROR(gRT->GetTime(&Current, NULL)) &&
        Current.Second != Baseline.Second)
    {
        // One second has passed, so update Current time and
        // increment the counter.
        Baseline = Current;
        ++Timer;
    }
}

// Remove response token from queue if we did not get a notification
// from the remote host in a timely manner.
if (!gResponseCallbackComplete) {
    Status = HttpProtocol->Cancel(HttpProtocol, &ResponseToken);
    // TODO: Handle error and exit condition...
}

// Assuming we successfully received a response...
ContentDownloaded += ResponseMessage.BodyLength;
// TODO:
// Downloaded data exists in Buffer[0..ResponseMessage.BodyLength].
// Append data to a file, heap memory, etc.
}

// Perform any necessary cleanup and handling of downloaded file
// assuming we succeeded at downloading the content. Depending on
// where the data was stored as per business need, that data can
// be consumed at this point. For example, if the data was stored
// to a file system, the file can be opened and consumed.

return EFI_SUCCESS;
}
```

## 29.6.3 HTTP Utilities Protocol

### Summary

This section defines the EFI HTTP Utilities Protocol interface.

## EFI\_HTTP\_UTILITIES\_PROTOCOL

### Protocol GUID

```
#define EFI_HTTP_UTILITIES_PROTOCOL_GUID \  
{ 0x3E35C163, 0x4074, 0x45DD, \  
  { 0x43, 0x1E, 0x23, 0x98, 0x9D, 0xD8, 0x6B, 0x32 } }
```

### Protocol Interface Structure

```
typedef struct _EFI_HTTP_UTILITIES_PROTOCOL {  
  EFI_HTTP_UTILS_BUILD Build;  
  EFI_HTTP_UTILS_PARSE Parse;  
} EFI_HTTP_UTILITIES_PROTOCOL;
```

### Parameters

*Build*

Create HTTP header based on a combination of seed header, fields to delete, and fields to append.

*Parse*

Parses HTTP header and produces an array of key/value pairs.

### Description

The EFI HTTP utility protocol is designed to be used by EFI drivers and applications to parse HTTP headers from a byte stream. This driver is neither dependent on network connectivity, nor the existence of an underlying network infrastructure.

## EFI\_HTTP\_UTILITIES\_PROTOCOL.Build()

### Summary

Provides ability to add, remove, or replace HTTP headers in a raw HTTP message.

### EFI Protocol

```
typedef
EFI_STATUS
(EFIAPI *EFI_HTTP_UTILS_BUILD) (
  IN EFI_HTTP_UTILITIES_PROTOCOL *This,
  IN UINTN      SeedMessageSize
  IN VOID      *SeedMessage, OPTIONAL
  IN UINTN      DeleteCount
  IN CHAR8      *DeleteList[], OPTIONAL
  IN UINTN      AppendCount
  IN EFI_HTTP_HEADER *AppendList[], OPTIONAL
  OUT UINTN     *NewMessageSize,
  OUT VOID      **NewMessage,
);
```

### Parameters

<i>This</i>	Pointer to <b>EFI_HTTP_UTILITIES_PROTOCOL</b> instance.
<i>SeedMessageSize</i>	Size of the initial HTTP header. This can be zero.
<i>SeedMessage</i>	Initial HTTP header to be used as a base for building a new HTTP header. If NULL, <i>SeedMessageSize</i> is ignored.
<i>DeleteCount</i>	Number of null-terminated HTTP header field names in <i>DeleteList</i> .
<i>DeleteList</i>	List of null-terminated HTTP header field names to remove from <i>SeedMessage</i> . Only the field names are in this list because the field values are irrelevant to this operation.
<i>AppendCount</i>	Number of header fields in <i>AppendList</i> .
<i>AppendList</i>	List of HTTP headers to populate <i>NewMessage</i> with. If <i>SeedMessage</i> is not <b>NULL</b> , <i>AppendList</i> will be appended to the existing list from <i>SeedMessage</i> in <i>NewMessage</i> .
<i>NewMessageSize</i>	Pointer to number of header fields in <i>NewMessage</i> .
<i>NewMessage</i>	Pointer to a new list of HTTP headers based on

### Description

The **Build()** function is used to manage the headers portion of an HTTP message by providing the ability to add, remove, or replace HTTP headers.

### Status Codes Returned

EFI_SUCCESS	Add, remove, and replace operations succeeded.
-------------	--



EFI_OUT_OF_RESOURCES	Could not allocate memory for <i>NewMessage</i> .
EFI_INVALID_PARAMETER	One or more of the following conditions is <b>TRUE</b> <i>This is NULL</i>

## EFI\_HTTP\_UTILITIES\_PROTOCOL.Parse()

### Summary

Parse HTTP header into array of key/value pairs.

### EFI Protocol

```
typedef
EFI_STATUS
(EFI_API *EFI_HTTP_UTILS_PARSE) (
  IN EFI_HTTP_PROTOCOL *This,
  IN CHAR8 *HttpMessage,
  IN UINTN HttpMessageSize,
  OUT EFI_HTTP_HEADER **HeaderFields,
  OUT UINTN *FieldCount
);
```

### Parameters

<i>This</i>	Pointer to <b>EFI_HTTP_UTILITIES_PROTOCOL</b> instance.
<i>HttpMessage</i>	Contains raw unformatted HTTP header string.
<i>HttpMessageSize</i>	Size of HTTP header.
<i>HeaderFields</i>	Array of key/value header pairs.
<i>FieldCount</i>	Number of headers in <i>HeaderFields</i> .

### Description

The **Parse()** function is used to transform data stored in *HttpHeader* into a list of fields paired with their corresponding values.

### Status Codes Returned

EFI_SUCCESS	Allocation succeeded
EFI_NOT_STARTED	This EFI HTTP Protocol instance has not been initialized.
EFI_INVALID_PARAMETER	One or more of the following conditions is <b>TRUE</b> <ul style="list-style-type: none"> <li>• <i>This</i> is NULL</li> <li>• <i>HttpMessage</i> is NULL</li> <li>• <i>HeaderFields</i> is NULL</li> <li>• <i>FieldCount</i> is NULL</li> </ul>

## 29.7 EFI REST Protocol

This section defines the EFI REST Protocol interface.

## 29.7.1 EFI REST Protocol Definitions

### EFI\_REST\_PROTOCOL

#### Protocol GUID

```
#define EFI_REST_PROTOCOL_GUID \
    {0x0DB48A36, 0x4E54, 0xEA9C, \
     { 0x9B, 0x09, 0x1E, 0xA5, 0xBE, 0x3A, 0x66, 0x0B }}
```

#### Protocol Interface Structure

```
typedef struct _EFI_REST_PROTOCOL {
    EFI_REST_SEND_RECEIVE  SendReceive;
    EFI_REST_GET_TIME      GetServiceTime;
} EFI_REST_PROTOCOL;
```

#### Parameters

*RestSendReceive* Provides an HTTP-like interface to send and receive resources from a REST service.

*GetServiceTime* Returns the current time of the REST service.

#### Description

The EFI REST protocol is designed to be used by EFI drivers and applications to send and receive resources from a RESTful service. This protocol abstracts REST (Representational State Transfer) client functionality. This EFI protocol could be implemented to use an underlying EFI HTTP protocol, or it could rely on other interfaces that abstract HTTP access to the resources.

## EFI\_REST\_PROTOCOL.SendReceive()

### Summary

Provides a simple HTTP-like interface to send and receive resources from a REST service.

### EFI Protocol

```
typedef
EFI_STATUS
(EFIAPI *EFI_REST_SEND_RECEIVE)(
  IN EFI_REST_PROTOCOL *This,
  IN EFI_HTTP_MESSAGE *RequestMessage,
  OUT EFI_HTTP_MESSAGE *ResponseMessage
);
```

### Parameters

*This* Pointer to **EFI\_REST\_PROTOCOL** instance for a particular REST service.

*RequestMessage* Pointer to the HTTP request data for this resource

*ResponseMessage* Pointer to the HTTP response data obtained for this requested.

### Description

The **SendReceive()** function sends an HTTP request to this REST service, and returns a response when the data is retrieved from the service. *RequestMessage* contains the HTTP request to the REST resource identified by *RequestMessage.Request.Url*. The *ResponseMessage* is the returned HTTP response for that request, including any HTTP status.

### Status Codes Returned

EFI_SUCCESS	operation succeeded
EFI_INVALID_PARAMETER	<i>This</i> , <i>RequestMessage</i> , or <i>ResponseMessage</i> are NULL.
EFI_DEVICE_ERROR	An unexpected system or network error occurred.

## EFI\_REST\_PROTOCOL.GetServiceTime()

```
typedef
EFI_STATUS
(EFI_API *EFI_REST_GET_TIME)(
  IN EFI_REST_PROTOCOL *This,
  OUT EFI_TIME *Time
);
```

### Parameters

*This*

Pointer to **EFI\_REST\_PROTOCOL** instance.

*Time*

A pointer to storage to receive a snapshot of the current time of the REST service.

### Description

The **GetServiceTime()** function is an optional interface to obtain the current time from this REST service instance. If this REST service does not support retrieving the time, this function returns **EFI\_UNSUPPORTED**.

### Status Codes Returned

EFI_SUCCESS	operation succeeded
EFI_INVALID_PARAMETER	<i>This</i> or <i>Time</i> are <b>NULL</b> .
EFI_UNSUPPORTED	The RESTful service does not support returning the time
EFI_DEVICE_ERROR	An unexpected system or network error occurred.



## 30 Network Protocols — UDP and MTFTP

---

### 30.1 EFI UDP Protocol

This chapter defines the EFI UDP (User Datagram Protocol) Protocol that interfaces over the EFI IP Protocol, and the EFI MTFTP Protocol interface that is built upon the EFI UDP Protocol. Protocols for version 4 and version 6 of UDP and MTFTP are included.

#### 30.1.1 UDP4 Service Binding Protocol

##### EFI\_UDP4\_SERVICE\_BINDING\_PROTOCOL

###### Summary

The EFI UDPv4 Service Binding Protocol is used to locate communication devices that are supported by an EFI UDPv4 Protocol driver and to create and destroy instances of the EFI UDPv4 Protocol child protocol driver that can use the underlying communications device.

###### GUID

```
#define EFI_UDP4_SERVICE_BINDING_PROTOCOL_GUID \
  {0x83f01464,0x99bd,0x45e5,\
   {0xb3,0x83,0xaf,0x63,0x05,0xd8,0xe9,0xe6}}
```

###### Description

A network application that requires basic UDPv4 I/O services can use one of the protocol handler services, such as **BS->LocateHandleBuffer()**, to search for devices that publish a EFI UDPv4 Service Binding Protocol GUID. Each device with a published EFI UDPv4 Service Binding Protocol GUID supports the EFI UDPv4 Protocol and may be available for use.

After a successful call to the **EFI\_UDP4\_SERVICE\_BINDING\_PROTOCOL.CreateChild()** function, the newly created child EFI UDPv4 Protocol driver is in an unconfigured state; it is not ready to send and receive data packets.

Before a network application terminates execution every successful call to the **EFI\_UDP4\_SERVICE\_BINDING\_PROTOCOL.CreateChild()** function must be matched with a call to the **EFI\_UDP4\_SERVICE\_BINDING\_PROTOCOL.DestroyChild()** function.

#### 30.1.2 UDP4 Protocol

##### EFI\_UDP4\_PROTOCOL

###### Summary

The EFI UDPv4 Protocol provides simple packet-oriented services to transmit and receive UDP packets.

## GUID

```
#define EFI_UDP4_PROTOCOL_GUID \
{0x3ad9df29,0x4501,0x478d,\
{0xb1,0xf8,0x7f,0x7f,0xe7,0x0e,0x50,0xf3}}
```

## Protocol Interface Structure

```
typedef struct _EFI_UDP4_PROTOCOL {
  EFI_UDP4_GET_MODE_DATA  GetModeData;
  EFI_UDP4_CONFIGURE      Configure;
  EFI_UDP4_GROUPS         Groups;
  EFI_UDP4_ROUTES         Routes;
  EFI_UDP4_TRANSMIT       Transmit;
  EFI_UDP4_RECEIVE        Receive;
  EFI_UDP4_CANCEL         Cancel;
  EFI_UDP4_POLL           Poll;
} EFI_UDP4_PROTOCOL;
```

## Parameters

<i>GetModeData</i>	Reads the current operational settings. See the <b>GetModeData()</b> function description.
<i>Configure</i>	Initializes, changes, or resets operational settings for the EFI UDPv4 Protocol. See the <b>Configure()</b> function description.
<i>Groups</i>	Joins and leaves multicast groups. See the <b>Groups()</b> function description.
<i>Routes</i>	Add and deletes routing table entries. See the <b>Routes()</b> function description.
<i>Transmit</i>	Queues outgoing data packets into the transmit queue. This function is a nonblocked operation. See the <b>Transmit()</b> function description.
<i>Receive</i>	Places a receiving request token into the receiving queue. This function is a nonblocked operation. See the <b>Receive()</b> function description.
<i>Cancel</i>	Aborts a pending transmit or receive request. See the <b>Cancel()</b> function description.
<i>Poll</i>	Polls for incoming data packets and processes outgoing data packets. See the <b>Poll()</b> function description.

## Description

The **EFI\_UDP4\_PROTOCOL** defines an EFI UDPv4 Protocol session that can be used by any network drivers, applications, or daemons to transmit or receive UDP packets. This protocol instance can either be bound to a specified port as a service or connected to some remote peer as an active client. Each instance has its own settings, such as the routing table and group table, which are independent from each other.



**Note:** *In this document, all IPv4 addresses and incoming/outgoing packets are stored in network byte order. All other parameters in the functions and data structures that are defined in this document are stored in host byte order.*

## EFI\_UDP4\_PROTOCOL.GetModeData()

### Summary

Reads the current operational settings.

### Prototype

```
typedef
EFI_STATUS
(EFI_API *EFI_UDP4_GET_MODE_DATA) (
    IN EFI_UDP4_PROTOCOL      *This,
    OUT EFI_UDP4_CONFIG_DATA  *Udp4ConfigData OPTIONAL,
    OUT EFI_IP4_MODE_DATA     *Ip4ModeData  OPTIONAL,
    OUT EFI_MANAGED_NETWORK_CONFIG_DATA *MnpConfigData OPTIONAL,
    OUT EFI_SIMPLE_NETWORK_MODE *SnpModeData OPTIONAL
);
```

### Parameters

<i>This</i>	Pointer to the <b>EFI_UDP4_PROTOCOL</b> instance.
<i>Udp4ConfigData</i>	Pointer to the buffer to receive the current configuration data. Type <b>EFI_UDP4_CONFIG_DATA</b> is defined in “Related Definitions” below.
<i>Ip4ModeData</i>	Pointer to the EFI IPv4 Protocol mode data structure. Type <b>EFI_IP4_MODE_DATA</b> is defined in <b>EFI_IP4_PROTOCOL.GetModeData()</b> .
<i>MnpConfigData</i>	Pointer to the managed network configuration data structure. Type <b>EFI_MANAGED_NETWORK_CONFIG_DATA</b> is defined in <b>EFI_MANAGED_NETWORK_PROTOCOL.GetModeData()</b> .
<i>SnpModeData</i>	Pointer to the simple network mode data structure. Type <b>EFI_SIMPLE_NETWORK_MODE</b> is defined in the <b>EFI_SIMPLE_NETWORK_PROTOCOL</b> .

### Description

The **GetModeData()** function copies the current operational settings of this EFI UDPv4 Protocol instance into user-supplied buffers. This function is used optionally to retrieve the operational mode data of underlying networks or drivers.

## Related Definition

```

//*****
// EFI_UDP4_CONFIG_DATA
//*****
typedef struct {
//Receiving Filters
BOOLEAN   AcceptBroadcast;
BOOLEAN   AcceptPromiscuous;
BOOLEAN   AcceptAnyPort;
BOOLEAN   AllowDuplicatePort;
// I/O parameters
UINT8     TypeOfService;
UINT8     TimeToLive;
BOOLEAN   DoNotFragment;
UINT32    ReceiveTimeout;
UINT32    TransmitTimeout;
// Access Point
BOOLEAN   UseDefaultAddress;
EFI_IPv4_ADDRESS StationAddress;
EFI_IPv4_ADDRESS SubnetMask;
UINT16    StationPort;
EFI_IPv4_ADDRESS RemoteAddress;
UINT16    RemotePort;
} EFI_UDP4_CONFIG_DATA;

```

<i>AcceptBroadcast</i>	Set to <b>TRUE</b> to accept broadcast UDP packets.
<i>AcceptPromiscuous</i>	Set to <b>TRUE</b> to accept UDP packets that are sent to any address.
<i>AcceptAnyPort</i>	Set to <b>TRUE</b> to accept UDP packets that are sent to any port.
<i>AllowDuplicatePort</i>	Set to <b>TRUE</b> to allow this EFI UDPv4 Protocol child instance to open a port number that is already being used by another EFI UDPv4 Protocol child instance.
<i>TypeOfService</i>	<i>TypeOfService</i> field in transmitted IPv4 packets.
<i>TimeToLive</i>	<i>TimeToLive</i> field in transmitted IPv4 packets.
<i>DoNotFragment</i>	Set to <b>TRUE</b> to disable IP transmit fragmentation.
<i>ReceiveTimeout</i>	The receive timeout value (number of microseconds) to be associated with each incoming packet. Zero means do not drop incoming packets.
<i>TransmitTimeout</i>	The transmit timeout value (number of microseconds) to be associated with each outgoing packet. Zero means do not drop outgoing packets.
<i>UseDefaultAddress</i>	Set to <b>TRUE</b> to use the default IP address and default routing table. If the default IP address is not available yet, then the underlying EFI IPv4 Protocol driver will use

**EFI\_IP4\_CONFIG2\_PROTOCOL** to retrieve the IP address and subnet information. Ignored for incoming filtering if *AcceptPromiscuous* is set to **TRUE**.

*StationAddress*

The station IP address that will be assigned to this EFI UDPv4 Protocol instance. The EFI UDPv4 and EFI IPv4 Protocol drivers will only deliver incoming packets whose destination matches this IP address exactly. Address 0.0.0.0 is also accepted as a special case in which incoming packets destined to any station IP address are always delivered. Not used when *UseDefaultAddress* is **TRUE**. Ignored for incoming filtering if *AcceptPromiscuous* is **TRUE**.

*SubnetMask*

The subnet address mask that is associated with the station address. Not used when *UseDefaultAddress* is **TRUE**.

*StationPort*

The port number to which this EFI UDPv4 Protocol instance is bound. If a client of the EFI UDPv4 Protocol does not care about the port number, set *StationPort* to zero. The EFI UDPv4 Protocol driver will assign a random port number to transmitted UDP packets. Ignored if *AcceptAnyPort* is set to **TRUE**.

*RemoteAddress*

The IP address of remote host to which this EFI UDPv4 Protocol instance is connecting. If *RemoteAddress* is not 0.0.0.0, this EFI UDPv4 Protocol instance will be connected to *RemoteAddress*; i.e., outgoing packets of this EFI UDPv4 Protocol instance will be sent to this address by default and only incoming packets from this address will be delivered to client. Ignored for incoming filtering if *AcceptPromiscuous* is **TRUE**.

*RemotePort*

The port number of the remote host to which this EFI UDPv4 Protocol instance is connecting. If it is not zero, outgoing packets of this EFI UDPv4 Protocol instance will be sent to this port number by default and only incoming packets from this port will be delivered to client. Ignored if *RemoteAddress* is 0.0.0.0 and ignored for incoming filtering if *AcceptPromiscuous* is **TRUE**.

## Status Codes Returned

EFI_SUCCESS	The mode data was read.
EFI_NOT_STARTED	When <i>Udp4ConfigData</i> is queried, no configuration data is available because this instance has not been started.
EFI_INVALID_PARAMETER	<i>This</i> is <b>NULL</b> .

## EFI\_UDP4\_PROTOCOL.Configure()

### Summary

- Initializes, changes, or resets the operational parameters for this instance of the EFI UDPv4 Protocol.

### Prototype

```
typedef
EFI_STATUS
(EFIAPI *EFI_UDP4_CONFIGURE) (
  IN EFI_UDP4_PROTOCOL *This,
  IN EFI_UDP4_CONFIG_DATA *UdpConfigData OPTIONAL
);
```

### Parameters

*This* Pointer to the **EFI\_UDP4\_PROTOCOL** instance.

*UdpConfigData* Pointer to the buffer to receive the current mode data.

### Description

The **Configure()** function is used to do the following:

- Initialize and start this instance of the EFI UDPv4 Protocol.
- Change the filtering rules and operational parameters.
- Reset this instance of the EFI UDPv4 Protocol.

Until these parameters are initialized, no network traffic can be sent or received by this instance. This instance can be also reset by calling **Configure()** with *UdpConfigData* set to **NULL**. Once reset, the receiving queue and transmitting queue are flushed and no traffic is allowed through this instance.

With different parameters in *UdpConfigData*, **Configure()** can be used to bind this instance to specified port.

### Status Codes Returned

EFI_SUCCESS	The configuration settings were set, changed, or reset successfully.
EFI_NO_MAPPING	When using a default address, configuration (DHCP, BOOTP, RARP, etc.) is not finished yet.
EFI_INVALID_PARAMETER	One or more following conditions are <b>TRUE</b> : <ul style="list-style-type: none"> <li><i>This</i> is <b>NULL</b>.</li> <li><i>UdpConfigData.StationAddress</i> is not a valid unicast IPv4 address.</li> <li><i>UdpConfigData.SubnetMask</i> is not a valid IPv4 address mask. The subnet mask must be contiguous.</li> <li><i>UdpConfigData.RemoteAddress</i> is not a valid unicast IPv4 address if it is not zero.</li> </ul>

EFI_ALREADY_STARTED	The EFI UDPv4 Protocol instance is already started/configured and must be stopped/reset before it can be reconfigured. Only <i>TypeOfService</i> , <i>TimeToLive</i> , <i>DoNotFragment</i> , <i>ReceiveTimeout</i> , and <i>TransmitTimeout</i> can be reconfigured without stopping the current instance of the EFI UDPv4 Protocol.
EFI_ACCESS_DENIED	<i>UdpConfigData.AllowDuplicatePort</i> is <b>FALSE</b> and <i>UdpConfigData.StationPort</i> is already used by other instance.
EFI_OUT_OF_RESOURCES	The EFI UDPv4 Protocol driver cannot allocate memory for this EFI UDPv4 Protocol instance.
EFI_DEVICE_ERROR	An unexpected network or system error occurred and this instance was not opened.

## EFI\_UDP4\_PROTOCOL.Groups()

### Summary

Joins and leaves multicast groups.

### Prototype

```
typedef
EFI_STATUS
(EFIAPI *EFI_UDP4_GROUPS) (
  IN EFI_UDP4_PROTOCOL *This,
  IN BOOLEAN   JoinFlag,
  IN EFI_IPv4_ADDRESS *MulticastAddress OPTIONAL
);
```

### Parameters

<i>This</i>	Pointer to the <b>EFI_UDP4_PROTOCOL</b> instance.
<i>JoinFlag</i>	Set to <b>TRUE</b> to join a multicast group. Set to <b>FALSE</b> to leave one or all multicast groups.
<i>MulticastAddress</i>	Pointer to multicast group address to join or leave.

### Description

The **Groups()** function is used to enable and disable the multicast group filtering.

If the *JoinFlag* is **FALSE** and the *MulticastAddress* is **NULL**, then all currently joined groups are left.

### Status Codes Returned

EFI_SUCCESS	The operation completed successfully.
EFI_NOT_STARTED	The EFI UDPv4 Protocol instance has not been started.
EFI_NO_MAPPING	When using a default address, configuration (DHCP, BOOTP, RARP, etc.) is not finished yet.
EFI_OUT_OF_RESOURCES	Could not allocate resources to join the group.
EFI_INVALID_PARAMETER	One or more of the following conditions is <b>TRUE</b> : <ul style="list-style-type: none"> <li><i>This</i> is <b>NULL</b>.</li> <li><i>JoinFlag</i> is <b>TRUE</b> and <i>MulticastAddress</i> is <b>NULL</b>.</li> <li><i>JoinFlag</i> is <b>TRUE</b> and <i>*MulticastAddress</i> is not a valid multicast address.</li> </ul>
EFI_ALREADY_STARTED	The group address is already in the group table (when <i>JoinFlag</i> is <b>TRUE</b> ).
EFI_NOT_FOUND	The group address is not in the group table (when <i>JoinFlag</i> is <b>FALSE</b> ).
EFI_DEVICE_ERROR	An unexpected system or network error occurred.

## EFI\_UDP4\_PROTOCOL.Routes()

### Summary

Adds and deletes routing table entries.

### Prototype

```
typedef
EFI_STATUS
(EFI_API *EFI_UDP4_ROUTES) (
  IN EFI_UDP4_PROTOCOL *This,
  IN BOOLEAN DeleteRoute,
  IN EFI_IPv4_ADDRESS *SubnetAddress,
  IN EFI_IPv4_ADDRESS *SubnetMask,
  IN EFI_IPv4_ADDRESS *GatewayAddress
);
```

### Parameters

<i>This</i>	Pointer to the <b>EFI_UDP4_PROTOCOL</b> instance.
<i>DeleteRoute</i>	Set to <b>TRUE</b> to delete this route from the routing table. Set to <b>FALSE</b> to add this route to the routing table. <i>DestinationAddress</i> and <i>SubnetMask</i> are used as the key to each route entry.
<i>SubnetAddress</i>	The destination network address that needs to be routed.
<i>SubnetMask</i>	The subnet mask of <i>SubnetAddress</i> .
<i>GatewayAddress</i>	The gateway IP address for this route.

### Description

The **Routes()** function adds a route to or deletes a route from the routing table.

Routes are determined by comparing the *SubnetAddress* with the destination IP address and arithmetically **AND**-ing it with the *SubnetMask*. The gateway address must be on the same subnet as the configured station address.

The default route is added with *SubnetAddress* and *SubnetMask* both set to 0.0.0.0. The default route matches all destination IP addresses that do not match any other routes.

A zero *GatewayAddress* is a nonroute. Packets are sent to the destination IP address if it can be found in the Address Resolution Protocol (ARP) cache or on the local subnet. One automatic nonroute entry will be inserted into the routing table for outgoing packets that are addressed to a local subnet (gateway address of 0.0.0.0).

Each instance of the EFI UDPv4 Protocol has its own independent routing table. Instances of the EFI UDPv4 Protocol that use the default IP address will also have copies of the routing table provided by the **EFI\_IP4\_CONFIG2\_PROTOCOL**. These copies will be updated automatically whenever the IP driver reconfigures its instances; as a result, the previous modification to these copies will be lost.



**Note:** *There is no way to set up routes to other network interface cards (NICs) because each NIC has its own independent network stack that shares information only through **EFI UDP4 Variable**.*

### Status Codes Returned

EFI_SUCCESS	The operation completed successfully.
EFI_NOT_STARTED	The EFI UDPv4 Protocol instance has not been started.
EFI_NO_MAPPING	When using a default address, configuration (DHCP, BOOTP, RARP, etc.) is not finished yet.
EFI_INVALID_PARAMETER	One or more of the following conditions is <b>TRUE</b> : <ul style="list-style-type: none"> <li>• <i>This</i> is <b>NULL</b>.</li> <li>• <i>SubnetAddress</i> is <b>NULL</b>.</li> <li>• <i>SubnetMask</i> is <b>NULL</b>.</li> <li>• <i>GatewayAddress</i> is <b>NULL</b>.</li> <li>• <i>*SubnetAddress</i> is not a valid subnet address.</li> <li>• <i>*SubnetMask</i> is not a valid subnet mask.</li> <li>• <i>*GatewayAddress</i> is not a valid unicast IP address.</li> </ul>
EFI_OUT_OF_RESOURCES	Could not add the entry to the routing table.
EFI_NOT_FOUND	This route is not in the routing table.
EFI_ACCESS_DENIED	The route is already defined in the routing table.

## EFI\_UDP4\_PROTOCOL.Transmit()

### Summary

Queues outgoing data packets into the transmit queue.

### Prototype

```
typedef
EFI_STATUS
(EFI_API *EFI_UDP4_TRANSMIT) (
  IN EFI_UDP4_PROTOCOL *This,
  IN EFI_UDP4_COMPLETION_TOKEN *Token
);
```

### Parameters

<i>This</i>	Pointer to the <b>EFI_UDP4_PROTOCOL</b> instance.
<i>Token</i>	Pointer to the completion token that will be placed into the transmit queue. Type <b>EFI_UDP4_COMPLETION_TOKEN</b> is defined in “Related Definitions” below.

### Description

The **Transmit()** function places a sending request to this instance of the EFI UDPv4 Protocol, alongside the transmit data that was filled by the user. Whenever the packet in the token is sent out or some errors occur, the **Token.Event** will be signaled and **Token.Status** is updated. Providing a proper notification function and context for the event will enable the user to receive the notification and transmitting status.

### Related Definitions

```
/**
//*****
// EFI_UDP4_COMPLETION_TOKEN
//*****
typedef struct {
  EFI_EVENT      Event;
  EFI_STATUS     Status;
  union {
    EFI_UDP4_RECEIVE_DATA *RxData;
    EFI_UDP4_TRANSMIT_DATA *TxData;
  } Packet;
} EFI_UDP4_COMPLETION_TOKEN;
```

<i>Event</i>	This <i>Event</i> will be signaled after the <i>Status</i> field is updated by the EFI UDPv4 Protocol driver. The type of <i>Event</i> must be <b>EVT_NOTIFY_SIGNAL</b> . The Task Priority Level (TPL) of <i>Event</i> must be lower than or equal to <b>TPL_CALLBACK</b> .
--------------	--

<i>Status</i>	Will be set to one of the following values:
---------------	---

**EFI\_SUCCESS.** The receive or transmit operation completed successfully.

**EFI\_ABORTED.** The receive or transmit was aborted.

**EFI\_TIMEOUT.** The transmit timeout expired.

**EFI\_NETWORK\_UNREACHABLE.** The destination network is unreachable. *RxData* is set to **NULL** in this situation.

**EFI\_HOST\_UNREACHABLE.** The destination host is unreachable. *RxData* is set to **NULL** in this situation.

**EFI\_PROTOCOL\_UNREACHABLE.** The UDP protocol is unsupported in the remote system. *RxData* is set to **NULL** in this situation.

**EFI\_PORT\_UNREACHABLE.** No service is listening on the remote port. *RxData* is set to **NULL** in this situation.

**EFI\_ICMP\_ERROR.** Some other Internet Control Message Protocol (ICMP) error report was received. For example, packets are being sent too fast for the destination to receive them and the destination sent an ICMP source quench report. *RxData* is set to **NULL** in this situation.

**EFI\_DEVICE\_ERROR.** An unexpected system or network error occurred.

**EFI\_NO\_MEDIA.** There was a media error.

*RxData*

When this token is used for receiving, *RxData* is a pointer to **EFI\_UDP4\_RECEIVE\_DATA**. Type **EFI\_UDP4\_RECEIVE\_DATA** is defined below.

*TxData*

When this token is used for transmitting, *TxData* is a pointer to **EFI\_UDP4\_TRANSMIT\_DATA**. Type **EFI\_UDP4\_TRANSMIT\_DATA** is defined below.

The **EFI\_UDP4\_COMPLETION\_TOKEN** structures are used for both transmit and receive operations.

When used for transmitting, the *Event* and *TxData* fields must be filled in by the EFI UDPv4 Protocol client. After the transmit operation completes, the *Status* field is updated by the EFI UDPv4 Protocol and the *Event* is signaled.

- When used for receiving, only the *Event* field must be filled in by the EFI UDPv4 Protocol client. After a packet is received, *RxData* and *Status* are filled in by the EFI UDPv4 Protocol and the *Event* is signaled.
- The ICMP related status codes filled in *Status* are defined as follows:

```
//*****
// UDP4 Token Status definition
//*****
#define EFI_NETWORK_UNREACHABLE EFIERR(100)
#define EFI_HOST_UNREACHABLE EFIERR(101)
#define EFI_PROTOCOL_UNREACHABLE EFIERR(102)
#define EFI_PORT_UNREACHABLE EFIERR(103)
```

```

//*****
// EFI_UDP4_RECEIVE_DATA
//*****
typedef struct {
    EFI_TIME    TimeStamp;
    EFI_EVENT    RecycleSignal;
    EFI_UDP4_SESSION_DATA    UdpSession;
    UINT32    DataLength;
    UINT32    FragmentCount;
    EFI_UDP4_FRAGMENT_DATA    FragmentTable[1];
} EFI_UDP4_RECEIVE_DATA;

```

<i>TimeStamp</i>	Time when the EFI UDPv4 Protocol accepted the packet. <i>TimeStamp</i> is zero filled if timestamps are disabled or unsupported.
<i>RecycleSignal</i>	Indicates the event to signal when the received data has been processed.
<i>UdpSession</i>	The UDP session data including <i>SourceAddress</i> , <i>SourcePort</i> , <i>DestinationAddress</i> , and <i>DestinationPort</i> . Type <b>EFI_UDP4_SESSION_DATA</b> is defined below.
<i>DataLength</i>	The sum of the fragment data length.
<i>FragmentCount</i>	Number of fragments. May be zero.
<i>FragmentTable</i>	Array of fragment descriptors. IP and UDP headers are included in these buffers if <i>ConfigData.RawData</i> is <b>TRUE</b> . Otherwise they are stripped. May be zero. Type <b>EFI_UDP4_FRAGMENT_DATA</b> is defined below.

**EFI\_UDP4\_RECEIVE\_DATA** is filled by the EFI UDPv4 Protocol driver when this EFI UDPv4 Protocol instance receives an incoming packet. If there is a waiting token for incoming packets, the *CompletionToken.Packet.RxData* field is updated to this incoming packet and the *CompletionToken.Event* is signaled. The EFI UDPv4 Protocol client must signal the *RecycleSignal* after processing the packet.

- *FragmentTable* could contain multiple buffers that are not in the continuous memory locations. The EFI UDPv4 Protocol client might need to combine two or more buffers in *FragmentTable* to form their own protocol header.

```

//*****
// EFI_UDP4_SESSION_DATA
//*****
typedef struct {
  EFI_IPv4_ADDRESS SourceAddress;
  UINT16 SourcePort;
  EFI_IPv4_ADDRESS DestinationAddress;
  UINT16 DestinationPort;
} EFI_UDP4_SESSION_DATA;

```

<i>SourceAddress</i>	Address from which this packet is sent. If this field is set to zero when sending packets, the address that is assigned in <b>EFI_UDP4_PROTOCOL.Configure()</b> is used.
<i>SourcePort</i>	Port from which this packet is sent. It is in host byte order. If this field is set to zero when sending packets, the port that is assigned in <b>EFI_UDP4_PROTOCOL.Configure()</b> is used. If this field is set to zero and unbound, a call to <b>EFI_UDP4_PROTOCOL.Transmit()</b> will fail.
<i>DestinationAddress</i>	Address to which this packet is sent.
<i>DestinationPort</i>	Port to which this packet is sent. It is in host byte order. If this field is set to zero and unconnected, the call to <b>EFI_UDP4_PROTOCOL.Transmit()</b> will fail.

The **EFI\_UDP4\_SESSION\_DATA** is used to retrieve the settings when receiving packets or to override the existing settings of this EFI UDPv4 Protocol instance when sending packets.

```

//*****
// EFI_UDP4_FRAGMENT_DATA
//*****
typedef struct {
  UINT32 FragmentLength;
  VOID *FragmentBuffer;
} EFI_UDP4_FRAGMENT_DATA;

```

<i>FragmentLength</i>	Length of the fragment data buffer.
<i>FragmentBuffer</i>	Pointer to the fragment data buffer.

**EFI\_UDP4\_FRAGMENT\_DATA** allows multiple receive or transmit buffers to be specified. The purpose of this structure is to avoid copying the same packet multiple times.

```

//*****
// EFI_UDP4_TRANSMIT_DATA
//*****
typedef struct {
    EFI_UDP4_SESSION_DATA *UdpSessionData;
    EFI_IPv4_ADDRESS *GatewayAddress;
    UINT32    DataLength;
    UINT32    FragmentCount;
    EFI_UDP4_FRAGMENT_DATA FragmentTable[1];
} EFI_UDP4_TRANSMIT_DATA;
    
```

- UdpSessionData*      If not **NULL**, the data that is used to override the transmitting settings. Type **EFI\_UDP4\_SESSION\_DATA** is defined above.
- GatewayAddress*      The next-hop address to override the setting from the routing table.
- DataLength*            Sum of the fragment data length. Must not exceed the maximum UDP packet size.
- FragmentCount*        Number of fragments.
- FragmentTable*        Array of fragment descriptors. Type **EFI\_UDP4\_FRAGMENT\_DATA** is defined above.

The EFI UDPv4 Protocol client must fill this data structure before sending a packet. The packet may contain multiple buffers that may be not in a continuous memory location.

### Status Codes Returned

EFI_SUCCESS	The data has been queued for transmission.
EFI_NOT_STARTED	This EFI UDPv4 Protocol instance has not been started.
EFI_NO_MAPPING	When using a default address, configuration (DHCP, BOOTP, RARP, etc.) is not finished yet.

EFI_INVALID_PARAMETER	<p>One or more of the following are <b>TRUE</b>:</p> <ul style="list-style-type: none"> <li>• <i>This</i> is <b>NULL</b>.</li> <li>• <i>Token</i> is <b>NULL</b>.</li> <li>• <i>Token.Event</i> is <b>NULL</b>.</li> <li>• <i>Token.Packet.TxData</i> is <b>NULL</b>.</li> <li>• <i>Token.Packet.TxData.FragmentCount</i> is zero.</li> <li>• <i>Token.Packet.TxData.DataLength</i> is not equal to the sum of fragment lengths.</li> <li>• One or more of the <i>Token.Packet.TxData.FragmentTable[].FragmentLength</i> fields is zero.</li> <li>• One or more of the <i>Token.Packet.TxData.FragmentTable[].FragmentBuffer</i> fields is <b>NULL</b>.</li> <li>• <i>Token.Packet.TxData.GatewayAddress</i> is not a unicast IPv4 address if it is not <b>NULL</b>.</li> <li>• <i>Token.Packet.TxData.UdpSessionData.SourceAddress</i> is not a valid unicast IPv4 address or <i>Token.Packet.TxData.UdpSessionData.DestinationAddress</i> is zero if the <i>UdpSessionData</i> is not <b>NULL</b>.</li> </ul>
EFI_ACCESS_DENIED	The transmit completion token with the same <i>Token.Event</i> was already in the transmit queue.
EFI_NOT_READY	The completion token could not be queued because the transmit queue is full.
EFI_OUT_OF_RESOURCES	Could not queue the transmit data.
EFI_NOT_FOUND	There is no route to the destination network or address.
EFI_BAD_BUFFER_SIZE	The data length is greater than the maximum UDP packet size. Or the length of the IP header + UDP header + data length is greater than MTU if <i>DoNotFragment</i> is <b>TRUE</b> .
EFI_NO_MEDIA	There was a media error.

## EFI\_UDP4\_PROTOCOL.Receive()

### Summary

Places an asynchronous receive request into the receiving queue.

### Prototype

```
typedef
EFI_STATUS
(EFIAPI *EFI_UDP4_RECEIVE) (
    IN EFI_UDP4_PROTOCOL *This,
    IN EFI_UDP4_COMPLETION_TOKEN *Token
);
```

### Parameters

*This*

Pointer to the **EFI\_UDP4\_PROTOCOL** instance.

*Token*

Pointer to a token that is associated with the receive data descriptor. Type **EFI\_UDP4\_COMPLETION\_TOKEN** is defined in **EFI\_UDP4\_PROTOCOL.Transmit()**.

### Description

The **Receive()** function places a completion token into the receive packet queue. This function is always asynchronous.

The caller must fill in the *Token.Event* field in the completion token, and this field cannot be **NULL**. When the receive operation completes, the EFI UDPv4 Protocol driver updates the *Token.Status* and *Token.Packet.RxData* fields and the *Token.Event* is signaled.

Providing a proper notification function and context for the event will enable the user to receive the notification and receiving status. That notification function is guaranteed to not be re-entered.

### Status Codes Returned

EFI_SUCCESS	The receive completion token was cached.
EFI_NOT_STARTED	This EFI UDPv4 Protocol instance has not been started.
EFI_NO_MAPPING	When using a default address, configuration (DHCP, BOOTP, RARP, etc.) is not finished yet.
EFI_INVALID_PARAMETER	One or more of the following conditions is <b>TRUE</b> : <ul style="list-style-type: none"> <li><i>This</i> is <b>NULL</b>.</li> <li><i>Token</i> is <b>NULL</b>.</li> <li><i>Token.Event</i> is <b>NULL</b>.</li> </ul>
EFI_OUT_OF_RESOURCES	The receive completion token could not be queued due to a lack of system resources (usually memory).
EFI_DEVICE_ERROR	An unexpected system or network error occurred. The EFI UDPv4 Protocol instance has been reset to startup defaults.



EFI_ACCESS_DENIED	A receive completion token with the same <i>Token.Event</i> was already in the receive queue.
EFI_NOT_READY	The receive request could not be queued because the receive queue is full.
EFI_NO_MEDIA	There was a media error.

## EFI\_UDP4\_PROTOCOL.Cancel()

### Summary

Aborts an asynchronous transmit or receive request.

### Prototype

```
typedef
EFI_STATUS
(EFIAPI *EFI_UDP4_CANCEL)(
  IN EFI_UDP4_PROTOCOL  *This,
  IN EFI_UDP4_COMPLETION_TOKEN *Token OPTIONAL
);
```

### Parameters

*This* Pointer to the **EFI\_UDP4\_PROTOCOL** instance.

*Token* Pointer to a token that has been issued by **EFI\_UDP4\_PROTOCOL.Transmit()** or **EFI\_UDP4\_PROTOCOL.Receive()**. If **NULL**, all pending tokens are aborted. Type **EFI\_UDP4\_COMPLETION\_TOKEN** is defined in **EFI\_UDP4\_PROTOCOL.Transmit()**.

### Description

The **Cancel()** function is used to abort a pending transmit or receive request. If the token is in the transmit or receive request queues, after calling this function, *Token.Status* will be set to **EFI\_ABORTED** and then *Token.Event* will be signaled. If the token is not in one of the queues, which usually means that the asynchronous operation has completed, this function will not signal the token and **EFI\_NOT\_FOUND** is returned.

### Status Codes Returned

EFI_SUCCESS	The asynchronous I/O request was aborted and <i>Token.Event</i> was signaled. When <i>Token</i> is <b>NULL</b> , all pending requests are aborted and their events are signaled.
EFI_INVALID_PARAMETER	<i>This</i> is <b>NULL</b> .
EFI_NOT_STARTED	This instance has not been started.
EFI_NO_MAPPING	When using the default address, configuration (DHCP, BOOTP, RARP, etc.) is not finished yet.
EFI_NOT_FOUND	When <i>Token</i> is not <b>NULL</b> , the asynchronous I/O request was not found in the transmit or receive queue. It has either completed or was not issued by <b>Transmit()</b> and <b>Receive()</b> .

## EFI\_UDP4\_PROTOCOL.Poll()

### Summary

Polls for incoming data packets and processes outgoing data packets.

### Prototype

```
typedef
EFI_STATUS
(EFI_API *EFI_UDP4_POLL) (
    IN EFI_UDP4_PROTOCOL *This
);
```

### Parameters

*This* Pointer to the **EFI\_UDP4\_PROTOCOL** instance.

### Description

The **Poll()** function can be used by network drivers and applications to increase the rate that data packets are moved between the communications device and the transmit and receive queues.

In some systems, the periodic timer event in the managed network driver may not poll the underlying communications device fast enough to transmit and/or receive all data packets without missing incoming packets or dropping outgoing packets. Drivers and applications that are experiencing packet loss should try calling the **Poll()** function more often.

### Status Codes Returned

EFI_SUCCESS	Incoming or outgoing data was processed.
EFI_INVALID_PARAMETER	<i>This</i> is <b>NULL</b> .
EFI_DEVICE_ERROR	An unexpected system or network error occurred.
EFI_TIMEOUT	Data was dropped out of the transmit and/or receive queue. Consider increasing the polling rate.

## 30.2 EFI UDPv6 Protocol

This section defines the EFI UDPv6 (User Datagram Protocol version 6) Protocol that interfaces over the EFI IPv6 Protocol.

## 30.2.1 UDP6 Service Binding Protocol

### EFI\_UDP6\_SERVICE\_BINDING\_PROTOCOL

#### Summary

The EFI UDPv6 Service Binding Protocol is used to locate communication devices that are supported by an EFI UDPv6 Protocol driver and to create and destroy instances of the EFI UDPv6 Protocol child instance that uses the underlying communications device.

#### GUID

```
#define EFI_UDP6_SERVICE_BINDING_PROTOCOL_GUID \
    {0x66ed4721, 0x3c98, 0x4d3e, \
     {0x81, 0xe3, 0xd0, 0x3d, 0xd3, 0x9a, 0x72, 0x54}}
```

#### Description

A network application that requires basic UDPv6 I/O services can use one of the protocol handler services, such as **BS->LocateHandleBuffer()**, to search for devices that publish a EFI UDPv6 Service Binding Protocol GUID. Each device with a published EFI UDPv6 Service Binding Protocol GUID supports the EFI UDPv6 Protocol and may be available for use.

After a successful call to the **EFI\_UDP6\_SERVICE\_BINDING\_PROTOCOL.CreateChild()** function, the newly created child EFI UDPv6 Protocol driver is in an un-configured state; it is not ready to send and receive data packets.

Before a network application terminates execution, every successful call to the **EFI\_UDP6\_SERVICE\_BINDING\_PROTOCOL.CreateChild()** function must be matched with a call to the **EFI\_UDP6\_SERVICE\_BINDING\_PROTOCOL.DestroyChild()** function.

## 30.2.2 EFI UDP6 Protocol

### EFI\_UDP6\_PROTOCOL

#### Summary

The EFI UDPv6 Protocol provides simple packet-oriented services to transmit and receive UDP packets.

## GUID

```
#define EFI_UDP6_PROTOCOL_GUID \
  {0x4f948815, 0xb4b9, 0x43cb, \
   {0x8a, 0x33, 0x90, 0xe0, 0x60, 0xb3, 0x49, 0x55}}
```

## Protocol Interface Structure

```
typedef struct _EFI_UDP6_PROTOCOL {
  EFI_UDP6_GET_MODE_DATA GetModeData;
  EFI_UDP6_CONFIGURE Configure;
  EFI_UDP6_GROUPS Groups;
  EFI_UDP6_TRANSMIT Transmit;
  EFI_UDP6_RECEIVE Receive;
  EFI_UDP6_CANCEL Cancel;
  EFI_UDP6_POLL Poll;
} EFI_UDP6_PROTOCOL;
```

## Parameters

<i>GetModeData</i>	Reads the current operational settings. See the <b>GetModeData()</b> function description.
<i>Configure</i>	Initializes, changes, or resets operational settings for the EFI UDPv6 Protocol. See the <b>Configure()</b> function description.
<i>Groups</i>	Joins and leaves multicast groups. See the <b>Groups()</b> function description.
<i>Transmit</i>	Queues outgoing data packets into the transmit queue. This function is a non-blocked operation. See the <b>Transmit()</b> function description.
<i>Receive</i>	Places a receiving request token into the receiving queue. This function is a non-blocked operation. See the <b>Receive()</b> function description.
<i>Cancel</i>	Aborts a pending transmit or receive request. See the <b>Cancel()</b> function description.
<i>Poll</i>	Polls for incoming data packets and processes outgoing data packets. See the <b>Poll()</b> function description.

## Description

The **EFI\_UDP6\_PROTOCOL** defines an EFI UDPv6 Protocol session that can be used by any network drivers, applications, or daemons to transmit or receive UDP packets. This protocol instance can either be bound to a specified port as a service or connected to some remote peer as an active client. Each instance has its own settings, such as group table, that are independent from each other.

**Note:** *Byte Order:* In this document, all IPv6 addresses and incoming/outgoing packets are stored in network byte order. All other parameters in the functions and data structures that are defined in this document are stored in host byte order.

## EFI\_UDP6\_PROTOCOL.GetModeData()

### Summary

Read the current operational settings.

### Prototype

```

typedef
EFI_STATUS
(EFI_API *EFI_UDP6_GET_MODE_DATA) (
    IN EFI_UDP6_PROTOCOL      *This,
    OUT EFI_UDP6_CONFIG_DATA  *Udp6ConfigData OPTIONAL,
    OUT EFI_IP6_MODE_DATA     *Ip6ModeData  OPTIONAL,
    OUT EFI_MANAGED_NETWORK_CONFIG_DATA *MnpConfigData OPTIONAL,
    OUT EFI_SIMPLE_NETWORK_MODE *SnpModeData OPTIONAL
);

```

### Parameters

<i>This</i>	Pointer to the <b>EFI_UDP6_PROTOCOL</b> instance.
<i>Udp6ConfigData</i>	The buffer in which the current UDP configuration data is returned. Type <b>EFI_UDP6_CONFIG_DATA</b> is defined in "Related Definitions" below.
<i>Ip6ModeData</i>	The buffer in which the current EFI IPv6 Protocol mode data is returned. Type <b>EFI_IP6_MODE_DATA</b> is defined in <b>EFI_IP6_PROTOCOL.GetModeData()</b> .
<i>MnpConfigData</i>	The buffer in which the current managed network configuration data is returned. Type <b>EFI_MANAGED_NETWORK_CONFIG_DATA</b> is defined in <b>EFI_MANAGED_NETWORK_PROTOCOL.GetModeData()</b> .
<i>SnpModeData</i>	The buffer in which the simple network mode data is returned. Type <b>EFI_SIMPLE_NETWORK_MODE</b> is defined in the <b>EFI_SIMPLE_NETWORK</b> Protocol.

### Description

The **GetModeData()** function copies the current operational settings of this EFI UDPv6 Protocol instance into user-supplied buffers. This function is used optionally to retrieve the operational mode data of underlying networks or drivers.

## Related Definition

```

*****
// EFI_UDP6_CONFIG_DATA
//
*****

typedef struct {
//Receiving Filters

    BOOLEAN    AcceptPromiscuous;
    BOOLEAN    AcceptAnyPort;
    BOOLEAN    AllowDuplicatePort;
//I/O parameters
;

    UINT8      TrafficClass;
    UINT8      HopLimit;
;

    UINT32     ReceiveTimeout;
    UINT32     TransmitTimeout;
//Access Point
    EFI_IPv6_ADDRESS StationAddress;
    UINT16     StationPort;
    EFI_IPv6_ADDRESS RemoteAddress;
    UINT16     RemotePort;
} EFI_UDP6_CONFIG_DATA;

```

<i>AcceptPromiscuous</i>	Set to <b>TRUE</b> to accept UDP packets that are sent to any address.
<i>AcceptAnyPort</i>	Set to <b>TRUE</b> to accept UDP packets that are sent to any port.
<i>AllowDuplicatePort</i>	Set to <b>TRUE</b> to allow this EFI UDPv6 Protocol child instance to open a port number that is already being used by another EFI UDPv6 Protocol child instance.
<i>TrafficClass</i>	<i>TrafficClass</i> field in transmitted IPv6 packets.
<i>HopLimit</i>	<i>HopLimit</i> field in transmitted IPv6 packets.
<i>ReceiveTimeout</i>	The receive timeout value (number of microseconds) to be associated with each incoming packet. Zero means do not drop incoming packets.
<i>TransmitTimeout</i>	The transmit timeout value (number of microseconds) to be associated with each outgoing packet. Zero means do not drop outgoing packets.
<i>StationAddress</i>	The station IP address that will be assigned to this EFI UDPv6 Protocol instance. The EFI UDPv6 and EFI IPv6 Protocol drivers will only deliver incoming packets whose destination matches this IP address exactly. Address 0::/

128 is also accepted as a special case. Under this situation, underlying IPv6 driver is responsible for binding a source address to this EFI IPv6 protocol instance according to source address selection algorithm. Only incoming packet from the selected source address is delivered. This field can be set and changed only when the EFI IPv6 driver is transitioning from the stopped to the started states. If no address is available for selecting, the EFI IPv6 Protocol driver will use **EFI\_IP6\_CONFIG\_PROTOCOL** to retrieve the IPv6 address.

#### *StationPort*

The port number to which this EFI UDPv6 Protocol instance is bound. If a client of the EFI UDPv6 Protocol does not care about the port number, set *StationPort* to zero. The EFI UDPv6 Protocol driver will assign a random port number to transmitted UDP packets. Ignored if *AcceptAnyPort* is **TRUE**.

#### *RemoteAddress*

The IP address of remote host to which this EFI UDPv6 Protocol instance is connecting. If *RemoteAddress* is not 0::/128, this EFI UDPv6 Protocol instance will be connected to *RemoteAddress*, i.e., outgoing packets of this EFI UDPv6 Protocol instance will be sent to this address by default and only incoming packets from this address will be delivered to client. Ignored for incoming filtering if *AcceptPromiscuous* is **TRUE**.

#### *RemotePort*

The port number of the remote host to which this EFI UDPv6 Protocol instance is connecting. If it is not zero, outgoing packets of this EFI UDPv6 Protocol instance will be sent to this port number by default and only incoming packets from this port will be delivered to client. Ignored if *RemoteAddress* is 0::/128 and ignored for incoming filtering if *AcceptPromiscuous* is **TRUE**.

## Status Codes Returned

EFI_SUCCESS	The mode data was read.
EFI_NOT_STARTED	When <i>Udp6ConfigData</i> is queried, no configuration data is available because this instance has not been started.
EFI_INVALID_PARAMETER	<i>This</i> is <b>NULL</b> .



## EFI\_UDP6\_PROTOCOL.Configure()

### Summary

Initializes, changes, or resets the operational parameters for this instance of the EFI UDPv6 Protocol.

### Prototype

```
typedef
EFI_STATUS
(EFIAPI *EFI_UDP6_CONFIGURE) (
  IN EFI_UDP6_PROTOCOL *This,
  IN EFI_UDP6_CONFIG_DATA *UdpConfigData OPTIONAL
);
```

### Parameters

<i>This</i>	Pointer to the <b>EFI_UDP6_PROTOCOL</b> instance.
<i>UdpConfigData</i>	Pointer to the buffer contained the configuration data.

### Description

The **Configure()** function is used to do the following:

- Initialize and start this instance of the EFI UDPv6 Protocol.
- Change the filtering rules and operational parameters.
- Reset this instance of the EFI UDPv6 Protocol.

Until these parameters are initialized, no network traffic can be sent or received by this instance. This instance can be also reset by calling **Configure()** with *UdpConfigData* set to **NULL**. Once reset, the receiving queue and transmitting queue are flushed and no traffic is allowed through this instance.

With different parameters in *UdpConfigData*, **Configure()** can be used to bind this instance to specified port.

## Status Codes Returned

EFI_SUCCESS	The configuration settings were set, changed, or reset successfully.
EFI_NO_MAPPING	The underlying IPv6 driver was responsible for choosing a source address for this instance, but no source address was available for use.
EFI_INVALID_PARAMETER	One or more following conditions are <b>TRUE</b> : <i>This is NULL.</i> <i>UdpConfigData.StationAddress</i> neither zero nor one of the configured IP addresses in the underlying IPv6 driver. <i>UdpConfigData.RemoteAddress</i> is not a valid unicast IPv6 address if it is not zero.
EFI_ALREADY_STARTED	The EFI UDPv6 Protocol instance is already started/configured and must be stopped/reset before it can be reconfigured. Only <i>TrafficClass</i> , <i>HopLimit</i> , <i>ReceiveTimeout</i> , and <i>TransmitTimeout</i> can be reconfigured without stopping the current instance of the EFI UDPv6 Protocol.
EFI_ACCESS_DENIED	<i>UdpConfigData.AllowDuplicatePort</i> is <b>FALSE</b> and <i>UdpConfigData.StationPort</i> is already used by other instance.
EFI_OUT_OF_RESOURCES	The EFI UDPv6 Protocol driver cannot allocate memory for this EFI UDPv6 Protocol instance.
EFI_DEVICE_ERROR	An unexpected network or system error occurred and this instance was not opened.

## EFI\_UDP6\_PROTOCOL.Groups()

### Summary

Joins and leaves multicast groups.

### Prototype

```
typedef
EFI_STATUS
(EFI_API *EFI_UDP6_GROUPS) (
  IN EFI_UDP6_PROTOCOL *This,
  IN BOOLEAN JoinFlag,
  IN EFI_IPv6_ADDRESS *MulticastAddress OPTIONAL
);
```

### Parameters

<i>This</i>	Pointer to the <b>EFI_UDP6_PROTOCOL</b> instance.
<i>JoinFlag</i>	Set to <b>TRUE</b> to join a multicast group. Set to <b>FALSE</b> to leave one or all multicast groups.
<i>MulticastAddress</i>	Pointer to multicast group address to join or leave.

### Description

The **Groups()** function is used to join or leave one or more multicast group.

If the *JoinFlag* is **FALSE** and the *MulticastAddress* is **NULL**, then all currently joined groups are left.

### Status Codes Returned

EFI_SUCCESS	The operation completed successfully.
EFI_NOT_STARTED	The EFI UDPv6 Protocol instance has not been started.
EFI_OUT_OF_RESOURCES	Could not allocate resources to join the group.
EFI_INVALID_PARAMETER	One or more of the following conditions is <b>TRUE</b> : <i>This</i> is <b>NULL</b> . <i>JoinFlag</i> is <b>TRUE</b> and <i>MulticastAddress</i> is <b>NULL</b> . <i>JoinFlag</i> is <b>TRUE</b> and <i>*MulticastAddress</i> is not a valid multicast address.
EFI_ALREADY_STARTED	The group address is already in the group table (when <i>JoinFlag</i> is <b>TRUE</b> ).
EFI_NOT_FOUND	The group address is not in the group table (when <i>JoinFlag</i> is <b>FALSE</b> ).
EFI_DEVICE_ERROR	An unexpected system or network error occurred.

## EFI\_UDP6\_PROTOCOL.Transmit()

### Summary

Queues outgoing data packets into the transmit queue.

### Prototype

```
typedef
EFI_STATUS
(EFI_API *EFI_UDP6_TRANSMIT) (
  IN EFI_UDP6_PROTOCOL  *This,
  IN EFI_UDP6_COMPLETION_TOKEN *Token
);
```

### Parameters

<i>This</i>	Pointer to the <b>EFI_UDP6_PROTOCOL</b> instance.
<i>Token</i>	Pointer to the completion token that will be placed into the transmit queue. Type <b>EFI_UDP6_COMPLETION_TOKEN</b> is defined in "Related Definitions" below.

### Description

The **Transmit()** function places a sending request to this instance of the EFI UDPv6 Protocol, alongside the transmit data that was filled by the user. Whenever the packet in the token is sent out or some errors occur, the *Token.Event* will be signaled and *Token.Status* is updated. Providing a proper notification function and context for the event will enable the user to receive the notification and transmitting status.

### Related Definitions

```
/**
//*****
// EFI_UDP6_COMPLETION_TOKEN
//*****
typedef struct {
  EFI_EVENT      Event;
  EFI_STATUS     Status;
  union {
    EFI_UDP6_RECEIVE_DATA  *RxData;
    EFI_UDP6_TRANSMIT_DATA *TxData;
  } Packet;
} EFI_UDP6_COMPLETION_TOKEN;
```

<i>Event</i>	This <i>Event</i> will be signaled after the <i>Status</i> field is updated by the EFI UDPv6 Protocol driver. The type of <i>Event</i> must be <b>EVT_NOTIFY_SIGNAL</b> .
--------------	---

<i>Status</i>	Will be set to one of the following values:
---------------	---

- EFI\_SUCCESS:** The receive or transmit operation completed successfully.
- EFI\_ABORTED:** The receive or transmit was aborted.
- EFI\_TIMEOUT:** The transmit timeout expired.
- EFI\_NETWORK\_UNREACHABLE:** The destination network is unreachable. *RxData* is set to **NULL** in this situation.
- EFI\_HOST\_UNREACHABLE:** The destination host is unreachable. *RxData* is set to **NULL** in this situation.
- EFI\_PROTOCOL\_UNREACHABLE:** The UDP protocol is unsupported in the remote system. *RxData* is set to **NULL** in this situation.
- EFI\_PORT\_UNREACHABLE:** No service is listening on the remote port. *RxData* is set to **NULL** in this situation.
- EFI\_ICMP\_ERROR:** Some other Internet Control Message Protocol (ICMP) error report was received. For example, packets are being sent too fast for the destination to receive them and the destination sent an ICMP source quench report. *RxData* is set to **NULL** in this situation.
- EFI\_DEVICE\_ERROR:** An unexpected system or network error occurred.
- EFI\_SECURITY\_VIOLATION:** The transmit or receive was failed because of IPsec policy check.

*RxData* When this token is used for receiving, *RxData* is a pointer to **EFI\_UDP6\_RECEIVE\_DATA**. Type **EFI\_UDP6\_RECEIVE\_DATA** is defined below.

*TxData* When this token is used for transmitting, *TxData* is a pointer to **EFI\_UDP6\_TRANSMIT\_DATA**. Type **EFI\_UDP6\_TRANSMIT\_DATA** is defined below.

The **EFI\_UDP6\_COMPLETION\_TOKEN** structures are used for both transmit and receive operations.

When used for transmitting, the *Event* and *TxData* fields must be filled in by the EFI UDPv6 Protocol client. After the transmit operation completes, the *Status* field is updated by the EFI UDPv6 Protocol and the *Event* is signaled.

When used for receiving, only the *Event* field must be filled in by the EFI UDPv6 Protocol client. After a packet is received, *RxData* and *Status* are filled in by the EFI UDPv6 Protocol and the *Event* is signaled.

```

//*****
// EFI_UDP6_RECEIVE_DATA
//*****
typedef struct {
    EFI_TIME    TimeStamp;
    EFI_EVENT    RecycleSignal;
    EFI_UDP6_SESSION_DATA    UdpSession;
    UINT32    DataLength;
    UINT32    FragmentCount;
    EFI_UDP6_FRAGMENT_DATA    FragmentTable[1];
} EFI_UDP6_RECEIVE_DATA;

```

<i>TimeStamp</i>	Time when the EFI UDPv6 Protocol accepted the packet. <i>TimeStamp</i> is zero filled if timestamps are disabled or unsupported.
<i>RecycleSignal</i>	Indicates the event to signal when the received data has been processed.
<i>UdpSession</i>	The UDP session data including <i>SourceAddress</i> , <i>SourcePort</i> , <i>DestinationAddress</i> , and <i>DestinationPort</i> . Type <b>EFI_UDP6_SESSION_DATA</b> is defined below.
<i>DataLength</i>	The sum of the fragment data length.
<i>FragmentCount</i>	Number of fragments. Maybe zero.
<i>FragmentTable</i>	Array of fragment descriptors. Maybe zero. Type <b>EFI_UDP6_FRAGMENT_DATA</b> is defined below.

**EFI\_UDP6\_RECEIVE\_DATA** is filled by the EFI UDPv6 Protocol driver when this EFI UDPv6 Protocol instance receives an incoming packet. If there is a waiting token for incoming packets, the *CompletionToken.Packet.RxData* field is updated to this incoming packet and the *CompletionToken.Event* is signaled. The EFI UDPv6 Protocol client must signal the *RecycleSignal* after processing the packet.

*FragmentTable* could contain multiple buffers that are not in the continuous memory locations. The EFI UDPv6 Protocol client might need to combine two or more buffers in *FragmentTable* to form their own protocol header.

```

//*****
// EFI_UDP6_SESSION_DATA
//*****
typedef struct {
    EFI_IPv6_ADDRESS    SourceAddress;
    UINT16    SourcePort;
    EFI_IPv6_ADDRESS    DestinationAddress;
    UINT16    DestinationPort;
} EFI_UDP6_SESSION_DATA;

```

<i>SourceAddress</i>	Address from which this packet is sent. This field should not be used when sending packets.
----------------------	---

<i>SourcePort</i>	Port from which this packet is sent. It is in host byte order. This field should not be used when sending packets.
<i>DestinationAddress</i>	Address to which this packet is sent. When sending packet, it'll be ignored if it is zero.
<i>DestinationPort</i>	Port to which this packet is sent. When sending packet, it'll be ignored if it is zero .

The **EFI\_UDP6\_SESSION\_DATA** is used to retrieve the settings when receiving packets or to override the existing settings (only *DestinationAddress* and *DestinationPort* can be overridden) of this EFI UDPv6 Protocol instance when sending packets.

```

//*****
// EFI_UDP6_FRAGMENT_DATA
//*****
typedef struct {
    UINT32  FragmentLength;
    VOID    *FragmentBuffer;
} EFI_UDP6_FRAGMENT_DATA;

```

<i>FragmentLength</i>	Length of the fragment data buffer.
<i>FragmentBuffer</i>	Pointer to the fragment data buffer.

**EFI\_UDP6\_FRAGMENT\_DATA** allows multiple receive or transmit buffers to be specified. The purpose of this structure is to avoid copying the same packet multiple times.

```

//*****
// EFI_UDP6_TRANSMIT_DATA
//*****
typedef struct {
    EFI_UDP6_SESSION_DATA  *UdpSessionData  ;
    UINT32      DataLength;
    UINT32      FragmentCount;
    EFI_UDP6_FRAGMENT_DATA  FragmentTable[1];
} EFI_UDP6_TRANSMIT_DATA;

```

*UdpSessionData* If not **NULL**, the data that is used to override the transmitting settings. Only the two fields *UdpSessionData.DestinationAddress* and *UdpSessionData.DestinationPort* can be used as the transmitting setting fields. Type **EFI\_UDP6\_SESSION\_DATA** is defined above.

<i>DataLength</i>	Sum of the fragment data length. Must not exceed the maximum UDP packet size.
<i>FragmentCount</i>	Number of fragments.
<i>FragmentTable</i>	Array of fragment descriptors. Type <b>EFI_UDP6_FRAGMENT_DATA</b> is defined above.

The EFI UDPv6 Protocol client must fill this data structure before sending a packet. The packet may contain multiple buffers that may be not in a continuous memory location.

## Status Codes Returned

EFI_SUCCESS	The data has been queued for transmission.
EFI_NOT_STARTED	This EFI UDPv6 Protocol instance has not been started.
EFI_NO_MAPPING	The underlying IPv6 driver was responsible for choosing a source address for this instance, but no source address was available for use.
EFI_INVALID_PARAMETER	<p>One or more of the following are <b>TRUE</b>:</p> <p><i>This is <b>NULL</b>.</i></p> <p><i>Token is <b>NULL</b>.</i></p> <p><i>Token.Event is <b>NULL</b>.</i></p> <p><i>Token.Packet.TxData is <b>NULL</b>.</i></p> <p><i>Token.Packet.TxData.FragmentCount is zero.</i></p> <p><i>Token.Packet.TxData.DataLength is not equal to the sum of fragment lengths.</i></p> <p>One or more of the <i>Token.Packet.TxData.FragmentTable[].FragmentLength</i> fields is zero.</p> <p>One or more of the <i>Token.Packet.TxData.FragmentTable[].FragmentBuffer</i> fields is <b>NULL</b>.</p> <p>Token.Packet.TxData.UdpSessionData.DestinationAddress is not zero and is not valid unicast Ipv6 address if UdpSessionData is not NULL.</p> <p><i>Token.Packet.TxData.UdpSessionData is NULL and this instance's UdpConfigData.RemoteAddress is unspecified.</i></p> <p><i>Token.Packet.TxData.UdpSessionData.DestinationAddress is non-zero when DestinationAddress is configured as non-zero when doing <b>Configure()</b> for this EFI Udp6 protocol instance.</i></p> <p><i>Token.Packet.TxData.UdpSessionData.DestinationAddress is zero when DestinationAddress is unspecified when doing <b>Configure()</b> for this EFI Udp6 protocol instance</i></p>
EFI_ACCESS_DENIED	The transmit completion token with the same <i>Token.Event</i> was already in the transmit queue.



EFI_NOT_READY	The completion token could not be queued because the transmit queue is full.
EFI_OUT_OF_RESOURCES	Could not queue the transmit data.
EFI_NOT_FOUND	There is no route to the destination network or address.
EFI_BAD_BUFFER_SIZE	The data length is greater than the maximum UDP packet size.
EFI_NO_MEDIA	There was a media error.

## EFI\_UDP6\_PROTOCOL.Receive()

### Summary

Places an asynchronous receive request into the receiving queue.

### Prototype

```
typedef
EFI_STATUS
(EFIAPI *EFI_UDP6_RECEIVE) (
    IN EFI_UDP6_PROTOCOL *This,
    IN EFI_UDP6_COMPLETION_TOKEN *Token
);
```

### Parameters

<i>This</i>	Pointer to the <b>EFI_UDP6_PROTOCOL</b> instance.
<i>Token</i>	Pointer to a token that is associated with the receive data descriptor. Type <b>EFI_UDP6_COMPLETION_TOKEN</b> is defined in <b>EFI_UDP6_PROTOCOL.Transmit()</b> .

### Description

The **Receive()** function places a completion token into the receive packet queue. This function is always asynchronous.

The caller must fill in the **Token.Event** field in the completion token, and this field cannot be **NULL**. When the receive operation completes, the EFI UDPv6 Protocol driver updates the *Token.Status* and *Token.Packet.RxData* fields and the *Token.Event* is signaled. Providing a proper notification function and context for the event will enable the user to receive the notification and receiving status. That notification function is guaranteed to not be re-entered.

### Status Codes Returned

EFI_SUCCESS	The receive completion token was cached.
EFI_NOT_STARTED	This EFI UDPv6 Protocol instance has not been started.
EFI_NO_MAPPING	The underlying IPv6 driver was responsible for choosing a source address for this instance, but no source address was available for use.
EFI_INVALID_PARAMETER	One or more of the following conditions is <b>TRUE</b> : <i>This</i> is <b>NULL</b> . <i>Token</i> is <b>NULL</b> . <i>Token.Event</i> is <b>NULL</b> .
EFI_OUT_OF_RESOURCES	The receive completion token could not be queued due to a lack of system resources (usually memory).
EFI_DEVICE_ERROR	An unexpected system or network error occurred. The EFI UDPv6 Protocol instance has been reset to startup defaults.
EFI_ACCESS_DENIED	A receive completion token with the same <i>Token.Event</i> was already in the receive queue.

EFI_NOT_READY	The receive request could not be queued because the receive queue is full.
EFI_NO_MEDIA	There was a media error.

## EFI\_UDP6\_PROTOCOL.Cancel()

### Summary

Aborts an asynchronous transmit or receive request.

### Prototype

```
typedef
EFI_STATUS
(EFI_API *EFI_UDP6_CANCEL)(
    IN EFI_UDP6_PROTOCOL *This,
    IN EFI_UDP6_COMPLETION_TOKEN *Token OPTIONAL
);
```

### Parameters

<i>This</i>	Pointer to the <b>EFI_UDP6_PROTOCOL</b> instance.
<i>Token</i>	Pointer to a token that has been issued by <b>EFI_UDP6_PROTOCOL.Transmit()</b> or <b>EFI_UDP6_PROTOCOL.Receive()</b> . If <b>NULL</b> , all pending tokens are aborted. Type <b>EFI_UDP6_COMPLETION_TOKEN</b> is defined in <b>EFI_UDP6_PROTOCOL.Transmit()</b> .

### Description

The **Cancel()** function is used to abort a pending transmit or receive request. If the token is in the transmit or receive request queues, after calling this function, *Token.Status* will be set to **EFI\_ABORTED** and then *Token.Event* will be signaled. If the token is not in one of the queues, which usually means that the asynchronous operation has completed, this function will not signal the token and **EFI\_NOT\_FOUND** is returned.

### Status Codes Returned

EFI_SUCCESS	The asynchronous I/O request was aborted and <i>Token.Event</i> was signaled. When <i>Token</i> is <b>NULL</b> , all pending requests are aborted and their events are signaled.
EFI_INVALID_PARAMETER	<i>This</i> is <b>NULL</b> .
EFI_NOT_STARTED	This instance has not been started.
EFI_NOT_FOUND	When <i>Token</i> is not <b>NULL</b> , the asynchronous I/O request was not found in the transmit or receive queue. It has either completed or was not issued by <b>Transmit()</b> and <b>Receive()</b> .

## EFI\_UDP6\_PROTOCOL.Poll()

### Summary

Polls for incoming data packets and processes outgoing data packets.

### Prototype

```
typedef
EFI_STATUS
(EFIAPI *EFI_UDP6_POLL) (
    IN EFI_UDP6_PROTOCOL *This
);
```

### Parameters

*This*

Pointer to the **EFI\_UDP6\_PROTOCOL** instance.

### Description

The **Poll()** function can be used by network drivers and applications to increase the rate that data packets are moved between the communications device and the transmit and receive queues.

In some systems, the periodic timer event in the managed network driver may not poll the underlying communications device fast enough to transmit and/or receive all data packets without missing incoming packets or dropping outgoing packets. Drivers and applications that are experiencing packet loss should try calling the **Poll()** function more often.

### Status Codes Returned

EFI_SUCCESS	Incoming or outgoing data was processed.
EFI_INVALID_PARAMETER	<i>This</i> is <b>NULL</b> .
EFI_DEVICE_ERROR	An unexpected system or network error occurred.
EFI_TIMEOUT	Data was dropped out of the transmit and/or receive queue. Consider increasing the polling rate.

## 30.3 EFI MTFTPv4 Protocol

The following sections defines the EFI MTFTPv4 Protocol interface that is built upon the EFI UDPv4 Protocol.

### EFI\_MTFTP4\_SERVICE\_BINDING\_PROTOCOL

#### Summary

The EFI MTFTPv4 Service Binding Protocol is used to locate communication devices that are supported by an EFI MTFTPv4 Protocol driver and to create and destroy instances of

the EFI MTFTPv4 Protocol child protocol driver that can use the underlying communications device.

## GUID

```
#define EFI_MTFTP4_SERVICE_BINDING_PROTOCOL_GUID \
{0x2e800be,0x8f01,0x4aa6,\
{0x94,0x6b,0xd7,0x13,0x88,0xe1,0x83,0x3f}}
```

## Description

A network application or driver that requires MTFTPv4 I/O services can use one of the protocol handler services, such as **BS->LocateHandleBuffer()**, to search for devices that publish an EFI MTFTPv4 Service Binding Protocol GUID. Each device with a published EFI MTFTPv4 Service Binding Protocol GUID supports the EFI MTFTPv4 Protocol service and may be available for use.

After a successful call to the **EFI\_MTFTP4\_SERVICE\_BINDING\_PROTOCOL.CreateChild()** function, the newly created child EFI MTFTPv4 Protocol driver instance is in an unconfigured state; it is not ready to transfer data.

Before a network application terminates execution, every successful call to the **EFI\_MTFTP4\_SERVICE\_BINDING\_PROTOCOL.CreateChild()** function must be matched with a call to the **EFI\_MTFTP4\_SERVICE\_BINDING\_PROTOCOL.DestroyChild()** function.

Each instance of the EFI MTFTPv4 Protocol driver can support one file transfer operation at a time. To download two files at the same time, two instances of the EFI MTFTPv4 Protocol driver will need to be created.

## EFI\_MTFTP4\_PROTOCOL

### Summary

The EFI MTFTPv4 Protocol provides basic services for client-side unicast and/or multicast TFTP operations.

## GUID

```
#define EFI_MTFTP4_PROTOCOL_GUID \
{0x78247c57,0x63db,0x4708,\
{0x99,0xc2,0xa8,0xb4,0xa9,0xa6,0x1f,0x6b}}
```

## Protocol Interface Structure

```
typedef struct _EFI_MTFTP4_PROTOCOL {
  EFI_MTFTP4_GET_MODE_DATA  GetModeData;
  EFI_MTFTP4_CONFIGURE      Configure;
  EFI_MTFTP4_GET_INFO       GetInfo;
  EFI_MTFTP4_PARSE_OPTIONS  ParseOptions;
  EFI_MTFTP4_READ_FILE      ReadFile;
  EFI_MTFTP4_WRITE_FILE     WriteFile;
  EFI_MTFTP4_READ_DIRECTORY ReadDirectory;
  EFI_MTFTP4_POLL           Poll;
} EFI_MTFTP4_PROTOCOL;
```

## Parameters

<i>GetModeData</i>	Reads the current operational settings. See the <b>GetModeData()</b> function description.
<i>Configure</i>	Initializes, changes, or resets the operational settings for this instance of the EFI MTFTPv4 Protocol driver. See the <b>Configure()</b> function description.
<i>GetInfo</i>	Retrieves information about a file from an MTFTPv4 server. See the <b>GetInfo()</b> function description.
<i>ParseOptions</i>	Parses the options in an MTFTPv4 OACK (options acknowledgement) packet. See the <b>ParseOptions()</b> function description.
<i>ReadFile</i>	Downloads a file from an MTFTPv4 server. See the <b>ReadFile()</b> function description.
<i>WriteFile</i>	Uploads a file to an MTFTPv4 server. This function may be unsupported in some EFI implementations. See the <b>WriteFile()</b> function description.
<i>ReadDirectory</i>	Downloads a related file “directory” from an MTFTPv4 server. This function may be unsupported in some EFI implementations. See the <b>ReadDirectory()</b> function description.
<i>Poll</i>	Polls for incoming data packets and processes outgoing data packets. See the <b>Poll()</b> function description.

## Description

The **EFI\_MTFTP4\_PROTOCOL** is designed to be used by UEFI drivers and applications to transmit and receive data files. The EFI MTFTPv4 Protocol driver uses the underlying EFI UDPv4 Protocol driver and EFI IPv4 Protocol driver.

## EFI\_MTFTP4\_PROTOCOL.GetModeData()

### Summary

Reads the current operational settings.

### Prototype

```
typedef
EFI_STATUS
(EFI_API *EFI_MTFTP4_GET_MODE_DATA)(
  IN EFI_MTFTP4_PROTOCOL *This,
  OUT EFI_MTFTP4_MODE_DATA *ModeData
);
```

### Parameters

<i>This</i>	Pointer to the <b>EFI_MTFTP4_PROTOCOL</b> instance.
<i>ModeData</i>	Pointer to storage for the EFI MTFTPv4 Protocol driver mode data. Type <b>EFI_MTFTP4_MODE_DATA</b> is defined in “Related Definitions” below.

### Description

The **GetModeData()** function reads the current operational settings of this EFI MTFTPv4 Protocol driver instance.

### Related Definitions

```
/**
*****
// EFI_MTFTP4_MODE_DATA
*****
typedef struct {
  EFI_MTFTP4_CONFIG_DATA ConfigData;
  UINT8 SupportedOptionCount;
  UINT8 **SupportedOptions;
  UINT8 UnsupportedOptionCount;
  UINT8 **UnsupportedOptions;
} EFI_MTFTP4_MODE_DATA;
```

<i>ConfigData</i>	The configuration data of this instance. Type <b>EFI_MTFTP4_CONFIG_DATA</b> is defined below.
<i>SupportedOptionCount</i>	The number of option strings in the following <i>SupportedOptions</i> array.
<i>SupportedOptions</i>	An array of pointers to null-terminated ASCII option strings that are recognized and supported by this EFI MTFTPv4 Protocol driver implementation.
<i>UnsupportedOptionCount</i>	An array of pointers to null-terminated ASCII option



strings that are recognized but not supported by this EFI MTFTPv4 Protocol driver implementation.

### *UnsupportedOptions*

An array of option strings that are recognized but are not supported by this EFI MTFTPv4 Protocol driver implementation.

The **EFI\_MTFTP4\_MODE\_DATA** structure describes the operational state of this instance.

```

//*****
// EFI_MTFTP4_CONFIG_DATA
//*****
typedef struct {
    BOOLEAN    UseDefaultSetting;
    EFI_IPv4_ADDRESS StationIp;
    EFI_IPv4_ADDRESS SubnetMask;
    UINT16     LocalPort;
    EFI_IPv4_ADDRESS GatewayIp;
    EFI_IPv4_ADDRESS ServerIp;
    UINT16     InitialServerPort;
    UINT16     TryCount;
    UINT16     TimeoutValue;
} EFI_MTFTP4_CONFIG_DATA;

```

<i>UseDefaultSetting</i>	Set to <b>TRUE</b> to use the default station address/subnet mask and the default route table information.
<i>StationIp</i>	If <i>UseDefaultSetting</i> is <b>FALSE</b> , indicates the station address to use.
<i>SubnetMask</i>	If <i>UseDefaultSetting</i> is <b>FALSE</b> , indicates the subnet mask to use.
<i>LocalPort</i>	Local port number. Set to zero to use the automatically assigned port number.
<i>GatewayIp</i>	if <i>UseDefaultSetting</i> is <b>FALSE</b> , indicates the gateway IP address to use.
<i>ServerIp</i>	The IP address of the MTFTPv4 server.
<i>InitialServerPort</i>	The initial MTFTPv4 server port number. Request packets are sent to this port. This number is almost always 69 and using zero defaults to 69.
<i>TryCount</i>	The number of times to transmit MTFTPv4 request packets and wait for a response.
<i>TimeoutValue</i>	The number of seconds to wait for a response after sending the MTFTPv4 request packet.

The **EFI\_MTFTP4\_CONFIG\_DATA** structure is used to report and change MTFTPv4 session parameters.

## Status Codes Returned

EFI_SUCCESS	The configuration data was successfully returned.
EFI_OUT_OF_RESOURCES	The required mode data could not be allocated.
EFI_INVALID_PARAMETER	<i>This is <b>NULL</b> or <i>ModeData</i> is <b>NULL</b>.</i>

## EFI\_MTFTP4\_PROTOCOL.Configure()

### Summary

Initializes, changes, or resets the default operational setting for this EFI MTFTPv4 Protocol driver instance.

### Prototype

```
typedef
EFI_STATUS
(EFIAPI *EFI_MTFTP4_CONFIGURE)(
  IN EFI_MTFTP4_PROTOCOL *This,
  IN EFI_MTFTP4_CONFIG_DATA *MtftpConfigData OPTIONAL
);
```

### Parameters

<i>This</i>	Pointer to the <b>EFI_MTFTP4_PROTOCOL</b> instance.
<i>MtftpConfigData</i>	Pointer to the configuration data structure. Type <b>EFI_MTFTP4_CONFIG_DATA</b> is defined in <b>EFI_MTFTP4_PROTOCOL.GetModeData()</b> .

### Description

The **Configure()** function is used to set and change the configuration data for this EFI MTFTPv4 Protocol driver instance. The configuration data can be reset to startup defaults by calling **Configure()** with *MtftpConfigData* set to **NULL**. Whenever the instance is reset, any pending operation is aborted. By changing the EFI MTFTPv4 Protocol driver instance configuration data, the client can connect to different MTFTPv4 servers. The configuration parameters in *MtftpConfigData* are used as the default parameters in later MTFTPv4 operations and can be overridden in later operations.

### Status Codes Returned

EFI_SUCCESS	The EFI MTFTPv4 Protocol driver was configured successfully.
EFI_INVALID_PARAMETER	One or more following conditions are <b>TRUE</b> : <ul style="list-style-type: none"> <li><i>This</i> is <b>NULL</b>.</li> <li><i>MtftpConfigData.UseDefaultSetting</i> is <b>FALSE</b> and <i>MtftpConfigData.StationIp</i> is not a valid IPv4 unicast address.</li> <li><i>MtftpCofigData.UseDefaultSetting</i> is <b>FALSE</b> and <i>MtftpConfigData.SubnetMask</i> is invalid.</li> <li><i>MtftpCofigData.ServerIp</i> is not a valid IPv4 unicast address.</li> <li><i>MtftpConfigData.UseDefaultSetting</i> is <b>FALSE</b> and <i>MtftpConfigData.GatewayIp</i> is not a valid IPv4 unicast address or is not in the same subnet with station address.</li> </ul>
EFI_ACCESS_DENIED	The EFI configuration could not be changed at this time because there is one MTFTP background operation in progress.

EFI_NO_MAPPING	When using a default address, configuration (DHCP, BOOTP, RARP, etc.) has not finished yet.
EFI_UNSUPPORTED	A configuration protocol (DHCP, BOOTP, RARP, etc.) could not be located when clients choose to use the default address settings.
EFI_OUT_OF_RESOURCES	The EFI MTFTPv4 Protocol driver instance data could not be allocated.
EFI_DEVICE_ERROR	An unexpected system or network error occurred. The EFI MTFTPv4 Protocol driver instance is not configured.

## EFI\_MTFTP4\_PROTOCOL.GetInfo()

### Summary

Gets information about a file from an MTFTPv4 server.

### Prototype

```
typedef
EFI_STATUS
(EFIAPI *EFI_MTFTP4_GET_INFO)(
  IN EFI_MTFTP4_PROTOCOL  *This,
  IN EFI_MTFTP4_OVERRIDE_DATA *OverrideData OPTIONAL,
  IN UINT8      *Filename,
  IN UINT8      *ModeStr  OPTIONAL,
  IN UINT8      OptionCount,
  IN EFI_MTFTP4_OPTION *OptionList OPTIONAL,
  OUT UINT32      *PacketLength,
  OUT EFI_MTFTP4_PACKET **Packet  OPTIONAL
);
```

### Parameters

<i>This</i>	Pointer to the <b>EFI_MTFTP4_PROTOCOL</b> instance.
<i>OverrideData</i>	Data that is used to override the existing parameters. If <b>NULL</b> , the default parameters that were set in the <b>EFI_MTFTP4_PROTOCOL.Configure()</b> function are used. Type <b>EFI_MTFTP4_OVERRIDE_DATA</b> is defined in “Related Definitions” below.
<i>Filename</i>	Pointer to a null-terminated ASCII file name string.
<i>ModeStr</i>	Pointer to a null-terminated ASCII mode string. If <b>NULL</b> , “octet” will be used.
<i>OptionCount</i>	Number of option/value string pairs in <i>OptionList</i> .
<i>OptionList</i>	Pointer to array of option/value string pairs. Ignored if <i>OptionCount</i> is zero. Type <b>EFI_MTFTP4_OPTION</b> is defined in “Related Definitions” below.
<i>PacketLength</i>	The number of bytes in the returned packet.
<i>Packet</i>	The pointer to the received packet. This buffer must be freed by the caller. Type <b>EFI_MTFTP4_PACKET</b> is defined in “Related Definitions” below.

### Description

The **GetInfo()** function assembles an MTFTPv4 request packet with options; sends it to the MTFTPv4 server; and may return an MTFTPv4 OACK, MTFTPv4 ERROR, or ICMP ERROR packet. Retries occur only if no response packets are received from the MTFTPv4 server before the timeout expires.

## Related Definitions

```

//*****
// EFI_MTFTP_OVERRIDE_DATA
//*****
typedef struct {
  EFI_IPv4_ADDRESS GatewayIp;
  EFI_IPv4_ADDRESS ServerIp;
  UINT16   ServerPort;
  UINT16   TryCount;
  UINT16   TimeoutValue;
} EFI_MTFTP4_OVERRIDE_DATA;

```

<i>GatewayIp</i>	IP address of the gateway. If set to 0.0.0.0, the default gateway address that was set by the <b>EFI_MTFTP4_PROTOCOL.Configure()</b> function will not be overridden.
<i>ServerIp</i>	IP address of the MTFTIPv4 server. If set to 0.0.0.0, it will use the value that was set by the <b>EFI_MTFTP4_PROTOCOL.Configure()</b> function.
<i>ServerPort</i>	MTFTIPv4 server port number. If set to zero, it will use the value that was set by the <b>EFI_MTFTP4_PROTOCOL.Configure()</b> function.
<i>TryCount</i>	Number of times to transmit MTFTIPv4 request packets and wait for a response. If set to zero, it will use the value that was set by the <b>EFI_MTFTP4_PROTOCOL.Configure()</b> function.
<i>TimeoutValue</i>	Number of seconds to wait for a response after sending the MTFTIPv4 request packet. If set to zero, it will use the value that was set by the <b>EFI_MTFTP4_PROTOCOL.Configure()</b> function.

The **EFI\_MTFTP4\_OVERRIDE\_DATA** structure is used to override the existing parameters that were set by the **EFI\_MTFTP4\_PROTOCOL.Configure()** function.

```

//*****
// EFI_MTFTP4_OPTION
//*****
typedef struct {
  UINT8   *OptionStr;
  UINT8   *ValueStr;
} EFI_MTFTP4_OPTION;

```

<i>OptionStr</i>	Pointer to the null-terminated ASCII MTFTIPv4 option string.
<i>ValueStr</i>	Pointer to the null-terminated ASCII MTFTIPv4 value string.

```

#pragma pack(1)

//*****
// EFI_MTFTP4_PACKET
//*****
typedef union {
    UINT16    OpCode;
    EFI_MTFTP4_REQ_HEADER  Rrq, Wrq;
    EFI_MTFTP4_OACK_HEADER Oack;
    EFI_MTFTP4_DATA_HEADER Data;
    EFI_MTFTP4_ACK_HEADER  Ack;
    // This field should be ignored and treated as reserved
    EFI_MTFTP4_DATA8_HEADER Data8;
    // This field should be ignored and treated as reserved
    EFI_MTFTP4_ACK8_HEADER  Ack8;
    EFI_MTFTP4_ERROR_HEADER Error;
} EFI_MTFTP4_PACKET;

//*****
// EFI_MTFTP4_REQ_HEADER
//*****
typedef struct {
    UINT16 OpCode;
    UINT8  Filename[1];
} EFI_MTFTP4_REQ_HEADER;

//*****
// EFI_MTFTP4_OACK_HEADER
//*****
typedef struct {
    UINT16 OpCode;
    UINT8  Data[1];
} EFI_MTFTP4_OACK_HEADER;

//*****
// EFI_MTFTP4_DATA_HEADER
//*****
typedef struct {
    UINT16 OpCode;
    UINT16 Block;
    UINT8  Data[1];
} EFI_MTFTP4_DATA_HEADER;

//*****
// EFI_MTFTP4_ACK_HEADER
//*****
typedef struct {

```

```

    UINT16 OpCode;
    UINT16 Block[1];
} EFI_MTFTP4_ACK_HEADER;

//*****
// EFI_MTFTP4_DATA8_HEADER
// This field should be ignored and treated as reserved
//*****
typedef struct {
    UINT16 OpCode;
    UINT64 Block;
    UINT8 Data[1];
} EFI_MTFTP4_DATA8_HEADER;

//*****
// EFI_MTFTP4_ACK8_HEADER
// This field should be ignored and treated as reserved
//*****
typedef struct {
    UINT16 OpCode;
    UINT64 Block[1];
} EFI_MTFTP4_ACK8_HEADER;

//*****
// EFI_MTFTP4_ERROR_HEADER
//*****
typedef struct {
    UINT16 OpCode;
    UINT16 ErrorCode;
    UINT8 ErrorMessage[1];
} EFI_MTFTP4_ERROR_HEADER;

#pragma pack()

```

[Table 198](#) below describes the parameters that are listed in the MTFTPv4 packet structure definitions above. All the above structures are byte packed. The pragmas may vary from compiler to compiler. The MTFTPv4 packet structures are also used by the following functions:

- `EFI_MTFTP4_PROTOCOL.ReadFile()`
- `EFI_MTFTP4_PROTOCOL.WriteFile()`
- `EFI_MTFTP4_PROTOCOL.ReadDirectory()`
- The EFI MTFTPv4 Protocol packet check callback functions

**Note:** *Both incoming and outgoing MTFTPv4 packets are in network byte order. All other parameters defined in functions or data structures are stored in host byte order.*



Table 198. Descriptions of Parameters in MTFTPV4 Packet Structures

Data Structure	Parameter	Description
<b>EFI_MTFTP4_PACKET</b>	OpCode	Type of packets as defined by the MTFTPV4 packet opcodes. Opcode values are defined below.
	Rrq, Wrq	Read request or write request packet header. See the description for <b>EFI_MTFTP4_REQ_HEADER</b> below in this table.
	Oack	Option acknowledge packet header. See the description for <b>EFI_MTFTP4_OACK_HEADER</b> below in this table.
	Data	Data packet header. See the description for <b>EFI_MTFTP4_DATA_HEADER</b> below in this table.
	Ack	Acknowledgement packet header. See the description for <b>EFI_MTFTP4_ACK_HEADER</b> below in this table.
	Data8	This field should be ignored and treated as reserved.  Data packet header with big block number. See the description for <b>EFI_MTFTP4_DATA8_HEADER</b> below in this table.
	Ack8	This field should be ignored and treated as reserved.  Acknowledgement header with big block number. See the description for <b>EFI_MTFTP4_ACK8_HEADER</b> below in this table.
	Error	Error packet header. See the description for <b>EFI_MTFTP4_ERROR_HEADER</b> below in this table.
<b>EFI_MTFTP4_REQ_HEADER</b>	OpCode	For this packet type, <i>OpCode</i> = <b>EFI_MTFTP4_OPCODE_RRQ</b> for a read request or <i>OpCode</i> = <b>EFI_MTFTP4_OPCODE_WRQ</b> for a write request.
	Filename	The file name to be downloaded or uploaded.

Data Structure	Parameter	Description
<b>EFI_MTFTP4_OACK_HEADER</b>	OpCode	For this packet type, <i>OpCode</i> = <b>EFI_MTFTP4_OPCODE_OACK</b> .
	Data	The option strings in the option acknowledgement packet.
<b>EFI_MTFTP4_DATA_HEADER</b>	OpCode	For this packet type, <i>OpCode</i> = <b>EFI_MTFTP4_OPCODE_DATA</b> .
	Block	Block number of this data packet.
	Data	The content of this data packet.
<b>EFI_MTFTP4_ACK_HEADER</b>	OpCode	For this packet type, <i>OpCode</i> = <b>EFI_MTFTP4_OPCODE_ACK</b> .
	Block	The block number of the data packet that is being acknowledged.
<b>EFI_MTFTP4_DATA8_HEADER</b>	OpCode	This field should be ignored and treated as reserved.  For this packet type, <i>OpCode</i> = <b>EFI_MTFTP4_OPCODE_DATA8</b> .
	Block	This field should be ignored and treated as reserved.  The block number of data packet.
	Data	This field should be ignored and treated as reserved.  The content of this data packet.
<b>EFI_MTFTP4_ACK8_HEADER</b>	OpCode	This field should be ignored and treated as reserved.  For this packet type, <i>OpCode</i> = <b>EFI_MTFTP4_OPCODE_ACK8</b> .
	Block	This field should be ignored and treated as reserved.  The block number of the data packet that is being acknowledged.
<b>EFI_MTFTP4_ERROR_HEADER</b>	OpCode	For this packet type, <i>OpCode</i> = <b>EFI_MTFTP4_OPCODE_ERROR</b> .
	ErrorCode	The error number as defined by the MTFTPv4 packet error codes. Values for <i>ErrorCode</i> are defined below.
	ErrorMessage	Error message string.

```

//
// MTFTP Packet OpCodes
//
#define EFI_MTFTP4_OPCODE_RRQ  1
#define EFI_MTFTP4_OPCODE_WRQ  2
#define EFI_MTFTP4_OPCODE_DATA  3
#define EFI_MTFTP4_OPCODE_ACK  4
#define EFI_MTFTP4_OPCODE_ERROR 5
#define EFI_MTFTP4_OPCODE_OACK 6
#define EFI_MTFTP4_OPCODE_DIR  7
//This field should be ignored and treated as reserved.
#define EFI_MTFTP4_OPCODE_DATA8 8
//This field should be ignored and treated as reserved.
#define EFI_MTFTP4_OPCODE_ACK8  9

```

Following is a description of the fields in the above definition.

<i>EFI_MTFTP4_OPCODE_RRQ</i>	The MTFTPv4 packet is a read request.
<i>EFI_MTFTP4_OPCODE_WRQ</i>	The MTFTPv4 packet is a write request.
<i>EFI_MTFTP4_OPCODE_DATA</i>	The MTFTPv4 packet is a data packet.
<i>EFI_MTFTP4_OPCODE_ACK</i>	The MTFTPv4 packet is an acknowledgement packet.
<i>EFI_MTFTP4_OPCODE_ERROR</i>	The MTFTPv4 packet is an error packet.
<i>EFI_MTFTP4_OPCODE_OACK</i>	The MTFTPv4 packet is an option acknowledgement packet.
<i>EFI_MTFTP4_OPCODE_DIR</i>	The MTFTPv4 packet is a directory query packet.
<i>EFI_MTFTP4_OPCODE_DATA8</i>	This field should be ignored and treated as reserved.  The MTFTPv4 packet is a data packet with a big block number.
<i>EFI_MTFTP4_OPCODE_ACK8</i>	This field should be ignored and treated as reserved.  The MTFTPv4 packet is an acknowledgement packet with a big block number.

```
//
// MTFTP ERROR Packet ErrorCodes
//
#define EFI_MTFTP4_ERRORCODE_NOT_DEFINED    0
#define EFI_MTFTP4_ERRORCODE_FILE_NOT_FOUND 1
#define EFI_MTFTP4_ERRORCODE_ACCESS_VIOLATION 2
#define EFI_MTFTP4_ERRORCODE_DISK_FULL     3
#define EFI_MTFTP4_ERRORCODE_ILLEGAL_OPERATION 4
#define EFI_MTFTP4_ERRORCODE_UNKNOWN_TRANSFER_ID 5
#define EFI_MTFTP4_ERRORCODE_FILE_ALREADY_EXISTS 6
#define EFI_MTFTP4_ERRORCODE_NO_SUCH_USER   7
#define EFI_MTFTP4_ERRORCODE_REQUEST_DENIED 8
```

<i>EFI_MTFTP4_ERRORCODE_NOT_DEFINED</i>	The error code is not defined. See the error message in the packet (if any) for details.
<i>EFI_MTFTP4_ERRORCODE_FILE_NOT_FOUND</i>	The file was not found.
<i>EFI_MTFTP4_ERRORCODE_ACCESS_VIOLATION</i>	There was an access violation.
<i>EFI_MTFTP4_ERRORCODE_DISK_FULL</i>	The disk was full or its allocation was exceeded.
<i>EFI_MTFTP4_ERRORCODE_ILLEGAL_OPERATION</i>	The MTFTPv4 operation was illegal.
<i>EFI_MTFTP4_ERRORCODE_UNKNOWN_TRANSFER_ID</i>	The transfer ID is unknown.
<i>EFI_MTFTP4_ERRORCODE_FILE_ALREADY_EXISTS</i>	The file already exists.
<i>EFI_MTFTP4_ERRORCODE_NO_SUCH_USER</i>	There is no such user.
<i>EFI_MTFTP4_ERRORCODE_REQUEST_DENIED</i>	The request has been denied due to option negotiation.

## Status Codes Returned

EFI_SUCCESS	An MTFTPv4 OACK packet was received and is in the <i>Packet</i> .
EFI_INVALID_PARAMETER	One or more of the following conditions is <b>TRUE</b> : <ul style="list-style-type: none"> <li>• <i>This</i> is <b>NULL</b>.</li> <li>• <i>Filename</i> is <b>NULL</b>.</li> <li>• <i>OptionCount</i> is not zero and <i>OptionList</i> is <b>NULL</b>.</li> <li>• One or more options in <i>OptionList</i> have wrong format.</li> <li>• <i>PacketLength</i> is <b>NULL</b>.</li> <li>• One or more IPv4 addresses in <i>OverrideData</i> are not valid unicast IPv4 addresses if <i>OverrideData</i> is not <b>NULL</b> and the addresses are not set to all zero.</li> </ul>

EFI_UNSUPPORTED	<ul style="list-style-type: none"> <li>One or more options in the <i>OptionList</i> are in the unsupported list of structure <b>EFI_MTFTP4_MODE_DATA</b>.</li> </ul>
EFI_NOT_STARTED	The EFI MTFTPv4 Protocol driver has not been started.
EFI_NO_MAPPING	When using a default address, configuration (DHCP, BOOTP, RARP, etc.) has not finished yet.
EFI_ACCESS_DENIED	The previous operation has not completed yet.
EFI_OUT_OF_RESOURCES	Required system resources could not be allocated.
EFI_TFTP_ERROR	An MTFTPv4 ERROR packet was received and is in the <i>Packet</i> .
EFI_NETWORK_UNREACHABLE	An ICMP network unreachable error packet was received and the <i>Packet</i> is set to <b>NULL</b> .
EFI_HOST_UNREACHABLE	An ICMP host unreachable error packet was received and the <i>Packet</i> is set to <b>NULL</b> .
EFI_PROTOCOL_UNREACHABLE	An ICMP protocol unreachable error packet was received and the <i>Packet</i> is set to <b>NULL</b> .
EFI_PORT_UNREACHABLE	An ICMP port unreachable error packet was received and the <i>Packet</i> is set to <b>NULL</b> .
EFI_ICMP_ERROR	Some other ICMP ERROR packet was received and the <i>Packet</i> is set to <b>NULL</b> .
EFI_PROTOCOL_ERROR	An unexpected MTFTPv4 packet was received and is in the <i>Packet</i> .
EFI_TIMEOUT	No responses were received from the MTFTPv4 server.
EFI_DEVICE_ERROR	An unexpected network error or system error occurred.
EFI_NO_MEDIA	There was a media error.

## EFI\_MTFTP4\_PROTOCOL.ParseOptions()

### Summary

Parses the options in an MTFTPv4 OACK packet.

### Prototype

```
typedef
EFI_STATUS
(EFI_API *EFI_MTFTP4_PARSE_OPTIONS)(
  IN EFI_MTFTP4_PROTOCOL *This,
  IN UINT32 PacketLen,
  IN EFI_MTFTP4_PACKET *Packet,
  OUT UINT32 *OptionCount,
  OUT EFI_MTFTP4_OPTION **OptionList OPTIONAL
);
```

### Parameters

<i>This</i>	Pointer to the <b>EFI_MTFTP4_PROTOCOL</b> instance.
<i>PacketLen</i>	Length of the OACK packet to be parsed.
<i>Packet</i>	Pointer to the OACK packet to be parsed. Type <b>EFI_MTFTP4_PACKET</b> is defined in <b>EFI_MTFTP4_PROTOCOL.GetInfo()</b> .
<i>OptionCount</i>	Pointer to the number of options in following <i>OptionList</i> .
<i>OptionList</i>	Pointer to <b>EFI_MTFTP4_OPTION</b> storage. Call the EFI Boot Service <b>FreePool()</b> to release the <i>OptionList</i> if the options in this <i>OptionList</i> are not needed any more. Type <b>EFI_MTFTP4_OPTION</b> is defined in <b>EFI_MTFTP4_PROTOCOL.GetInfo()</b> .

### Description

The **ParseOptions()** function parses the option fields in an MTFTPv4 OACK packet and returns the number of options that were found and optionally a list of pointers to the options in the packet.

If one or more of the option fields are not valid, then **EFI\_PROTOCOL\_ERROR** is returned and *\*OptionCount* and *\*OptionList* stop at the last valid option.

### Status Codes Returned

EFI_SUCCESS	The OACK packet was valid and the <i>OptionCount</i> and <i>OptionList</i> parameters have been updated.
EFI_INVALID_PARAMETER	One or more of the following conditions is <b>TRUE</b> : <ul style="list-style-type: none"> <li><i>PacketLen</i> is 0.</li> <li><i>Packet</i> is <b>NULL</b> or <i>Packet</i> is not a valid MTFTPv4 packet.</li> <li><i>OptionCount</i> is <b>NULL</b>.</li> </ul>

EFI_NOT_FOUND	No options were found in the OACK packet.
EFI_OUT_OF_RESOURCES	Storage for the <i>OptionList</i> array cannot be allocated.
EFI_PROTOCOL_ERROR	One or more of the option fields is invalid.

## EFI\_MFTP4\_PROTOCOL.ReadFile()

### Summary

Downloads a file from an MFTFv4 server.

### Prototype

```
typedef
EFI_STATUS
(EFIAPI *EFI_MFTP4_READ_FILE)(
  IN EFI_MFTP4_PROTOCOL  *This,
  IN EFI_MFTP4_TOKEN    *Token
);
```

### Parameters

<i>This</i>	Pointer to the <b>EFI_MFTP4_PROTOCOL</b> instance.
<i>Token</i>	Pointer to the token structure to provide the parameters that are used in this operation. Type <b>EFI_MFTP4_TOKEN</b> is defined in “Related Definitions” below.

### Description

The **ReadFile()** function is used to initialize and start an MFTFv4 download process and optionally wait for completion. When the download operation completes, whether successfully or not, the *Token.Status* field is updated by the EFI MFTFv4 Protocol driver and then *Token.Event* is signaled (if it is not **NULL**).

Data can be downloaded from the MFTFv4 server into either of the following locations:

- A fixed buffer that is pointed to by *Token.Buffer*
- A download service function that is pointed to by *Token.CheckPacket*

If both *Token.Buffer* and *Token.CheckPacket* are used, then *Token.CheckPacket* will be called first. If the call is successful, the packet will be stored in *Token.Buffer*.



## Related Definitions

```

//*****
// EFI_MTFTP4_TOKEN
//*****
typedef struct {
    EFI_STATUS      Status;
    EFI_EVENT       Event;
    EFI_MTFTP4_OVERRIDE_DATA *OverrideData;
    UINT8          *Filename;
    UINT8          *ModeStr;
    UINT32         OptionCount;
    EFI_MTFTP4_OPTION *OptionList;
    UINT64         BufferSize;
    VOID          *Buffer;
    VOID          *Context;
    EFI_MTFTP4_CHECK_PACKET CheckPacket;
    EFI_MTFTP4_TIMEOUT_CALLBACK TimeoutCallback;
    EFI_MTFTP4_PACKET_NEEDED PacketNeeded;
} EFI_MTFTP4_TOKEN;

```

<i>Status</i>	The status that is returned to the caller at the end of the operation to indicate whether this operation completed successfully. Defined <i>Status</i> values are listed below.
<i>Event</i>	The event that will be signaled when the operation completes. If set to <b>NULL</b> , the corresponding function will wait until the read or write operation finishes. The type of <i>Event</i> must be <b>EVT_NOTIFY_SIGNAL</b> . The Task Priority Level (TPL) of <i>Event</i> must be lower than or equal to <b>TPL_CALLBACK</b> .
<i>OverrideData</i>	If not <b>NULL</b> , the data that will be used to override the existing configure data. Type <b>EFI_MTFTP4_OVERRIDE_DATA</b> is defined in <b>EFI_MTFTP4_PROTOCOL.GetInfo()</b> .
<i>Filename</i>	Pointer to the null-terminated ASCII file name string.
<i>ModeStr</i>	Pointer to the null-terminated ASCII mode string. If <b>NULL</b> , "octet" is used.
<i>OptionCount</i>	Number of option/value string pairs.
<i>OptionList</i>	Pointer to an array of option/value string pairs. Ignored if <i>OptionCount</i> is zero. Both a remote server and this driver implementation should support these options. If one or more options are unrecognized by this implementation, it is sent to the remote server without being changed. Type <b>EFI_MTFTP4_OPTION</b> is defined in <b>EFI_MTFTP4_PROTOCOL.GetInfo()</b> .
<i>BufferSize</i>	On input, the size, in bytes, of <i>Buffer</i> . On output, the number of bytes transferred

<i>Buffer</i>	Pointer to the data buffer. Data that is downloaded from the MFTFv4 server is stored here. Data that is uploaded to the MFTFv4 server is read from here. Ignored if <i>BufferSize</i> is zero.
<i>Context</i>	Pointer to the context that will be used by <i>CheckPacket</i> , <i>TimeoutCallback</i> and <i>PacketNeeded</i> .
<i>CheckPacket</i>	Pointer to the callback function to check the contents of the received packet. Type <b>EFI_MFTFv4_CHECK_PACKET</b> is defined below.
<i>TimeoutCallback</i>	Pointer to the function to be called when a timeout occurs. Type <b>EFI_MFTFv4_TIMEOUT_CALLBACK</b> is defined below.
<i>PacketNeeded</i>	Pointer to the function to provide the needed packet contents. Only used in <b>WriteFile()</b> operation. Type <b>EFI_MFTFv4_PACKET_NEEDED</b> is defined below.

The **EFI\_MFTFv4\_TOKEN** structure is used for both the MFTFv4 reading and writing operations. The caller uses this structure to pass parameters and indicate the operation context. After the reading or writing operation completes, the EFI MFTFv4 Protocol driver updates the *Status* parameter and the *Event* is signaled if it is not **NULL**. The following table lists the status codes that are returned in the *Status* parameter.

## Status Codes Returned in the Status Parameter

EFI_SUCCESS	The data file has been transferred successfully.
EFI_OUT_OF_RESOURCES	Required system resources could not be allocated.
EFI_BUFFER_TOO_SMALL	<i>BufferSize</i> is not large enough to hold the downloaded data in downloading process.
EFI_ABORTED	Current operation is aborted by user.
EFI_NETWORK_UNREACHABLE	An ICMP network unreachable error packet was received.
EFI_NETWORK_UNREACHABLE	An ICMP host unreachable error packet was received.
EFI_NETWORK_UNREACHABLE	An ICMP protocol unreachable error packet was received.
EFI_NETWORK_UNREACHABLE	An ICMP port unreachable error packet was received .
EFI_ICMP_ERROR	Some other ICMP ERROR packet was received.
EFI_TIMEOUT	No responses were received from the MTFTPv4 server.
EFI_TFTP_ERROR	An MTFTPv4 ERROR packet was received.
EFI_DEVICE_ERROR	An unexpected network error or system error occurred.
EFI_NO_MEDIA	There was a media error.

```

//*****
// EFI_MTFTP4_CHECK_PACKET
//*****
typedef
EFI_STATUS
(EFIAPI *EFI_MTFTP4_CHECK_PACKET)(
  IN EFI_MTFTP4_PROTOCOL *This,
  IN EFI_MTFTP4_TOKEN *Token,
  IN UINT16 PacketLen,
  IN EFI_MTFTP4_PACKET *Packet
);

```

*This* Pointer to the **EFI\_MTFTP4\_PROTOCOL** instance.

*Token* The token that the caller provided in the **EFI\_MTFTP4\_PROTOCOL.ReadFile()**, **WriteFile()** or **ReadDirectory()** function. Type **EFI\_MTFTP4\_TOKEN** is defined in **EFI\_MTFTP4\_PROTOCOL.ReadFile()**.

*PacketLen* Indicates the length of the packet.

*Packet* Pointer to an MTFTPv4 packet. Type **EFI\_MTFTP4\_PACKET** is defined in **EFI\_MTFTP4\_PROTOCOL.GetInfo()**.

**EFI\_MTFTP4\_CHECK\_PACKET** is a callback function that is provided by the caller to intercept the **EFI\_MTFTP4\_OPCODE\_DATA** or **EFI\_MTFTP4\_OPCODE\_DATA8** packets processed in the **EFI\_MTFTP4\_PROTOCOL.ReadFile()** function, and alternatively to intercept **EFI\_MTFTP4\_OPCODE\_OACK** or **EFI\_MTFTP4\_OPCODE\_ERROR** packets during a call to **EFI\_MTFTP4\_PROTOCOL.ReadFile()**, **WriteFile()** or **ReadDirectory()**. Whenever an MTFTPv4 packet with the type described above is received from a server,

the EFI MFTFTPv4 Protocol driver will call **EFI\_MFTFTP4\_CHECK\_PACKET** function to let the caller have an opportunity to process this packet. Any status code other than **EFI\_SUCCESS** that is returned from this function will abort the transfer process.

```

//*****
// EFI_MFTFTP4_TIMEOUT_CALLBACK
//*****
typedef
EFI_STATUS
(EFI_API *EFI_MFTFTP4_TIMEOUT_CALLBACK)(
  IN EFI_MFTFTP4_PROTOCOL *This,
  IN EFI_MFTFTP4_TOKEN *Token
);

```

*This* Pointer to the **EFI\_MFTFTP4\_PROTOCOL** instance.

*Token* The token that is provided in the **EFI\_MFTFTP4\_PROTOCOL.ReadFile()** or **EFI\_MFTFTP4\_PROTOCOL.WriteFile()** or **EFI\_MFTFTP4\_PROTOCOL.ReadDirectory()** functions by the caller. Type **EFI\_MFTFTP4\_TOKEN** is defined in **EFI\_MFTFTP4\_PROTOCOL.ReadFile()**.

**EFI\_MFTFTP4\_TIMEOUT\_CALLBACK** is a callback function that the caller provides to capture the timeout event in the **EFI\_MFTFTP4\_PROTOCOL.ReadFile()**, **EFI\_MFTFTP4\_PROTOCOL.WriteFile()** or **EFI\_MFTFTP4\_PROTOCOL.ReadDirectory()** functions. Whenever a timeout occurs, the EFI MFTFTPv4 Protocol driver will call the **EFI\_MFTFTP4\_TIMEOUT\_CALLBACK** function to notify the caller of the timeout event. Any status code other than **EFI\_SUCCESS** that is returned from this function will abort the current download process.

```

//*****
// EFI_MFTFTP4_PACKET_NEEDED
//*****
typedef
EFI_STATUS
(EFI_API *EFI_MFTFTP4_PACKET_NEEDED)(
  IN EFI_MFTFTP4_PROTOCOL *This,
  IN EFI_MFTFTP4_TOKEN *Token,
  IN OUT UINT16 *Length,
  OUT VOID **Buffer
);

```

*This* Pointer to the **EFI\_MFTFTP4\_PROTOCOL** instance.

*Token* The token provided in the **EFI\_MFTFTP4\_PROTOCOL.WriteFile()** by the caller.

*Length* Indicates the length of the raw data wanted on input, and the length the data available on output.

*Buffer* Pointer to the buffer where the data is stored.

**EFI\_MTFTP4\_PACKET\_NEEDED** is a callback function that the caller provides to feed data to the **EFI\_MTFTP4\_PROTOCOL.WriteFile()** function.

**EFI\_MTFTP4\_PACKET\_NEEDED** provides another mechanism for the caller to provide data to upload other than a static buffer. The EFI MTFTP4 Protocol driver always calls **EFI\_MTFTP4\_PACKET\_NEEDED** to get packet data from the caller if no static buffer was given in the initial call to **EFI\_MTFTP4\_PROTOCOL.WriteFile()** function. Setting *\*Length* to zero signals the end of the session. Returning a status code other than **EFI\_SUCCESS** aborts the session.

## Status Codes Returned

EFI_SUCCESS	The data file is being downloaded.
EFI_INVALID_PARAMETER	One or more of the parameters is not valid. <ul style="list-style-type: none"> <li>• <i>This</i> is <b>NULL</b>.</li> <li>• <i>Token</i> is <b>NULL</b>.</li> <li>• <i>Token.FileName</i> is <b>NULL</b>.</li> <li>• <i>Token.OptionCount</i> is not zero and <i>Token.OptionList</i> is <b>NULL</b>.</li> <li>• One or more options in <i>Token.OptionList</i> have wrong format.</li> <li>• <i>Token.Buffer</i> and <i>Token.CheckPacket</i> are both <b>NULL</b>.</li> <li>• One or more IPv4 addresses in <i>Token.OverrideData</i> are not valid unicast IPv4 addresses if <i>Token.OverrideData</i> is not <b>NULL</b> and the addresses are not set to all zero.</li> </ul>
EFI_UNSUPPORTED	<ul style="list-style-type: none"> <li>• One or more options in the <i>Token.OptionList</i> are in the unsupported list of structure <b>EFI_MTFTP4_MODE_DATA</b>.</li> </ul>
EFI_NOT_STARTED	The EFI MTFTPv4 Protocol driver has not been started.
EFI_NO_MAPPING	When using a default address, configuration (DHCP, BOOTP, RARP, etc.) is not finished yet.
EFI_ALREADY_STARTED	This <i>Token</i> is being used in another MTFTPv4 session.
EFI_ACCESS_DENIED	The previous operation has not completed yet.
EFI_OUT_OF_RESOURCES	Required system resources could not be allocated.
EFI_DEVICE_ERROR	An unexpected network error or system error occurred.
EFI_NO_MEDIA	There was a media error.

## EFI\_MTFTP4\_PROTOCOL.WriteFile()

### Summary

Sends a data file to an MTFTpv4 server. May be unsupported in some EFI implementations.

### Prototype

```
typedef
EFI_STATUS
(EFI_API *EFI_MTFTP4_WRITE_FILE)(
  IN EFI_MTFTP4_PROTOCOL *This,
  IN EFI_MTFTP4_TOKEN *Token
);
```

### Parameters

<i>This</i>	Pointer to the <b>EFI_MTFTP4_PROTOCOL</b> instance.
<i>Token</i>	Pointer to the token structure to provide the parameters that are used in this function. Type <b>EFI_MTFTP4_TOKEN</b> is defined in <b>EFI_MTFTP4_PROTOCOL.ReadFile()</b> .

### Description

The **WriteFile()** function is used to initialize an uploading operation with the given option list and optionally wait for completion. If one or more of the options is not supported by the server, the unsupported options are ignored and a standard TFTP process starts instead. When the upload process completes, whether successfully or not, *Token.Event* is signaled, and the EFI MTFTpv4 Protocol driver updates *Token.Status*.

The caller can supply the data to be uploaded in the following two modes:

- Through the user-provided buffer
- Through a callback function

With the user-provided buffer, the *Token.BufferSize* field indicates the length of the buffer, and the driver will upload the data in the buffer. With an **EFI\_MTFTP4\_PACKET\_NEEDED** callback function, the driver will call this callback function to get more data from the user to upload. See the definition of **EFI\_MTFTP4\_PACKET\_NEEDED** for more information. These two modes cannot be used at the same time. The callback function will be ignored if the user provides the buffer.

### Status Codes Returned

EFI_SUCCESS	The upload session has started.
EFI_UNSUPPORTED	The operation is not supported by this implementation.

EFI_INVALID_PARAMETER	<p>One or more of the following conditions is <b>TRUE</b>:</p> <ul style="list-style-type: none"> <li>• <i>This</i> is <b>NULL</b>.</li> <li>• <i>Token</i> is <b>NULL</b>.</li> <li>• <i>Token.FileName</i> is <b>NULL</b>.</li> <li>• <i>Token.OptionCount</i> is not zero and <i>Token.OptionList</i> is <b>NULL</b>.</li> <li>• One or more options in <i>Token.OptionList</i> have wrong format.</li> <li>• <i>Token.Buffer</i> and <i>Token.PacketNeeded</i> are both <b>NULL</b>.</li> <li>• One or more IPv4 addresses in <i>Token.OverrideData</i> are not valid unicast IPv4 addresses if <i>Token.OverrideData</i> is not <b>NULL</b> and the addresses are not set to all zero.</li> </ul>
EFI_UNSUPPORTED	<ul style="list-style-type: none"> <li>• One or more options in the <i>Token.OptionList</i> are in the unsupported list of structure <b>EFI_MTFTP4_MODE_DATA</b>.</li> </ul>
EFI_NOT_STARTED	The EFI MTFTPv4 Protocol driver has not been started.
EFI_NO_MAPPING	When using a default address, configuration (DHCP, BOOTP, RARP, etc.) is not finished yet.
EFI_ALREADY_STARTED	This <i>Token</i> is already being used in another MTFTPv4 session.
EFI_OUT_OF_RESOURCES	Required system resources could not be allocated.
EFI_ACCESS_DENIED	The previous operation has not completed yet.
EFI_DEVICE_ERROR	An unexpected network error or system error occurred.
EFI_NO_MEDIA	There was a media error.

## EFI\_MTFTP4\_PROTOCOL.ReadDirectory()

### Summary

Downloads a data file “directory” from an MTFTPV4 server. May be unsupported in some EFI implementations.

### Prototype

```
typedef
EFI_STATUS
(EFIAPI *EFI_MTFTP4_READ_DIRECTORY)(
  IN EFI_MTFTP4_PROTOCOL  *This,
  IN EFI_MTFTP4_TOKEN     *Token
);
```

### Parameters

<i>This</i>	Pointer to the <b>EFI_MTFTP4_PROTOCOL</b> instance.
<i>Token</i>	Pointer to the token structure to provide the parameters that are used in this function. Type <b>EFI_MTFTP4_TOKEN</b> is defined in <b>EFI_MTFTP4_PROTOCOL.ReadFile()</b> .

### Description

The **ReadDirectory()** function is used to return a list of files on the MTFTPV4 server that are logically (or operationally) related to *Token.FileName*. The directory request packet that is sent to the server is built with the option list that was provided by caller, if present.

The file information that the server returns is put into either of the following locations:

- A fixed buffer that is pointed to by *Token.Buffer*
- A download service function that is pointed to by *Token.CheckPacket*

If both *Token.Buffer* and *Token.CheckPacket* are used, then *Token.CheckPacket* will be called first. If the call is successful, the packet will be stored in *Token.Buffer*.

The returned directory listing in the *Token.Buffer* or **EFI\_MTFTP4\_PACKET** consists of a list of two or three variable-length ASCII strings, each terminated by a null character, for each file in the directory. If the multicast option is involved, the first field of each directory entry is the static multicast IP address and UDP port number that is associated with the file name. The format of the field is **ip:ip:ip:ip:port**. If the multicast option is not involved, this field and its terminating null character are not present.

The next field of each directory entry is the file name and the last field is the file information string. The information string contains the file size and the create/modify timestamp. The format of the information string is **filesize yyyy-mm-dd hh:mm:ss:ffff**. The timestamp is Coordinated Universal Time (UTC; also known as Greenwich Mean Time [GMT]).

### Status Codes Returned

EFI_SUCCESS	The MTFTPV4 related file "directory" has been downloaded.
-------------	---



EFI_UNSUPPORTED	The EFI MTFTPv4 Protocol driver does not support this function.
EFI_INVALID_PARAMETER	One or more of these conditions is <b>TRUE</b> : <ul style="list-style-type: none"> <li>• <i>This</i> is <b>NULL</b>.</li> <li>• <i>Token</i> is <b>NULL</b>.</li> <li>• <i>Token.FileName</i> is <b>NULL</b>.</li> <li>• <i>Token.OptionCount</i> is not zero and <i>Token.OptionList</i> is <b>NULL</b>.</li> <li>• One or more options in <i>Token.OptionList</i> have wrong format.</li> </ul> <i>Token.Buffer</i> and <i>Token.CheckPacket</i> are both <b>NULL</b> . <ul style="list-style-type: none"> <li>• One or more IPv4 addresses in <i>Token.OverrideData</i> are not valid unicast IPv4 addresses if <i>Token.OverrideData</i> is not <b>NULL</b> and the addresses are not set to all zero.</li> </ul>
EFI_UNSUPPORTED	One or more options in the <i>Token.OptionList</i> are in the unsupported list of structure <b>EFI_MTFTP4_MODE_DATA</b> .
EFI_NOT_STARTED	The EFI MTFTPv4 Protocol driver has not been started.
EFI_NO_MAPPING	When using a default address, configuration (DHCP, BOOTP, RARP, etc.) is not finished yet.
EFI_ALREADY_STARTED	This <i>Token</i> is already being used in another MTFTPv4 session.
EFI_OUT_OF_RESOURCES	Required system resources could not be allocated.
EFI_ACCESS_DENIED	The previous operation has not completed yet.
EFI_DEVICE_ERROR	An unexpected network error or system error occurred.
EFI_NO_MEDIA	There was a media error.

## EFI\_MTFTP4\_PROTOCOL.POLL()

### Summary

Polls for incoming data packets and processes outgoing data packets.

### Prototype

```
typedef
EFI_STATUS
(EFI_API *EFI_MTFTP4_POLL) (
    IN EFI_MTFTP4_PROTOCOL *This
);
```

### Parameters

*This* Pointer to the **EFI\_MTFTP4\_PROTOCOL** instance.

### Description

The **Poll()** function can be used by network drivers and applications to increase the rate that data packets are moved between the communications device and the transmit and receive queues.

In some systems, the periodic timer event in the managed network driver may not poll the underlying communications device fast enough to transmit and/or receive all data packets without missing incoming packets or dropping outgoing packets. Drivers and applications that are experiencing packet loss should try calling the **Poll()** function more often.

### Status Codes Returned

EFI_SUCCESS	Incoming or outgoing data was processed.
EFI_NOT_STARTED	This EFI MTFTPv4 Protocol instance has not been started.
EFI_NO_MAPPING	When using a default address, configuration (DHCP, BOOTP, RARP, etc.) is not finished yet.
EFI_INVALID_PARAMETER	<i>This</i> is <b>NULL</b> .
EFI_DEVICE_ERROR	An unexpected system or network error occurred.
EFI_TIMEOUT	Data was dropped out of the transmit and/or receive queue. Consider increasing the polling rate.

## 30.4 EFI MTFTPv6 Protocol

This section defines the EFI MTFTPv6 Protocol interface that is built upon the EFI UDPv6 Protocol.

## 30.4.1 MTFTP6 Service Binding Protocol

### EFI\_MTFTP6\_SERVICE\_BINDING\_PROTOCOL

#### Summary

The EFI MTFTPv6 Service Binding Protocol is used to locate communication devices that are supported by an EFI MTFTPv6 Protocol driver and to create and destroy instances of the EFI MTFTPv6 Protocol child instance that can use the underlying communications device.

#### GUID

```
#define EFI_MTFTP6_SERVICE_BINDING_PROTOCOL_GUID \
{0xd9760ff3,0x3cca,0x4267,\
{0x80,0xf9,0x75,0x27,0xfa,0xfa,0x42,0x23}}
```

#### Description

A network application or driver that requires MTFTPv6 I/O services can use one of the protocol handler services, such as **BS->LocateHandleBuffer()**, to search for devices that publish an EFI MTFTPv6 Service Binding Protocol GUID. Each device with a published EFI MTFTPv6 Service Binding Protocol GUID supports the EFI MTFTPv6 Protocol service and may be available for use.

After a successful call to the **EFI\_MTFTP6\_SERVICE\_BINDING\_PROTOCOL.CreateChild()** function, the newly created child EFI MTFTPv6 Protocol driver instance is in the un-configured state; it is not ready to transfer data.

Before a network application terminates execution, every successful call to the **EFI\_MTFTP6\_SERVICE\_BINDING\_PROTOCOL.CreateChild()** function must be matched with a call to the **EFI\_MTFTP6\_SERVICE\_BINDING\_PROTOCOL.DestroyChild()** function.

Each instance of the EFI MTFTPv6 Protocol driver can support one file transfer operation at a time. To download two files at the same time, two instances of the EFI MTFTPv6 Protocol driver need to be created.

## 30.4.2 MTFTP6 Protocol

### EFI\_MTFTP6\_PROTOCOL

#### Summary

The EFI MTFTPv6 Protocol provides basic services for client-side unicast and/or multicast TFTP operations.

## GUID

```
#define EFI_MTFTP6_PROTOCOL_GUID \
  {0xbf0a78ba,0xec29,0x49cf,\
   {0xa1,0xc9,0x7a,0xe5,0x4e,0xab,0x6a,0x51}}
```

## Protocol Interface Structure

```
typedef struct _EFI_MTFTP6_PROTOCOL {
  EFI_MTFTP6_GET_MODE_DATA  GetModeData;
  EFI_MTFTP6_CONFIGURE      Configure;
  EFI_MTFTP6_GET_INFO       GetInfo;
  EFI_MTFTP6_PARSE_OPTIONS  ;
  EFI_MTFTP6_READ_FILE      ReadFile;
  EFI_MTFTP6_WRITE_FILE     WriteFile;
  EFI_MTFTP6_READ_DIRECTORY ReadDirectory;
  EFI_MTFTP6_POLL           Poll;
} EFI_MTFTP6_PROTOCOL;
```

## Parameters

<i>GetModeData</i>	Reads the current operational settings. See the <b>GetModeData()</b> function description.
<i>Configure</i>	Initializes, changes, or resets the operational settings for this instance of the EFI MTFTPv6 Protocol driver. See the <b>Configure()</b> function description.
<i>GetInfo</i>	Retrieves information about a file from an MTFTPv6 server. See the <b>GetInfo()</b> function description.
<i>ParseOptions</i>	Parses the options in an MTFTPv6 OACK (options acknowledgement) packet. See the <b>ParseOptions()</b> function description.
<i>ReadFile</i>	Downloads a file from an MTFTPv6 server. See the <b>ReadFile()</b> function description.
<i>WriteFile</i>	Uploads a file to an MTFTPv6 server. This function may be unsupported in some EFI implementations. See the <b>WriteFile()</b> function description.
<i>ReadDirectory</i>	Downloads a related file directory from an MTFTPv6 server. This function may be unsupported in some EFI implementations. See the <b>ReadDirectory()</b> function description.
<i>Poll</i>	Polls for incoming data packets and processes outgoing data packets. See the <b>Poll()</b> function description.

## Description

The **EFI\_MTFTP6\_PROTOCOL** is designed to be used by UEFI drivers and applications to transmit and receive data files. The EFI MTFTPv6 Protocol driver uses the underlying EFI UDPv6 Protocol driver and EFI IPv6 Protocol driver.

## EFI\_MTFTP6\_PROTOCOL.GetModeData()

### Summary

Read the current operational settings.

### Prototype

```
typedef
EFI_STATUS
(EFIAPI *EFI_MTFTP6_GET_MODE_DATA)(
  IN EFI_MTFTP6_PROTOCOL *This,
  OUT EFI_MTFTP6_MODE_DATA *ModeData
);
```

### Parameters

*This*

Pointer to the **EFI\_MTFTP6\_PROTOCOL** instance.

*ModeData*

The buffer in which the EFI MTFTPv6 Protocol driver mode data is returned. Type **EFI\_MTFTP6\_MODE\_DATA** is defined in "Related Definitions" below.

### Description

The **GetModeData()** function reads the current operational settings of this EFI MTFTPv6 Protocol driver instance.

### Related Definitions

```
/**
//*****
// EFI_MTFTP6_MODE_DATA
//*****
typedef struct {
  EFI_MTFTP6_CONFIG_DATA ConfigData;
  UINT8    SupportedOptionCount;
  UINT8    **SupportedOptions;
} EFI_MTFTP6_MODE_DATA;
```

*ConfigData*

The configuration data of this instance. Type **EFI\_MTFTP6\_CONFIG\_DATA** is defined below.

*SupportedOptionCount*

The number of option strings in the following *SupportedOptions* array.

*SupportedOptions*

An array of null-terminated ASCII option strings that are recognized and supported by this EFI MTFTPv6 Protocol driver implementation. The buffer is read only to the caller and the caller should NOT free the buffer.

The **EFI\_MTFTP6\_MODE\_DATA** structure describes the operational state of this instance.

```

//*****
// EFI_MTFTP6_CONFIG_DATA
//*****
typedef struct {
    EFI_IPv6_ADDRESS StationIp;
    UINT16 LocalPort;
    EFI_IPv6_ADDRESS ServerIp;
    UINT16 InitialServerPort;
    UINT16 TryCount;
    UINT16 TimeoutValue;
} EFI_MTFTP6_CONFIG_DATA;
    
```

- StationIp*                      The local IP address to use. Set to zero to let the underlying IPv6 driver choose a source address. If not zero it must be one of the configured IP addresses in the underlying IPv6 driver.
- LocalPort*                      Local port number. Set to zero to use the automatically assigned port number.
- ServerIp*                      The IP address of the MTFTPv6 server.
- InitialServerPort*              The initial MTFTPv6 server port number. Request packets are sent to this port. This number is almost always 69 and using zero defaults to 69.
- TryCount*                      The number of times to transmit MTFTPv6 request packets and wait for a response.
- TimeoutValue*                  The number of seconds to wait for a response after sending the MTFTPv6 request packet.

The **EFI\_MTFTP6\_CONFIG\_DATA** structure is used to retrieve and change MTFTPv6 session parameters.

### Status Codes Returned

EFI_SUCCESS	The configuration data was successfully returned.
EFI_OUT_OF_RESOURCES	The required mode data could not be allocated.
EFI_INVALID_PARAMETER	<i>This is NULL or ModeData is NULL.</i>

## EFI\_MTFTP6\_PROTOCOL.Configure()

### Summary

Initializes, changes, or resets the default operational setting for this EFI MTFTPv6 Protocol driver instance.

### Prototype

```
typedef
EFI_STATUS
(EFI_API *EFI_MTFTP6_CONFIGURE)(
  IN EFI_MTFTP6_PROTOCOL *This,
  IN EFI_MTFTP6_CONFIG_DATA *MtftpConfigData OPTIONAL
);
```

### Parameters

<i>This</i>	Pointer to the <b>EFI_MTFTP6_PROTOCOL</b> instance.
<i>MtftpConfigData</i>	Pointer to the configuration data structure. Type <b>EFI_MTFTP6_CONFIG_DATA</b> is defined in <b>EFI_MTFTP6_PROTOCOL.GetModeData()</b> .

### Description

The **Configure()** function is used to set and change the configuration data for this EFI MTFTPv6 Protocol driver instance. The configuration data can be reset to startup defaults by calling **Configure()** with *MtftpConfigData* set to **NULL**. Whenever the instance is reset, any pending operation is aborted. By changing the EFI MTFTPv6 Protocol driver instance configuration data, the client can connect to different MTFTPv6 servers. The configuration parameters in *MtftpConfigData* are used as the default parameters in later MTFTPv6 operations and can be overridden in later operations.

### Status Codes Returned

EFI_SUCCESS	The EFI MTFTPv6 Protocol instance was configured successfully.
EFI_INVALID_PARAMETER	One or more following conditions are <b>TRUE</b> : <ul style="list-style-type: none"> <li>• <i>This</i> is <b>NULL</b>.</li> <li>• <i>MtftpConfigData.StationIp</i> is neither zero nor one of the configured IP addresses in the underlying IPv6 driver.</li> <li>• <i>MtftpCofigData.ServerIp</i> is not a valid IPv6 unicast address.</li> </ul>
EFI_ACCESS_DENIED	<ul style="list-style-type: none"> <li>• The configuration could not be changed at this time because there is some MTFTP background operation in progress.</li> <li>• <i>MtftpCofigData.LocalPort</i> is already in use.</li> </ul>
EFI_NO_MAPPING	The underlying IPv6 driver was responsible for choosing a source address for this instance, but no source address was available for use.
EFI_OUT_OF_RESOURCES	The EFI MTFTPv6 Protocol driver instance data could not be allocated.

EFI_DEVICE_ERROR	An unexpected system or network error occurred. The EFI MTFTPv6 Protocol driver instance is not configured.
------------------	---



## EFI\_MTFTP6\_PROTOCOL.GetInfo()

### Summary

Get information about a file from an MTFTPv6 server.

### Prototype

```
typedef
EFI_STATUS
(EFIAPI *EFI_MTFTP6_GET_INFO)(
  IN EFI_MTFTP6_PROTOCOL *This,
  IN EFI_MTFTP6_OVERRIDE_DATA *OverrideData OPTIONAL,
  IN UINT8 *Filename,
  IN UINT8 *ModeStr OPTIONAL,
  IN UINT8 OptionCount,
  IN EFI_MTFTP6_OPTION *OptionList OPTIONAL,
  OUT UINT32 *PacketLength,
  OUT EFI_MTFTP6_PACKET **Packet OPTIONAL
);
```

### Parameters

<i>This</i>	Pointer to the <b>EFI_MTFTP6_PROTOCOL</b> instance.
<i>OverrideData</i>	Data that is used to override the existing parameters. If <b>NULL</b> , the default parameters that were set in the <b>EFI_MTFTP6_PROTOCOL.Configure()</b> function are used. Type <b>EFI_MTFTP6_OVERRIDE_DATA</b> is defined in "Related Definitions" below.
<i>Filename</i>	Pointer to a null-terminated ASCII file name string.
<i>ModeStr</i>	Pointer to a null-terminated ASCII mode string. If <b>NULL</b> , octet will be used.
<i>OptionCount</i>	Number of option/value string pairs in <i>OptionList</i> .
<i>OptionList</i>	Pointer to array of option/value string pairs. Ignored if <i>OptionCount</i> is zero. Type <b>EFI_MTFTP6_OPTION</b> is defined in "Related Definitions" below.
<i>PacketLength</i>	The number of bytes in the returned packet.
<i>Packet</i>	The pointer to the received packet. This buffer must be freed by the caller. Type <b>EFI_MTFTP6_PACKET</b> is defined in "Related Definitions" below.

### Description

The **GetInfo()** function assembles an MTFTPv6 request packet with options, sends it to the MTFTPv6 server, and may return an MTFTPv6 OACK, MTFTPv6 ERROR, or ICMP ERROR packet. Retries occur only if no response packets are received from the MTFTPv6 server before the timeout expires.

## Related Definitions

```

//*****
// EFI_MTFTP_OVERRIDE_DATA
//*****
typedef struct {
    EFI_IPv6_ADDRESS ServerIp;
    UINT16    ServerPort;
    UINT16    TryCount;
    UINT16    TimeoutValue;
} EFI_MTFTP6_OVERRIDE_DATA;

```

<i>ServerIp</i>	IP address of the MTFTFv6 server. If set to all zero, the value that was set by the <b>EFI_MTFTP6_PROTOCOL.Configure()</b> function will be used.
<i>ServerPort</i>	MTFTFv6 server port number. If set to zero, it will use the value that was set by the <b>EFI_MTFTP6_PROTOCOL.Configure()</b> function.
<i>TryCount</i>	Number of times to transmit MTFTFv6 request packets and wait for a response. If set to zero, the value that was set by the <b>EFI_MTFTP6_PROTOCOL.Configure()</b> function will be used.
<i>TimeoutValue</i>	Number of seconds to wait for a response after sending the MTFTFv6 request packet. If set to zero, the value that was set by the <b>EFI_MTFTP6_PROTOCOL.Configure()</b> function will be used.

The **EFI\_MTFTP6\_OVERRIDE\_DATA** structure is used to override the existing parameters that were set by the **EFI\_MTFTP6\_PROTOCOL.Configure()** function.

```

//*****
// EFI_MTFTP6_OPTION
//*****
typedef struct {
    UINT8    *OptionStr;
    UINT8    *ValueStr;
} EFI_MTFTP6_OPTION;

```

<i>OptionStr</i>	Pointer to the null-terminated ASCII MTFTFv6 option string.
<i>ValueStr</i>	Pointer to the null-terminated ASCII MTFTFv6 value string.

```

#pragma pack(1)

//*****
// EFI_MTFTP6_PACKET
//*****
typedef union {
    UINT16    OpCode;
    EFI_MTFTP6_REQ_HEADER Rrq;
    EFI_MTFTP6_REQ_HEADER Wrq;
    EFI_MTFTP6_OACK_HEADER Oack;
    EFI_MTFTP6_DATA_HEADER Data;
    EFI_MTFTP6_ACK_HEADER Ack;
    // This field should be ignored and treated as reserved.
    EFI_MTFTP6_DATA8_HEADER Data8;
    // This field should be ignored and treated as reserved.
    EFI_MTFTP6_ACK8_HEADER Ack8;
    EFI_MTFTP6_ERROR_HEADER Error;
} EFI_MTFTP6_PACKET;

//*****
// EFI_MTFTP6_REQ_HEADER
//*****
typedef struct {
    UINT16 OpCode;
    UINT8  Filename[1];
} EFI_MTFTP6_REQ_HEADER;

//*****
// EFI_MTFTP6_OACK_HEADER
//*****
typedef struct {
    UINT16 OpCode;
    UINT8  Data[1];
} EFI_MTFTP6_OACK_HEADER;

//*****
// EFI_MTFTP6_DATA_HEADER
//*****
typedef struct {
    UINT16 OpCode;
    UINT16 Block;
    UINT8  Data[1];
} EFI_MTFTP6_DATA_HEADER;

//*****
// EFI_MTFTP6_ACK_HEADER

```

```

//*****
typedef struct {
    UINT16 OpCode;
    UINT16 Block[1];
} EFI_MTFTP6_ACK_HEADER;

//*****
// EFI_MTFTP6_DATA8_HEADER
// This field should be ignored and treated as reserved.
//*****
typedef struct {
    UINT16 OpCode;
    UINT64 Block;
    UINT8 Data[1];
} EFI_MTFTP6_DATA8_HEADER;

//*****
// EFI_MTFTP6_ACK8_HEADER
//*****
typedef struct {
    UINT16 OpCode;
    UINT64 Block[1];
} EFI_MTFTP6_ACK8_HEADER;

//*****
// EFI_MTFTP6_ERROR_HEADER
//*****
typedef struct {
    UINT16 OpCode;
    UINT16 ErrorCode;
    UINT8 ErrorMessage[1];
} EFI_MTFTP6_ERROR_HEADER;

#pragma pack()

```

Table 1 below describes the parameters that are listed in the MTFTPv6 packet structure definitions above. All the above structures are byte packed. The pragmas may vary from compiler to compiler. The MTFTPv6 packet structures are also used by the following functions:

- `EFI_MTFTP6_PROTOCOL.ReadFile()`
- `EFI_MTFTP6_PROTOCOL.WriteFile()`
- `EFI_MTFTP6_PROTOCOL.ReadDirectory()`
- The EFI MTFTPv6 Protocol packet check callback functions

**Note:** **BYTE ORDER:** Both incoming and outgoing MTFTPv6 packets are in network byte order. All other parameters defined in functions or data structures are stored in host byte order.

**Table 199. Descriptions of Parameters in MTFTPv6 Packet Structures**

Data Structure	Parameter	Description
<b>EFI_MTFTP6_PACKET</b>	OpCode	Type of packets as defined by the MTFTPv6 packet opcodes. Opcode values are defined below.
	Rrq, Wrq	Read request or write request packet header. See the description for <b>EFI_MTFTP6_REQ_HEADER</b> below in this table.
	Oack	Option acknowledge packet header. See the description for <b>EFI_MTFTP6_OACK_HEADER</b> below in this table.
	Data	Data packet header. See the description for <b>EFI_MTFTP6_DATA_HEADER</b> below in this table.
	Ack	Acknowledgement packet header. See the description for <b>EFI_MTFTP6_ACK_HEADER</b> below in this table.
	Data8	This field should be ignored and treated as reserved.  Data packet header with big block number. See the description for <b>EFI_MTFTP6_DATA8_HEADER</b> below in this table.
	Ack8	This field should be ignored and treated as reserved.  Acknowledgement header with big block number. See the description for <b>EFI_MTFTP6_ACK8_HEADER</b> below in this table.
	Error	Error packet header. See the description for <b>EFI_MTFTP6_ERROR_HEADER</b> below in this table.
<b>EFI_MTFTP6_REQ_HEADER</b>	OpCode	For this packet type, <i>OpCode</i> = <b>EFI_MTFTP6_OPCODE_RRQ</b> for a read request or <i>OpCode</i> = <b>EFI_MTFTP6_OPCODE_WRQ</b> for a write request.
	Filename	The file name to be downloaded or uploaded.

<b>EFI_MTFTP6_OACK_HEADER</b>	OpCode	For this packet type, <i>OpCode</i> = <b>EFI_MTFTP6_OPCODE_OACK</b> .
	Data	The option strings in the option acknowledgement packet.
<b>EFI_MTFTP6_DATA_HEADER</b>	OpCode	For this packet type, <i>OpCode</i> = <b>EFI_MTFTP6_OPCODE_DATA</b> .
	Block	Block number of this data packet.
	Data	The content of this data packet.
<b>EFI_MTFTP6_ACK_HEADER</b>	OpCode	For this packet type, <i>OpCode</i> = <b>EFI_MTFTP6_OPCODE_ACK</b> .
	Block	The block number of the data packet that is being acknowledged.
<b>EFI_MTFTP6_DATA8_HEADER</b>	OpCode	This field should be ignored and treated as reserved.  For this packet type, <i>OpCode</i> = <b>EFI_MTFTP6_OPCODE_DATA8</b> .
	Block	This field should be ignored and treated as reserved.  The block number of data packet.
	Data	This field should be ignored and treated as reserved.  The content of this data packet.
<b>EFI_MTFTP6_ACK8_HEADER</b>	OpCode	For this packet type, <i>OpCode</i> = <b>EFI_MTFTP6_OPCODE_ACK8</b> .
	Block	The block number of the data packet that is being acknowledged.
<b>EFI_MTFTP6_ERROR_HEADER</b>	OpCode	For this packet type, <i>OpCode</i> = <b>EFI_MTFTP6_OPCODE_ERROR</b> .
	ErrorCode	The error number as defined by the MTFTPV6 packet error codes. Values for <i>ErrorCode</i> are defined below.
	ErrorMessage	Error message string.

```
//  
// MTFTP Packet OpCodes  
//  
#define EFI_MTFTP6_OPCODE_RRQ 1  
#define EFI_MTFTP6_OPCODE_WRQ 2  
#define EFI_MTFTP6_OPCODE_DATA 3  
#define EFI_MTFTP6_OPCODE_ACK 6  
#define EFI_MTFTP6_OPCODE_ERROR 5  
#define EFI_MTFTP6_OPCODE_OACK 6  
#define EFI_MTFTP6_OPCODE_DIR 7  
//This field should be ignored and treated as reserved.  
#define EFI_MTFTP4_OPCODE_DATA8 8  
//This field should be ignored and treated as reserved.  
#define EFI_MTFTP4_OPCODE_ACK8 9
```

Following is a description of the fields in the above definition.

Table 200. MTFTP Packet OpCode Descriptions

MTFTP Packet OpCode	Description
<b>EFI_MTFTP6_OPCODE_RRQ</b>	The MTFTPv6 packet is a read request.
<b>EFI_MTFTP6_OPCODE_WRQ</b>	The MTFTPv6 packet is a write request.
<b>EFI_MTFTP6_OPCODE_DATA</b>	The MTFTPv6 packet is a data packet.
<b>EFI_MTFTP6_OPCODE_ACK</b>	The MTFTPv6 packet is an acknowledgement packet.
<b>EFI_MTFTP6_OPCODE_ERROR</b>	The MTFTPv6 packet is an error packet.
<b>EFI_MTFTP6_OPCODE_OACK</b>	The MTFTPv6 packet is an option acknowledgement packet.
<b>EFI_MTFTP6_OPCODE_DIR</b>	The MTFTPv6 packet is a directory query packet.
<b>EFI_MTFTP6_OPCODE_DATA8</b>	This field should be ignored and treated as reserved.  The MTFTPv6 packet is a data packet with a big block number.
<b>EFI_MTFTP6_OPCODE_ACK8</b>	This field should be ignored and treated as reserved.  The MTFTPv6 packet is an acknowledgement packet with a big block number.

```
//
// MTFTP ERROR Packet ErrorCodes
//
#define EFI_MTFTP6_ERRORCODE_NOT_DEFINED0
#define EFI_MTFTP6_ERRORCODE_FILE_NOT_FOUND1
#define EFI_MTFTP6_ERRORCODE_ACCESS_VIOLATION2
#define EFI_MTFTP6_ERRORCODE_DISK_FULL3
#define EFI_MTFTP6_ERRORCODE_ILLEGAL_OPERATION4
#define EFI_MTFTP6_ERRORCODE_UNKNOWN_TRANSFER_ID5
#define EFI_MTFTP6_ERRORCODE_FILE_ALREADY_EXISTS6
#define EFI_MTFTP6_ERRORCODE_NO_SUCH_USER7
#define EFI_MTFTP6_ERRORCODE_REQUEST_DENIED8
```

Table 201. MTFTP ERROR Packet ErrorCode Descriptions

MTFTP ERROR Packet ErrorCodes	Description
<b>EFI_MTFTP6_ERRORCODE_NOT_DEFINED</b>	The error code is not defined. See the error message in the packet (if any) for details.
<b>EFI_MTFTP6_ERRORCODE_FILE_NOT_FOUND</b>	The file was not found.
<b>EFI_MTFTP6_ERRORCODE_ACCESS_VIOLATION</b>	There was an access violation.
<b>EFI_MTFTP6_ERRORCODE_DISK_FULL</b>	The disk was full or its allocation was exceeded.



<b>EFI_MTFTP6_ERRORCODE_ILLEGAL_OPERATION</b>	The MTFTPv6 operation was illegal.
<b>EFI_MTFTP6_ERRORCODE_UNKNOWN_TRANSFER_ID</b>	The transfer ID is unknown.
<b>EFI_MTFTP6_ERRORCODE_FILE_ALREADY_EXISTS</b>	The file already exists.
<b>EFI_MTFTP6_ERRORCODE_NO_SUCH_USER</b>	There is no such user.
<b>EFI_MTFTP6_ERRORCODE_REQUEST_DENIED</b>	The request has been denied due to option negotiation.

## Status Codes Returned

EFI_SUCCESS	An MTFTPv6 OACK packet was received and is in the <i>Packet</i> .
EFI_INVALID_PARAMETER	One or more of the following conditions is <b>TRUE</b> : <ul style="list-style-type: none"> <li><i>This</i> is <b>NULL</b>.</li> <li><i>Filename</i> is <b>NULL</b>.</li> <li><i>OptionCount</i> is not zero and <i>OptionList</i> is <b>NULL</b>.</li> <li>One or more options in <i>OptionList</i> have wrong format.</li> <li><i>PacketLength</i> is <b>NULL</b>.</li> <li><i>OverrideData.ServerIp</i> is not a valid unicast IPv6 address and not set to all zero.</li> </ul>
EFI_UNSUPPORTED	One or more options in the <i>OptionList</i> are unsupported by this implementation.
EFI_NOT_STARTED	The EFI MTFTPv6 Protocol driver has not been started.
EFI_NO_MAPPING	The underlying IPv6 driver was responsible for choosing a source address for this instance, but no source address was available for use.
EFI_ACCESS_DENIED	The previous operation has not completed yet.
EFI_OUT_OF_RESOURCES	Required system resources could not be allocated.
EFI_TFTP_ERROR	An MTFTPv6 ERROR packet was received and is in the <i>Packet</i> .
EFI_NETWORK_UNREACHABLE	An ICMP network unreachable error packet was received and the <i>Packet</i> is set to <b>NULL</b> ..
EFI_NETWORK_UNREACHABLE	An ICMP host unreachable error packet was received and the <i>Packet</i> is set to <b>NULL</b> ...
EFI_NETWORK_UNREACHABLE	An ICMP protocol unreachable error packet was received and the <i>Packet</i> is set to <b>NULL</b> ..
EFI_NETWORK_UNREACHABLE	An ICMP port unreachable error packet was received and the <i>Packet</i> is set to <b>NULL</b> ...
EFI_ICMP_ERROR	Some other ICMP ERROR packet was received and the <i>Packet</i> is set to <b>NULL</b> .
EFI_PROTOCOL_ERROR	An unexpected MTFTPv6 packet was received and is in the <i>Packet</i> .

EFI_TIMEOUT	No responses were received from the MFTFv6 server.
EFI_DEVICE_ERROR	An unexpected network error or system error occurred.

## EFI\_MTFTP6\_PROTOCOL.ParseOptions()

### Summary

Parse the options in an MTFTPv6 OACK packet.

### Prototype

```
typedef
EFI_STATUS
(EFI_API *EFI_MTFTP6_PARSE_OPTIONS)(
  IN EFI_MTFTP6_PROTOCOL *This,
  IN UINT32    PacketLen,
  IN EFI_MTFTP6_PACKET *Packet,
  OUT UINT32   *OptionCount,
  OUT EFI_MTFTP6_OPTION **OptionList OPTIONAL
);
```

### Parameters

<i>This</i>	Pointer to the <b>EFI_MTFTP6_PROTOCOL</b> instance.
<i>PacketLen</i>	Length of the OACK packet to be parsed.
<i>Packet</i>	Pointer to the OACK packet to be parsed. Type <b>EFI_MTFTP6_PACKET</b> is defined in <b>EFI_MTFTP6_PROTOCOL.GetInfo()</b> .
<i>OptionCount</i>	Pointer to the number of options in the following <i>OptionList</i> .
<i>OptionList</i>	Pointer to <b>EFI_MTFTP6_OPTION</b> storage. Each pointer in the <i>OptionList</i> points to the corresponding MTFTP option buffer in the <i>Packet</i> . Call the EFI Boot Service <b>FreePool()</b> to release the <i>OptionList</i> if the options in this <i>OptionList</i> are not needed any more. Type <b>EFI_MTFTP6_OPTION</b> is defined in <b>EFI_MTFTP6_PROTOCOL.GetInfo()</b> .

### Description

The **ParseOptions()** function parses the option fields in an MTFTPv6 OACK packet and returns the number of options that were found and optionally a list of pointers to the options in the packet.

If one or more of the option fields are not valid, then **EFI\_PROTOCOL\_ERROR** is returned and *\*OptionCount* and *\*OptionList* stop at the last valid option.

## Status Codes Returned

EFI_SUCCESS	The OACK packet was valid and the <i>OptionCount</i> and <i>OptionList</i> parameters have been updated.
EFI_INVALID_PARAMETER	One or more of the following conditions is <b>TRUE</b> : <ul style="list-style-type: none"> <li>• <i>PacketLen</i> is 0.</li> <li>• <i>Packet</i> is <b>NULL</b> or <i>Packet</i> is not a valid MTFTPv6 packet.</li> <li>• <i>OptionCount</i> is <b>NULL</b>.</li> </ul>
EFI_NOT_FOUND	No options were found in the OACK packet.
EFI_OUT_OF_RESOURCES	Storage for the <i>OptionList</i> array can not be allocated.
EFI_PROTOCOL_ERROR	One or more of the option fields is invalid.

## EFI\_MTFTP6\_PROTOCOL.ReadFile()

### Summary

Download a file from an MTFTPv6 server.

### Prototype

```
typedef
EFI_STATUS
(EFIAPI *EFI_MTFTP6_READ_FILE)(
  IN EFI_MTFTP6_PROTOCOL  *This,
  IN EFI_MTFTP6_TOKEN    *Token
);
```

### Parameters

<i>This</i>	Pointer to the <b>EFI_MTFTP6_PROTOCOL</b> instance.
<i>Token</i>	Pointer to the token structure to provide the parameters that are used in this operation. Type <b>EFI_MTFTP6_TOKEN</b> is defined in "Related Definitions" below.

### Description

The **ReadFile()** function is used to initialize and start an MTFTPv6 download process and optionally wait for completion. When the download operation completes, whether successfully or not, the *Token.Status* field is updated by the EFI MTFTPv6 Protocol driver and then *Token.Event* is signaled if it is not **NULL**.

Data can be downloaded from the MTFTPv6 server into either of the following locations:

- A fixed buffer that is pointed to by *Token.Buffer*
- A download service function that is pointed to by *Token.CheckPacket*

If both *Token.Buffer* and *Token.CheckPacket* are used, then *Token.CheckPacket* will be called first. If the call is successful, the packet will be stored in *Token.Buffer*.

## Related Definitions

```

//*****
// EFI_MTFTP6_TOKEN
//*****
typedef struct {
    EFI_STATUS      Status;
    EFI_EVENT       Event;
    EFI_MTFTP6_OVERRIDE_DATA OverrideData;
    UINT8          *Filename;
    UINT8          *ModeStr;
    UINT32         OptionCount;
    EFI_MTFTP6_OPTION* OptionList;
    UINT64         BufferSize;
    VOID          *Buffer;
    VOID          *Context;
    EFI_MTFTP6_CHECK_PACKET CheckPacket;
    EFI_MTFTP6_TIMEOUT_CALLBACK TimeoutCallback;
    EFI_MTFTP6_PACKET_NEEDED PacketNeeded;
} EFI_MTFTP6_TOKEN;

```

<i>Status</i>	The status that is returned to the caller at the end of the operation to indicate whether this operation completed successfully. Defined <i>Status</i> values are listed below.
<i>Event</i>	The event that will be signaled when the operation completes. If set to <b>NULL</b> , the corresponding function will wait until the read or write operation finishes. The type of <i>Event</i> must be <b>EVT_NOTIFY_SIGNAL</b> .
<i>OverrideData</i>	If not <b>NULL</b> , the data that will be used to override the existing configure data. Type <b>EFI_MTFTP6_OVERRIDE_DATA</b> is defined in <b>EFI_MTFTP6_PROTOCOL.GetInfo()</b> .
<i>Filename</i>	Pointer to the null-terminated ASCII file name string.
<i>ModeStr</i>	Pointer to the null-terminated ASCII mode string. If <b>NULL</b> , octet is used.
<i>OptionCount</i>	Number of option/value string pairs.
<i>OptionList</i>	Pointer to an array of option/value string pairs. Ignored if <i>OptionCount</i> is zero. Both a remote server and this driver implementation should support these options. If one or more options are unrecognized by this implementation, it is sent to the remote server without being changed. Type <b>EFI_MTFTP6_OPTION</b> is defined in <b>EFI_MTFTP6_PROTOCOL.GetInfo()</b> .
<i>BufferSize</i>	On input, the size, in bytes, of <i>Buffer</i> . On output, the number of bytes transferred.

<i>Buffer</i>	Pointer to the data buffer. Data that is downloaded from the MTFTPv6 server is stored here. Data that is uploaded to the MTFTPv6 server is read from here. Ignored if <i>BufferSize</i> is zero.
<i>Context</i>	Pointer to the context that will be used by <i>CheckPacket</i> , <i>TimeoutCallback</i> and <i>PacketNeeded</i> .
<i>CheckPacket</i>	Pointer to the callback function to check the contents of the received packet. Type <b>EFI_MTFTP6_CHECK_PACKET</b> is defined below.
<i>TimeoutCallback</i>	Pointer to the function to be called when a timeout occurs. Type <b>EFI_MTFTP6_TIMEOUT_CALLBACK</b> is defined below.
<i>PacketNeeded</i>	Pointer to the function to provide the needed packet contents. Only used in <b>WriteFile()</b> operation. Type <b>EFI_MTFTP6_PACKET_NEEDED</b> is defined below.

The **EFI\_MTFTP6\_TOKEN** structure is used for both the MTFTPv6 reading and writing operations. The caller uses this structure to pass parameters and indicate the operation context. After the reading or writing operation completes, the EFI MTFTPv6 Protocol driver updates the *Status* parameter and the *Event* is signaled if it is not **NULL**. The following table lists the status codes that are returned in the *Status* parameter.

### Status Codes Returned in the Status Parameter

EFI_SUCCESS	The data file has been transferred successfully.
EFI_OUT_OF_RESOURCES	Required system resources could not be allocated.
EFI_BUFFER_TOO_SMALL	<i>BufferSize</i> is not zero but not large enough to hold the downloaded data in downloading process.
EFI_ABORTED	Current operation is aborted by user.
EFI_NETWORK_UNREACHABLE	An ICMP network unreachable error packet was received.
EFI_NETWORK_UNREACHABLE	An ICMP host unreachable error packet was received..
EFI_NETWORK_UNREACHABLE	An ICMP protocol unreachable error packet was received.
EFI_NETWORK_UNREACHABLE	An ICMP port unreachable error packet was received.
EFI_ICMP_ERROR	Some other ICMP ERROR packet was received.
EFI_TIMEOUT	No responses were received from the MTFTPv6 server.
EFI_TFTP_ERROR	An MTFTPv6 ERROR packet was received.
EFI_DEVICE_ERROR	An unexpected network error or system error occurred.

```

//*****
// EFI_MTFTP6_CHECK_PACKET
//*****
typedef
EFI_STATUS
(EFI_API *EFI_MTFTP6_CHECK_PACKET)(
    IN EFI_MTFTP6_PROTOCOL *This,
    IN EFI_MTFTP6_TOKEN *Token,
    IN UINT16 PacketLen,
    IN EFI_MTFTP6_PACKET *Packet
);
    
```

*This* Pointer to the **EFI\_MTFTP6\_PROTOCOL** instance.

*Token* The token that the caller provided in the **EFI\_MTFTP6\_PROTOCOL.ReadFile()**, **WriteFile()** or **ReadDirectory()** function. Type **EFI\_MTFTP6\_TOKEN** is defined in **EFI\_MTFTP6\_PROTOCOL.ReadFile()**.

*PacketLen* Indicates the length of the packet.

*Packet* Pointer to an MTFTPv6 packet. Type **EFI\_MTFTP6\_PACKET** is defined in **EFI\_MTFTP6\_PROTOCOL.GetInfo()**.

**EFI\_MTFTP6\_CHECK\_PACKET** is a callback function that is provided by the caller to intercept the **EFI\_MTFTP6\_OPCODE\_DATA** or **EFI\_MTFTP6\_OPCODE\_DATA8** packets processed in the **EFI\_MTFTP6\_PROTOCOL.ReadFile()** function, and alternatively to intercept **EFI\_MTFTP6\_OPCODE\_OACK** or **EFI\_MTFTP6\_OPCODE\_ERROR** packets during a call to **EFI\_MTFTP6\_PROTOCOL.ReadFile()**, **WriteFile()** or **ReadDirectory()**.



Whenever an MTFTFv6 packet with the type described above is received from a server, the EFI MTFTFv6 Protocol driver will call **EFI\_MTFTF6\_CHECK\_PACKET** function to let the caller have an opportunity to process this packet. Any status code other than **EFI\_SUCCESS** that is returned from this function will abort the transfer process.

```

//*****
// EFI_MTFTF6_TIMEOUT_CALLBACK
//*****
typedef
EFI_STATUS
(EFI_API *EFI_MTFTF6_TIMEOUT_CALLBACK)(
    IN EFI_MTFTF6_PROTOCOL *This,
    IN EFI_MTFTF6_TOKEN *Token
);

```

This	Pointer to the <b>EFI_MTFTF6_PROTOCOL</b> instance.
Token	The token that is provided in the <b>EFI_MTFTF6_PROTOCOL.ReadFile()</b> or <b>EFI_MTFTF6_PROTOCOL.WriteFile()</b> or <b>EFI_MTFTF6_PROTOCOL.ReadDirectory()</b> functions by the caller. Type <b>EFI_MTFTF6_TOKEN</b> is defined in <b>EFI_MTFTF6_PROTOCOL.ReadFile()</b> .

**EFI\_MTFTF6\_TIMEOUT\_CALLBACK** is a callback function that the caller provides to capture the timeout event in the **EFI\_MTFTF6\_PROTOCOL.ReadFile()**, **EFI\_MTFTF6\_PROTOCOL.WriteFile()** or **EFI\_MTFTF6\_PROTOCOL.ReadDirectory()** functions. Whenever a timeout occurs, the EFI MTFTFv6 Protocol driver will call the **EFI\_MTFTF6\_TIMEOUT\_CALLBACK** function to notify the caller of the timeout event. Any status code other than **EFI\_SUCCESS** that is returned from this function will abort the current download process.

```

//*****
// EFI_MTFTF6_PACKET_NEEDED
//*****
typedef
EFI_STATUS
(EFI_API *EFI_MTFTF6_PACKET_NEEDED)(
    IN EFI_MTFTF6_PROTOCOL *This,
    IN EFI_MTFTF6_TOKEN Token,
    IN OUT UINT16 *Length,
    OUT VOID **Buffer
);

```

<i>This</i>	Pointer to the <b>EFI_MTFTF6_PROTOCOL</b> instance.
Token	The token provided in the <b>EFI_MTFTF6_PROTOCOL.WriteFile()</b> by the caller.

*Length* Indicates the length of the raw data wanted on input, and the length the data available on output.

*Buffer* Pointer to the buffer where the data is stored.

**EFI\_MTFTP6\_PACKET\_NEEDED** is a callback function that the caller provides to feed data to the **EFI\_MTFTP6\_PROTOCOL.WriteFile()** function.

**EFI\_MTFTP6\_PACKET\_NEEDED** provides another mechanism for the caller to provide data to upload other than a static buffer. The EFI MTFTP6 Protocol driver always calls **EFI\_MTFTP6\_PACKET\_NEEDED** to get packet data from the caller if no static buffer was given in the initial call to **EFI\_MTFTP6\_PROTOCOL.WriteFile()** function. Setting *\*Length* to zero signals the end of the session. Returning a status code other than **EFI\_SUCCESS** aborts the session.

### Status Codes Returned

EFI_SUCCESS	The data file is being downloaded.
EFI_INVALID_PARAMETER	One or more of the parameters is not valid. <ul style="list-style-type: none"> <li>• <i>This</i> is <b>NULL</b>.</li> <li>• <i>Token</i> is <b>NULL</b>.</li> <li>• <i>Token.FileName</i> is <b>NULL</b>.</li> <li>• <i>Token.OptionCount</i> is not zero and <i>Token.OptionList</i> is <b>NULL</b>.</li> <li>• One or more options in <i>Token.OptionList</i> have wrong format.</li> <li>• <i>Token.Buffer</i> and <i>Token.CheckPacket</i> are both <b>NULL</b>.</li> <li>• <i>Token.OverrideData.ServerIp</i> is not a valid unicast IPv6 address and not set to all zero..</li> </ul>
EFI_UNSUPPORTED	One or more options in the <i>Token.OptionList</i> are not supported by this implementation.
EFI_NOT_STARTED	The EFI MTFTPv6 Protocol driver has not been started.
EFI_NO_MAPPING	The underlying IPv6 driver was responsible for choosing a source address for this instance, but no source address was available for use.
EFI_ALREADY_STARTED	This <i>Token</i> is being used in another MTFTPv6 session.
EFI_ACCESS_DENIED	The previous operation has not completed yet.
EFI_OUT_OF_RESOURCES	Required system resources could not be allocated.
EFI_DEVICE_ERROR	An unexpected network error or system error occurred.
EFI_NO_MEDIA	There was a media error.

## EFI\_MTFTP6\_PROTOCOL.WriteFile()

### Summary

Send a file to an MTFTPV6 server. May be unsupported in some implementations.

### Prototype

```
typedef
EFI_STATUS
(EFI_API *EFI_MTFTP6_WRITE_FILE)(
  IN EFI_MTFTP6_PROTOCOL *This,
  IN EFI_MTFTP6_TOKEN *Token
);
```

### Parameters

<i>This</i>	Pointer to the <b>EFI_MTFTP6_PROTOCOL</b> instance.
<i>Token</i>	Pointer to the token structure to provide the parameters that are used in this function. Type <b>EFI_MTFTP6_TOKEN</b> is defined in <b>EFI_MTFTP6_PROTOCOL.ReadFile()</b> .

### Description

The **WriteFile()** function is used to initialize an uploading operation with the given option list and optionally wait for completion. If one or more of the options is not supported by the server, the unsupported options are ignored and a standard TFTP process starts instead. When the upload process completes, whether successfully or not, *Token.Event* is signaled, and the EFI MTFTPV6 Protocol driver updates *Token.Status*.

The caller can supply the data to be uploaded in the following two modes:

- Through the user-provided buffer
- Through a callback function

With the user-provided buffer, the *Token.BufferSize* field indicates the length of the buffer, and the driver will upload the data in the buffer. With an **EFI\_MTFTP6\_PACKET\_NEEDED** callback function, the driver will call this callback function to get more data from the user to upload. See the definition of **EFI\_MTFTP6\_PACKET\_NEEDED** for more information. These two modes cannot be used at the same time. The callback function will be ignored if the user provides the buffer.

### Status Codes Returned

EFI_SUCCESS	The upload session has started.
EFI_UNSUPPORTED	The operation is not supported by this implementation.

EFI_INVALID_PARAMETER	<p>One or more of the following conditions is <b>TRUE</b>:</p> <ul style="list-style-type: none"> <li>• <i>This</i> is <b>NULL</b>.</li> <li>• <i>Token</i> is <b>NULL</b>.</li> <li>• <i>Token.FileName</i> is <b>NULL</b>.</li> <li>• <i>Token.OptionCount</i> is not zero and <i>Token.OptionList</i> is <b>NULL</b>.</li> <li>• One or more options in <i>Token.OptionList</i> have wrong format.</li> <li>• <i>Token.Buffer</i> and <i>Token.PacketNeeded</i> are both <b>NULL</b>.</li> <li>• <i>Token.OverrideData.ServerIp</i> is not a valid unicast IPv6 address and not set to all zero.</li> </ul>
EFI_UNSUPPORTED	One or more options in the <i>Token.OptionList</i> are not supported by this implementation.
EFI_NOT_STARTED	The EFI MTFTPv6 Protocol driver has not been started.
EFI_NO_MAPPING	The underlying IPv6 driver was responsible for choosing a source address for this instance, but no source address was available for use.
EFI_ALREADY_STARTED	This <i>Token</i> is already being used in another MTFTPv6 session.
EFI_OUT_OF_RESOURCES	Required system resources could not be allocated.
EFI_ACCESS_DENIED	The previous operation has not completed yet.
EFI_DEVICE_ERROR	An unexpected network error or system error occurred.
EFI_NO_MEDIA	There was a media error.

## EFI\_MTFTP6\_PROTOCOL.ReadDirectory()

### Summary

Download a data file directory from an MTFTPv6 server. May be unsupported in some implementations.

### Prototype

```
typedef
EFI_STATUS
(EFIAPI *EFI_MTFTP6_READ_DIRECTORY)(
  IN EFI_MTFTP6_PROTOCOL  *This,
  IN EFI_MTFTP6_TOKEN    *Token
);
```

### Parameters

<i>This</i>	Pointer to the <b>EFI_MTFTP6_PROTOCOL</b> instance.
<i>Token</i>	Pointer to the token structure to provide the parameters that are used in this function. Type <b>EFI_MTFTP6_TOKEN</b> is defined in <b>EFI_MTFTP6_PROTOCOL.ReadFile()</b> .

### Description

The **ReadDirectory()** function is used to return a list of files on the MTFTPv6 server that are logically (or operationally) related to *Token.FileName*. The directory request packet that is sent to the server is built with the option list that was provided by caller, if present.

The file information that the server returns is put into either of the following locations:

- A fixed buffer that is pointed to by *Token.Buffer*
- A download service function that is pointed to by *Token.CheckPacket*

If both *Token.Buffer* and *Token.CheckPacket* are used, then *Token.CheckPacket* will be called first. If the call is successful, the packet will be stored in *Token.Buffer*.

The returned directory listing in the *Token.Buffer* or **EFI\_MTFTP6\_PACKET** consists of a list of two or three variable-length ASCII strings, each terminated by a null character, for each file in the directory. If the multicast option is involved, the first field of each directory entry is the static multicast IP address and UDP port number that is associated with the file name. The format of the field is **ip:ip:ip:ip:port**. If the multicast option is not involved, this field and its terminating null character are not present.

The next field of each directory entry is the file name and the last field is the file information string. The information string contains the file size and the create/modify timestamp. The format of the information string is **filesize yyyy-mm-dd hh:mm:ss:ffff**. The timestamp is Coordinated Universal Time (UTC; also known as Greenwich Mean Time [GMT]).

### Status Codes Returned

EFI_SUCCESS	The MTFTPv6 related file "directory" has been downloaded.
-------------	---

EFI_UNSUPPORTED	The EFI MTFTPv6 Protocol driver does not support this function.
EFI_INVALID_PARAMETER	One or more of these conditions is <b>TRUE</b> : <ul style="list-style-type: none"> <li>• <i>This</i> is <b>NULL</b>.</li> <li>• <i>Token</i> is <b>NULL</b>.</li> <li>• <i>Token.FileName</i> is <b>NULL</b>.</li> <li>• <i>Token.OptionCount</i> is not zero and <i>Token.OptionList</i> is <b>NULL</b>.</li> <li>• One or more options in <i>Token.OptionList</i> have wrong format.</li> <li>• <i>Token.Buffer</i> and <i>Token.CheckPacket</i> are both <b>NULL</b>.</li> <li>• <i>Token.OverrideData.ServerIp</i> is not a valid unicast IPv6 address and not set to all zero.</li> </ul>
EFI_UNSUPPORTED	One or more options in the <i>Token.OptionList</i> are not supported by this implementation.
EFI_NOT_STARTED	The EFI MTFTPv6 Protocol driver has not been started.
EFI_NO_MAPPING	The underlying IPv6 driver was responsible for choosing a source address for this instance, but no source address was available for use.
EFI_ALREADY_STARTED	This <i>Token</i> is already being used in another MTFTPv6 session.
EFI_OUT_OF_RESOURCES	Required system resources could not be allocated.
EFI_ACCESS_DENIED	The previous operation has not completed yet.
EFI_DEVICE_ERROR	An unexpected network error or system error occurred.

## EFI\_MTFTP6\_PROTOCOL.Poll()

### Summary

Polls for incoming data packets and processes outgoing data packets.

### Prototype

```
typedef
EFI_STATUS
(EFI_API *EFI_MTFTP6_POLL) (
  IN EFI_MTFTP6_PROTOCOL *This
);
```

### Parameters

*This*

Pointer to the **EFI\_MTFTP6\_PROTOCOL** instance.

### Description

The **Poll()** function can be used by network drivers and applications to increase the rate that data packets are moved between the communications device and the transmit and receive queues.

In some systems, the periodic timer event in the managed network driver may not poll the underlying communications device fast enough to transmit and/or receive all data packets without missing incoming packets or dropping outgoing packets. Drivers and applications that are experiencing packet loss should try calling the **Poll()** function more often.

### Status Codes Returned

EFI_SUCCESS	Incoming or outgoing data was processed.
EFI_NOT_STARTED	This EFI MTFTPv6 Protocol instance has not been started.
EFI_INVALID_PARAMETER	<i>This</i> is <b>NULL</b> .
EFI_DEVICE_ERROR	An unexpected system or network error occurred.
EFI_TIMEOUT	Data was dropped out of the transmit and/or receive queue. Consider increasing the polling rate.





## 31 Secure Boot and Driver Signing

---

### 31.1 Secure Boot

This protocol is intended to provide access for generic authentication information associated with specific device paths. The authentication information is configurable using the defined interfaces. Successive configuration of the authentication information will overwrite the previously configured information. Once overwritten, the previous authentication information will not be retrievable.

#### EFI\_AUTHENTICATION\_INFO\_PROTOCOL

##### Summary

This protocol is used on any device handle to obtain authentication information associated with the physical or logical device.

##### GUID

```
#define EFI_AUTHENTICATION_INFO_PROTOCOL_GUID \
{0x7671d9d0,0x53db,0x4173,\
{0xaa,0x69,0x23,0x27,0xf2,0x1f,0x0b,0xc7}}
```

##### Protocol Interface Structure

```
typedef struct _EFI_AUTHENTICATION_INFO_PROTOCOL {
  EFI_AUTHENTICATION_INFO_PROTOCOL_GET  Get;
  EFI_AUTHENTICATION_INFO_PROTOCOL_SET  Set;
} EFI_AUTHENTICATION_INFO_PROTOCOL;
```

##### Parameters

*Get()*

Used to retrieve the Authentication Information associated with the controller handle

*Set()*

Used to set the Authentication information associated with the controller handle

##### Description

The **EFI\_AUTHENTICATION\_INFO\_PROTOCOL** provides the ability to get and set the authentication information associated with the controller handle.

## EFI\_AUTHENTICATION\_INFO\_PROTOCOL.Get()

### Summary

Retrieves the Authentication information associated with a particular controller handle.

### Prototype

```
typedef
EFI_STATUS
(EFI_API *EFI_AUTHENTICATION_INFO_PROTOCOL_GET) (
    IN EFI_AUTHENTICATION_INFO_PROTOCOL      *This,
    IN EFI_HANDLE      ControllerHandle,
    OUT VOID      **Buffer
);
```

### Parameters

<i>This</i>	Pointer to the <b>EFI_AUTHENTICATION_INFO_PROTOCOL</b>
<i>ControllerHandle</i>	Handle to the Controller
<i>Buffer</i>	Pointer to the authentication information. This function is responsible for allocating the buffer and it is the caller's responsibility to free buffer when the caller is finished with buffer.

### Description

This function retrieves the Authentication Node for a given controller handle.

### Status Codes Returned

EFI_SUCCESS	Successfully retrieved Authentication information for the given <i>ControllerHandle</i>
EFI_INVALID_PARAMETER	No matching Authentication information found for the given <i>ControllerHandle</i>
EFI_DEVICE_ERROR	The authentication information could not be retrieved due to a hardware error.

## EFI\_AUTHENTICATION\_INFO\_PROTOCOL.Set()

### Summary

Set the Authentication information for a given controller handle.

### Prototype

```
typedef
EFI_STATUS
(EFI_API *EFI_AUTHENTICATION_INFO_PROTOCOL_SET) (
    IN EFI_AUTHENTICATION_INFO_PROTOCOL *This,
    IN EFI_HANDLE ControllerHandle
    IN VOID *Buffer
);
```

### Parameters

<i>This</i>	Pointer to the <b>EFI_AUTHENTICATION_INFO_PROTOCOL</b>
<i>ControllerHandle</i>	Handle to the controller.
<i>Buffer</i>	Pointer to the authentication information.

### Description

This function sets the authentication information for a given controller handle. If the authentication node exists corresponding to the given controller handle this function overwrites the previously present authentication information.

### Status Codes Returned

EFI_SUCCESS	Successfully set the Authentication node information for the given <i>ControllerHandle</i> .
EFI_UNSUPPORTED	If the platform policies do not allow setting of the Authentication information.
EFI_DEVICE_ERROR	The authentication node information could not be configured due to a hardware error.
EFI_OUT_OF_RESOURCES	Not enough storage is available to hold the data.

### Authentication Nodes

The authentication node is associated with specific controller paths. There can be various types of authentication nodes, each describing a particular authentication method and associated properties.

### Generic Authentication Node Structures

An authentication node is a variable length binary structure that is made up of variable length authentication information. [Table 202](#) defines the generic structure. The Authentication type GUID defines the corresponding authentication node.

Table 202. Generic Authentication Node Structure

Mnemonic	Byte Offset	Byte Length	Description
Type GUID	0	16	Authentication Type GUID
Length	16	2	Length of this structure in bytes.
Specific Authentication Data	18	n	Specific Authentication Data. Type defines the authentication method and associated type of data. Size of the data is included in the length.

All Authentication Nodes are byte-packed data structures that may appear on any byte boundary. All code references to Authentication Nodes must assume all fields are UNALIGNED. Since every Authentication Node contains a length field in a known place, it is possible to traverse Authentication Node of unknown type.

#### CHAP (using RADIUS) Authentication Node

This Authentication Node type defines the CHAP authentication using RADIUS information.

**GUID**

```
#define EFI_AUTHENTICATION_CHAP_RADIUS_GUID \
{0xd6062b50,0x15ca,0x11da,\
{0x92,0x19,0x00,0x10,0x83,0xff,0xca,0x4d}}
```

**Node Definition****Table 203. CHAP Authentication Node Structure using RADIUS**

Mnemonic	Byte Offset	Byte Length	Description
Type	0	16	EFI_AUTHENTICATION_CHAP_RADIUS_GUID
Length	16	2	Length of this structure in bytes. Total length is 58+P+Q+R+S+T
RADIUS IP Address	18	16	Radius IPv4 or IPv6 Address
Reserved	34	2	Reserved
NAS IP Address	36	16	NAS IPv4 or IPv6 Address
NAS Secret Length	52	2	NAS Secret LengthP
NAS Secret	54	p	NAS Secret
CHAP Secret Length	54+P	2	CHAP Secret Length Q
CHAP Secret	56+P	q	CHAP Secret
CHAP Name Length	56 +Q	2	CHAP Name Length R
CHAP Name	58+P+Q	r	CHAP Name String
Reverse CHAP Name Length	58+P+Q+R	2	Reverse CHAP Name length
Reverse CHAP Name	60+P+Q+R	S	Reverse CHAP Name
Reverse CHAP Secret Length	60+P+Q+R+S	2	Reverse CHAP Length
Reverse CHAP Secret	62+P+Q+R+S	T	Reverse CHAP Secret

**Summary**

RADIUS IP Address	RADIUS Server IPv4 or IPv6 Address
NAS IP Address	Network Access Server IPv4 or IPv6 Address (OPTIONAL)
NAS Secret Length	Network Access Server Secret Length in bytes (OPTIONAL)
NAS Secret	Network Access Server secret (OPTIONAL)
CHAP Secret Length	CHAP Initiator Secret length in bytes
CHAP Secret	CHAP Initiator Secret
CHAP Name Length	CHAP Initiator Name Length in bytes
CHAP Name	CHAP Initiator Name
Reverse CHAP name length	Reverse CHAP name length

Reverse CHAP Name      Reverse CHAP name  
Reverse CHAP Secret Length Reverse CHAP secret length  
Reverse CHAP Secret      Reverse CHAP secret

## CHAP (using local database) Authentication Node

This Authentication Node type defines CHAP using local database information.

### GUID

```
#define EFI_AUTHENTICATION_CHAP_LOCAL_GUID \
{0xc280c73e,0x15ca,0x11da,\
{0xb0,0xca,0x00,0x10,0x83,0xff,0xca,0x4d}}
```

### Node Definition

Table 204. CHAP Authentication Node Structure using Local Database

Mnemonic	Byte Offset	Byte Length	Description
Type	0	16	EFI_AUTHENTICATION_CHAP_LOCAL_GUID
Length	16	2	Length of this structure in bytes. Total length is 58+P+Q+R+S+T
Reserved	18	2	Reserved for future use
User Secret Length	20	2	User Secret Length
User Secret	22	p	User Secret
User Name Length	22+p	2	User Name Length
User Name	24+p	q	User Name
CHAP Secret Length	24+p+q	2	CHAP Secret Length
CHAP Secret	26+p+q	r	CHAP Secret
CHAP Name Length	26+p+q+r	2	CHAP Name Length
CHAP Name	28+p+q+r	s	CHAP Name String
Reverse CHAP Name Length	58+P+Q+R	2	Reverse CHAP Name length
Reverse CHAP Name	60+P+Q+R	S	Reverse CHAP Name
Reverse CHAP Secret Length	60+P+Q+R+S	2	Reverse CHAP Length
Reverse CHAP Secret	62+P+Q+R+S	T	Reverse CHAP Secret

### Summary

User Secret Length      User Secret Length in bytes  
User Secret              User Secret  
User Name Length        User Name Length in bytes  
User Name                User Name

CHAP Secret Length	CHAP Initiator Secret length in bytes
CHAP Secret	CHAP Initiator Secret
CHAP Name Length	CHAP Initiator Name Length in bytes
CHAP Name	CHAP Initiator Name
Reverse CHAP name length	Reverse CHAP name length
Reverse CHAP Name	Reverse CHAP name
Reverse CHAP Secret Length	Reverse CHAP secret length
Reverse CHAP Secret	Reverse CHAP secret

## 31.2 UEFI Driver Signing Overview

This section describes a means of generating a digital signature for a UEFI executable, embedding that digital signature within the UEFI executable and verifying that the digital signature is from an authorized source.

The UEFI specification provides a standard format for executables. These executables may be located on un-secured media (such as a hard drive or unprotected flash device) or may be delivered via a un-secured transport layer (such as a network) or originate from a un-secured port (such as ExpressCard device or USB device). In each of these cases, the system provider may decide to authenticate either the origin of the executable or its integrity (i.e., it has not been tampered with). This section describes a means of doing so.

### 31.2.1 Digital Signatures

As a rule, digital signatures require two pieces: the data (often referred to as the *message*) and a public/private key pair. In order to create a digital signature, the message is processed by a hashing algorithm to create a hash value. This hash value is, in turn, encrypted using a signature algorithm and the private key to create the digital signature.

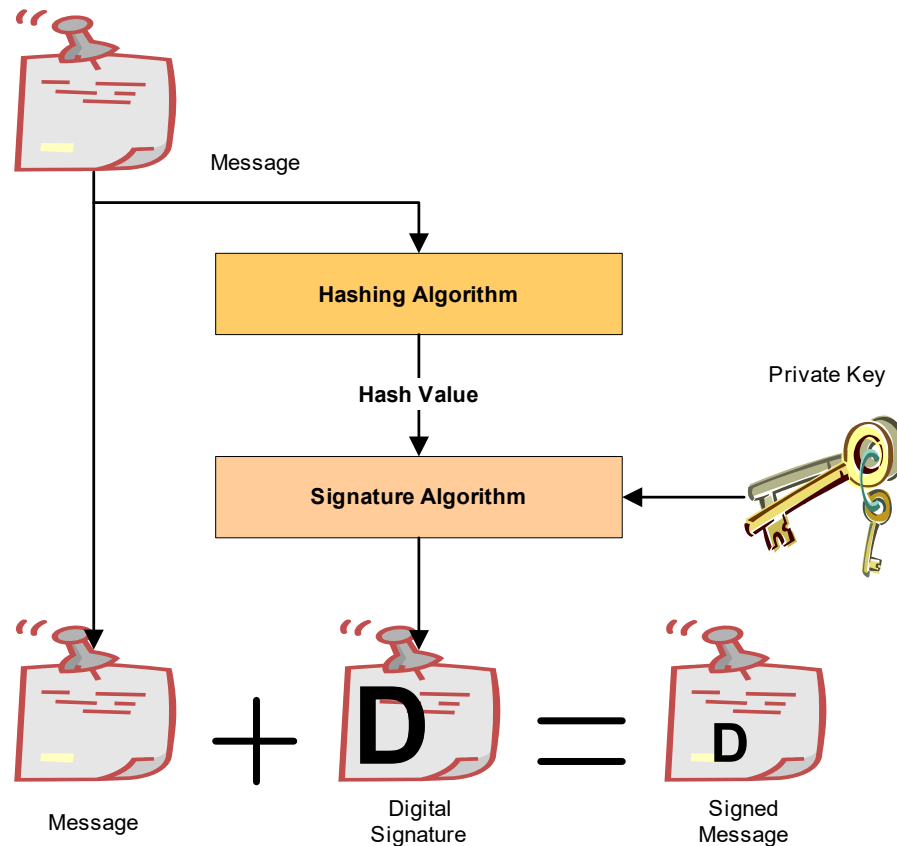

Figure 80. Creating A Digital Signature

In order to verify a signature, two pieces of data are required: the original message and the public key. First, the hash must be calculated exactly as it was calculated when the signature was created. Then the digital signature is decoded using the public key and the result is compared against the computed hash. If the two are identical, then you can be sure that message data is the one originally signed and it has not been tampered with.



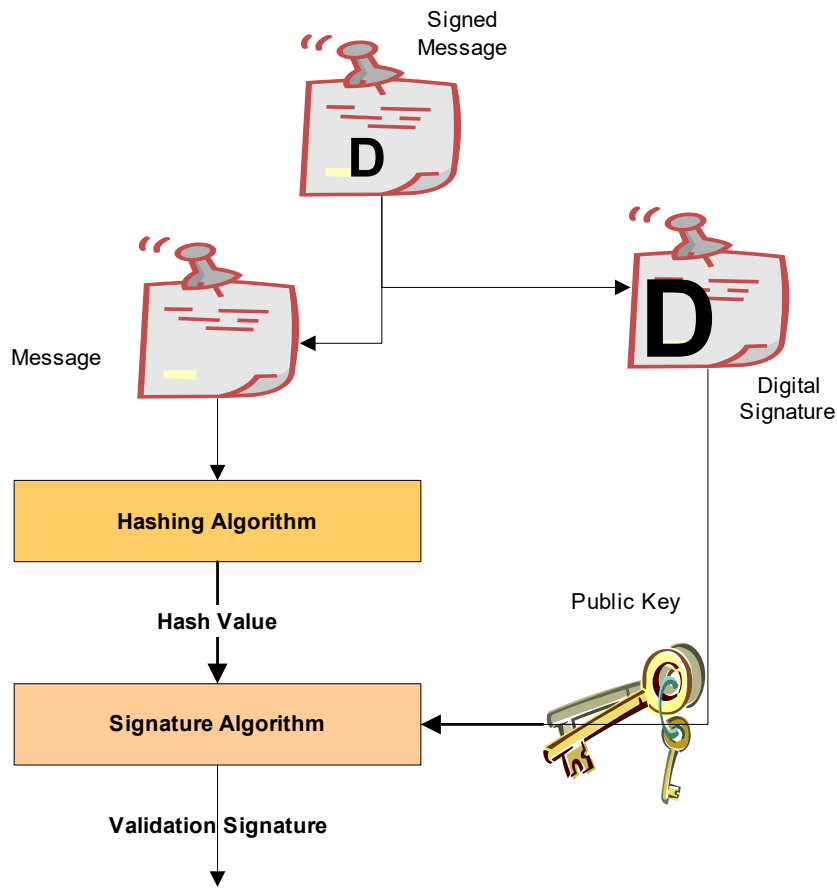
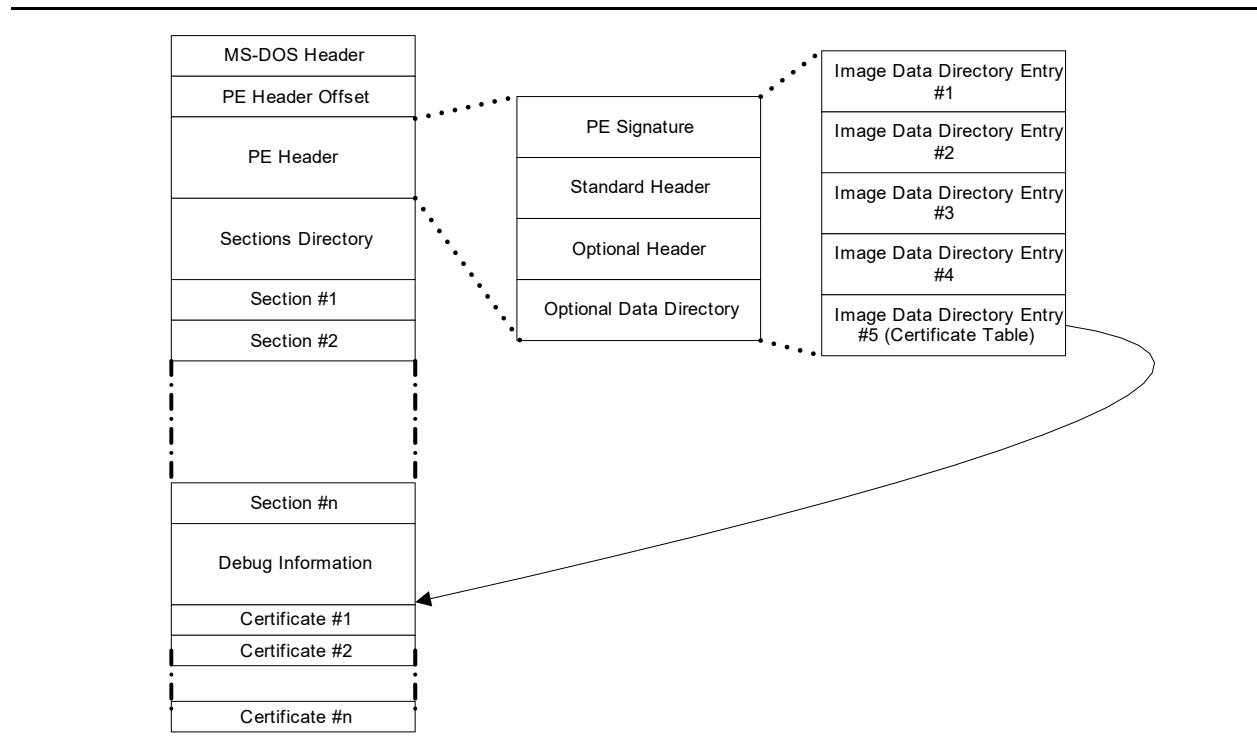

Figure 81. Verifying a Digital Signature

### 31.2.2 Embedded Signatures

The signatures used for digital signing of UEFI executables are embedded directly within the executable itself. Within the header is an array of directory entries. Each of these entries points to interesting places within the executable image. The fifth data directory entry contains a pointer to a list of certificates along with the length of the certificate areas. Each certificate may contain a digital signature used for validating the driver.

The following diagram illustrates how certificates are embedded in the PE/COFF file:



**Figure 82. Embedded Digital Certificates**

Within the PE/COFF optional header is a data directory. The 5<sup>th</sup> entry, if filled, points to a list of certificates. Normally, these certificates are appended to the end of the file.

### 31.2.3 Creating Image Digests from Images

One of the pieces required for creating a digital signature is the image digest. For a detailed description on how to create image digests from PE/COFF images, refer to the "Creating the PE Image Hash" section of the Microsoft Authenticode Format specification (see References).

### 31.2.4 Code Definitions

This section describes data structures used for signing UEFI executables.

## WIN\_CERTIFICATE

### Summary

The **WIN\_CERTIFICATE** structure is part of the PE/COFF specification.

### Prototype

```
typedef struct _WIN_CERTIFICATE {
    UINT32 dwLength;
    UINT16 wRevision;
    UINT16 wCertificateType;
    //UINT8 bCertificate[ANYSIZE_ARRAY];
} WIN_CERTIFICATE;
```

<i>dwLength</i>	The length of the entire certificate, including the length of the header, in bytes.
<i>wRevision</i>	The revision level of the <b>WIN_CERTIFICATE</b> structure. The current revision level is 0x0200.
<i>wCertificateType</i>	The certificate type. See <b>WIN_CERT_TYPE_xxx</b> for the UEFI certificate types. The UEFI specification reserves the range of certificate type values from 0x0EFO to 0x0EFF.
<i>bCertificate</i>	The actual certificate. The format of the certificate depends on <i>wCertificateType</i> . The format of the UEFI certificates is defined below.

### Related Definitions

```
#define WIN_CERT_TYPE_PKCS_SIGNED_DATA 0x0002
#define WIN_CERT_TYPE_EFI_PKCS115 0x0EFO
#define WIN_CERT_TYPE_EFI_GUID 0x0EF1
```

### Description

This structure is the certificate header. There may be zero or more certificates. I

- If the *wCertificateType* field is set to **WIN\_CERT\_TYPE\_EFI\_PKCS115**, then the certificate follows the format described in **WIN\_CERTIFICATE\_EFI\_PKCS1\_15**.
- If the *wCertificateType* field is set to **WIN\_CERT\_TYPE\_EFI\_GUID**, then the certificate follows the format described in **WIN\_CERTIFICATE\_UEFI\_GUID**.
- If the *wCertificateType* field is set to **WIN\_CERT\_TYPE\_PKCS\_SIGNED\_DATA** then the certificate is formatted as described in the Authenticode specification.

These certificates can be validated using the contents of the signature database described in [Section 31.4.1](#). The following table illustrates the relationship between the certificates and the signature types in the database.

**Note:** *In the case of a **WIN\_CERT\_TYPE\_PKCS\_SIGNED\_DATA** (or **WIN\_CERT\_TYPE\_EFI\_GUID** where *CertType* = **EFI\_CERT\_TYPE\_PKCS7\_GUID**) certificate, a match can occur against an entry in the authorized signature database (or the forbidden signature database; see*

[Section 31.6.1](#)) at *any level of the chain of X.509 certificates present in the certificate, and matches can occur against any of the applicable signature types defined in [Section 31.4](#)*:

**Table 205. PE/COFF Certificates Types and UEFI Signature Database Certificate Types**

Image Certificate Type	Verified Using Signature Database Type
<b>WIN_CERT_TYPE_EFI_PKCS115</b> ( <i>Signature</i> Size = 256 bytes)	<b>EFI_CERT_RSA2048_GUID</b> (public key)
<b>WIN_CERT_TYPE_EFI_GUID</b> ( <i>CertType</i> = <b>EFI_CERT_TYPE_RSA2048_SHA256_GUID</b> )	<b>EFI_CERT_RSA2048_GUID</b> (public key).
<b>WIN_CERT_TYPE_EFI_GUID</b> ( <i>CertType</i> = <b>EFI_CERT_TYPE_PKCS7_GUID</b> )	<b>EFI_CERT_X509_GUID</b> <b>EFI_CERT_RSA2048_GUID</b> (when applicable) <b>EFI_CERT_X509_SHA256_GUID</b> (when applicable) <b>EFI_CERT_X509_SHA384_GUID</b> (when applicable) <b>EFI_CERT_X509_SHA512_GUID</b> (when applicable)
<b>WIN_CERT_TYPE_PKCS_SIGNED_D ATA</b>	<b>EFI_CERT_X509_GUID</b> <b>EFI_CERT_RSA2048_GUID</b> (when applicable) <b>EFI_CERT_X509_SHA256_GUID</b> (when applicable) <b>EFI_CERT_X509_SHA384_GUID</b> (when applicable) <b>EFI_CERT_X509_SHA512_GUID</b> (when applicable)
(Always applicable regardless of whether a certificate is present or not)	<b>EFI_CERT_SHA1_GUID,</b> <b>EFI_CERT_SHA224_GUID,</b> <b>EFI_CERT_SHA256_GUID,</b> <b>EFI_CERT_SHA384_GUID,</b> <b>EFI_CERT_SHA512_GUID</b> In this case, the database contains the hash of the image.

## WIN\_CERTIFICATE\_EFI\_PKCS1\_15

### Summary

Certificate which encapsulates the RSASSA\_PKCS1-v1\_5 digital signature.

## Prototype

```
typedef struct _WIN_CERTIFICATE_EFI_PKCS1_15 {
    WIN_CERTIFICATE Hdr;
    EFI_GUID HashAlgorithm;
    // UINT8 Signature[ANYSIZE_ARRAY];
} WIN_CERTIFICATE_EFI_PKCS1_15;
```

<i>Hdr</i>	This is the standard <b>WIN_CERTIFICATE</b> header, where <i>wCertificateType</i> is set to <b>WIN_CERT_TYPE_EFI_PKCS1_15</b> .
<i>HashAlgorithm</i>	This is the hashing algorithm which was performed on the UEFI executable when creating the digital signature. It is one of the enumerated values pre-defined in <a href="#">Section 36.1.2.1</a> . See <b>EFI_HASH_ALGORITHM_x</b> .
<i>Signature</i>	This is the actual digital signature. The size of the signature is the same size as the key (2048-bit key is 256 bytes) and can be determined by subtracting the length of the other parts of this header from the total length of the certificate as found in <i>Hdr.dwLength</i> .

## Description

The **WIN\_CERTIFICATE\_UEFI\_PKCS1\_15** structure is derived from **WIN\_CERTIFICATE** and encapsulates the information needed to implement the RSASSA-PKCS1-v1\_5 digital signature algorithm as specified in RFC2437, sections 8-9.

## WIN\_CERTIFICATE\_UEFI\_GUID

### Summary

Certificate which encapsulates a GUID-specific digital signature.

### Prototype

```
typedef struct _WIN_CERTIFICATE_UEFI_GUID {
    WIN_CERTIFICATE Hdr;
    EFI_GUID CertType;
    UINT8 CertData[ANYSIZE_ARRAY];
} WIN_CERTIFICATE_UEFI_GUID;
```

<i>Hdr</i>	This is the standard <b>WIN_CERTIFICATE</b> header, where <i>wCertificateType</i> is set to <b>WIN_CERT_TYPE_EFI_GUID</b> .
<i>CertType</i>	This is the unique id which determines the format of the <i>CertData</i> .
<i>CertData</i>	This is the certificate data. The format of the data is determined by the <i>CertType</i> .

## Related Definitions

```
#define EFI_CERT_TYPE_RSA2048_SHA256_GUID
    {0xa7717414, 0xc616, 0x4977, \
    {0x94, 0x20, 0x84, 0x47, 0x12, 0xa7, 0x35, 0xbf}}
#define EFI_CERT_TYPE_PKCS7_GUID
    {0x4aafd29d, 0x68df, 0x49ee, \
    {0x8a, 0xa9, 0x34, 0x7d, 0x37, 0x56, 0x65, 0xa7}}
typedef struct _EFI_CERT_BLOCK_RSA_2048_SHA256 {
    EFI_GUID HashType;
    UINT8 PublicKey[256];
    UINT8 Signature[256];
} EFI_CERT_BLOCK_RSA_2048_SHA256;
```

*PublicKey*                      The RSA exponent e for this structure is 0x10001.  
*Signature*                      This signature block is PKCS 1 version 1.5 formatted.

## Description

The **WIN\_CERTIFICATE\_UEFI\_GUID** certificate type allows new types of certificates to be developed for driver authentication without requiring a new certificate type. The *CertType* defines the format of the *CertData*, which length is defined by the size of the certificate less the fixed size of the **WIN\_CERTIFICATE\_UEFI\_GUID** structure.

- If *CertType* is **EFI\_CERT\_TYPE\_RSA2048\_SHA256\_GUID** then the structure which follows has the format specified by **EFI\_CERT\_BLOCK\_RSA\_2048\_SHA256**.
- If *CertType* is **EFI\_CERT\_TYPE\_PKCS7\_GUID** then the *CertData* component shall contain a DER-encoded PKCS #7 version 1.5 [RFC2315] *SignedData* value.

## 31.3 Firmware/OS Key Exchange: creating trust relationships

This section describes a means of creating a trust relationship between the platform owner, the platform firmware, and an operating system. This trust relationship enables the platform firmware and one or more operating systems to exchange information in a secure manner.

The trust relationship uses two types of asymmetric key pairs:

### Platform Key (PK)

The platform key establishes a trust relationship between the platform owner and the platform firmware. The platform owner enrolls the public half of the key (PK<sub>pub</sub>) into the platform firmware. The platform owner can later use the private half of the key (PK<sub>priv</sub>) to change platform ownership or to enroll a Key Exchange Key. For UEFI, the recommended Platform Key format is RSA-2048. See “Enrolling The Platform Key” and “Clearing The Platform Key” for more information.

### Key Exchange Key (KEK)

Key exchange keys establish a trust relationship between the operating system and the platform firmware. Each operating system (and potentially,

each 3<sup>rd</sup> party application which need to communicate with platform firmware) enrolls a public key (KEK<sub>pub</sub>) into the platform firmware. See "Enrolling Key Exchange Keys" for more information.

While no Platform Key is enrolled, the SetupMode variable *shall* be equal to 1. While SetupMode == 1, the platform firmware *shall not* require authentication in order to modify the Platform Key, Key Enrollment Key, OsRecoveryOrder, OsRecovery####, and image security databases.

After the Platform Key is enrolled, the SetupMode variable shall be equal to 0. While SetupMode == 0, the platform firmware *shall* require authentication in order to modify the Platform Key, Key Enrollment Key, OsRecoveryOrder, OsRecovery####, and image security databases.

While no Platform Key is enrolled, and while the variable AuditMode == 0, the platform is said to be operating in *setup* mode.

After the Platform Key is enrolled, and while the variable AuditMode == 0, the platform is operating in *user* mode. The platform will continue to operate in user mode until the Platform Key is cleared, or the system is transitioned to either Audit or Deployed Modes. See "Clearing The Platform Key," "Transitioning to Audit Mode," and "Transitioning to Deployed Mode" for more information.

Audit Mode enables programmatic discovery of signature list combinations that successfully authenticate installed EFI images without the risk of rendering a system unbootable. Chosen signature lists configurations can be tested to ensure the system will continue to boot after the system is transitioned out of Audit Mode. Details on how to transition to Audit Mode are detailed below in the section "Transitioning to Audit Mode." After transitioning to Audit Mode, signature enforcement is disabled such that all images are initialized and enhanced Image Execution Information Table (IEIT) logging is performed including recursive validation for multi-signed images.

Deployed Mode is the most secure mode. For details on transitioning to Deployed Mode see the section "Transitioning to Deployed Mode" below. By design, both User Mode and Audit Mode support unauthenticated transitions to Deployed Mode. However, to move from Deployed Mode to any other mode requires a secure platform-specific method, or deleting the PK, which is authenticated.

Secure Boot Mode transitions to User Mode or Deployed Mode shall take effect immediately. Mode transitions to Setup Mode or Audit Mode may either take effect immediately (recommended) or after a reset. For implementations that require a reset, the mode transition shall be processed prior to the initialization of the SecureBoot variable, and the SetVariable() workflow shall be as follows:

1. If the variable has an authenticated attribute, it shall be authenticated as specified, and failure will result in immediate termination of this workflow by returning the appropriate error.
2. Check secure storage to determine if a Secure Boot Mode transition is already queued. If a transition is already queued, terminate this workflow by returning EFI\_ALREADY\_STARTED
3. Queue the request to secure storage
4. The Secure Boot Mode and Policy variables SHALL remain unchanged

5. Return `EFI_WARN_RESET_REQUIRED`.
6. After reboot, if the transition is successful, Secure Boot Mode and Policy variables will change accordingly. If the transition to lower security modes is rejected or fail, the workflow is terminated and the Secure Boot Mode and Policy variables remain unchanged

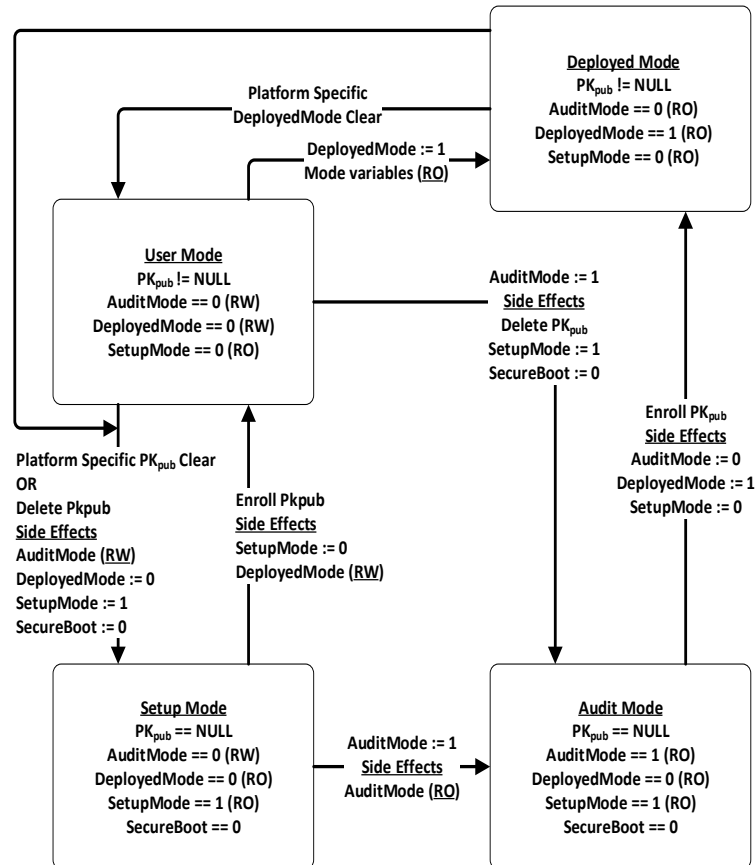

Figure 83. Secure Boot Modes

### 31.3.1 Enrolling The Platform Key

The platform owner enrolls the public half of the Platform Key ( $PK_{pub}$ ) by calling the UEFI Boot Service `SetVariable()` as specified in [Section 8.2.1](#). If the platform is in setup mode, then the new  $PK_{pub}$  may be signed with its  $PK_{priv}$  counterpart. If the platform is in user mode, then the new  $PK_{pub}$  must be signed with the current  $PK_{priv}$ . When the platform is in setup mode, a successful enrollment of a Platform Key shall cause the platform to immediately transition to user mode.

The authenticated PK variable can always be read but can only be written if the platform is in setup mode, or if the platform is in user mode and the provided  $PK_{pub}$  is signed with the current  $PK_{priv}$ .



The name and GUID of the Platform Key variable are specified in [Section 3.3](#) “Globally Defined Variables” The variable has the format of a signature database as described in “Signature Database” below, with exactly one entry.

The platform vendor may provide a default PKpub in the PKDefault variable described in [Section 3.3](#). This variable is formatted identically to the Platform Key variable. If present, this key may optionally be used as the public half of the Platform Key when transitioning from setup mode to user mode. If so, it may be read, placed within an **EFI\_VARIABLE\_AUTHENTICATION2** structure and copied to the Platform Key variable using the **SetVariable()** call.

### 31.3.2 Clearing The Platform Key

The platform owner clears the public half of the Platform Key (PK<sub>pub</sub>) by deleting the Platform Key variable using UEFI Runtime Service **SetVariable()**. The data buffer submitted to the **SetVariable()** must be signed with the current PK<sub>priv</sub>; see [Section 8.2](#) for details. The name and GUID of the Platform Key variable are specified in [Section 3.3](#), “Globally Defined Variables”

The platform key may also be cleared using a secure platform-specific method. When platform key is cleared, the global variable SetupMode must also be updated to 1.

### 31.3.3 Transitioning to Audit Mode

To enter Audit Mode, a new UEFI variable AuditMode is set to 1. Entering Audit Mode has the side effect of changing SetupMode == 1, PK is cleared, and the new DeployedMode == 0.

*Note:* The AuditMode variable is only writable before **ExitBootServices()** is called when the system is *not* in Deployed Mode. See [Figure 83](#) for more details.

### 31.3.4 Transitioning to Deployed Mode

To enter Deployed Mode from Audit Mode, set the variable PK. To enter Deployed Mode from User Mode, set the variable DeployedMode to 1. This transition takes effect immediately with no reset required. Entering Deployed Mode has the side effect of changing SetupMode == 0, AuditMode == 0 and is made read-only, and DeployedMode == 1 and is made read-only. See [Figure 83](#) for more details.

### 31.3.5 Enrolling Key Exchange Keys

Key exchange keys are stored in a signature database as described in “Signature Database” below. The signature database is stored as an authenticated UEFI variable.

The platform owner enrolls the key exchange keys by either calling **SetVariable()** as specified in [Section 8.2.1](#) with the **EFI\_VARIABLE\_APPEND\_WRITE** attribute set and the *Data* parameter containing the new key(s), or by reading the database using **GetVariable()**, appending the new key exchange key to the existing keys and then writing the database using **SetVariable()** as specified in [Section 8.2.1](#) without the **EFI\_VARIABLE\_APPEND\_WRITE** attribute set.

The authenticated UEFI variable that stores the key exchange keys (KEKs) can always be read but only be written if:

- The platform is in user mode and the provided variable data is signed with the current  $PK_{priv}$ ;

or if

- The platform is in setup mode (in this case the variable can be written without a signature validation, but the **SetVariable()** call needs to be formatted in accordance with the procedure for authenticated variables in [Section 8.2.1](#))

The name and GUID of the Key Exchange Key variable are specified in [Section 3.3](#), “Globally Defined Variables.”

The platform vendor may provide a default set of Key Exchange Keys in the KEKDefault variable described in [Section 3.3](#). If present, these keys (or a subset) may optionally be used when performing the initial enrollment of Key Exchange Keys. If any are to be used, they may be parsed from the variable and enrolled as described above.

### 31.3.6 Platform Firmware Key Storage Requirements

This section describes the platform firmware storage requirements of the different types of keys.

#### Platform Keys:

The public key must be stored in non-volatile storage which is tamper and delete resistant.

#### Key Exchange Keys:

The public key must be stored in non-volatile storage which is tamper resistant.

Careful consideration should be given to the security and configuration of any out-of-band management agent (e.g. hypervisor or service processor) such that the platform cannot exploit the management agent in order to circumvent Secure Boot.

## 31.4 Firmware/OS Key Exchange: passing public keys

This section describes a means of passing public keys from the OS to the platform firmware so that these keys can be used to securely pass information between the OS and the platform firmware.

Typically, the OS has been unable to communicate sensitive information or enforce any sort of policy because of the possibility of spoofing by a malicious software agent. That is, the platform firmware has been unable to trust the OS. By enrolling these public keys, authorized by the platform owner, the platform firmware can now check the signature of data passed by the operating system.

Of course if the malicious software agent is running as part of the OS, such as a rootkit, then any communication between the firmware and operating system still remains the subject of spoofing as the malicious code has access to the key exchange key.

## 31.4.1 Signature Database

### EFI\_SIGNATURE\_DATA

#### Summary

The format of a signature database.

#### Prototype

```
#pragma pack(1)
typedef struct _EFI_SIGNATURE_DATA {
    EFI_GUID      SignatureOwner;
    UINT8        SignatureData[...];
} EFI_SIGNATURE_DATA;

typedef struct _EFI_SIGNATURE_LIST {
    EFI_GUID      SignatureType;
    UINT32        SignatureListSize;
    UINT32        SignatureHeaderSize;
    UINT32        SignatureSize;
    // UINT8      SignatureHeader[SignatureHeaderSize];
    // EFI_SIGNATURE_DATA Signatures[...][SignatureSize];
} EFI_SIGNATURE_LIST;
#pragma pack()
```

#### Members

##### *SignatureListSize*

Total size of the signature list, including this header.

##### *SignatureType*

Type of the signature. GUID signature types are defined in "Related Definitions" below.

##### *SignatureHeaderSize*

Size of the signature header which precedes the array of signatures.

##### *SignatureSize*

Size of each signature. Must be at least the size of **EFI\_SIGNATURE\_DATA**.

##### *SignatureHeader*

Header before the array of signatures. The format of this header is specified by the *SignatureType*.

##### *Signatures*

An array of signatures. Each signature is *SignatureSize* bytes in length. The format of the signature is defined by the *SignatureType*.

*SignatureOwner*

An identifier which identifies the agent which added the signature to the list.

**Description**

The signature database consists of zero or more signature lists. The size of the signature database can be determined by examining the size of the UEFI variable.

Each signature list is a list of signatures of one type, identified by *SignatureType*. The signature list contains a header and then an array of zero or more signatures in the format specified by the header. The size of each signature in the signature list is specified by *SignatureSize*.

Each signature has an owner *SignatureOwner*, which is a GUID identifying the agent which inserted the signature in the database. Agents might include the operating system or an OEM-supplied driver or application. Agents may examine this field to understand whether they should manage the signature or not.

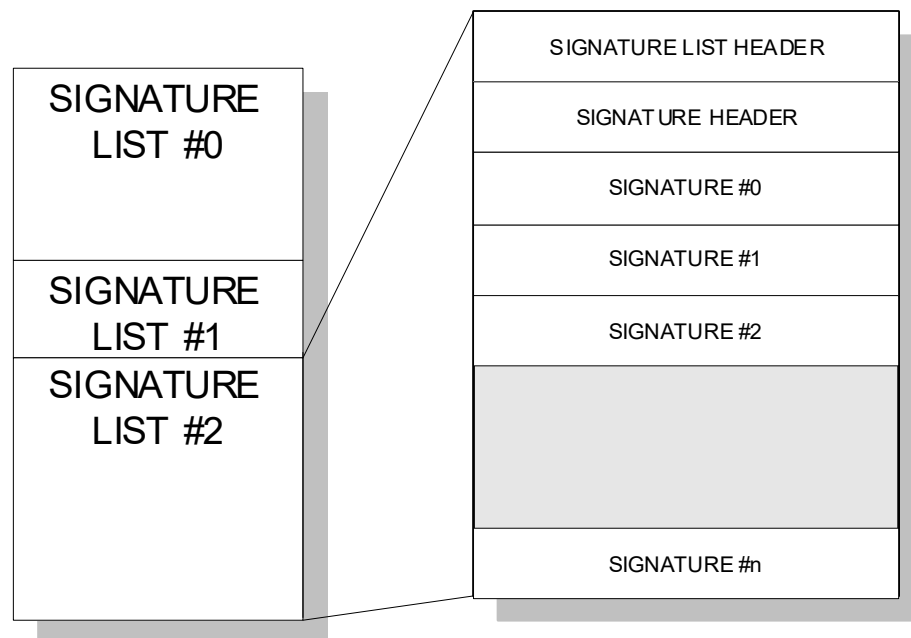

Figure 84. Signature lists

**Related Definitions**

```
#define EFI_CERT_SHA256_GUID \
{ 0xc1c41626, 0x504c, 0x4092, \
  { 0xac, 0xa9, 0x41, 0xf9, 0x36, 0x93, 0x43, 0x28 } };
```

This identifies a signature containing a SHA-256 hash. The *SignatureHeader* size shall always be 0. The *SignatureSize* shall always be 16 (size of *SignatureOwner* component) + 32 bytes.

```
#define EFI_CERT_RSA2048_GUID \
  { 0x3c5766e8, 0x269c, 0x4e34, \
    { 0xaa, 0x14, 0xed, 0x77, 0x6e, 0x85, 0xb3, 0xb6 } };
```

This identifies a signature containing an RSA-2048 key. The key (only the modulus since the public key exponent is known to be 0x10001) shall be stored in big-endian order.

The *SignatureHeader* size shall always be 0. The *SignatureSize* shall always be 16 (size of *SignatureOwner* component) + 256 bytes.

```
#define EFI_CERT_RSA2048_SHA256_GUID \
  { 0xe2b36190, 0x879b, 0x4a3d, \
    { 0xad, 0x8d, 0xf2, 0xe7, 0xbb, 0xa3, 0x27, 0x84 } };
```

This identifies a signature containing a RSA-2048 signature of a SHA-256 hash. The *SignatureHeader* size shall always be 0. The *SignatureSize* shall always be 16 (size of *SignatureOwner* component) + 256 bytes.

```
#define EFI_CERT_SHA1_GUID \
  { 0x826ca512, 0xcf10, 0x4ac9, \
    { 0xb1, 0x87, 0xbe, 0x01, 0x49, 0x66, 0x31, 0xbd } };
```

This identifies a signature containing a SHA-1 hash. The *SignatureSize* shall always be 16 (size of *SignatureOwner* component) + 20 bytes.

```
#define EFI_CERT_RSA2048_SHA1_GUID \
  { 0x67f8444f, 0x8743, 0x48f1, \
    { 0xa3, 0x28, 0x1e, 0xaa, 0xb8, 0x73, 0x60, 0x80 } };
```

This identifies a signature containing a RSA-2048 signature of a SHA-1 hash. The *SignatureHeader* size shall always be 0. The *SignatureSize* shall always be 16 (size of *SignatureOwner* component) + 256 bytes.

```
#define EFI_CERT_X509_GUID \
  { 0xa5c059a1, 0x94e4, 0x4aa7, \
    { 0x87, 0xb5, 0xab, 0x15, 0x5c, 0x2b, 0xf0, 0x72 } };
```

This identifies a signature based on a DER-encoded X.509 certificate. If the signature is an X.509 certificate then verification of the signature of an image should validate the public key certificate in the image using certificate path verification, up to this X.509 certificate as a trusted root. The *SignatureHeader* size shall always be 0. The *SignatureSize* may vary but shall always be 16 (size of the *SignatureOwner* component) + the size of the certificate itself.

**Note:** This means that each certificate will normally be in a separate **EFI\_SIGNATURE\_LIST**.

```
#define EFI_CERT_SHA224_GUID \
{ 0xb6e5233, 0xa65c, 0x44c9, \
  0x94, 0x07, 0xd9, 0xab, 0x83, 0xbf, 0xc8, 0xbd };
```

This identifies a signature containing a SHA-224 hash. The *SignatureHeader* size shall always be 0. The *SignatureSize* shall always be 16 (size of *SignatureOwner* component) + 28 bytes.

```
#define EFI_CERT_SHA384_GUID \
{ 0xff3e5307, 0x9fd0, 0x48c9, \
  0x85, 0xf1, 0x8a, 0xd5, 0x6c, 0x70, 0x1e, 0x01};
```

This identifies a signature containing a SHA-384 hash. The *SignatureHeader* size shall always be 0. The *SignatureSize* shall always be 16 (size of *SignatureOwner* component) + 48 bytes.

```
#define EFI_CERT_SHA512_GUID \
{ 0x93e0fae, 0xa6c4, 0x4f50, \
  0x9f, 0x1b, 0xd4, 0x1e, 0x2b, 0x89, 0xc1, 0x9a}
```

This identifies a signature containing a SHA-512 hash. The *SignatureHeader* size shall always be 0. The *SignatureSize* shall always be 16 (size of *SignatureOwner* component) + 64 bytes.

```
#define EFI_CERT_X509_SHA256_GUID \
{ 0x3bd2a492, 0x96c0, 0x4079, \
  0xb4, 0x20, 0xfc, 0xf9, 0x8e, 0xf1, 0x03, 0xed };
```

## Prototype

```
#pragma pack(1)
typedef struct _EFI_CERT_X509_SHA256 {
  EFI_SHA256_HASH  ToBeSignedHash;
  EFI_TIME        TimeOfRevocation;
} EFI_CERT_X509_SHA256;
#pragma pack()
```

## Members

### *ToBeSignedHash*

The SHA256 hash of an X.509 certificate's To-Be-Signed contents.

### *TimeOfRevocation*

The time that the certificate shall be considered to be revoked.

This identifies a signature containing the SHA256 hash of an X.509 certificate's To-Be-Signed contents, and a time of revocation. The *SignatureHeader* size shall always be 0. The *SignatureSize* shall always be 16 (size of the *SignatureOwner* component) + 48 bytes for an **EFI\_CERT\_X509\_SHA256** structure. If the *TimeOfRevocation* is non-zero,

the certificate should be considered to be revoked from that time and onwards, and otherwise the certificate shall be considered to always be revoked.

```
#define EFI_CERT_X509_SHA384_GUID \
{ 0x7076876e, 0x80c2, 0x4ee6, \
  { 0xaa, 0xd2, 0x28, 0xb3, 0x49, 0xa6, 0x86, 0x5b } };
```

## Prototype

```
#pragma pack(1)
typedef struct _EFI_CERT_X509_SHA384 {
  EFI_SHA384_HASH  ToBeSignedHash;
  EFI_TIME         TimeOfRevocation;
} EFI_CERT_X509_SHA384;
#pragma pack()
```

## Members

<i>ToBeSignedHash</i>	The SHA384 hash of an X.509 certificate's To-Be-Signed contents.
<i>TimeOfRevocation</i>	The time that the certificate shall be considered to be revoked.

This identifies a signature containing the SHA384 hash of an X.509 certificate's To-Be-Signed contents, and a time of revocation. The *SignatureHeader* size shall always be 0. The *SignatureSize* shall always be 16 (size of the *SignatureOwner* component) + 64 bytes for an **EFI\_CERT\_X509\_SHA384** structure. If the *TimeOfRevocation* is non-zero, the certificate should be considered to be revoked from that time and onwards, and otherwise the certificate shall be considered to always be revoked.

```
#define EFI_CERT_X509_SHA512_GUID \
{ 0x446dbf63, 0x2502, 0x4cda, \
  { 0xbc, 0xfa, 0x24, 0x65, 0xd2, 0xb0, 0xfe, 0x9d } };
```

## Prototype

```
#pragma pack(1)
typedef struct _EFI_CERT_X509_SHA512 {
  EFI_SHA512_HASH  ToBeSignedHash;
  EFI_TIME         TimeOfRevocation;
} EFI_CERT_X509_SHA512;
#pragma pack()
```

## Members

<i>ToBeSignedHash</i>	The SHA512 hash of an X.509 certificate's To-Be-Signed contents.
<i>TimeOfRevocation</i>	The time that the certificate shall be considered to be revoked.

This identifies a signature containing the SHA512 hash of an X.509 certificate's To-Be-Signed contents, and a time of revocation. The *SignatureHeader* size shall always be 0. The *SignatureSize* shall always be 16 (size of the *SignatureOwner* component) + 80 bytes for an **EFI\_CERT\_X509\_SHA512** structure. If the *TimeOfRevocation* is non-zero, the certificate should be considered to be revoked from that time and onwards, and otherwise the certificate shall be considered to always be revoked.

```
#define EFI_CERT_EXTERNAL_MANAGEMENT_GUID \
  { 0x452e8ced, 0xdfff, 0x4b8c, \
    { 0xae, 0x01, 0x51, 0x18, 0x86, 0x2e, 0x68, 0x2c } };
```

This *SignatureType* describes a pseudo-signature which will not facilitate authentication. It is only meaningful within a signature list used for authenticating writes through **SetVariable()**, and is only effective if it is the only signature present in that signature list. It allows a signature list to be populated without providing any means for **SetVariable()** to succeed. This signature type is intended for use on a platform with an external out-of-band management agent (e.g. hypervisor or service processor). When a platform is configured such that only signatures of this *SignatureType* are available for authenticating writes to a variable, that variable may only be modified by the external management agent using a platform-specific interface.

When a write may be authenticated using any signature from multiple signature lists, the presence of this signature in one of those signature lists does not inhibit the use of signatures present in the other signature lists. For example, if this signature is placed in PK, an attempt to write to db using **SetVariable()** will still succeed if it is signed by a valid KEKpriv, but a write to PK or KEK through **SetVariable()** cannot succeed because no PKpriv exists.

The *SignatureHeader* size shall always be 0. The *SignatureSize* shall always be 16 (size of *SignatureOwner* component) + 1 byte. The one byte of *SignatureData* exists only for compatibility reasons; It should be written as zero, and any value read should be ignored.

## 31.4.2 Image Execution Information Table

### Summary

When **AuditMode==0**, if the image's signature is not found in the authorized database, or is found in the forbidden database, the image will not be started and instead, information about it will be placed in this table.

When **AuditMode==1**, an **EFI\_IMAGE\_EXECUTION\_INFO** element is created in the **EFI\_IMAGE\_EXECUTION\_INFO\_TABLE** for every certificate found in the certificate table of every image that is validated.

Additionally for every image, an element will be created in the table for every **EFI\_CERT\_SHAXXX** that is supported by the platform. The contents of **Action** for each element are determined by comparing that specific element's *Signature* (which will contain exactly 1 **EFI\_SIGNATURE\_DATA**) to the currently-configured image security databases and policies, and shall be either **EFI\_IMAGE\_EXECUTION\_AUTH\_SIG\_PASSED**,



**EFI\_IMAGE\_EXECUTION\_AUTH\_SIG\_FAILED**, or  
**EFI\_IMAGE\_EXECUTION\_POLICY\_FAILED**.

Finally, because the system is in Audit Mode, all modules are initialized even if they fail to authenticate, and the **EFI\_IMAGE\_EXECUTION\_INITIALIZED** bit shall be set in **Action** for all elements.

## Prototype

```
typedef struct {
    EFI_IMAGE_EXECUTION_ACTION Action;
    UINT32 InfoSize;
    // CHAR16 Name[...];
    // EFI_DEVICE_PATH_PROTOCOL DevicePath;
    // EFI_SIGNATURE_LIST Signature;
} EFI_IMAGE_EXECUTION_INFO;
```

## Parameters

### *Action*

Describes the action taken by the firmware regarding this image. Type **EFI\_IMAGE\_EXECUTION\_ACTION** is described in “Related Definitions” below.

### *InfoSize*

Size of all of the entire structure.

### *Name*

If this image was a UEFI device driver (for option ROM, for example) this is the null-terminated, user-friendly name for the device. If the image was for an application, then this is the name of the application. If this cannot be determined, then a simple NULL character should be put in this position.

### *DevicePath*

Image device path. The image device path typically comes from the Loaded Image Device Path Protocol installed on the image handle. If image device path cannot be determined, a simple end-of-path device node should be put in this position.

### *Signature*

Zero or more image signatures. If the image contained no signatures, then this field is empty. The type **WIN\_CERTIFICATE** is defined in chapter 26.

## Prototype

```
typedef struct {
    UINTN NumberOfImages;
    EFI_IMAGE_EXECUTION_INFO InformationInfo[...]
} EFI_IMAGE_EXECUTION_INFO_TABLE;
```

*NumberOfImages* Number of **EFI\_IMAGE\_EXECUTION\_INFO** structures.  
*InformationInfo NumberOfImages* instances of **EFI\_IMAGE\_EXECUTION\_INFO** structures.

## Related Definitions

```
typedef UINT32 EFI_IMAGE_EXECUTION_ACTION;

#define EFI_IMAGE_EXECUTION_AUTHENTICATION 0x00000007
#define EFI_IMAGE_EXECUTION_AUTH_UNTESTED 0x00000000
#define EFI_IMAGE_EXECUTION_AUTH_SIG_FAILED 0x00000001
#define EFI_IMAGE_EXECUTION_AUTH_SIG_PASSED 0x00000002
#define EFI_IMAGE_EXECUTION_AUTH_SIG_NOT_FOUND 0x00000003
#define EFI_IMAGE_EXECUTION_AUTH_SIG_FOUND 0x00000004
#define EFI_IMAGE_EXECUTION_POLICY_FAILED 0x00000005

#define EFI_IMAGE_EXECUTION_INITIALIZED 0x00000008
```

## Description

This structure describes an image in the EFI System Configuration Table. It is only required in the case where image signatures are being checked and the image was not initialized because its signature failed, when `AuditMode==1`, or was not found in the signature database *and* an authorized user or the owner would not authorize its execution. It may be used in other cases as well.

In these cases, the information about the image is copied into the EFI System Configuration Table. Information about other images which were successfully initialized may also be included as well, but this is not required.

The *Action* field describes what action the firmware took with regard to the image and what other information it has about the image, including the device which it is related to. First, this field describes the results of the firmware's attempt to authenticate the image.

1. If **EFI\_IMAGE\_EXECUTION\_AUTH\_UNTESTED** is set, then no authentication attempt was made.
2. If **EFI\_IMAGE\_EXECUTION\_AUTH\_SIG\_FAILED** is set, then the image had at least one digital signature and the check of the digital signatures failed.
3. If **EFI\_IMAGE\_EXECUTION\_AUTH\_SIG\_PASSED** is set, then the image had at least one valid digital signature and a check of that digital signature passed.
4. If **EFI\_IMAGE\_EXECUTION\_AUTH\_SIG\_NOT\_FOUND** is set, then the image's signature could not be found in the signature database.
5. If **EFI\_IMAGE\_EXECUTION\_AUTH\_SIG\_FOUND** is set, then the image's signature was found in the signature database.
6. If **EFI\_IMAGE\_EXECUTION\_POLICY\_FAILED** is set, then authentication failed because of (unspecified) firmware security policy.

Second, this field describes whether the image was initialized or not.

This table can be used by an agent which executes later to audit which images were not loaded and perhaps query other sources to discover whether the image should be authorized. If so, the agent can use the method described in “Signature Database Update” to update the Signature Database with the image’s signature. Switching the system into Audit Mode generates a more verbose table which provides additional insights to this agent.

If an attempt to boot a legacy non-UEFI OS takes place when the system is in User Mode, the OS load shall fail and a corresponding **EFI\_IMAGE\_EXECUTION\_INFO** entry shall be created with Action set to **EFI\_IMAGE\_EXECUTION\_AUTH\_UNTESTED**, Name set to the NULL-terminated “Description String” from the BIOS Boot Specification Device Path and DevicePath set to the BIOS Boot Specification Device Path (see [Section 10.3.7](#)).

## 31.5 UEFI Image Validation

### 31.5.1 Overview

This section describes a way to use the platform ownership model described in the previous section and the key exchange mechanism to allow the firmware to authenticate a UEFI image, such as an OS loader or an option ROM, using the digital signing mechanisms described here.

The hand-off between the platform firmware and the operating system is a critical part of ensuring secure boot. Since there are large numbers of operating systems and a large number of minor variations in the loaders for those operating systems, it is difficult to carry all possible keys or signatures within the firmware as it ships. This requires some sort of update mechanism, to identify the proper loader. But, as with any update mechanism, there is the risk of allowing malicious software to “authenticate” itself, posing as the real operating system.

Likewise, there are a large number of potential 3<sup>rd</sup>-party UEFI applications, drivers and option ROMs and it is difficult to carry all possible keys or signatures within the firmware as it ships.

The mechanism described here requires that the platform firmware maintain a signature database, with entries for each authorized UEFI image (the authorized UEFI signature database). The signature database is a single UEFI Variable.

It also requires that the platform firmware maintain a signature database with entries for each forbidden UEFI image. This signature database is also a single UEFI variable.

The signature database is checked when the UEFI Boot Manager is about to start a UEFI image. If the UEFI image’s signature is not found in the authorized database, or is found in the forbidden database, the UEFI image will be deferred and information placed in the Image Execution Information Table. In the case of OS Loaders, the next boot option will be selected. The signature databases may be updated by the firmware, by a pre-OS application or by an OS application or driver.

If a firmware supports the **EFI\_CERT\_X509\_SHA\*\_GUID** signature types, it should support the RFC3161 timestamp specification. Images whose signature matches one of these types in the forbidden signature database shall only be considered forbidden if the

firmware either does not support timestamp verification, or the signature type has a time of revocation equal to zero, or the timestamp does not pass verification against the authorized timestamp and forbidden signature databases, or finally the signature type's time of revocation is less than or equal to the time recorded in the image signature's timestamp. If the timestamp's signature is authorized by the authorized timestamp database and the time recorded in the timestamp is less than the time of revocation, the image shall not be considered forbidden provided it is not forbidden by any other entry in the forbidden signature database. Finally, this requires that firmware supporting timestamp verification must support the authorized timestamp database and have a suitable time stamping authority certificate in that database.

### 31.5.2 Authorized User

An *authorized user* (for the purposes of UEFI image security) is one who possesses a key exchange key (KEK<sub>priv</sub>). This key is used to sign updates to the signature databases.

### 31.5.3 Signature Database Update

The Authorized, Forbidden, Timestamp, and Recovery signature databases are stored as UEFI authenticated variables (see Variable Services in [Section 8.2](#)) with the GUID **EFI\_IMAGE\_SECURITY\_DATABASE\_GUID** and the names **EFI\_IMAGE\_SECURITY\_DATABASE**, **EFI\_IMAGE\_SECURITY\_DATABASE1**, **EFI\_IMAGE\_SECURITY\_DATABASE2**, and **EFI\_IMAGE\_SECURITY\_DATABASE3**, respectively.

These authenticated UEFI variables that store the signature databases (db, dbx, dbr, or dbt) can always be read but can only be written if:

- The platform is in user mode and the provided variable data is signed with the private half of a previously enrolled key exchange key (KEK<sub>priv</sub>), or the platform private key (PK<sub>priv</sub>);

or if

- The platform is in setup mode (in this case the variables can be written without a signature validation, but the **SetVariable()** call needs to be formatted in accordance with the procedure for authenticated variables in [Section 8.2.1](#))

The signature databases are in the form of Signature Databases, as described in "Signature Database" above.

The platform vendor may provide a default set of entries for the Signature Database in the dbDefault, dbxDefault, dbtDefault, and dbrDefault variables described in [Section 3.3](#). If present, these keys (or a subset) may optionally be used when performing the initial enrollment of signature database entries. If any are to be used, they may be parsed from the variable and enrolled as described below.

If, when adding a signature to the signature database, **SetVariable()** returns **EFI\_OUT\_OF\_RESOURCES**, indicating there is no more room, the updater may discard the new signature or it may decide to discard one of the database entries. These

authenticated UEFI variables that store the signature databases (db, or dbx, dbt, or dbr) can always be read but can only be written if:

The following diagram illustrates the process for adding a new signature by the OS or an application that has access to a previously enrolled key exchange key using **SetVariable()**. In the diagram, the **EFI\_VARIABLE\_APPEND\_WRITE** attribute is not used. If **EFI\_VARIABLE\_APPEND\_WRITE** had been used, then steps 2 and 3 could have been omitted and step 7 would have included setting the **EFI\_VARIABLE\_APPEND\_WRITE** attribute.

1. The procedure begins by generating a new signature, in the format described by the Signature Database.
2. Call **GetVariable()** using **EFI\_IMAGE\_SECURITY\_DATABASE\_GUID** for the *VendorGuid* parameter and **EFI\_IMAGE\_SECURITY\_DATABASE** for the *VariableName* parameter.
3. If the variable exists, go to step 5.
4. Create an empty authorized signature database.
5. Create a new buffer which contains the authorized signature database, along with the new signature appended to the end.
6. Sign the new signature database using the private half of the Key Exchange Key as described in **SetVariable()**.
7. Update the authorized signature database using the UEFI Runtime Service **SetVariable()**.
8. If there was no error, go to step 11.
9. If there was an error because of no more resources, determine whether the database can be shrunk any more. The algorithm by which an agent decides which signatures may be safely removed is agent-specific. In most cases, agents should not remove signatures where the SignatureOwner field is not the agent's. If not, then go to step 11, discarding the new signature.
10. If the signature database could be shrunk further, then remove the entries and go to step 6.
11. Exit.

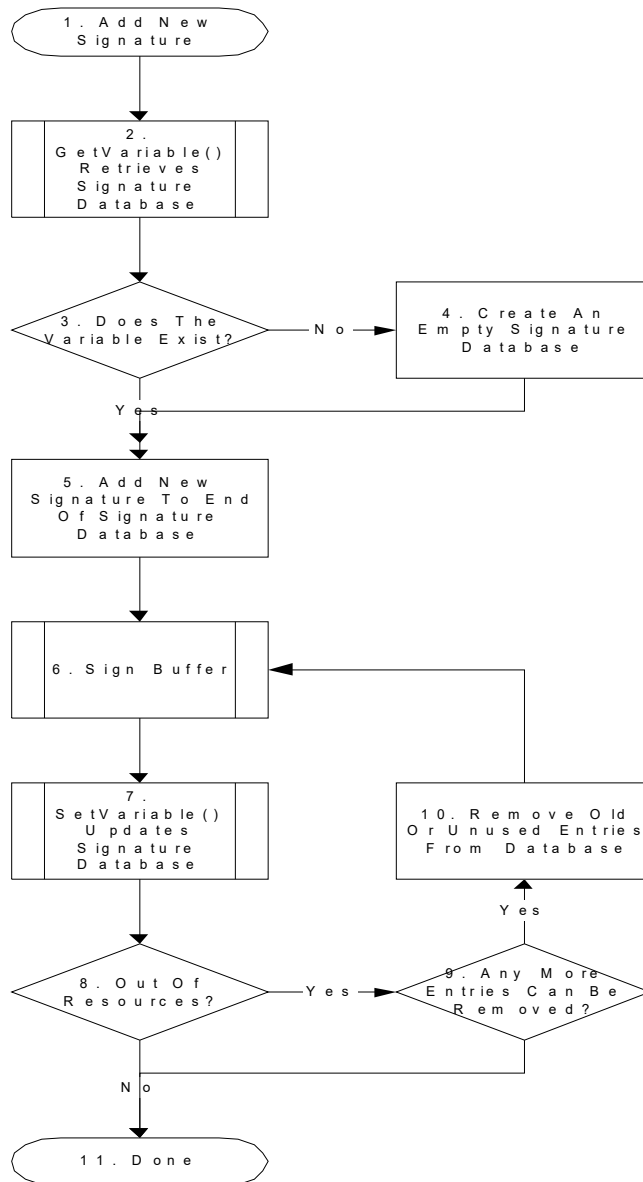

Figure 85. Process for adding a new signature by the OS

### 31.5.3.1 Using The EFI System Configuration Table

During the process of loading UEFI images, the firmware must gather information about which UEFI images were not started. The firmware may additionally gather information about UEFI images which were started. The information is used to create the Image

Execution Information Table, which is added to the EFI System Configuration Table and assigned the GUID **EFI\_IMAGE\_SECURITY\_DATABASE\_GUID**.

For each UEFI image, the following information is collected:

- The image hash.
- The user-friendly name of the UEFI image (if known)
- The device path
- The action taken on the device (was it initialized or why was it rejected)

For more information, see the 'Image Execution Information Table' above.

### 31.5.3.2 Firmware Policy

The firmware may approve UEFI images for other reasons than those specified here. For example: whether the image is in the system flash, whether the device providing the UEFI image is secured (in a case, etc.) or whether the image contains another type of platform-supported digital signature.

### 31.5.3.3 Authorization Process

This section describes the process by which an unknown UEFI image might be authorized to run. Implementations are not required to support all portions of this. For example, an implementation might defer all UEFI image or none.

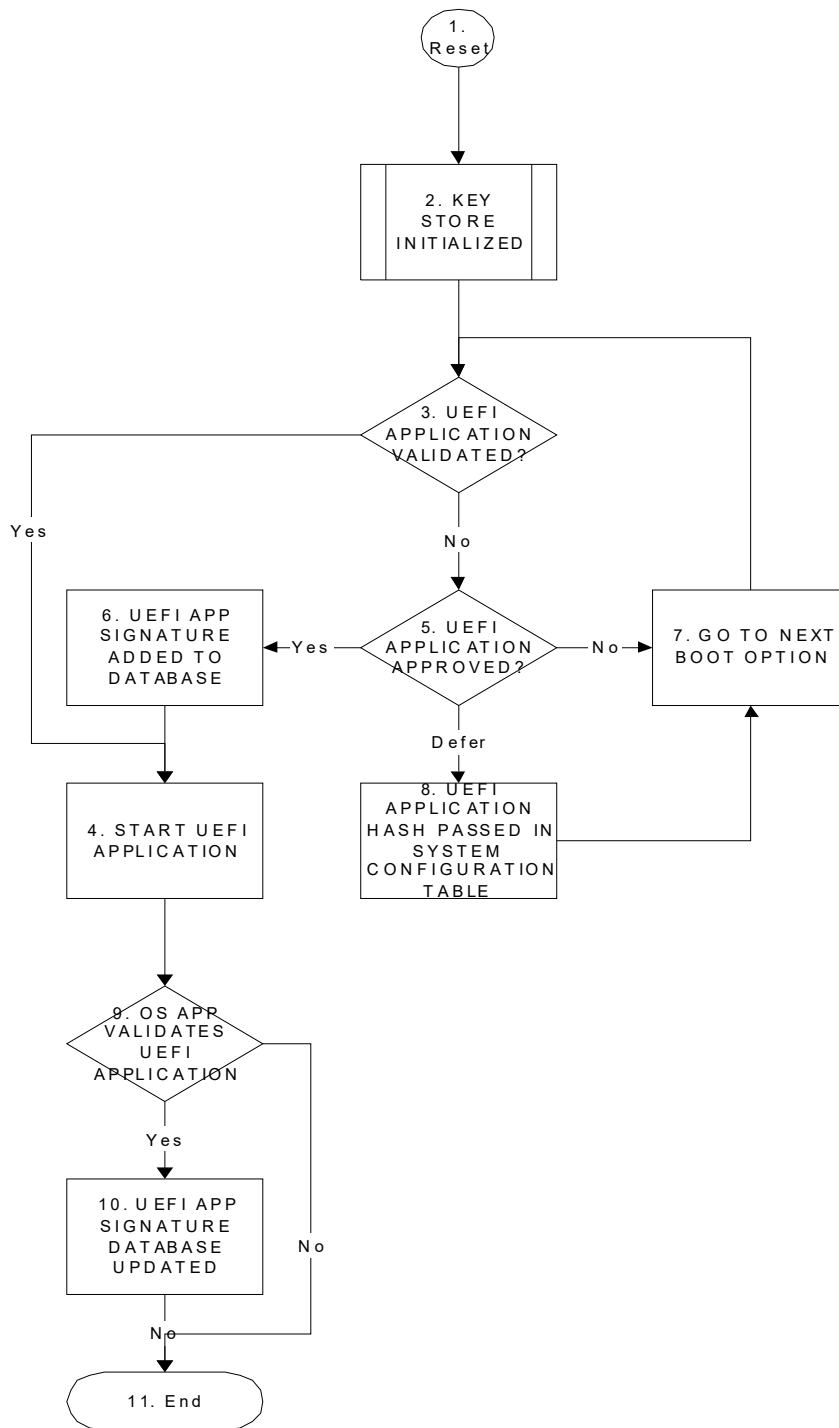

**Table 206. Authorization process flow**

1. Reset. This is when the platform begins initialization during boot.



2. Key Store Initialization. During the firmware initialization and before any signed UEFI images are initialized, the platform firmware must validate the signature database.
3. UEFI Image Validation Succeeded? During initialization of an UEFI image, the UEFI Boot Manager decides whether or not the UEFI image should be initialized. By comparing the calculated UEFI image signature against that in one of the signature databases, the firmware can determine if there is a match.

The security database *db* must either contain an entry with a hash value of the image (with a supported hash type), or it must contain an entry with a certificate against which an entry in the image's certificate table can be verified. In either case verification must not succeed if the security database *dbx* contains any record with:

- A. Any entry with **SignatureListType** of **EFI\_CERT\_SHA256\_GUID** with any **SignatureData** containing the SHA-256 hash of the binary.
- B. Any entry with **SignatureListType** of **EFI\_CERT\_X509\_SHA256**, **EFI\_CERT\_X509\_SHA384**, or **EFI\_CERT\_X509\_SHA512**, with any **SignatureData** which reflects the To-Be-Signed hash included in any certificate in the signing chain of the signature being verified.
- C. Any entry with **SignatureListType** of **EFI\_CERT\_X509\_GUID**, with **SignatureData** which contains a certificate with the same Issuer, Serial Number, and To-Be-Signed hash included in any certificate in the signing chain of the signature being verified.

Multiple signatures are allowed to exist in the binary's certificate table (as per PE/COFF Section "Attribute Certificate Table"). Only one hash or signature is required to be present in *db* in order to pass validation, so long as neither the SHA-256 hash of the binary nor any present signature is reflected in *dbx*.

Then, based on this match or its own policy, the firmware can decide whether or not to launch the UEFI image.

4. Start UEFI Image. If the UEFI Image is approved, then it is launched normally.
5. UEFI Image Not Approved. If the UEFI image was not approved the platform firmware may use other methods to discover if the UEFI image is authorized, such as consult a disk-based catalog or ask an authorized user. The result can be one of three responses: Yes, No or Defer.
6. UEFI Image Signature Added To Signature Database. If the user approves of the UEFI image, then the UEFI image's signature is saved in the firmware's signature database. If user approval is supported, then the firmware be able to update of the Signature Database. For more information, see Signature Database Update.
7. Go To Next Boot Option. If an UEFI image is rejected, then the next boot option is selected normally and go to step 3. This is in the case where the image is listed as a boot option.
8. UEFI Image Signature Passed In System Configuration Table. If user defers, then the UEFI image signature is copied into the Image Execution Information Table in the EFI System Configuration Table which is available to the operating system.
9. OS Application Validates UEFI Image. An OS application determines whether the image is valid.
10. UEFI Image Signature Added To Signature Database. For more information, see Signature Database Update.
11. End.

## 31.6 Code Definitions

### 31.6.1 UEFI Image Variable GUID & Variable Name

#### Summary

Constants used for UEFI signature database variable access.

#### Prototype

```
#define EFI_IMAGE_SECURITY_DATABASE_GUID \
  { 0xd719b2cb, 0x3d3a, 0x4596, \
    { 0xa3, 0xbc, 0xda, 0xd0, 0x0e, 0x67, 0x65, 0x6f }}
#define EFI_IMAGE_SECURITY_DATABASE L"db"
#define EFI_IMAGE_SECURITY_DATABASE1 L"dbx"
#define EFI_IMAGE_SECURITY_DATABASE2 L"dbt"
#define EFI_IMAGE_SECURITY_DATABASE3 L"dbr"
```

#### Description

- This GUID and name are used when calling the EFI Runtime Services **GetVariable()** and **SetVariable()**.
- The **EFI\_IMAGE\_SECURITY\_DATABASE\_GUID** and **EFI\_IMAGE\_SECURITY\_DATABASE** are used to retrieve and change the authorized signature database.
- The **EFI\_IMAGE\_SECURITY\_DATABASE\_GUID** and **EFI\_IMAGE\_SECURITY\_DATABASE1** are used to retrieve and change the forbidden signature database.
- The **EFI\_IMAGE\_SECURITY\_DATABASE\_GUID** and **EFI\_IMAGE\_SECURITY\_DATABASE2** are used to retrieve and change the authorized timestamp signature database.
- The **EFI\_IMAGE\_SECURITY\_DATABASE\_GUID** and **EFI\_IMAGE\_SECURITY\_DATABASE3** are used to retrieve and change the authorized recovery signature database.
- Firmware shall support the **EFI\_VARIABLE\_APPEND\_WRITE** flag (see [Section 8.2](#)) for the UEFI signature database variables.
- The signature database variables db, dbt, dbx, and dbr must be stored in tamper-resistant non-volatile storage.

## 32 Human Interface Infrastructure Overview

---

This section defines the core code and services that are required for an implementation of the Human Interface Infrastructure (HII). This specification does the following:

- Describes the basic mechanisms to manage user input
- Provides code definitions for the HII-related protocols, functions, and type definitions that are architecturally required by the UEFI Specification

### 32.1 Goals

This chapter describes the mechanisms by which UEFI-compliant systems manage user input. The major areas described include the following:

- String and font management.
- User input abstractions (for keyboards and mice)
- Internal representations of the *forms* (in the HTML sense) that are used for running a preboot setup.
- External representations (and derivations) of the forms that are used to pass configuration information to runtime applications, and the mechanisms to allow the results of those applications to be driven back into the firmware.

General goals include:

- Simplified *localization*, the process by which the interface is adapted to a particular language.
- A "forms" representation mechanism that is rich enough to support the complex configuration issues encountered by platform developers, including stock keeping unit (SKU) management and interrelationships between questions in the forms.
- Definition of a mechanism to allow most or all the configuration of the system to be performed during boot, at runtime, and remotely. Where possible, the forms describing the configuration should be expressed using existing standards such as XML.
- Ability for the different drivers (including those from add-in cards) and applications to contribute forms, strings, and fonts in a uniform manner while still allowing innovation in the look and feel for Setup.

Support user-interface on a wide range of display devices:

- Local text display
- Local graphics display
- Remote text display
- Remote graphics display
- Web browser
- OS-present GUI

Support automated configuration without a display.

## 32.2 Design Discussion

This section describes the basic concepts behind the Human Interface Infrastructure. This is a set of protocols that allow a UEFI driver to provide the ability to register user interface and configuration content with the platform firmware. Unlike legacy option ROMs, the configuration of drivers and controllers is delayed until a platform management utility chooses to use the services of these protocols. UEFI drivers are not allowed to perform setup-like operations outside the context of these protocols. This means that a driver is not allowed to interact with the user outside the context of this protocol.

The following example shows a basic platform configuration or “setup” model. The drivers and applications install elements (such as fonts, strings, images and forms) into the HII Database, which acts as a central repository for the entire platform. The Forms Browser uses these elements to render the user interface on the display devices and receive information from the user via HID devices. When complete, the changes made by the user in the Forms Browser are saved, either to the UEFI global variable storage—(**GetVariable()** and **SetVariable()**)— or to variable storage provided by the individual drivers.

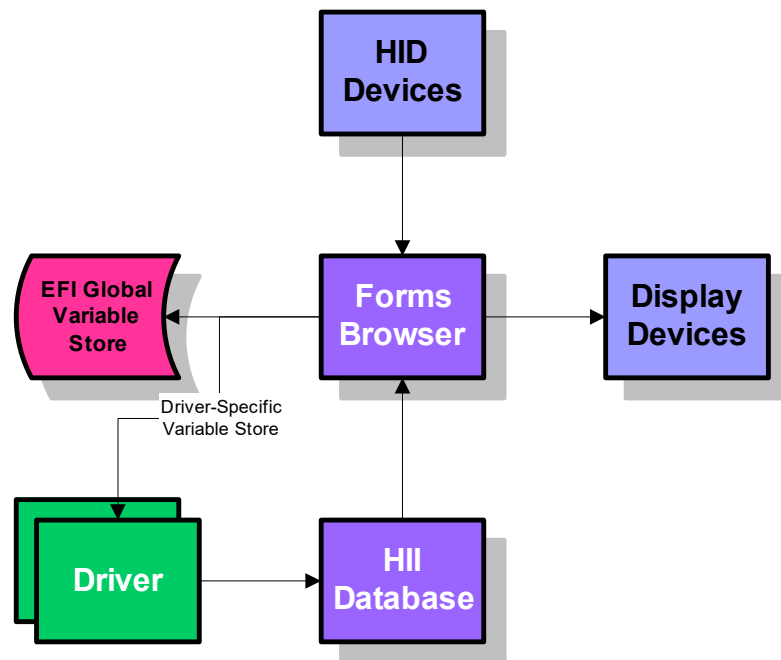

Figure 86. Platform Configuration Overview

### 32.2.1 Drivers And Applications

The user interface elements in the form of package lists are carried by the drivers and applications. Drivers and applications can create the package lists dynamically, or they can be pre-built and carried as resources in the driver/application image.

If they are stored as resources, then an editor can be used to modify the user interface elements without recompiling. For example, display elements can be modified or deleted, new languages added, and default values modified.

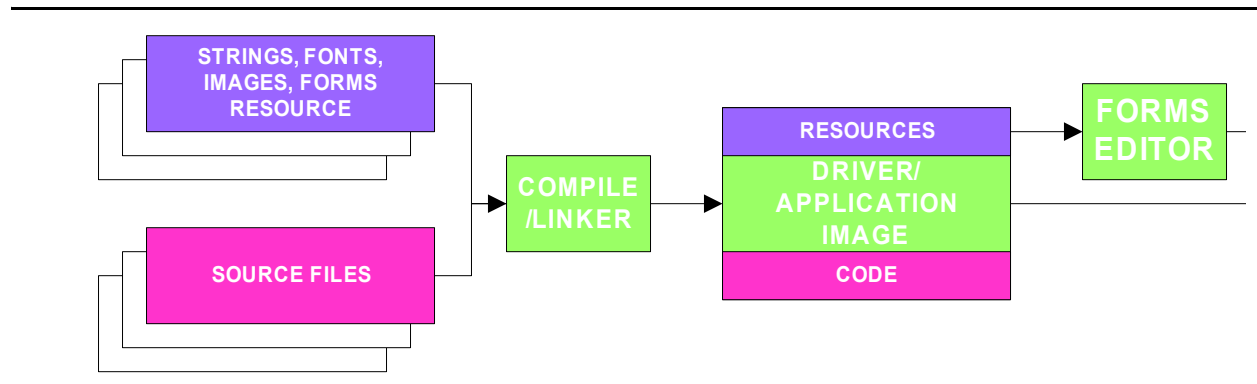

Figure 87. HII Resources In Drivers & Applications

The means by which the string, font, image and form resources are created is beyond the scope of this specification. The following diagram shows a few possible implementations. In both cases, the GUI design is an optional element and the user-interface elements are stored within a text-based resource file. Eventually, this source file is converted into a RES file (PE/COFF Resource Section) which can be linked with the main application.

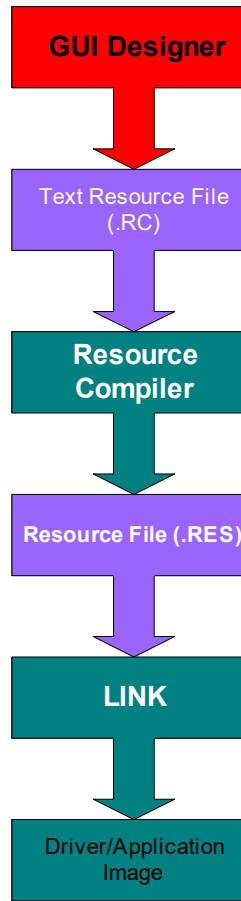

Figure 88. Creating UI Resources With Resource Files

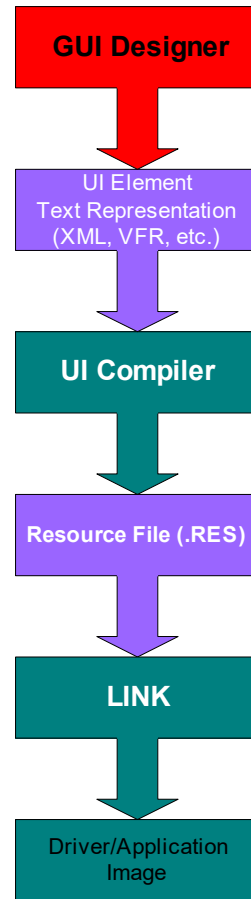

Figure 89. Creating UI Resources With Intermediate Source Representation

### 32.2.1.1 Platform and Driver Configuration

The intent is for this specification to enable the configuration of various target components in the system. The normally arduous task of managing user interface and configuration can be greatly simplified for the consumers of such functionality by enabling the platform to comprehend some standard user interactions.



Figure 90. The Platform and Standard User Interactions

### 32.2.1.2 Pre-O/S applications

There are various scenarios where a platform component must interact in some fashion with the user. Examples of this are when presenting a user with several choices of information (e.g. boot menu) and sending information to the display (e.g. system status, logo, etc.).

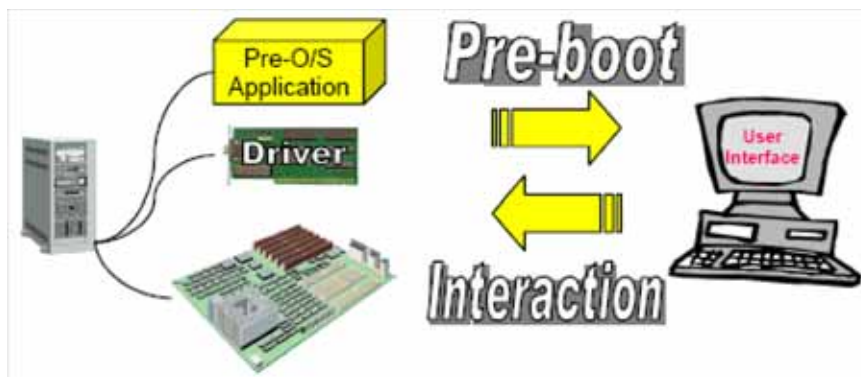

Figure 91. User and Platform Component Interaction

### 32.2.1.3 Description of User Interface Components

Various components listed in this specification are described in greater detail in their own sections. The user interface is composed of several distinct components illustrated below.



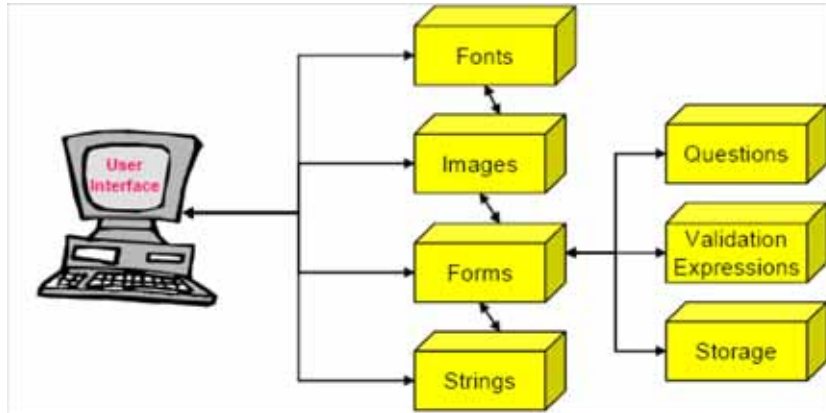

Figure 92. User Interface Components

#### 32.2.1.4 Forms

This component describes what type of content needs to be displayed to the user by means of a binary encoding (i.e., Internal Forms Representation) and also has added context information such as how to validate certain input and further describes where to store such input if it is intended to be non-volatile. Applications such as a browser or script engine may use the information with the forms to validate configuration setting values with or without a user interface.

#### 32.2.1.5 Strings

The strings are the text-based (UCS-2 encoded) representations of the information typically being referenced by the forms. The intent of this infrastructure is also to seamlessly enable multiple language support. To that end the strings have the appropriate language designators to differentiate one language from another.

#### 32.2.1.6 Images/Fonts

Since most content is typically intended to have the ability to be rendered on the local system, the human interface infrastructure also supports the ability for images and fonts to be accepted and used by the underlying user interface components.

#### 32.2.1.7 Consumers of the user interface data

The ultimate consumer of the user interface information will be some type of forms browser or forms processor. There are several usage scenarios which should be supported by this specification. These are illustrated below:

#### 32.2.1.8 Connected forms browser/processor

The ability to have the forms processing engine render content when directly connected to the target platform should be apparent. From the forms processing engine perspective, this could be the local machine or a machine that is network attached. In either case, there is a constructed agent which feeds the material to the forms processor

for purposes of rendering the user interface and interacting with the user. Note that a forms processor could simply act on the forms data without ever having to render the user interface and interact with the user. This situation is much more akin to script processing and should be a very supportable situation.

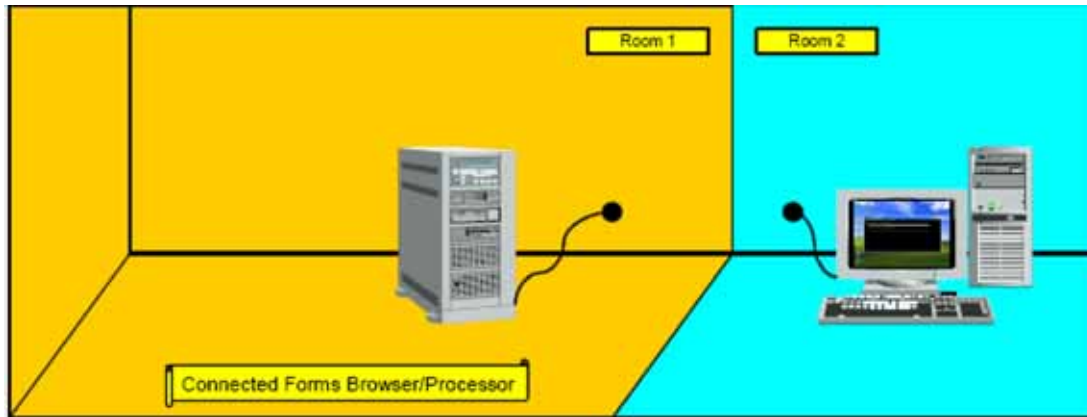

Figure 93. Connected Forms Browser/Processor

### 32.2.1.9 Disconnected Forms Browser/Processor

By enabling the ability to import and export a platform's settings, this infrastructure can also enable the ability for offline configuration. In this instance, a forms processor can interpret a given platform's form data and enable (either through user interaction or through automated scripting) the changing of configuration settings. These settings can then be applied to the target platform when a connection is established.

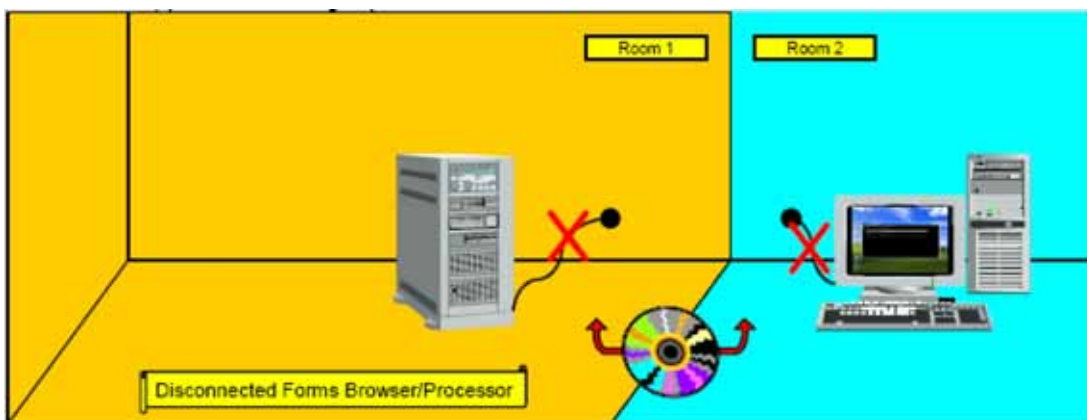

Figure 94. Disconnected Forms Browser/Processor

### 32.2.1.10 O/S-Present Forms Browser/Processor

When it is desired that the forms data be used in the presence of an O/S, this specification describes a means by which to support this capability. By being able to encapsulate the

data and export it through standard means such that an O/S agent (e.g. forms browser/processor) can retrieve it, O/S-present usage models can be made available for further value-add implementations.

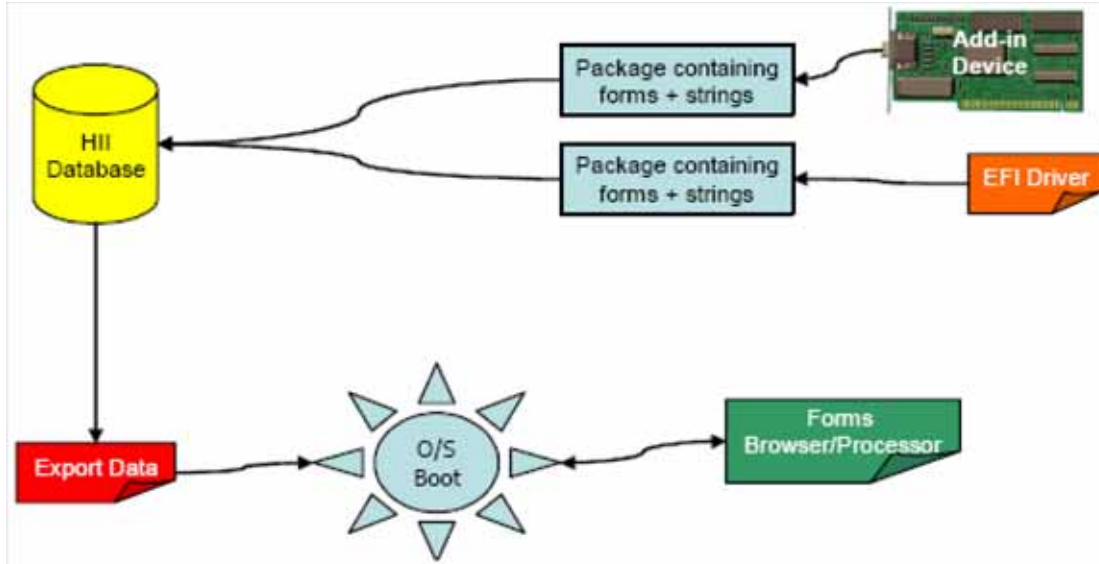

Figure 95. O/S-Present Forms Browser/Processor

### 32.2.1.11 Where are the Results Stored

The forms data encodes how to store the changes per configuration question. The ability to save data to the platform as well as to a proprietary on-board store is provided. The premise is that each of the target non-volatile store components (e.g. motherboard, add-in device, etc.) would advertise an interface as described in this specification so that the forms browser/processor can route changes to the appropriate target.

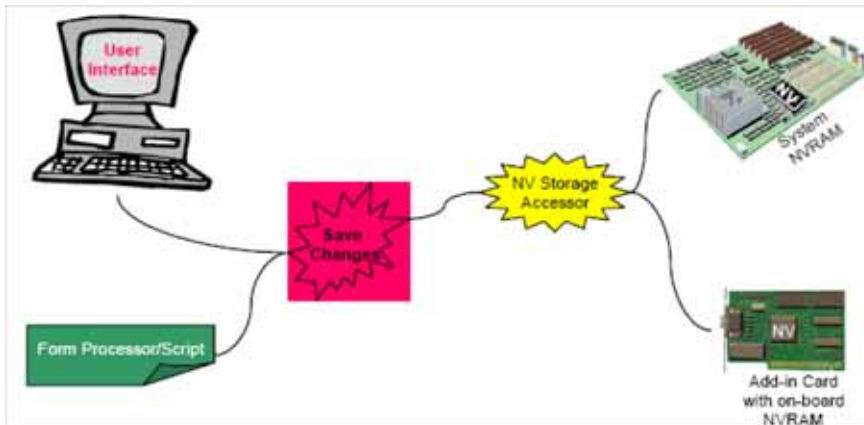

Figure 96. Platform Data Storage

## 32.2.2 Localization

Localization is the process by which the interface is adapted to a particular language. The table below discusses issues with localization and provides possible solutions.

**Table 207. Localization Issues**

Issue	Example	Solution	Comment
Directional display	Right to left printing for Hebrew.	Printing direction is a function of the language.	The display engine may or may not support all display techniques. If a language supports a display mechanism that the display engine does not, the language that uses the font must be selected.
Punctuation	Punctuation is directional. A comma in a right-to-left language is different from a comma in a left-to-right language.	Character choice is the choice of the author or translator.	
Line breakage	Rules vary from language to language.	The UEFI preboot GUI performs little or no formatting.	The runtime display depends on the runtime browser and is not defined here.
Date and time	Most Europeans would write July 4, 1776, as 4/7/1776 while the United States would write it 7/4/1776 and others would write 1776/7/4. The separator characters between the parts of both date and time vary as well.	Generally left to the creator of the user interface.	
Numbers	12,345.67 in one language is presented as 12.345,67 in another.	Print only integers and do not insert separator characters.	This solution is gaining acceptance around the world as more people use computers.

## 32.2.3 User Input

To limit the number of required glyphs, we must also limit the amount and type of user input.

User input generally comes from the following main types of devices:

- Keyboards
- Mouse-like pointing devices

Input from other devices, such as limited keys on a front panel, can be handled two ways:

- Treat the limited keys as special-purpose devices with completely unique interfaces.
- Programmatically make the limited keys mimic a keyboard or mouse-like pointing device.

Pointing devices require no localization. They are universally understood by the subset of the world population addressed in this specification. For example, if a person does not know how to use a mouse or other pointing device, it is probably not a good idea to allow that person to change a system's configuration.

On the other hand, keyboards are localized at the keycaps but not in the electronics. In other words, a French keyboard and a German keyboard might have very different keys but the software inside the keyboard—let alone the software in the system at the other end of the wire—cannot know which set of keycaps are installed.

This specification proposes to solve this issue by using the keys that are common between keyboards and ignoring language-specific keys. Keys that are available on USB keyboards in preboot mode include the following:

- Function keys (F1 – F12)
- Number keys (0-9)
- "Upside down T" cursor keys (the arrows, home, end, page up, page down)
- Numeric keypad keys
- The Enter, Space, Tab, and Esc keys
- Modifier keys (shifts, alts, controls, Windows\*)
- Number lock

The scan codes for these keys do not vary from language to language. These keys are the standard keys used for browser navigation although most end-users are unaware of this fact. Help for form-entry-specific keys must be provided to enable a useful keys-only interface. The one case where other, language-specific keys may be used is to enter passwords. Because passwords are never displayed, there is no requirement to translate scan code to Unicode character codes (keyboard localization) or scan codes to font glyphs.

Additional data can be provided to enable a richer set of input characters. This input is necessary to support features such as arbitrary text input and passwords.

## 32.2.4 Keyboard Layout

### 32.2.4.1 Keyboard Mapping

UEFI's keyboard mapping loosely based definitions on ISO 9995. It bases the naming mechanism on the figure below. The keys highlighted in brown are the keys that nearly all keyboard layouts use for customizations. However, customization does not necessarily

mean that all the keys are different. In fact, most of the keys are likely to be the same. When modifying the mapping, one can normally reference the keys in brown as the likely candidates (for whom to create modifications).

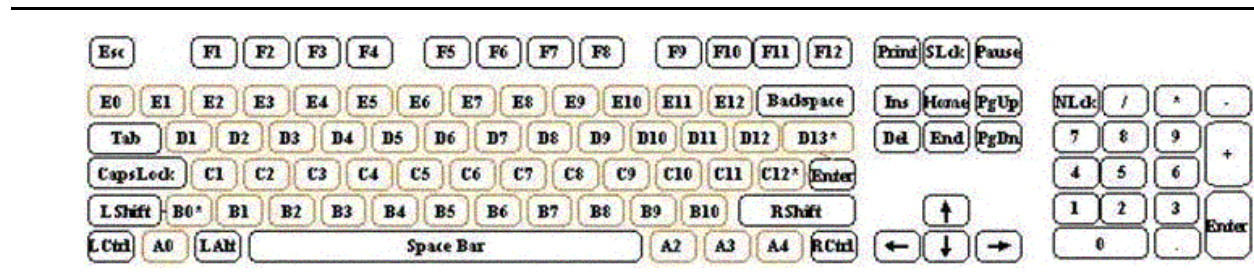

Figure 97. Keyboard Layout

Instead of referencing keys in hardware-specific ways such as scan codes, the HII specification defines an **EFI\_KEY** enumeration that allows for a simple method of referencing this hardware abstraction. Type **EFI\_KEY** is defined in [EFI\\_HII\\_DATABASE\\_PROTOCOL.GetKeyboardLayout\(\)](#). It also provides a way to update the keyboard layout with a great deal of flexibility. Any of the keys can be mapped to any 16-bit Unicode character code or control code value.

When defining the values for a particular key, there are six elements that are pertinent to the key:

#### Key name

The `EFI_KEY` enumeration defines the names of the above keys.

#### Unicode Character Code

Defines the Unicode Character Code (if any) of the named key.

#### Shifted UnicodeCharacter Code

Defines the Unicode Character Code (if any) of the named key while the shift modifier key is being pressed

#### Alt-GR Unicode Character Code

Defines the Unicode Character Code (if any) of the named key while the Alt-GR modifier key (if any) is being pressed.

#### Shifted Alt-GR UnicodeCharacter Code

Defines the Unicode Character Code (if any) of the named key while the Shift and Alt-GR modifier key (if any) is being pressed.

#### Modifier key value

Defines the nonprintable special function that this key has assigned to it.

- Under normal circumstances, a key that has any Unicode character code definitions generally has a modifier key value of **EFI\_NULL\_MODIFIER**. This value means the key has no special function other than the printing of a character. An exception to the rule is if any of the Unicode character codes have a value of `0xFFFF`. Although rarely used, this value is the one

case in which a key might have both a printable character and an active control key value.

An example of this exception would be the numeric keypad's insert key. The definition for this key on a standard US keyboard is as follows:

```

Key = EfiKeyZero
Unicode = 0x0030 (basically a '0')
ShiftedUnicode = 0xFFFF (the exception to the rule)
AltGrUnicode = 0x0000
ShiftedAltGrUnicode = 0x0000
Modifier = EFI_INSERT_MODIFIER

```

This key is one of the few keys that, under normal circumstances, prints something out but also has a special function. These special functions are generally limited to the numeric keypad; however, this general limitation does not prevent someone from having the flexibility of defining these types of variations.

#### 32.2.4.2 Modifier Keys

The definitions of the modifier keys allow for special functionality that is not necessarily accomplished by a printable character. Many of these modifier keys are flags to toggle certain state bits on and off inside of a keyboard driver. An example is [EFI CAPS LOCK MODIFIER](#). This state being active could alter what the typing of a particular key produces. Other control keys, such as [EFI LEFT ARROW MODIFIER](#) and [EFI END MODIFIER](#), affect the position of the cursor. One modifier key is likely unfamiliar to most people who exclusively use US keyboards, and that key is the [EFI ALT GR MODIFIER](#) key. This key's primary purpose is to activate a secondary type of shift modifier that exposes additional printable characters on certain keys. In some keyboard layouts, this key does not exist and is normally the [EFI RIGHT ALT MODIFIER](#) key. None of the other modifier key functions should be a mystery to someone familiar with the usage of a standard computer keyboard.

An example of a few descriptor entries would be as follows:

```

Layout = {
  EfiKeyLCtrl,0,0,0,0,EFI_LEFT_CONTROL_MODIFIER, //Left control
                                                    // key
  EfiKeyA0,0,0,0,0,EFI_NULL_MODIFIER, //Not defined
                                     // windows key
  EfiKeySpaceBar,0x0020,0x0020,0x0020,0x0020,EFI_NULL_MODIFIER
                                     //(Space Bar)
}

```

See "Related Definitions" in [EFI\\_HII\\_DATABASE\\_PROTOCOL.GetKeyboardLayout\(\)](#) for the defined modifier values.

#### 32.2.4.3 Non-spacing Keys

Non-spacing keys are a concept that provides the ability to **OR** together an accent key and another printable character. Non-spacing keys are defined as special types of



modifier characters. They are typically accent keys that do not advance the cursor and in essence are a type of modifier key in that they maintain some level of state.

The way a person uses a non-spacing key is that the non-spacing key that maybe has the function of overlaying an umlaut (two dots) onto whatever the next character might be.

The user presses the umlaut non-spacing key and follows it with a capital A, which yields an "Ä."

An example of a few descriptor entries would be as follows:

```
//
// If it's a dead key, we need to pass a list of physical key
// names, each with a unicode, shifted, altgr, shiftedaltgr
// character code. Each key name will have a Modifier value of
// EFI_NS_KEY_MODIFIER for the first entry, and then the list of
// EFI_NS_KEY_DEPENDENCY_MODIFIER physical key descriptions.
// This eventually will lead to the next normal non-modifier key
// definition.
//
// This requires defining an additional Modifier value of
// EFI_NS_KEY_DEPENDENCY_MODIFIER to signify
// EFI_NS_KEY_MODIFIER children definitions.
//
// The keyboard driver (consumer of the layouts) will know that
// any key definitions with the EFI_NS_KEY_DEPENDENCY_MODIFIER
// modifier do not redefine the value of the specified EFI_KEY.
// They are simply used as a special case augmentation to the
// original EFI_NS_KEY_MODIFIER.
//
// It is an error condition to define a
// EFI_NS_KEY_MODIFIER without having all the
// EFI_NS_KEY_DEPENDENCY_MODIFIER keys defined serially.
//
Layout = {
  EfiKeyE0, 0, 0, 0, 0, EFI_NS_KEY_MODIFIER,
  EfiKeyC1, 0x00E2, 0x00C2, 0, 0, EFI_NS_KEY_DEPENDENCY_MODIFIER,
  EfiKeyD3, 0x00EA, 0x00CA, 0, 0, EFI_NS_KEY_DEPENDENCY_MODIFIER,
  EfiKeyD8, 0x00EC, 0x00CC, 0, 0, EFI_NS_KEY_DEPENDENCY_MODIFIER,
  EfiKeyD9, 0x00F4, 0x00D4, 0, 0, EFI_NS_KEY_DEPENDENCY_MODIFIER,
  EfiKeyD7, 0x00FB, 0x00CB, 0, 0, EFI_NS_KEY_DEPENDENCY_MODIFIER
}
```

In the above example, a key located at E0 is designated as a dead key. Using a common German keyboard layout as the example, a circumflex accent "^" is defined as a dead key at the E0 location. The A, E, I, O, and U characters are valid keys that can be pressed after the dead key and will produce a valid printable character. These characters are located at C1, D3, D8, D9, and D7 respectively.

The results of the *Layout* definition provided above would allow for the production of the following characters: äÂÊÏôÛÛ.



### 32.2.5 Forms

This specification describes how a UEFI driver or application may present a forms (or dialogs) based interface. The forms-based interface assumes that each window or screen consists of some window dressing (title & buttons) and a list of questions. These questions represent individual configuration settings for the application or driver, although several GUI controls may be used for one question.

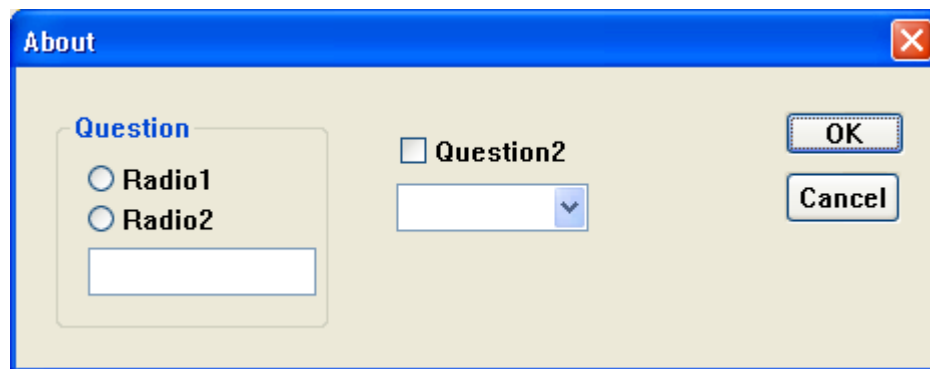

Figure 98. Forms-based Interface Example

The forms are stored in the HII database, along with the strings, fonts and images. The various attributes of the forms and questions are encoded in IFR (Internal Forms Representation)—with each object and attribute a byte stream.

Other applications (so-called “Forms Processors”) may use the information within the forms to validate configuration setting values without a user interface at all.

The Forms Browser provides a forms-based user interface which understands how to read the contents of the forms, interact with the user, and save the resulting values. The Forms Browser uses forms data installed by an application or driver during initialization in the HII database. The Forms Browser organizes the forms so that a user may navigate between the forms, select the individual questions and change the values using the HID and display devices. When the user has finished making modifications, the Forms Browser saves the values, either to the global EFI variable store or else to a private variable store provided by the driver or application.

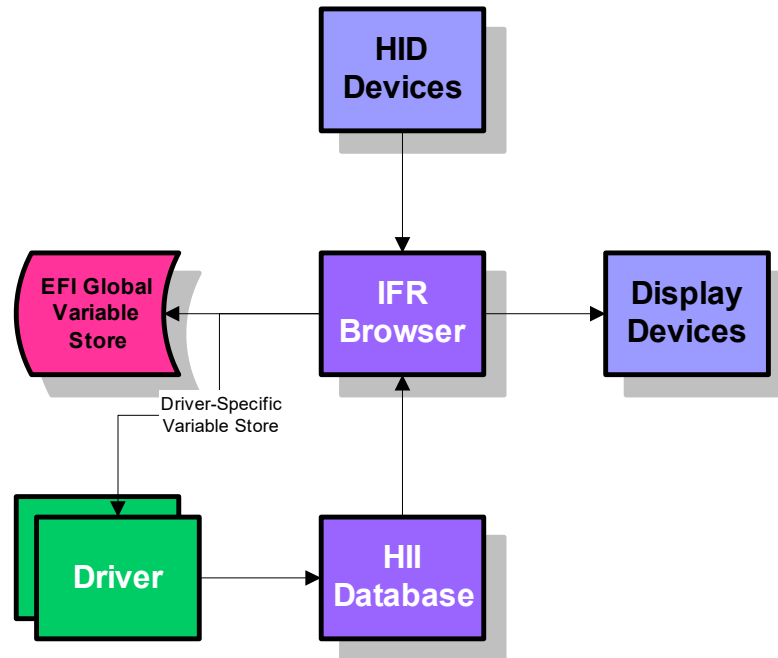

Figure 99. Platform Configuration Overview

### 32.2.5.1 Form Sets

*Form sets* are logically-related groups of forms.

#### Attributes

Each forms set has the following attributes:

##### Form Set Identifier

Uniquely identifies the form set within a package list using a GUID. The Form Set Identifier, along with a device path, uniquely identifies a form set in a system.

##### Form Set Class Identifier

Optional array of up to three GUIDs which identify how the form set should be used or classified. The list of standard form set classes is found in the "Related Definitions" section of [EFI\\_FORM\\_BROWSER2\\_PROTOCOL.SendForm\(\)](#).

##### Title

Title text for the form set.

##### Help

Help text for the form set.

##### Image

Optional title image for the form set.

## Animation

Optional title animation for the form set

## Description

Within a form set, there is one *parent* form and zero or more *child* forms. The parent form is the first enabled, visible form in the form set. The child forms are the second or later enabled, visible forms in the form set. In general, the Forms Browser will provide a means to navigate to the parent form. A cross-reference (see [Section 32.2.5.4.10](#)) is used to navigate between forms within a form set or between forms in different form sets.

Variable stores are declared within a form set. Variable stores describe the means for retrieval and storage of configuration settings, and location information within that variable store. For more information, see [Section 32.2.5.6](#).

Default stores are declared within a form set. Default stores group together different types of default settings (normal, manufacturing, etc.) and give them a name. See [Section 32.2.5.8](#) for more information.

The form set can control whether or not to process an individual form by nesting it inside of an **EFI\_IFR\_DISABLE\_IF** expression. See [Section 32.2.5.2.1](#) for more information. The form set can control whether or not to display an individual form by nesting it inside of an **EFI\_IFR\_SUPPRESS\_IF** expression.

## Syntax

The form set consists of an **EFI\_IFR\_FORM\_SET** object, where the body consists of

```
form-set :=EFI_IFR_FORM_SET form-set-list
form-set-list :=form form-set-list |
EFI_IFR_IMAGE form-set-list |
EFI_IFR_ANIMATION form-set-list |
EFI_IFR_VARSTORE form-set-list |
EFI_IFR_VARSTORE_EFI form-set-list |
EFI_IFR_VARSTORE_NAME_VALUE form-set-list |
EFI_IFR_DEFAULTSTORE form-set-list |
EFI_IFR_DISABLE_IF expression form-set-list |
<empty>
EFI_IFR_SUPPRESS_IF expression form-set-list | <empty>
```

### 32.2.5.2 Forms

Forms are logically-related groups of statements (including questions) designed to be displayed together.

## Attributes

Each form has the following attributes:

**Form Identifier**

A 16-bit unsigned integer, which uniquely identifies the form within the form set. The Form Identifier, along with the device path and Form Set Identifier, uniquely identifies a form within a system.

**Title**

Title text for the form. The Forms Browser may use this text to describe the nature and purpose of the form in a window title.

**Image**

Optional title image for the form. The Forms Browser may use this image to display the nature and purpose of the form in a window title.

**Animation**

Optional title animation for the form set.

**Modal**

If a form is modal, then the on-form interaction must be completed prior to navigating to another form. See "User Interaction", [Section 32.2.10.1](#).

The form can control whether or not to process a statement by nesting it inside of an **EFI\_IFR\_DISABLE\_IF** expression. See [Section 32.2.5.3.2](#) for more information.

The form can control whether a particular statement is selectable by nesting it inside of an **EFI\_IFR\_GRAY\_OUT\_IF** expression. Statements that cannot be selected are displayed by Form Browsers, but cannot be selected by a user. **EFI\_IFR\_GRAY\_OUT\_IF** causes statements to be displayed with some visual indication. See [Section 32.2.5.3.4](#) for more information.

The form can control whether to display a statement by nesting it inside of an **EFI\_IFR\_SUPPRESS\_IF** expression. See [Section 32.3.8.3.75](#) for more information.

**Syntax**

The form consists of an **EFI\_IFR\_FORM** object, where the body consists of:

```
form:=EFI_IFR_FORM form-tag-list |
EFI_IFR_FORM_MAP form-tag-list
form-tag-list:=form-tag form-tag-list |
<empty>
form-tag:= EFI_IFR_IMAGE |
EFI_IFR_ANIMATION |
EFI_IFR_LOCKED |
EFI_IFR_RULE |
EFI_IFR_MODAL_TAG |
statement |
```

```

question |
cond-statement-list |
<empty>

statement-list:= statement statement-list |
question statement-list |
cond-statement-list |
<empty>

cond-statement-list:= EFI_IFR_DISABLE_IF expression statement-list |
EFI_IFR_SUPPRESS_IF expression statement-list |
EFI_IFR_GRAY_OUT_IF expression statement-list |
question-list := question question-list |
<empty>

```

Other unknown opcodes are permitted, but will be ignored.

#### 32.2.5.2.1 Enable/Disable

Disabled forms will not be processed at all by a Forms Processor. Forms are enabled unless:

- The form nests inside an **EFI\_IFR\_DISABLE\_IF** expression which evaluated to false.
- The disabling of forms is evaluated during Forms Processor initialization and is not re-evaluated.

#### 32.2.5.2.2 Modifiability

Forms can be locked so that a Forms Editor will not change it. Forms are unlocked unless:

- The form has an **EFI\_IFR\_LOCKED** in its scope.

The locking of statement is evaluated only during Forms Editor initialization.

#### 32.2.5.2.3 Visibility

Suppressed forms will not be displayed. Forms are visible unless:

- The form is disabled (see [Section 32.2.5.4](#))
- The form is nested inside an **EFI\_IFR\_SUPPRESS\_IF** expression which evaluates to false.

#### 32.2.5.3 Statements

All displayable items within the body of a form are statements. Statements provide information or capabilities to the user. Questions (see [Section 32.2.5.4](#)) are a specialized form of statement with a value. Statements are used only by Forms Browsers and are ignored by other Forms Processors.

## Attributes

Statements have the following attributes:

### Prompt

The text that will be displayed with the statement.

### Help

The extended descriptive text that can be displayed with the statement.

### Image

The optional image that will be displayed with the statement.

### Animation

The optional animation that will be displayed with the statement.

Other than Questions, there are three types of statements:

- Static Text/Image
- Subtitle
- Cross-Reference

## Syntax

*statement* := *subtitle* | *static-text* | *reset button*

*statement-tag-list* := *statement-tag statement-tag-list* |

<empty>

*statement-tag* := **EFI\_IFR\_IMAGE** |

**EFI\_IFR\_LOCKED**

**EFI\_IFR\_ANIMATION**

### 32.2.5.3.1 Display

Statement display depends on the Forms Browser. Statements *do not* describe how the statement must be displayed but rather provide resources (such as text and images) for use by the Forms Browser. The Forms Browser uses this information to create the necessary user interface.

The Forms Browser may use the visibility (see [Section 32.2.5.3.3](#)) or selectability (see [Section 32.2.5.3.4](#)) of the statements to change the way the item is displayed. The **EFI\_IFR\_GRAY\_OUT\_IF** expression explicitly requires that nested statements have visual differentiation from normal statements.

### 32.2.5.3.2 Enable/Disable

Statements which have been disabled will not be processed at all by a Forms Processor. Statements are enabled unless:

- The parent statement or question is disabled.
- The statement is nested inside an **EFI\_IFR\_DISABLE\_IF** expression which evaluated to false.

- The disabling of statements is evaluated during Forms Browser initialization and is not re-evaluated.

### 32.2.5.3.3 Visibility

Suppressed statements will not be displayed. Statements are displayed unless:

- The parent statement or question is suppressed.
- The statement is disabled (see [Section 32.2.5.3.2](#))
- The statement is nested inside an **EFI\_IFR\_SUPPRESS\_IF** expression which evaluates to false.

The suppression of the statements is evaluated during Forms Browser initialization. Subsequently, the suppression of statements is reevaluated each time a value in any question on the selected form has changed.

### 32.2.5.3.4 Evaluation of Selectable Statements

A user in a Forms Browser can choose statements which are selectable. Statements are selectable unless:

- The parent statement or question is not selectable.
- The statement is suppressed (see [Section 32.2.5.3.2](#)).
- The statement is nested inside an **EFI\_IFR\_GRAY\_OUT\_IF** expression which evaluated to false.

The evaluation of selectable statements takes place during Forms Browser initialization. Subsequently, selectable statements are reevaluated each time a value in any question on the selected form has changed.

### 32.2.5.3.5 Modifiability

A statement can be locked so that a Forms Editor will not change it. Statements are unlocked unless:

- The parent form or parent statement/question is locked.
- The statement has an **EFI\_IFR\_LOCKED** in its scope.

The locking of a statement is evaluated only during Forms Editor initialization.

### 32.2.5.3.6 Static Text/Image

The Forms Browser displays the specified prompt, the specified text and (optionally) the image, but has no user interaction.

## Syntax

*static-text*= **EFI\_IFR\_TEXT** *statement-tag-list*

### 32.2.5.3.7 Subtitle

The subtitle is a means of visually grouping questions by providing a separator, some optional separating text, and an optional image.

## Syntax

*subtitle:= EFI\_IFR\_SUBTITLE statement-tag-list*

### 32.2.5.3.8 Reset Button

#### Attributes

Reset Buttons have the following attributes:

##### Default Id

Specifies the default set to use when restoring defaults to the current form.

## Syntax

*reset button:= EFI\_IFR\_RESET\_BUTTON statement-tag-list*

### 32.2.5.4 Questions

Questions are statements which have a value. The value corresponds to a configuration setting for the platform or for a device. The question uniquely identifies the configuration setting, describes the possible values, the way the value is stored, and how the question should be displayed.

#### Attributes

Questions have the following attributes (in addition to those of statements):

##### Question Identifier

A 16-bit unsigned integer which uniquely identifies the question within the form set in which it appears. The Question Identifier, along with the device path and Form Set Identifier, uniquely identifies a question within a system.

##### Default Value

The value used when the user requests that defaults be loaded.

##### Manufacturing Value

The value used when the user requests that manufacturing defaults are loaded.

##### Value

Each question has a current value. See [Section 32.2.5.4.1](#) for more information.

##### Value Format

The format used to store a question's value.

##### Value Storage

The means by which values are stored. See [Section 32.2.5.4.2](#) for more information.

##### Refresh Identifiers

Zero or more GUIDs associated with an event group initialized by the Forms Browser when the form set containing the question is opened. If the event group associated with the GUID is signaled (see **SignalEvent()**), then the question value will be updated from storage.



## Refresh Interval

The minimum number of seconds that must pass before the Forms Browser will automatically update the current question value from storage. The default value is zero, indicating there will be no automatic refresh.

## Validation

New values assigned to questions can be validated, using validation expressions, or, if connected, using a callback. See [Section 32.2.5.9](#) for more information.

## Callback

If set, the callback will be called when the question's value is changed. In some cases, the presence of these callbacks prevents the question's value from being edited while disconnected.

The question can control whether a particular option can be displayed by nesting it inside of an **EFI\_IFR\_SUPPRESS\_IF** expression. Form Browsers do not display Suppressed Options, but Suppressed Options may still be examined by Form Processors.

## Syntax

*question* := *action-button* | *boolean* | *date* | *number* | *ordered-list* | *string* | *time* | *cross-reference*

*question-tag-list* := *question-tag* *question-tag-list* |  
<empty>

*question-tag* := *statement-tag* |  
**EFI\_IFR\_INCONSISTENT\_IF** *expression* |  
**EFI\_IFR\_NO\_SUBMIT\_IF** *expression* |  
**EFI\_IFR\_WARNING\_IF** *expression* |  
**EFI\_IFR\_DISABLE\_IF** *expression* *question-list* |  
**EFI\_IFR\_REFRESH\_ID** *RefreshEventGroupId* |  
**EFI\_IFR\_REFRESH** |  
**EFI\_IFR\_VARSTORE\_DEVICE**

*question-option-tag* := **EFI\_IFR\_SUPPRESS\_IF** *expression* |  
**EFI\_IFR\_VALUE** *optional-expression* |  
**EFI\_IFR\_READ** *expression* |  
**EFI\_IFR\_WRITE** *expression* |  
*default* |  
*option*

*question-option-list* := *question-tag* *question-option-list* |  
*question-option-tag* *question-option-list* |  
<empty>

Other unknown opcodes are permitted but are ignored.

#### 32.2.5.4.1 Values

Question values are a data type listed in [Section 32.2.5.7.4](#). During initialization of the Forms Processor or Forms Browser, the values of all enabled questions are retrieved. If the value cannot be retrieved, then the question's value is **Undefined**.

A question with the value of type **Undefined** will be suppressed. This suppression will be reevaluated based on Value Refresh or when any question value on the selected form is changed.

When the form is submitted, the modified values are written to Value Storage. When the form is reset, the question value is set to the default question value. If there is no default question value, the question value is unchanged.

When a question value is retrieved, the following process is used:

1. Set the *this* internal constant to have the same value as the one read from the question's storage.
2. If present, change the current question value to the value returned by a question's nested **EFI\_IFR\_READ** operator.

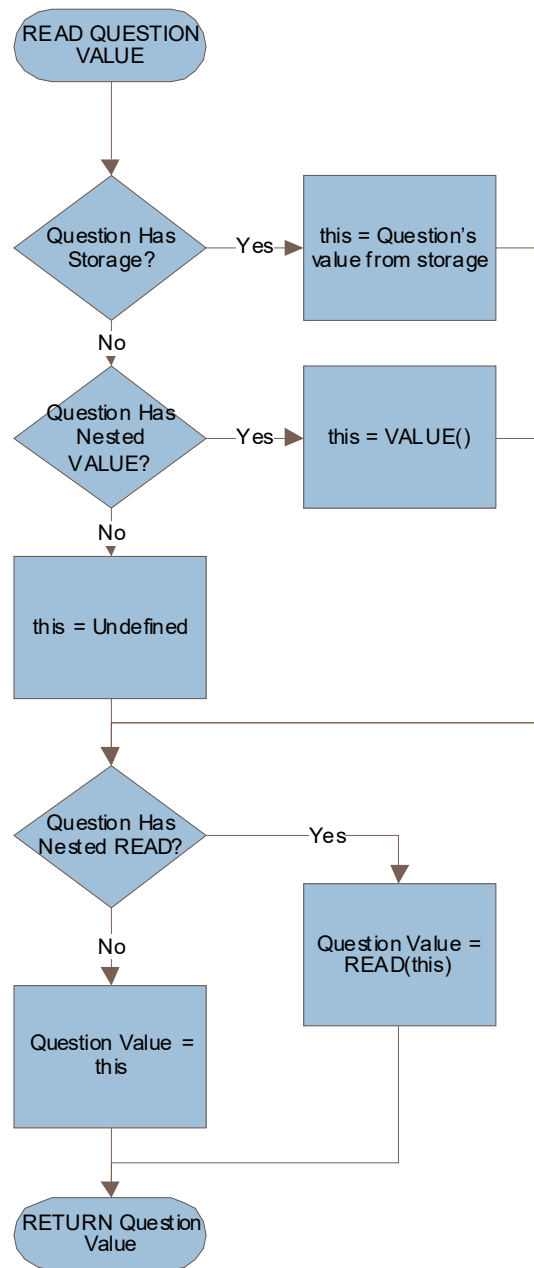

Figure 100. Question Value Retrieval Process

When a question value is changed, the following process is used:

1. Set the *this* internal constant to have the same value as the current question value.
2. If present, evaluate the question's nested **EFI\_IFR\_WRITE** ([Section 32.3.8.3.94](#)) operator.
3. Write the value to the question's storage

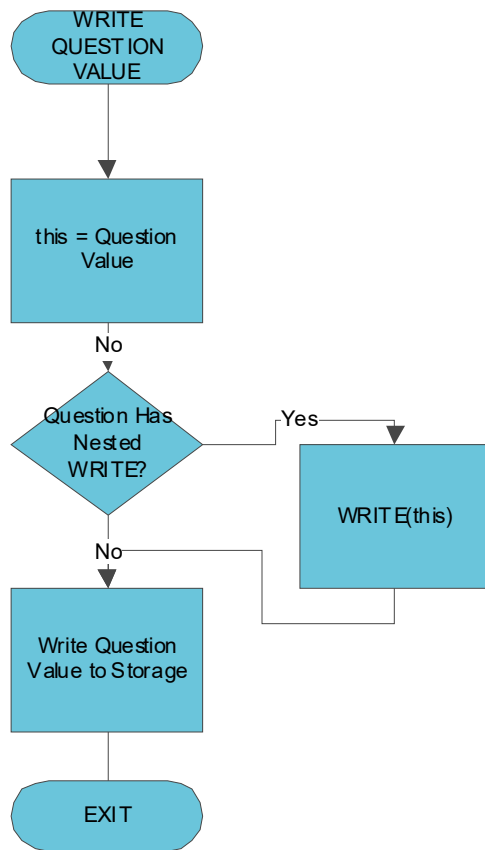

Figure 101. Question Value Change Process

#### 32.2.5.4.2 Storage Requirements

Question storage requirements describe the type and size of storage for the value. These storage requirements describe whether the question's value will be stored as an EFI global variable or using driver local storage. It also describes whether the value is packed together with other values in a buffer, or passed as a name-value pair. See [Section 32.2.5.6](#) for more information.

#### 32.2.5.4.3 Display

Question display depends on the Forms Browser. Questions *do not* describe how the question must be displayed. Instead, questions provide resources (such as text and images) and information about visibility and the ability to edit the question. The Forms Browser uses these to create the necessary user interface.

Questions can have prompt text, help text and (optionally) an image. The prompt text usually describes the nature of the question. Help text is displayed either in a special display area or only at the request of the user. Questions can also have hints which describe how to visually organize the information

#### 32.2.5.4.4 Action Button

Action buttons are buttons which cause a pre-defined configuration string to process immediately. There is no storage directly associated with the button.

##### Attributes

Action buttons have no additional attributes other than the common question attributes).

##### Storage

There is no storage associated with the action button.

##### Results

There are no results associated with the action button. If used in an expression, the question value will always be **Undefined**.

##### Syntax

*action-button*:= **EFI\_IFR\_ACTION** *question-tag-list*

#### 32.2.5.4.5 Boolean

Boolean questions are those that allow a choice between true and false. The question's value is Boolean. In general, construct questions so that the prompt text asks questions resulting in 'yes/enabled/on' is 'true' and 'no/disabled/off' is 'false'.

Boolean questions may be displayed as a check box, two radio buttons, a selection list, a list box, or a drop list box.

##### Attributes

Boolean questions have no additional attributes other than the common question attributes:

##### Storage

If the boolean question uses Buffer storage or EFI Variable (see [Section 32.2.5.6](#)), then the size is exactly one byte, with the FALSE condition is zero and the TRUE value is 1.

##### Results

The results are represented as either 0 (**FALSE**) or 1 (**TRUE**).

##### Syntax

*boolean*:= **EFI\_IFR\_CHECKBOX** *question-option-list*

#### 32.2.5.4.6 Date

Date questions allow modification of part or all of a standard calendar date. The format of the date display depends on the Forms Browser and any localization.

##### Attributes

Date questions have the following attributes:

**Year Suppressed**

The year will not be displayed or updated.

**Month Suppressed**

The month will not be displayed or updated.

**Day Suppressed**

The day will not be displayed or updated.

**UEFI Storage**

In addition to normal question Value Storage, Date questions can optionally be instructed to save the date to either the system time or system wake-up time using the UEFI runtime services **SetTime()** or **SetWakeuptime()**. In this case, the date and time will be read first, the modifications made and changes will be written back.

Conversion to and from strings to a date depends on the system localization.

The date value is stored an **EFI\_HII\_TIME** structure. The **TimeZone** field is always set to **EFI\_UNSPECIFIED\_TIMEZONE**. The **Daylight** field is always set to zero. The contents of the other fields are undetermined.

**Storage**

If the date question uses Buffer storage or EFI Variable storage (see [Section 32.2.5.6](#)), then the stored result will occupy exactly the size of **EFI\_HII\_DATE**.

**Results**

Results for date questions are represented as a hex dump of the **EFI\_HII\_DATE** structure. If used in a question, the value will be a buffer containing the contents of the **EFI\_HII\_DATE** structure.

**Syntax**

*date:= **EFI\_IFR\_DATE** question-option-list*

**32.2.5.4.7 Number**

Number questions allow modification of an integer value up to 64-bits. Number questions can also specify pre-defined options.

**Attributes**

Number questions have the following attributes:

**Radix**

Hint describes the output radix of numbers. The possible values are unsigned decimal, signed decimal or hexadecimal. Numbers displayed in hexadecimal will be prefixed by '0x'

**Minimum Value**

The minimum unsigned value which can be accepted for this question.

**Maximum Value:**

The maximum unsigned value which can be accepted for this question.

**Skip Value:**

Defines the minimum increment between values.

**Storage**

If the number question uses Buffer storage or EFI Variable storage (see [Section 32.2.5.6](#)), then the buffer size specified by must be 1, 2, 4 or 8. Also, the Forms Processor will do implicit error checking to make sure that the signed or unsigned value can be stored in the Buffer without loss of significant bits. For example, if the buffer size is 1 byte, then the largest unsigned integer value would be 255. Likewise, the largest signed integer value would be 127 and the smallest signed integer value would be -128. The Forms Processor will automatically detect this as an error and generate an appropriate error.

**Results**

The results are represented as string versions of unsigned hexadecimal values.

**Syntax**

*number* := **EFI\_IFR\_NUMERIC** *question-option-list* /  
**EFI\_IFR\_ONE\_OF** *question-option-list*

**32.2.5.4.8 Set**

Sets are questions where  $n$  containers can be filled with any of  $m$  pre-defined choices. This supports both lists where a given value can only appear in one of the slots or where the same choice can appear many times.

Each of the containers takes the form of an option which a name, a value and (optionally) an image.

**Attributes**

Set questions have the following attributes:

**Container Count**

Specifies the number of available selectable options.

**Unique**

If set, then each choice may be used at most, once.

**NoEmpty**

All slots must be filled with a non-zero value.

**Storage**

The set questions are stored as a Buffer with one byte for each Container.

**Results**

Each Container value is represented as two characters, one for each nibble. All hexadecimal characters (a-f) are in lower-case.

The results are represented as a series of Container values, starting with the lowest Container.

## Syntax

*ordered-list:=EFI\_IFR\_ORDERED\_LIST question-option-list*

## Options

Set questions treat the values specified by nested **EFI\_IFR\_ONE\_OF\_OPTION** values as the value for a single Container, not the entire question storage. This is different from other question types.

## Defaults

Set questions treat the default values specified by nested **EFI\_IFR\_DEFAULT** or **EFI\_IFR\_ONE\_OF\_OPTION** opcodes as the default value for all Containers. The default values must be of type **EFI\_IFR\_TYPE\_BUFFER**, with each byte in the buffer corresponding to a single Container value, starting with the first container. If the buffer contains fewer bytes than *MaxContainers*, then the remaining Containers will be set to a value of 0.

Default values returned from the ALTCFG section when **ExtractConfig()** is called fill the storage starting with the first container.

### 32.2.5.4.9 String

String questions allow modification of a string.

## Attributes

String questions have the following attributes:

### Minimum Length

Hint describes the minimum length of the string, in characters.

### Maximum Length

Hint describes the maximum length of the string, in characters.

### Multi-Line

Hint describes that the string might contain multiple lines.

### Output Mask

If set, the text entered will not be displayed.

### Storage

The string questions are stored as a **NULL**-terminated string. If the time question uses Buffer or EFI Variable storage (see [Section 32.2.5.6](#)), then the buffer size must exceed the size of the NULL-terminated string. If the string is shorter than the length of the buffer, the remainder of the buffer is filled with **NULL** characters.



## Results

Results for string questions are represented as hex dump of the string, including the terminating **NULL** character.

## Syntax

*string* = **EFI\_IFR\_STRING**      *question-option-list* /  
**EFI\_IFR\_PASSWORD**      *question-option-list*

### 32.2.5.4.10 Cross-Reference

Cross-reference questions provide a selectable means by which users navigate to other forms and/or other questions. The form and question can be in the current form set, another form set or even in a form associated with a different device. If the specified form or question does not exist, the button is not selectable, is grayed-out, or is suppressed.

## Attributes

Cross references can have the following attributes:

### Form Identifier

The identifier of the target form.

### Form Set Identifier

Optionally specifies an alternate form-set which contains the target form. If specified, then the focus will be on form within the form set specified by Form Identifier. If the Form Identifier is not specified, then the first form in the Form Set is used.

### Question Identifier

Optionally specifies the question identifier of the target question on the target form. If specified then focus will be placed on the question specified by this question identifier. Otherwise, the focus will be on the first question within the specified form.

### Device Path

Optionally, the device path which contains the Form Identifier. Otherwise, the device path associated with the form set containing this cross-reference will be used.

### Storage

Storage is optional for a cross-reference question. It is only present when the cross-reference question does not supply any target (i.e., REF5). If the question uses Buffer or EFI Variable storage (see [Section 32.2.5.6](#)), then the buffer size must be exactly the size of the **EFI\_HII\_REF** structure.

## Results

Results for cross-reference questions are represented as a hex dump of the question identifier, form identifier, form set GUID and null-terminated device

path text. If used in a question, the question value will be a buffer containing the **EFI\_HII\_REF** structure..

## Syntax

*cross-reference* := **EFI\_IFR\_REF** *statement-tag-list*

### 32.2.5.4.11 Time

Time questions allow modification of part or all of a time. The format of the time display depends on the Forms Browser and any localization.

## Attributes

Time questions have the following attributes:

### Hour Suppressed

The hour will not be displayed or updated.

### Minute Suppressed

The minute will not be displayed or updated.

### Second Suppressed

The second will not be displayed or updated.

## UEFI Storage

In addition to normal question Value Storage, time questions can be instructed to save the time to either the system time or system wake-up time using the UEFI runtime services **SetTime** or **SetWakeuptime**. In these instances, the date and time is read first, the modifications made and changes are then written back.

Conversion to and from strings to a time depends on the system localization.

The time value is stored as part of an **EFI\_HII\_TIME** structure. The contents of the other fields are undetermined.

## Storage

If the time question uses Buffer or EFI Variable storage (see [Section 32.2.5.6](#)), then the buffer size must be exactly the size of the **EFI\_HII\_TIME** structure..

## Results

Results for time questions are represented as a hex dump of the **EFI\_HII\_TIME** structure. If used in a question, the value will be a buffer containing the contents of the **EFI\_HII\_TIME** structure.

## Syntax

*time* := **EFI\_IFR\_TIME** *question-option-list*

### 32.2.5.5 Options

Use Options within questions to give text or graphic description of a particular question value. They may also describe the choices in the set data type.

## Attributes

Options have the following attributes:

### Text

The text for the option.

### Image

The optional image for the option.

### Animation

The optional animation for the option.

### Value

The value for the option.

### Default

If set, this is the option selected when the user asks for the defaults. Only one visible option can have this bit set within a question's scope.

### Manufacturing Default

If set, this is the option selected when manufacturing defaults are set. Only one visible option can have this bit set within a question's scope.

## Syntax

*option* := **EFI\_IFR\_ONE\_OF\_OPTION** *option-tag-list*

*option-tag-list* := *option-tag* *option-tag-list* |

<empty>

*option-tag* := **EFI\_IFR\_IMAGE**

**EFI\_IFR\_ANIMATION**

### 32.2.5.5.1 Visibility

Options which have been suppressed will not be displayed. Options are displayed unless:

- The parent question is suppressed.
- The option is nested inside an **EFI\_IFR\_SUPPRESS\_IF** expression which evaluated to false.

The suppression of the options is evaluated each time the option is displayed.

### 32.2.5.6 Storage

Question values are stored in *Variable Stores*, which are application, platform or device repositories for configuration settings. In many cases, this is non-volatile storage. In other cases, it holds only the current behavior of a driver or application.

Question values are retrieved from the variable store when the form is initialized. They are updated periodically based on question settings and stored back in the variable store when the form is submitted.

It is possible for a question to have no associated Variable Store. This happens when the `VarStoreId` associated with the question is set to zero and, for Date/Time questions, the UEFI Storage is disabled. For questions with no associated Variable Store, the question must either support the RETRIEVE and CHANGED callback actions (see [EFI\\_HII\\_CONFIG\\_ACCESS\\_PROTOCOL.CallBack\(\)](#)) or contain an embedded READ or WRITE opcode: `EFI_IFR_READ_OP` and `EFI_IFR_WRITE_OP` (see [Section 32.3.8.3.58](#) and [Section 32.3.8.3.94](#)).

Because the value associated with a question contained in a Variable Store can be shared by multiple questions, the questions must all treat the shared information as compatible data types. There are four types of variable stores:

### Buffer Storage

With buffer storage, the application, platform or driver provides the definition of a buffer which contains the values for one or more questions. The size of the entire buffer is defined in the `EFI_IFR_VARSTORE` definition. Each question defines a field in the buffer by providing an offset within the buffer and the size of the required storage. These variable stores are exposed by the app/driver using the `EFI_HII_CONFIG_ACCESS_PROTOCOL`, which is installed on the same handle as the package list. Question values are retrieved via `EFI_HII_CONFIG_ACCESS_PROTOCOL.ExtractConfig()` and updated via `EFI_HII_CONFIG_ACCESS_PROTOCOL.RouteConfig()`. Rather than access the buffer as a whole, Buffer Storage Variable Stores access each field independently, via a list of one or more (field offset, value) pairs encoded as variable length text strings as defined for the `EFI_HII_CONFIG_ACCESS_PROTOCOL`.

### Name/Value Storage

With name/value storage, the application provides a string which contains the encoded values for a single question. These variable stores are exposed by the app/driver using the `EFI_HII_CONFIG_ACCESS_PROTOCOL`, which is installed on the same handle as the package list.

### EFI Variable Storage

This is a specialized form of Buffer Storage, which uses the EFI runtime services `GetVariable()` and `SetVariable()` to access the entire buffer defined for the Variable Store as a single binary object..

### EFI Date/Time Storage

For date and time-related questions, the question values can be retrieved using the EFI runtime services `GetTime()` and `GetWakeUpTime()` and stored using the EFI runtime services `SetTime()` and `SetWakeUpTime()`.

The following table summarizes the types of information needed for each type of storage and where it is retrieved from.

Table 208. Information for Types of Storage

Storage Type	Information Type	Where It Comes From
None	Driver Handle	Handle specified with <b>NewPackageList()</b> or derived from <b>EFI_IFR_VARSTORE_DEVICE.DevicePath</b>
Buffer Storage	Driver Handle	Handle specified with <b>NewPackageList()</b> or derived from <b>EFI_IFR_VARSTORE_DEVICE.DevicePath</b>
	Variable ID	Variable store specified by <b>EFI_IFR_QUESTION_HEADER.VarStoreId.</b>
	Variable Name	Variable store specified by <b>EFI_IFR_QUESTION_HEADER.VarStoreId</b>
	Variable Store Offset	Variable store offset specified by <b>EFI_IFR_QUESTION_HEADER.VarOffset.</b>
Name/Value Storage	Driver Handle	Handle specified with <b>NewPackageList()</b> or derived from <b>EFI_IFR_VARSTORE_DEVICE.DevicePath</b>
	Variable ID	Variable store specified by <b>EFI_IFR_QUESTION_HEADER.VarStoreId.</b>
	Variable Name	Variable name specified by <b>EFI_IFR_QUESTION_HEADER.VarStoreInfo.VarName.</b>
EFI Variable Storage	Driver Handle	None
	Variable ID	Variable store specified by <b>EFI_IFR_QUESTION_HEADER.VarStoreId.</b>
	EFI_Variable GUID (for Variable Services)	EFI variable GUID specified by <b>EFI_IFR_VARSTORE_EFI.Guid.</b>
	EFI_Variable Name (for Variable Services)	EFI variable name specified by <b>EFI_IFR_VARSTORE_EFI.Name.</b>
	Variable Name	Variable name specified by <b>EFI_IFR_QUESTION_HEADER.VarStoreId.</b>
	Variable Store Offset	Variable store offset specified by <b>EFI_IFR_QUESTION_HEADER.VarStoreInfo.VarOffset.</b>
EFI Date/Time Storage	Driver Handle	None
	Variable ID	None
	Variable Name	None

### 32.2.5.7 Expressions

This section describes the expressions used in various expressions in IFR. The expressions are encoded using normal IFR opcodes, but in RPN (Reverse Polish Notation) where the operands occur before the operator.

The opcodes fall into these categories:

#### Unary operators

Functions taking a single sub-expression.

#### Binary operators.

Functions taking two sub-expressions.

#### Ternary operators.

Functions taking three sub-expressions.

#### Built-in functions.

Operators taking zero or more sub-expressions.

#### Constants.

Numeric and string constants.

#### Question Values.

Specified by their question identifier.

All integer operations are performed at 64-bit precision.

#### 32.2.5.7.1 Expression Encoding

Expressions are usually encoded within the scope of another binary object. If the expression consists of more than a single opcode, the first opcode should open a scope (*Header.Scope* = 1) and use an **EFI\_IFR\_END** opcode to close the scope in order to make sure they can be skipped,

#### 32.2.5.7.2 Expression Stack

When evaluating expressions, the Forms Processor uses a stack to hold intermediate values. Each operator either pushes a value on the stack, pops a value from the stack, or both. For example, the **EFI\_IFR\_ONE** operator pushes the integer value 1 on the expression stack. The **EFI\_IFR\_ADD** operator pops two integer values from the expression stack, adds them together, and pushes the result back on the stack.

After evaluating an expression, there should be only one value left on the expression stack.

#### 32.2.5.7.3 Rules

Rules are pre-defined expressions attached to the form. These rules may be used in any expression within the form's scope. Each rule is given a unique identifier (0-255) when it is created by **EFI\_IFR\_RULE**. This same identifier is used when the rule is referred to in an expression with **EFI\_IFR\_RULE\_REF**.

To save space, rules are intended to allow manual or automatic extraction of common sub-expressions from form expressions.

#### 32.2.5.7.4 Data Types

The expressions use five basic data types:

##### Boolean

True or false.

##### Unsigned Integer

64-bit unsigned integer.

##### String

Null-terminated string.

##### Buffer

Fixed size array of unsigned 8-bit integers.

##### Undefined

Undetermined value. Used when the value cannot be calculated or for run-time errors.

Data conversion is not implicit. Explicit data conversion can be performed using the [EFI\\_IFR\\_TO\\_STRING](#), [EFI\\_IFR\\_TO\\_UINT](#), and [EFI\\_IFR\\_TO\\_BOOLEAN](#) operators.

The Date and Time question values are converted to the *Buffer* data type filled with the **EFI\_HII\_DATE** and **EFI\_HII\_TIME** structure contents (respectively).

The Ref question values are converted to the Buffer data type and filled with the **EFI\_HII\_REF** and structure contents.

#### Syntax

The expressions have the following syntax:

*expression* := *built-in-function* |

*constant* |

*expression unary-op* |

*expression expression binary-op* |

*expression expression expression ternary-op*

*expression-pair-list*

##### **EFI\_IFR\_MAP**

*expression-pair-list* := *expression-pair-list expression expression* |  
<empty>

*optional-expression* := *expression* |

<empty>

*built-in-function* := EFI\_IFR\_DUP |  
EFI\_IFR\_EQ\_ID\_VAL |  
EFI\_IFR\_EQ\_ID\_ID |  
EFI\_IFR\_EQ\_ID\_VAL\_LIST |  
EFI\_IFR\_GET |  
EFI\_IFR\_QUESTION\_REF1 |  
EFI\_IFR\_QUESTION\_REF3 |  
EFI\_IFR\_RULE\_REF |  
EFI\_IFR\_STRING\_REF1 |  
EFI\_IFR\_THIS |  
EFI\_IFR\_SECURITY

*constant* := EFI\_IFR\_FALSE |  
EFI\_IFR\_ONE |  
EFI\_IFR\_ONES |  
EFI\_IFR\_TRUE |  
EFI\_IFR\_UINT8 |  
EFI\_IFR\_UINT16 |  
EFI\_IFR\_UINT32 |  
EFI\_IFR\_UINT64 |  
EFI\_IFR\_UNDEFINED |  
EFI\_IFR\_VERSION |  
EFI\_IFR\_ZERO

*binary-op* := EFI\_IFR\_ADD |  
EFI\_IFR\_AND |  
EFI\_IFR\_BITWISE\_AND |  
EFI\_IFR\_BITWISE\_OR |  
EFI\_IFR\_CATENATE |  
EFI\_IFR\_DIVIDE |  
EFI\_IFR\_EQUAL |  
EFI\_IFR\_GREATER\_EQUAL |  
EFI\_IFR\_GREATER\_THAN |  
EFI\_IFR\_LESS\_EQUAL |  
EFI\_IFR\_LESS\_THAN |  
EFI\_IFR\_MATCH |  
EFI\_IFR\_MATCH2 |



EFI\_IFR\_MODULO |  
 EFI\_IFR\_MULTIPLY |  
 EFI\_IFR\_NOT\_EQUAL |  
 EFI\_IFR\_OR |  
 EFI\_IFR\_SHIFT\_LEFT |  
 EFI\_IFR\_SHIFT\_RIGHT |  
 EFI\_IFR\_SUBTRACT |  
*unary-op* :=EFI\_IFR\_LENGTH |  
 EFI\_IFR\_NOT |  
 EFI\_IFR\_BITWISE\_NOT |  
 EFI\_IFR\_QUESTION\_REF2 |  
 EFI\_IFR\_SET |  
 EFI\_IFR\_STRING\_REF2 |  
 EFI\_IFR\_TO\_BOOLEAN |  
 EFI\_IFR\_TO\_STRING |  
 EFI\_IFR\_TO\_UINT |  
 EFI\_IFR\_TO\_UPPER |  
 EFI\_IFR\_TO\_LOWER  
*ternary-op* :=EFI\_IFR\_CONDITIONAL |  
 EFI\_IFR\_FIND |  
 EFI\_IFR\_MID |  
 EFI\_IFR\_TOKEN |  
 EFI\_IFR\_SPAN

### 32.2.5.8 Defaults

Defaults are pre-defined question values. The question values may be changed to their defaults either through a Forms Processor-defined means or when the user selects an **EFI\_IFR\_RESET\_BUTTON** statement (see [Section 32.2.5.3.8](#)). Each question may have zero or more default values, with each default value used for different purposes. For example, there might be a "standard" default value, a default value used for manufacturing and a "safe" default value. A group of default values used to configure a platform or device for a specific purpose is called default store.

#### Default Stores

There are three standard default stores:

##### Standard Defaults

These are the defaults used to prepare the system/device for normal operation.

##### Manufacturing Defaults

These are the defaults used to prepare the system/device for manufacturing.

### Safe Defaults

These are the defaults used to boot the system in a "safe" or low-risk mode.

## Attributes

Default stores have the following attributes:

### Name

Each default store has a user-readable name

### Identifier

A 16-bit unsigned integer. The values between 0x0000 and 0x3fff are reserved for use by the UEFI specification. The values between 0x4000 and 0x7fff are reserved for platform providers. The values between 0x8000 and 0xbfff are reserved for hardware vendors. The values between 0xc000 and 0xffff are reserved for firmware vendors.

```
#define EFI_HII_DEFAULT_CLASS_STANDARD 0x0000
#define EFI_HII_DEFAULT_CLASS_MANUFACTURING 0x0001
#define EFI_HII_DEFAULT_CLASS_SAFE 0x0002
#define EFI_HII_DEFAULT_CLASS_PLATFORM_BEGIN 0x4000
#define EFI_HII_DEFAULT_CLASS_PLATFORM_END 0x7fff
#define EFI_HII_DEFAULT_CLASS_HARDWARE_BEGIN 0x8000
#define EFI_HII_DEFAULT_CLASS_HARDWARE_END 0xbfff
#define EFI_HII_DEFAULT_CLASS_FIRMWARE_BEGIN 0xc000
#define EFI_HII_DEFAULT_CLASS_FIRMWARE_END 0xffff
```

Users of these ranges are encouraged to use the specification defined ranges for maximum interoperability. Questions or platforms may support defaults for only a subset of the possible default stores. Support for default store 0 ("standard") is recommended.

## Defaulting

When retrieving the default values for a question, the Forms Processor uses one of the following (listed from highest priority to lowest priority):

1. The value returned from the **Callback()** member function of the Config Access protocol associated with the question when called with the *Action* set to one of the **EFI\_BROWSER\_ACTION\_DEFAULT\_x** values (see [Section 34.5](#)). It is recommended that this form only be used for questions where the default value alters dynamically at runtime.
2. The value returned in the *Response* parameter of the **ConfigAccess()** member function (using the ALTCFG form). See [Section 34.2.1](#).
3. The value specified by an **EFI\_IFR\_DEFAULT** opcodes appear within the scope of a question. (see [Section 32.3.8.3.12](#))
4. One of the Options (see [Section 32.2.5.5](#)) has its Standard Default or Manufacturing Default attribute set.

5. For Boolean questions, the Standard Default or Manufacturing Default values in the Flags field. (see [Section 32.2.5.4.5](#)).

## Syntax

*Default* := **EFI\_IFR\_DEFAULT**  
*default-tag* := **EFI\_IFR\_VALUE** |  
<empty>

### 32.2.5.9 Validation

Validation is the process of determining whether a value can be applied to a configuration setting. Validation takes place at three different points in the editing process: edit-level, question-level and form-level.

#### 32.2.5.9.1 Edit-Level Validation

First, it takes place while the value is being edited with a Forms Browser. The Forms Browser may optionally reject values selected by the user which would fail Question-Level validation. For example, the Forms Browser may limit the length of strings entered so that they meet the Minimum and Maximum Length.

#### 32.2.5.9.2 Question-Level Validation

Second, it takes place when the value has changed, normally when the user attempts to leave the control, navigate between the portions of the control or selects one of the option values. At this point, an error occurs if:

- For a String (see [Section 32.2.5.4.9](#)), if the string length is less than the Minimum Length, then the Forms Processor generates an error.
- For a String (see [Section 32.2.5.4.9](#)), if the string length is greater than the Maximum Length, then the Forms Processor generates an error.
- For a Number (see [Section 32.2.5.4.7](#)), if the number cannot fit in the specified variable storage without loss of significant bits, then the Forms Processor generates an error.
- For all questions, if an **EFI\_IFR\_INCONSISTENT\_IF** evaluates to TRUE, then the Forms Processor will display the specified error text.
- For all questions, if an **EFI\_IFR\_WARNING\_IF** evaluates to TRUE, then the Forms Processor will display the specified warning text.

#### 32.2.5.9.3 Form-Level Validation

Third, it takes place when exiting the form or when the values are submitted. The error occurs under two conditions:

- For all questions, if an **EFI\_IFR\_NO\_SUBMIT\_IF** evaluates to TRUE, then the Forms Processor will display the specified error text.
- If a Forms Processor such as a script processor performs Form-Level validation, where the concept of a form is not maintained, then the Form-Level validation must

occur before processing question values from other forms or before completion of the configuration session.

### 32.2.5.10 Forms Processing

Forms Processors interpret the IFR in order to extract information about configuration settings. This section describes how the IFR should be interpreted and how errors should be handled.

#### 32.2.5.10.1 Error Handling

The Forms Processor may encounter problems in interpreting the IFR. This section describes the standard ways of handling these issues:

##### **Unknown Opcodes.**

Unknown opcodes have a type which is not recognized by the Forms Processor. In general, the Forms Processor ignores the opcode, along with any nested opcodes.

##### **Malformed Opcodes.**

Malformed objects have a length which is less than the minimum length for that object type. In this case, the entire form is disabled.

##### **Extended Opcodes.**

Extended objects have a length longer than that expected by the Forms Processor. In this case, the Forms Processor interprets the object normally and ignores the extra data.

##### **Malformed Forms Sets**

Malformed forms sets occur when an object's length would cause it extend beyond the end of the forms set, or when the end of the forms set occurs while a scope is still open. In this case, the entire forms set is ignored.

##### **Reserved Bits Set.**

The Forms Processor should ignore all set reserved bits.

### 32.2.5.11 Forms Editing

This section describes considerations for Forms Editors, which are a specialized Forms Processor which can create and manipulate form lists, forms and questions in their binary form.

#### 32.2.5.11.1 Locking

Locking indicates that a question or statement,--along with its related options, prompts, help text or images--should not be moved or edited. A statement or question is locked when the **IFR\_LOCKED** opcode is found within its scope.

UEFI-compliant Forms Editors must allow statements or questions within an image to be locked, but should not allow them to be unlocked. UEFI-compliant Forms Editors must not allow modification of locked statements or questions or any of their associated data (including options, text or images).

*Note: This mechanism cannot prevent unauthorized modification. However, it does clearly state the intent of the driver creator that they should not be modified.*

### 32.2.5.11.2 Moving Forms

When forms are moved between form sets, the related data (such as forms, variable stores and default stores) need to have their references renumbered to avoid conflicts with identifiers in the new form set. For forms, these include:

- **EFI\_IFR\_FORM** or **EFI\_IFR\_FORM\_MAP** (and all references in **EFI\_IFR\_REF**)
- **EFI\_IFR\_DEFAULTSTORE** (and all references in **EFI\_IFR\_DEFAULT**)
- **EFI\_IFR\_VARSTORE\_x** (and all references within question headers)

### 32.2.5.11.3 Moving Questions

When questions are moved between form sets, the related data (such as images and strings) need to be moved and references to results-processing and storage may need to be revised. For example:

#### String and Images.

If the question is being moved to another form set, then all strings and images associated with the question must be moved to the package list containing the form set and removed from the current one.

#### Form Set.

If the question is moved to a package list installed by a different driver, then the **EFI\_IFR\_VAR\_STORAGE\_DEVICE** (see [Section 32.3.8.3.92](#)) should be nested in the scope of the question, describing the driver installation device path.

#### Question References.

If a question value in another form set is referred to in any expressions (such as **EFI\_IFR\_INCONSISTENT\_IF** or **EFI\_IFR\_NO\_SUBMIT\_IF** or **EFI\_IFR\_WARNING\_IF**) using either **EFI\_IFR\_QUESTION\_REF2** (see [Section 32.3.8.3.56](#)) or **EFI\_IFR\_QUESTION\_REF1** (see [Section](#)) then these must be converted to a form of **EFI\_IFR\_QUESTION\_REF3** (see [Section 32.3.8.3.57](#)), specifying the EFI\_GUID of the form set and/or the device path of the package list containing the form set wherein the question referred to is defined.

When questions are moved between forms, whether in the same form list or another form list, question behavior reliant on the current form may need revision. One example is the use of [EFI\\_IFR\\_RULE\\_REF](#) in expressions. Here, rules are shortcuts for common expressions used in a form. If a question is moved to another form, the references to any rules in expressions must be replaced by the expression itself.

### 32.2.5.12 Forms Processing & Security Privileges

The IFR provides a way for a Forms Processor to identify which forms, statements, questions and even question values are available only to users with specific privilege levels and enforce those privilege levels.

Setup access security privileges are described in terms of GUIDs. The current user profile either has the specified privilege or it does not. The **EFI\_IFR\_SECURITY** opcode returns whether or not the current user profile has the specified setup access privilege.

Combined with the expressions such as **EFI\_IFR\_DISABLE\_IF**, **EFI\_IFR\_SUPPRESS\_IF**, **EFI\_IFR\_GRAY\_OUT\_IF**, **EFI\_IFR\_WARNING\_IF**, **EFI\_IFR\_INCONSISTENT\_IF** and **EFI\_IFR\_NOSUBMIT\_IF**, the author of a form can control access to specific forms, statements and questions, or even control whether specific values are valid.

Forms Processors on systems with multiple setup-related user privilege levels must support report these correctly when processing the **EFI\_IFR\_SECURITY** opcode.

Forms Processors on systems which support the UEFI User Authentication proposal must correctly inquire from the current user profile whether or not it has security privileges (see [Section 35.4.1.6](#) on **EFI\_USER\_INFO\_ACCESS\_SETUP** and [Section 35.3.1](#) on **EFI\_USER\_MANAGER\_PROTOCOL.GetInfo()**).

Forms Processors on systems which support re-identification during the platform configuration process must support reevaluation of the **EFI\_IFR\_SUPPRESS\_IF** and **EFI\_IFR\_GRAY\_OUT\_IF** upon receipt of notification that the current user profile has been changed by using the UEFI Boot Service **CreateEventEx()** and the **EFI\_USER\_PROFILE\_CHANGED\_EVENT\_GUID**.

### 32.2.6 Strings

Strings in the UEFI environment are defined using UCS-2, which is a 16-bit-per-character representation. For user-interface purposes, strings are one of the types of resources which can be installed into the HII Database (see [Section 32.2.9](#)).

In order to facilitate localization, users reference strings by an identifier unique to the package list which the driver installed. Each identifier may have several translations associated with it, such as English, French, and Traditional Chinese. When displaying a string, the Forms Browser selects the actual text to display based on the current platform language setting.

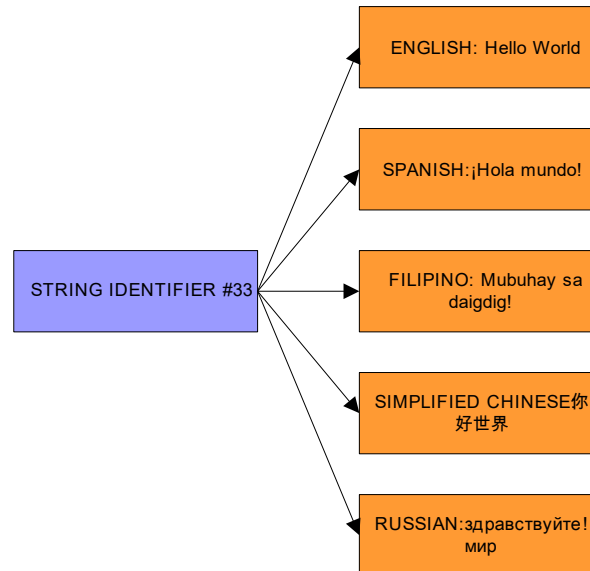

Figure 102. String Identifiers

The actual text for each language is stored separately (in a separate package), which makes it possible to add and remove language support just by including or excluding the appropriate package.

Each string may have font information, including the font family name, font size and font style, associated with it. Not all platforms or displays can support fonts and styles beyond the system default font (see [Section 32.2.7](#)), so the font information associated with the string should be viewed as a set of hints.

### 32.2.6.1 Configuration Language Paradigm

This specification uses the RFC 4646 language naming scheme to identify the language that a given string is associated with. Since RFC 4646 allows for the same Primary language tags to contain a large variation of subtags (e.g. regions), a best matching language algorithm is defined in RFC 4647. Callers of interfaces that require RFC 4646 language codes to retrieve a Unicode string, must use the RFC 4647 algorithm to lookup the Unicode string with the closest matching RFC 4646 language code.

Since the majority of strings discussed in this specification are associated with generating a user interface, the languages that are typically associated with strings have commonly defined languages such as en-US, zh-Hant, and it-IT. The RFC 4646 standard also reserves for private use languages prefixed with a value of "x".

**Note:** *This specification defines for its own purposes one of these private use areas as a special-purpose language that components can use for extracting information out of. Assume that any private-use languages encountered by a compliant implementation will likely consider those*

*languages as configuration languages, and the associated behavior when referencing those languages will be platform specific. [Section 32.2.11.2](#) describes an example of such a use.*

### 32.2.6.2 Unicode Usage

This section describes how different aspects of the Unicode specification related to the strings within this specification.

#### 32.2.6.2.1 Private Use Area

Unicode defines a *private use* area of 6500 characters that may be defined for local uses. Suggested uses include Egyptian Hieroglyphics; see *Developing International Software For Windows 95\* and Windows NT\** for more information. UEFI prohibits use of this area in a UEFI environment. This is because a centralized font database accumulated from the various drivers (a valid implementation) would end up with collisions in the private use area, and, generally, an XML browser could not display these characters.

#### 32.2.6.2.2 Surrogate Area

The Unicode specification has two 16-bit character representations: UCS-2 and UTF-16. The UEFI specification uses UCS-2. The primary difference is that UTF-16 defines *surrogate areas* (see page 56 in *Professional XML*) that allow for expanded character representations of the 16-bit Unicode. These character representations are very similar to Double Byte Character Set (DBCS)—2048 Unicode values split into two groups (D800–DBFF and DC00–DFFF). They are defined as having 16 additional bits of value to make up the character, for a total of about one million extra characters. UEFI does not support surrogate characters.

#### 32.2.6.2.3 Non-Spacing Characters

Unicode uses the concept of a *nonspacing* character. These glyphs are used to add accents, and so on, to other characters by what amounts to logically OR'ing the glyph over the previous glyph. There does not appear to be any predictable range in the Unicode encoding to determine nonspacing characters, yet these characters appear in many languages. Further, these characters enable spelling of several languages including many African languages and Vietnamese.

#### 32.2.6.2.4 Common Control Codes

This specification allows the encoding of font display information within the strings using special control characters. These control codes are meant as display hints, and different platforms may ignore them, depending on display capabilities.

In single-byte encoding, these are in the form **0x7F 0xyy** or **0x7F 0x0y 0xzz**. Single-byte encoding is used only when coupled with the Standard Compression Scheme for Unicode, described in [Section 32.3.6.3](#).

In double-byte encoding, these are in the form **0xF6yy**, **0xF7zz** or **0xF8zz**. When converted to UCS-2, all control codes should use the **0xFxyy** form.



**Table 209. Common Control Codes for Font Display Information**

Value	Description	Single-Byte Encoding	Double-Byte Encoding
0x00	Font Family Select. The subsequent text will be displayed in the font specified by the following byte.	0x7F 0x00 0xzz	0xF7zz
0x01	Font Size Select. The subsequent text will be displayed in the point size, in half points, specified by the following byte.	0x7F 0x01 0xzz	0xF8zz
0x20	Bold On.	0x7F 0x20	0xF620
0x21	Bold Off	0x7F 0x21	0xF621
0x22	Italic On	0x7F 0x22	0xF622
0x23	Italic Off	0x7F 0x23	0xF623
0x24	Underline On	0x7F 0x24	0xF624
0x25	Underline Off	0x7F 0x25	0xF625
0x26	Emboss ON	0x7F 0x26	0xF626
0x27	Emboss OFF	0x7F 0x27	0xF627
0x28	Shadow ON	0x7F 0x28	0xF628
0x29	Shadow OFF	0x7F 0x29	0xF629
0x2A	DbiUnderline ON	0x7F 0x2A	0xF62A
0x2B	DbiUnderline OFF	0x7F 0x2B	0xF62B

### 32.2.6.2.5 Line Breaks

This section describes the use of control characters to determine where break opportunities within strings. These guidelines are based on Unicode Technical Report #14, but are significantly simplified.

#### Spaces

In general, any of the following space characters is a line-break opportunity:

0020	SPACE
1680	OGHAM SPACE MARK

2000	EN QUAD
2001	EM QUAD
2002	EN SPACE
2003	EM SPACE
2004	THREE-PER-EM SPACE
2005	FOUR-PER-EM SPACE
2006	SIX-PER-EM SPACE
2008	PUNCTUATION SPACE

2009	THIN SPACE
200A	HAIR SPACE
205F	MEDIUM MATHEMATICAL SPACE

When a space is desired without a line-break opportunity, one of the following spaces should be used:

00A0	NO-BREAK SPACE (NBSP)
202F	NARROW NO-BREAK SPACE (NNBSP)

### In-Word Break Opportunities

In some cases, allowing line-breaks in a word is desirable. These line break opportunities should be explicitly described using one of the characters from the following list:

200B	ZERO WIDTH SPACE (ZWSP)
------	-------------------------

### Hyphens

The following characters are hyphens and other characters which describe line break opportunities after the character.

058A	ARMENIAN HYPHEN
2010	HYPHEN
2012	FIGURE DASH
2013	EN DASH
0F0B	TIBETAN MARK INTERSYLLABIC TSHEG
1361	ETHIOPIC WORDSPACE
17D5	KHMER SIGN BARIYOOSAN

The following characters describe line break opportunities before and after them, but not between a pair of them:

2014	EM DASH
------	---------

The following characters describe a hyphen which is not a line-breaking opportunity:

2011	NON-BREAKING HYPHEN (NBHY)
------	----------------------------

### Mandatory Breaks

The following characters force a line-break:

000A	NEW LINE
000C	FORM FEED
000D	CARRIAGE RETURN
2028	LINE SEPARATOR

2029

PARAGRAPH SEPARATOR

## 32.2.7 Fonts

This section describes how fonts are used within the UEFI environment.

UEFI describes a standard font, which is required for all systems which support text display on bitmapped output devices. The standard font (named 'system') is a fixed pitch font, where all characters are either narrow (8x19) or wide (16x19). UEFI also allows for display of other fonts, both fixed-pitch and variable-pitch. Platform support for these fonts is optional.

UEFI fonts are described using either the Simplified Font Package ([Section 32.3.2](#)) or the normal Font Package ([Section 32.3.3](#)).

### 32.2.7.1 Font Attributes

Fonts have the following attributes:

#### Font Name

The font name describes, in broad terms, the visual style of the font. For example, "Arial" or "Times New Roman". The standard font always has the name "sysdefault".

#### Font Size

The font size describes the maximum height of the character cell, in pixels. The standard font always has the font size of 19.

#### Font Style

The font style describes standard visual modifies to the base visual style of a font. Supported font styles include: bold, italic, underline, double-underline, embossed, outline and shadowed. Some font styles may also be simulated by the font rendering engine. The standard font always has no additional font styles.

### 32.2.7.2 Limiting Glyphs

Strings in the UEFI environment can be presented in environments with very different limitations. The most constrained environment is in the firmware phases prior to discovery of a boot device with a system partition. The main limitation in this environment is storage space. If unexpected strings could be displayed before system partition availability, the UEFI environment would have to store glyphs for all characters in a Unicode font. After system partition discovery, all glyphs could be made available.

Careful user interface design can limit to a manageable number, the quantity of unexpected characters that the system could be called on to display. Knowing what strings the firmware is going to display limits the number of glyphs it is required to carry.

In addition, carefully designed firmware can support a system where a limited number of strings are displayed before system partition availability. This may be done while enabling the input and display of large numbers of characters/glyphs using a full font file stored on the system partition. In such a situation, the designer must ensure that enough information can be displayed. The designer must also insure that the configuration can be

changed using only information from firmware-based non-volatile storage to obtain access to a satisfactory system partition.

UEFI requires platform support of a font containing the basic Latin character set.

While the system firmware will carry this standard font, there might be times when a UEFI application or driver requires the printing of a character not contained within the platform firmware. In this case, a UEFI driver or application can carry this font data and add it to the font already present in the HII Database. New font glyphs are accepted when there is no font glyph definition for the Unicode character already in the specified font.

In addition the standard system font and fonts extended by UEFI applications or drivers, it is possible for drivers that implement the EFI HII Font Glyph Generator Protocol to render additional font glyphs with specific font name, style, and size information, and add the new font packages to the HII Database. That is when HII Font Ex searches the glyph block in the existing HII font packages, it will try to locate

**EFI\_HII\_FONT\_GLYPH\_GENERATOR\_PROTOCOL** protocol for generating the corresponding glyph block and inserting the new glyph block into HII font package if the glyph block information is not exist in any HII font package. The HII font package which the new glyph block inserted can be an existing HII font package or a new HII font package created by HII Font Ex according to the **EFI\_FONT\_DISPLAY\_INFO** of character.

The figure below shows how fonts interact with the HII database and UEFI drivers, even if the font does not already exist in the database.

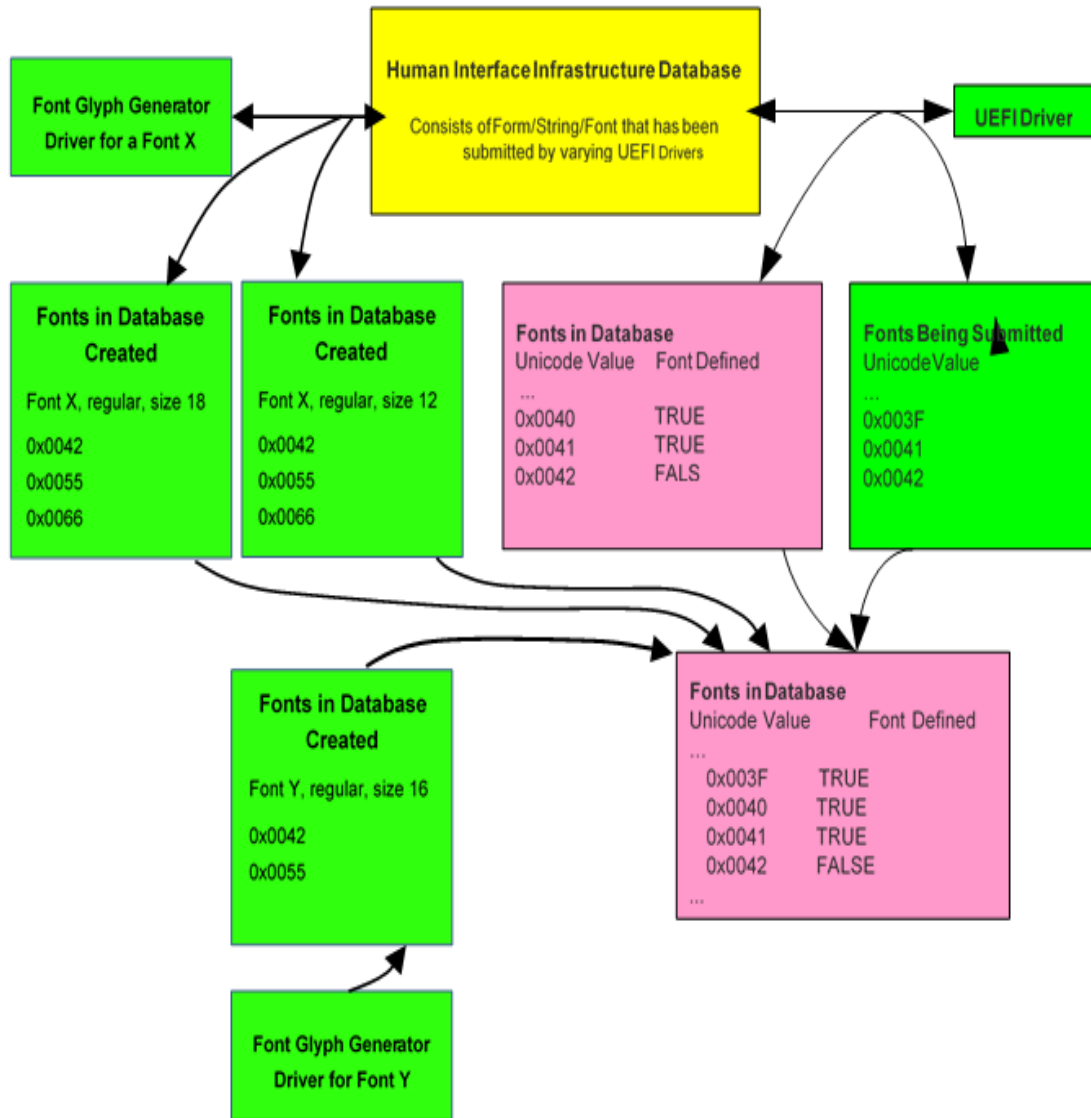

Figure 103. Fonts

### 32.2.7.3 Fixed Font Description

To allow a UEFI application or driver to extend the existing fonts with additional characters, the UEFI driver must be able to provide characters that fit aesthetically with the system font. For this reason the capability to define attributes of different fonts and to suggest a reasonable default target for these parameters is important.

Fonts can vary in width, style, baseline, height, size, and so on. The fixed font definition includes white space and the glyph data, as well as the positioning of the glyph data. This prevents characters of different fixed fonts from being adjusted at runtime to fit

aesthetically together. To provide UEFI drivers with a basic description of how to design fixed font characters, a subset of industry standard font terms are defined below:

**baseline**

The distance from upper left corner of cell to the base of the Caps (A, B, C,...)

**cap\_height**

The distance from the base of the Caps to the top of the Caps

**x\_height**

The distance from the baseline to the top of the lower case 'x'

**descender**

The distance some characters extended below the baseline (g, j, p, q, y)

**ascender**

The distance from the top of the lower case 'x' to the tall lower case characters (b, d, f, h, k, l)

The following figure illustrates the font description terms:

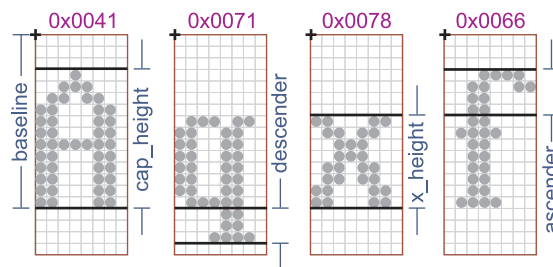

**Figure 104. Font Description Terms**

This 8x19 system font example (above), follows the original VGA 8x16 definition and creating double wide vertical lines, giving a *bold* look to the font (style = bold). Along with matching the 8x19 base system font, if a UEFI driver wants to extend the DBCS (Double Byte Character Set) font, it must be aware of the parameters that describe the 16x19 font, as shown below.

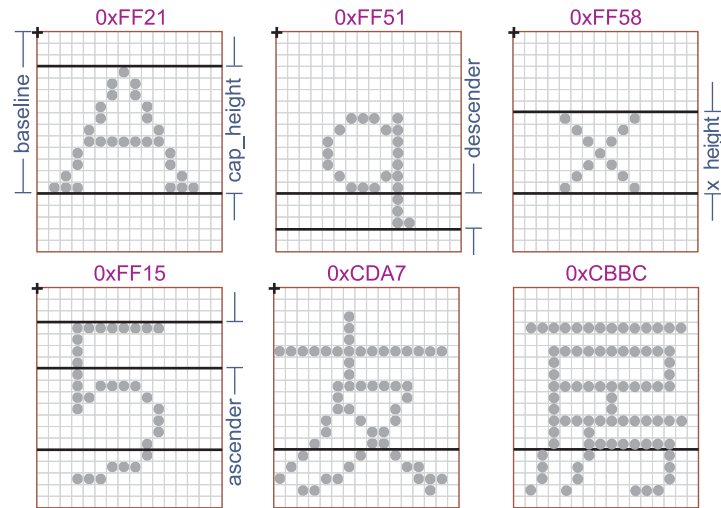

**Figure 105. 16 x 19 Font Parameters**

This 16x19 font example (above) has a style of *plain* (single width vertical lines) instead of *bold* like the 8x19 font, since there is not enough horizontal resolution to cleanly define the DBCS glyphs. The 16x19 ASCII characters have also been designed in a style matching the DBCS characters, allowing them to fit aesthetically together. Note that the default 16x19 fixed width characters are not stored like 1-bit images, one row after another; but instead stored with the left column (19 bytes) first, followed by the right column (19 bytes) of character data. The figure below shows how the characters of the previous figure would be laid out in the font structure.

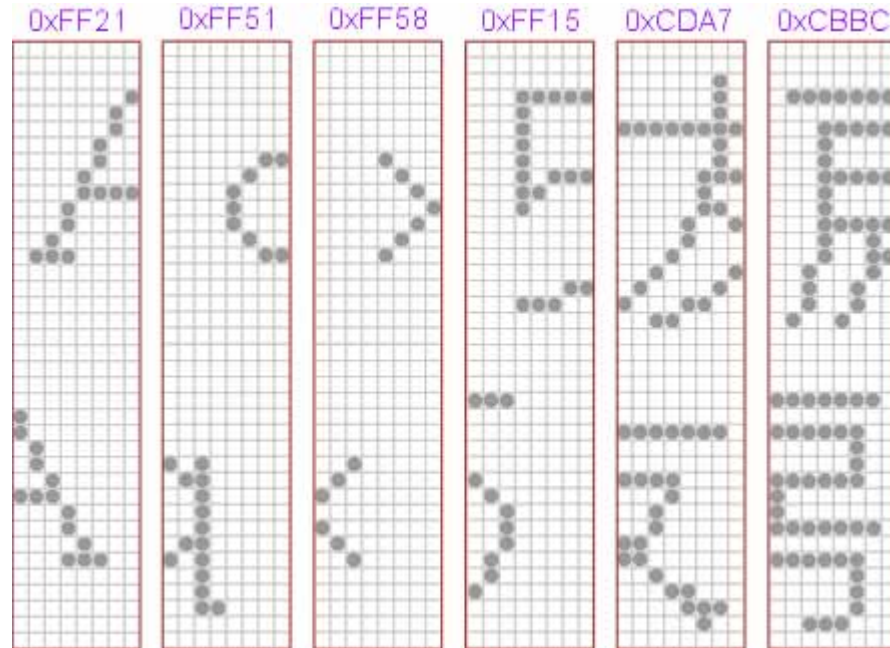

Figure 106. Font Structure Layout

### 32.2.7.3.1 System Fixed Font Design Guidelines

To allow a UEFI application or driver to extend the fixed font character set, the UEFI system fonts must adhere, at least roughly, to the design guidelines in the table below:

Table 210. Guidelines for UEFI System Fonts

Term	8 x 19 Font	16 x 19 Font
baseline	15 pixels	14 pixels
cap_height	12 pixels	11 pixels
x_height	8 pixels	7 pixels
descender	3 pixels	4 pixels
ascender	4 pixels	4 pixels

In the table above lists the terms in priority order. The most critical guideline to match is the *baseline*, followed by *cap\_height* and *x\_height*. The terms *descender* and *ascender* are not as critical to the aesthetic look of the font as are the other terms. These font design parameters are only guidelines. Failing to match them will not prevent reasonable operation of a UEFI driver that attempting to extend the system font.

### 32.2.7.4 Proportional Fonts Description

Unlike the fixed fonts, proportional fonts do not have a predefined character cell; instead the character cell is created based on the characters that are being displayed in the current line. In a proportional font only the glyph data is defined, no whitespace. Instead,



the proportional font defines five parameters (Width, Height, Offset\_X, Offset\_Y, & Advance), which allow the glyph data to be positioned in the character cell and calculate the origin of the next character.

In the figure below, you can see these parameters (in '[...].') for the characters shown, in addition you can see the actual byte storage (the padding to the nearest byte is shown shaded).

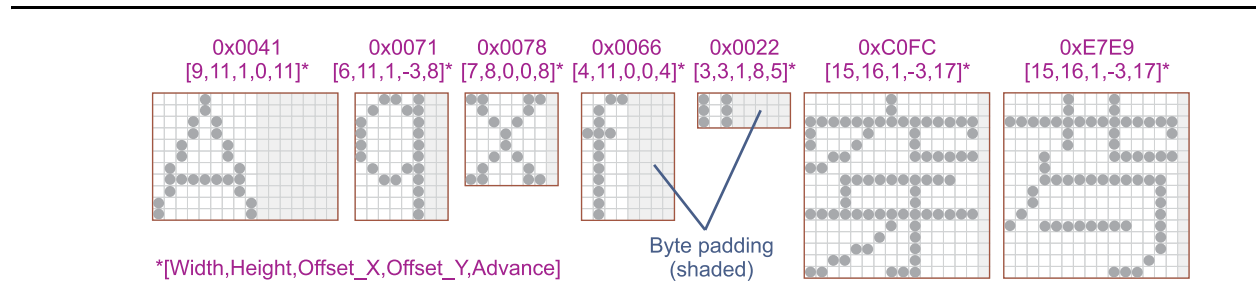

Figure 107. Proportional Font Parameters and Byte Padding

To determine font *baseline*, scan all font glyphs calculating sum of Height and Offset\_Y for each glyph. The largest value of the sum defines location of the *baseline*.

The font *line height* is calculated by adding *baseline* with the largest by absolute value negative Offset\_Y among all the font glyphs.

### 32.2.7.4.1 Aligning Glyphs to the Baseline

To display a line of proportional glyphs, *baseline* and *line height* have to be determined. If all the characters to be displayed are from the same font, the *baseline* and *line height* are the *baseline* and *line height* of the font.

If the characters being displayed are from different fonts, scan glyphs of the characters to be displayed calculating sum of Height and Offset\_Y for each glyph. The largest value of the sum defines location of the *baseline*.

The *line height* is calculated by adding *baseline* with the largest by absolute value negative Offset\_Y among all the characters to be displayed.

As shown in the following figure, once the *baseline* value is found it is added to the starting position of the line to calculate the *Origin*. From the *Origin*, each and every glyph can be generated based on the individual glyph parameters, including the calculation of the next glyph's *Origin*.

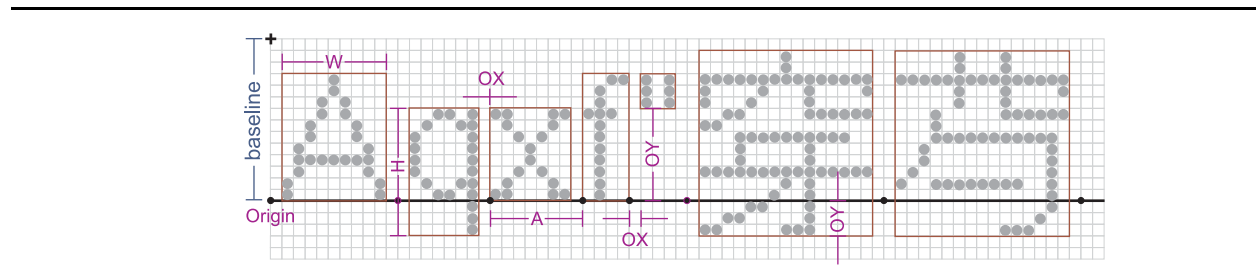

Figure 108. Aligning Glyphs

The starting position (upper left hand corner) of the glyph is defined by (Origin\_X + Offset\_X), (Origin\_Y – (Offset\_Y + Height)). The Origin of the next glyph is defined by (Origin\_X + Advance), (Origin\_Y).

In addition to determining the *line height* and *baseline* values; the scan of the characters also calculates the *line width* by totaling up all of the *advance* values.

#### 32.2.7.4.2 Proportional Font Design Guidelines

This method of aligning glyphs to a baseline allows one to place wildly different characters correctly position on a single line. However there still is a need for the system proportional fonts to roughly adhere to overall font height (19 pixels high character cells) and the placement of the baseline at the bottom of the Caps (if applicable or about 5 pixels up from the bottom of the character cell). These guidelines are not as critical as the fixed font guidelines, since the character cell height are defined at runtime, based on what else is displayed with that character.

### 32.2.8 Images

The format of the images to be stored in the Human Interface Infrastructure (HII) database have been created to conform to the industry standard 1-bit, 4-bit, 8-bit, and 24-bit video memory layouts. The 24-bit and 32-bit display systems have the exact same display capabilities and the exact same pixel definition. The difference is that the 32-bit pixels are DWORD aligned for improve CPU efficiency when accessing video memory. The extra byte that is inserted from the 24-bit and the 32-bit layout has no bearing on the actual screen.

Video memory is arranged *left-to-right*, and then *top-to-bottom*. In a 1-bit or monochrome display, the most significant bit of the first byte defines the screen's upper left most pixel. In a 4-bit or 16 color, display the most significant nibble of the first byte defines the screen's upper left most pixel. In a 8-bit or 256 color display, the first byte defines the screen's upper left most pixel.

In both the 24-bit and 32-bit TrueColor displays, the first three bytes defines the screen's upper left most pixel. The first byte is the pixel's blue component value, the next byte is the pixel's green component value, and the third byte is the pixel's red component value (B,G,R). Each color component value can vary from 0x00 (color off) to 0xFF (color full on), allowing 16.8 millions colors that can be specified. In the 32-bit TrueColor display modes, the fourth byte is a *don't care*.

#### 32.2.8.1 Converting to a 32-bit Display

The UEFI recommended video mode for computer-like devices uses a 32-bit Linear Frame Buffer video mode. All images stored in the HII database will need conversion to 32-bit before display.

To display a 24-bit image into 32-bit video memory, a pixel of the image is retrieved (read DWORD value advance pixel offset by 3) and then written to the video memory (write DWORD value advance pixel offset by 4).

To display any of the non-TrueColor images (1-bit, 4-bit, and 8-bit), there is an extra step of indirection through the palette definition to get the TrueColor pixel value. First retrieve

the palette index value by isolating the corresponding bits, then index into the associated palette to retrieve the 24-bit (B,G,R) color entry (read DWORD value), then write it to the video memory (write DWORD value advance pixel offset by 4). For this reason, the palette color entry definition is defined exactly the same as the image color pixel (B,G,R).

### 32.2.8.2 Non-TrueColor Displays

It is possible to display the HII database images on non-TrueColor video modes. You cannot however, display images beyond the bit depth of the target screen resolution. For example you would be able to display 1-bit, 4-bit, and 8-bit images in a 256 color video mode. To do this you must create a global palette (256 entries), by merging all images color needs to a best fit palette and then programming the hardware palette with that data.

The hardware palette color definition (R,G,B) is backwards from the screen pixel definition (B,G,R), and will have to be swapped before programming. In addition, the hardware palette may only support 6-bit of magnitude per color component instead of the 8-bit defined in the palette information section; therefore the values will have to be shifted before writing.

### 32.2.9 HII Database

The Human Interface Infrastructure (HII) database is the resource that serves as the repository of all the form, string, image and font data for the system. Drivers that contain information that is appropriate for the database will export this data to the HII database.

For example, one driver might contain all the motherboard-specific data (the traditional "Setup" for the system). Additionally, add-in cards may contain their own drivers, which, in turn, have their own Setup-related data. All of the drivers that contain Setup-related data would export their information to the HII database, as shown in the figure below.

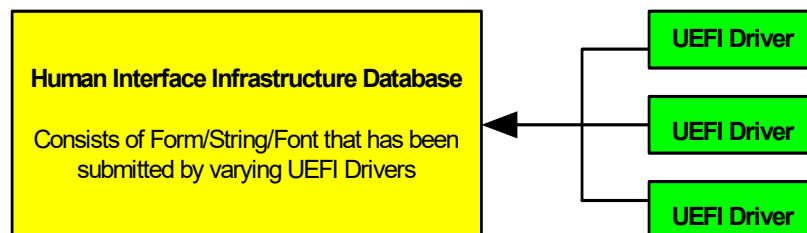

Figure 109. HII Database

### 32.2.10 Forms Browser

The UEFI Forms Browser is the service that reads the contents of the HII Database and interprets the forms data in order to present it to the user. For example, the Forms Browser can be used to gather all setup-related data and presents it to the user. This service also takes the user input and allows for changes to be saved into non-volatile storage.

The figure below shows the relationship between the HII database, UEFI drivers, and the UEFI Forms Browser.

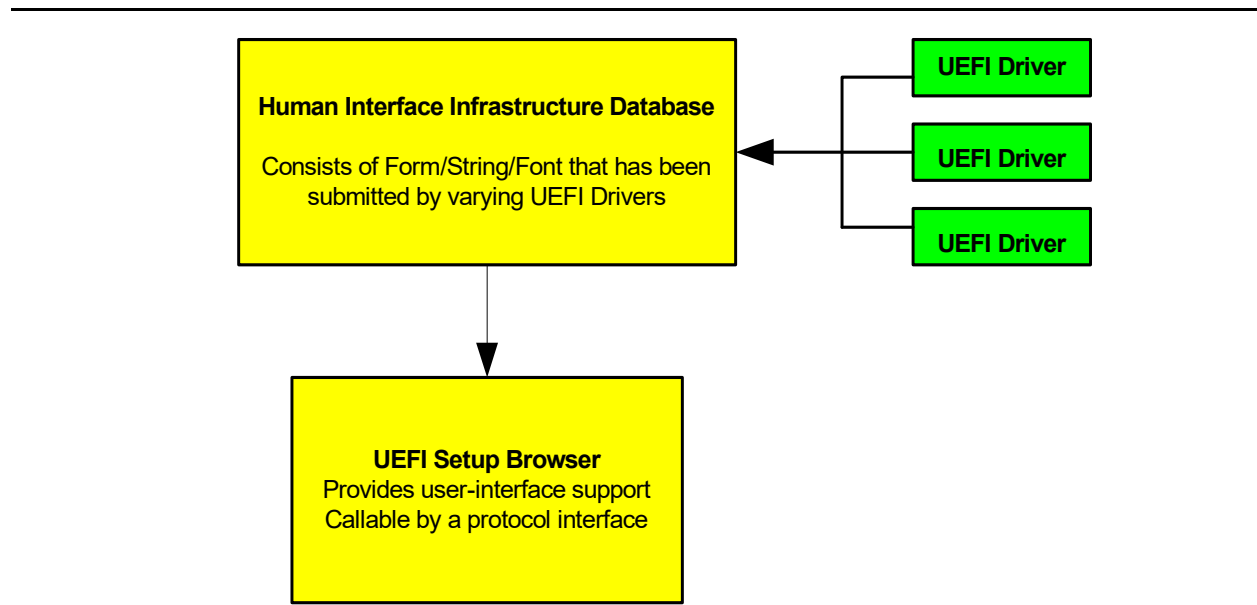

Figure 110. Setup Browser

### 32.2.10.1 User Interaction

The Forms Browser implementer has great flexibility as to the type of actual user interface provided. For example, while required to support some forms of navigation (see [EFI FORM BROWSER2 PROTOCOL.SendForm\(\)](#) or the cross-reference question), it may optionally support additional navigation capabilities, such as a back button or a menu bar. This section describes the rules to which the Forms Browser user-interaction must conform.

#### 32.2.10.1.1 Forms Browser details

The forms browser maintains a collection of one or more forms. The forms browser is required to provide navigation for these forms if there is more than one (see [Section 34.6](#), "Form Browser Protocol").

The forms browser maintains one or more *active forms*. An active form is any form where the forms browser is maintaining a set of question values. A form is considered active after all question values have been read from storage and the **EFI\_BROWSER\_ACTION\_FORM\_OPEN** action has been sent to all questions on the form which require callback. A form is considered inactive after all question values have been either discarded or written to storage and the **EFI\_BROWSER\_ACTION\_FORM\_CLOSE** action has been sent to all questions on the form which require callback.

The forms browser maintains a *selected* form. The selected form contains the selected question and indicates the primary area of user interaction.

The standards form navigation behaviors are:

### Navigate Forms.

When the user chooses this required behavior, a new form is selected and, if any questions on the form are selectable (see [Section 32.2.5.3.4](#)), a question is selected. Forms browsers are required to provide navigation to (at least) the first form in all form sets when FormId is zero (see [Section 34.6](#)). This behavior cannot be selected if the current form is modal (see [Section 32.2.5.2](#), "Forms").

### Exit Browser/Discard All.

When the user chooses this optional behavior, the question values for active forms are discarded, the active forms are deactivated and the forms browser exits with an action request of **EFI\_BROWSER\_ACTION\_REQUEST\_EXIT**. This behavior cannot be selected if the current form is modal (see [Section 32.2.5.2](#), "Forms").

### Exit Browser/Submit All.

When the user chooses optional behavior, the question values are written to storage, the active forms are deactivated and the forms browser exits with an action request of **EFI\_BROWSER\_ACTION\_REQUEST\_SUBMIT** or **EFI\_BROWSER\_ACTION\_REQUEST\_RESET**. This behavior cannot be selected if the current form is modal (see [Section 32.2.5.2](#), "Forms").

### Default.

When the user chooses this optional behavior, the current question values for the questions on the focus form are updated from one of the default stores and then the **EFI\_IFR\_BROWSER\_ACTION\_REQUEST\_DEFAULT\_x** action is sent for each of the questions with the Callback attribute. This behavior can be initiated by a Reset Button question (see section [Section 32.2.5.3.8](#)).

#### 32.2.10.1.2 Selected Form

When a form is made active, the forms browser sends the **EFI\_BROWSER\_ACTION\_FORM\_OPEN** for all questions supporting callback, retrieves the current question values, saves those as the original question values and begins refreshing any questions that support it.

The forms browser maintains a *current question value* for each question on active forms. The current question value is the last value that the forms browser read from storage/callback (see [Section 32.2.5.4.1](#), "Values") or the last value committed by the user. The form is considered *modified* if any of the current question values are modified (see Questions, below). The forms browser refreshes the current question values of at least questions on the selected with a non-zero refresh interval.

The forms browser maintains a *selected question* on the selected form. The selected question is the primary focus of the user's interaction. When a form is selected, the forms browser must choose a selectable question (see [Section 32.2.5.3.4](#), "Evaluation of Selectable Statements") as the selected question, if one is present on the form.

The standard active form behaviors are:

**Exit Browser/Discard All.**

When the user chooses this required behavior, the question values for active forms are discarded, the active forms are deactivated and the forms browser exits with an action request of **EFI\_BROWSER\_ACTION\_REQUEST\_EXIT**. This behavior can be initiated by the function associated with a question with the Callback attribute.

**Exit Browser/ Submit All.**

When the user chooses this required behavior, the current question values for active forms are validated (see nosubmitif, [Section 32.3.8.3.45](#)) and, if successful, question values for active forms are written to storage, the active forms are deactivated and the forms browser exits with an action request of **EFI\_BROWSER\_ACTION\_REQUEST\_SUBMIT**. This behavior can be initiated by the function associated with a question with the Callback attribute.

**Exit Browser/Discard All/Reset Platform.**

When the user chooses this required behavior, the question values for active forms are discarded, the active forms are deactivated and the form browser exits with an action request of **EFI\_BROWSER\_ACTION\_REQUEST\_RESET**. This behavior can be initiated by the function associated with a question with the Callback attribute.

**Exit Form/Submit Form.**

Apply Form. When the user chooses this required behavior, the question values for the selected form are validated (see ->nosubmitif, BUGBUG<-) and, if successful, question values for the selected form are written to storage and the selected form is deselected. This behavior can be initiated by the function associated with a question with the Callback attribute.

**Exit Form/Discard Form.**

When the user chooses this required behavior, the question values for the selected form are discarded and the selected form is deselected. This behavior can be initiated by the function associated with a question with the Callback attribute.

**Apply Form.**

When the user chooses this required behavior, the question values for the selected form are validated (see nosubmitif, BUGBUG) and, if successful, question values for the selected form are written to storage. This behavior can be initiated by the function associated with a question with the Callback attribute.

**Discard Form.**

When the user chooses this required behavior, the question values for the selected form are discarded. This behavior can be initiated by the function associated with a question with the Callback attribute.

**Default.**

When the user chooses this required behavior, the current question values for the questions on the selected form are updated from a default store. This behavior can be initiated by a Reset Button question (see [Section 32.2.5.3.8](#)).

### Navigate To Question.

When the user chooses this required behavior, the selected question is deselected and another question on the same form is selected. The types of navigation provided between questions on the same form are beyond the scope of this specification.

### Navigate To Form.

When the user chooses this required behavior, the selected form is deselected and the form specified by the question is selected. This behavior can be initiated by a Cross-Reference question. Note that this behavior is distinct from the Navigate Forms behavior described in Forms Navigation.

From these basic behaviors, more complex behaviors can be constructed. For example, a forms browser might check whether the form is modified and, if so, prompt the user to select between the Exit Browser/Discard All and Exit Browser/Submit All behaviors.

#### 32.2.10.1.3 Selected Question

When the user navigates to a question or the forms browser selects a form with a selectable question, the forms browser places the question in the *static* state. When the user is choosing another question values for the selected question (by typing or from a menu or other means), the forms browser places the question in the *changing* state. When the user finalizes selection of a question value the forms browser returns the question to the static state.

The forms browser refreshes all questions in at least the selected form with a non-zero refresh interval that are not *modified*. Typically, a forms browser will not update the displayed question value while the selected question is in the changing state, but will when the selected question is in the static state. A question is considered *modified* if there is storage associated with the question (i.e., a variable store was specified) and the current question value is different from the original question value.

The standard active question behaviors are:

#### Change

When the user chooses this required behavior, the forms browser places the selected question in the changing state and allows the user to specify a new current question value for the active question. For example, selecting items in a drop box or beginning to type a new value in an edit box.

With some question types and user interface styles, this behavior is hidden from the user. For example, with check boxes or radio buttons as found in most windowed user-interfaces, the user changes and commits the value with one action. Likewise, with action buttons, selecting the action button implies both the question value and the commit action.

This behavior corresponds to the CHANGING browser action request for questions that support callback.

### Commit

When the user chooses this required behavior, the forms browser validates the specified question value (see **EFI\_IPF\_INCONSISTENT\_IF**, [Section 32.3.8.3.33](#)) and, if successful, places the selected question in the static state and updates the current question value to that specified while in the *changing* state. If the selected question's current question value is different than the selected question's original question value, the selected question is considered *modified*. The form browser must then re-evaluate the modifiability, selectability and visibility of other questions in the selected form.

This behavior corresponds to the CHANGED browser action request for questions that support callback.

### Discard

When the user chooses this required behavior, the forms browser places the question in the changed state.

## 32.2.11 Configuration Settings

In order to save user changes to configuration settings after the system reset or power-off, there must be some form of non-volatile storage available. There are two types of non-volatile storage: system non-volatile storage or add-in card non-volatile storage. Both types are supported.

In general, settings are not saved to non-volatile storage until the user specifically directs the Forms Browser to do so. There are exceptions, such as when operating in a batch or script mode, setting a system password, and updating the system date and time. The underlying platform support dictates whether or not hardware configuration changes are committed immediately.

As shown in the figure below, when a system reset occurs, the firmware's initialization routines will launch the UEFI drivers (e.g. option ROMs). Drivers enabled to take direction from a non-volatile setting read the updated settings during their initialization.



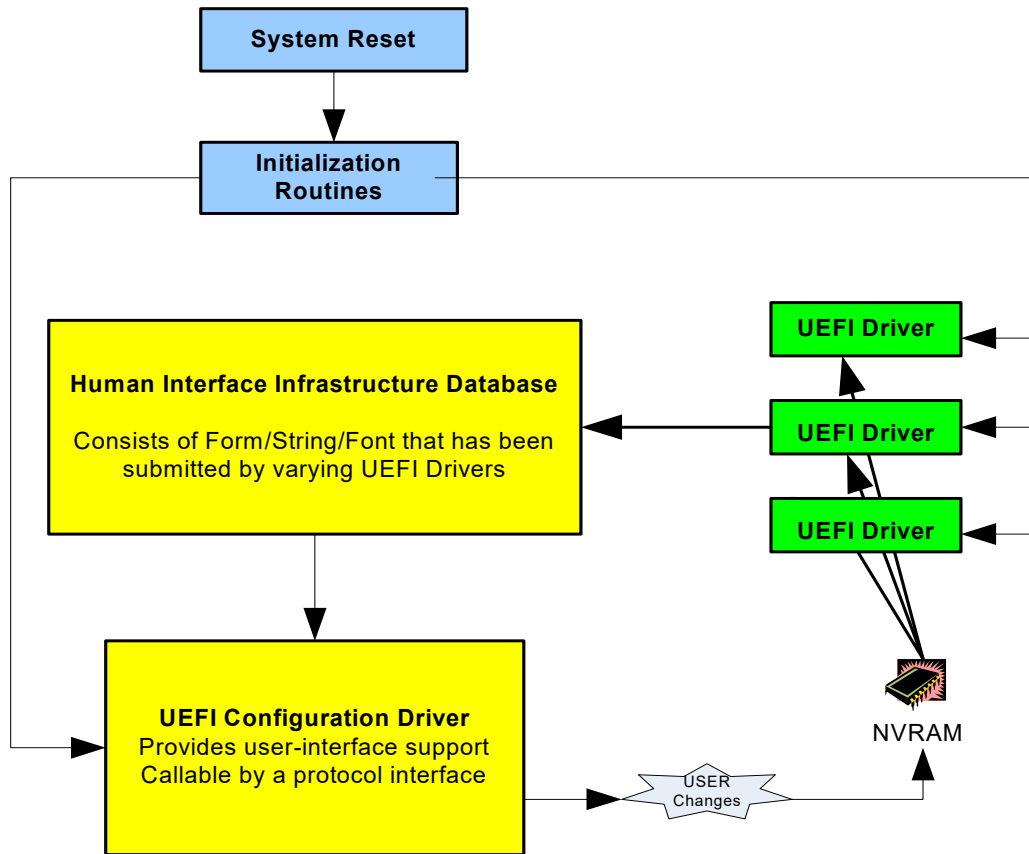

Figure 111. Storing Configuration Settings

### 32.2.11.1 OS Runtime Utilization

Due to the static nature of the data that is contained in the HII Database and the fact that certain classes of non-volatile storage can be updated during OS run-time, it is possible for an application running under an OS to read the HII information, make configuration changes and even make changes.

The figure below shows how an OS makes use of the HII database during runtime. In this case, the contents of the HII Database is exported to a buffer. The pointer to the buffer is placed in the EFI System Configuration Table, where it can be retrieved by an OS application.

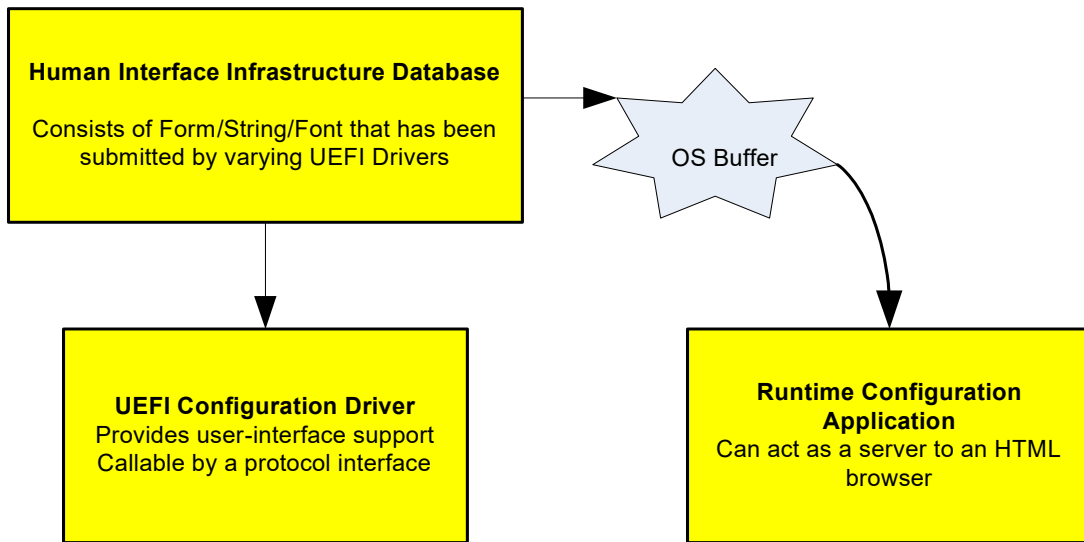

Figure 112. OS Runtime Utilization

The process used to allow an OS application to use this is as follows:

Drivers/applications in the system register user interface data into the HII Database

When the platform transitions from pre-boot to runtime phases of operation, the HII **ExportPackageLists()** is called to export the contents of the HII Database into a runtime buffer.

This runtime buffer is advertised in the UEFI Configuration Table using the HII Database Protocol's GUID so that an OS application can find the data.

The HII **ExportConfig()** is called to export the current configuration into a runtime buffer.

This runtime buffer is advertised in the UEFI Configuration Table using the HII Configuration Routing Protocol's GUID so that an OS application can find the data.

When an O/S application wants to display pre-boot configuration content, it searches the UEFI Configuration Table for the HII Database Protocol's GUID entry and renders the contents from the runtime buffer which it points to.

If the OS application needs to update the system configuration, the configuration information can be updated.

For those configuration settings which are stored in UEFI variables (i.e., using **GetVariable()** and **SetVariable()**), the application can update these using the abstraction provided by the operating system.

For those configuration settings which are not stored in UEFI variables, the OS application can use the UEFI UpdateCapsule runtime service to change the configuration.

### 32.2.11.2 Working with a UEFI Configuration Language

By defining the concept of a language that may provide hints to a consumer that the string payload may contain pre-defined standard keyword content, the user of this solution can export their configuration data for evaluation. This evaluation enables the consumer to determine if a particular platform supports a given configuration language, and in-turn be able to adjust known settings that are stored in a platform-specific manner. An example of this is illustrated below which uses various component described in this and the other HII chapters of this specification. In the example, a fictional technology called XYZ exists, and this particular platform supports it. The question is, how does a standard application which is not privy to the platform’s construction know how this setting is stored? To-date, this is not a reasonably solvable problem, but in the illustration below, this example shows how one might go about solving this issue.

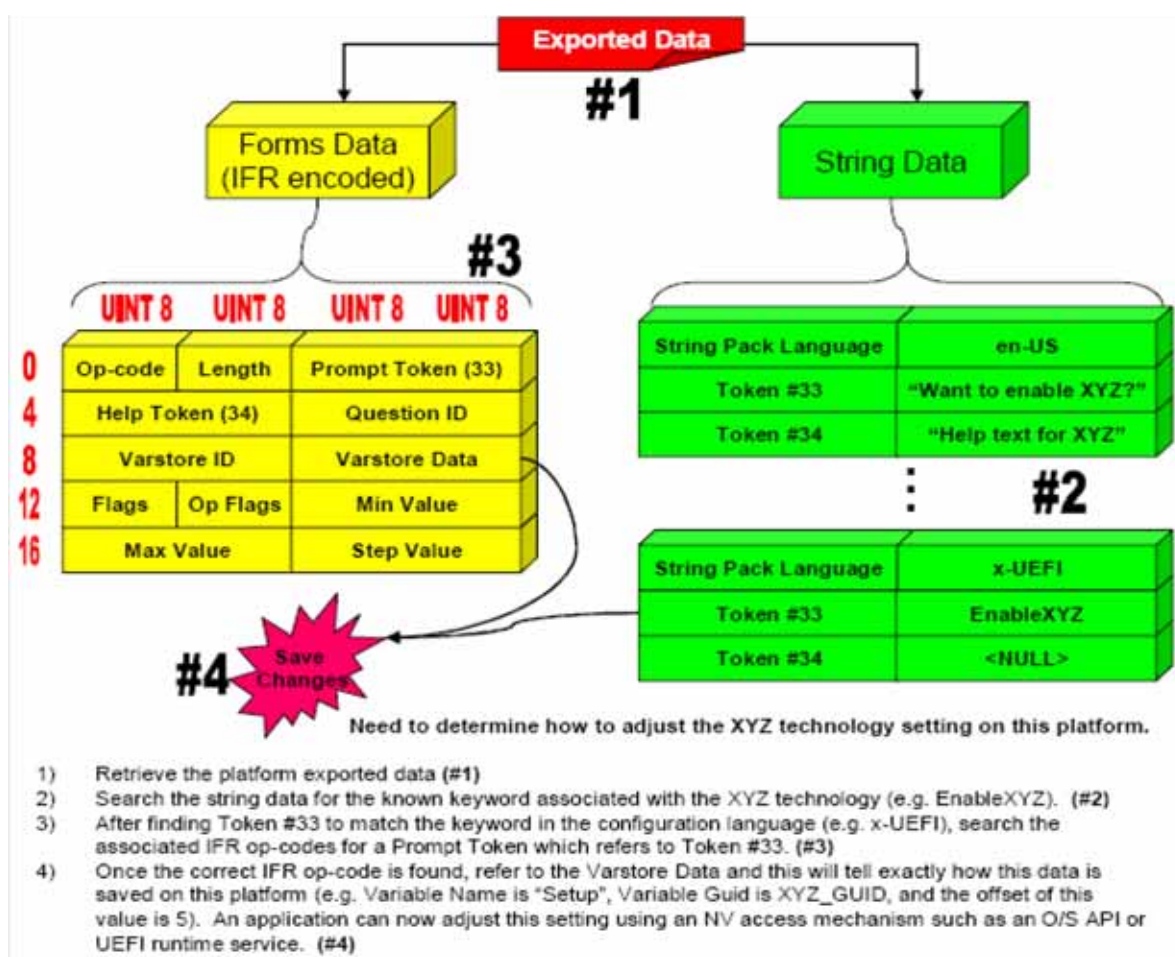
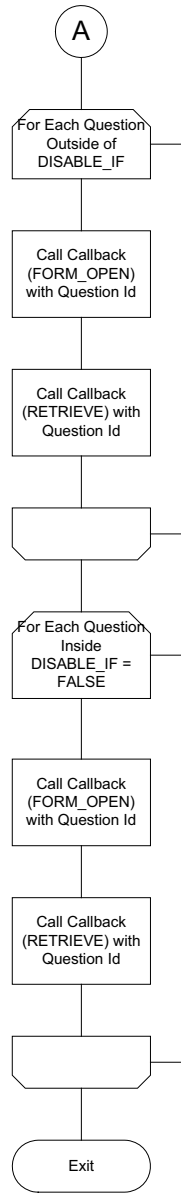

Figure 113. Standard Application Obtaining Setting Example

### 32.2.12 Form Callback Logic

Since it has been the design intent that the forms processor not need to understand the underlying hardware implementations or design paradigms of the platform, there were certain needs that could only be met by calling a more platform knowledgeable component. In this case, the component would typically be associated with some hardware device (e.g. motherboard, add-in card, etc.). To facilitate this interaction, some formal interfaces were declared for more platform-specific components to advertise and the forms processor could then call.

Note that the need for the forms processor to call into an alternate component driver should be limited as much as possible. The two primary reasons for this are the cases where off-line or O/S-present configuration is important. The three flow charts which follow describe the typical decisions that a forms processor would make with regards to handling processes which necessitate a callback.



CM13190

Figure 114. Typical Forms Processor Decisions Necessitating a Callback (1)

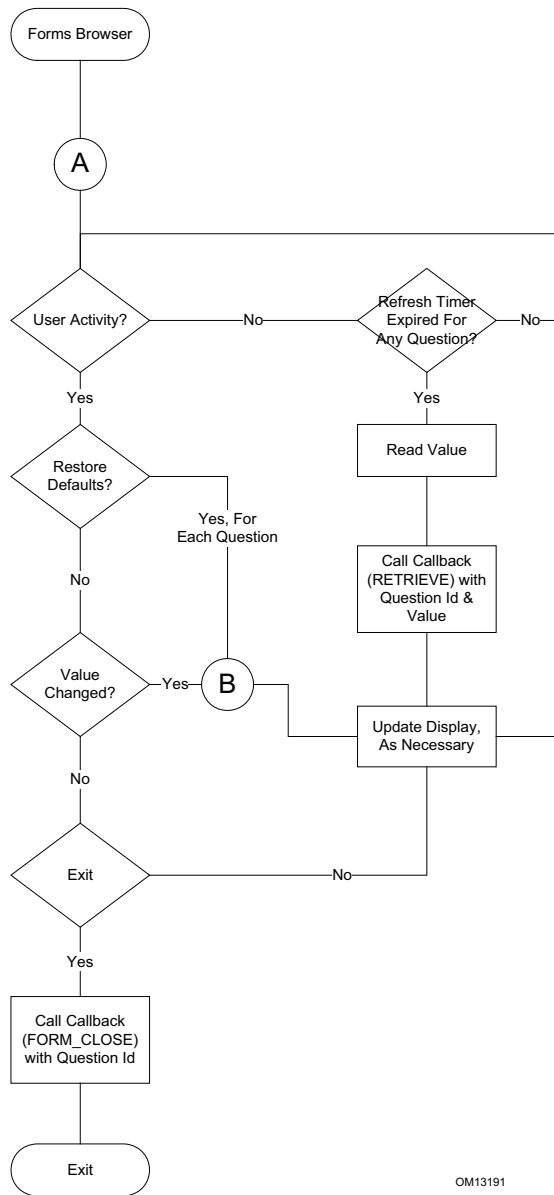

OM13191

Figure 115. Typical Forms Processor Decisions Necessitating a Callback (2)

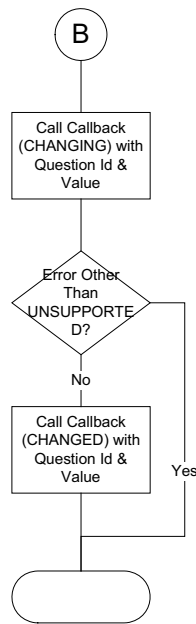

OM13192

Figure 116. Typical Forms Processor Decisions Necessitating a Callback (3)

### 32.2.13 Driver Model Interaction

The ability for a UEFI driver to interact with a target controller is abstracted through the Configuration Access Protocol. If a particular piece of hardware managed by a controller needs configuration services, it is the responsibility of that controller to provide this configuration abstraction for the given device. Regardless of whether a device driver or bus driver is abstracting the hardware configuration, the interaction with a configured device is identical.

Note that the ability for a driver to provide these access protocols might be done fairly early in the initialization process. Depending on the hardware capabilities, one might be advantaged in providing configuration access very early so that being able to determine a given device's current settings can be done without a full enumeration of certain bus devices. Also note that the same recommendations that are made in the DriverBinding sections should still be maintained. These cover the Supported, Started, and Stopped functions.

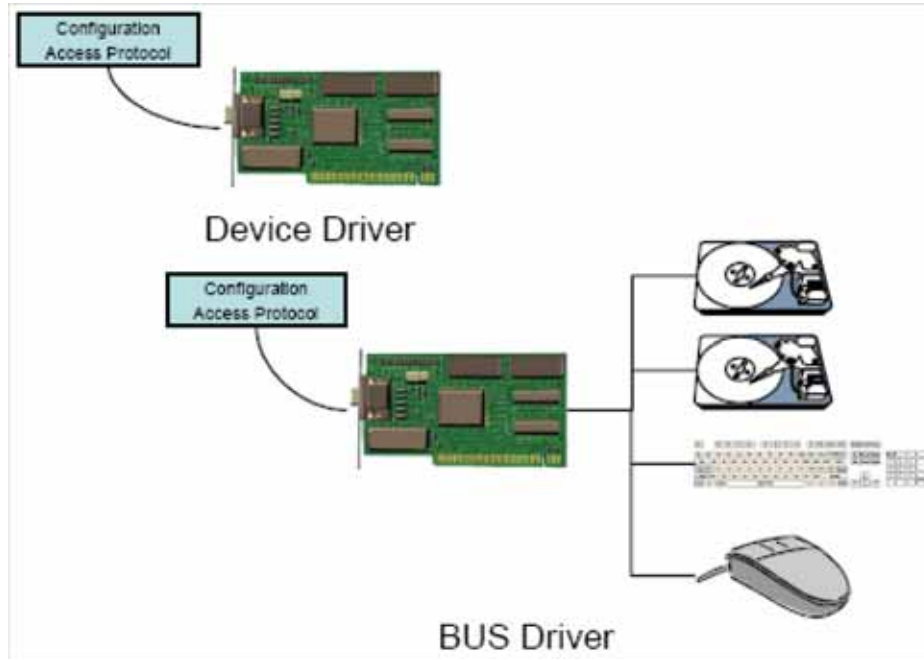

Figure 117. Driver Model Interactions

### 32.2.14 Human Interface Component Interactions

The figure below depicts the model used inside a common deployment of HII to manage human interface components.



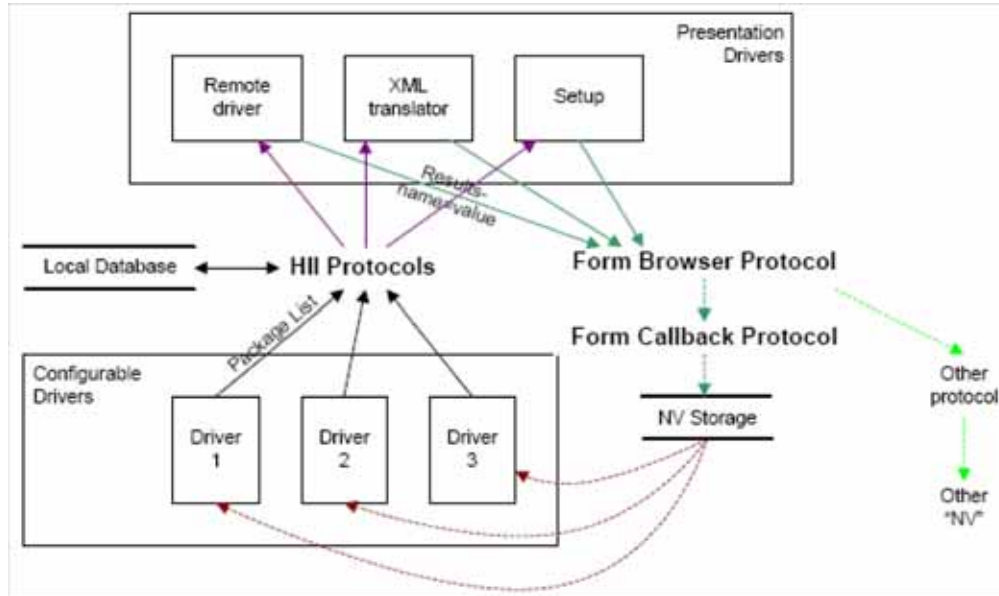

Figure 118. Managing Human Interface Components

### 32.2.15 Standards Map Forms

Configuration settings are configuration settings. But the way in which they are controlled is driven by different requirements. For example, the UEFI HII infrastructure focuses primarily on the way in which the configuration settings can be browsed and manipulated by a user. Other standards such as the DMTF Command-Line Protocol, focus on the way in which configuration settings can be manipulated via text commands.

Each *configuration method* tends to view the configuration settings a different way. In the end, they are changing the same configuration setting, but their means of exposing the control differs. The means by which a configuration method (HII, DMTF, WMI, SNMP, etc.) exposes an individual configuration setting is called a *question*.

In many cases, there is a one-to-one mapping between the questions exposed by these different configuration methods. That is, a question, as exposed by one configuration method matches the semantic meaning of the configuration setting exactly.

However, in other cases, there is not a one-to-one mapping. These cases break down into three broad categories:

1. Value Shift. In this case, the configuration setting has the same scope as the question exposed by a configuration method, but the values used to describe them are different. It may be as simple as 1=5, 2=6, 3=7, etc. or something more complicated, where "ON"=1 and "OFF"=0.
2. One-To-Many. In this case, the configuration setting maps to two or more questions exposed by a configuration method. For example the configuration setting might have the following enumerated values:
  - a 0 = Disable Serial Port

- b 1 = Enable Serial Port, I/O Port 0x3F8, IRQ 4
- c 2 = Enable Serial Port, I/O Port 0x2F8, IRQ 3
- d 3 = Enable Serial Port, I/O Port 0x3E8, IRQ 4
- e 4 = Enable Serial Port, I/O Port 0x2E8, IRQ 3

But in the configuration method, the serial port is controlled by three separate questions:

- Question #1: 0 = disable, 1 = enable
- Question #2: I/O Port (disabled if Question #1 = 0)
- Question #3: IRQ (disabled if Question #1 = 0)

Changing the configuration method question #1 to a value of 0 requires that the configuration setting be set to 0. In this case, there is the possibility of data loss. After changing the configuration setting to 0, the information about the I/O port and IRQ are not preserved.

So, in order to change the configuration setting to the value of 1 would require three of the configuration method's questions to change value: Question #1=1, Question #2=0x3F8, Question #3=IRQ 4.

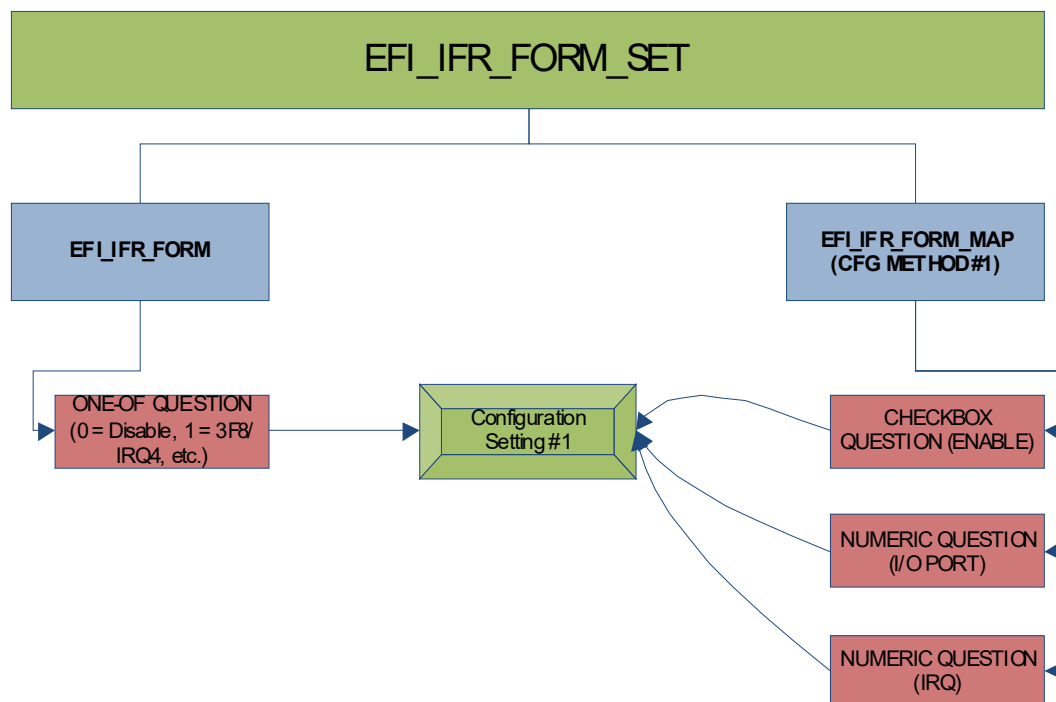

Figure 119. EFI IFR Form set configuration

3. Many-To-One. In this case, the conditions are reversed from the example described in #2 above. Now there are three configuration settings which map to a single configuration method question.

For example, the configuration settings are described using three separate questions:

- a Question #1: 0 = disable, 1 = enable

- b Question #2: I/O Port (disabled if Question #1 = 0)
- c Question #3: IRQ (disabled if Question #1 = 0)

But in the configuration method, the serial port is controlled by a single question with the following enumerated values:

- a 0 = Disable Serial Port
- b 1 = Enable Serial Port, I/O Port 0x3F8, IRQ 4
- c 2 = Enable Serial Port, I/O Port 0x2F8, IRQ 3
- d 3 = Enable Serial Port, I/O Port 0x3E8, IRQ 4
- e 4 = Enable Serial Port, I/O Port 0x2E8, IRQ 3

So, in order to change the configuration method to the value of 1 would require three configuration settings to change value: Question #1=1, Question #2=0x3F8, Question #3=IRQ 4.

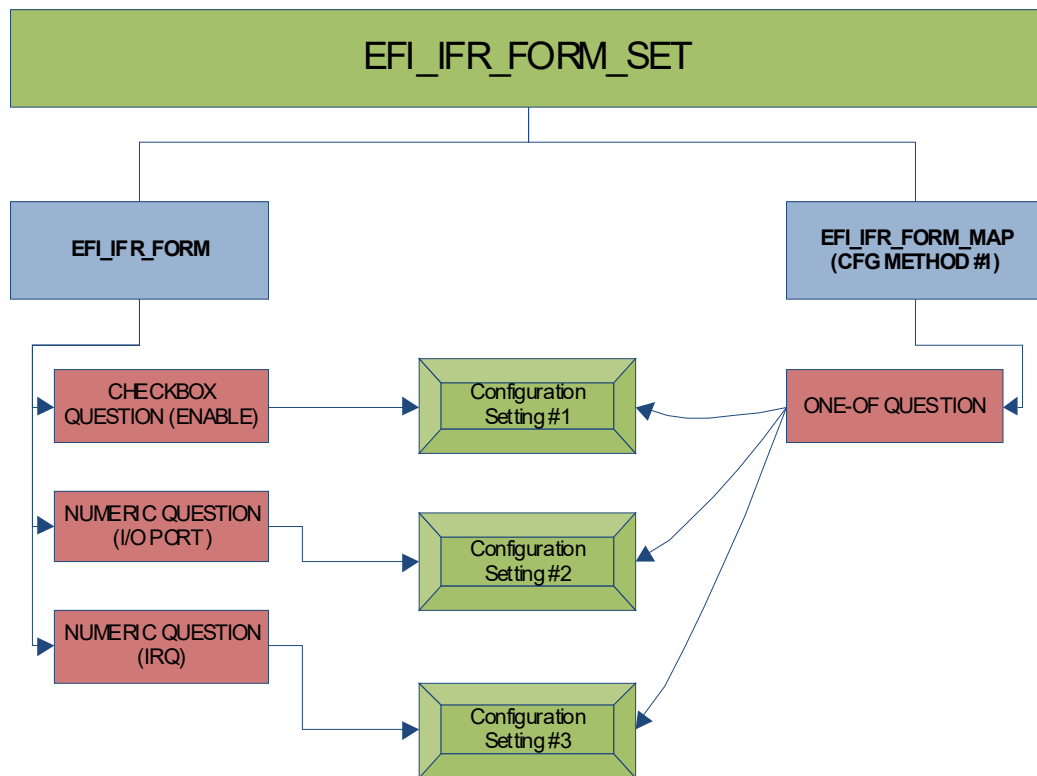

Figure 120. EFI IFR Form Set question changes

Some configuration settings may involve more than one of these mappings.

Standards map forms describe the questions exposed by these other configuration methods and how they map back to the configuration settings exposed by the UEFI drivers. Each standards map form describes the mapping for a single configuration method, along with that configuration method's name and version.

The questions within standards map forms are encoded using IFR in the same fashion as those within other UEFI forms. The prompt strings for these questions are tied back to the names for those questions within the configuration method (e.g., DMTF CLP).

### 32.2.15.1 Create A Question's Value By Combing Multiple Configuration Settings

Rather than reading directly from storage, these standards map questions retrieve their value using the **EFI\_IFR\_READ** ([Section 32.3.8.3.58](#)) operator. This operator can aggregate a value from more than one configuration settings using **EFI\_IFR\_GET** ([Section 32.3.8.3.27](#)). This operator can also change the type (integer, string, Boolean) of the value so that, say, a configuration setting with a type of integer can be represented in a standards map form as a string.

For example, to map a single question to three configuration settings (CS1, CS2 and CS3) as described in scenario #3 in [Section 32.2.1.5](#) above would have the following truth table:

**Table 211. Truth table: Mapping a single question to three configuration settings**

CS1	CS2	CS3	Q
<b>false</b>	X	X	0
<b>true</b>	0x3F8	4	1
<b>true</b>	0x2F8	3	2
<b>true</b>	0x3E8	4	3
<b>true</b>	0x2E8	3	4
<b>true</b>	any other value	any other value	<b>Undefined</b>

These become the following equations:

$x0: \text{Get}(\text{CS1}) ? x7 : 0$

$x1: ((\text{Get}(\text{CS2}) \& 0xF00) >> 8) == \text{Get}(\text{CS3}) + 1 ? x2 : \text{Undefined}$

$x2: \text{Map}(\text{Get}(\text{CS2}), 0x3f8, 1, 0x2F8, 2, 0x3E8, 3, 0x2E8, 4)$

### 32.2.15.2 Changing Multiple Configuration Settings From One Question's Value

Rather than writing directly to storage, these standards map questions change their value using the **EFI\_IFR\_WRITE** ([Section 32.3.8.3.94](#)) operator. This operator can, in turn, use the **EFI\_IFR\_SET** ([Section 32.3.8.3.66](#)) operator to change one or more configuration settings. This operator can also change the type (integer, string, Boolean, etc.) of the value written so that, say, a configuration setting with a type of integer can be represented in a standards map form as a string question.

For example, in example #2 above, the following table applies:

Table 212. Multiple configuration settings Example #2

CS1	CS2	CS3	Q
false	X	X	0
true	0x3F8	4	1
true	0x3E8	3	2
true	0x2F8	4	3
true	0x2E8	3	4

**Set**(CS1,Q != 0) &&

**Set**(CS2,Map(*this*,1,0x3F8,2,0x3E8,3,0x2F8,4,0x2E8)) &&

**Set**(CS3, Map(*this*,1,4,2,3,3,4,4,3))

### 32.2.15.3 Value Shifting

Value shifting is facilitated by the **EFI\_IFR\_MAP** ([Section 32.3.8.3.38](#)) operator. If this operator finds a value in a list, it replaces it with another value from the list, even if the other value is a different type.

For example, consider the following list of values

Table 213. Values:

1	PEI Module
2	DXE Boot Service Driver
3	DXE Runtime Driver
10	UEFI Boot Service Driver
11	UEFI Runtime Driver
12	UEFI Application

If the integer value 10 were supplied, the value “UEFI Boot Service Driver” would be returned. If the integer value 20 were supplied, Undefined would be returned.

### 32.2.15.4 Prompts

In standards map forms, the prompts can be used as the key words for the configuration method. They should be specified in the language *i-uefi* unless there are multiple translations available. Other standards may use the question identifiers as the means of identifying the standard question.

## 32.3 Code Definitions

This chapter describes the binary encoding of the different package types:

- Font Package
- Simplified Font Package

- String Package
- Image Package
- Device Path Package
- Keyboard Layout Package
- GUID Package
- Forms Package

### 32.3.1 Package Lists and Package Headers

#### EFI\_HII\_PACKAGE\_HEADER

##### Summary

The header found at the start of each package.

##### Prototype

```
typedef struct {
    UINT32 Length:24;
    UINT32 Type:8;
    UINT8 Data[ ... ];
} EFI_HII_PACKAGE_HEADER;
```

##### Members

<i>Length</i>	The size of the package in bytes.
<i>Type</i>	The package type. See <b>EFI_HII_PACKAGE_TYPE_x</b> , below.
<i>Data</i>	The package data, the format of which is determined by <i>Type</i> .

##### Description

Each package starts with a header, as defined above, which indicates the size and type of the package. When added to a pointer pointing to the start of the header, *Length* points at the next package. The package lists form a package list when concatenated together and terminated with an **EFI\_HII\_PACKAGE\_HEADER** with a *Type* of **EFI\_HII\_PACKAGE\_END**.

The type **EFI\_HII\_PACKAGE\_TYPE\_GUID** is used for vendor-defined HII packages, whose contents are determined by the *Guid*.

The range of package types starting with **EFI\_HII\_PACKAGE\_TYPE\_SYSTEM\_BEGIN** through **EFI\_HII\_PACKAGE\_TYPE\_SYSTEM\_END** are reserved for system firmware implementers.

## Related Definitions

```

#define EFI_HII_PACKAGE_TYPE_ALL    0x00
#define EFI_HII_PACKAGE_TYPE_GUID  0x01
#define EFI_HII_PACKAGE_FORMS      0x02
#define EFI_HII_PACKAGE_STRINGS    0x04
#define EFI_HII_PACKAGE_FONTS      0x05
#define EFI_HII_PACKAGE_IMAGES     0x06
#define EFI_HII_PACKAGE_SIMPLE_FONTS 0x07
#define EFI_HII_PACKAGE_DEVICE_PATH 0x08
#define EFI_HII_PACKAGE_KEYBOARD_LAYOUT 0x09
#define EFI_HII_PACKAGE_ANIMATIONS 0x0A
#define EFI_HII_PACKAGE_END        0xDF
#define EFI_HII_PACKAGE_TYPE_SYSTEM_BEGIN 0xE0
#define EFI_HII_PACKAGE_TYPE_SYSTEM_END  0xFF

```

Table 214. Package Types

Package Type	Description
EFI_HII_PACKAGE_TYPE_ALL	Pseudo-package type used when exporting package lists. See <b>ExportPackageList()</b> .
EFI_HII_PACKAGE_TYPE_GUID	Package type where the format of the data is specified using a GUID immediately following the package header.
EFI_HII_PACKAGE_FORMS	Forms package.
EFI_HII_PACKAGE_STRINGS	Strings package.
EFI_HII_PACKAGE_FONTS	Fonts package.
EFI_HII_PACKAGE_IMAGES	Images package.
EFI_HII_PACKAGE_SIMPLE_FONTS	Simplified (8x19, 16x19) Fonts package.
EFI_HII_PACKAGE_DEVICE_PATH	Binary-encoded device path.
EFI_HII_PACKAGE_END	Used to mark the end of a package list.
EFI_HII_PACKAGE_ANIMATIONS	Animations package.
EFI_HII_PACKAGE_TYPE_SYSTEM_BEGIN... EFI_HII_PACKAGE_TYPE_SYSTEM_END	Package types reserved for use by platform firmware implementations.

### 32.3.1.1 EFI\_HII\_PACKAGE\_LIST\_HEADER

#### Summary

The header found at the start of each package list.

## Prototype

```
typedef struct {
    EFI_GUID  PackageListGuid;
    UINT32    PackagLength;
} EFI_HII_PACKAGE_LIST_HEADER;
```

## Members

<i>PackageListGuid</i>	The unique identifier applied to the list of packages which follows.
<i>PackageLength</i>	The size of the package list (in bytes), including the header.

## Description

This header uniquely identifies the package list and is placed in front of a list of packages. Package lists with the same *PackageListGuid* value should contain the same data set. Updated versions should have updated GUIDs.

## 32.3.2 Simplified Font Package

The simplified font package describes the font glyphs for the standard 8x19 pixel (*narrow*) and 16x19 (*wide*) fonts. Other fonts should be described using the normal Font Package.

A simplified font package consists of a header and two types of glyph structures—standard-width (narrow) and wide glyphs.

### 32.3.2.1 EFI\_HII\_SIMPLE\_FONT\_PACKAGE\_HDR

## Summary

A simplified font package consists of a font header followed by a series of glyph structures.

## Prototype

```
typedef struct _EFI_HII_SIMPLE_FONT_PACKAGE_HDR {
    EFI_HII_PACKAGE_HEADER  Header;
    UINT16                  NumberOfNarrowGlyphs;
    UINT16                  NumberOfWideGlyphs;
    EFI_NARROW_GLYPH        NarrowGlyphs[];
    EFI_WIDE_GLYPH          WideGlyphs[];
} EFI_HII_SIMPLE_FONT_PACKAGE_HDR;
```

## Members

*Header*

The header contains a *Length* and *Type* field. In the case of a font package, the type will be **EFI\_HII\_PACKAGE\_SIMPLE\_FONTS** and the length will be



the total size of the font package including the size of the narrow and wide glyphs. See [EFI HII PACKAGE HEADER](#).

<i>NumberOfNarrowGlyphs</i>	The number of <i>NarrowGlyphs</i> that are included in the font package.
<i>NumberOfWideGlyphs</i>	The number of <i>WideGlyphs</i> that are included in the font package.
<i>NarrowGlyphs</i>	An array of <b>EFI_NARROW_GLYPH</b> entries. The number of entries is specified by <i>NumberOfNarrowGlyphs</i> .
<i>WideGlyphs</i>	An array of <b>EFI_WIDE_GLYPH</b> entries. The number of entries is specified by <i>NumberOfWideGlyphs</i> . To calculate the offset of <i>WideGlyphs</i> , use the offset of <i>NarrowGlyphs</i> and add the size of <b>EFI_NARROW_GLYPH</b> multiplied by the <i>NumberOfNarrowGlyphs</i> .

## Description

The glyphs must be sorted by Unicode character code.

It is up to developers who manage fonts to choose efficient mechanisms for accessing fonts. The contiguous presentation can easily be used because narrow and wide glyphs are not intermixed, so a binary search is possible (hence the requirement that the glyphs be sorted by weight).

### 32.3.2.2 EFI\_NARROW\_GLYPH

#### Summary

The **EFI\_NARROW\_GLYPH** has a preferred dimension (w x h) of 8 x 19 pixels.

#### Prototype

```
typedef struct {
    CHAR16 UnicodeWeight;
    UINT8 Attributes;
    UINT8 GlyphCol1[EFI_GLYPH_HEIGHT];
} EFI_NARROW_GLYPH;
```

#### Members

<i>UnicodeWeight</i>	The Unicode representation of the glyph. The term <i>weight</i> is the technical term for a character code.
<i>Attributes</i>	The data element containing the glyph definitions; see "Related Definitions" below.
<i>GlyphCol1</i>	The column major glyph representation of the character. Bits with values of one indicate that the corresponding pixel is to be on when normally displayed; those with zero are off.

## Description

Glyphs are represented by two structures, one each for the two sizes of glyphs. The narrow glyph (**EFI\_NARROW\_GLYPH**) is the normal glyph used for text display.

## Related Definitions

```
// Contents of EFI_NARROW_GLYPH.Attributes
#define EFI_GLYPH_NON_SPACING 0x01
#define EFI_GLYPH_WIDE 0x02
#define EFI_GLYPH_HEIGHT 19
#define EFI_GLYPH_WIDTH 8
```

Following is a description of the fields in the above definition:

EFI_GLYPH_NON_SPACING	This symbol is to be printed "on top of" ( <b>OR</b> 'd with) the previous glyph before display.
EFI_GLYPH_WIDE	This symbol uses 16x19 formats rather than 8x19.

### 32.3.2.3 EFI\_WIDE\_GLYPH

#### Summary

The **EFI\_WIDE\_GLYPH** has a preferred dimension (w x h) of 16 x 19 pixels, which is large enough to accommodate logographic characters.

#### Prototype

```
typedef struct {
    CHAR16 UnicodeWeight;
    UINT8 Attributes;
    UINT8 GlyphCol1[EFI_GLYPH_HEIGHT];
    UINT8 GlyphCol2[EFI_GLYPH_HEIGHT];
    UINT8 Pad[3];
} EFI_WIDE_GLYPH;
```

#### Members

<i>UnicodeWeight</i>	The Unicode representation of the glyph. The term <i>weight</i> is the technical term for a character code.
<i>Attributes</i>	The data element containing the glyph definitions; see "Related Definitions" in <b>EFI_NARROW_GLYPH</b> for attribute values.
<i>GlyphCol1</i> and <i>GlyphCol2</i>	The column major glyph representation of the character. Bits with values of one indicate that the corresponding pixel is to be on when normally displayed; those with zero are off.
<i>Pad</i>	Ensures that <b>sizeof (EFI_WIDE_GLYPH)</b> is twice the <b>sizeof (EFI_NARROW_GLYPH)</b> . The contents of <i>Pad</i> must be zero.

## Description

Glyphs are represented via the two structures, one each for the two sizes of glyphs. The wide glyph (**EFI\_WIDE\_GLYPH**) is large enough to display logographic characters.

### 32.3.3 Font Package

The font package describes the glyphs for a single font with a single family, size and style. The package has two parts: a fixed header and the glyph blocks. All structures described here are byte packed.

#### 32.3.3.1 Fixed Header

The fixed header consists of a standard record header and then the character values in this section, the flags (including the encoding method) and the offsets of the glyph information, the glyph bitmaps and the character map.

```
typedef struct _EFI_HII_FONT_PACKAGE_HDR {
  EFI_HII_PACKAGE_HEADER Header;
  UINT32    HdrSize;
  UINT32    GlyphBlockOffset;
  EFI_HII_GLYPH_INFO Cell;
  EFI_HII_FONT_STYLE FontStyle;
  CHAR16    FontFamily[];
} EFI_HII_FONT_PACKAGE_HDR;
```

<i>Header</i>	The standard package header, where <i>Header.Type</i> = <b>EFI_HII_PACKAGE_FONTS</b> .
<i>HdrSize</i>	Size of this header.
<i>GlyphBlockOffset</i>	The offset, relative to the start of this header, of a series of variable-length glyph blocks, each describing information about the bitmap associated with a glyph.
<i>Cell</i>	This contains the measurement of the widest and tallest characters in the font ( <i>Cell.Width</i> and <i>Cell.Height</i> ). It also contains the default offset to the horizontal and vertical origin point of the character cell ( <i>Cell.OffsetX</i> and <i>Cell.OffsetY</i> ). Finally, it contains the default <i>AdvanceX</i> .
<i>FontStyle</i>	The design style of the font, 1 bit per style. See <b>EFI_HII_FONT_STYLE</b> .
<i>FontFamily</i>	The null-terminated string with the name of the font family to which the font belongs.

## Related Definitions

```

typedef UINT32 EFI_HII_FONT_STYLE;
#define EFI_HII_FONT_STYLE_NORMAL  0x00000000
#define EFI_HII_FONT_STYLE_BOLD    0x00000001
#define EFI_HII_FONT_STYLE_ITALIC  0x00000002
#define EFI_HII_FONT_STYLE_EMBOSS  0x00010000
#define EFI_HII_FONT_STYLE_OUTLINE  0x00020000
#define EFI_HII_FONT_STYLE_SHADOW   0x00040000
#define EFI_HII_FONT_STYLE_UNDERLINE 0x00080000
#define EFI_HII_FONT_STYLE_DBL_UNDER 0x00100000

```

### 32.3.3.2 Glyph Information

For each Unicode character code, the glyph information gives the glyph bitmap, the character size and the position of the bitmap relative to the origin of the character cell. The glyph information is encoded as a series of blocks, each with a single byte header. The blocks must be processed in order.

Each block begins with a single byte, which contains the block type.

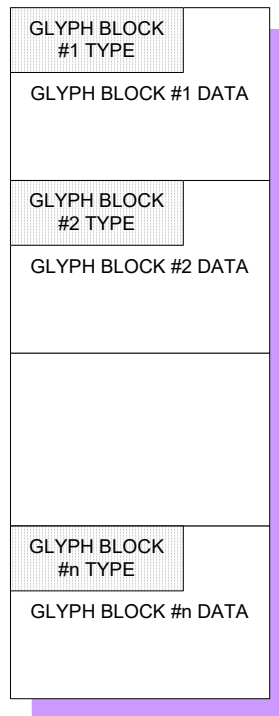

Figure 121. Glyph Information Encoded in Blocks

## Prototype

```
typedef struct _EFI_HII_GLYPH_BLOCK {
    UINT8 BlockType;
    UINT8 BlockBody[];
} EFI_HII_GLYPH_BLOCK;
```

## Members

The following table describes the different block types:

Name	Value	Description
EFI_HII_GIBT_END	0x00	The end of the glyph information.
EFI_HII_GIBT_GLYPH	0x10	Glyph information for a single character value, bit-packed.
EFI_HII_GIBT_GLYPHS	0x11	Glyph information for multiple character values.
EFI_HII_GIBT_GLYPH_DEFAULT	0x12	Glyph information for a single character value, using the default character cell information.
EFI_HII_GIBT_GLYPHS_DEFAULT	0x13	Glyph information for multiple character values, using the default character cell information.
EFI_HII_GIBT_GLYPH_VARIABILITY	0x14	Glyph information for the variable glyph.
EFI_HII_GIBT_DUPLICATE	0x20	Create a duplicate of an existing glyph but with a new character value.
EFI_HII_GIBT_SKIP2	0x21	Skip a number (1-65535) character values.
EFI_HII_GIBT_SKIP1	0x22	Skip a number (1-255) character values.
EFI_HII_GIBT_DEFAULTS	0x23	Set default glyph information for subsequent glyph blocks.
EFI_HII_GIBT_EXT1	0x30	For future expansion (one byte length field)
EFI_HII_GIBT_EXT2	0x31	For future expansion (two byte length field)
EFI_HII_GIBT_EXT4	0x32	For future expansion (four byte length field)

## Description

In order to recreate all glyphs, start at the first block and process them all until a **EFI\_HII\_GIBT\_END** block is found. When processing the glyph blocks, each block refers to the current character value (*CharValueCurrent*), which is initially set to one (1).

Glyph blocks of an unknown type should be skipped. If they cannot be skipped, then processing halts.

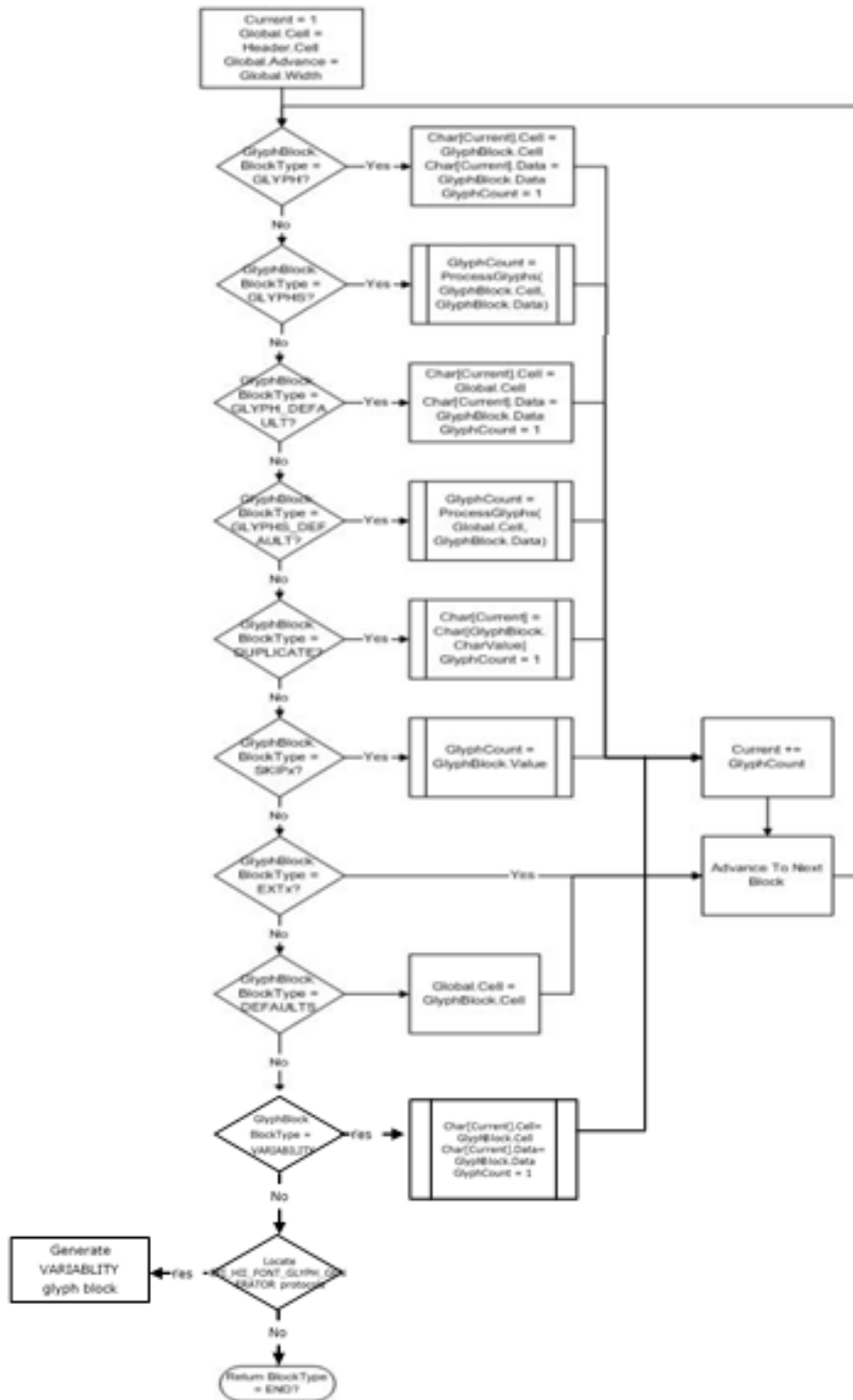

Figure 122. Glyph Block Processing

## Related Definitions

```
typedef struct _EFI_HII_GLYPH_INFO {
    UINT16 Width;
    UINT16 Height;
    INT16 OffsetX;
    INT16 OffsetY;
    INT16 AdvanceX;
} EFI_HII_GLYPH_INFO;
```

<i>Width</i>	Width of the character or character cell, in pixels. For fixed-pitch fonts, this is the same as the advance.
<i>Height</i>	Height of the character or character cell, in pixels.
<i>OffsetX</i>	Offset to the horizontal edge of the character cell.
<i>OffsetY</i>	Offset to the vertical edge of the character cell.
<i>AdvanceX</i>	Number of pixels to advance to the right when moving from the <i>origin</i> of the current glyph to the origin of the next glyph.

### 32.3.3.2.1 EFI\_HII\_GIBT\_DEFAULTS

#### Summary

Changes the default character cell information.

#### Prototype

```
typedef struct _EFI_HII_GIBT_DEFAULTS_BLOCK {
    EFI_HII_GLYPH_BLOCK Header;
    EFI_HII_GLYPH_INFO Cell;
} EFI_HII_GIBT_DEFAULTS_BLOCK;
```

#### Members

##### *Header*

Standard glyph block header, where *Header.BlockType* = **EFI\_HII\_GIBT\_DEFAULTS**.

##### *Cell*

The new default cell information which will be applied to all subsequent **GLYPH\_DEFAULT** and **GLYPHS\_DEFAULT** blocks.

#### Description

Changes the default cell information used for subsequent **EFI\_HII\_GIBT\_GLYPH\_DEFAULT** and **EFI\_HII\_GIBT\_GLYPHS\_DEFAULT** glyph blocks. The cell information described by *Cell* remains in effect until the next **EFI\_HII\_GIBT\_DEFAULTS** is found. Prior to the first **EFI\_HII\_GIBT\_DEFAULTS** block, the cell information in the fixed header are used.

### 32.3.3.2.2 EFI\_HII\_GIBT\_DUPLICATE

#### Summary

Assigns a new character value to a previously defined glyph.

#### Prototype

```
typedef struct _EFI_HII_GIBT_DUPLICATE_BLOCK {
    EFI_HII_GLYPH_BLOCK Header;
    CHAR16 CharValue;
} EFI_HII_GIBT_DUPLICATE_BLOCK;
```

#### Members

*Header*

Standard glyph block header, where *Header.BlockType* = **EFI\_HII\_GIBT\_DUPLICATE**.

*CharValue*

The previously defined character value with the exact same glyph.

#### Description

Indicates that the glyph with character value *CharValueCurrent* has the same glyph as a previously defined character value and increments *CharValueCurrent* by one.

### 32.3.3.2.3 EFI\_HII\_GIBT\_END

#### Summary

Marks the end of the glyph information.

#### Prototype

```
typedef struct _EFI_GLYPH_GIBT_END_BLOCK {
    EFI_HII_GLYPH_BLOCK Header;
} EFI_GLYPH_GIBT_END_BLOCK;
```

#### Members

*Header*

Standard glyph block header, where *Header.BlockType* = **EFI\_HII\_GIBT\_END**.

#### Description

Any glyphs with a character value greater than or equal to *CharValueCurrent* are empty.

### 32.3.3.2.4 EFI\_HII\_GIBT\_EXT1, EFI\_HII\_GIBT\_EXT2, EFI\_HII\_GIBT\_EXT4

#### Summary

Future expansion block types which have a length byte.



## Prototype

```
typedef struct _EFI_HII_GIBT_EXT1_BLOCK {
  EFI_HII_GLYPH_BLOCK Header;
  UINT8   BlockType2;
  UINT8   Length;
} EFI_HII_GIBT_EXT1_BLOCK;
```

```
typedef struct _EFI_HII_GIBT_EXT2_BLOCK {
  EFI_HII_GLYPH_BLOCK Header;
  UINT8   BlockType2;
  UINT16  Length;
} EFI_HII_GIBT_EXT2_BLOCK;
```

```
typedef struct _EFI_HII_GIBT_EXT4_BLOCK {
  EFI_HII_GLYPH_BLOCK Header;
  UINT8   BlockType2;
  UINT32  Length;
} EFI_HII_GIBT_EXT4_BLOCK;
```

## Members

*Header*

Standard glyph block header, where *Header.BlockType* = **EFI\_HII\_GIBT\_EXT1**, **EFI\_HII\_GIBT\_EXT2** or **EFI\_HII\_GIBT\_EXT4**.

*Length*

Size of the glyph block, in bytes.

*BlockType2*

Indicates the type of extended block. Currently all extended block types are reserved for future expansion.

## Description

These are reserved for future expansion, with length bytes included so that they can be easily skipped.

### 32.3.3.2.5 EFI\_HII\_GIBT\_GLYPH

## Summary

Provide the bitmap for a single glyph.

## Prototype

```
typedef struct _EFI_HII_GIBT_GLYPH_BLOCK {
  EFI_HII_GLYPH_BLOCK Header;
  EFI_HII_GLYPH_INFO Cell;
  UINT8 BitmapData[1];
} EFI_HII_GIBT_GLYPH_BLOCK;
```

## Members

### *Header*

Standard glyph block header, where *Header.BlockType* = **EFI\_HII\_GIBT\_GLYPH**.

### *Cell*

Contains the width and height of the encoded bitmap (*Cell.Width* and *Cell.Height*), the number of pixels (signed) right of the character cell origin where the left edge of the bitmap should be placed (*Cell.OffsetX*), the number of pixels above the character cell origin where the top edge of the bitmap should be placed (*Cell.OffsetY*) and the number of pixels (signed) to move right to find the origin for the next character cell (*Cell.AdvanceX*).

### *GlyphCount*

The number of glyph bitmaps.

### *BitmapData*

The bitmap data specifies a series of pixels, one bit per pixel, *left-to-right, top-to-bottom*. Each glyph bitmap only encodes the portion of the bitmap enclosed by its character-bounding box, but the entire glyph is padded out to the nearest byte. The number of bytes per bitmap can be calculated as:  $((Cell.Width + 7)/8) * Cell.Height$ .

## Description

This block provides the bitmap for the character with the value *CharValueCurrent* and increments *CharValueCurrent* by one. Each glyph contains a glyph width and height, a drawing offset, number of pixels to advance after drawing and then the encoded bitmap.

### 32.3.3.2.6 EFI\_HII\_GIBT\_GLYPHS

## Summary

Provide the bitmaps for multiple glyphs with the same cell information

## Prototype

```
typedef struct _EFI_HII_GIBT_GLYPHS_BLOCK {
  EFI_HII_GLYPH_BLOCK Header;
  EFI_HII_GLYPH_INFO Cell;
  UINT16 Count;
  UINT8 BitmapData[1];
} EFI_HII_GIBT_GLYPHS_BLOCK;
```

## Members

### *Header*

Standard glyph block header, where *Header.BlockType* = **EFI\_HII\_GIBT\_GLYPHS**.

### *Cell*

Contains the width and height of the encoded bitmap (*Cell.Width* and *Cell.Height*), the number of pixels (signed) right of the character cell origin where the left edge of the bitmap should be placed (*Cell.OffsetX*), the number of pixels above the character cell origin where the top edge of the bitmap should be placed (*Cell.OffsetY*) and the number of pixels (signed) to move right to find the origin for the next character cell (*Cell.AdvanceX*).

### *BitmapData*

The bitmap data specifies a series of pixels, one bit per pixel, *left-to-right*, *top-to-bottom*, for each glyph. Each glyph bitmap only encodes the portion of the bitmap enclosed by its character-bounding box. The number of bytes per bitmap can be calculated as:  $((Cell.Width + 7)/8) * Cell.Height$ .

## Description

Provides the bitmaps for the characters with the values *CharValueCurrent* through *CharValueCurrent* + *Count* - 1 and increments *CharValueCurrent* by *Count*. These glyphs have identical cell information and the encoded bitmaps are exactly the same number of bytes.

### 32.3.3.2.7 EFI\_HII\_GIBT\_GLYPH\_DEFAULT

## Summary

Provide the bitmap for a single glyph, using the default cell information.

## Prototype

```
typedef struct _EFI_HII_GIBT_GLYPH_DEFAULT_BLOCK {
    EFI_HII_GLYPH_BLOCK Header;
    UINT8    BitmapData[];
} EFI_HII_GIBT_GLYPH_DEFAULT_BLOCK;
```

## Members

### *Header*

Standard glyph block header, where *Header.BlockType* = **EFI\_HII\_GIBT\_GLYPH\_DEFAULT**.

### *BitmapData*

The bitmap data specifies a series of pixels, one bit per pixel, *left-to-right, top-to-bottom*. Each glyph bitmap only encodes the portion of the bitmap enclosed by its character-bounding box. The number of bytes per bitmap can be calculated as:  $((Global.Cell.Width + 7)/8) * Global.Cell.Height$ .

## Description

Provides the bitmap for the character with the value *CharValueCurrent* and increments *CharValueCurrent* by 1. This glyph uses the default cell information. The default cell information is found in the font header or the most recently processed **EFI\_HII\_GIBT\_DEFAULTS**.

### 32.3.3.2.8 EFI\_HII\_GIBT\_GLYPHS\_DEFAULT

## Summary

Provide the bitmaps for multiple glyphs with the default cell information

## Prototype

```
typedef struct _EFI_HII_GIBT_GLYPHS_DEFAULT_BLOCK {
    EFI_HII_GLYPH_BLOCK Header;
    UINT16    Count;
    UINT8    BitmapData[];
} EFI_HII_GIBT_GLYPHS_DEFAULT_BLOCK;
```

## Members

### *Header*

Standard glyph block header, where *Header.BlockType* = **EFI\_HII\_GIBT\_GLYPHS\_DEFAULT**.

### *Count*

Number of glyphs in the glyph block.

### *BitmapData*

The bitmap data specifies a series of pixels, one bit per pixel, *left-to-right, top-to-bottom*, for each glyph. Each glyph bitmap only encodes the portion of the bitmap enclosed by its character-bounding box. The number of bytes

per bitmap can be calculated as:  $((Global.Cell.Width + 7)/8) * Global.Cell.Height$ .

## Description

Provides the bitmaps for the characters with the values *CharValueCurrent* through *CharValueCurrent + Count - 1* and increments *CharValueCurrent* by *Count*. These glyphs use the default cell information and the encoded bitmaps have exactly the same number of bytes.

### 32.3.3.2.9 EFI\_HII\_GIBT\_SKIPx

## Summary

Increments the current character value *CharValueCurrent* by the number specified.

## Prototype

```
typedef struct _EFI_HII_GIBT_SKIP2_BLOCK {
  EFI_HII_GLYPH_BLOCK Header;
  UINT16 SkipCount;
} EFI_HII_GIBT_SKIP2_BLOCK;
```

```
typedef struct _EFI_HII_GIBT_SKIP1_BLOCK {
  EFI_HII_GLYPH_BLOCK Header;
  UINT8 SkipCount;
} EFI_HII_GIBT_SKIP1_BLOCK;
```

## Members

*Header*

Standard glyph block header, where *BlockType* = **EFI\_HII\_GIBT\_SKIP1** or **EFI\_HII\_GIBT\_SKIP2**.

*SkipCount*

The unsigned 8- or 16-bit value to add to *CharValueCurrent*.

## Description

Increments the current character value *CharValueCurrent* by the number specified.

### 32.3.3.2.10 EFI\_HII\_GIBT\_GLYPH\_VARIABILITY

## Related Definitions

```
//*****
// EFI_HII_GIBT_GLYPH_VARIABILITY (0x14)
//*****
typedef struct _EFI_HII_GIBT_VARIABILITY_BLOCK {
  EFI_HII_GLYPH_BLOCK Header;
```

```

EFI_HII_GLYPH_INFO Cell;
UINT8                GlyphPackInBits;
UINT8                BitmapData [1];
} EFI_HII_GIBT_VARIABILITY_BLOCK;

```

## Member

<i>Header</i>	Standard glyph block header, where <i>Blocktype</i> = <a href="#">EFI_HII_GIBT_GLYPH_VARIABILITY</a> .
<i>Cell</i>	Contains the width and height of the encoded bitmap ( <i>Cell.Width</i> and <i>Cell.Height</i> ), the number of pixels (signed) right of the character cell origin where the left edge of the bitmap should be placed ( <i>Cell.OffsetX</i> ), the number of pixels above the character cell origin where the top edge of the bitmap should be placed ( <i>Cell.OffsetY</i> ) and the number of pixels (signed) to move right to find the origin for the next character cell ( <i>Cell.AdvanceX</i> ).
<i>GlyphPackInBits</i>	This describes the bit length for each pixel in glyph. With this, the length of <i>BitmapData</i> can be determined according to <i>GlyphPackInBits</i> , <i>cell.with</i> and <i>cell.height</i> . The valid value is <a href="#">GIBT_VARIABILITY_BLOCK_1_BIT</a> , <a href="#">GIBT_VARIABILITY_BLOCK_2_BIT</a> , <a href="#">GIBT_VARIABILITY_BLOCK_4_BIT</a> , <a href="#">GIBT_VARIABILITY_BLOCK_8_BIT</a> , <a href="#">GIBT_VARIABILITY_BLOCK_16_BIT</a> , <a href="#">GIBT_VARIABILITY_BLOCK_24_BIT</a> , <a href="#">GIBT_VARIABILTY_BLOCK_32_BIT</a> HII Font Ex protocol has no idea about how to decode the bitmap of glyph if the glyph is declared as <a href="#">EFI_HII_GIBT_GLYPH_VARIABLITY</a> . The bitmap decoding is resolved in <a href="#">EFI_HII_FONT_GLPHY_GENERATOR_PROTOCOL</a> . This field is used to determine the length of entire glyph block.
<i>BitmapData</i>	The raw data of the glyph pixels. The format of the glyph pixel depends on the glyph generator. Only <a href="#">EFI_HII_FONT_GLYPH_GENERATOR_PROTOCOL</a> knows how to draw the glyph.

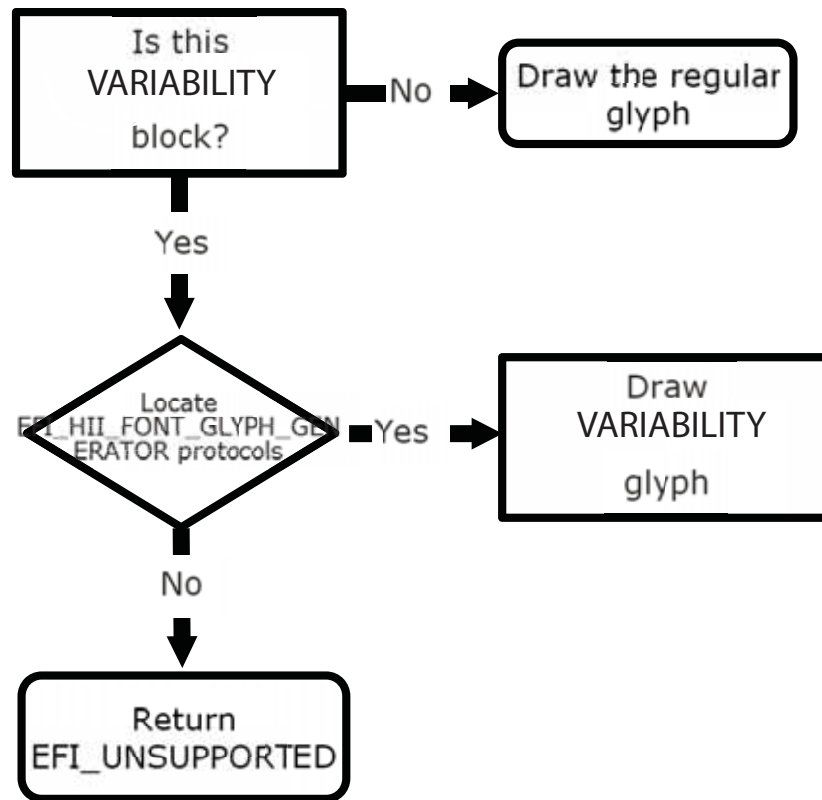

Figure 123. EFI\_HII\_GIBT\_GLYPH\_VARIABILITY Glyph Drawing Processing

### 32.3.4 Device Path Package

#### Summary

The device path package is used to carry a device path associated with the package list.

#### Prototype

```

typedef struct _EFI_HII_DEVICE_PATH_PACKAGE {
  EFI_HII_PACKAGE_HEADER           Header;
  //EFI_DEVICE_PATH_PROTOCOL       DevicePath[];
} EFI_HII_DEVICE_PATH_PACKAGE;
  
```

#### Parameters

*Header*

The standard package header, where *Header.Type* = **EFI\_HII\_PACKAGE\_DEVICE\_PATH**.

*DevicePath*

The Device Path description associated with the driver handle that provided the content sent to the HII database.

## Description

This package is created by `NewPackageList()` when the package list is first added to the HII database by locating the `EFI_DEVICE_PATH_PROTOCOL` attached to the driver handle passed in to that function.

### 32.3.5 GUID Package

The GUID package is used to carry data where the format is defined by a GUID.

#### Prototype

```
typedef struct _EFI_HII_GUID_PACKAGE_HDR {
    EFI_HII_PACKAGE_HEADER Header;
    EFI_GUID Guid;
    // Data per GUID definition may follow
} EFI_HII_GUID_PACKAGE_HDR;
```

#### Members

*Header*

The standard package header, where *Header.Type* = `EFI_HII_PACKAGE_TYPE_GUID`.

*Guid*

Identifier which describes the remaining data within the package.

#### Description

This is a free-form package type designed to allow extensibility by allowing the format to be specified using *Guid*.

### 32.3.6 String Package

The Strings package record describes the mapping between string identifiers and the actual text of the strings themselves. The package consists of three parts: a fixed header, the string information and the font information.

#### 32.3.6.1 Fixed Header

The fixed header consists of a standard record header and then the string identifiers contained in this section and the offsets of the string and language information.



## Prototype

```
typedef struct _EFI_HII_STRING_PACKAGE_HDR {
  EFI_HII_PACKAGE_HEADER Header;
  UINT32 HdrSize;
  UINT32 StringInfoOffset;
  CHAR16 LanguageWindow[16];
  EFI_STRING_ID LanguageName;
  CHAR8 Language[ ... ];
} EFI_HII_STRING_PACKAGE_HDR;
```

## Members

### *Header*

The standard package header, where *Header.Type* = **EFI\_HII\_PACKAGE\_STRINGS**.

### *HdrSize*

Size of this header.

### *StringInfoOffset*

Offset, relative to the start of this header, of the string information.

### *LanguageWindow*

Specifies the default values placed in the static and dynamic windows before processing each SCSU-encoded string.

### *LanguageName*

String identifier within the current string package of the full name of the language specified by *Language*.

### *Language*

The null-terminated ASCII string that specifies the language of the strings in the package. The languages are described as specified by [Appendix M](#).

## Related Definition

```
#define UEFI_CONFIG_LANG "x-UEFI"
#define UEFI_CONFIG_LANG_2 "x-i-UEFI"
```

### 32.3.6.2 String Information

For each string identifier, the string information gives the string's text and font. The string information is encoded as a series of blocks, each with a single byte header. The blocks must be processed in order, using the current string identifier (*StringIdCurrent*), which is set initially to one (1). Processing continues until an **EFI\_SIBT\_END** block is found.

The types of blocks are: string blocks, duplicate blocks, font blocks, and skip blocks. String blocks specify the text and font for the current string identifier and increment to the next string identifier. Duplicate blocks copy the text of a previous string identifier and increment to the next string identifier. Skip blocks skip string identifiers, leaving them blank.

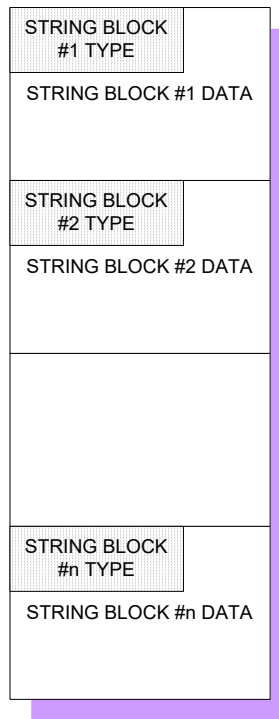

Figure 124. String Information Encoded in Blocks

Each block begins with a single byte, which contains the block type.

```
typedef struct {
    UINT8 BlockType;
    UINT8 BlockBody[];
} EFI_HII_STRING_BLOCK;
```

The following table describes the different block types:

Name	Value	Description
EFI_HII_SIBT_END	0x00	The end of the string information.
EFI_HII_SIBT_STRING_SCSU	0x10	Single string using default font information.
EFI_HII_SIBT_STRING_SCSU_FONT	0x11	Single string with font information.
EFI_HII_SIBT_STRINGS_SCSU	0x12	Multiple strings using default font information.
EFI_HII_SIBT_STRINGS_SCSU_FONT	0x13	Multiple strings with font information.
EFI_HII_SIBT_STRING_UCS2	0x14	Single UCS-2 string using default font information.
EFI_HII_SIBT_STRING_UCS2_FONT	0x15	Single UCS-2 string with font information

EFI_HII_SIBT_STRINGS_UCS2	0x16	Multiple UCS-2 strings using default font information.
EFI_HII_SIBT_STRINGS_UCS2_FONT	0x17	Multiple UCS-2 strings with font information.
EFI_HII_SIBT_DUPLICATE	0x20	Create a duplicate of an existing string.
EFI_HII_SIBT_SKIP2	0x21	Skip a certain number of string identifiers.
EFI_HII_SIBT_SKIP1	0x22	Skip a certain number of string identifiers.
EFI_HII_SIBT_EXT1	0x30	For future expansion (one byte length field)
EFI_HII_SIBT_EXT2	0x31	For future expansion (two byte length field)
EFI_HII_SIBT_EXT4	0x32	For future expansion (four byte length field)
EFI_HII_SIBT_FONT	0x40	Font information.

When processing the string blocks, each block type refers and modifies the current string identifier (*StringIdCurrent*).

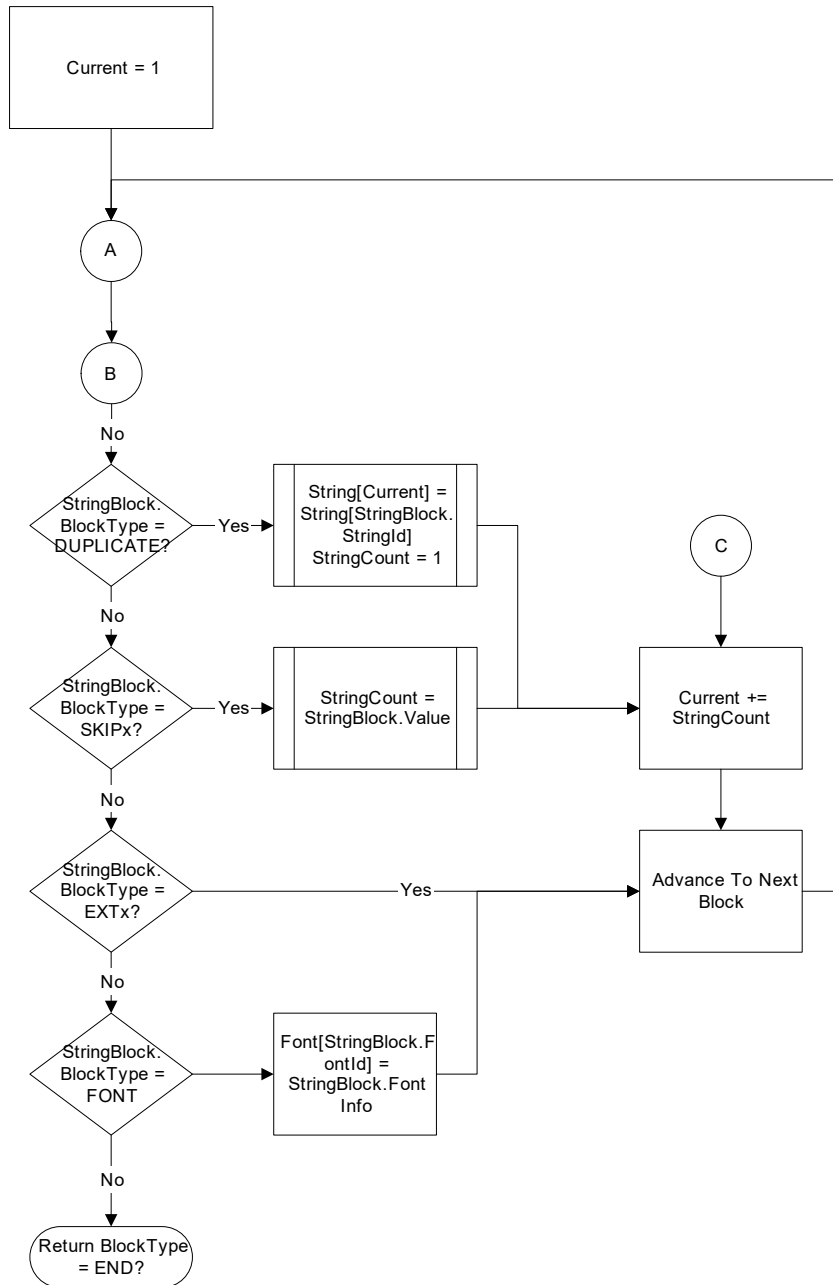

Figure 125. String Block Processing: Base Processing

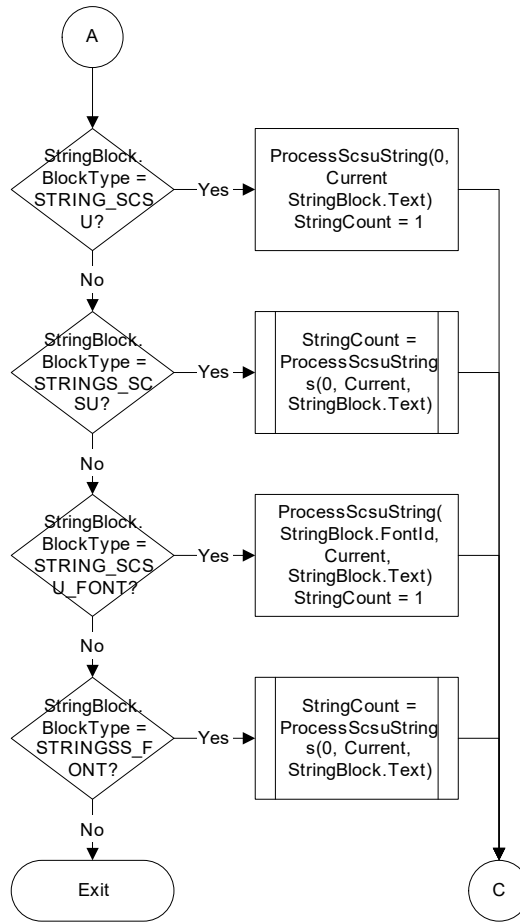

Figure 126. String Block Processing: SCSU Processing

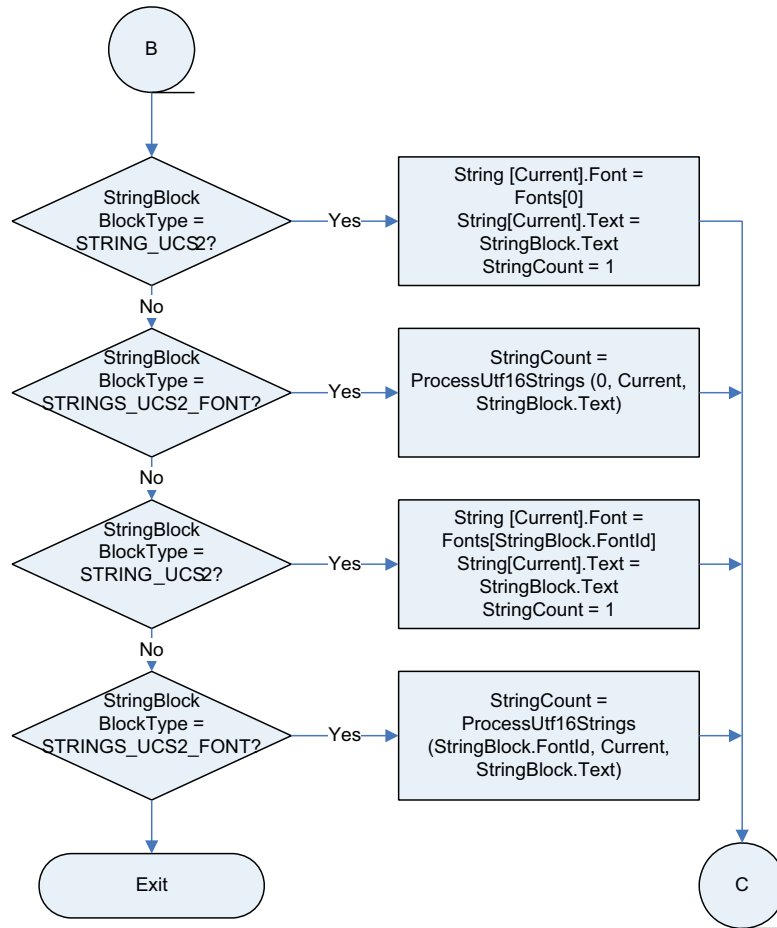

Figure 127. String Block Processing: UTF Processing

### 32.3.6.2.1 EFI\_HII\_SIBT\_DUPLICATE

#### Summary

Creates a duplicate of a previously defined string.

## Prototype

```
typedef struct _EFI_HII_SIBT_DUPLICATE_BLOCK {
    EFI_HII_STRING_BLOCK      Header;
    EFI_STRING_ID             StringId;
} EFI_HII_SIBT_DUPLICATE_BLOCK;
```

## Members

### *Header*

Standard string block header, where **Header.BlockType = EFI\_HII\_SIBT\_DUPLICATE**.

### *StringId*

The string identifier of a previously defined string with the exact same string text.

## Description

Indicates that the string with string identifier *StringIdCurrent* is the same as a previously defined string and increments *StringIdCurrent* by one.

### 32.3.6.2.2 EFI\_HII\_SIBT\_END

## Summary

Marks the end of the string information.

## Prototype

```
typedef struct _EFI_HII_SIBT_END_BLOCK {
    EFI_HII_STRING_BLOCK Header;
} EFI_HII_SIBT_END_BLOCK;
```

## Members

### *Header*

Standard extended header, where *Header.Header.BlockType = EFI\_HII\_SIBT\_EXT2* and *Header.BlockType2 = EFI\_HII\_SIBT\_FONT*.

### *BlockType2*

Indicates the type of extended block. See [Section 32.3.6.2](#) for a list of all block types.

## Description

Any strings with a string identifier greater than or equal to *StringIdCurrent* are empty.

### 32.3.6.2.3 EFI\_HII\_SIBT\_EXT1, EFI\_HII\_SIBT\_EXT2, EFI\_HII\_SIBT\_EXT4

## Summary

Future expansion block types which have a length byte.

## Prototype

```
typedef struct _EFI_HII_SIBT_EXT1_BLOCK {
  EFI_HII_STRING_BLOCK Header;
  UINT8   BlockType2;
  UINT8   Length;
} EFI_HII_SIBT_EXT1_BLOCK;
```

```
typedef struct _EFI_HII_SIBT_EXT2_BLOCK {
  EFI_HII_STRING_BLOCK Header;
  UINT8   BlockType2;
  UINT16  Length;
} EFI_HII_SIBT_EXT2_BLOCK;
```

```
typedef struct _EFI_HII_SIBT_EXT4_BLOCK {
  EFI_HII_STRING_BLOCK Header;
  UINT8   BlockType2;
  UINT32  Length;
} EFI_HII_SIBT_EXT4_BLOCK;
```

## Members

*Header*

Standard string block header, where *Header.BlockType* = **EFI\_HII\_SIBT\_EXT1**, **EFI\_HII\_SIBT\_EXT2** or **EFI\_HII\_SIBT\_EXT4**.

*Length*

Size of the string block, in bytes.

*BlockType2*

Indicates the type of extended block. See [Section 32.3.6.2](#) for a list of all block types.

## Description

These are reserved for future expansion, with length bytes included so that they can be easily skipped.

### 32.3.6.2.4 EFI\_HII\_SIBT\_FONT

## Summary

Provide information about a single font.



## Prototype

```
typedef struct _EFI_HII_SIBT_FONT_BLOCK {
  EFI_HII_SIBT_EXT2_BLOCK Header;
  UINT8 FontId;
  UINT16 FontSize;
  EFI_HII_FONT_STYLE FontStyle;
  CHAR16 FontName[...];
} EFI_HII_SIBT_FONT_BLOCK;
```

## Members

### *Header*

Standard extended header, where *Header.BlockType2* = **EFI\_HII\_SIBT\_FONT**.

### *FontId*

Font identifier, which must be unique within the string package.

### *FontSize*

Character cell size, in pixels, of the font.

### *FontStyle*

Font style. Type **EFI\_HII\_FONT\_STYLE** is defined in "Related Definitions" in **EFI\_HII\_FONT\_PACKAGE\_HDR**.

### *FontName*

Null-terminated font family name.

## Description

Associates a font identifier *FontId* with a font name *FontName*, size *FontSize* and style *FontStyle*. This font identifier may be used with the string blocks. The font identifier 0 is the default font for those string blocks which do not specify a font identifier.

### 32.3.6.2.5 EFI\_HII\_SIBT\_SKIP1

## Summary

Skips string identifiers.

## Prototype

```
typedef struct _EFI_HII_SIBT_SKIP1_BLOCK {
  EFI_HII_STRING_BLOCK Header;
  UINT8 SkipCount;
} EFI_HII_SIBT_SKIP1_BLOCK;
```

## Members

### *Header*

Standard string block header, where *Header.BlockType* = **EFI\_HII\_SIBT\_SKIP1**.

*SkipCount*

The unsigned 8-bit value to add to *StringIdCurrent*.

**Description**

Increments the current string identifier *StringIdCurrent* by the number specified.

**32.3.6.2.6 EFI\_HII\_SIBT\_SKIP2****Summary**

Skips string ids.

**Prototype**

```
typedef struct _EFI_HII_SIBT_SKIP2_BLOCK {
    EFI_HII_STRING_BLOCK Header;
    UINT16 SkipCount;
} EFI_HII_SIBT_SKIP2_BLOCK;
```

**Members***Header*

Standard string block header, where *Header.BlockType* = **EFI\_HII\_SIBT\_SKIP2**.

*SkipCount*

The unsigned 16-bit value to add to *StringIdCurrent*.

**Description**

Increments the current string identifier *StringIdCurrent* by the number specified.

**32.3.6.2.7 EFI\_HII\_SIBT\_STRING\_SCSU****Summary**

Describe a string encoded using SCSU, in the default font.

**Prototype**

```
typedef struct _EFI_HII_SIBT_STRING_SCSU_BLOCK {
    EFI_HII_STRING_BLOCK Header;
    UINT8 StringText[];
} EFI_HII_SIBT_STRING_SCSU_BLOCK;
```

**Members***Header*

Standard header where *Header.BlockType* = **EFI\_HII\_SIBT\_STRING\_SCSU**.

*StringText*

The string text is a null-terminated string, which is assigned to the string identifier *StringIdCurrent*.

## Description

This string block provides the SCSU-encoded text for the string in the default font with string identifier *StringIdCurrent* and increments *StringIdCurrent* by one.

### 32.3.6.2.8 EFI\_HII\_SIBT\_STRING\_SCSU\_FONT

## Summary

Describe a string in the specified font.

## Prototype

```
typedef struct _EFI_HII_SIBT_STRING_SCSU_FONT_BLOCK {
    EFI_HII_STRING_BLOCK Header;
    UINT8    FontIdentifier;
    UINT8    StringText[];
} EFI_HII_SIBT_STRING_SCSU_FONT_BLOCK;
```

## Members

### *Header*

Standard string block header, where *Header.BlockType* = **EFI\_HII\_SIBT\_STRING\_SCSU\_FONT**.

### *FontIdentifier*

The identifier of the font to be used as the starting font for the entire string. The identifier must either be 0 for the default font or an identifier previously specified by an **EFI\_HII\_SIBT\_FONT** block. Any string characters that deviates from this font family, size or style must provide an explicit control character. See [Section 32.2.6.2.4](#).

### *StringText*

The string text is a null-terminated encoded string, which is assigned to the string identifier *StringIdCurrent*.

## Description

This string block provides the SCSU-encoded text for the string in the font specified by *FontIdentifier* with string identifier *StringIdCurrent* and increments *StringIdCurrent* by one.

### 32.3.6.2.9 EFI\_HII\_SIBT\_STRINGS\_SCSU

## Summary

Describe strings in the default font.

## Prototype

```
typedef struct _EFI_HII_SIBT_STRINGS_SCSU_BLOCK {
    EFI_HII_STRING_BLOCK Header;
    UINT16    StringCount;
    UINT8     StringText[];
} EFI_HII_SIBT_STRINGS_SCSU_BLOCK;
```

## Members

### *Header*

Standard header where *Header.BlockType* = **EFI\_HII\_SIBT\_STRINGS\_SCSU**

### *StringCount*

Number of strings in *StringText*.

### *StringText*

The strings, where each string is a null-terminated encoded string.

## Description

This string block provides the SCSU-encoded text for *StringCount* strings which have the default font and which have sequential string identifiers. The strings are assigned the identifiers, starting with *StringIdCurrent* and continuing through *StringIdCurrent* + *StringCount* - 1. *StringIdCurrent* is incremented by *StringCount*.

### 32.3.6.2.10 EFI\_HII\_SIBT\_STRINGS\_SCSU\_FONT

## Summary

Describe strings in the specified font.

## Prototype

```
typedef struct _EFI_HII_SIBT_STRINGS_SCSU_FONT_BLOCK {
    EFI_HII_STRING_BLOCK Header;
    UINT8     FontIdentifier;
    UINT16    StringCount;
    UINT8     StringText[];
} EFI_HII_SIBT_STRINGS_SCSU_FONT_BLOCK;
```

## Members

### *Header*

Standard header where *Header.BlockType* = **EFI\_HII\_SIBT\_STRINGS\_SCSU\_FONT**.

### *StringCount*

Number of strings in *StringText*.

### *FontIdentifier*

The identifier of the font to be used as the starting font for the entire string. The identifier must either be 0 for the default font or an identifier previously

specified by an **EFI\_HII\_SIBT\_FONT** block. Any string characters that deviates from this font family, size or style must provide an explicit control character. See [Section 32.2.6.2.4](#).

### *StringText*

The strings, where each string is a null-terminated encoded string.

## Description

This string block provides the SCSU-encoded text for *StringCount* strings which have the font specified by *FontIdentifier* and which have sequential string identifiers. The strings are assigned the identifiers, starting with *StringIdCurrent* and continuing through *StringIdCurrent* + *StringCount* - 1. *StringIdCurrent* is incremented by *StringCount*.

### 32.3.6.2.11 EFI\_HII\_SIBT\_STRING\_UCS2

## Summary

Describe a string in the default font.

## Prototype

```
typedef struct _EFI_HII_SIBT_STRING_UCS2_BLOCK {
    EFI_HII_STRING_BLOCK Header;
    CHAR16 StringText[];
} EFI_HII_SIBT_STRING_UCS2_BLOCK;
```

## Members

### *Header*

Standard header where *Header.BlockType* = **EFI\_HII\_SIBT\_STRING\_UCS2**.

### *StringText*

The string text is a null-terminated UCS-2 string, which is assigned to the string identifier *StringIdCurrent*.

## Description

This string block provides the UCS-2 encoded text for the string in the default font with string identifier *StringIdCurrent* and increments *StringIdCurrent* by one.

### 32.3.6.2.12 EFI\_HII\_SIBT\_STRING\_UCS2\_FONT

## Summary

Describe a string in the specified font.

## Prototype

```
typedef struct _EFI_HII_SIBT_STRING_UCS2_FONT_BLOCK {
  EFI_HII_STRING_BLOCK Header;
  UINT8 FontIdentifier;
  CHAR16 StringText[];
} EFI_HII_SIBT_STRING_UCS2_FONT_BLOCK;
```

## Members

### *Header*

Standard header where *Header.BlockType* = **EFI\_HII\_SIBT\_STRING\_UCS2\_FONT**.

### *FontIdentifier*

The identifier of the font to be used as the starting font for the entire string. The identifier must either be 0 for the default font or an identifier previously specified by an **EFI\_HII\_SIBT\_FONT** block. Any string characters that deviates from this font family, size or style must provide an explicit control character. See [Section 32.2.6.2.4](#).

### *StringText*

The string text is a null-terminated UCS-2 string, which is assigned to the string identifier *StringIdCurrent*.

## Description

This string block provides the UCS-2 encoded text for the string in the font specified by *FontIdentifier* with string identifier *StringIdCurrent* and increments *StringIdCurrent* by one.

### 32.3.6.2.13 EFI\_HII\_SIBT\_STRINGS\_UCS2

## Summary

Describes strings in the default font.

## Prototype

```
typedef struct _EFI_HII_SIBT_STRINGS_UCS2_BLOCK {
  EFI_HII_STRING_BLOCK Header;
  UINT16 StringCount;
  CHAR16 StringText[];
} EFI_HII_SIBT_STRINGS_UCS2_BLOCK;
```

## Members

### *Header*

Standard header where *Header.BlockType* = **EFI\_HII\_SIBT\_STRINGS\_UCS2**.

### *StringCount*

Number of strings in *StringText*.

*StringText*

The string text is a series of null-terminated UCS-2 strings, which are assigned to the string identifiers *StringIdCurrent*.to *StringIdCurrent* + *StringCount* - 1.

**Description**

This string block provides the UCS-2 encoded text for the strings in the default font with string identifiers *StringIdCurrent* to *StringIdCurrent* + *StringCount* - 1 and increments *StringIdCurrent* by *StringCount*.

**32.3.6.2.14 EFI\_HII\_SIBT\_STRINGS\_UCS2\_FONT****Summary**

Describes strings in the specified font.

**Prototype**

```
typedef struct _EFI_HII_SIBT_STRINGS_UCS2_FONT_BLOCK {
  EFI_HII_STRING_BLOCK  Header;
  UINT8                 FontIdentifier;
  UINT16                StringCount;
  CHAR16                StringText[];
} EFI_HII_SIBT_STRINGS_UCS2_FONT_BLOCK;
```

**Members***Header*

Standard header where *Header.BlockType* = **EFI\_HII\_SIBT\_STRINGS\_UCS2\_FONT**.

*FontIdentifier*

The identifier of the font to be used as the starting font for the entire string. The identifier must either be 0 for the default font or an identifier previously specified by an **EFI\_HII\_SIBT\_FONT** block. Any string characters that deviates from this font family, size or style must provide an explicit control character. See [Section 32.2.6.2.4](#).

*StringCount*

Number of strings in *StringText*.

*StringText*

The string text is a series of null-terminated UCS-2 strings, which are assigned to the string identifiers *StringIdCurrent*.through *StringIdCurrent* + *StringCount* - 1.

**Description**

This string block provides the UCS-2 encoded text for the strings in the font specified by *FontIdentifier* with string identifiers *StringIdCurrent* to *StringIdCurrent* + *StringCount* - 1 and increments *StringIdCurrent* by *StringCount*.

### 32.3.6.3 String Encoding

Each of the following sections describes part of how string text is encoded.

#### 32.3.6.3.1 Standard Compression Scheme for Unicode (SCSU)

The Unicode consortium provides a standard text compression algorithm, which minimizes the amount of storage required for multiple-language strings. For more information, see “Links to UEFI-Related Documents” (<http://uefi.org/uefi>) under the heading “Unicode Compression Scheme”.

This specification extends the technique described in the following ways:

- The strings use the control code 0x7F to introduce the control codes described in [Section 32.2.6.2.4](#). The following byte is the control code. The character value 0x7F will be encoded as 0x01 (SQ0) 0x7F.
- The language information contains default static and dynamic code windows, whereas SCSU provides fixed values for these.
- Characters between 0xF000 and 0xFCFF should be rejected.

#### 32.3.6.3.2 Unicode 2-Byte Encoding (UCS-2)

The Unicode consortium provides a standard encoding algorithm, which takes two bytes per character. For more information see “Links to UEFI-Related Documents” (<http://uefi.org/uefi>) under the heading “Unicode Consortium”.

Characters between 0xF000 and 0xFCFF should be rejected.

## 32.3.7 Image Package

The Image package record describes the mapping between image identifiers and the pixels of the image themselves. The package consists of three parts: a fixed header, image information and the palette information.

### 32.3.7.1 Fixed Header

#### Summary

The fixed header consists of a standard record header and the offsets of the image and palette information.

#### Prototype

```
typedef struct _EFI_HII_IMAGE_PACKAGE_HDR {
    EFI_HII_PACKAGE_HEADER Header;
    UINT32 ImageInfoOffset;
    UINT32 PaletteInfoOffset;
} EFI_HII_IMAGE_PACKAGE_HDR;
```

#### Members

*Header*

Standard package header, where *Header.Type* = **EFI\_HII\_PACKAGE\_IMAGES**.



*ImageInfoOffset*

Offset, relative to this header, of the image information. If this is zero, then there are no images in the package.

*PaletteInfoOffset*

Offset, relative to this header, of the palette information. If this is zero, then there are no palettes in the image package.

**32.3.7.2 Image Information**

For each image identifier, the image information gives the bitmap and the relevant palette. The image information is encoded as a series of blocks, each with a single byte header. The blocks must be processed in order.

Each block begins with a single byte, which contains the block type.

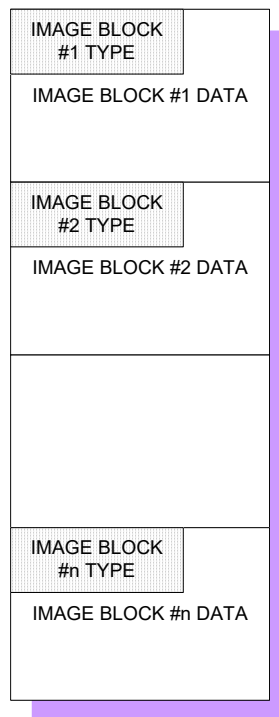

Figure 128. Image Information Encoded in Blocks

**Prototype**

```
typedef struct _EFI_HII_IMAGE_BLOCK {
    UINT8 BlockType;
    UINT8 BlockBody[];
} EFI_HII_IMAGE_BLOCK;
```

The following table describes the different block types:

Table 215. Block Types

Name	Value	Description
EFI_HII_IIBT_END	0x00	The end of the image information.
EFI_HII_IIBT_IMAGE_1BIT	0x10	1-bit w/palette
EFI_HII_IIBT_IMAGE_1BIT_TRANS	0x11	1-bit w/palette & transparency
EFI_HII_IIBT_IMAGE_4BIT	0x12	4-bit w/palette
EFI_HII_IIBT_IMAGE_4BIT_TRANS	0x13	4-bit w/palette & transparency
EFI_HII_IIBT_IMAGE_8BIT	0x14	8-bit w/palette
EFI_HII_IIBT_IMAGE_8BIT_TRANS	0x15	8-bit w/palette & transparency
EFI_HII_IIBT_IMAGE_24BIT	0x16	24-bit RGB
EFI_HII_IIBT_IMAGE_24BIT_TRANS	0x17	24-bit RGB w/transparency
EFI_HII_IIBT_IMAGE_JPEG	0x18	JPEG encoded image
EFI_HII_IIBT_IMAGE_PNG	0x19	PNG encoded image
EFI_HII_IIBT_DUPLICATE	0x20	Duplicate an existing image identifier
EFI_HII_IIBT_SKIP2	0x21	Skip a certain number of image identifiers.
EFI_HII_IIBT_SKIP1	0x22	Skip a certain number of image identifiers.
EFI_HII_IIBT_EXT1	0x30	For future expansion (one byte length field)
EFI_HII_IIBT_EXT2	0x31	For future expansion (two byte length field)
EFI_HII_IIBT_EXT4	0x32	For future expansion (four byte length field)

In order to recreate all images, start at the first block and process them all until an **EFI\_HII\_IIBT\_END\_BLOCK** block is found. When processing the image blocks, each block refers to the current image identifier (*ImageIdCurrent*), which is initially set to one (1).

Image blocks of an unknown type should be skipped. If they cannot be skipped, then processing halts.

### 32.3.7.2.1 EFI\_HII\_IIBT\_END

#### Summary

Marks the end of the image information.

#### Prototype

```
# define EFI_HII_IIBT_END 0x00

typedef struct _EFI_HII_IIBT_END_BLOCK {
    EFI_HII_IMAGE_BLOCK Header;
} EFI_HII_IIBT_END_BLOCK;
```

#### Members

*Header*

Standard image block header, where *Header.BlockType* = **EFI\_HII\_IIBT\_END\_BLOCK**.

*BlockType2*

Indicates the type of extended block. See [Section 32.3.6.2](#) for a list of all block types.

**Description**

Any images with an image identifier greater than or equal to *ImageIdCurrent* are empty.

**32.3.7.2.2 EFI\_HII\_IIBT\_EXT1, EFI\_HII\_IIBT\_EXT2, EFI\_HII\_IIBT\_EXT4****Summary**

Generic prefix for image information with a 1-byte length.

**Prototype**

```
#define EFI_HII_IIBT_EXT1 0x30
typedef struct _EFI_HII_IIBT_EXT1_BLOCK {
    EFI_HII_IMAGE_BLOCK Header;
    UINT8    BlockType2;
    UINT8    Length;
} EFI_HII_IIBT_EXT1_BLOCK;
```

```
#define EFI_HII_IIBT_EXT2 0x31
```

```
typedef struct _EFI_HII_IIBT_EXT2_BLOCK {
    EFI_HII_IMAGE_BLOCK Header;
    UINT8    BlockType2;
    UINT16   Length;
} EFI_HII_IIBT_EXT2_BLOCK;
```

```
#define EFI_HII_IIBT_EXT4 0x32
```

```
typedef struct _EFI_HII_IIBT_EXT4_BLOCK {
    EFI_HII_IMAGE_BLOCK Header;
    UINT8    BlockType2;
    UINT32   Length;
} EFI_HII_IIBT_EXT4_BLOCK;
```

**Members***Header*

Standard image block header, where *Header.BlockType* = **EFI\_HII\_IIBT\_EXT1\_BLOCK**, **EFI\_HII\_IIBT\_EXT2\_BLOCK** or **EFI\_HII\_IIBT\_EXT4\_BLOCK**.

*Length*

Size of the image block, in bytes, including the image block header.

*BlockType2*

Indicates the type of extended block. See [Section 32.3.7.2](#) for a list of all block types.

## Description

Future extensions for image records which need a length-byte length use this prefix.

### 32.3.7.2.3 EFI\_HII\_IIBT\_IMAGE\_1BIT

## Summary

One bit-per-pixel graphics image with palette information.

## Prototype

```
typedef struct _EFI_HII_IIBT_IMAGE_1BIT_BASE {
    UINT16    Width;
    UINT16    Height;
    UINT8     Data[ ... ];
} EFI_HII_IIBT_IMAGE_1BIT_BASE;

#define EFI_HII_IIBT_IMAGE_1BIT 0x10

typedef struct _EFI_HII_IIBT_IMAGE_1BIT_BLOCK {
    EFI_HII_IMAGE_BLOCK    Header;
    UINT8                  PaletteIndex;
    EFI_HII_IIBT_IMAGE_1BIT_BASE    Bitmap;
} EFI_HII_IIBT_IMAGE_1BIT_BLOCK;
```

## Members

### *Header*

Standard image header, where *Header.BlockType* = **EFI\_HII\_IIBT\_IMAGE\_1BIT**.

### *Width*

Width of the bitmap in pixels.

### *Height*

Height of the bitmap in pixels.

### *Bitmap*

The bitmap specifies a series of pixels, one bit per pixel, *left-to-right, top-to-bottom*, and is padded out to the nearest byte. The number of bytes per bitmap can be calculated as:  $((Width + 7)/8) * Height$ .

### *PaletteIndex*

Index of the palette in the palette information.

## Description

This record assigns the 1-bit-per-pixel bitmap data to the *ImageIdCurrent* identifier and increment *ImageIdCurrent* by one. The image's upper left hand corner pixel is the most significant bit of the first bitmap byte. An example of a **EFI\_HII\_IIBT\_IMAGE\_1BIT** structure is shown below:

```

0x01      ; Palette Index
0x000B    ; Width
0x0013    ; Height
10000000b,00000000b ; Bitmap
11000000b,00000000b
11100000b,00000000b
11110000b,00000000b
11111000b,00000000b
11111100b,00000000b
11111110b,00000000b
11111111b,00000000b
11111111b,10000000b
11111111b,11000000b
11111111b,11100000b
11111110b,00000000b
11101111b,00000000b
11001111b,00000000b
10001111b,10000000b
00001111b,10000000b
00000111b,11000000b
00000111b,11000000b
00000011b,10000000b

```

### 32.3.7.2.4 EFI\_HII\_IIBT\_IMAGE\_1BIT\_TRANS

#### Summary

One bit-per-pixel graphics image with palette information and transparency.

## Prototype

```
#define EFI_HII_IIBT_IMAGE_1BIT_TRANS 0x11

typedef struct _EFI_HII_IIBT_IMAGE_1BIT_TRANS_BLOCK {
    EFI_HII_IMAGE_BLOCK  Header;
    UINT8                PaletteIndex;
    EFI_HII_IIBT_IMAGE_1BIT_BASE Bitmap;
} EFI_HII_IIBT_IMAGE_1BIT_TRANS_BLOCK;
```

## Members

### *Header*

Standard image header, where *Header.BlockType* = **EFI\_HII\_IIBT\_IMAGE\_1BIT\_TRANS**.

### *PaletteIndex*

Index of the palette in the palette information.

### *Bitmap*

The bitmap specifies a series of pixels, one bit per pixel, *left-to-right, top-to-bottom*, and is padded out to the nearest byte. The number of bytes per bitmap can be calculated as:  $((Width + 7)/8) * Height$ .

## Description

This record assigns the 1-bit-per-pixel bitmap data to the *ImageIdCurrent* identifier and increment *ImageIdCurrent* by one. The data in the **EFI\_HII\_IIBT\_IMAGE\_1BIT\_TRANS** structure is exactly the same as the **EFI\_HII\_IIBT\_IMAGE\_1BIT** structure, the difference is how the data is treated.

The bitmap pixel value 0 is the 'transparency' value and will not be written to the screen. The bitmap pixel value 1 will be translated to the color specified by *Palette*.

### 32.3.7.2.5 EFI\_HII\_IIBT\_IMAGE\_24BIT

## Summary

A 24 bit-per-pixel graphics image.

## Prototype

```
#define EFI_HII_IIBT_IMAGE_24BIT 0x16

typedef struct _EFI_HII_IIBT_IMAGE_24BIT_BASE
  UINT16      Width,
  UINT16      Height,
  EFI_HII_RGB_PIXEL  Bitmap[ ... ];
} EFI_HII_IIBT_IMAGE_24BIT_BASE;

typedef struct _EFI_HII_IIBT_IMAGE_24BIT_BLOCK {
  EFI_HII_IMAGE_BLOCK  Header,
  EFI_HII_IIBT_IMAGE_24BIT_BASE  Bitmap;
} EFI_HII_IIBT_IMAGE_24BIT_BLOCK;
```

## Members

### *Width*

Width of the bitmap in pixels.

### *Height*

Height of the bitmap in pixels.

### *Header*

Standard image header, where *Header.BlockType* = **EFI\_HII\_IIBT\_IMAGE\_24BIT**.

### *Bitmap*

The bitmap specifies a series of pixels, 24 bits per pixel, *left-to-right, top-to-bottom*. The number of bytes per bitmap can be calculated as: (Width \* 3) \* Height. Type **EFI\_HII\_RGB\_PIXEL** is defined in “Related Definitions” below.

## Description

This record assigns the 24-bit-per-pixel bitmap data to the *ImageIdCurrent* identifier and increment *ImageIdCurrent* by one. The image’s upper left hand corner pixel is composed of the first three bitmap bytes. The first byte is the pixel’s blue component value, the next byte is the pixel’s green component value, and the third byte is the pixel’s red component value (B,G,R). Each color component value can vary from 0x00 (color off) to 0xFF (color full on), allowing 16.8 millions colors that can be specified.

## Related Definitions

```
typedef struct _EFI_HII_RGB_PIXEL {
  UINT8  b;
  UINT8  g;
  UINT8  r;
} EFI_HII_RGB_PIXEL;
```

### *b*

The relative intensity of blue in the pixel’s color, from off (0x00) to full-on (0xFF).

*g*

The relative intensity of green in the pixel's color, from off (0x00) to full-on (0xFF).

*r*

The relative intensity of red in the pixel's color, from off (0x00) to full-on (0xFF).

### 32.3.7.2.6 EFI\_HII\_IIBT\_IMAGE\_24BIT\_TRANS

#### Summary

A 24 bit-per-pixel graphics image with transparency.

#### Prototype

```
#define _EFI_HII_IIBT_IMAGE_24BIT_TRANS 0x17

typedef struct EFI_HII_IIBT_IMAGE_24BIT_TRANS_BLOCK {
    EFI_HII_IMAGE_BLOCK    Header;
    EFI_HII_IIBT_IMAGE_24BIT_BASE Bitmap;
} EFI_HII_IIBT_IMAGE_24BIT_TRANS_BLOCK;
```

#### Members

*Header*

Standard image header, where *Header.BlockType* = **EFI\_HII\_IIBT\_IMAGE\_24BIT\_TRANS**.

*Bitmap*

The bitmap specifies a series of pixels, 24 bits per pixel, *left-to-right, top-to-bottom*. The number of bytes per bitmap can be calculated as: (Width \* 3) \* Height.

*Width*

Width of the bitmap in pixels.

*Height*

Height of the bitmap in pixels.

#### Description

This record assigns the 24-bit-per-pixel bitmap data to the *ImageIdCurrent* identifier and increment *ImageIdCurrent* by one. The data in the **EFI\_HII\_IMAGE\_24BIT\_TRANS** structure is exactly the same as the **EFI\_HII\_IMAGE\_24BIT** structure, the difference is how the data is treated.

The bitmap pixel value 0x00, 0x00, 0x00 is the 'transparency' value and will not be written to the screen. All other bitmap pixel values will be written as defined to the screen. Since the 'transparency' value replaces *true* black, for image to display black they should use the color 0x00, 0x00, 0x01 (very dark red)



### 32.3.7.2.7 EFI\_HII\_IIBT\_IMAGE\_4BIT

#### Summary

Four bits-per-pixel graphics image with palette information.

#### Prototype

```
typedef struct _EFI_HII_IIBT_IMAGE_4BIT_BASE {
    UINT16 Width;
    UINT16 Height;
    UINT8 Data[ ... ];
} EFI_HII_IIBT_IMAGE_4BIT_BASE;

#define EFI_HII_IIBT_IMAGE_4BIT 0x12

typedef struct _EFI_HII_IIBT_IMAGE_4BIT_BLOCK {
    EFI_HII_IMAGE_BLOCK Header;
    UINT8 PaletteIndex;
    EFI_HII_IIBT_IMAGE_4BIT_BASE Bitmap;
} EFI_HII_IIBT_IMAGE_4BIT_BLOCK;
```

#### Members

##### *Width*

Width of the bitmap in pixels.

##### *Height*

Height of the bitmap in pixels.

##### *Header*

Standard image header, where *Header.BlockType* = **EFI\_HII\_IIBT\_IMAGE\_4BIT**.

##### *PaletteIndex*

Index of the palette in the palette information.

##### *Bitmap*

The bitmap specifies a series of pixels, four bits per pixel, *left-to-right, top-to-bottom*, and is padded out to the nearest byte. The number of bytes per bitmap can be calculated as:  $((Width + 1)/2) * Height$ .

#### Description

This record assigns the 4-bit-per-pixel bitmap data to the *ImageIdCurrent* identifier using the specified palette and increment *ImageIdCurrent* by one. The image's upper left hand corner pixel is the most significant nibble of the first bitmap byte.

### 32.3.7.2.8 EFI\_HII\_IIBT\_IMAGE\_4BIT\_TRANS

#### Summary

Four bits-per-pixel graphics image with palette information and transparency.

#### Prototype

```
#define EFI_HII_IIBT_IMAGE_4BIT_TRANS 0x13

typedef struct _EFI_HII_IIBT_IMAGE_4BIT_TRANS_BLOCK {
  EFI_HII_IMAGE_BLOCK  Header,
  UINT8                PaletteIndex,
  EFI_HII_IIBT_IMAGE_4BIT_BASE  Bitmap,
} EFI_HII_IIBT_IMAGE_4BIT_TRANS_BLOCK;
```

#### Members

##### *Header*

Standard image header, where *Header.BlockType* = **EFI\_HII\_IIBT\_IMAGE\_4BIT\_TRANS**.

##### *PaletteIndex*

Index of the palette in the palette information.

##### *Bitmap*

The bitmap specifies a series of pixels, four bits per pixel, *left-to-right, top-to-bottom*, and is padded out to the nearest byte. The number of bytes per bitmap can be calculated as:  $((Width + 1)/2) * Height$ .

#### Description

This record assigns the 4-bit-per-pixel bitmap data to the *ImageIdCurrent* identifier using the specified palette and increment *ImageIdCurrent* by one. The data in the **EFI\_HII\_IMAGE\_4BIT\_TRANS** structure is exactly the same as the **EFI\_HII\_IMAGE\_4BIT** structure, the difference is how the data is treated.

The bitmap pixel value 0 is the 'transparency' value and will not be written to the screen. All the other bitmap pixel values will be translated to the color specified by *Palette*.

### 32.3.7.2.9 EFI\_HII\_IIBT\_IMAGE\_8BIT

#### Summary

Eight bits-per-pixel graphics image with palette information.

## Prototype

```
#define EFI_HII_IIBT_IMAGE_8BIT 0x14

typedef struct _EFI_HII_IIBT_IMAGE_8BIT_BASE {
    UINT16 Width;
    UINT16 Height;
    UINT8 Data[ ... ];
} EFI_HII_IIBT_IMAGE_8BIT_BASE;

typedef struct _EFI_HII_IIBT_IMAGE_8BIT_BLOCK {
    EFI_HII_IMAGE_BLOCK Header;
    UINT8 PaletteIndex;
    EFI_HII_IIBT_IMAGE_8BIT_BASE Bitmap;
} EFI_HII_IIBT_IMAGE_8BIT_BLOCK;
```

## Members

### *Width*

Width of the bitmap in pixels.

### *Height*

Height of the bitmap in pixels.

### *Header*

Standard image header, where *Header.BlockType* = **EFI\_HII\_IIBT\_IMAGE\_8BIT**.

### *PaletteIndex*

Index of the palette in the palette information.

### *Bitmap*

The bitmap specifies a series of pixels, eight bits per pixel, *left-to-right, top-to-bottom*. The number of bytes per bitmap can be calculated as: *Width* \* *Height*.

## Description

This record assigns the 8-bit-per-pixel bitmap data to the *ImageIdCurrent* identifier using the specified palette and increment *ImageIdCurrent* by one. The image's upper left hand corner pixel is the first bitmap byte.

### 32.3.7.2.10 EFI\_HII\_IIBT\_IMAGE\_8BIT\_TRANS

## Summary

Eight bits-per-pixel graphics image with palette information and transparency.

## Prototype

```
#define EFI_HII_IIBT_IMAGE_8BIT_TRANS 0x15

typedef struct _EFI_HII_IIBT_IMAGE_8BIT_TRANS_BLOCK {
  EFI_HII_IMAGE_BLOCK  Header,
  UINT8                PaletteIndex,
  EFI_HII_IIBT_IMAGE_8BIT_BASE Bitmap,
} EFI_HII_IIBT_IMAGE_8BIT_TRANS_BLOCK;
```

## Members

### *Header*

Standard image header, where *Header.BlockType* = **EFI\_HII\_IIBT\_IMAGE\_8BIT\_TRANS**.

### *PaletteIndex*

Index of the palette in the palette information.

### *Bitmap*

The bitmap specifies a series of pixels, eight bits per pixel, *left-to-right, top-to-bottom*. The number of bytes per bitmap can be calculated as: *Width* \* *Height*.

## Description

This record assigns the 8-bit-per-pixel bitmap data to the *ImageIdCurrent* identifier using the specified palette and increment *ImageIdCurrent* by one. The data in the **EFI\_HII\_IMAGE\_8BIT\_TRANS** structure is exactly the same as the **EFI\_HII\_IMAGE\_8BIT** structure, the difference is how the data is treated.

The bitmap pixel value 0 is the 'transparency' value and will not be written to the screen. All the other bitmap pixel values will be translated to the color specified by *Palette*.

### 32.3.7.2.11 EFI\_HII\_IIBT\_DUPLICATE

## Summary

Assigns a new character value to a previously defined image.

## Prototype

```
#define EFI_HII_IIBT_DUPLICATE 0x20

typedef struct _EFI_HII_IIBT_DUPLICATE_BLOCK {
  EFI_HII_IMAGE_BLOCK  Header,
  EFI_IMAGE_ID        ImageId,
} EFI_HII_IIBT_DUPLICATE_BLOCK;
```

## Members

### *Header*

Standard image header, where *Header.BlockType* = **EFI\_HII\_IIBT\_DUPLICATE**.

### *ImageId*

The previously defined image ID with the exact same image.

## Description

Indicates that the image with image ID *ImageValueCurrent* has the same image as a previously defined image ID and increments *ImageValueCurrent* by one.

### 32.3.7.2.12 EFI\_HII\_IIBT\_IMAGE\_JPEG

## Summary

A true-color bitmap is encoded with JPEG image compression.

## Prototype

```
#define EFI_HII_IIBT_IMAGE_JPEG 0x18

typedef struct _EFI_HII_IIBT_JPEG_BLOCK {
  EFI_HII_IMAGE_BLOCK  Header,
  UINT32               Size,
  UINT8                Data[ ... ];
} EFI_HII_IIBT_JPEG;
```

## Members

### *Header*

Standard image header, where *Header.BlockType* = **EFI\_HII\_IIBT\_IMAGE\_JPEG**.

### *Size*

Specifies the size of the JPEG encoded data.

*Data*

JPEG encoded data with 'JFIF' signature at offset 6 in the data block. The JPEG encoded data, specifies type of encoding and final size of true-color image.

**Description**

This record assigns the JPEG image data to the *ImageIdCurrent* identifier and increment *ImageIdCurrent* by one. The JPEG decoder is only required to cover the basic JPEG encoding types, which are produced by standard available paint packages (for example: MSPaint under Windows from Microsoft). This would include JPEG encoding of high (1:1:1) and medium (4:1:1) quality with only three components (R,G,B) – no support for the special gray component encoding.

**32.3.7.2.13 EFI\_HII\_IIBT\_SKIP1****Summary**

Skips image IDs.

**Prototype**

```
#define EFI_HII_IIBT_SKIP1 0x22

typedef struct _EFI_HII_IIBT_SKIP1_BLOCK {
    EFI_HII_IMAGE_BLOCK Header;
    UINT8 SkipCount;
} EFI_HII_IIBT_SKIP1_BLOCK;
```

**Members***Header*

Standard image header, where *Header.BlockType* = **EFI\_HII\_IIBT\_SKIP1**.

*SkipCount*

The unsigned 8-bit value to add to *ImageIdCurrent*.

**Description**

Increments the current image ID *ImageIdCurrent* by the number specified.

**32.3.7.2.14 EFI\_HII\_IIBT\_SKIP2****Summary**

Skips image IDs.

## Prototype

```
#define EFI_HII_IIBT_SKIP2 0x21

typedef struct _EFI_HII_IIBT_SKIP2_BLOCK {
    EFI_HII_IMAGE_BLOCK Header;
    UINT16 SkipCount;
} EFI_HII_IIBT_SKIP2_BLOCK;
```

## Members

*Header*

Standard image header, where *Header.BlockType* = **EFI\_HII\_IIBT\_SKIP2**.

*SkipCount*

The unsigned 16-bit value to add to *ImageIdCurrent*.

## Description

Increments the current image ID *ImageIdCurrent* by the number specified.

### 32.3.7.2.15 EFI\_HII\_IIBT\_PNG\_BLOCK

Add a new image block structure for **EFI\_HII\_IIBT\_IMAGE\_PNG**. This supports the PNG image format in EFI HII image database.

## Related Definitions

```
/**
*****
// EFI_HII_IIBT_IMAGE_PNG(0x19)
*****
typedef struct _EFI_HII_IIBT_PNG_BLOCK {
    EFI_HII_IMAGE_BLOCK Header;
    UINT32 Size;
    UINT8 Data [1];
} EFI_HII_IIBT_PNG_BLOCK;
```

## Member

*Header*

Standard image block header, where *Header.locktype* = **EFI\_HII\_IIBT\_IMAGE\_PNG**.

*Size*

Size of the PNG image.

*Data*

The raw data of the PNG image file.

### 32.3.7.3 Palette Information

## Summary

This section describes the palette information within an image package.

## Prototype

```
typedef struct _EFI_HII_IMAGE_PALETTE_INFO_HEADER {
    UINT16 PaletteCount;
} EFI_HII_IMAGE_PALETTE_INFO_HEADER;
```

## Members

*PaletteCount*

Number of palettes.

## Description

This fixed header is followed by zero or more variable-length palette information records. The structures are assigned a number 1 to n.

### 32.3.7.3.1 Palette Information Records

## Summary

A single palette

## Prototype

```
typedef struct _EFI_HII_IMAGE_PALETTE_INFO {
    UINT16 PaletteSize;
    EFI_HII_RGB_PIXEL PaletteValue[...];
} EFI_HII_IMAGE_PALETTE_INFO;
```

## Members

*PaletteSize*

Size of the palette information.

*PaletteValue*

Array of color values. Type **EFI\_HII\_RGB\_PIXEL** is described in "Related Definitions" in **EFI\_HII\_IIBT\_IMAGE\_24BIT**.

## Description

Each palette information record is an array of 24-bit color structures. The first entry (**PaletteValue[0]**) corresponds to color 0 in the source image; the second entry (**PaletteValue[1]**) corresponds to color 1, etc. Each palette entry is a three byte entry, with the first byte equal to the blue component of the color, followed by green, and finally red (B,G,R). Each color component value can vary from 0x00 (color off) to 0xFF (color full on), allowing 16.8 millions colors that can be specified.

A black & white 1-bit image would have the following palette structure:





Figure 129. Palette Structure of a Black & White, One-Bit Image

A 4-bit image would have the following palette structure:

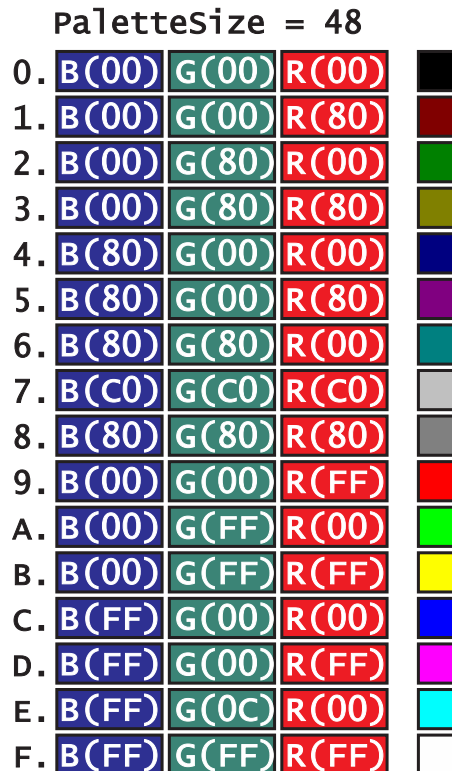

Figure 130. Palette Structure of a Four-Bit Image

The image palette must only contain the palette entries specified in the bitmap. The bitmap should allocate each color index starting from 0x00, so the palette information can be as small as possible. The following is an example of a palette structure of a 4-bit image that only uses 6 colors:

---

**PaletteSize = 18**

0.	B(00)	G(00)	R(00)	
1.	B(99)	G(00)	R(33)	
2.	B(CC)	G(00)	R(33)	
3.	B(FF)	G(33)	R(66)	
4.	B(FF)	G(66)	R(66)	
5.	B(FF)	G(99)	R(66)	
6.	B(FF)	G(FF)	R(FF)	

---

**Figure 131. Palette Structure of a Four-Bit, Six-Color Image**

Each palette entry specifies each unique color in the image. The above figure would be typical of light blue logo on a black background, with several shades of blue for anti-aliasing the blue logo on the black background.

### 32.3.8 Forms Package

The Forms package is used to carry forms-based encoding data.

#### Prototype

```
typedef struct _EFI_HII_FORM_PACKAGE_HDR {
    EFI_HII_PACKAGE_HEADER      Header;
    //EFI_IFR_OP_HEADER          OpCodeHeader;
    //More op-codes follow
} EFI_HII_FORM_PACKAGE_HDR;
```

#### Parameters

*Header*

The standard package header, where *Header.Type* = **EFI\_HII\_PACKAGE\_FORMS**.

*OpCodeHeader*

The header for the first of what will be a series of op-codes associated with the forms data described in this package. The syntax of the forms can be referenced in [Section 32.2.5](#).

#### Description

This is a package type designed to represent Internal Forms Representation (IFR) objects as a collection of op-codes

#### 32.3.8.1 Binary Encoding

The IFR is a binary encoding for HII-related objects. Every object has (at least) three attributes:

Opcode. The enumeration of all of the different HII-related objects.

**Length.** The length of the opcode itself (2-127 bytes).

**Scope.** If set, this opens up a new scope. Certain objects describe attributes or capabilities which only apply to the current scope rather than the entire form. The scope extends up to the special **END** opcode, which marks the end of the current scope.

The binary objects are encoded as byte stream. Every object begins with a standard header (**EFI\_IFR\_OP\_HEADER**), which describes the opcode type, length and scope.

The simple binary object consists of a standard header, which contains a single 8-bit opcode, a 7-bit length and a 1-bit nesting indicator. The length specifies the number of bytes in the opcode, including the header. The simple binary object may also have zero or more bytes of fixed, object-specific, data.

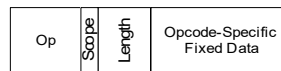

**Figure 132. Simple Binary Object**

When the *Scope* bit is set, it marks the beginning of a new scope which applies to all subsequent opcodes until the matching **EFI\_IFR\_END** opcode is found to close the scope. Those opcodes may, in turn, open new scopes as well, creating nested scopes.

### 32.3.8.2 Standard Headers

#### 32.3.8.2.1 EFI\_IFR\_OP\_HEADER

##### Summary

Standard opcode header

##### Prototype

```
typedef struct _EFI_IFR_OP_HEADER {
    UINT8    OpCode;
    UINT8    Length:7;
    UINT8    Scope:1;
} EFI_IFR_OP_HEADER;
```

##### Members

<i>OpCode</i>	Defines which type of operation is being described by this header. See <a href="#">Section 32.3.8.3</a> for a list of IFR opcodes.
<i>Length</i>	Defines the number of bytes in the opcode, including this header.
<i>Scope</i>	If this bit is set, the opcode begins a new scope, which is ended by an <b>EFI_IFR_END</b> opcode.

##### Description

Forms are represented in a binary format roughly similar to processor instructions.

Each header contains an opcode, a length and a scope indicator.

If *Scope* indicator is set, the scope exists until it reaches a corresponding **EFI\_IFR\_END** opcode. Scopes may be nested within other scopes.

### Related Definitions

```
typedef UINT16 EFI_QUESTION_ID;
typedef UINT16 EFI_IMAGE_ID;
typedef UINT16 EFI_STRING_ID;
typedef UINT16 EFI_FORM_ID;
typedef UINT16 EFI_VARSTORE_ID;
typedef UINT16 EFI_ANIMATION_ID;
```

#### 32.3.8.2.2 EFI\_IFR\_QUESTION\_HEADER

### Summary

Standard question header.

### Prototype

```
typedef struct _EFI_IFR_QUESTION_HEADER {
    EFI_IFR_STATEMENT_HEADER Header;
    EFI_QUESTION_ID QuestionId;
    EFI_VARSTORE_ID VarStoreId;
    union {
        EFI_STRING_ID VarName;
        UINT16 VarOffset;
    } VarStoreInfo;
    UINT8 Flags;
} EFI_IFR_QUESTION_HEADER;
```

### Members

<i>Header</i>	The standard statement header.
<i>QuestionId</i>	The unique value that identifies the particular question being defined by the opcode. The value of zero is reserved.
<i>Flags</i>	A bit-mask that determines which unique settings are active for this question. See “Related Definitions” below for the meanings of the individual bits.
<i>VarStoreId</i>	Specifies the identifier of a previously declared variable store to use when storing the question’s value. A value of zero indicates no associated variable store.
<i>VarStoreInfo</i>	If <i>VarStoreId</i> refers to Buffer Storage ( <b>EFI_IFR_VARSTORE</b> or <b>EFI_IFR_VARSTORE_EFI</b> ), then <i>VarStoreInfo</i> contains a 16-bit Buffer Storage offset ( <i>VarOffset</i> ). If <i>VarStoreId</i> refers to Name/Value Storage ( <b>EFI_IFR_VARSTORE_NAME_VALUE</b> ), then <i>VarStoreInfo</i>

contains the String ID of the name (*VarName*) for this name/value pair.

## Description

This is the standard header for questions.

## Related Definitions

```

//*****
// Flags values
//*****
#define EFI_IFR_FLAG_READ_ONLY    0x01
#define EFI_IFR_FLAG_CALLBACK     0x04
#define EFI_IFR_FLAG_RESET_REQUIRED 0x10
#define EFI_IFR_FLAG_RECONNECT_REQUIRED 0x40
#define EFI_IFR_FLAG_OPTIONS_ONLY 0x80

```

EFI_IFR_FLAG_READ_ONLY	The question is read-only
EFI_IFR_FLAG_CALLBACK	Designates if a particular opcode is to be treated as something that will initiate a callback to a registered driver.
EFI_IFR_FLAG_RESET_REQUIRED	If a particular choice is modified, designates that a return flag will be activated upon exiting of the browser, which indicates that the changes that the user requested require a reset to enact.
EFI_IFR_FLAG_RECONNECT_REQUIRED	If a particular choice is modified, designates that a return flag will be activated upon exiting of the formset or the browser, which indicates that the changes that the user requested require a reconnect to enact.
EFI_IFR_FLAG_OPTIONS_ONLY	For questions with options, this indicates that only the options will be available for user choice.

### 32.3.8.2.3 EFI\_IFR\_STATEMENT\_HEADER

## Summary

Standard statement header.

## Prototype

```
typedef struct _EFI_IFR_STATEMENT_HEADER {  
    EFI_STRING_ID Prompt;  
    EFI_STRING_ID Help;  
} EFI_IFR_STATEMENT_HEADER;
```

## Members

*Prompt*

The string identifier of the prompt string for this particular statement. The value 0 indicates no prompt string.

*Help*

The string identifier of the help string for this particular statement. The value 0 indicates no help string.

## Description

This is the standard header for statements, including questions.

### 32.3.8.3 Opcode Reference

This section describes each of the IFR opcode encodings in detail. The table below lists the opcodes in numeric order while the reference section lists them in alphabetic order.

Table 216. IFR Opcodes

Opcode	Value	Description
<b>EFI_IFR_FORM_OP</b>	0x01	Form
<b>EFI_IFR_SUBTITLE_OP</b>	0x02	Subtitle statement
<b>EFI_IFR_TEXT_OP</b>	0x03	Static text/image statement
<b>EFI_IFR_IMAGE_OP</b>	0x04	Static image.
<b>EFI_IFR_ONE_OF_OP</b>	0x05	One-of question
<b>EFI_IFR_CHECKBOX_OP</b>	0x06	Boolean question
<b>EFI_IFR_NUMERIC_OP</b>	0x07	Numeric question
<b>EFI_IFR_PASSWORD_OP</b>	0x08	Password string question
<b>EFI_IFR_ONE_OF_OPTION_OP</b>	0x09	Option
<b>EFI_IFR_SUPPRESS_IF_OP</b>	0x0A	Suppress if conditional
<b>EFI_IFR_LOCKED_OP</b>	0x0B	Marks statement/question as locked
<b>EFI_IFR_ACTION_OP</b>	0x0C	Button question
<b>EFI_IFR_RESET_BUTTON_OP</b>	0x0D	Reset button statement
<b>EFI_IFR_FORM_SET_OP</b>	0x0E	Form set
<b>EFI_IFR_REF_OP</b>	0x0F	Cross-reference statement
<b>EFI_IFR_NO_SUBMIT_IF_OP</b>	0x10	Error checking conditional
<b>EFI_IFR_INCONSISTENT_IF_OP</b>	0x11	Error checking conditional
<b>EFI_IFR_EQ_ID_VAL_OP</b>	0x12	Return true if question value equals UINT16
<b>EFI_IFR_EQ_ID_ID_OP</b>	0x13	Return true if question value equals another question value
<b>EFI_IFR_EQ_ID_VAL_LIST_OP</b>	0x14	Return true if question value is found in list of UINT16s
<b>EFI_IFR_AND_OP</b>	0x15	Push true if both sub-expressions returns true.
<b>EFI_IFR_OR_OP</b>	0x16	Push true if either sub-expressions returns true.
<b>EFI_IFR_NOT_OP</b>	0x17	Push false if sub-expression returns true, otherwise return true.
<b>EFI_IFR_RULE_OP</b>	0x18	Create rule in current form.
<b>EFI_IFR_GRAY_OUT_IF_OP</b>	0x19	Nested statements, questions or options will not be selectable if expression returns true.
<b>EFI_IFR_DATE_OP</b>	0x1A	Date question.
<b>EFI_IFR_TIME_OP</b>	0x1B	Time question.
<b>EFI_IFR_STRING_OP</b>	0x1C	String question
<b>EFI_IFR_REFRESH_OP</b>	0x1D	Interval for refreshing a question

Opcode	Value	Description
<b>EFI_IFR_DISABLE_IF_OP</b>	0x1E	Nested statements, questions or options will not be processed if expression returns true.
<b>EFI_IFR_ANIMATION_OP</b>	0x1F	Animation associated with question statement, form or form set.
<b>EFI_IFR_TO_LOWER_OP</b>	0x20	Convert a string on the expression stack to lower case.
<b>EFI_IFR_TO_UPPER_OP</b>	0x21	Convert a string on the expression stack to upper case.
<b>EFI_IFR_MAP_OP</b>	0x22	Convert one value to another by selecting a match from a list.
<b>EFI_IFR_ORDERED_LIST_OP</b>	0x23	Set question
<b>EFI_IFR_VARSTORE_OP</b>	0x24	Define a buffer-style variable storage.
<b>EFI_IFR_VARSTORE_NAME_VALUE_OP</b>	0x25	Define a name/value style variable storage.
<b>EFI_IFR_VARSTORE_EFI_OP</b>	0x26	Define a UEFI variable style variable storage.
<b>EFI_IFR_VARSTORE_DEVICE_OP</b>	0x27	Specify the device path to use for variable storage.
<b>EFI_IFR_VERSION_OP</b>	0x28	Push the revision level of the UEFI Specification to which this Forms Processor is compliant.
<b>EFI_IFR_END_OP</b>	0x29	Marks end of scope.
<b>EFI_IFR_MATCH_OP</b>	0x2A	Push TRUE if string matches a pattern.
<b>EFI_IFR_MATCH2_OP</b>	0x64	Push TRUE if string matches a Regular Expression pattern.
<b>EFI_IFR_GET_OP</b>	0x2B	Return a stored value.
<b>EFI_IFR_SET_OP</b>	0x2C	Change a stored value.
<b>EFI_IFR_READ_OP</b>	0x2D	Provides a value for the current question or default.
<b>EFI_IFR_WRITE</b>	0x2E	Change a value for the current question.
<b>EFI_IFR_EQUAL_OP</b>	0x2F	Push TRUE if two expressions are equal.
<b>EFI_IFR_NOT_EQUAL_OP</b>	0x30	Push TRUE if two expressions are not equal.
<b>EFI_IFR_GREATER_THAN_OP</b>	0x31	Push TRUE if one expression is greater than another expression.
<b>EFI_IFR_GREATER_EQUAL_OP</b>	0x32	Push TRUE if one expression is greater than or equal to another expression.
<b>EFI_IFR_LESS_THAN_OP</b>	0x33	Push TRUE if one expression is less than another expression.
<b>EFI_IFR_LESS_EQUAL_OP</b>	0x34	Push TRUE if one expression is less than or equal to another expression.



Opcode	Value	Description
<b>EFI_IFR_BITWISE_AND_OP</b>	0x35	Bitwise-AND two unsigned integers and push the result.
<b>EFI_IFR_BITWISE_OR_OP</b>	0x36	Bitwise-OR two unsigned integers and push the result.
<b>EFI_IFR_BITWISE_NOT_OP</b>	0x37	Bitwise-NOT an unsigned integer and push the result.
<b>EFI_IFR_SHIFT_LEFT_OP</b>	0x38	Shift an unsigned integer left by a number of bits and push the result.
<b>EFI_IFR_SHIFT_RIGHT_OP</b>	0x39	Shift an unsigned integer right by a number of bits and push the result.
<b>EFI_IFR_ADD_OP</b>	0x3A	Add two unsigned integers and push the result.
<b>EFI_IFR_SUBTRACT_OP</b>	0x3B	Subtract two unsigned integers and push the result.
<b>EFI_IFR_MULTIPLY_OP</b>	0x3C	Multiply two unsigned integers and push the result.
<b>EFI_IFR_DIVIDE_OP</b>	0x3D	Divide one unsigned integer by another and push the result.
<b>EFI_IFR_MODULO_OP</b>	0x3E	Divide one unsigned integer by another and push the remainder.
<b>EFI_IFR_RULE_REF_OP</b>	0x3F	Evaluate a rule
<b>EFI_IFR_QUESTION_REF1_OP</b>	0x40	Push a question's value
<b>EFI_IFR_QUESTION_REF2_OP</b>	0x41	Push a question's value
<b>EFI_IFR_UINT8_OP</b>	0x42	Push an 8-bit unsigned integer
<b>EFI_IFR_UINT16_OP</b>	0x43	Push a 16-bit unsigned integer.
<b>EFI_IFR_UINT32_OP</b>	0x44	Push a 32-bit unsigned integer
<b>EFI_IFR_UINT64_OP</b>	0x45	Push a 64-bit unsigned integer.
<b>EFI_IFR_TRUE_OP</b>	0x46	Push a boolean TRUE.
<b>EFI_IFR_FALSE_OP</b>	0x47	Push a boolean FALSE
<b>EFI_IFR_TO_UINT_OP</b>	0x48	Convert expression to an unsigned integer
<b>EFI_IFR_TO_STRING_OP</b>	0x49	Convert expression to a string
<b>EFI_IFR_TO_BOOLEAN_OP</b>	0x4A	Convert expression to a boolean.
<b>EFI_IFR_MID_OP</b>	0x4B	Extract portion of string or buffer
<b>EFI_IFR_FIND_OP</b>	0x4C	Find a string in a string.
<b>EFI_IFR_TOKEN_OP</b>	0x4D	Extract a delimited byte or character string from buffer or string.
<b>EFI_IFR_STRING_REF1_OP</b>	0x4E	Push a string
<b>EFI_IFR_STRING_REF2_OP</b>	0x4F	Push a string

Opcode	Value	Description
<b>EFI_IFR_CONDITIONAL_OP</b>	0x50	Duplicate one of two expressions depending on result of the first expression.
<b>EFI_IFR_QUESTION_REF3_OP</b>	0x51	Push a question's value from a different form.
<b>EFI_IFR_ZERO_OP</b>	0x52	Push a zero
<b>EFI_IFR_ONE_OP</b>	0x53	Push a one
<b>EFI_IFR_ONES_OP</b>	0x54	Push a 0xFFFFFFFFFFFFFFFF.
<b>EFI_IFR_UNDEFINED_OP</b>	0x55	Push Undefined
<b>EFI_IFR_LENGTH_OP</b>	0x56	Push length of buffer or string.
<b>EFI_IFR_DUP_OP</b>	0x57	Duplicate top of expression stack
<b>EFI_IFR_THIS_OP</b>	0x58	Push the current question's value
<b>EFI_IFR_SPAN_OP</b>	0x59	Return first matching/non-matching character in a string
<b>EFI_IFR_VALUE_OP</b>	0x5A	Provide a value for a question
<b>EFI_IFR_DEFAULT_OP</b>	0x5B	Provide a default value for a question.
<b>EFI_IFR_DEFAULTSTORE_OP</b>	0x5C	Define a Default Type Declaration
<b>EFI_IFR_FORM_MAP_OP</b>	0x5D	Create a standards-map form.
<b>EFI_IFR_CATENATE_OP</b>	0x5E	Push concatenated buffers or strings.
<b>EFI_IFR_GUID_OP</b>	0x5F	An extensible GUIDed op-code
<b>EFI_IFR_SECURITY_OP</b>	0x60	Returns whether current user profile contains specified setup access privileges.
<b>EFI_IFR_MODAL_TAG_OP</b>	0x61	Specify current form is modal
<b>EFI_IFR_REFRESH_ID_OP</b>	0x62	Establish an event group for refreshing a forms-based element.
<b>EFI_IFR_WARNING_IF</b>	0x63	Warning conditional

## Code Definitions

Each of the following sections gives a detailed description of the opcodes' behavior.

### 32.3.8.3.1 EFI\_IFR\_ACTION

#### Summary

Create an action button.

## Prototype

```
#define EFI_IFR_ACTION_OP 0x0C
typedef struct _EFI_IFR_ACTION {
    EFI_IFR_OP_HEADER  Header;
    EFI_IFR_QUESTION_HEADER Question;
    EFI_STRING_ID      QuestionConfig;
} EFI_IFR_ACTION;

typedef struct _EFI_IFR_ACTION_1 {
    EFI_IFR_OP_HEADER  Header;
    EFI_IFR_QUESTION_HEADER Question;
} _EFI_IFR_ACTION_1;
```

## Members

<i>Header</i>	The standard opcode header, where <i>Header.OpCode</i> = <b>EFI_IFR_ACTION_OP</b> .
<i>Question</i>	The standard question header. See <b>EFI_IFR_QUESTION_HEADER</b> ( <a href="#">Section 32.3.8.2.2</a> ) for more information.
<i>QuestionConfig</i>	The results string which is in <i>&lt;ConfigResp&gt;</i> format will be processed when the button is selected by the user.

## Description

Creates an action question. When the question is selected, the configuration string specified by *QuestionConfig* will be processed. If *QuestionConfig* is 0 or is not present, then no configuration string will be processed. This is useful when using an action button only for the callback.

If the question is marked read-only (see **EFI\_IFR\_QUESTION\_HEADER**) then the action question cannot be selected.

### 32.3.8.3.2 EFI\_IFR\_ANIMATION

## Summary

Creates an image for a statement or question.

## Prototype

```
#define EFI_IFR_ANIMATION_OP 0x1F
typedef struct _EFI_IFR_ANIMATION {
    EFI_IFR_OP_HEADER  Header;
    EFI_ANIMATION_ID  Id;
} EFI_IFR_ANIMATION;
```

## Members

<i>Header</i>	Standard opcode header, where <i>Header.OpCode</i> is <b>EFI_IFR_ANIMATION_OP</b>
---------------	---

*Id* Animation identifier in the HII database.

## Description

Associates an animation from the HII database with the current question, statement or form. If the specified animation does not exist in the HII database.

### 32.3.8.3.3 EFI\_IFR\_ADD

## Summary

Pops two unsigned integers, adds them and pushes the result.

## Prototype

```
#define EFI_IFR_ADD_OP 0x3a
typedef struct _EFI_IFR_ADD {
    EFI_IFR_OP_HEADER Header;
} EFI_IFR_ADD;
```

## Members

*Header* Standard opcode header, where *Header.OpCode = EFI\_IFR\_ADD\_OP*.

## Description

This opcode performs the following actions:

1. Pop two values from the expression stack. The first popped is the *right-hand* value. The second popped is the *left-hand* value.
2. If the two values do not evaluate to unsigned integers, push Undefined.
3. Zero-extend the *left-hand* and *right-hand* values to 64-bits.
4. Add the left-hand value to right-hand value.
5. Push the lower 64-bits of the result. Overflow is ignored.

### 32.3.8.3.4 EFI\_IFR\_AND

## Summary

Pops two booleans, push **TRUE** if both are **TRUE**, otherwise push **FALSE**.

## Prototype

```
#define EFI_IFR_AND_OP 0x15
typedef struct _EFI_IFR_AND {
    EFI_IFR_OP_HEADER Header;
} EFI_IFR_AND;
```

## Members

*Header* The standard opcode header, where *Header.OpCode = EFI\_IFR\_AND\_OP*.

## Description

This opcode performs the following actions:

1. Pop two expressions from the expression stack.
2. If the two expressions cannot be evaluated as boolean, push Undefined.
3. If both expressions evaluate to **TRUE**, then push **TRUE**. Otherwise, push **FALSE**.

### 32.3.8.3.5 EFI\_IFR\_BITWISE\_AND

## Summary

Pops two unsigned integers, perform bitwise AND and push the result.

## Prototype

```
#define EFI_IFR_BITWISE_AND_OP 0x35
typedef struct _EFI_IFR_BITWISE_AND {
    EFI_IFR_OP_HEADER Header;
} EFI_IFR_BITWISE_AND;
```

## Members

*Header*

The standard opcode header, where *Header.OpCode* = **EFI\_IFR\_BITWISE\_AND\_OP**.

## Description

This opcode performs the following actions:

1. Pop two expressions from the expression stack.
2. If the two expressions cannot be evaluated as unsigned integers, push Undefined.
3. Otherwise, zero-extend the unsigned integers to 64-bits.
4. Perform a bitwise-AND on the two values.
5. Push the result.

### 32.3.8.3.6 EFI\_IFR\_BITWISE\_NOT

## Summary

Pop an unsigned integer, perform a bitwise NOT and push the result.

## Prototype

```
#define EFI_IFR_BITWISE_NOT_OP 0x37
typedef struct _EFI_IFR_BITWISE_NOT {
    EFI_IFR_OP_HEADER Header;
} EFI_IFR_BITWISE_NOT;
```

## Members

*Header*

The standard opcode header, where *Header.OpCode* = **EFI\_IFR\_BITWISE\_NOT\_OP**.

## Description

This opcode performs the following actions:

1. Pop an expression from the expression stack.
2. If the expression cannot be evaluated as an unsigned integer, push Undefined.
3. Otherwise, zero-extend the unsigned integer to 64-bits.
4. Perform a bitwise-NOT on the value.
5. Push the result.

### 32.3.8.3.7 EFI\_IFR\_BITWISE\_OR

## Summary

Pops two unsigned integers, perform bitwise OR and push the result.

## Prototype

```
#define EFI_IFR_BITWISE_OR_OP 0x36
typedef struct _EFI_IFR_BITWISE_OR {
    EFI_IFR_OP_HEADER Header;
} EFI_IFR_BITWISE_OR;
```

## Members

*Header*

Standard opcode header, where *OpCode* is **EFI\_IFR\_BITWISE\_OR\_OP**.

## Description

This opcode performs the following actions:

1. Pop two expressions from the expression stack.
2. If the two expressions cannot be evaluated as unsigned integers, push Undefined.
3. Otherwise, zero-extend the unsigned integers to 64-bits.
4. Perform a bitwise-OR of the two values.
5. Push the result.

### 32.3.8.3.8 EFI\_IFR\_CATENATE

## Summary

Pops two buffers or strings, concatenates them and pushes the result.

## Prototype

```
#define EFI_IFR_CATENATE_OP 0x5e
typedef struct _EFI_IFR_CATENATE {
    EFI_IFR_OP_HEADER Header;
} EFI_IFR_CATENATE;
```

## Members

*Header*

Standard opcode header, where *OpCode* is **EFI\_IFR\_CATENATE\_OP**.

## Description

This opcode performs the following actions:

1. Pop two expressions from the expression stack. The first expression popped is the *left* value and the second value popped is the *right* value.
2. If the *left* or *right* values cannot be evaluated as a string or a buffer, push Undefined. If the *left* or *right* values are of different types, then push Undefined.
3. If the *left* and *right* values are strings, push a new string which contains the contents of the *left* string (without the NULL terminator) followed by the contents of the *right* string on to the expression stack.
4. If the *left* and *right* values are buffers, push a new buffer that contains the contents of the *left* buffer followed by the contents of the *right* buffer on to the expression stack.

### 32.3.8.3.9 EFI\_IFR\_CHECKBOX

## Summary

Creates a boolean checkbox.

## Prototype

```
#define EFI_IFR_CHECKBOX_OP 0x06
typedef struct _EFI_IFR_CHECKBOX {
    EFI_IFR_OP_HEADER Header;
    EFI_IFR_QUESTION_HEADER Question;
    UINT8 Flags;
} EFI_IFR_CHECKBOX;
```

## Members

*Header*

The standard question header, where *Header.OpCode* = **EFI\_IFR\_CHECKBOX\_OP**.

*Question*

The standard question header. See **EFI\_IFR\_QUESTION\_HEADER** ([Section 32.3.8.2.2](#)) for more information.

*Flags*

Flags that describe the behavior of the question. All undefined bits should be zero. See **EFI\_IFR\_CHECKBOX\_x** in "Related Definitions" for more information.

## Description

Creates a Boolean checkbox question and adds it to the current form. The checkbox has two values: **FALSE** if the box is not checked and **TRUE** if it is.

There are three ways to specify defaults for this question: the *Flags* field (lowest priority), one or more nested **EFI\_IFR\_ONE\_OF\_OPTION**, or nested **EFI\_IFR\_DEFAULT** (highest priority).

An image may be associated with the question using a nested **EFI\_IFR\_IMAGE**. An animation may be associated with the option using a nested **EFI\_IFR\_ANIMATION**.

## Related Definitions

```
#define EFI_IFR_CHECKBOX_DEFAULT 0x01
#define EFI_IFR_CHECKBOX_DEFAULT_MFG 0x02
```

### 32.3.8.3.10 EFI\_IFR\_CONDITIONAL

#### Summary

Pops two values and a boolean, pushes one of the values depending on the boolean.

#### Prototype

```
#define EFI_IFR_CONDITIONAL_OP 0x50
typedef struct _EFI_IFR_CONDITIONAL {
    EFI_IFR_OP_HEADER Header;
} EFI_IFR_CONDITIONAL;
```

#### Members

*Header* Standard opcode header, where *OpCode* is **EFI\_IFR\_CONDITIONAL\_OP**.

#### Description

This opcode performs the following actions:

1. Pop three values from the expression stack. The first value popped is the *right* value. The second expression popped is the middle value. The last expression popped is the *left* value.
2. If the *left* value cannot be evaluated as a boolean, push Undefined.
3. If the *left* expression evaluates to **TRUE**, push the *right* value.
4. Otherwise, push the middle value.

### 32.3.8.3.11 EFI\_IFR\_DATE

#### Summary

Create a date question.



## Prototype

```
#define EFI_IFR_DATE_OP 0x1A
typedef struct _EFI_IFR_DATE {
    EFI_IFR_OP_HEADER  Header;
    EFI_IFR_QUESTION_HEADER Question;
    UINT8              Flags;
} EFI_IFR_DATE;
```

## Members

*Header* The sequence that defines the type of opcode as well as the length of the opcode being defined. *Header.OpCode* = **EFI\_IFR\_DATE\_OP**.

*Question* The standard question header. See [Section 32.3.8.2.2](#) for more information.

*Flags* Flags that describe the behavior of the question. All undefined bits should be zero.

```
#define EFI_QF_DATE_YEAR_SUPPRESS 0x01
#define EFI_QF_DATE_MONTH_SUPPRESS 0x02
#define EFI_QF_DATE_DAY_SUPPRESS 0x04
#define EFI_QF_DATE_STORAGE 0x30
```

For **QF\_DATE\_STORAGE**, there are currently three valid values:

```
#define QF_DATE_STORAGE_NORMAL 0x00
#define QF_DATE_STORAGE_TIME 0x10
#define QF_DATE_STORAGE_WAKEUP 0x20
```

## Description

Create a Date question (see [Section 32.2.5.4.6](#)) and add it to the current form.

There are two ways to specify defaults for this question: one or more nested **EFI\_IFR\_ONE\_OF\_OPTION** (lowest priority) or nested **EFI\_IFR\_DEFAULT** (highest priority). An image may be associated with the option using a nested **EFI\_IFR\_IMAGE**. An animation may be associated with the question using a nested **EFI\_IFR\_ANIMATION**.

### 32.3.8.3.12 EFI\_IFR\_DEFAULT

## Summary

Provides a default value for the current question

## Prototype

```
#define EFI_IFR_DEFAULT_OP 0x5b
typedef struct _EFI_IFR_DEFAULT {
  EFI_IFR_OP_HEADER Header;
  UINT16  DefaultId;
  UINT8   Type;
  EFI_IFR_TYPE_VALUE Value;
} EFI_IFR_DEFAULT;

typedef struct _EFI_IFR_DEFAULT_2 {
  EFI_IFR_OP_HEADER Header;
  UINT16  DefaultId;
  UINT8   Type;
} EFI_IFR_DEFAULT_2;
```

## Members

<i>Header</i>	The sequence that defines the type of opcode as well as the length of the opcode being defined. For this tag, <i>Header.OpCode</i> = <b>EFI_IFR_DEFAULT_OP</b> .
<i>DefaultId</i>	Identifies the default store for this value. The default store must have previously been created using <b>EFI_IFR_DEFAULTSTORE</b> .
<i>Type</i>	The type of data in the <i>Value</i> field. See <b>EFI_IFR_TYPE_x</b> in <b>EFI_IFR_ONE_OF_OPTION</b> .
<i>Value</i>	The default value. The actual size of this field depends on <i>Type</i> . If <i>Type</i> is <b>EFI_IFR_TYPE_OTHER</b> , then the default value is provided by a nested <b>EFI_IFR_VALUE</b> .

## Description

This opcode specifies a default value for the current question. There are two forms. The first (**EFI\_IFR\_DEFAULT**) assumes that the default value is a constant, embedded directly in the Value member. The second (**EFI\_IFR\_DEFAULT\_2**) assumes that the default value is specified using a nested **EFI\_IFR\_VALUE** opcode.

### 32.3.8.3.13 EFI\_IFR\_DEFAULTSTORE

## Summary

Provides a declaration for the type of default values that a question can be associated with.

## Prototype

```
#define EFI_IFR_DEFAULTSTORE_OP 0x5c
typedef struct _EFI_IFR_DEFAULTSTORE {
    EFI_IFR_OP_HEADER Header;
    EFI_STRING_ID DefaultName;
    UINT16 DefaultId;
} EFI_IFR_DEFAULTSTORE;
```

## Members

<i>Header</i>	The sequence that defines the type of opcode as well as the length of the opcode being defined. For this tag, <i>Header.OpCode</i> = <b>EFI_IFR_DEFAULTSTORE_OP</b>
<i>DefaultName</i>	A string token reference for the human readable string associated with the type of default being declared.
<i>DefaultId</i>	The default identifier, which is unique within the current form set. The default identifier creates a group of defaults. See <a href="#">Section</a> for the default identifier ranges.

## Description

Declares a class of default which can then have question default values associated with. An **EFI\_IFR\_DEFAULTSTORE** with a specified *DefaultId* must appear in the IFR before it can be referenced by an **EFI\_IFR\_DEFAULT**.

### 32.3.8.3.14 EFI\_IFR\_DISABLE\_IF

## Summary

Disable all nested questions and expressions if the expression evaluates to **TRUE**.

## Prototype

```
#define EFI_IFR_DISABLE_IF_OP 0x1e
typedef struct _EFI_IFR_DISABLE_IF {
    EFI_IFR_OP_HEADER Header;
} EFI_IFR_DISABLE_IF;
```

## Members

<i>Header</i>	The byte sequence that defines the type of opcode as well as the length of the opcode being defined. <i>Header.OpCode</i> = <b>EFI_IFR_DISABLE_IF_OP</b> .
---------------	--

## Description

All nested statements, questions, options or expressions will not be processed if the expression appearing as the first nested object evaluates to TRUE. If the expression consists of more than a single opcode, then the first opcode in the expression must have the Scope bit set and the expression must end with **EFI\_IFR\_END**.

When this opcode appears under a form set, the expression must only rely on constants. When this opcode appears under a form, the expression may rely on question values in the same form which are not inside of an **EFI\_DISABLE\_IF** expression.

### 32.3.8.3.15 EFI\_IFR\_DIVIDE

#### Summary

Pops two unsigned integers, divide one by the other and pushes the result.

#### Prototype

```
#define EFI_IFR_DIVIDE_OP 0x3d
typedef struct _EFI_IFR_DIVIDE {
    EFI_IFR_OP_HEADER Header;
} EFI_IFR_DIVIDE;
```

#### Members

*Header*

Standard opcode header, where OpCode is **EFI\_IFR\_DIVIDE**.

#### Description

1. Pop two expressions from the expression stack. The first popped is the *right-hand* expression. The second popped is the *left-hand* expression.
2. If the two expressions do not evaluate to unsigned integers, push Undefined. If the *right-hand* expression is equal to zero, push Undefined.
3. Zero-extend the *left-hand* and *right-hand* expressions to 64-bits.
4. Divide the *left-hand* value to *right-hand* expression.
5. Push the result.

### 32.3.8.3.16 EFI\_IFR\_DUP

#### Summary

Duplicate the top value on the expression stack.

#### Prototype

```
#define EFI_IFR_DUP_OP 0x57
typedef struct _EFI_IFR_DUP {
    EFI_IFR_OP_HEADER Header;
} EFI_IFR_DUP;
```

#### Members

*Header*

Standard opcode header, where *OpCode* is **EFI\_IFR\_DUP\_OP**.

#### Description

Duplicate the top expression on the expression stack.

*Note:* This opcode is usually used as an optimization by the tools to help eliminate common sub-expression calculation and make smaller expressions.

### 32.3.8.3.17 EFI\_IFR\_END

#### Summary

End of the current scope.

#### Prototype

```
#define EFI_IFR_END_OP 0x29
typedef struct _EFI_IFR_END {
    EFI_IFR_OP_HEADER Header;
} EFI_IFR_END;
```

#### Members

*Header*

Standard opcode header, where *OpCode* is **EFI\_IFR\_END\_OP**.

#### Description

Marks the end of the current scope.

### 32.3.8.3.18 EFI\_IFR\_EQUAL

#### Summary

Pop two values, compare and push **TRUE** if equal, **FALSE** if not.

#### Prototype

```
#define EFI_IFR_EQUAL_OP 0x2f
typedef struct _EFI_IFR_EQUAL {
    EFI_IFR_OP_HEADER Header;
} EFI_IFR_EQUAL;
```

#### Members

*Header*

Standard opcode header, where *OpCode* is **EFI\_IFR\_EQUAL\_OP**.

#### Description

The opcode performs the following actions:

1. Pop two values from the expression stack.
2. If the two values are not strings, Booleans or unsigned integers, push Undefined.
3. If the two values are of different types, push Undefined.
4. Compare the two values. Strings are compared lexicographically.
5. If the two values are equal then push **TRUE** on the expression stack. If they are not equal, push **FALSE**.

## 32.3.8.3.19 EFI\_IFR\_EQ\_ID\_ID

**Summary**

Push **TRUE** if the two questions have the same value or **FALSE** if they are not equal.

**Prototype**

```
#define EFI_IFR_EQ_ID_ID_OP 0x13
typedef struct _EFI_IFR_EQ_ID_ID {
    EFI_IFR_OP_HEADER Header;
    EFI_QUESTION_ID QuestionId1;
    EFI_QUESTION_ID QuestionId2;
} EFI_IFR_EQ_ID_ID;
```

**Members**

<i>Header</i>	Standard opcode header, where <i>OpCode</i> is <b>EFI_IFR_EQ_ID_ID_OP</b> .
<i>QuestionId1, QuestionId2</i>	Specifies the identifier of the questions whose values will be compared.

**Description**

Evaluate the values of the specified questions (*QuestionId1, QuestionId2*). If the two values cannot be evaluated or cannot be converted to comparable types, then push Undefined. If they are equal, push **TRUE**. Otherwise push **FALSE**.

## 32.3.8.3.20 EFI\_IFR\_EQ\_ID\_VAL\_LIST

**Summary**

Push **TRUE** if the question's value appears in a list of unsigned integers.

**Prototype**

```
#define EFI_IFR_EQ_ID_VAL_LIST_OP 0x14
typedef struct _EFI_IFR_EQ_ID_VAL_LIST {
    EFI_IFR_OP_HEADER Header;
    EFI_QUESTION_ID QuestionId;
    UINT16 ListLength;
    UINT16 ValueList[1];
} EFI_IFR_EQ_ID_VAL_LIST;
```

**Members**

<i>Header</i>	Standard opcode header, where <i>OpCode</i> is <b>EFI_IFR_EQ_ID_VAL_LIST_OP</b> .
<i>QuestionId</i>	Specifies the identifier of the question whose value will be compared.
<i>ListLength</i>	Number of entries in <i>ValueList</i> .

*ValueList* Zero or more unsigned integer values to compare against.

### Description

Evaluate the value of the specified question (*QuestionId*). If the specified question cannot be evaluated as an unsigned integer, then push Undefined. If the value can be found in *ValueList*, then push **TRUE**. Otherwise push **FALSE**.

#### 32.3.8.3.21 EFI\_IFR\_EQ\_ID\_VAL

### Summary

Push TRUE if a question's value is equal to a 16-bit unsigned integer, otherwise FALSE.

### Prototype

```
#define EFI_IFR_EQ_ID_VAL_OP 0x12
typedef struct _EFI_IFR_EQ_ID_VAL {
    EFI_IFR_OP_HEADER Header;
    EFI_QUESTION_ID QuestionId;
    UINT16 Value;
} EFI_IFR_EQ_ID_VAL;
```

### Members

<i>Header</i>	<i>Standard opcode header, where OpCode is EFI_IFR_EQ_ID_VAL_OP.</i>
<i>QuestionId</i>	Specifies the identifier of the question whose value will be compared.
<i>Value</i>	Unsigned integer value to compare against.

### Description

Evaluate the value of the specified question (*QuestionId*). If the specified question cannot be evaluated as an unsigned integer, then push Undefined. If they are equal, push **TRUE**. Otherwise push **FALSE**.

#### 32.3.8.3.22 EFI\_IFR\_FALSE

### Summary

Push a **FALSE** on to the expression stack.

## Prototype

```
#define EFI_IFR_FALSE_OP 0x47
typedef struct _EFI_IFR_FALSE {
    EFI_IFR_OP_HEADER Header;
} EFI_IFR_FALSE;
```

## Members

*Header*

The sequence that defines the type of opcode as well as the length of the opcode being defined. For this tag, *Header.OpCode* = **EFI\_IFR\_FALSE\_OP**

## Description

Push a **FALSE** on to the expression stack.

### 32.3.8.3.23 EFI\_IFR\_FIND

## Summary

Pop two strings and an unsigned integer, find one string in the other and the index where found.

## Prototype

```
#define EFI_IFR_FIND_OP 0x4c
typedef struct _EFI_IFR_FIND {
    EFI_IFR_OP_HEADER Header;
    UINT8 Format;
} EFI_IFR_FIND;
```

## Members

*Header*

Standard opcode header, where *OpCode* is **EFI\_IFR\_FIND\_OP**.

*Format*

The following flags govern the matching criteria:

## Related Definitions

```
#define EFI_IFR_FF_CASE_SENSITIVE 0x00
#define EFI_IFR_FF_CASE_INSENSITIVE 0x01
```

## Description

This opcode performs the following actions:

1. Pop three expressions from the expression stack. The first expression popped is the *right-hand* value and the second value popped is the middle value and the last value popped is the *left-hand* value.
2. If the *left-hand* or *middle* values cannot be evaluated as a string, push Undefined. If the *third* expression cannot be evaluated as an unsigned integer, push Undefined.



3. The *left-hand* value is the string to search. The *middle* value is the string to compare with. The *right-hand* expression is the zero-based index of the search. I
4. If the string is found, push the zero-based index of the found string.
5. Otherwise, if the string is not found or the *right-hand* value specifies a value which is greater-than or equal to the length of the *left-hand* value's string, push 0xFFFFFFFFFFFFFFFF.

### 32.3.8.3.24 EFI\_IFR\_FORM

#### Summary

Creates a form.

#### Prototype

```
#define EFI_IFR_FORM_OP 0x01
typedef struct _EFI_IFR_FORM {
    EFI_IFR_OP_HEADER Header;
    EFI_FORM_ID FormId;
    EFI_STRING_ID FormTitle;
} EFI_IFR_FORM;
```

#### Members

<i>Header</i>	The sequence that defines the type of opcode as well as the length of the opcode being defined. <i>Header.OpCode = EFI_IFR_FORM_OP</i> .
<i>FormId</i>	The form identifier, which uniquely identifies the form within the form set. The form identifier, along with the device path and form set GUID, uniquely identifies a form within a system.
<i>FormTitle</i>	The string token reference to the title of this particular form.

#### Description

A form is the encapsulation of what amounts to a browser page. The header defines a *FormId*, which is referenced by the form set, among others. It also defines a *FormTitle*, which is a string to be used as the title for the form.

### 32.3.8.3.25 EFI\_IFR\_FORM\_MAP

#### Summary

Creates a standards map form.

## Prototype

```
#define EFI_IFR_FORM_MAP_OP 0x5D
typedef struct _EFI_IFR_FORM_MAP_METHOD {
    EFI_STRING_ID    MethodTitle;
    EFI_GUID         MethodIdentifier;
} EFI_IFR_FORM_MAP_METHOD;

typedef struct _EFI_IFR_FORM_MAP {
    EFI_IFR_OP_HEADER    Header;
    EFI_FORM_ID          FormId;
    //EFI_IFR_FORM_MAP_METHOD    Methods[];
} EFI_IFR_FORM_MAP;
```

## Parameters

<i>Header</i>	The sequence that defines the type of opcode as well as the length of the opcode being defined. <i>Header.OpCode</i> = <b>EFI_IFR_FORM_MAP_OP</b> .
<i>FormId</i>	The unique identifier for this particular form.
<i>Methods</i>	One or more configuration method's name and unique identifier.
<i>MethodTitle</i>	The string identifier which provides the human-readable name of the configuration method for this standards map form.
<i>MethodIdentifier</i>	Identifier which uniquely specifies the configuration methods associated with this standards map form. See "Related Definitions" for current identifiers.

## Description

A standards map form describes how the configuration settings are represented for a configuration method identified by *MethodIdentifier*. It also defines a *FormTitle*, which is a string to be used as the title for the form.

## Related Definitions

```
#define EFI_HII_STANDARD_FORM_GUID \
    { 0x3bd2f4ec, 0xe524, 0x46e4, \
      { 0xa9, 0xd8, 0x51, 0x01, 0x17, 0x42, 0x55, 0x62 } }
```

An **EFI\_IFR\_FORM\_MAP** where the method identifier is **EFI\_HII\_STANDARD\_FORM\_GUID** is semantically identical to a normal **EFI\_IFR\_FORM**.

### 32.3.8.3.26 EFI\_IFR\_FORM\_SET

## Summary

The form set is a collection of forms that are intended to describe the pages that will be displayed to the user.

## Prototype

```
#define EFI_IFR_FORM_SET_OP 0x0E

typedef struct _EFI_IFR_FORM_SET {
  EFI_IFR_OP_HEADER Header;
  EFI_GUID Guid;
  EFI_STRING_ID FormSetTitle;
  EFI_STRING_ID Help;
  UINT8 Flags;
  //EFI_GUID ClassGuid[...];
} EFI_IFR_FORM_SET;
```

## Members

<i>Header</i>	The sequence that defines the type of opcode as well as the length of the opcode being defined. <i>Header.OpCode</i> = <b>EFI_IFR_FORM_SET_OP</b> .
<i>Guid</i>	The unique GUID value associated with this particular form set. Type <b>EFI_GUID</b> is defined in <b>InstallProtocolInterface()</b> in this specification.
<i>FormSetTitle</i>	The string token reference to the title of this particular form set.
<i>Help</i>	The string token reference to the help of this particular form set.
<i>Flags</i>	Flags which describe additional features of the form set. Bits 0:1 = number of members in <i>ClassGuid</i> . Bits 2:7 = Reserved. Should be set to zero.
<i>ClassGuid</i>	Zero to three class identifiers. The standard class identifiers are described in <b>EFI_HII_FORM_BROWSER2_PROTOCOL.SendForm()</b> . They do not need to be unique in the form set.

## Description

The form set consists of a header and zero or more forms.

### 32.3.8.3.27 EFI\_IFR\_GET

#### Summary

Return a stored value.

## Prototype

```
#define EFI_IFR_GET_OP 0x2B
typedef struct _EFI_IFR_GET {
  EFI_IFR_OP_HEADER Header;
  EFI_VARSTORE_ID VarStoreId;
  union {
    EFI_STRING_ID VarName;
    UINT16 VarOffset;
  } VarStoreInfo;
  UINT8 VarStoreType;
} EFI_IFR_GET;
```

## Parameters

<i>Header</i>	The sequence that defines the type of opcode as well as the length of the opcode being defined. <i>Header.OpCode</i> = <b>EFI_IFR_GET_OP</b> .
<i>VarStoreId</i>	Specifies the identifier of a previously declared variable store to use when retrieving the value.
<i>VarStoreInfo</i>	Depending on the type of variable store selected, this contains either a 16-bit Buffer Storage offset ( <i>VarOffset</i> ) or a Name/Value or EFI Variable name ( <i>VarName</i> ).
<i>VarStoreType</i>	Specifies the type used for storage. The storage types <b>EFI_IFR_TYPE_x</b> are defined in <i>EFI_IFR_ONE_OF_OPTION</i> .

## Description

This operator takes the value from storage and pushes it on to the expression stack. If the value could not be retrieved from storage, then **Undefined** is pushed on to the expression stack.

The type of value retrieved from storage depends on the setting of *VarStoreType*, as described in the following table:

Table 217. VarStoreType Descriptions

<i>VarStoreType</i>	Storage Description
<b>EFI_IFR_TYPE_NUM_SIZE_8</b>	8-bit unsigned integer
<b>EFI_IFR_TYPE_NUM_SIZE_16</b>	16-bit unsigned integer
<b>EFI_IFR_TYPE_NUM_SIZE_32</b>	32-bit unsigned integer
<b>EFI_IFR_TYPE_NUM_SIZE_64</b>	64-bit unsigned integer
<b>EFI_IFR_TYPE_BOOLEAN</b>	8-bit boolean (0 = false, 1 = true)
<b>EFI_IFR_TYPE_TIME</b>	<b>EFI_HII_TIME</b>
<b>EFI_IFR_TYPE_DATE</b>	<b>EFI_HII_DATE</b>
<b>EFI_IFR_TYPE_STRING</b>	Null-terminated string
<b>EFI_IFR_TYPE_OTHER</b>	Invalid
<b>EFI_IFR_TYPE_ACTION</b>	Null-Terminated string
<b>EFI_IFR_TYPE_UNDEFINED</b>	Invalid
<b>EFI_IFR_TYPE_BUFFER</b>	Buffer
<b>EFI_IFR_TYPE_REF</b>	<b>EFI_HII_REF</b>

### 32.3.8.3.28 EFI\_IFR\_GRAY\_OUT\_IF

#### Summary

Creates a group of statements or questions which are conditionally grayed-out.

#### Prototype

```
#define EFI_IFR_GRAY_OUT_IF_OP 0x19
typedef struct _EFI_IFR_GRAY_OUT_IF {
    EFI_IFR_OP_HEADER Header;
} EFI_IFR_GRAY_OUT_IF;
```

#### Members

*Header*

The byte sequence that defines the type of opcode as well as the length of the opcode being defined.

*Header.OpCode* = **EFI\_IFR\_GRAY\_OUT\_IF\_OP**.

#### Description

All nested statements or questions will be grayed out (not selectable and visually distinct) if the expression appearing as the first nested object evaluates to **TRUE**. If the expression consists of more than a single opcode, then the first opcode in the expression must have the Scope bit set and the expression must end with **EFI\_IFR\_END**.

Different browsers may support this option to varying degrees. For example, HTML has no similar construct so it may not support this facility.

### 32.3.8.3.29 EFI\_IFR\_GREATER\_EQUAL

#### Summary

Pop two values, compare, push **TRUE** if first is greater than or equal the second, otherwise push **FALSE**.

#### Prototype

```
#define EFI_IFR_GREATER_EQUAL_OP 0x32
typedef struct _EFI_IFR_GREATER_EQUAL {
    EFI_IFR_OP_HEADER Header;
} EFI_IFR_GREATER_EQUAL;
```

#### Members

*Header* Standard opcode header, where *OpCode* is **EFI\_IFR\_GREATER\_EQUAL\_OP**.

#### Description

This opcode performs the following actions:

1. Pop two values from the expression stack. The first value popped is the *right-hand* value and the second value popped is the *left-hand* value.
2. If the two values do not evaluate to string, boolean or unsigned integer, push Undefined.
3. If the two values do not evaluate to the same type, push Undefined.
4. Compare the two values. Strings are compared lexicographically.
5. If the *left-hand* value is greater than or equal to the *right-hand* value, push **TRUE**. Otherwise push **FALSE**.

### 32.3.8.3.30 EFI\_IFR\_GREATER\_THAN

#### Summary

Pop two values, compare, push **TRUE** if first is greater than the second, otherwise push **FALSE**.

#### Prototype

```
#define EFI_IFR_GREATER_THAN_OP 0x31
typedef struct _EFI_IFR_GREATER_THAN {
    EFI_IFR_OP_HEADER Header;
} EFI_IFR_GREATER_THAN;
```

#### Members

*Header* Standard opcode header, where *OpCode* is **EFI\_IFR\_GREATER\_THAN\_OP**

## Description

This opcode performs the following actions:

1. Pop two values from the expression stack. The first value popped is the *right-hand* value and the second value popped is the *left-hand* value.
2. If the two values do not evaluate to string, boolean or unsigned integer, push Undefined.
3. If the two values do not evaluate to the same type, push Undefined.
4. Compare the two values. Strings are compared lexicographically.
5. If the *left-hand* value is greater than the *right-hand* value, push **TRUE**. Otherwise push **FALSE**.

### 32.3.8.3.31 EFI\_IFR\_GUID

#### Summary

A GUIDed operation. This op-code serves as an extensible op-code which can be defined by the Guid value to have various functionality. It should be noted that IFR browsers or scripts which cannot interpret the meaning of this GUIDed op-code will skip it.

#### Prototype

```
#define EFI_IFR_GUID_OP 0x5F
typedef struct _EFI_IFR_GUID {
    EFI_IFR_OP_HEADER Header;
    EFI_GUID Guid;
    //Optional Data Follows
} EFI_IFR_GUID;
```

#### Parameters

*Header*

The sequence that defines the type of opcode as well as the length of the opcode being defined. For this tag, *Header.OpCode = EFI\_IFR\_GUID\_OP*

*Guid*

The GUID value for this op-code. This field is intended to define a particular type of special-purpose function, and the format of the data which immediately follows the Guid field (if any) is defined by that particular GUID.

### 32.3.8.3.32 EFI\_IFR\_IMAGE

#### Summary

Creates an image for a statement or question.

## Prototype

```
#define EFI_IFR_IMAGE_OP 0x04
typedef struct _EFI_IFR_IMAGE {
    EFI_IMAGE_ID    Id;
} EFI_IFR_IMAGE;
```

## Members

*Id* Image identifier in the HII database.

## Description

Specifies the image within the HII database.

### 32.3.8.3.33 EFI\_IFR\_INCONSISTENT\_IF

## Summary

Creates a validation expression and error message for a question.

## Prototype

```
#define EFI_IFR_INCONSISTENT_IF_OP 0x011
typedef struct _EFI_IFR_INCONSISTENT_IF {
    EFI_IFR_OP_HEADER  Header;
    EFI_STRING_ID      Error;
} EFI_IFR_INCONSISTENT_IF;
```

## Members

*Header* The byte sequence that defines the type of opcode as well as the length of the opcode being defined.  
*Header.OpCode* = **EFI\_IFR\_INCONSISTENT\_IF\_OP**.

*Error* The string token reference to the string that will be used for the consistency check message.

## Description

This tag uses a Boolean expression to allow the IFR creator to check options in a richer manner than provided by the question tags themselves. For example, this tag might be used to validate that two options are not using the same address or that the numbers that were entered align to some pattern (such as leap years and February in a date input field). The tag provides a string to be used in a error display to alert the user to the issue. Inconsistency tags will be evaluated when the user traverses from tag to tag. The user should not be allowed to submit the results of a form inconsistency.

### 32.3.8.3.34 EFI\_IFR\_LENGTH

## Summary

Pop a string or buffer, push its length.



## Prototype

```
#define EFI_IFR_LENGTH_OP 0x56
typedef struct _EFI_IFR_LENGTH {
    EFI_IFR_OP_HEADER Header;
} EFI_IFR_LENGTH;
```

## Members

*Header*

Standard opcode header, where *OpCode* is **EFI\_IFR\_LENGTH\_OP**.

## Description

This opcode performs the following actions:

1. Pop a value from the expression stack.
2. If the value cannot be evaluated as a buffer or string, then push Undefined.
3. If the value can be evaluated as a buffer, push the length of the buffer, in bytes.
4. If the value can be evaluated as a string, push the length of the string, in characters.

### 32.3.8.3.35 EFI\_IFR\_LESS\_EQUAL

## Summary

Pop two values, compare, push **TRUE** if first is less than or equal to the second, otherwise push **FALSE**.

## Prototype

```
#define EFI_IFR_LESS_EQUAL_OP 0x34
typedef struct _EFI_IFR_LESS_EQUAL {
    EFI_IFR_OP_HEADER Header;
} EFI_IFR_LESS_EQUAL;
```

## Members

*Header*

Standard opcode header, where *OpCode* is **EFI\_IFR\_LESS\_EQUAL\_OP**.

## Description

This opcode performs the following actions:

1. Pop two values from the expression stack. The first value popped is the *right-hand* value and the second value popped is the *left-hand* value.
2. If the two values do not evaluate to string, boolean or unsigned integer, push Undefined.
3. If the two values do not evaluate to the same type, push Undefined.
4. Compare the two values. Strings are compared lexicographically.
5. If the *left-hand* value is less than or equal to the *right-hand* value, push **TRUE**. Otherwise push **FALSE**.

### 32.3.8.3.36 EFI\_IFR\_LESS\_THAN

#### Summary

Pop two values, compare, push **TRUE** if the first is less than the second, otherwise push **FALSE**.

#### Prototype

```
#define EFI_IFR_LESS_THAN_OP 0x33
typedef struct _EFI_IFR_LESS_THAN {
    EFI_IFR_OP_HEADER    Header;
} EFI_IFR_LESS_THAN;
```

#### Members

*Header*

Standard opcode header, where *OpCode* is **EFI\_IFR\_LESS\_THAN\_OP**.

#### Description

This opcode performs the following actions:

1. Pop two values from the expression stack. The first value popped is the *right-hand* value and the second value popped is the *left-hand* value.
2. If the two values do not evaluate to string, boolean or unsigned integer, push Undefined.
3. If the two values do not evaluate to the same type, push Undefined.
4. Compare the two values. Strings are compared lexicographically.
5. If the *left-hand* value is less than the *right-hand* value, push **TRUE**. Otherwise push **FALSE**.

### 32.3.8.3.37 EFI\_IFR\_LOCKED

#### Summary

Specifies that the statement or question is locked.

#### Prototype

```
#define EFI_IFR_LOCKED_OP 0x0B
typedef struct _EFI_IFR_LOCKED {
    EFI_IFR_OP_HEADER    Header;
} EFI_IFR_LOCKED;
```

#### Parameters

*Header*

Standard opcode header, where *Header.OpCode* is **EFI\_IFR\_LOCKED\_OP**.

#### Members

None

## Description

The presence of **EFI\_IFR\_LOCKED** indicates that the statement or question should not be modified by a Forms Editor.

### 32.3.8.3.38 EFI\_IFR\_MAP

## Summary

Pops value, compares against an array of comparison values, pushes the corresponding result value.

## Prototype

```
#define EFI_IFR_MAP_OP 0x22
typedef struct _EFI_IFR_MAP {
    EFI_IFR_OP_HEADER Header;
} EFI_IFR_MAP;
```

## Parameters

*Header*

The sequence that defines the type of opcode as well as the length of the opcode being defined. For this tag, *Header.OpCode = EFI\_IFR\_MAP\_OP*

## Description

This operator contains zero or more expression pairs nested within its scope. Each expression pair contains a *match expression* and a *return expression*.

This opcode performs the following actions:

1. This operator pops a single value from the expression stack.
2. Compare this value against the evaluated result of each of the *match expressions*.
3. If there is a match, then the evaluated result of the corresponding *return expression* is pushed on to the expression stack.
4. If there is no match, then Undefined is pushed.

### 32.3.8.3.39 EFI\_IFR\_MATCH

## Summary

Pop a source string and a pattern string, push **TRUE** if the source string matches the pattern specified by the pattern string, otherwise push **FALSE**.

## Prototype

```
#define EFI_IFR_MATCH_OP 0x2a
typedef struct _EFI_IFR_MATCH {
    EFI_IFR_OP_HEADER Header;
} EFI_IFR_MATCH;
```

## Members

*Header* Standard opcode header, where *Header.Opcode* is **EFI\_IFR\_MATCH\_OP**.

## Description

1. Pop two values from the expression stack. The first value popped is the *string* and the second value popped is the *pattern*.
2. If the *string* or the *pattern* cannot be evaluated as a string, then push Undefined.
3. Process the *string* and *pattern* using the **MetaMatch** function of the **EFI\_UNICODE\_COLLATION2\_PROTOCOL**.
4. If the result is **TRUE**, then push **TRUE**.
5. If the result is **FALSE**, then push **FALSE**.

### 32.3.8.3.40 EFI\_IFR\_MID

## Summary

Pop a string or buffer and two unsigned integers, push an extracted portion of the string or buffer.

## Prototype

```
#define EFI_IFR_MID_OP 0x4b
typedef struct _EFI_IFR_MID {
    EFI_IFR_OP_HEADER Header;
} EFI_IFR_MID;
```

## Members

*Header* Standard opcode header, where *OpCode* is **EFI\_IFR\_MID\_OP**.

## Description

1. Pop three values from the expression stack. The first value popped is the *right* value and the second value popped is the *middle* value and the last expression popped is the *left* value.
2. If the *left* value cannot be evaluated as a string or a buffer, push Undefined. If the *middle* or *right* value cannot be evaluated as unsigned integers, push Undefined.
3. If the *left* value is a string, then the *middle* value is the 0-based index of the first character in the string to extract and the *right* value is the length of the string to extract. If the *right* value is zero or the *middle* value is greater than or equal the string's length, then push an Empty string. Push the extracted string on the expression

stack. If the *right* value would cause extraction to extend beyond the end of the string, then only the characters up to and include the last character of the string are in the pushed result.

4. If the *left* value is a buffer, then the *middle* value is the 0-based index of the first byte in the buffer to extract and the *right* value is the length of the buffer to extract. If the *right* value is zero or the *middle* value is greater than the buffer's length, then push an empty buffer. Push the extracted buffer on the expression stack. If the *right* value would cause extraction to extend beyond the end of the buffer, then only the bytes up to and include the last byte of the buffer are in the pushed result.

### 32.3.8.3.41 EFI\_IFR\_MODAL\_TAG

#### Summary

Specify that the current form is a modal form.

#### Prototype

```
#define EFI_IFR_MODAL_TAG_OP 0x61
typedef struct _EFI_IFR_MODAL_TAG {
    EFI_IFR_OP_HEADER Header;
} EFI_IFR_MODAL_TAG;
```

#### Members

*Header*

Standard opcode header, where *OpCode* is **EFI\_IFR\_MODAL\_TAG\_OP**.

#### Description

When this opcode is present within the scope of a form, the form is modal; if the opcode is not present, the form is not modal.

A "modal" form is one that requires specific user interaction before it is deactivated. Examples of modal forms include error messages or confirmation dialogs.

When a modal form is activated, it is also selected. A modal form is deactivated only when one of the following occurs:

- The user chooses a "Navigate To Form" behavior (defined in [Section 32.2.10.1.2](#), "Selected Form"). Note that this is distinct from the "Navigate Forms" behavior.
- A question in the form requires callback, and the callback returns one of the following ActionRequest values (defined in **EFI\_HII\_CONFIG\_ACCESS\_PROTOCOL.CallBack()**):
  - **EFI\_BROWSER\_ACTION\_REQUEST\_RESET**
  - **EFI\_BROWSER\_ACTION\_REQUEST\_SUBMIT**
  - **EFI\_BROWSER\_ACTION\_REQUEST\_EXIT**
  - **EFI\_BROWSER\_ACTION\_REQUEST\_FORM\_SUBMIT\_EXIT**
  - **EFI\_BROWSER\_ACTION\_REQUEST\_FORM\_DISCARD\_EXIT**

A modal form cannot be deactivated using other navigation behaviors, including:

- Navigate Forms
- Exit Browser/Discard All (except when initiated by a callback as indicated above)

- Exit Browser/Submit All (except when initiated by a callback as indicated above)
- Exit Browser/Discard All/Reset Platform (except when initiated by a callback as indicated above)

### 32.3.8.3.42 EFI\_IFR\_MODULO

#### Summary

Pop two unsigned integers, divide one by the other and push the remainder.

#### Prototype

```
#define EFI_IFR_MODULO_OP 0x3e
typedef struct _EFI_IFR_MODULO {
    EFI_IFR_OP_HEADER Header;
} EFI_IFR_MODULO;
```

#### Members

*Header* Standard opcode header, where *OpCode* is **EFI\_IFR\_MODULO\_OP**.

#### Description

This opcode performs the following actions:

1. Pop two values from the expression stack. The first value popped is the *right-hand* value and the second value popped is the *left-hand* value.
2. If the two values do not evaluate to unsigned integers, push Undefined. If the *right-hand* value to 0, push Undefined.
3. Zero-extend the values to 64-bits. Then, divide the *left-hand* value by the *right-hand* value.
4. Push the difference between the *left-hand* value and the product of the *right-hand* value and the calculated quotient.

### 32.3.8.3.43 EFI\_IFR\_MULTIPLY

#### Summary

Multiply one unsigned integer by another and push the result.

#### Prototype

```
#define EFI_IFR_MULTIPLY_OP 0x3c
typedef struct _EFI_IFR_MULTIPLY {
    EFI_IFR_OP_HEADER Header;
} EFI_IFR_MULTPLY;
```

#### Members

Header Standard opcode header, where *OpCode* is **EFI\_IFR\_MULTIPLY\_OP**.

## Description

This opcode performs the following actions:

1. Pop two values from the expression stack. The first value popped is the *right-hand* expression and the second value popped is the *left-hand* expression.
2. If the two values do not evaluate to unsigned integers, push Undefined.
3. Zero-extend the values to 64-bits. Then, multiply the *right-hand* value by the *left-hand* value. Push the lower 64-bits of the result.

### 32.3.8.3.44 EFI\_IFR\_NOT

## Summary

Pop a boolean and, if **TRUE**, push **FALSE**. If **FALSE**, push **TRUE**.

## Prototype

```
#define EFI_IFR_NOT_OP 0x17
typedef struct _EFI_IFR_NOT {
    EFI_IFR_OP_HEADER Header;
} EFI_IFR_NOT;
```

## Members

*Header*

The sequence that defines the type of opcode as well as the length of the opcode being defined. *Header.OpCode* = **EFI\_IFR\_NOT\_OP**.

## Description

This opcode performs the following actions:

1. Pop one value from the expression stack.
2. If the value cannot be evaluated as a Boolean, push Undefined.
3. If the value evaluates to **TRUE**, then push **FALSE**. Otherwise, push **TRUE**.

### 32.3.8.3.45 EFI\_IFR\_NOT\_EQUAL

## Summary

Pop two values, compare and push **TRUE** if not equal, otherwise push **FALSE**.

## Prototype

```
#define EFI_IFR_NOT_EQUAL_OP 0x30
typedef struct _EFI_IFR_NOT_EQUAL {
    EFI_IFR_OP_HEADER Header;
} EFI_IFR_NOT_EQUAL;
```

## Members

*Header*

Standard opcode header, where *OpCode* is **EFI\_IFR\_NOT\_EQUAL\_OP**.

## Description

This opcode performs the following actions:

1. Pop two values from the expression stack.
2. If the two values are not strings, Booleans or unsigned integers, push Undefined.
3. If the two values are of different types, push Undefined.
4. Compare the two values. Strings are compared lexicographically.
5. If the two values are not equal then push **TRUE** on the expression stack. If they are equal, push **FALSE**.

### 32.3.8.3.46 EFI\_IFR\_NO\_SUBMIT\_IF

#### Summary

Creates a validation expression and error message for a question.

#### Prototype

```
#define EFI_IFR_NO_SUBMIT_IF_OP 0x10
typedef struct _EFI_IFR_NO_SUBMIT_IF {
    EFI_IFR_OP_HEADER  Header;
    EFI_STRING_ID      Error;
} EFI_IFR_NO_SUBMIT_IF;
```

#### Members

*Header*

The byte sequence that defines the type of opcode as well as the length of the opcode being defined.  
*Header.OpCode = EFI\_IFR\_NO\_SUBMIT\_IF\_OP.*

*Error*

The string token reference to the string that will be used for the consistency check message.

#### Description

Creates a conditional expression which will be evaluated when the form is submitted. If the conditional evaluates to TRUE, then the error message Error will be displayed to the user and the user will be prevented from submitting the form.

### 32.3.8.3.47 EFI\_IFR\_NUMERIC

#### Summary

Creates a number question.



## Prototype

```
#define EFI_IFR_NUMERIC_OP 0x07
typedef struct _EFI_IFR_NUMERIC {
    EFI_IFR_OP_HEADER Header;
    EFI_IFR_QUESTION_HEADER Question;
    UINT8 Flags;

    union {
        struct {
            UINT8 MinValue;
            UINT8 MaxValue;
            UINT8 Step;
        } u8;
        struct {
            UINT16 MinValue;
            UINT16 MaxValue;
            UINT16 Step;
        } u16;
        struct {
            UINT32 MinValue;
            UINT32 MaxValue;
            UINT32 Step;
        } u32;
        struct {
            UINT64 MinValue;
            UINT64 MaxValue;
            UINT64 Step;
        } u64;
    } data;
} EFI_IFR_NUMERIC;
```

## Members

<i>Header</i>	The sequence that defines the type of opcode as well as the length of the opcode being defined. <i>Header.OpCode</i> = <b>EFI_IFR_NUMERIC_OP</b> .
<i>Question</i>	The standard question header. See <a href="#">Section 32.3.8.2.2</a> for more information.
<i>Flags</i>	Specifies flags related to the numeric question. See “Related Definitions”
<i>MinValue</i>	The minimum value to be accepted by the browser for this opcode. The size of the data field may vary from 8 to 64 bits.

<i>MaxValue</i>	The maximum value to be accepted by the browser for this opcode. The size of the data field may vary from 8 to 64 bits.
<i>Step</i>	Defines the amount to increment or decrement the value each time a user requests a value change. If the step value is 0, then the input mechanism for the numeric value is to be free-form and require the user to type in the actual value. The size of the data field may vary from 8 to 64 bits.

## Description

Creates a number question on the current form, with built-in error checking and default information. The storage size depends on the **EFI\_IFR\_NUMERIC\_SIZE** portion of the *Flags* field.

There are two ways to specify defaults for this question: one or more nested **EFI\_IFR\_ONE\_OF\_OPTION** (lowest priority) or nested **EFI\_IFR\_DEFAULT** (highest priority). An image may be associated with the option using a nested **EFI\_IFR\_IMAGE**. An animation may be associated with the question using a nested **EFI\_IFR\_ANIMATION**.

## Related Definitions

```
#define EFI_IFR_NUMERIC_SIZE  0x03
#define EFI_IFR_NUMERIC_SIZE_1 0x00
#define EFI_IFR_NUMERIC_SIZE_2 0x01
#define EFI_IFR_NUMERIC_SIZE_4 0x02
#define EFI_IFR_NUMERIC_SIZE_8 0x03

#define EFI_IFR_DISPLAY  0x30
#define EFI_IFR_DISPLAY_INT_DEC  0x00
#define EFI_IFR_DISPLAY_UINT_DEC 0x10
#define EFI_IFR_DISPLAY_UINT_HEX 0x20
```

EFI_IFR_NUMERIC_SIZE	Specifies the size of the numeric value, the storage required and the size of the <i>MinValue</i> , <i>MaxValue</i> and <i>Step</i> values in the opcode header.
EFI_IFR_DISPLAY	The value will be displayed in signed decimal, unsigned decimal or unsigned hexadecimal. Input is still allowed in any form.

**Note:** *IFR expressions do not support signed types (see [Section 32.2.5.7.4 Data Types](#)). The value of a numeric question is treated during expression evaluation as an unsigned integer even if **EFI\_IFR\_DISPLAY\_INT\_DEC** flag is specified. However, the **EFI\_IFR\_DISPLAY\_INT\_DEC** flag is taken into consideration while validating question's current or default value against *MinValue* and *MaxValue*. When **EFI\_IFR\_DISPLAY\_INT\_DEC** flag is specified, forms*

*processor must treat **MinValue**, **MaxValue**, current question value, and default question value as signed integers.*

### 32.3.8.3.48 EFI\_IFR\_ONE

#### Summary

Push a one on to the expression stack.

#### Prototype

```
#define EFI_IFR_ONE_OP 0x53
typedef struct _EFI_IFR_ONE {
    EFI_IFR_OP_HEADER Header;
} EFI_IFR_ONE;
```

#### Members

*Header*

The sequence that defines the type of opcode as well as the length of the opcode being defined. For this tag, *Header.OpCode = **EFI\_IFR\_ONE\_OP***

#### Description

Push a one on to the expression stack.

### 32.3.8.3.49 EFI\_IFR\_ONES

#### Summary

Push 0xFFFFFFFFFFFFFFFF on to the expression stack.

#### Prototype

```
#define EFI_IFR_ONES_OP 0x54
typedef struct _EFI_IFR_ONES {
    EFI_IFR_OP_HEADER Header;
} EFI_IFR_ONES;
```

#### Members

*Header*

The sequence that defines the type of opcode as well as the length of the opcode being defined. For this tag, *Header.OpCode = **EFI\_IFR\_ONES\_OP***

#### Description

Push 0xFFFFFFFFFFFFFFFF on to the expression stack.

## 32.3.8.3.50 EFI\_IFR\_ONE\_OF

**Summary**

Creates a select-one-of question.

**Prototype**

```
#define EFI_IFR_ONE_OF_OP 0x05

typedef struct _EFI_IFR_ONE_OF {
  EFI_IFR_OP_HEADER  Header;
  EFI_IFR_QUESTION_HEADER Question;
  UINT8              Flags;

  union {
    struct {
      UINT8  MinValue;
      UINT8  MaxValue;
      UINT8  Step;
    } u8;
    struct {
      UINT16 MinValue;
      UINT16 MaxValue;
      UINT16 Step;
    } u16;
    struct {
      UINT32 MinValue;
      UINT32 MaxValue;
      UINT32 Step;
    } u32;
    struct {
      UINT64 MinValue;
      UINT64 MaxValue;
      UINT64 Step;
    } u64;
  } data;
} EFI_IFR_ONE_OF;
```

**Members**

*Header*

The sequence that defines the type of opcode as well as the length of the opcode being defined. *Header.OpCode = EFI\_IFR\_ONE\_OF\_OP*.

*Question*

The standard question header. See [Section 32.3.8.2.2](#) for more information.

*Flags*

Specifies flags related to the numeric question. See “Related Definitions” in **EFI\_IFR\_NUMERIC**.

<i>MinValue</i>	The minimum value to be accepted by the browser for this opcode. The size of the data field may vary from 8 to 64 bits, depending on the size specified in <i>Flags</i>
<i>MaxValue</i>	The maximum value to be accepted by the browser for this opcode. The size of the data field may vary from 8 to 64 bits, depending on the size specified in <i>Flags</i>
<i>Step</i>	Defines the amount to increment or decrement the value each time a user requests a value change. If the step value is 0, then the input mechanism for the numeric value is to be free-form and require the user to type in the actual value. The size of the data field may vary from 8 to 64 bits, depending on the size specified in <b>Flags</b>

## Description

This opcode creates a select-on-of object, where the user must select from one of the nested options. This is identical to **EFI\_IFR\_NUMERIC**.

There are two ways to specify defaults for this question: one or more nested **EFI\_IFR\_ONE\_OF\_OPTION** (lowest priority) or nested **EFI\_IFR\_DEFAULT** (highest priority). An image may be associated with the option using a nested **EFI\_IFR\_IMAGE**. An animation may be associated with the question using a nested **EFI\_IFR\_ANIMATION**.

### 32.3.8.3.51 EFI\_IFR\_ONE\_OF\_OPTION

## Summary

Creates a pre-defined option for a question.

## Prototype

```
#define EFI_IFR_ONE_OF_OPTION_OP 0x09
typedef struct _EFI_IFR_ONE_OF_OPTION {
    EFI_IFR_OP_HEADER  Header;
    EFI_STRING_ID      Option;
    UINT8              Flags;
    UINT8              Type;
    EFI_IFR_TYPE_VALUE Value;
} EFI_IFR_ONE_OF_OPTION;
```

## Members

<i>Header</i>	The sequence that defines the type of opcode as well as the length of the opcode being defined. <i>Header.OpCode</i> = <b>EFI_IFR_ONE_OF_OPTION_OP</b> .
<i>Option</i>	The string token reference to the option description string for this particular opcode.
<i>Flags</i>	Specifies the flags associated with the current option. See <b>EFI_IFR_OPTION_x</b> .
<i>Type</i>	Specifies the type of the option's value. See <b>EFI_IFR_TYPE</b> .

*Value*

The union of all of the different possible values. The actual contents (and size) of the field depends on *Type*.

## Related Definitions

```
typedef union {
  UINT8  u8; // EFI_IFR_TYPE_NUM_SIZE_8
  UINT16 u16; // EFI_IFR_TYPE_NUM_SIZE_16
  UINT32 u32; // EFI_IFR_TYPE_NUM_SIZE_32
  UINT64 u64; // EFI_IFR_TYPE_NUM_SIZE_64
  BOOLEAN b; // EFI_IFR_TYPE_BOOLEAN
  EFI_HII_TIME time; // EFI_IFR_TYPE_TIME
  EFI_HII_DATE date; // EFI_IFR_TYPE_DATE
  EFI_STRING_ID string; // EFI_IFR_TYPE_STRING, EFI_IFR_TYPE_ACTION
  EFI_HII_REF ref; // EFI_IFR_TYPE_REF
  // UINT8 buffer[]; // EFI_IFR_TYPE_BUFFER
} EFI_IFR_TYPE_VALUE;
```

```
typedef struct {
  UINT8 Hour;
  UINT8 Minute;
  UINT8 Second;
} EFI_HII_TIME;
```

```
typedef struct {
  UINT16 Year;
  UINT8 Month;
  UINT8 Day; //
} EFI_HII_DATE;
```

```
typedef struct {
  EFI_QUESTION_ID QuestionId;
  EFI_FORM_ID FormId;
  EFI_GUID FormSetGuid;
  EFI_STRING_ID DevicePath;
} EFI_HII_REF;
```

```
#define EFI_IFR_TYPE_NUM_SIZE_8 0x00
#define EFI_IFR_TYPE_NUM_SIZE_16 0x01
#define EFI_IFR_TYPE_NUM_SIZE_32 0x02
#define EFI_IFR_TYPE_NUM_SIZE_64 0x03
#define EFI_IFR_TYPE_BOOLEAN 0x04
#define EFI_IFR_TYPE_TIME 0x05
#define EFI_IFR_TYPE_DATE 0x06
#define EFI_IFR_TYPE_STRING 0x07
#define EFI_IFR_TYPE_OTHER 0x08
```

```
#define EFI_IFR_TYPE_UNDEFINED 0x09
#define EFI_IFR_TYPE_ACTION 0x0A
#define EFI_IFR_TYPE_BUFFER 0x0B
#define EFI_IFR_TYPE_REF 0x0C

#define EFI_IFR_OPTION_DEFAULT 0x10
#define EFI_IFR_OPTION_DEFAULT_MFG 0x20
```

## Description

Create a selection for use in any of the questions.

The value is encoded within the opcode itself, unless **EFI\_IFR\_TYPE\_OTHER** is specified, in which case the value is determined by a nested **EFI\_IFR\_VALUE**.

An image may be associated with the option using a nested **EFI\_IFR\_IMAGE**. An animation may be associated with the question using a nested **EFI\_IFR\_ANIMATION**.

### 32.3.8.3.52 EFI\_IFR\_OR

#### Summary

Pop two Booleans, push **TRUE** if either is **TRUE**. Otherwise push **FALSE**.

#### Prototype

```
#define EFI_IFR_OR_OP 0x16
typedef struct _EFI_IFR_OR {
    EFI_IFR_OP_HEADER Header;
} EFI_IFR_OR;
```

#### Members

*Header*

The sequence that defines the type of opcode as well as the length of the opcode being defined. *Header.OpCode* = **EFI\_IFR\_OR\_OP**.

#### Description

This opcode performs the following actions:

1. Pop two values from the expression stack.
2. If either value does not evaluate as a Boolean, then push Undefined.
3. If either value evaluates to **TRUE**, then push **TRUE**. Otherwise, push **FALSE**.

### 32.3.8.3.53 EFI\_IFR\_ORDERED\_LIST

#### Summary

Creates a set question using an ordered list.

## Prototype

```
#define EFI_IFR_ORDERED_LIST_OP 0x23

typedef struct _EFI_IFR_ORDERED_LIST {
    EFI_IFR_OP_HEADER  Header;
    EFI_IFR_QUESTION_HEADER Question;
    UINT8              MaxContainers;
    UINT8              Flags;
} EFI_IFR_ORDERED_LIST;
```

## Members

<i>Header</i>	The byte sequence that defines the type of opcode as well as the length of the opcode being defined. <i>Header.OpCode</i> = <b>EFI_IFR_ORDERED_LIST_OP</b> .
<i>Question</i>	The standard question header. See <a href="#">Section 32.3.8.2.2</a> for more information.
<i>MaxContainers</i>	The maximum number of entries for which this tag will maintain an order. This value also identifies the size of the storage associated with this tag's ordering array.
<i>Flags</i>	A bit-mask that determines which unique settings are active for this opcode.

## Description

Create an ordered list question in the current form. One thing to note is that valid values for the options in ordered lists should never be a 0. The value of 0 is used to determine if a particular "slot" in the array is empty. Therefore, if in the previous example 3 was followed by a 4 and then followed by a 0, the valid options to be displayed would be 3 and 4 only.

An image may be associated with the option using a nested **EFI\_IFR\_IMAGE**. An animation may be associated with the question using a nested **EFI\_IFR\_ANIMATION**.

## Related Definitions

```
#define EFI_IFR_UNIQUE_SET 0x01
#define EFI_IFR_NO_EMPTY_SET 0x02
```

These flags determine whether all entries in the list must be unique (**EFI\_IFR\_UNIQUE\_SET**) and whether there can be any empty items in the ordered list (**EFI\_IFR\_NO\_EMPTY\_SET**).

### 32.3.8.3.54 EFI\_IFR\_PASSWORD

#### Summary

Creates a password question



## Prototype

```
#define EFI_IFR_PASSWORD_OP 0x08
typedef struct _EFI_IFR_PASSWORD {
    EFI_IFR_OP_HEADER    Header;
    EFI_IFR_QUESTION_HEADER Question;
    UINT16                MinSize;
    UINT16                MaxSize;
} EFI_IFR_PASSWORD;
```

## Members

<i>Header</i>	The sequence that defines the type of opcode as well as the length of the opcode being defined. <i>Header.OpCode</i> = <b>EFI_IFR_PASSWORD_OP</b> .
<i>Question</i>	The standard question header. See <a href="#">Section 32.3.8.2.2</a> for more information.
<i>MinSize</i>	The minimum number of characters that can be accepted for this opcode.
<i>MaxSize</i>	The maximum number of characters that can be accepted for this opcode.

## Description

Creates a password question in the current form.

An image may be associated with the option using a nested **EFI\_IFR\_IMAGE**. An animation may be associated with the question using a nested **EFI\_IFR\_ANIMATION**. The password question has two modes of operation. The first is when the Header.Flags has the **EFI\_IFR\_FLAG\_CALLBACK** bit not set. If the bit isn't set, the browser will handle all password operations itself, including string comparisons as needed. If the password question has the **EFI\_IFR\_FLAG\_CALLBACK** bit set, then there will be a formal handshake initiated between the browser and the registered driver that would accept the callback. See the flowchart represented in [Figure 133](#) and [Figure 134](#) for details.

(This flowchart is provided in two parts because of page formatting but should be viewed as a single continuous chart.)

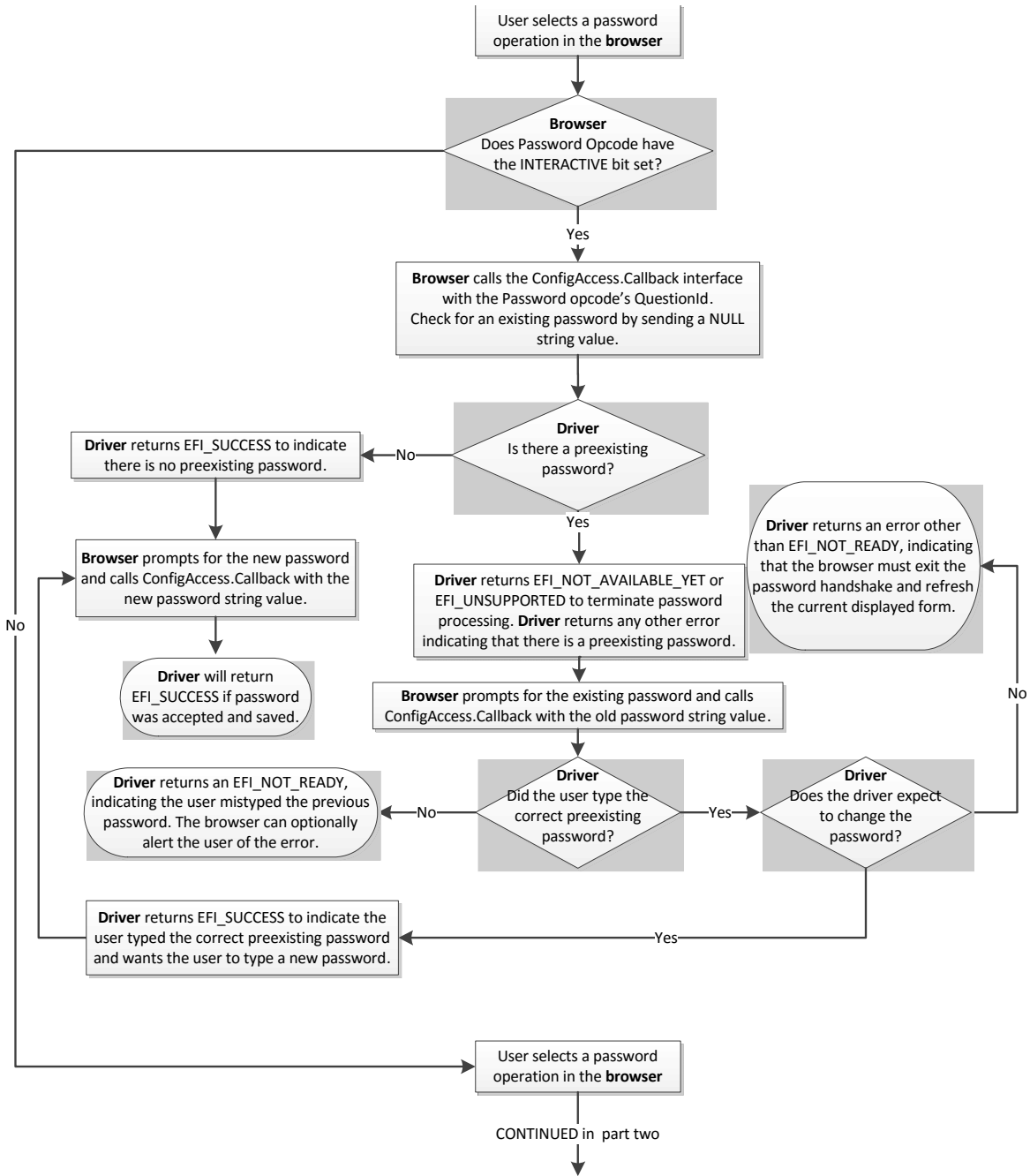

Figure 133. Password Flowchart (part one)

*CONTINUED FROM part one:*  
 "User selects a password operation in the **browser**"

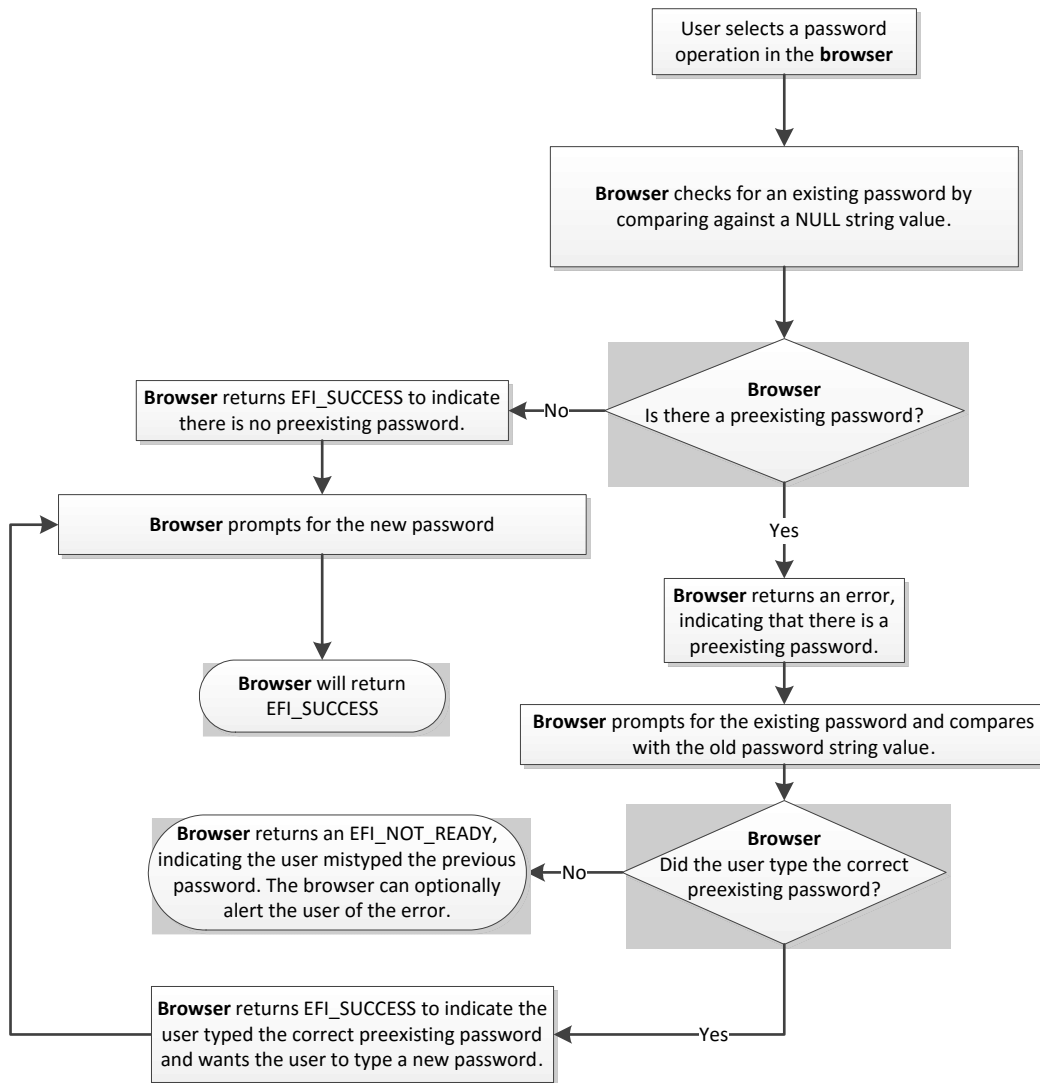

Figure 134. Password Flowchart (part two)

32.3.8.3.55 EFI\_IFR\_QUESTION\_REF1

**Summary**

Push a question's value on the expression stack.

## Prototype

```
#define EFI_IFR_QUESTION_REF1_OP 0x40
typedef struct _EFI_IFR_QUESTION_REF1 {
    EFI_IFR_OP_HEADER    Header;
    EFI_QUESTION_ID      QuestionId;
} EFI_IFR_QUESTION_REF1;
```

## Members

<i>Header</i>	The byte sequence that defines the type of opcode as well as the length of the opcode being defined. <i>Header.OpCode</i> = <b>EFI_IFR_QUESTION_REF1_OP</b> .
<i>QuestionId</i>	The question's identifier, which must be unique within the form set.

## Description

Push the value of the question specified by *QuestionId* on to the expression stack. If the question's value cannot be determined or the question does not exist, then push Undefined.

### 32.3.8.3.56 EFI\_IFR\_QUESTION\_REF2

## Summary

Pop an integer from the expression stack, convert it to a question id, and push the question value associated with that question id onto the expression stack.

## Prototype

```
#define EFI_IFR_QUESTION_REF2_OP 0x41
typedef struct _EFI_IFR_QUESTION_REF2 {
    EFI_IFR_OP_HEADER    Header;
} EFI_IFR_QUESTION_REF2;
```

## Members

<i>Header</i>	The byte sequence that defines the type of opcode as well as the length of the opcode being defined. <i>Header.OpCode</i> = <b>EFI_IFR_QUESTION_REF2_OP</b> .
---------------	--

## Description

This opcode performs the following actions:

1. Pop an integer from the expression stack
2. Convert it to a question id
3. Push the question value associated with that question id onto the expression stack.

If the popped expression cannot be evaluated as an unsigned integer or the value of the unsigned integer is greater than 0xFFFF, then push Undefined onto the expression stack in step 3. If the value of the question specified by the unsigned integer, after converted to

a question id, cannot be determined or the question does not exist, also push Undefined onto the expression stack in step 3.

### 32.3.8.3.57 EFI\_IFR\_QUESTION\_REF3

#### Summary

Pop an integer from the expression stack, convert it to a question id, and push the question value associated with that question id onto the expression stack.

#### Prototype

```
#define EFI_IFR_QUESTION_REF3_OP 0x51
typedef struct _EFI_IFR_QUESTION_REF3 {
    EFI_IFR_OP_HEADER  Header;
} EFI_IFR_QUESTION_REF3;

typedef struct _EFI_IFR_QUESTION_REF3_2 {
    EFI_IFR_OP_HEADER  Header;
    EFI_STRING_ID      DevicePath;
} EFI_IFR_QUESTION_REF3_2;

typedef struct _EFI_IFR_QUESTION_REF3_3 {
    EFI_IFR_OP_HEADER  Header;
    EFI_STRING_ID      DevicePath;
    EFI_GUID           Guid;
} EFI_IFR_QUESTION_REF3_3;
```

#### Members

<i>Header</i>	The byte sequence that defines the type of opcode as well as the length of the opcode being defined. <i>Header.OpCode</i> = <b>EFI_IFR_QUESTION_REF3_OP</b> .
<i>DevicePath</i>	Specifies the text representation of the device path containing the form set where the question is defined. If this is not present or the value is 0 then the device path installed on the <b>EFI_HANDLE</b> which was registered with the form set containing the current question is used.
<i>Guid</i>	Specifies the GUID of the form set where the question is defined. If the value is Nil or this field is not present, then the current form set is used (if <i>DevicePath</i> is 0) or the only form set attached to the device path specified by <i>DevicePath</i> is used. If the value is Nil and there is more than one form set on the specified device path, then the value Undefined will be pushed.

#### Description

This opcode performs the following actions:

1. Pop an integer from the expression stack

2. Convert it to a question id
3. Push the question value associated with that question id onto the expression stack.

If the popped expression cannot be evaluated as an unsigned integer or the value of the unsigned integer is greater than 0xFFFF, then push Undefined onto the expression stack in step 3. If the value of the question specified by the unsigned integer, after converted to a question id, cannot be determined or the question does not exist, also push Undefined onto the expression stack in step 3.

This version allows question values from other forms to be referenced in expressions.

### 32.3.8.3.58 EFI\_IFR\_READ

#### Summary

Provides a value for the current question or default.

#### Prototype

```
#define EFI_IFR_READ_OP 0x2D
typedef struct _EFI_IFR_READ {
    EFI_IFR_OP_HEADER  Header;
} EFI_IFR_READ;
```

#### Parameters

*Header*

The sequence that defines the type of opcode as well as the length of the opcode being defined. For this tag, *Header.OpCode* = **EFI\_IFR\_READ\_OP**

#### Description

After reading the value for the current question (if any storage was specified) and setting the *this* constant (see **EFI\_IFR\_THIS**), this expression will be evaluated (if present) to return the value. If the *FormId* and *QuestionId* are either both not present, or are both set to zero, then the link does nothing.

### 32.3.8.3.59 EFI\_IFR\_REF

#### Summary

Creates a cross-reference statement.

## Prototype

```
#define EFI_IFR_REF_OP 0x0F
typedef struct _EFI_IFR_REF {
    EFI_IFR_OP_HEADER Header;
    EFI_IFR_QUESTION_HEADER Question;
    EFI_FORM_ID FormId;
} EFI_IFR_REF;
```

```
typedef struct _EFI_IFR_REF2 {
    EFI_IFR_OP_HEADER Header;
    EFI_IFR_QUESTION_HEADER Question;
    EFI_FORM_ID FormId;
    EFI_QUESTION_ID QuestionId;
} EFI_IFR_REF2;
```

```
typedef struct _EFI_IFR_REF3 {
    EFI_IFR_OP_HEADER Header;
    EFI_IFR_QUESTION_HEADER Question;
    EFI_FORM_ID FormId;
    EFI_QUESTION_ID QuestionId;
    EFI_GUID FormSetId;
} EFI_IFR_REF3;
```

```
typedef struct _EFI_IFR_REF4 {
    EFI_IFR_OP_HEADER Header;
    EFI_IFR_QUESTION_HEADER Question;
    EFI_FORM_ID FormId;
    EFI_QUESTION_ID QuestionId;
    EFI_GUID FormSetId;
    EFI_STRING_ID DevicePath;
} EFI_IFR_REF4;
```

```
typedef struct _EFI_IFR_REF5 {
    EFI_IFR_OP_HEADER Header;
    EFI_IFR_QUESTION_HEADER Question;
} EFI_IFR_REF5;
```

## Members

<i>Header</i>	The byte sequence that defines the type of opcode as well as the length of the opcode being defined. <i>Header.OpCode</i> = <b>EFI_IFR_REF_OP</b> .
<i>Question</i>	Standard question header. See <a href="#">Section 32.3.8.2.2</a>
<i>FormId</i>	The form to which this link is referring. If this is zero, then the link is on the current form. If this is missing, then the link is determined by the nested <b>EFI_IFR_VALUE</b> .

<i>QuestionId</i>	The question on the form to which this link is referring. If this field is not present (determined by the length of the opcode) or the value is zero, then the link refers to the top of the form.
<i>FormSetId</i>	The form set to which this link is referring. If it is all zeroes or not present, and <i>DevicePath</i> is not present, then the link is to the current form set. If it is all zeroes (or not present) and the <i>DevicePath</i> is present, then the link is to the first form set associated with the <i>DevicePath</i> .
<i>DevicePath</i>	The string identifier that specifies the string containing the text representation of the device path to which the form set containing the form specified by <i>FormId</i> . If this field is not present (determined by the opcode's length) or the value is zero, then the link refers to the current page. The format of the device path string that this field references is compatible with the Text format that is specified in the Text Device Node Reference ( <a href="#">Section 10.6.1.6</a> )

## Description

Creates a user-selectable link to a form or a question on a form. There are several forms of this opcode which are distinguished by the length of the opcode.

### 32.3.8.3.60 EFI\_IFR\_REFRESH

## Summary

Mark a question for periodic refresh.

## Prototype

```
#define EFI_IFR_REFRESH_OP 0x1d
typedef struct _EFI_IFR_REFRESH {
    EFI_IFR_OP_HEADER Header;
    UINT8 RefreshInterval;
} EFI_IFR_REFRESH;
```

## Members

<i>Header</i>	The byte sequence that defines the type of opcode as well as the length of the opcode being defined. <i>Header.OpCode</i> = <b>EFI_IFR_REFRESH_OP</b> .
<i>RefreshInterval</i>	Minimum number of seconds before the question value should be refreshed. A value of zero indicates the question should not be refreshed automatically.



## Description

When placed within the scope of a question, it will force the question's value to be refreshed at least every *RefreshInterval* seconds. The value may be refreshed less often, depending on browser policy or capabilities.

### 32.3.8.3.61 EFI\_IFR\_REFRESH\_ID

## Summary

Mark an Question for an asynchronous refresh.

## Prototype

```
#define EFI_IFR_REFRESH_ID_OP 0x62
typedef struct _EFI_IFR_REFRESH_ID {
    EFI_IFR_OP_HEADER Header;
    EFI_GUID RefreshEventGroupId;
} EFI_IFR_REFRESH_ID;
```

## Members

*Header*

The byte sequence that defines the type of opcode as well as the length of the opcode being defined.  
*Header.OpCode = EFI\_IFR\_REFRESH\_ID\_OP.*

*RefreshEventGroupId*

The GUID associated with the event group which will be used to initiate a re-evaluation of an element in a set of forms.

## Description

This tag op-code must be placed within the scope of a question or a form. If within the scope of a question and the event is signaled which belongs to the *RefreshEventGroupId*, the question will be refreshed. More than one question may share the same Event Group.

If the tag op-code is placed within the scope of an **EFI\_IFR\_FORM** op-code and the event is signaled which belongs to the *RefreshEventGroupId*, the entire form's contents will be refreshed.

- If the contents within a form had an **EFI\_IFR\_REFRESH\_ID** tag op-code placed within the scope of the form, and an event is signalled, all questions associated with the *RefreshEventGroupId* are marked for refresh. The Forms Browser will update the question value from storage, reparse the forms from the HII database and, at some time later, reflect that change if the question is displayed.

When interpreting this op-code, a browser must do the following actions:

- The browser will create an event group via CreateEventEx() based on the specified *RefreshEventGroupId* when the form set which contains the op-code is opened by the browser.

- When an event is signaled, all questions associated with the *RefreshEventGroupId* are marked for refresh. The Forms Browser will update the question value from storage and, at some time later, update the question's display.
- The browser will close the event group which was previously created when the form set which contains the op-code is closed by the browser.

### 32.3.8.3.62 EFI\_IFR\_RESET\_BUTTON

#### Summary

Create a reset or submit button on the current form.

#### Prototype

```
#define EFI_IFR_RESET_BUTTON_OP 0x0d
typedef struct _EFI_IFR_RESET_BUTTON {
    EFI_IFR_OP_HEADER    Header;
    EFI_IFR_STATEMENT_HEADER Statement;
    EFI_DEFAULT_ID    DefaultId;
} EFI_IFR_RESET_BUTTON;
```

```
typedef UINT16 EFI_DEFAULT_ID;
```

#### Members

<i>Header</i>	The standard header, where <i>Header.OpCode</i> = <b>EFI_IFR_RESET_BUTTON_OP</b> .
<i>Statement</i>	Standard statement header, including the prompt and help text.
<i>DefaultId</i>	Specifies the set of default store to use when restoring the defaults to the questions on this form. See <b>EFI_IFR_DEFAULTSTORE</b> ( <a href="#">Section 32.3.8.3.13</a> ) for more information.

#### Description

This opcode creates a user-selectable button that resets the question values for all questions on the current form to the default values specified by *DefaultId*. If **EFI\_IFR\_FLAGS\_CALLBACK** is set in the question header, then the callback associated with the form set will be called. An image may be associated with the statement using a nested **EFI\_IFR\_IMAGE**. An animation may be associated with the statement using a nested **EFI\_IFR\_ANIMATION**.

### 32.3.8.3.63 EFI\_IFR\_RULE

#### Summary

Create a rule for use in a form and associate it with an identifier.

## Prototype

```
#define EFI_IFR_RULE_OP 0x18
typedef struct _EFI_IFR_RULE {
    EFI_IFR_OP_HEADER Header;
    UINT8 RuleId;
} EFI_IFR_RULE;
```

## Members

*Header*

The byte sequence that defines the type of opcode as well as the length of the opcode being defined.

*Header.OpCode* = **EFI\_IFR\_RULE\_OP**.

*RuleId*

Unique identifier for the rule. There can only one rule within a form with the specified *RuleId*. If another already exists, then the form is marked as invalid.

## Description

Create a rule, which associates an expression with an identifier and attaches it to the currently opened form. These rules allow common sub-expressions to be re-used within a form.

### 32.3.8.3.64 EFI\_IFR\_RULE\_REF

## Summary

Evaluate a form rule and push its result on the expression stack.

## Prototype

```
#define EFI_IFR_RULE_REF_OP 0x3f
typedef struct _EFI_IFR_RULE_REF {
    EFI_IFR_OP_HEADER Header;
    UINT8 RuleId;
} EFI_IFR_RULE_REF;
```

## Members

*Header*

The byte sequence that defines the type of opcode as well as the length of the opcode being defined.

*Header.OpCode* = **EFI\_IFR\_RULE\_REF\_OP**.

*RuleId*

The rule's identifier, which must be unique within the form.

## Description

Look up the rule specified by *RuleId* and push the evaluated result on the expression stack. If the specified rule does not exist, then push Undefined.

### 32.3.8.3.65 EFI\_IFR\_SECURITY

#### Summary

Push **TRUE** if the current user profile contains the specified setup access permissions.

#### Prototype

```
#define EFI_IFR_SECURITY_OP 0x60
typedef struct _EFI_IFR_SECURITY {
    EFI_IFR_OP_HEADER Header;
    EFI_GUID Permissions;
} EFI_IFR_SECURITY;
```

#### Members

<i>Header</i>	Standard opcode header, where <i>Header.Op</i> = <b>EFI_IFR_SECURITY_OP</b> .
<i>Permissions</i>	Security permission level.

#### Description

This opcode pushes whether or not the current user profile contains the specified setup access permissions. This opcode can be used in expressions to disable, suppress or gray-out forms, statements and questions. It can also be used in checking question values to disallow or allow certain values.

This opcode performs the following actions:

1. If the current user profile contains the specified setup access permissions, then push **TRUE**. Otherwise, push **FALSE**.

### 32.3.8.3.66 EFI\_IFR\_SET

#### Summary

Change a stored value.

## Prototype

```
#define EFI_IFR_SET_OP 0x2C
typedef struct _EFI_IFR_SET {
    EFI_IFR_OP_HEADER Header;
    EFI_VARSTORE_ID VarStoreId;
    union {
        EFI_STRING_ID VarName;
        UINT16 VarOffset;
    } VarStoreInfo;
    UINT8 VarStoreType;
} EFI_IFR_SET;
```

## Parameters

<i>Header</i>	The sequence that defines the type of opcode as well as the length of the opcode being defined. <i>Header.OpCode</i> = <b>EFI_IFR_SET_OP</b> .
<i>VarStoreId</i>	Specifies the identifier of a previously declared variable store to use when storing the question's value.
<i>VarStoreInfo</i>	Depending on the type of variable store selected, this contains either a 16-bit Buffer Storage offset ( <i>VarOffset</i> ) or a Name/Value or EFI Variable name ( <i>VarName</i> ).
<i>VarStoreType</i>	Specifies the type used for storage. The storage types <b>EFI_IFR_TYPE_x</b> are defined in <b>EFI_IFR_ONE_OF_OPTION</b> .

## Description

This operator pops an expression from the expression stack. The expression popped is the *value*.

The value is stored into the variable store identified by *VarStoreId* and *VarStoreInfo*.

If the value could be stored successfully, then **TRUE** is pushed on to the expression stack. Otherwise, **FALSE** is pushed on the expression stack.

### 32.3.8.3.67 EFI\_IFR\_SHIFT\_LEFT

## Summary

Pop two unsigned integers, shift one left by the number of bits specified by the other and push the result.

## Prototype

```
#define EFI_IFR_SHIFT_LEFT_OP 0x38
typedef struct _EFI_IFR_SHIFT_LEFT {
    EFI_IFR_OP_HEADER Header;
} EFI_IFR_SHIFT_LEFT;
```

## Members

*Header*

Standard opcode header, where *OpCode* is **EFI\_IFR\_SHIFT\_LEFT\_OP**.

## Description

This opcode performs the following actions:

1. Pop two values from the expression stack. The first value popped is the *right-hand* value and the second value popped is the *left-hand* value.
2. If the two values do not evaluate to unsigned integers, push Undefined.
3. Shift the *left-hand* value left by the number of bits specified by the *right-hand* value and push the result.

### 32.3.8.3.68 EFI\_IFR\_SHIFT\_RIGHT

## Summary

Pop two unsigned integers, shift one right by the number of bits specified by the other and push the result.

## Prototype

```
#define EFI_IFR_SHIFT_RIGHT_OP 0x39
typedef struct _EFI_IFR_SHIFT_RIGHT {
    EFI_IFR_OP_HEADER Header;
} EFI_IFR_SHIFT_RIGHT;
```

## Members

*Header*

Standard opcode header, where *OpCode* is **EFI\_IFR\_SHIFT\_RIGHT\_OP**.

## Description

This opcode performs the following actions:

1. Pop two values from the expression stack. The first value popped is the *right-hand* value and the second value popped is the *left-hand* value.
2. If the two values do not evaluate to unsigned integers, push Undefined.
3. Shift the *left-hand* value right by the number of bits specified by the *right-hand* value and push the result.

### 32.3.8.3.69 EFI\_IFR\_SPAN

#### Summary

Pop two strings and an unsigned integer, find the first character from one string that contains characters found in another and push its index.

#### Prototype

```
#define EFI_IFR_SPAN_OP 0x59
typedef struct _EFI_IFR_SPAN {
    EFI_IFR_OP_HEADER Header;
    UINT8    Flags;
} EFI_IFR_SPAN;
```

#### Members

*Header*

The sequence that defines the type of opcode as well as the length of the opcode being defined. For this tag, *Header.OpCode* = **EFI\_IFR\_SPAN\_OP**.

*Flags*

Specifies whether to find the first matching string (**EFI\_IFR\_FLAGS\_FIRST\_MATCHING**) or the first non-matching string (**EFI\_IFR\_FLAGS\_FIRST\_NON\_MATCHING**).

#### Description

This opcode performs the following actions:

1. Pop three values from the expression stack. The first value popped is the *right* value and the second value popped is the *middle* value and the last value popped is the *left* expression.
2. If the *left* or *middle* values cannot be evaluated as a string, push Undefined. If the *right* value cannot be evaluated as an unsigned integer, push Undefined.
3. The *left* string is the string to scan. The *middle* string consists of character pairs representing the low-end of a range and the high-end of a range of characters. The *right* unsigned integer represents the starting location for the scan.
4. The operation will push the zero-based index of the first character after the *right* value which falls within any one of the ranges (**EFI\_IFR\_FLAGS\_FIRST\_MATCHING**) or falls within none of the ranges (**EFI\_IFR\_FLAGS\_FIRST\_NON\_MATCHING**).

#### Related Definitions

```
#define EFI_IFR_FLAGS_FIRST_MATCHING 0x00
#define EFI_IFR_FLAGS_FIRST_NON_MATCHING 0x01
```

### 32.3.8.3.70 EFI\_IFR\_STRING

#### Summary

Defines the string question.

## Prototype

```
#define EFI_IFR_STRING_OP 0x1C
typedef struct _EFI_IFR_STRING {
    EFI_IFR_OP_HEADER  Header;
    EFI_IFR_QUESTION_HEADER  Question;
    UINT8      MinSize;
    UINT8      MaxSize;
    UINT8      Flags;
} EFI_IFR_STRING;
```

## Members

<i>Header</i>	The sequence that defines the type of opcode as well as the length of the opcode being defined. <i>Header.OpCode = EFI_IFR_STRING_OP.</i>
<i>Question</i>	The standard question header. See <a href="#">Section 32.3.8.2.2</a> for more information.
<i>MinSize</i>	The minimum number of characters that can be accepted for this opcode.
<i>MaxSize</i>	The maximum number of characters that can be accepted for this opcode.
<i>Flags</i>	Flags which control the string editing behavior. See “Related Definitions” below.

## Description

This creates a string question. The minimum length is *MinSize* and the maximum length is *MaxSize* characters.

An image may be associated with the question using a nested **EFI\_IFR\_IMAGE**. An animation may be associated with the question using a nested **EFI\_IFR\_ANIMATION**.

There are two ways to specify defaults for this question: one or more nested **EFI\_IFR\_ONE\_OF\_OPTION** (lowest priority) or nested **EFI\_IFR\_DEFAULT** (highest priority).

If **EFI\_IFR\_STRING\_MULTI\_LINE** is set, it is a hint to the Forms Browser that multi-line text can be allowed. If it is clear, then multi-line editing should not be allowed.

## Related Definitions

```
#define EFI_IFR_STRING_MULTI_LINE 0x01
```

### 32.3.8.3.71 EFI\_IFR\_STRING\_REF1

## Summary

Push a string on the expression stack.



## Prototype

```
#define EFI_IFR_STRING_REF1_OP 0x4e
typedef struct _EFI_IFR_STRING_REF1 {
    EFI_IFR_OP_HEADER  Header;
    EFI_STRING_ID      StringId;
} EFI_IFR_STRING_REF1;
```

## Members

*Header*

The byte sequence that defines the type of opcode as well as the length of the opcode being defined.

*Header.OpCode* = **EFI\_IFR\_STRING\_REF1\_OP**.

*StringId*

The string's identifier, which must be unique within the package list.

## Description

Push the string specified by *StringId* on to the expression stack. If the string does not exist, then push an empty string.

### 32.3.8.3.72 EFI\_IFR\_STRING\_REF2

## Summary

Pop a string identifier, push the associated string.

## Prototype

```
#define EFI_IFR_STRING_REF2_OP 0x4f
typedef struct _EFI_IFR_STRING_REF2 {
    EFI_IFR_OP_HEADER_  Header;
} EFI_IFR_STRING_REF2;
```

## Members

*Header*

The byte sequence that defines the type of opcode as well as the length of the opcode being defined.

*Header.OpCode* = **EFI\_IFR\_STRING\_REF2\_OP**.

## Description

This opcode performs the following actions:

1. Pop a value from the expression stack.
2. If the value cannot be evaluated as an unsigned integer or the value of the unsigned integer is greater than 0xFFFF, push Undefined.
3. If the string specified by the value (converted to a string identifier) cannot be determined or the string does not exist, push an empty string.
4. Otherwise, push the string on to the expression stack.

### 32.3.8.3.73 EFI\_IFR\_SUBTITLE

#### Summary

Creates a sub-title in the current form.

#### Prototype

```
#define EFI_IFR_SUBTITLE_OP 0x02
typedef struct _EFI_IFR_SUBTITLE {
    EFI_IFR_OP_HEADER  Header;
    EFI_IFR_STATEMENT_HEADER Statement;
    UINT8              Flags;
} EFI_IFR_SUBTITLE;
```

#### Members

*Header*

The sequence that defines the type of opcode as well as the length of the opcode being defined. For this tag, *Header.OpCode* = **EFI\_IFR\_SUBTITLE\_OP**.

*Flags*

Identifies specific behavior for the sub-title.

#### Description

Subtitle strings are intended to be used by authors to separate sections of questions into semantic groups. If *Header.Scope* is set, then the Forms Browser may further distinguish the end of the semantic group as including only those statements and questions which are nested.

If **EFI\_IFR\_FLAGS\_HORIZONTAL** is set, then this provides a hint that the nested statements or questions should be horizontally arranged. Otherwise, they are assumed to be vertically arranged.

An image may be associated with the statement using a nested **EFI\_IFR\_IMAGE**. An animation may be associated with the statement using a nested **EFI\_IFR\_ANIMATION**.

#### Related Definitions

```
#define EFI_IFR_FLAGS_HORIZONTAL 0x01
```

### 32.3.8.3.74 EFI\_IFR\_SUBTRACT

#### Summary

Pop two unsigned integers, subtract one from the other, push the result.

## Prototype

```
#define EFI_IFR_SUBTRACT_OP 0x3b
typedef struct _EFI_IFR_SUBTRACT {
    EFI_IFR_OP_HEADER Header;
} EFI_IFR_SUBTRACT;
```

## Members

*Header*

Standard opcode header, where *Header.OpCode* is **EFI\_IFR\_SUBTRACT\_OP**.

## Description

This opcode performs the following operations:

1. Pop two values from the expression stack. The first value popped is the *right-hand* value and the second value popped is the *left-hand* value.
2. If the two values do not evaluate to unsigned integers, push Undefined.
3. Zero-extend the values to 64-bits.
4. Subtract the *right-hand* value from the *left-hand* value.
5. Push the lower 64-bits of the result.

### 32.3.8.3.75 EFI\_IFR\_SUPPRESS\_IF

## Summary

Creates a group of statements or questions which are conditionally invisible.

## Prototype

```
#define EFI_IFR_SUPPRESS_IF_OP 0x0a
typedef struct _EFI_IFR_SUPPRESS_IF {
    EFI_IFR_OP_HEADER Header;
} EFI_IFR_SUPPRESS_IF;
```

## Members

*Header*

The byte sequence that defines the type of opcode as well as the length of the opcode being defined.

*Header.OpCode* = **EFI\_IFR\_SUPPRESS\_IF\_OP**.

## Description

The suppress tag causes the nested objects to be hidden from the user if the expression appearing as the first nested object evaluates to TRUE. If the expression consists of more than a single opcode, then the first opcode in the expression must have the Scope bit set and the expression must end with **EFI\_IFR\_END**.

This display form is maintained until the scope for this opcode is closed.

### 32.3.8.3.76 EFI\_IFR\_TEXT

#### Summary

Creates a static text and image.

#### Prototype

```
#define EFI_IFR_TEXT_OP 0x03
typedef struct _EFI_IFR_TEXT {
    EFI_IFR_OP_HEADER Header;
    EFI_IFR_STATEMENT_HEADER Statement;
    EFI_STRING_ID TextTwo;
} EFI_IFR_TEXT;
```

#### Members

<i>Header</i>	The sequence that defines the type of opcode as well as the length of the opcode being defined. For this tag, <i>Header.OpCode</i> = <b>EFI_IFR_TEXT_OP</b> .
<i>Statement</i>	Standard statement header.
<i>TextTwo</i>	The string token reference to the secondary string for this opcode.

#### Description

This is a static text/image statement.

An image may be associated with the statement using a nested **EFI\_IFR\_IMAGE**. An animation may be associated with the question using a nested **EFI\_IFR\_ANIMATION**.

### 32.3.8.3.77 EFI\_IFR\_THIS

#### Summary

Push current question's value.

#### Prototype

```
#define EFI_IFR_THIS_OP 0x58
typedef struct _EFI_IFR_THIS {
    EFI_IFR_OP_HEADER Header;
} EFI_IFR_THIS;
```

#### Members

<i>Header</i>	The sequence that defines the type of opcode as well as the length of the opcode being defined. For this tag, <i>Header.OpCode</i> = <b>EFI_IFR_THIS_OP</b> .
---------------	---

#### Description

Push the current question's value.

### 32.3.8.3.78 EFI\_IFR\_TIME

#### Summary

Create a Time question.

#### Prototype

```
#define EFI_IFR_TIME_OP 0x1b
typedef struct _EFI_IFR_TIME {
    EFI_IFR_OP_HEADER  Header;
    EFI_IFR_QUESTION_HEADER  Question;
    UINT8  Flags;
} EFI_IFR_TIME;
```

#### Members

<i>Header</i>	Basic question information. <i>Header.Opcode</i> = <b>EFI_IFR_TIME_OP</b> .
<i>Question</i>	The standard question header. See <a href="#">Section 32.3.8.2.2</a> for more information.
<i>Flags</i>	A bit-mask that determines which unique settings are active for this opcode.
<b>QF_TIME_HOUR_SUPPRESS</b> 0x01	
<b>QF_TIME_MINUTE_SUPPRESS</b> 0x02	
<b>QF_TIME_SECOND_SUPPRESS</b> 0x04	
<b>QF_TIME_STORAGE</b> 0x30	
	For <b>QF_TIME_STORAGE</b> , there are currently three valid values:
<b>QF_TIME_STORAGE_NORMAL</b> 0x00	
<b>QF_TIME_STORAGE_TIME</b> 0x10	
<b>QF_TIME_STORAGE_WAKEUP</b> 0x20	

#### Description

Create a Time question (see [Section 32.2.5.4.11](#)) and add it to the current form.

An image may be associated with the question using a nested **EFI\_IFR\_IMAGE**. An animation may be associated with the question using a nested **EFI\_IFR\_ANIMATION**.

### 32.3.8.3.79 EFI\_IFR\_TOKEN

#### Summary

Pop two strings and an unsigned integer, then push the nth section of the first string using delimiters from the second string.

## Prototype

```
#define EFI_IFR_TOKEN_OP 0x4d
typedef struct _EFI_IFR_TOKEN {
    EFI_IFR_OP_HEADER Header;
} EFI_IFR_TOKEN;
```

## Members

*Header*

Standard opcode header, where *OpCode* is **EFI\_IFR\_TOKEN\_OP**.

## Description

This opcode performs the following actions:

1. Pop three values from the expression stack. The first value popped is the *right* value and the second value popped is the *middle* value and the last value popped is the *left* value.
2. If the *left* or *middle* values cannot be evaluated as a string, push Undefined. If the *right* value cannot be evaluated as an unsigned integer, push Undefined.
3. The first value is the string. The second value is a string, where each character is a valid delimiter. The third value is the zero-based index.
4. Push the nth delimited sub-string on to the expression stack (0 = left of the first delimiter). The end of the string always acts as the final delimiter.
5. If no such string exists, an empty string is pushed.

### 32.3.8.3.80 EFI\_IFR\_TO\_BOOLEAN

## Summary

Pop a value, convert to Boolean and push the result.

## Prototype

```
#define EFI_IFR_TO_BOOLEAN_OP 0x4A
typedef struct _EFI_IFR_TO_BOOLEAN {
    EFI_IFR_OP_HEADER Header;
} EFI_IFR_TO_BOOLEAN;
```

## Members

*Header*

The sequence that defines the type of opcode as well as the length of the opcode being defined. For this tag, *Header.OpCode* = **EFI\_IFR\_TO\_BOOLEAN\_OP**

## Description

This opcode performs the following actions:

1. Pop a value from the expression stack. If the value is Undefined or cannot be evaluated as a Boolean, push Undefined. Otherwise push the Boolean on the expression stack.
2. When converting from an unsigned integer, zero will be converted to **FALSE** and any other value will be converted to **TRUE**.
3. When converting from a string, if case-insensitive compare with "true" is **True**, then push **TRUE**. If a case-insensitive compare with "false" is **TRUE**, then push **False**. Otherwise, push Undefined.
4. When converting from a buffer, if the buffer is all zeroes, then push **False**. Otherwise push **True**.

### 32.3.8.3.81 EFI\_IFR\_TO\_LOWER

#### Summary

Convert a string on the expression stack to lower case.

#### Prototype

```
#define EFI_IFR_TO_LOWER_OP 0x20
typedef struct _EFI_IFR_TO_LOWER {
    EFI_IFR_OP_HEADER Header;
} EFI_IFR_TO_LOWER;
```

#### Members

*Header*

The sequence that defines the type of opcode as well as the length of the opcode being defined. For this tag, *Header.OpCode* = **EFI\_IFR\_TO\_LOWER\_OP**

#### Description

Pop an expression from the expression stack. If the expression is Undefined or cannot be evaluated as a string, push Undefined. Otherwise, convert the string to all lower case using the **StrLwr** function of the **EFI\_UNICODE\_COLLATION2\_PROTOCOL** and push the string on the expression stack.

### 32.3.8.3.82 EFI\_IFR\_TO\_STRING

#### Summary

Pop a value, convert to a string, push the result.

## Prototype

```
#define EFI_IFR_TO_STRING_OP 0x49
typedef struct _EFI_IFR_TO_STRING{
    EFI_IFR_OP_HEADER Header;
    UINT8 Format;
} EFI_IFR_TO_STRING;
```

## Members

*Header*

The sequence that defines the type of opcode as well as the length of the opcode being defined. For this tag, *Header.OpCode* = **EFI\_IFR\_TO\_STRING\_OP**

*Format*

When converting from unsigned integers, these flags control the format:

0 = unsigned decimal

1 = signed decimal

2 = hexadecimal (lower-case alpha)

3 = hexadecimal (upper-case alpha)

When converting from a buffer, these flags control the format:

0 = ASCII

8 = UCS-2

## Description

This opcode performs the following actions:

1. Pop a value from the expression stack.
2. If the value is Undefined or cannot be evaluated as a string, push Undefined.
3. Convert the value to a string. When converting from an unsigned integer, the number will be converted to a unsigned decimal string (Format = 0), signed decimal string (Format = 1) or a hexadecimal string (Format = 2 or 3).

When converting from a boolean, the boolean will be converted to "True" (True) or "False" (False). When converting from a buffer, each 8-bit (Format = 0) or 16-bit (Format = 8) value will be converted into a character and appended to the string, up until the end of the buffer or a NULL character.

4. Push the result.

### 32.3.8.3.83 EFI\_IFR\_TO\_UINT

#### Summary

Pop a value, convert to an unsigned integer, push the result.



## Prototype

```
#define EFI_IFR_TO_UINT_OP 0x48
typedef struct _EFI_IFR_TO_UINT {
    EFI_IFR_OP_HEADER Header;
} EFI_IFR_TO_UINT;
```

## Members

*Header*

The sequence that defines the type of opcode as well as the length of the opcode being defined. For this tag, *Header.OpCode* = **EFI\_IFR\_TO\_UINT\_OP**

## Description

1. Pop a value from the expression stack.
2. If the value is Undefined or cannot be evaluated as an unsigned integer, push Undefined.
3. Convert the value to an unsigned integer. When converting from a boolean, if True, push 1 and if False, push 0. When converting from a string, whitespace is skipped. The prefix '0x' or '0X' indicates to convert from a hexadecimal string while the prefix '-' indicates conversion from a signed integer string. When converting from a buffer, if the buffer is greater than 8 bytes in length, push Undefined. Otherwise, zero-extend the contents of the buffer to 64-bits.
4. Push the result.

### 32.3.8.3.84 EFI\_IFR\_TO\_UPPER

## Summary

Convert a string on the expression stack to upper case.

## Prototype

```
#define EFI_IFR_TO_UPPER_OP 0x21
typedef struct _EFI_IFR_TO_UPPER {
    EFI_IFR_OP_HEADER Header;
} EFI_IFR_TO_UPPER;
```

## Members

*Header*

The sequence that defines the type of opcode as well as the length of the opcode being defined. For this tag, *Header.OpCode* = **EFI\_IFR\_TO\_UPPER\_OP**

## Description

Pop an expression from the expression stack. If the expression is Undefined or cannot be evaluated as a string, push Undefined. Otherwise, convert the string to all upper case using the **StrUpr** function of the **EFI\_UNICODE\_COLLATION2\_PROTOCOL** and push the string on the expression stack.

### 32.3.8.3.85 EFI\_IFR\_TRUE

#### Summary

Push a TRUE on to the expression stack.

#### Prototype

```
#define EFI_IFR_TRUE_OP 0x46
typedef struct _EFI_IFR_TRUE {
    EFI_IFR_OP_HEADER Header;
} EFI_IFR_TRUE;
```

#### Members

*Header*

The sequence that defines the type of opcode as well as the length of the opcode being defined. For this tag, *Header.OpCode* = **EFI\_IFR\_TRUE\_OP**

#### Description

Push a **TRUE** on to the expression stack.

### 32.3.8.3.86 EFI\_IFR\_UINT8, EFI\_IFR\_UINT16, EFI\_IFR\_UINT32, EFI\_IFR\_UINT64

#### Summary

Push an unsigned integer on to the expression stack.

## Prototype

```
#define EFI_IFR_UINT8_OP 0x42
typedef struct _EFI_IFR_UINT8 {
    EFI_IFR_OP_HEADER Header;
    UINT8    Value;
} EFI_IFR_UINT8;

#define EFI_IFR_UINT16_OP 0x43
typedef struct _EFI_IFR_UINT16 {
    EFI_IFR_OP_HEADER Header;
    UINT16    Value;
} EFI_IFR_UINT16;

#define EFI_IFR_UINT32_OP 0x44
typedef struct _EFI_IFR_UINT32 {
    EFI_IFR_OP_HEADER Header;
    UINT32    Value;
} EFI_IFR_UINT32;

#define EFI_IFR_UINT64_OP 0x45
typedef struct _EFI_IFR_UINT64 {
    EFI_IFR_OP_HEADER Header;
    UINT64    Value;
} EFI_IFR_UINT64;
```

## Members

*Header*

The sequence that defines the type of opcode as well as the length of the opcode being defined. For this tag, *Header.OpCode* = **EFI\_IFR\_UINT8\_OP**, **EFI\_IFR\_UINT16\_OP**, **EFI\_IFR\_UINT32\_OP** or **EFI\_IFR\_UINT64\_OP**.

*Value*

The unsigned integer.

## Description

Push the specified unsigned integer, zero-extended to 64-bits, on to the expression stack.

### 32.3.8.3.87 EFI\_IFR\_UNDEFINED

## Summary

Push an Undefined to the expression stack.

## Prototype

```
#define EFI_IFR_UNDEFINED_OP 0x55
typedef struct _EFI_IFR_UNDEFINED {
    EFI_IFR_OP_HEADER Header;
} EFI_IFR_UNDEFINED;
```

## Members

*Header*

The sequence that defines the type of opcode as well as the length of the opcode being defined. For this tag, *Header.OpCode* = **EFI\_IFR\_UNDEFINED\_OP**

## Description

Push Undefined on to the expression stack.

### 32.3.8.3.88 EFI\_IFR\_VALUE

## Summary

Provides a value for the current question or default.

## Prototype

```
#define EFI_IFR_VALUE_OP 0x5a
typedef struct _EFI_IFR_VALUE {
    EFI_IFR_OP_HEADER Header;
} EFI_IFR_VALUE;
```

## Members

*Header*

The sequence that defines the type of opcode as well as the length of the opcode being defined. For this tag, *Header.OpCode* = **EFI\_IFR\_VALUE\_OP**

## Description

Creates a value for the current question or default with no storage. The value is the result of the expression nested in the scope.

If used for a question, then the question will be read-only.

### 32.3.8.3.89 EFI\_IFR\_VARSTORE

## Summary

Creates a variable storage short-cut for linear buffer storage.

## Prototype

```
#define EFI_IFR_VARSTORE_OP 0x24
typedef struct {
    EFI_IFR_OP_HEADER Header;
    EFI_GUID Guid;
    EFI_VARSTORE_ID VarStoreId;
    UINT16 Size;
    //UINT8 Name[];
} EFI_IFR_VARSTORE;
```

## Members

<i>Header</i>	The byte sequence that defines the type of opcode as well as the length of the opcode being defined. For this tag, <i>Header.OpCode</i> = <b>EFI_IFR_VARSTORE_OP</b> .
<i>Guid</i>	The variable's GUID definition. This field comprises one half of the variable name, with the other half being the human-readable aspect of the name, which is represented by the string immediately following the <i>Size</i> field. Type <b>EFI_GUID</b> is defined in <b>InstallProtocolInterface()</b> in this specification.
<i>VarStoreId</i>	The variable store identifier, which is unique within the current form set. This field is the value that uniquely identify this instance from others. Question headers refer to this value to designate which is the active variable that is being used. A value of zero is invalid.
<i>Size</i>	The size of the variable store.
<i>Name</i>	A null-terminated ASCII string that specifies the name associated with the variable store. The field is not actually included in the structure but is included here to help illustrate the encoding of the opcode. The size of the string, including the null termination, is included in the opcode's header size.

## Description

This opcode describes a Buffer Storage Variable Store within a form set. A question can select this variable store by setting the *VarStoreId* field in its opcode header.

An **EFI\_IFR\_VARSTORE** with a specified *VarStoreId* must appear in the IFR before it can be referenced by a question.

### 32.3.8.3.90 EFI\_IFR\_VARSTORE\_NAME\_VALUE

## Summary

Creates a variable storage short-cut for name/value storage.

## Prototype

```
#define EFI_IFR_VARSTORE_NAME_VALUE_OP 0x25
typedef struct _EFI_IFR_VARSTORE_NAME_VALUE {
    EFI_IFR_OP_HEADER Header;
    EFI_VARSTORE_ID VarStoreId;
    EFI_GUID Guid;
} EFI_IFR_VARSTORE_NAME_VALUE;
```

## Members

<i>Header</i>	The byte sequence that defines the type of opcode as well as the length of the opcode being defined. For this tag, <i>Header.OpCode</i> = <b>EFI_IFR_VARSTORE_NAME_VALUE_OP</b> .
<i>Guid</i>	The variable's GUID definition. This field comprises one half of the variable name, with the other half being the human-readable aspect of the name, which is specified in the <i>VariableName</i> field in the question's header (see <b>EFI_IFR_QUESTION_HEADER</b> ). Type <b>EFI_GUID</b> is defined in <b>InstallProtocolInterface()</b> in the UEFI Specification.
<i>VarStoreId</i>	The variable store identifier, which is unique within the current form set. This field is the value that uniquely identifies this variable store definition instance from others. Question headers refer to this value to designate which is the active variable that is being used. A value of zero is invalid.

## Description

This opcode describes a Name/Value Variable Store within a form set. A question can select this variable store by setting the *VarStoreId* field in its question header.

An **EFI\_IFR\_VARSTORE\_NAME\_VALUE** with a specified *VarStoreId* must appear in the IFR before it can be referenced by a question.

### 32.3.8.3.91 EFI\_IFR\_VARSTORE\_EFI

#### Summary

Creates a variable storage short-cut for EFI variable storage.

## Prototype

```
#define EFI_IFR_VARSTORE_EFI_OP 0x26
typedef struct _EFI_IFR_VARSTORE_EFI {
    EFI_IFR_OP_HEADER Header;
    EFI_VARSTORE_ID VarStoreId;
    EFI_GUID Guid;
    UINT32 Attributes;
    UINT16 Size;
    //UINT8 Name[];
} EFI_IFR_VARSTORE_EFI;
```

## Members

<i>Header</i>	The byte sequence that defines the type of opcode as well as the length of the opcode being defined. For this tag, <i>Header.OpCode</i> = <b>EFI_IFR_VARSTORE_EFI_OP</b> .
<i>VarStoreId</i>	The variable store identifier, which is unique within the current form set. This field is the value that uniquely identifies this variable store definition instance from others. Question headers refer to this value to designate which is the active variable that is being used. A value of zero is invalid.
<i>Guid</i>	The EFI variable's GUID definition. This field comprises one half of the EFI variable name, with the other half being the human-readable aspect of the name, which is specified in the <i>Name</i> field below. Type <b>EFI_GUID</b> is defined in <b>InstallProtocolInterface()</b> in this specification.
<i>Attributes</i>	Specifies the flags to use for the variable.
<i>Size</i>	The size of the variable store.
<i>Name</i>	A null-terminated ASCII string that specifies one half of the EFI name for this variable store. The other half is specified in the <i>Guid</i> field (above). The <i>Name</i> field is not actually included in the structure but is included here to help illustrate the encoding of the opcode. The size of the string, including the null termination, is included in the opcode's header size.

## Description

This opcode describes an EFI Variable Variable Store within a form set. The *Guid* and *Name* specified here will be used with **GetVariable()** and **SetVariable()**.

- A question can select this variable store by setting the *VarStoreId* field in its question header.
- A question can refer to a specific offset within the EFI Variable using the *VarOffset* field in its question header.

**Note:** *Name* must be converted to a CHAR16 string before it is passed to **GetVariable()** or **SetVariable()**.

An **EFI\_IFR\_VARSTORE\_EFI** with a specified *VarStoreId* must appear in the IFR before it can be referenced by a question.

### 32.3.8.3.92 EFI\_IFR\_VARSTORE\_DEVICE

#### Summary

Select the device which contains the variable store.

#### Prototype

```
#define EFI_IFR_VARSTORE_DEVICE_OP 0x27
typedef struct _EFI_IFR_VARSTORE_DEVICE {
    EFI_IFR_OP_HEADER    Header;
    EFI_STRING_ID        DevicePath;
} EFI_IFR_VARSTORE_DEVICE;
```

#### Members

*Header*

The byte sequence that defines the type of opcode as well as the length of the opcode being defined. For this tag, *Header.OpCode* = **EFI\_IFR\_VARSTORE\_DEVICE\_OP**.

*DevicePath*

Specifies the string which contains the device path of the device where the variable store resides.

#### Description

This opcode describes the device path where a variable store resides. Normally, the Forms Processor finds the variable store on the handle specified when the HII database function **NewPackageList()** was called. However, if this opcode is found in the scope of a question, the handle specified by the text device path *DevicePath* is used instead.

### 32.3.8.3.93 EFI\_IFR\_VERSION

#### Summary

Push the version of the UEFI specification to which the Forms Processor conforms.

#### Prototype

```
#define EFI_IFR_VERSION_OP 0x28
typedef struct _EFI_IFR_VERSION {
    EFI_IFR_OP_HEADER    Header;
} EFI_IFR_VERSION;
```

#### Members

*Header*

The sequence that defines the type of opcode as well as the length of the opcode being defined. For this tag, *Header.OpCode* = **EFI\_IFR\_VERSION\_OP**.



## Description

Returns the revision level of the UEFI specification with which the Forms Processor is compliant as a 16-bit unsigned integer, with the form:

[15:8]Major revision

[7:4]Tens digit of the minor revision

[3:0]Ones digit of the minor revision

The fields of the version have the following correlation with the revision of the UEFI system table.

**Major revision: `EFI_SYSTEM_TABLE_REVISION >> 16`**

**Tens digit of the minor revision: `(EFI_SYSTEM_TABLE_REVISION & 0xFFFF)/10`**

**Ones digit of the minor revision: `(EFI_SYSTEM_TABLE_REVISION & 0xFFFF)%10`**

### 32.3.8.3.94 EFI\_IFR\_WRITE

#### Summary

Change a value for the current question.

#### Prototype

```
#define EFI_IFR_WRITE_OP 0x2E
typedef struct _EFI_IFR_WRITE {
    EFI_IFR_OP_HEADER    Header;
} EFI_IFR_WRITE;
```

#### Parameters

*Header*

The sequence that defines the type of opcode as well as the length of the opcode being defined. For this tag, *Header.OpCode* = **EFI\_IFR\_WRITE\_OP**

#### Description

Before writing the value of the current question to storage (if any storage was specified), the *this* constant is set (see **EFI\_IFR\_THIS**) and then this expression is evaluated.

### 32.3.8.3.95 EFI\_IFR\_ZERO

#### Summary

Push a zero on to the expression stack.

## Prototype

```
#define EFI_IFR_ZERO_OP 0x52
typedef struct _EFI_IFR_ZERO {
    EFI_IFR_OP_HEADER Header;
} EFI_IFR_ZERO;
```

## Members

*Header*

The sequence that defines the type of opcode as well as the length of the opcode being defined. For this tag, *Header.OpCode* = **EFI\_IFR\_ZERO\_OP**

## Description

Push a zero on to the expression stack.

### 32.3.8.3.96 EFI\_IFR\_WARNING\_IF

## Summary

Creates a validation expression and warning message for a question.

## Prototype

```
#define EFI_IFR_WARNING_IF_OP 0x063
typedef struct _EFI_IFR_WARNING_IF {
    EFI_IFR_OP_HEADER Header;
    EFI_STRING_ID Warning;
    UINT8 Timeout;
} EFI_IFR_WARNING_IF;
```

## Members

*Header*

The byte sequence that defines the type of opcode as well as the length of the opcode being defined. *Header.OpCode* = **EFI\_IFR\_WARNING\_IF\_OP**.

*Warning*

The string token reference to the string that will be used for the warning check message.

*Timeout*

The number of seconds for the warning message to be displayed before it is timed out or acknowledged by the user. A value of zero indicates that the message is displayed indefinitely until the user acknowledges it.

## Description

This tag uses a Boolean expression to allow the IFR creator to check options in a question, and provide a warning message if the expression is true. For example, this tag might be used to give a warning if the user attempts to disable a security setting, or change the value of a sensitive question. The tag provides a string to be used in a warning display to alert the user of the consequences of changing the question value. Warning tags will be evaluated when the user traverses from tag to tag. The browser must display the warning text message and not allow the form to be submitted until either the user acknowledges

the message (with some key press for instance) or the number of seconds in `TimeOut` elapses. Unlike inconsistency tags, the user should still be allowed to submit the results of a form even if the warning expression evaluates to true.

### 32.3.8.3.97 EFI\_IFR\_MATCH2

#### Summary

Pop a source string and a pattern string, push **TRUE** if the source string matches the Regular Expression pattern specified by the pattern string, otherwise push **FALSE**.

#### Prototype

```
#define EFI_IFR_MATCH2_OP 0x64
typedef struct _EFI_IFR_MATCH2 {
    EFI_IFR_OP_HEADER Header;
    EFI_GUID SyntaxType;
} EFI_IFR_MATCH2;
```

#### Members

<i>Header</i>	Standard opcode header, where <i>Header.Opcode</i> is <b>EFI_IFR_MATCH2_OP</b> .
<i>SyntaxType</i>	A GUID that identifies the regular expression syntax type to use for the <i>pattern</i> string. See <b>EFI_REGULAR_EXPRESSION_PROTOCOL</b> for current syntax definitions.

#### Description

This opcode performs the following actions:

1. Pop two values from the expression stack. The first value popped is the *string* and the second value popped is the *pattern*.
2. If the *string* or the *pattern* cannot be evaluated as a string, then push Undefined.
3. Call **GetInfo** function of each instance of **EFI\_REGULAR\_EXPRESSION\_PROTOCOL**, looking for a *SyntaxType* that is listed in the set of supported regular expression syntax types returned by *RegExSyntaxTypeList*. If the type specified by *SyntaxType* is not supported in any of the **EFI\_REGULAR\_EXPRESSION\_PROTOCOL** instances, or no **EFI\_REGULAR\_EXPRESSION\_PROTOCOL** instance was found, push Undefined.
4. Process the *string* and *pattern* using the **MatchString** function of the **EFI\_REGULAR\_EXPRESSION\_PROTOCOL** instance that supports the *SyntaxType*, where *SyntaxType* is the *SyntaxType* input to **MatchString**.
5. If the returned regular expression *Result* is **TRUE**, then push **TRUE**.
6. If the return regular expression *Result* is **FALSE**, then push **FALSE**.

**Note:** To ensure interoperability, drivers that publish HII IFR Forms packages should check the system capabilities by calling the **GetInfo** function of each **EFI\_REGULAR\_EXPRESSION\_PROTOCOL** instance during initialization. If the required regular expression syntax type is not supported, the driver may install its own instance of **EFI\_REGULAR\_EXPRESSION\_PROTOCOL** to add the

support. The driver may also choose to fall back to other methods of validation, such as using **EFI\_IFR\_MATCH** or callbacks.

### 32.3.9 Keyboard Package

```
//*****
// EFI_HII_KEYBOARD_PACKAGE_HDR
//*****
typedef struct {
    EFI_HII_PACKAGE_HDR  Header;
    UINT16               LayoutCount;
    //EFI_HII_KEYBOARD_LAYOUT Layout[];
} EFI_HII_KEYBOARD_PACKAGE_HDR;
```

<i>Header</i>	The general pack header which defines both the type of pack and the length of the entire pack.
<i>LayoutCount</i>	The number of keyboard layouts contained in the entire keyboard pack.
<i>Layout</i>	An array of <i>LayoutCount</i> number of keyboard layouts.

### 32.3.10 Animations Package

The Animation package record describes how, when, and which EFI images to display. The package consists of two parts: a fixed header and the animation information.

#### 32.3.10.1 Animated Images Package

##### Summary

The fixed header consists of a standard record header and the

##### Prototype

```
typedef struct _EFI_HII_ANIMATION_PACKAGE_HDR {
    EFI_HII_ANIMATION_PACKAGE  Header;
    UINT32                     AnimationInfoOffset;
} EFI_HII_ANIMATION_PACKAGE_HDR;
```

##### Members

<i>Header</i>	Standard image header, where <i>Header.BlockType</i> = <b>EFI_HII_PACKAGE_ANIMATIONS</b> .
<i>AnimationInfoOffset</i>	Offset, relative to this header, of the animation information. If this is zero, then there are no animation sequences in the package.

#### 32.3.10.2 Animation Information

For each animated image identifier, the animation information gives a sequence of EFI images to display and how and when to transition to the next image. The animation

information is encoded as a series of blocks, with each block prefixed by a single byte header (**EFI\_HII\_ANIMATION\_BLOCK**) or one of the extension headers (**EFI\_HII\_AIBT\_EXTx\_BLOCK**). The blocks must be processed in order.

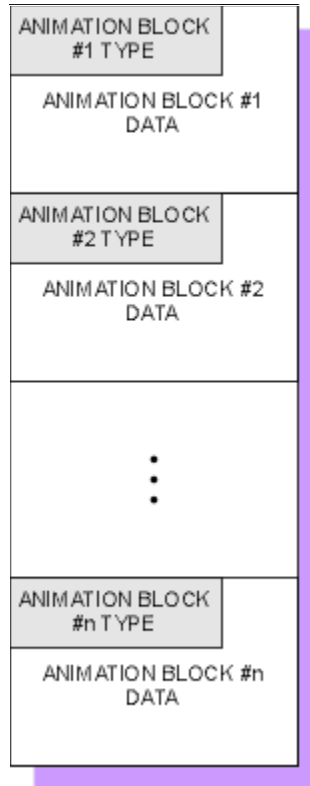

Figure 135. Animation Information Encoded in Blocks

### Prototype

```
typedef struct _EFI_HII_ANIMATION_BLOCK {
    UINT8          BlockType;
    //UINT8        BlockBody[];
} EFI_HII_ANIMATION_BLOCK;
```

The following table describes the different block types:

Table 218. Animation Block Types

Name	Value	Description
EFI_HII_AIBT_END	0x00	The end of the animation information.
EFI_HII_AIBT_OVERLAY_IMAGES	0x10	Animate sequence once by displaying the next image in the <i>logical window</i> .
EFI_HII_AIBT_CLEAR_IMAGES	0x11	Animate sequence once by clearing the <i>logical window</i> before displaying the next image.
EFI_HII_AIBT_RESTORE_SCRN	0x12	Animate sequence once by clearing the restoring the <i>logical window</i> before displaying the next image.
EFI_HII_AIBT_OVERLAY_IMAGES_LOOP	0x18	Animate repeating sequence by displaying the next image in the <i>logical window</i> .
EFI_HII_AIBT_CLEAR_IMAGES_LOOP	0x19	Animate repeating sequence by clearing the <i>logical window</i> before displaying the next image.
EFI_HII_AIBT_RESTORE_SCRN_LOOP	0x1A	Animate repeating sequence by clearing the restoring the <i>logical window</i> before displaying the next image.
EFI_HII_AIBT_DUPLICATE	0x20	Duplicate an existing animation identifier
EFI_HII_AIBT_SKIP2	0x21	Skip a certain number of animation identifiers.
EFI_HII_AIBT_SKIP1	0x22	Skip a certain number of animation identifiers.
EFI_HII_AIBT_EXT1	0x30	For future expansion (one byte length field)
EFI_HII_AIBT_EXT2	0x31	For future expansion (two byte length field)
EFI_HII_AIBT_EXT4	0x32	For future expansion (four byte length field)

In order to recreate all animation sequences, start at the first block and process them all until either an **EFI\_HII\_AIBT\_END** block is found. When processing the animation blocks, each block refers to the current animation identifier (*AnimationIdCurrent*), which is initially set to one (1).

Animation blocks of an unknown type should be skipped. If they cannot be skipped, then processing halts.

### 32.3.10.2.1 EFI\_HII\_AIBT\_END

#### Summary

Marks the end of the animation information.

#### Prototype

None

#### Members

*Header*

Standard animation header, where *Header.BlockType* = **EFI\_HII\_AIBT\_END**.

## Discussion

Any animation sequences with an animation identifier greater than or equal to *AnimationIdCurrent* are empty. There is no additional data.

### 32.3.10.2.2 EFI\_HII\_AIBT\_EXT1, EFI\_HII\_AIBT\_EXT2, EFI\_HII\_AIBT\_EXT4

## Summary

Generic prefix for animation information with a 1-byte, 2-byte or 4-byte length.

## Prototype

```
typedef struct _EFI_HII_AIBT_EXT1_BLOCK {
  EFI_HII_ANIMATION_BLOCK  Header;
  UINT8                    BlockType2;
  UINT8                    Length;
} EFI_HII_AIBT_EXT1_BLOCK;
```

```
typedef struct _EFI_HII_AIBT_EXT2_BLOCK {
  EFI_HII_ANIMATION_BLOCK Header;
  UINT8                    BlockType2;
  UINT16                   Length;
} EFI_HII_AIBT_EXT2_BLOCK;
```

```
typedef struct _EFI_HII_AIBT_EXT4_BLOCK {
  EFI_HII_ANIMATION_BLOCK Header;
  UINT8                    BlockType2;
  UINT32                   Length;
} EFI_HII_AIBT_EXT4_BLOCK;
```

## Members

*Header* Standard animation header, where *Header.BlockType* = **EFI\_HII\_AIBT\_EXT1**, **EFI\_HII\_AIBT\_EXT2**, or **EFI\_HII\_AIBT\_EXT4**.

*Length* Size of the animation block, in bytes, including the animation block header.

*BlockType2* The block type, as described in [Table 215 on page 2112](#).

## Discussion

These records are used for variable sized animation records which need an explicit length.

### 32.3.10.2.3 EFI\_HII\_AIBT\_OVERLAY\_IMAGES

## Summary

An animation block to describe an animation sequence that does not cycle, and where one image is simply displayed over the previous image.

## Prototype

```
typedef struct _EFI_HII_AIBT_OVERLAY_IMAGES_BLOCK {
    EFI_IMAGE_ID    DftImageId;
    UINT16          Width;
    UINT16          Height;
    UINT16          CellCount;
    EFI_HII_ANIMATION_CELL AnimationCell[];
} EFI_HII_AIBT_OVERLAY_IMAGES_BLOCK;
```

## Members

<i>DftImageId</i>	This is image that is to be reference by the image protocols, if the animation function is not supported or disabled. This image can be one particular image from the animation sequence (if any one of the animation frames has a complete image) or an alternate image that can be displayed alone. If the value is zero, no image is displayed.
<i>Width</i>	The overall width of the set of images ( <i>logical window width</i> ).
<i>Height</i>	The overall height of the set of images ( <i>logical window height</i> ).
<i>CellCount</i>	The number of <b>EFI_HII_ANIMATION_CELL</b> contained in the animation sequence.
<i>AnimationCell</i>	An array of <i>CellCount</i> animation cells. The type <b>EFI_HII_ANIMATION_CELL</b> is defined in "Related Definitions" below.

## Description

This record assigns the animation sequence data to the *AnimationIdCurrent* identifier and increment *AnimationIdCurrent* by one. This animation sequence is meant to be displayed only once (it is not a repeating sequence). Each image in the sequence will remain on the screen for the specified *delay* before the next image in the sequence is displayed.

The header type (either *BlockType* in **EFI\_HII\_ANIMATION\_BLOCK** or *BlockType2* in **EFI\_HII\_AIBT\_EXTx\_BLOCK**) will be set to **EFI\_HII\_AIBT\_OVERLAY\_IMAGES**.

## Related Definition

```
typedef struct _EFI_HII_ANIMATION_CELL {
    UINT16    OffsetX;
    UINT16    OffsetY;
    EFI_IMAGE_ID ImageId;
    UINT16    Delay;
} EFI_HII_ANIMATION_CELL;
```

<i>OffsetX</i>	The X offset from the upper left hand corner of the <i>logical window</i> to position the indexed image.
<i>OffsetY</i>	The Y offset from the upper left hand corner of the <i>logical window</i> to position the indexed image.



<i>Imageld</i>	The image to display at the specified offset from the upper left hand corner of the <i>logical window</i> .
<i>Delay</i>	The number of milliseconds to delay after displaying the indexed image and before continuing on to the next linked image. If value is zero, no delay.

## Related Description

The *logical window* definition allows the animation to be centered, even though the first image might be way off center (bounds the sequence of images). All images will be clipped to the defined *logical window*, since the *logical window* is suppose to bound all images, normally there is nothing to clip. The *DftImageld* definition allows an alternate image to be displayed if animation is currently not supported. The *DftImageld* image is to be centered in the defined *logical window*.

### 32.3.10.2.4 EFI\_HII\_AIBT\_CLEAR\_IMAGES

#### Summary

An animation block to describe an animation sequence that does not cycle, and where the *logical window* is cleared to the specified color before the next image is displayed.

#### Prototype

```
typedef struct _EFI_HII_AIBT_CLEAR_IMAGES_BLOCK {
    EFI_IMAGE_ID           DftImageld;
    UINT16                 Width;
    UINT16                 Height;
    UINT16                 CellCount;
    EFI_HII_RGB_PIXEL      BackgndColor;
    EFI_HII_ANIMATION_CELL AnimationCell[];
} EFI_HII_AIBT_CLEAR_IMAGES_BLOCK;
```

#### Members

<i>DftImageld</i>	This is image that is to be reference by the image protocols, if the animation function is not supported or disabled. This image can be one particular image from the animation sequence (if any one of the animation frames has a complete image) or an alternate image that can be displayed alone. If the value is zero, no image is displayed.
<i>Width</i>	The overall width of the set of images ( <i>logical window</i> width).
<i>Height</i>	The overall height of the set of images ( <i>logical window</i> height).
<i>CellCount</i>	The number of <b>EFI_HII_ANIMATION_CELL</b> contained in the animation sequence.

<i>BackgndColor</i>	The color to clear the <i>logical window</i> to before displaying the indexed image.
<i>AnimationCell</i>	An array of <i>CellCount</i> animation cells. The type <b>EFI_HII_ANIMATION_CELL</b> is defined in “Related Definitions” in <b>EFI_HII_AIBT_OVERLAY_IMAGES</b> .

## Description

This record assigns the animation sequence data to the *AnimationIdCurrent* identifier and increment *AnimationIdCurrent* by one. This animation sequence is meant to be displayed only once (it is not a repeating sequence). Each image in the sequence will remain on the screen for the specified *delay* before the logical window is cleared to the specified color (*BackgndColor*) and the next image is displayed. The logical window is also cleared to the specified color before displaying the *DftImageId* image.

The header type (either *BlockType* in **EFI\_HII\_ANIMATION\_BLOCK** or *BlockType2* in **EFI\_HII\_AIBT\_EXTx\_BLOCK**) will be set to **EFI\_HII\_AIBT\_CLEAR\_IMAGES**.

### 32.3.10.2.5 EFI\_HII\_AIBT\_RESTORE\_SCRN

## Summary

An animation block to describe an animation sequence that does not cycle, and where the screen is restored to the original state before the next image is displayed.

## Prototype

```
typedef struct _EFI_HII_AIBT_RESTORE_SCRN_BLOCK {
    EFI_IMAGE_ID    DftImageId;
    UINT16          Width;
    UINT16          Height;
    UINT16          CellCount;
    EFI_HII_ANIMATION_CELL AnimationCell[];
} EFI_HII_AIBT_RESTORE_SCRN_BLOCK;
```

## Members

<i>DftImageId</i>	This is image that is to be reference by the image protocols, if the animation function is not supported or disabled. This image can be one particular image from the animation sequence (if any one of the animation frames has a complete image) or an alternate image that can be displayed alone. If the value is zero, no image is displayed.
<i>Width</i>	The overall width of the set of images ( <i>logical window</i> width).
<i>Height</i>	The overall height of the set of images ( <i>logical window</i> height).
<i>CellCount</i>	The number of <b>EFI_HII_ANIMATION_CELL</b> contained in the animation sequence.

*AnimationCell*

An array of *CellCount* animation cells. The type **EFI\_HII\_ANIMATION\_CELL** is defined in “Related Definitions” in **EFI\_HII\_AIBT\_OVERLAY\_IMAGES**.

**Description**

This record assigns the animation sequence data to the *AnimationIdCurrent* identifier and increment *AnimationIdCurrent* by one. This animation sequence is meant to be displayed only once (it is not a repeating sequence). Before the first image is displayed, the entire defined *logical window* is saved to a buffer. Then each image in the sequence will remain on the screen for the specified *delay* before the logical window is restored to the original state and the next image is displayed.

If memory buffers are not available to save the *logical window*, this structure is treated as **EFI\_HII\_AIBT\_CLEAR\_IMAGES** structure, with the *BackgndColor* value set to black.

The header type (either *BlockType* in **EFI\_HII\_ANIMATION\_BLOCK** or *BlockType2* in **EFI\_HII\_AIBT\_EXTx\_BLOCK**) will be set to **EFI\_HII\_AIBT\_RESTORE\_SCRN**.

**32.3.10.2.6 EFI\_HII\_AIBT\_OVERLAY\_IMAGES\_LOOP****Summary**

An animation block to describe an animation sequence that continuously cycles, and where one image is simply displayed over the previous image.

**Prototype**

```
typedef EFI_HII_AIBT_OVERLAY_IMAGES_BLOCK
EFI_HII_AIBT_OVERLAY_IMAGES_LOOP_BLOCK {
    EFI_IMAGE_ID      DftImageId;
    UINT16            Width;
    UINT16            Height;
    UINT16            CellCount;
    EFI_HII_ANIMATION_CELL AnimationCell[];
} EFI_HII_AIBT_OVERLAY_IMAGES_LOOP_BLOCK;
```

**Members**

<i>DftImageId</i>	This is image that is to be reference by the image protocols, if the animation function is not supported or disabled. This image can be one particular image from the animation sequence (if any one of the animation frames has a complete image) or an alternate image that can be displayed alone. If the value is zero, no image is displayed.
<i>Width</i>	The overall width of the set of images ( <i>logical window</i> width).
<i>Height</i>	The overall height of the set of images ( <i>logical window</i> height).
<i>CellCount</i>	The number of <b>EFI_HII_ANIMATION_CELL</b> contained in the animation sequence.

*AnimationCell*

An array of *CellCount* animation cells. The type **EFI\_HII\_ANIMATION\_CELL** is defined in “Related Definitions” in **EFI\_HII\_AIBT\_OVERLAY\_IMAGES**

**Description**

This record assigns the animation sequence data to the *AnimationIdCurrent* identifier and increment *AnimationIdCurrent* by one. This animation sequence is meant to continuously cycle until stopped or paused. Each image in the sequence will remain on the screen for the specified *delay* before the next image in the sequence is displayed.

The header type (either *BlockType* in **EFI\_HII\_ANIMATION\_BLOCK** or *BlockType2* in **EFI\_HII\_AIBT\_EXTx\_BLOCK**) will be set to **EFI\_HII\_AIBT\_OVERLAY\_IMAGES\_LOOP**.

**32.3.10.2.7 EFI\_HII\_AIBT\_CLEAR\_IMAGES\_LOOP****Summary**

An animation block to describe an animation sequence that continuously cycles, and where the *logical window* is cleared to the specified color before the next image is displayed.

**Prototype**

```
typedef EFI_HII_AIBT_CLEAR_IMAGES_BLOCK
EFI_HII_AIBT_CLEAR_IMAGES_LOOP_BLOCK {
    EFI_IMAGE_ID    DftImageId;
    UINT16          Width;
    UINT16          Height;
    UINT16          CellCount;
    EFI_HII_RGB_PIXEL BackgndColor;
    EFI_HII_ANIMATION_CELL AnimationCell[][];
} EFI_HII_AIBT_CLEAR_IMAGES_LOOP_BLOCK;
```

**Members***DftImageId*

This is image that is to be reference by the image protocols, if the animation function is not supported or disabled. This image can be one particular image from the animation sequence (if any one of the animation frames has a complete image) or an alternate image that can be displayed alone. If the value is zero, no image is displayed.

*Width*

The overall width of the set of images (*logical window* width).

*Height*

The overall height of the set of images (*logical window* height).

*CellCount*

The number of **EFI\_HII\_ANIMATION\_CELL** contained in the animation sequence.

<i>BackgndColor</i>	The color to clear the <i>logical window</i> to before displaying the indexed image.
<i>AnimationCell</i>	An array of <i>CellCount</i> animation cells. The type <b>EFI_HII_ANIMATION_CELL</b> is defined in “Related Definitions” in <b>EFI_HII_AIBT_OVERLAY_IMAGES</b>

## Description

This record assigns the animation sequence data to the *AnimationIdCurrent* identifier and increment *AnimationIdCurrent* by one. This animation sequence is meant to continuously cycle until stopped or paused. Each image in the sequence will remain on the screen for the specified *delay* before the logical window is cleared to the specified color (*BackgndColor*) and the next image is displayed. The logical window is also cleared to the specified color before displaying the *DftImageld* image.

The header type (either *BlockType* in **EFI\_HII\_ANIMATION\_BLOCK** or *BlockType2* in **EFI\_HII\_AIBT\_EXTx\_BLOCK**) will be set to **EFI\_HII\_AIBT\_CLEAR\_IMAGES\_LOOP**.

### 32.3.10.2.8 EFI\_HII\_AIBT\_RESTORE\_SCRN\_LOOP

## Summary

An animation block to describe an animation sequence that continuously cycles, and where the screen is restored to the original state before the next image is displayed.

## Prototype

```
typedef EFI_HII_AIBT_RESTORE_SCRN_LOOP_BLOCK
EFI_HII_AIBT_RESTORE_SCRN_LOOP_BLOCK {
    EFI_IMAGE_ID    DftImageld;
    UINT16          Width;
    UINT16          Height;
    UINT16          CellCount;
    EFI_HII_ANIMATION_CELL AnimationCell[];
} EFI_HII_AIBT_RESTORE_SCRN_LOOP_BLOCK;
```

## Members

<i>Header</i>	Standard image header, where <i>Header.BlockType</i> = <b>EFI_HII_AIBT_RESTORE_SCRN_LOOP</b> .
<i>DftImageld</i>	This is image that is to be reference by the image protocols, if the animation function is not supported or disabled. This image can be one particular image from the animation sequence (if any one of the animation frames has a complete image) or an alternate image that can be displayed alone. If the value is zero, no image is displayed.
<i>Length</i>	Size of the animation block, in bytes, including the animation block header.
<i>Width</i>	The overall width of the set of images ( <i>logical window</i> width).

<i>Height</i>	The overall height of the set of images ( <i>logical window</i> height).
<i>CellCount</i>	The number of <b>EFI_HII_ANIMATION_CELL</b> contained in the animation sequence.
<i>AnimationCell</i>	An array of <i>CellCount</i> animation cells. The type <b>EFI_HII_ANIMATION_CELL</b> is defined in “Related Definitions” in <b>EFI_HII_AIBT_OVERLAY_IMAGES</b>

## Description

This record assigns the animation sequence data to the *AnimationIdCurrent* identifier and increment *AnimationIdCurrent* by one. This animation sequence is meant to continuously cycle until stopped or paused. Before the first image is displayed, the entire defined *logical window* is saved to a buffer. Then each image in the sequence will remain on the screen for the specified *delay* before the logical window is restored to the original state and the next image is displayed.

If memory buffers are not available to save the *logical window*, this structure is treated as **EFI\_HII\_AIBT\_CLEAR\_IMAGES\_LOOP** structure, with the *BackgndColor* value set to black.

The header type (either *BlockType* in **EFI\_HII\_ANIMATION\_BLOCK** or *BlockType2* in **EFI\_HII\_AIBT\_EXTx\_BLOCK**) will be set to **EFI\_HII\_AIBT\_RESTORE\_SCRN\_LOOP**.

### 32.3.10.2.9 EFI\_HII\_AIBT\_DUPLICATE

#### Summary

Assigns a new character value to a previously defined animation sequence.

#### Prototype

```
typedef struct _EFI_HII_AIBT_DUPLICATE_BLOCK {
    EFI_ANIMATION_ID    AnimationId;
} EFI_HII_AIBT_DUPLICATE_BLOCK;
```

#### Members

<i>AnimationId</i>	The previously defined animation ID with the exact same animation information.
--------------------	--

#### Discussion

Indicates that the animation sequence with animation ID *AnimationIdCurrent* has the same animation information as a previously defined animation ID and increments *AnimationIdCurrent* by one.

The header type (either *BlockType* in **EFI\_HII\_ANIMATION\_BLOCK** or *BlockType2* in **EFI\_HII\_AIBT\_EXTx\_BLOCK**) will be set to **EFI\_HII\_AIBT\_DUPLICATE**.

### 32.3.10.2.10 EFI\_HII\_AIBT\_SKIP1

#### Summary

Skips animation IDs.

#### Prototype

```
typedef struct _EFI_HII_AIBT_SKIP1_BLOCK {  
    UINT8      SkipCount;  
} EFI_HII_AIBT_SKIP1_BLOCK;
```

#### Members

*SkipCount* The unsigned 8-bit value to add to *AnimationIdCurrent*.

#### Discussion

Increments the current animation ID *AnimationIdCurrent* by the number specified. The header type (either *BlockType* in **EFI\_HII\_ANIMATION\_BLOCK** or *BlockType2* in **EFI\_HII\_AIBT\_EXTx\_BLOCK**) will be set to **EFI\_HII\_AIBT\_SKIP1**.

### 32.3.10.2.11 EFI\_HII\_AIBT\_SKIP2

#### Summary

Skips animation IDs.

#### Prototype

```
typedef struct _EFI_HII_AIBT_SKIP2_BLOCK {  
    UINT16     SkipCount;  
} EFI_HII_AIBT_SKIP2_BLOCK;
```

#### Members

*SkipCount* The unsigned 16-bit value to add to *AnimationIdCurrent*.

#### Discussion

Increments the current animation ID *AnimationIdCurrent* by the number specified. The header type (either *BlockType* in **EFI\_HII\_ANIMATION\_BLOCK** or *BlockType2* in **EFI\_HII\_AIBT\_EXTx\_BLOCK**) will be set to **EFI\_HII\_AIBT\_SKIP2**.





## 33 HII Protocols

---

This section provides code definitions for the HII-related protocols, functions, and type definitions, which are the required architectural mechanisms by which UEFI-compliant systems manage user input. The major areas described include the following:

- Font management.
- String management.
- Image management.
- Database management.

### 33.1 Font Protocol

#### EFI\_HII\_FONT\_PROTOCOL

##### Summary

Interfaces which retrieve font information.

##### GUID

```
#define EFI_HII_FONT_PROTOCOL_GUID \
{ 0xe9ca4775, 0x8657, 0x47fc, \
  {0x97, 0xe7, 0x7e, 0xd6, 0x5a, 0x8, 0x43, 0x24 } }
```

##### Protocol

```
typedef struct _EFI_HII_FONT_PROTOCOL {
  EFI_HII_STRING_TO_IMAGE StringToImage;
  EFI_HII_STRING_ID_TO_IMAGE StringIdToImage;
  EFI_HII_GET_GLYPH GetGlyph;
  EFI_HII_GET_FONT_INFO GetFontInfo;
} EFI_HII_FONT_PROTOCOL;
```

##### Members

*StringToImage, StringIdToImage*

Render a string to a bitmap or to the display.

*GetGlyph*

Return a specific glyph in a specific font.

*GetFontInfo*

Return font information for a specific font.

## EFI\_HII\_FONT\_PROTOCOL.StringToImage()

### Summary

Renders a string to a bitmap or to the display.

### Prototype

```
typedef
EFI_STATUS
(EFI_API *EFI_HII_STRING_TO_IMAGE) (
  IN CONST EFI_HII_FONT_PROTOCOL *This,
  IN EFI_HII_OUT_FLAGS   Flags,
  IN CONST EFI_STRING   String,
  IN CONST EFI_FONT_DISPLAY_INFO *StringInfo OPTIONAL,
  IN OUT EFI_IMAGE_OUTPUT **Blit,
  IN UINTN               BlitX,
  IN UINTN               BlitY,
  OUT EFI_HII_ROW_INFO   **RowInfoArray OPTIONAL,
  OUT UINTN              *RowInfoArraySize OPTIONAL,
  OUT UINTN              *ColumnInfoArray OPTIONAL
);
```

### Parameters

#### *This*

A pointer to the **EFI\_HII\_FONT\_PROTOCOL** instance.

#### *Flags*

Describes how the string is to be drawn. **EFI\_HII\_OUT\_FLAGS** is defined in Related Definitions, below.

#### *String*

Points to the null-terminated string to be displayed.

#### *StringInfo*

Points to the string output information, including the color and font. If NULL, then the string will be output in the default system font and color.

#### *Blit*

If this points to a non-NULL on entry, this points to the image, which is *Blit.Width* pixels wide and *Blit.Height* pixels high. The string will be drawn onto this image and **EFI\_HII\_OUT\_FLAG\_CLIP** is implied. If this points to a NULL on entry, then a buffer will be allocated to hold the generated image and the pointer updated on exit. It is the caller's responsibility to free this buffer.

#### *BlitX, BlitY*

Specifies the offset from the left and top edge of the image of the first character cell in the image.

*RowInfoArray*

If this is non-NULL on entry, then on exit, this will point to an allocated buffer containing row information and *RowInfoArraySize* will be updated to contain the number of elements. This array describes the characters which were at least partially drawn and the heights of the rows. It is the caller's responsibility to free this buffer.

*RowInfoArraySize*

If this is non-NULL on entry, then on exit it contains the number of elements in *RowInfoArray*.

*ColumnInfoArray*

If this is non-NULL, then on return it will be filled with the horizontal offset for each character in the string on the row where it is displayed. Non-printing characters will have the offset ~0. The caller is responsible to allocate a buffer large enough so that there is one entry for each character in the string, not including the null-terminator. It is possible when character display is normalized that some character cells overlap.

## Description

This function renders a string to a bitmap or the screen using the specified font, color and options. It either draws the string and glyphs on an existing bitmap, allocates a new bitmap or uses the screen. The strings can be clipped or wrapped. Optionally, the function also returns the information about each row and the character position on that row.

If **EFI\_HII\_OUT\_FLAG\_CLIP** is set, then text will be formatted only based on explicit line breaks and all pixels which would lie outside the bounding box specified by *Blt.Width* and *Blt.Height* are ignored. The information in the *RowInfoArray* only describes characters which are at least partially displayed. For the final row, the *RowInfoArray.LineHeight* and *RowInfoArray.BaseLine* may describe pixels which are outside the limit specified by *Blt.Height* (unless **EFI\_HII\_OUT\_FLAG\_CLIP\_CLEAN\_Y** is specified) even though those pixels were not drawn. The *LineWidth* may describe pixels which are outside the limit specified by *Blt.Width* (unless **EFI\_HII\_OUT\_FLAG\_CLIP\_CLEAN\_X** is specified) even though those pixels were not drawn.

If **EFI\_HII\_OUT\_FLAG\_CLIP\_CLEAN\_X** is set, then it modifies the behavior of **EFI\_HII\_OUT\_FLAG\_CLIP** so that if a character's right-most on pixel cannot fit, then it will not be drawn at all. This flag requires that **EFI\_HII\_OUT\_FLAG\_CLIP** be set.

If **EFI\_HII\_OUT\_FLAG\_CLIP\_CLEAN\_Y** is set, then it modifies the behavior of **EFI\_HII\_OUT\_FLAG\_CLIP** so that if a row's bottom-most pixel cannot fit, then it will not be drawn at all. This flag requires that **EFI\_HII\_OUT\_FLAG\_CLIP** be set.

If **EFI\_HII\_OUT\_FLAG\_WRAP** is set, then text will be wrapped at the right-most line-break opportunity prior to a character whose right-most extent would exceed *Blt.Width*. If no line-break opportunity can be found, then the text will behave as if **EFI\_HII\_OUT\_FLAG\_CLIP\_CLEAN\_X** is set. This flag cannot be used with **EFI\_HII\_OUT\_FLAG\_CLIP\_CLEAN\_X**.

If **EFI\_HII\_OUT\_FLAG\_TRANSPARENT** is set, then *StringInfo.BackgroundColor* is ignored and all “off” pixels in the character’s drawn will use the pixel value from *Blit*. This flag cannot be used if *Blit* is NULL upon entry.

If **EFI\_HII\_IGNORE\_IF\_NO\_GLYPH** is set, then characters which have no glyphs are not drawn. Otherwise, they are replaced with Unicode character code 0xFFFF (REPLACEMENT CHARACTER).

If **EFI\_HII\_IGNORE\_LINE\_BREAK** is set, then explicit line break characters will be ignored.

If **EFI\_HII\_DIRECT\_TO\_SCREEN** is set, then the string will be written directly to the output device specified by *Screen*. Otherwise the string will be rendered to the bitmap specified by *Bitmap*.

## Related Definitions

```
typedef UINT32 EFI_HII_OUT_FLAGS;
```

```
#define EFI_HII_OUT_FLAG_CLIP    0x00000001
#define EFI_HII_OUT_FLAG_WRAP   0x00000002
#define EFI_HII_OUT_FLAG_CLIP_CLEAN_Y 0x00000004
#define EFI_HII_OUT_FLAG_CLIP_CLEAN_X 0x00000008
#define EFI_HII_OUT_FLAG_TRANSPARENT 0x00000010
#define EFI_HII_IGNORE_IF_NO_GLYPH 0x00000020
#define EFI_HII_IGNORE_LINE_BREAK 0x00000040
#define EFI_HII_DIRECT_TO_SCREEN 0x00000080
```

```
typedef CHAR16 *EFI_STRING;
```

```
typedef struct _EFI_HII_ROW_INFO {
    UINTN StartIndex;
    UINTN EndIndex;
    UINTN LineHeight;
    UINTN LineWidth;
    UINTN BaselineOffset;
} EFI_HII_ROW_INFO;
```

### *StartIndex*

The index of the first character in the string which is displayed on the line.

### *EndIndex*

The index of the last character in the string which is displayed on the line.

### *LineHeight*

The height of the line, in pixels.

### *LineWidth*

The width of the text on the line, in pixels.

### *BaselineOffset*

The font baseline offset in pixels from the bottom of the row, or 0 if none.

## Status Codes Returned

EFI_SUCCESS	The string was successfully updated.
EFI_OUT_OF_RESOURCES	Unable to allocate an output buffer for <i>RowInfoArray</i> or <i>Blk</i> .
EFI_INVALID_PARAMETER	The <i>String</i> or <i>Blk</i> was NULL.
EFI_INVALID_PARAMETER	Flags were invalid combination

## EFI\_HII\_FONT\_PROTOCOL.StringIdToImage()

### Summary

Render a string to a bitmap or the screen containing the contents of the specified string.

### Prototype

```
typedef
EFI_STATUS
(EFI_API *EFI_HII_STRING_ID_TO_IMAGE) (
  IN CONST EFI_HII_FONT_PROTOCOL *This,
  IN EFI_HII_OUT_FLAGS   Flags,
  IN EFI_HII_HANDLE     PackageList,
  IN EFI_STRING_ID      StringId,
  IN CONST CHAR8*       Language,
  IN CONST EFI_FONT_DISPLAY_INFO *StringInfo OPTIONAL,
  IN OUT EFI_IMAGE_OUTPUT **Bit,
  IN UINTN              BitX,
  IN UINTN              BitY,
  OUT EFI_HII_ROW_INFO  **RowInfoArray OPTIONAL,
  OUT UINTN             *RowInfoArraySize OPTIONAL,
  OUT UINTN             *ColumnInfoArray OPTIONAL
);
```

### Parameters

#### *This*

A pointer to the **EFI\_HII\_FONT\_PROTOCOL** instance.

#### *Flags*

Describes how the string is to be drawn. **EFI\_HII\_OUT\_FLAGS** is defined in Related Definitions, below.

#### *PackageList*

The package list in the HII database to search for the specified string.

#### *StringId*

The string's id, which is unique within *PackageList*.

#### *Language*

Points to the language for the retrieved string. If NULL, then the current system language is used.

#### *StringInfo*

Points to the string output information, including the color and font. If NULL, then the string will be output in the default system font and color.

***Blt***

If this points to a non-NULL on entry, this points to the image, which is *Blt.Width* pixels wide and *Height* pixels high. The string will be drawn onto this image and **EFI\_HII\_OUT\_FLAG\_CLIP** is implied. If this points to a NULL on entry, then a buffer will be allocated to hold the generated image and the pointer updated on exit. It is the caller's responsibility to free this buffer.

***BltX, BltY***

Specifies the offset from the left and top edge of the output image of the first character cell in the image.

***RowInfoArray***

If this is non-NULL on entry, then on exit, this will point to an allocated buffer containing row information and *RowInfoArraySize* will be updated to contain the number of elements. This array describes the characters which were at least partially drawn and the heights of the rows. It is the caller's responsibility to free this buffer.

***RowInfoArraySize***

If this is non-NULL on entry, then on exit it contains the number of elements in *RowInfoArray*.

***ColumnInfoArray***

If non-NULL, on return it is filled with the horizontal offset for each character in the string on the row where it is displayed. Non-printing characters will have the offset -0. The caller is responsible to allocate a buffer large enough so that there is one entry for each character in the string, not including the null-terminator. It is possible when character display is normalized that some character cells overlap.

## Description

This function renders a string as a bitmap or to the screen and can clip or wrap the string. The bitmap is either supplied by the caller or else is allocated by the function. The strings are drawn with the font, size and style specified and can be drawn transparently or opaquely. The function can also return information about each row and each character's position on the row.

If **EFI\_HII\_OUT\_FLAG\_CLIP** is set, then text will be formatted only based on explicit line breaks and all pixels which would lie outside the bounding box specified by *Width* and *Height* are ignored. The information in the *RowInfoArray* only describes characters which are at least partially displayed. For the final row, the LineHeight and BaseLine may describe pixels which are outside the limit specified by *Height* (unless **EFI\_HII\_OUT\_FLAG\_CLIP\_CLEAN\_Y** is specified) even though those pixels were not drawn.

If **EFI\_HII\_OUT\_FLAG\_CLIP\_CLEAN\_X** is set, then it modifies the behavior of **EFI\_HII\_OUT\_FLAG\_CLIP** so that if a character's right-most on pixel cannot fit, then it will not be drawn at all. This flag requires that **EFI\_HII\_OUT\_FLAG\_CLIP** be set.

If **EFI\_HII\_OUT\_FLAG\_CLIP\_CLEAN\_Y** is set, then it modifies the behavior of **EFI\_HII\_OUT\_FLAG\_CLIP** so that if a row's bottom most pixel cannot fit, then it will not be drawn at all. This flag requires that **EFI\_HII\_OUT\_FLAG\_CLIP** be set.

If **EFI\_HII\_OUT\_FLAG\_WRAP** is set, then text will be wrapped at the right-most line-break opportunity prior to a character whose right-most extent would exceed *Width*. If no line-break opportunity can be found, then the text will behave as if **EFI\_HII\_OUT\_FLAG\_CLIP\_CLEAN\_X** is set. This flag cannot be used with **EFI\_HII\_OUT\_FLAG\_CLIP\_CLEAN\_X**.

If **EFI\_HII\_OUT\_FLAG\_TRANSPARENT** is set, then *BackgroundColor* is ignored and all "off" pixels in the character's glyph will use the pixel value from *Blit*. This flag cannot be used if *Blit* is NULL upon entry.

If **EFI\_HII\_IGNORE\_IF\_NO\_GLYPH** is set, then characters which have no glyphs are not drawn. Otherwise, they are replaced with Unicode character code 0xFFFFD (REPLACEMENT CHARACTER).

If **EFI\_HII\_IGNORE\_LINE\_BREAK** is set, then explicit line break characters will be ignored.

If **EFI\_HII\_DIRECT\_TO\_SCREEN** is set, then the string will be written directly to the output device specified by *Screen*. Otherwise the string will be rendered to the bitmap specified by *Bitmap*.

## Status Codes Returned

EFI_SUCCESS	The string was successfully updated.
EFI_OUT_OF_RESOURCES	Unable to allocate an output buffer for <i>RowInfoArray</i> or <i>Blit</i> .
EFI_INVALID_PARAMETER	The <i>StringId</i> or <i>PackageList</i> was <b>NULL</b> .
EFI_INVALID_PARAMETER	<i>Flags</i> were invalid combination.
EFI_NOT_FOUND	The <i>StringId</i> is not in the specified <i>PackageList</i> . The specified <i>PackageList</i> is not in the Database.



## EFI\_HII\_FONT\_PROTOCOL.GetGlyph()

### Summary

Return image and information about a single glyph.

### Prototype

```
typedef
EFI_STATUS
(EFI_API *EFI_HII_GET_GLYPH) (
  IN CONST EFI_HII_FONT_PROTOCOL *This,
  IN CHAR16 Char,
  IN CONST EFI_FONT_DISPLAY_INFO *StringInfo,
  OUT EFI_IMAGE_OUTPUT **Blit,
  OUT UINTN *Baseline OPTIONAL;
);
```

### Parameters

*This*

A pointer to the **EFI\_HII\_FONT\_PROTOCOL** instance.

*Char*

Character to retrieve.

*StringInfo*

Points to the string font and color information or NULL if the string should use the default system font and color.

*Blit*

Thus must point to a NULL on entry. A buffer will be allocated to hold the output and the pointer updated on exit. It is the caller's responsibility to free this buffer. On return, only *Blit.Width*, *Blit.Height*, and *Blit.Image.Bitmap* are valid.

*Baseline*

Number of pixels from the bottom of the bitmap to the baseline.

### Description

Convert the glyph for a single character into a bitmap.

### Status Codes Returned

EFI_SUCCESS	Glyph bitmap created.
EFI_OUT_OF_RESOURCES	Unable to allocate the output buffer <i>Blit</i> .
EFI_WARN_UNKNOWN_GLYPH	The glyph was unknown and was replaced with the glyph for Unicode character code 0xFFFFD.

EFI\_INVALID\_PARAMETER

*Blt* is NULL or *\*Blt* is !Null

## EFI\_HII\_FONT\_PROTOCOL.GetFontInfo()

### Summary

Return information about a particular font.

### Prototype

```
typedef
EFI_STATUS
(EFI_API *EFI_HII_GET_FONT_INFO) (
  IN CONST EFI_HII_FONT_PROTOCOL *This,
  IN OUT EFI_FONT_HANDLE *FontHandle,
  IN CONST EFI_FONT_DISPLAY_INFO *StringInfoIn, OPTIONAL
  OUT EFI_FONT_DISPLAY_INFO **StringInfoOut,
  IN CONST EFI_STRING String OPTIONAL
);

typedef VOID *EFI_FONT_HANDLE;
```

### Parameters

#### *This*

A pointer to the **EFI\_HII\_FONT\_PROTOCOL** instance.

#### *FontHandle*

On entry, points to the font handle returned by a previous call to **GetFontInfo()** or points to NULL to start with the first font. On return, points to the returned font handle or points to NULL if there are no more matching fonts.

#### *StringInfoIn*

Upon entry, points to the font to return information about. If NULL, then the information about the system default font will be returned.

#### *StringInfoOut*

Upon return, contains the matching font's information. If NULL, then no information is returned. This buffer is allocated with a call to the **Boot Service AllocatePool()**. It is the caller's responsibility to call the **Boot Service FreePool()** when the caller no longer requires the contents of *StringInfoOut*.

#### *String*

Points to the string which will be tested to determine if all characters are available. If NULL, then any font is acceptable.

### Description

This function iterates through fonts which match the specified font, using the specified criteria. If *String* is non-NULL, then all of the characters in the string must exist in order for a candidate font to be returned.

## Status Codes Returned

EFI_SUCCESS	Matching font returned successfully.
EFI_NOT_FOUND	No matching font was found.
EFI_OUT_OF_RESOURCES	There were insufficient resources to complete the request.

## 33.2 EFI HII Font Ex Protocol

The EFI HII Font Ex protocol defines an extension to the EFI HII Font protocol which enables various new capabilities described in this section.

### EFI\_HII\_FONT\_EX\_PROTOCOL

#### Summary

Interfaces which retrieve the font information.

#### GUID

```
#define EFI_HII_FONT_EX_PROTOCOL_GUID \
  { 0x849e6875, 0xdb35, 0x4df8, 0xb4, \
    {0x1e, 0xc8, 0xf3, 0x37, 0x18, 0x7, 0x3f } }
```

#### Protocol

```
typedef struct _EFI_HII_FONT_EX_PROTOCOL {
  EFI_HII_STRING_TO_IMAGE_EX  StringToImageEx;
  EFI_HII_STRING_ID_TO_IMAGE_EX StringIdToImageEx;
  EFI_HII_GET_GLYPH_EX       GetGlyphEx;
  EFI_HII_GET_FONT_INFO_EX   GetFontInfoEx;
  EFI_HII_GET_GLYPH_INFO     GetGlyphInfo;
} EFI_HII_FONT_EX_PROTOCOL;
```

#### Members

*StringToImageEx, StringIdToImageEx*

Render a string to a bitmap or to the display. This function will try to use the external font glyph generator for generating the glyph if it can't find the glyph in the font database.

*GetGlyphEx*

Return a specific glyph in a specific font. This function will try to use the external font glyph generator for generating the glyph if it can't find the glyph in the font database.

*GetFontInfoEx*

Return the font information for a specific font, this protocol invokes original **EFI\_HII\_FONT\_PROTOCOL.GetFontInfo()** implicitly.

*GetGlyphInfoEx*

Return the glyph information for the single glyph.

## EFI\_HII\_FONT\_EX\_PROTOCOL.StringToImageEx()

### Summary

Render a string to a bitmap or to the display. The prototype of this extension function is the same with [EFI\\_HII\\_FONT\\_PROTOCOL.StringToImage\(\)](#).

### Protocol

```
typedef
EFI_STATUS
(EFI_API *EFI_HII_STRING_TO_IMAGE_EX)(
    IN CONST EFI_HII_FONT_EX_PROTOCOL *This,
    IN EFI_HII_OUT_FLAGS    Flags,
    IN CONST EFI_STRING    String,
    IN CONST EFI_FONT_DISPLAY_INFO *StringInfo OPTIONAL,
    IN OUT EFI_IMAGE_OUTPUT  **Blit,
    IN UINTN                BlitX,
    IN UINTN                BlitY,
    OUT EFI_HII_ROW_INFO    **RowInfoArray OPTIONAL,
    OUT UINTN               *RowInfoArraySize OPTIONAL,
    OUT UINTN               *ColumnInfoArray OPTIONAL
);
```

### Parameters

Same with [EFI\\_HII\\_FONT\\_PROTOCOL.StringToImage\(\)](#).

### Description

This function is similar to [EFI\\_HII\\_FONT\\_PROTOCOL.StringToImage\(\)](#). The difference is that this function will locate all [EFI\\_HII\\_FONT\\_GLYPH\\_GENERATOR\\_PROTOCOL](#) instances that are installed in the system when the glyph in the string with the given font information is not found in the current HII glyph database. The function will attempt to generate the glyph information and the bitmap using the first [EFI\\_HII\\_FONT\\_GLYPH\\_GENERATOR\\_PROTOCOL](#) instance that supports the requested font information in the [EFI\\_FONT\\_DISPLAY\\_INFO](#).

### Status Codes Returned

Same with [EFI\\_HII\\_FONT\\_PROTOCOL.StringToImage\(\)](#).

## EFI\_HII\_FONT\_EX\_PROTOCOL.StringIdToImageEx()

### Summary

Render a string to a bitmap or the screen containing the contents of the specified string. The prototype of this extension function is the same with **EFI\_HII\_FONT\_PROTOCOL.StringIdToImage()**.

### Protocol

```
typedef
EFI_STATUS
(EFIAPI *EFI_HII_STRING_ID_TO_IMAGE_EX)(
  IN CONST EFI_HII_FONT_EX_PROTOCOL *This,
  IN EFI_HII_OUT_FLAGS    Flags,
  IN EFI_HII_HANDLE      PackageList,
  IN EFI_STRING_ID      StringId,
  IN CONST CHAR8        *Language,
  IN CONST EFI_FONT_DISPLAY_INFO *StringInfo OPTIONAL,
  IN OUT EFI_IMAGE_OUTPUT **Blit,
  IN UINTN              BlitX,
  IN UINTN              BlitY,
  OUT EFI_HII_ROW_INFO  **RowInfoArray OPTIONAL,
  OUT UINTN             *RowInfoArraySize OPTIONAL,
  OUT UINTN             *ColumnInfoArray OPTIONAL
);
```

### Parameters

Same with **EFI\_HII\_FONT\_PROTOCOL.StringIdToImage()**.

### Description

This function is similar to **EFI\_HII\_FONT\_PROTOCOL.StringIdToImage()**. The difference is that this function will locate all **EFI\_HII\_FONT\_GLYPH\_GENERATOR\_PROTOCOL** instances that are installed in the system when the glyph in the string with the given font information is not found in the current HII glyph database. The function will attempt to generate the glyph information and the bitmap using the first **EFI\_HII\_FONT\_GLYPH\_GENERATOR\_PROTOCOL** instance that supports the requested font information in the **EFI\_FONT\_DISPLAY\_INFO**.

### Status Codes Returned

Same with **EFI\_HII\_FONT\_PROTOCOL.StringToImage()**.

## EFI\_HII\_FONT\_EX\_PROTOCOL.GetGlyphEx()

### Summary

Return image and baseline about a single glyph. The prototype of this extension function is the same with [EFI\\_HII\\_FONT\\_PROTOCOL.GetGlyph\(\)](#).

### Protocol

```
typedef
EFI_STATUS
(EFIAPI *EFI_HII_GET_GLYPH_EX)(
    IN CONST EFI_HII_FONT_EX_PROTOCOL *This,
    IN CHAR16 Char,
    IN CONST EFI_FONT_DISPLAY_INFO *StringInfo,
    IN OUT EFI_IMAGE_OUTPUT **Blt,
    IN UINTN Baseline OPTIONAL
);
```

### Parameters

Same with [EFI\\_HII\\_FONT\\_PROTOCOL.GetGlyph\(\)](#).

### Description

This function is similar to [EFI\\_HII\\_FONT\\_PROTOCOL.GetGlyph\(\)](#). The difference is that this function will locate all [EFI\\_HII\\_FONT\\_GLYPH\\_GENERATOR\\_PROTOCOL](#) instances that are installed in the system when the glyph in the string with the given font information is not found in the current HII glyph database. The function will attempt to generate the glyph information and the bitmap using the first [EFI\\_HII\\_FONT\\_GLYPH\\_GENERATOR\\_PROTOCOL](#) instance that supports the requested font information in the [EFI\\_FONT\\_DISPLAY\\_INFO](#).

### Status Codes Returned

Same as [EFI\\_HII\\_FONT\\_PROTOCOL.GetGlyph\(\)](#).

## EFI\_HII\_FONT\_EX\_PROTOCOL.GetFontInfoEx()

### Summary

Return information about a particular font. The prototype of this extension function is the same with [EFI\\_HII\\_FONT\\_PROTOCOL.GetFontInformation\(\)](#).

### Protocol

```
typedef
EFI_STATUS
(EFI_API *EFI_HII_GET_FONT_INFO_EX)(
    IN CONST EFI_HII_FONT_EX_PROTOCOL *This,
    IN OUT EFI_FONT_HANDLE *FontHandle,
    IN CONST EFI_FONT_DISPLAY_INFO *StringInfoIn, OPTIONAL
    OUT EFI_FONT_DISPLAY_INFO **StringInfoOut,
    IN CONST EFI_STRING String OPTIONAL
);
```

### Parameters

Same with [EFI\\_HII\\_FONT\\_PROTOCOL.GetFontInfo\(\)](#).

### Description

Same with [EFI\\_HII\\_FONT\\_PROTOCOL.GetFontInfo\(\)](#). This protocol invokes [EFI\\_HII\\_FONT\\_PROTOCOL.GetFontInfo\(\)](#) implicitly.

### Status Codes Returned

Same as [EFI\\_HII\\_FONT\\_PROTOCOL.GetFontInfo\(\)](#).



## EFI\_HII\_FONT\_EX\_PROTOCOL.GetGlyphInfo()

### Summary

The function returns the information of the single glyph.

### Protocol

```
typedef
EFI_STATUS
(EFI_API *EFI_HII_GET_GLYPH_INFO)(
  IN CONST EFI_HII_FONT_EX_PROTOCOL *This,
  IN CHAR16 Char,
  IN CONST EFI_FONT_DISPLAY_INFO *FontDisplayInfo,
  OUT EFI_HII_GLYPH_INFO * GlyphInfo
);
```

### Parameters

<i>This</i>	<b>EFI_HII_FONT_EX_PROTOCOL</b> instance.
<i>Char</i>	Information of Character to retrieve.
<i>FontDisplayInfo</i>	Font display information of this character.
<i>GlyphInfo</i>	Pointer to retrieve the glyph information.

### Description

This function returns the glyph information of character in the specific font family. This function will locate all **EFI\_HII\_FONT\_GLYPH\_GENERATOR** protocol instances that are installed in the system, and attempt to use them if it can't find the glyph information in the font database. It returns **EFI\_UNSUPPORTED** if neither the font database nor any instances of the **EFI\_HII\_FONT\_GLYPH\_GENERATOR** protocols support the font glyph in the specific font family. Otherwise, the **EFI\_HII\_GLYPH\_INFO** is returned in *GlyphInfo*. This function only returns the glyph geometry information instead of allocating the buffer for **EFI\_IMAGE\_OUTPUT** and drawing the glyph in the buffer.

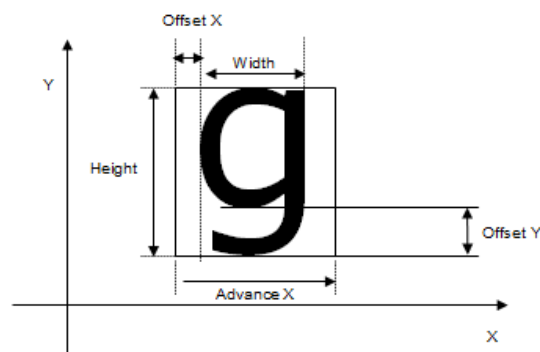

Figure 136. Glyph Example

## Status Codes Returned

EFI_SUCCESS	The glyph information was returned to <i>GlyphInfo</i> .
EFI_OUT_OF_RESOURCES	Memory allocation failed in this function.
EFI_NOT_FOUND	The input character was not found in the database.
EFI_UNSUPPORTED	The font is not supported.
EFI_INVALID_PARAMETER	The <i>GlyphInfo</i> or <i>FontDisplayInfo</i> was NULL.

## 33.2.1 Code Definitions

### EFI\_FONT\_DISPLAY\_INFO

#### Summary

Describes font output-related information.

#### Prototype

```
typedef struct _EFI_FONT_DISPLAY_INFO {
    EFI_GRAPHICS_OUTPUT_BLT_PIXEL ForegroundColor;
    EFI_GRAPHICS_OUTPUT_BLT_PIXEL BackgroundColor;
    EFI_FONT_INFO_MASK FontInfoMask;
    EFI_FONT_INFO FontInfo
} EFI_FONT_DISPLAY_INFO;
```

#### Members

##### *FontInfo*

The font information. Type **EFI\_FONT\_INFO** is defined in **EFI\_HII\_STRING\_PROTOCOL.NewString()**.

##### *ForegroundColor*

The color of the "on" pixels in the glyph in the bitmap.

##### *BackgroundColor*

The color of the "off" pixels in the glyph in the bitmap.

##### *FontInfoMask*

The font information mask determines which portion of the font information will be used and what to do if the specific font is not available.

#### Description

This structure is used for describing the way in which a string should be rendered in a particular font. *FontInfo* specifies the basic font information and *ForegroundColor* and *BackgroundColor* specify the color in which they should be displayed. The flags in *FontInfoMask* describe where the system default should be supplied instead of the specified information. The flags also describe what options can be used to make a match between the font requested and the font available.

If **EFI\_FONT\_INFO\_SYS\_FONT** is specified, then the font name in *FontInfo* is ignored and the system font name is used. This flag cannot be used with **EFI\_FONT\_INFO\_ANY\_FONT**.

If **EFI\_FONT\_INFO\_SYS\_SIZE** is specified, then the font height specified in *FontInfo* is ignored and the system font height is used instead. This flag cannot be used with **EFI\_FONT\_INFO\_ANY\_SIZE**.

If **EFI\_FONT\_INFO\_SYS\_STYLE** is specified, then the font style in *FontInfo* is ignored and the system font style is used. This flag cannot be used with **EFI\_FONT\_INFO\_ANY\_STYLE**.

If **EFI\_FONT\_INFO\_SYS\_FORE\_COLOR** is specified, then *ForegroundColor* is ignored and the system foreground color is used.

If **EFI\_FONT\_INFO\_SYS\_BACK\_COLOR** is specified, then *BackgroundColor* is ignored and the system background color is used.

If **EFI\_FONT\_INFO\_RESIZE** is specified, then the system may attempt to stretch or shrink a font to meet the size requested. This flag cannot be used with **EFI\_FONT\_INFO\_ANY\_SIZE**.

If **EFI\_FONT\_INFO\_RESTYLE** is specified, then the system may attempt to remove some of the specified styles in order to meet the style requested. This flag cannot be used with **EFI\_FONT\_INFO\_ANY\_STYLE**.

If **EFI\_FONT\_INFO\_ANY\_FONT** is specified, then the system may attempt to match with any font. This flag cannot be used with **EFI\_FONT\_INFO\_SYS\_FONT**.

If **EFI\_FONT\_INFO\_ANY\_SIZE** is specified, then the system may attempt to match with any font size. This flag cannot be used with **EFI\_FONT\_INFO\_SYS\_SIZE** or **EFI\_FONT\_INFO\_RESIZE**.

If **EFI\_FONT\_INFO\_ANY\_STYLE** is specified, then the system may attempt to match with any font style. This flag cannot be used with **EFI\_FONT\_INFO\_SYS\_STYLE** or **EFI\_FONT\_INFO\_RESTYLE**.

## Related Definitions

```
typedef UINT32 EFI_FONT_INFO_MASK;

#define EFI_FONT_INFO_SYS_FONT 0x00000001
#define EFI_FONT_INFO_SYS_SIZE 0x00000002
#define EFI_FONT_INFO_SYS_STYLE 0x00000004
#define EFI_FONT_INFO_SYS_FORE_COLOR 0x00000010
#define EFI_FONT_INFO_SYS_BACK_COLOR 0x00000020
#define EFI_FONT_INFO_RESIZE 0x00001000
#define EFI_FONT_INFO_RESTYLE 0x00002000
#define EFI_FONT_INFO_ANY_FONT 0x00010000
#define EFI_FONT_INFO_ANY_SIZE 0x00020000
#define EFI_FONT_INFO_ANY_STYLE 0x00040000
```

## EFI\_IMAGE\_OUTPUT

### Summary

Describes information about either a bitmap or a graphical output device.

### Prototype

```
typedef struct _EFI_IMAGE_OUTPUT {
    UINT16      Width;
    UINT16      Height;
    union {
        EFI_GRAPHICS_OUTPUT_BLT_PIXEL *Bitmap;
        EFI_GRAPHICS_OUTPUT_PROTOCOL *Screen;
    } Image;
} EFI_IMAGE_OUTPUT;
```

### Members

*Width*

Width of the output image.

*Height*

Height of the output image.

*Bitmap*

Points to the output bitmap.

*Screen*

Points to the **EFI\_GRAPHICS\_OUTPUT\_PROTOCOL** which describes the screen on which to draw the specified string.

## 33.3 String Protocol

### EFI\_HII\_STRING\_PROTOCOL

#### Summary

Interfaces which manipulate string data.

#### GUID

```
#define EFI_HII_STRING_PROTOCOL_GUID \
{ 0xfd96974, 0x23aa, 0x4cdc, \
  { 0xb9, 0xcb, 0x98, 0xd1, 0x77, 0x50, 0x32, 0x2a }}
```

#### Protocol

```
typedef struct _EFI_HII_STRING_PROTOCOL {
  EFI_HII_NEW_STRING  NewString;
  EFI_HII_GET_STRING  GetString;
  EFI_HII_SET_STRING  SetString;
  EFI_HII_GET_LANGUAGES  GetLanguages;
  EFI_HII_GET_2ND_LANGUAGES  GetSecondaryLanguages;
} EFI_HII_STRING_PROTOCOL;
```

#### Members

##### *NewString*

Add a new string.

##### *GetString*

Retrieve a string and related string information.

##### *SetString*

Change a string.

##### *GetLanguages*

List the languages for a particular package list.

##### *GetSecondaryLanguages*

List supported secondary languages for a particular primary language.

## EFI\_HII\_STRING\_PROTOCOL.NewString()

### Summary

Creates a new string in a specific language and add it to strings from a specific package list.

### Prototype

```
typedef
EFI_STATUS
(EFIAPI *EFI_HII_NEW_STRING) (
  IN CONST EFI_HII_STRING_PROTOCOL *This,
  IN EFI_HII_HANDLE      PackageList,
  OUT EFI_STRING_ID      *StringId,
  IN CONST CHAR8         *Language,
  IN CONST CHAR16        *LanguageName OPTIONAL,
  IN CONST EFI_STRING    String,
  IN CONST EFI_FONT_INFO *StringFontInfo
);
```

### Parameters

#### *This*

A pointer to the **EFI\_HII\_STRING\_PROTOCOL** instance.

#### *PackageList*

Handle of the package list where this string will be added.

#### *Language*

Points to the language for the new string. The language information is in the format described by [Appendix M](#) of the UEFI Specification.

#### *LanguageName*

Points to the printable language name to associate with the passed in *Language* field. This is analogous to passing in "zh-Hans" in the *Language* field and *LanguageName* might contain "Simplified Chinese" as the printable language.

#### *String*

Points to the new null-terminated string.

#### *StringFontInfo*

Points to the new string's font information or NULL if the string should have the default system font, size and style.

#### *StringId*

On return, contains the new strings id, which is unique within *PackageList*. Type **EFI\_STRING\_ID** is defined in [Section 32.3.8.2.1](#).

## Description

This function adds the string *String* to the group of strings owned by *PackageList*, with the specified font information *StringFontInfo* and returns a new string id. The new string identifier is guaranteed to be unique within the package list. That new string identifier is reserved for all languages in the package list.

## Related Definitions

```
typedef struct {
    EFI_HII_FONT_STYLE FontStyle;
    UINT16 FontSize;
    CHAR16 FontName[...];
} EFI_FONT_INFO;
```

### *FontStyle*

The design style of the font. Type **EFI\_HII\_FONT\_STYLE** is defined in [Section 32.3.3.1](#).

### *FontSize*

The character cell height, in pixels.

### *FontName*

The null-terminated font family name.

## Status Codes Returns

EFI_SUCCESS	The new string was added successfully
EFI_OUT_OF_RESOURCES	Could not add the string.
EFI_INVALID_PARAMETER	<i>String</i> is NULL or <i>StringId</i> is NULL or <i>Language</i> is NULL.
EFI_NOT_FOUND	The input package list could not be found in the current database.

## EFI\_HII\_STRING\_PROTOCOL.GetString()

### Summary

Returns information about a string in a specific language, associated with a package list.

### Prototype

```
typedef
EFI_STATUS
(EFI_API *EFI_HII_GET_STRING) (
  IN CONST EFI_HII_STRING_PROTOCOL *This,
  IN CONST CHAR8 *Language,
  IN EFI_HII_HANDLE PackageList,
  IN EFI_STRING_ID StringId,
  OUT EFI_STRING String,
  IN OUT UINTN *StringSize,
  OUT EFI_FONT_INFO **StringFontInfo OPTIONAL
);
```

### Parameters

#### *This*

A pointer to the **EFI\_HII\_STRING\_PROTOCOL** instance.

#### *PackageList*

The package list in the HII database to search for the specified string.

#### *Language*

Points to the language for the retrieved string. Callers of interfaces that require RFC 4646 language codes to retrieve a Unicode string must use the RFC 4647 algorithm to lookup the Unicode string with the closest matching RFC 4646 language code.

#### *StringId*

The string's id, which is unique within *PackageList*.

#### *String*

Points to the new null-terminated string.

#### *StringSize*

On entry, points to the size of the buffer pointed to by *String*, in bytes. On return, points to the length of the string, in bytes.

#### *StringFontInfo*

Points to a buffer that will be callee allocated and will have the string's font information into this buffer. The caller is responsible for freeing this buffer. If the parameter is NULL a buffer will not be allocated and the string font information will not be returned.



## Description

This function retrieves the string specified by *StringId* which is associated with the specified *PackageList* in the language *Language* and copies it into the buffer specified by *String*.

If the string specified by *StringId* is not present in the specified *PackageList*, then **EFI\_NOT\_FOUND** is returned. If the string specified by *StringId* is present, but not in the specified language then **EFI\_INVALID\_LANGUAGE** is returned.

If the buffer specified by *StringSize* is too small to hold the string, then **EFI\_BUFFER\_TOO\_SMALL** will be returned. *StringSize* will be updated to the size of buffer actually required to hold the string.

## Status Codes Returned

EFI_SUCCESS	The string was returned successfully.
EFI_NOT_FOUND	The string specified by <i>StringId</i> is not available. The specified <i>PackageList</i> is not in the Database.
EFI_INVALID_LANGUAGE	The string specified by <i>StringId</i> is available but not in the specified language.
EFI_BUFFER_TOO_SMALL	The buffer specified by <i>StringLength</i> is too small to hold the string.
EFI_INVALID_PARAMETER	The <i>Language</i> or <i>StringSize</i> was NULL.
EFI_INVALID_PARAMETER	The value referenced by <i>StringLength</i> was not zero and <i>String</i> was NULL.
EFI_OUT_OF_RESOURCES	There were insufficient resources to complete the request.

## EFI\_HII\_STRING\_PROTOCOL.SetString()

### Summary

Change information about the string.

### Prototype

```
typedef
EFI_STATUS
(EFIAPI *EFI_HII_SET_STRING) (
  IN CONST EFI_HII_STRING_PROTOCOL *This,
  IN EFI_HII_HANDLE    PackageList,
  IN EFI_STRING_ID    StringId,
  IN CONST CHAR8      *Language,
  IN CONST EFI_STRING  String,
  IN CONST EFI_FONT_INFO *StringFontInfo OPTIONAL
);
```

### Parameters

*This*

A pointer to the **EFI\_HII\_STRING\_PROTOCOL** instance.

*PackageList*

The package list containing the strings.

*Language*

Points to the language for the updated string.

*StringId*

The string id, which is unique within *PackageList*.

*String*

Points to the new null-terminated string.

*StringFontInfo*

Points to the string's font information or NULL if the string font information is not changed.

### Description

This function updates the string specified by *StringId* in the specified *PackageList* to the text specified by *String* and, optionally, the font information specified by *StringFontInfo*. There is no way to change the font information without changing the string text.

## Status Codes Returned

EFI_SUCCESS	The string was successfully updated.
EFI_NOT_FOUND	The string specified by <i>StringId</i> is not in the database. The specified <i>PackageList</i> is not in the Database.
EFI_INVALID_PARAMETER	The <i>String</i> or <i>Language</i> was NULL.
EFI_OUT_OF_RESOURCES	The system is out of resources to accomplish the task.

## EFI\_HII\_STRING\_PROTOCOL.GetLanguages()

### Summary

Returns a list of the languages present in strings in a package list.

### Prototype

```
typedef
EFI_STATUS
(EFIAPI *EFI_HII_GET_LANGUAGES) (
  IN CONST EFI_HII_STRING_PROTOCOL *This,
  IN EFI_HII_HANDLE PackageList,
  IN OUT CHAR8 *Languages,
  IN OUT UINTN *LanguagesSize
);
```

### Parameters

*This*

A pointer to the **EFI\_HII\_STRING\_PROTOCOL** instance.

*PackageList*

The package list to examine.

*Languages*

Points to the buffer to hold the returned null-terminated ASCII string.

*LanguageSize*

On entry, points to the size of the buffer pointed to by *Languages*, in bytes.  
On return, points to the length of *Languages*, in bytes.

### Description

This function returns the list of supported languages, in the format specified in [Appendix M](#).

### Status Codes Returned

EFI_SUCCESS	The languages were returned successfully.
EFI_BUFFER_TOO_SMALL	The <i>LanguageSize</i> is too small to hold the list of supported languages. <i>LanguageSize</i> is updated to contain the required size.
EFI_NOT_FOUND	The specified <i>PackageList</i> is not in the Database.
EFI_INVALID_PARAMETER	<i>LanguageSize</i> is NULL.
EFI_INVALID_PARAMETER	The value referenced by <i>LanguageSize</i> is not zero and <i>Languages</i> is NULL.

## EFI\_HII\_STRING\_PROTOCOL.GetSecondaryLanguages()

### Summary

Given a primary language, returns the secondary languages supported in a package list.

### Prototype

```
typedef
EFI_STATUS
(EFIAPI *EFI_HII_GET_2ND_LANGUAGES) (
  IN CONST EFI_HII_STRING_PROTOCOL *This,
  IN EFI_HII_HANDLE PackageList,
  IN CONST CHAR8* PrimaryLanguage,
  IN OUT CHAR8 *SecondaryLanguages,
  IN OUT UINTN *SecondaryLanguagesSize
);
```

### Parameters

#### *This*

A pointer to the **EFI\_HII\_STRING\_PROTOCOL** instance.

#### *PackageList*

The package list to examine.

#### *PrimaryLanguage*

Points to the null-terminated ASCII string that specifies the primary language. Languages are specified in the format specified in [Appendix M](#) of the UEFI Specification.

#### *SecondaryLanguages*

Points to the buffer to hold the returned null-terminated ASCII string that describes the list of secondary languages for the specified *PrimaryLanguage*. If there are no secondary languages, the function returns successfully, but this is set to NULL.

#### *SecondaryLanguagesSize*

On entry, points to the size of the buffer pointed to by *SecondaryLanguages*, in bytes. On return, points to the length of *SecondaryLanguages* in bytes.

### Description

Each string package has associated with it a single primary language and zero or more secondary languages. This routine returns the secondary languages associated with a package list.

### Status Codes Returned

EFI_SUCCESS	Secondary languages correctly returned
-------------	--

EFI_BUFFER_TOO_SMALL	The buffer specified by <i>SecondaryLanguagesSize</i> is too small to hold the returned information. <i>SecondaryLanguageSize</i> is updated to hold the size of the buffer required.
EFI_INVALID_LANGUAGE	The language specified by <i>FirstLanguage</i> is not present in the specified package list.
EFI_NOT_FOUND	The specified <i>PackageList</i> is not in the Database.
EFI_INVALID_PARAMETER	<i>PrimaryLanguage</i> or <i>SecondaryLanguagesSize</i> is NULL.
EFI_INVALID_PARAMETER	The value referenced by <i>SecondaryLanguagesSize</i> is not zero and <i>SecondaryLanguages</i> is NULL.

## 33.4 Image Protocol

### EFI\_HII\_IMAGE\_PROTOCOL

#### Summary

Protocol which allow access to images in the images database.

#### GUID

```
#define EFI_HII_IMAGE_PROTOCOL_GUID \
{ 0x31a6406a, 0x6bdf, 0x4e46, \
  { 0xb2, 0xa2, 0xeb, 0xaa, 0x89, 0xc4, 0x9, 0x20 } }
```

#### Protocol

```
typedef struct _EFI_HII_IMAGE_PROTOCOL {
  EFI_HII_NEW_IMAGE   NewImage;
  EFI_HII_GET_IMAGE   GetImage;
  EFI_HII_SET_IMAGE   SetImage;
  EFI_HII_DRAW_IMAGE  DrawImage;
  EFI_HII_DRAW_IMAGE_ID DrawImageId;
} EFI_HII_IMAGE_PROTOCOL;
```

#### Members

*NewImage*

Add a new image.

*GetImage*

Retrieve an image and related font information.

*SetImage*

Change an image.

## EFI\_HII\_IMAGE\_PROTOCOL.NewImage()

### Summary

Creates a new image and add it to images from a specific package list.

### Prototype

```
typedef
EFI_STATUS
(EFI_API *EFI_HII_NEW_IMAGE) (
  IN CONST EFI_HII_IMAGE_PROTOCOL *This,
  IN EFI_HII_HANDLE    PackageList,
  OUT EFI_IMAGE_ID    *ImageId
  IN CONST EFI_IMAGE_INPUT *Image
);
```

### Parameters

*This*

A pointer to the **EFI\_HII\_IMAGE\_PROTOCOL** instance.

*PackageList*

Handle of the package list where this image will be added.

*ImageId*

On return, contains the new image id, which is unique within *PackageList*.

*Image*

Points to the image.

### Description

This function adds the image *Image* to the group of images owned by *PackageList*, and returns a new image identifier (*ImageId*).

### Related Definitions

```
typedef UINT16 EFI_IMAGE_ID;
typedef struct {
  UINT32    Flags;
  UINT16    Width;
  UINT16    Height;
  EFI_GRAPHICS_OUTPUT_BLT_PIXEL *Bitmap;
} EFI_IMAGE_INPUT;
```

*Flags*

Describe image characteristics. If **EFI\_IMAGE\_TRANSPARENT** is set, then the image was designed for transparent display.

```
#define EFI_IMAGE_TRANSPARENT 0x00000001
```

*Width*

Image width, in pixels.

*Height*

Image height, in pixels.

*Bitmap*

A pointer to the actual bitmap, organized left-to-right, top-to-bottom. The size of the bitmap is *Width \* Height \**  
**sizeof(EFI\_GRAPHICS\_OUTPUT\_BLT\_PIXEL).**

**Status Codes Returns**

EFI_SUCCESS	The new image was added successfully
EFI_OUT_OF_RESOURCES	Could not add the image.
EFI_INVALID_PARAMETER	<i>Image</i> is NULL or <i>ImageId</i> is NULL.
EFI_NOT_FOUND	The <i>PackageList</i> could not be found.



## EFI\_HII\_IMAGE\_PROTOCOL.GetImage()

### Summary

Returns information about an image, associated with a package list.

### Prototype

```
typedef
EFI_STATUS
(EFI_API *EFI_HII_GET_IMAGE) (
  IN CONST EFI_HII_IMAGE_PROTOCOL *This,
  IN EFI_HII_HANDLE   PackageList,
  IN EFI_IMAGE_ID     ImageId,
  OUT EFI_IMAGE_INPUT *Image
);
```

### Parameters

*This*

A pointer to the **EFI\_HII\_IMAGE\_PROTOCOL** instance.

*PackageList*

The package list in the HII database to search for the specified image.

*ImageId*

The image's id, which is unique within *PackageList*.

*Image*

Points to the new image.

### Description

This function retrieves the image specified by *ImageId* which is associated with the specified *PackageList* and copies it into the buffer specified by *Image*.

If the image specified by *ImageId* is not present in the specified *PackageList*, then **EFI\_NOT\_FOUND** is returned.

The actual bitmap (*Image->Bitmap*) should not be freed by the caller and should not be modified directly.

### Status Codes Returned

EFI_SUCCESS	The image was returned successfully.
EFI_NOT_FOUND	The image specified by <i>ImageId</i> is not available. The specified <i>PackageList</i> is not in the Database.
EFI_INVALID_PARAMETER	<i>Image</i> was NULL.
EFI_OUT_OF_RESOURCES	The bitmap could not be retrieved because there was not enough memory.

## EFI\_HII\_IMAGE\_PROTOCOL.SetImage()

### Summary

Change information about the image.

### Prototype

```
typedef
EFI_STATUS
(EFI_API *EFI_HII_SET_IMAGE) (
  IN CONST EFI_HII_IMAGE_PROTOCOL *This,
  IN EFI_HII_HANDLE   PackageList,
  IN EFI_IMAGE_ID     ImageId,
  IN CONST EFI_IMAGE_INPUT *Image,
);
```

### Parameters

*This*

A pointer to the **EFI\_HII\_IMAGE\_PROTOCOL** instance.

*PackageList*

The package list containing the images.

*ImageId*

The image id, which is unique within *PackageList*.

*Image*

Points to the image.

### Description

This function updates the image specified by *ImageId* in the specified *PackageListHandle* to the image specified by *Image*.

### Status Codes Returned

EFI_SUCCESS	The image was successfully updated.
EFI_NOT_FOUND	The image specified by <i>ImageId</i> is not in the database. The specified <i>PackageList</i> is not in the Database.
EFI_INVALID_PARAMETER	The <i>Image</i> was NULL.

## EFI\_HII\_IMAGE\_PROTOCOL.DrawImage()

### Summary

Renders an image to a bitmap or to the display.

### Prototype

```
typedef
EFI_STATUS
(EFI_API *EFI_HII_DRAW_IMAGE) (
  IN CONST EFI_HII_IMAGE_PROTOCOL *This,
  IN EFI_HII_DRAW_FLAGS   Flags,
  IN CONST EFI_IMAGE_INPUT *Image,
  IN OUT EFI_IMAGE_OUTPUT **Blt,
  IN UINTN   BltX,
  IN UINTN   BltY,
);
```

### Parameters

*This*

A pointer to the **EFI\_HII\_IMAGE\_PROTOCOL** instance.

*Flags*

Describes how the image is to be drawn. **EFI\_HII\_DRAW\_FLAGS** is defined in Related Definitions, below.

*Image*

Points to the image to be displayed.

*Blt*

If this points to a non-NULL on entry, this points to the image, which is *Width* pixels wide and *Height* pixels high. The image will be drawn onto this image and **EFI\_HII\_DRAW\_FLAG\_CLIP** is implied. If this points to a NULL on entry, then a buffer will be allocated to hold the generated image and the pointer updated on exit. It is the caller's responsibility to free this buffer.

*BltX, BltY*

Specifies the offset from the left and top edge of the image of the first pixel in the image.

### Description

This function renders an image to a bitmap or the screen using the specified color and options. It draws the image on an existing bitmap, allocates a new bitmap or uses the screen. The images can be clipped.

If **EFI\_HII\_DRAW\_FLAG\_CLIP** is set, then all pixels drawn outside the bounding box specified by *Width* and *Height* are ignored.

The **EFI\_HII\_DRAW\_FLAG\_TRANSPARENT** flag determines whether the image will be drawn transparent or opaque. If **EFI\_HII\_DRAW\_FLAG\_FORCE\_TRANS** is set then the image's pixels will be drawn so that all "off" pixels in the image will be drawn using the pixel value from *BLT* and all other pixels will be copied. If **EFI\_HII\_DRAW\_FLAG\_FORCE\_OPAQUE** is set, then the image's pixels will be copied directly to the destination. If **EFI\_HII\_DRAW\_FLAG\_DEFAULT** is set, then the image will be drawn transparently or opaque, depending on the image's transparency setting (see **EFI\_IMAGE\_TRANSPARENT**). Images cannot be drawn transparently if *Blit* is NULL. If **EFI\_HII\_DIRECT\_TO\_SCREEN** is set, then the image will be written directly to the output device specified by *Screen*. Otherwise the image will be rendered to the bitmap specified by *Bitmap*.

### Status Codes Returned

EFI_SUCCESS	The image was successfully updated.
EFI_OUT_OF_RESOURCES	Unable to allocate an output buffer for <i>Blit</i> .
EFI_INVALID_PARAMETER	The <i>Image</i> or <i>Blit</i> was <b>NULL</b> .

## EFI\_HII\_IMAGE\_PROTOCOL.DrawImageId()

### Summary

Render an image to a bitmap or the screen containing the contents of the specified image.

### Prototype

```
typedef
EFI_STATUS
(EFI_API *EFI_HII_DRAW_IMAGE_ID) (
  IN CONST EFI_HII_IMAGE_PROTOCOL *This,
  IN EFI_HII_DRAW_FLAGS    Flags,
  IN EFI_HII_HANDLE        PackageList,
  IN EFI_IMAGE_ID          ImageId,
  IN OUT EFI_IMAGE_OUTPUT  **Blit,
  IN UINTN                 BlitX,
  IN UINTN                 BlitY,
);
```

### Parameters

*This*

A pointer to the **EFI\_HII\_IMAGE\_PROTOCOL** instance.

*Flags*

Describes how the image is to be drawn. **EFI\_HII\_DRAW\_FLAGS** is defined in Related Definitions, below.

*PackageList*

The package list in the HII database to search for the specified image.

*ImageId*

The image's id, which is unique within *PackageList*.

*Blit*

If this points to a non-NULL on entry, this points to the image, which is *Width* pixels wide and *Height* pixels high. The image will be drawn onto this image and **EFI\_HII\_DRAW\_FLAG\_CLIP** is implied. If this points to a NULL on entry, then a buffer will be allocated to hold the generated image and the pointer updated on exit. It is the caller's responsibility to free this buffer.

*BlitX, BlitY*

Specifies the offset from the left and top edge of the output image of the first pixel in the image.

## Description

This function renders an image to a bitmap or the screen using the specified color and options. It draws the image on an existing bitmap, allocates a new bitmap or uses the screen. The images can be clipped.

If **EFI\_HII\_DRAW\_FLAG\_CLIP** is set, then all pixels drawn outside the bounding box specified by *Width* and *Height* are ignored.

The **EFI\_HII\_DRAW\_FLAG\_TRANSPARENT** flag determines whether the image will be drawn transparent or opaque. If **EFI\_HII\_DRAW\_FLAG\_FORCE\_TRANS** is set, then the image will be drawn so that all “off” pixels in the image will be drawn using the pixel value from *Blit* and all other pixels will be copied. If **EFI\_HII\_DRAW\_FLAG\_FORCE\_OPAQUE** is set, then the image’s pixels will be copied directly to the destination. If **EFI\_HII\_DRAW\_FLAG\_DEFAULT** is set, then the image will be drawn transparently or opaque, depending on the image’s transparency setting (see **EFI\_IMAGE\_TRANSPARENT**). Images cannot be drawn transparently if *Blit* is NULL.

If **EFI\_HII\_DIRECT\_TO\_SCREEN** is set, then the image will be written directly to the output device specified by *Screen*. Otherwise the image will be rendered to the bitmap specified by *Bitmap*.

## Related Definitions

```
typedef UINT32 EFI_HII_DRAW_FLAGS;
#define EFI_HII_DRAW_FLAG_CLIP      0x00000001
#define EFI_HII_DRAW_FLAG_TRANSPARENT 0x00000030
#define EFI_HII_DRAW_FLAG_DEFAULT  0x00000000
#define EFI_HII_DRAW_FLAG_FORCE_TRANS 0x00000010
#define EFI_HII_DRAW_FLAG_FORCE_OPAQUE 0x00000020
#define EFI_HII_DIRECT_TO_SCREEN   0x00000080
```

## Status Codes Returned

EFI_SUCCESS	The image was successfully updated.
EFI_OUT_OF_RESOURCES	Unable to allocate an output buffer for <i>RowInfoArray</i> or <i>Blit</i> .
EFI_NOT_FOUND	The image specified by <i>ImageId</i> is not in the database. The specified <i>PackageList</i> is not in the Database
EFI_INVALID_PARAMETER	The <i>Image</i> or <i>Blit</i> was NULL.

## 33.5 EFI HII Image Ex Protocol

The EFI HII Image Ex protocol defines an extension to the EFI HII Image protocol which enables various new capabilities described in this section.

### EFI\_HII\_IMAGE\_EX\_PROTOCOL

## Summary

Protocol which allows access to the images in the images database

## GUID

```
#define EFI_HII_IMAGE_EX_PROTOCOL_GUID \
  {0x1a1241e6, 0x8f19, 0x41a9, 0xbc, \
   {0xe, 0xe8, 0xef, 0x39, 0xe0, 0x65, 0x46}}
```

## Protocol

```
typedef struct _EFI_HII_IMAGE_EX_PROTOCOL {
  EFI_HII_NEW_IMAGE_EX  NewImageEx;
  EFI_HII_GET_IMAGE_EX  GetImageEx;
  EFI_HII_SET_IMAGE_EX  SetImageEx;
  EFI_HII_DRAW_IMAGE_EX DrawImageEx;
  EFI_HII_DRAW_IMAGE_ID_EX DrawImageIdEx;
  EFI_HII_GET_IMAGE_INFO GetImageInfo;
} EFI_HII_IMAGE_EX_PROTOCOL;
```

## Members

<i>NewImageEx</i>	Add a new image. This protocol invokes the original <b>EFI_HII_IMAGE_PROTOCOL.NewImage()</b> implicitly.
<i>GetImageEx</i>	Retrieve an image and the related image information. This function will try to locate the <b>EFI_HII_IMAGE_DECODER_PROTOCOL</b> if the image decoder for the image is not supported by the EFI HII image EX protocol.
<i>SetImageEx</i>	Change information about the image, this protocol invokes original <b>EFI_HII_IMAGE_PROTOCOL.SetImage()</b> implicitly.
<i>DrawImageEx</i>	Renders an image to a bitmap or the display, this protocol invokes original <b>EFI_HII_IMAGE_PROTOCOL.DrawImage()</b> implicitly.
<i>DrawImageIdEx</i>	Renders an image to a bitmap or the screen containing the contents of the specified image, this protocol invokes original <b>EFI_HII_IMAGE_PROTOCOL.DrawImageId()</b> implicitly.
<i>GetImageInfo</i>	This function retrieves the image information specified by the image ID which is associated with the specified HII package list. This function only returns the geometry of the image instead of allocating the memory buffer and decoding the image to the buffer.

## EFI\_HII\_IMAGE\_EX\_PROTOCOL.NewImageEx()

### Summary

The prototype of this extension function is the same with [EFI\\_HII\\_IMAGE\\_PROTOCOL.NewImage\(\)](#).

### Protocol

```
typedef
EFI_STATUS
(EFI_API *EFI_HII_NEW_IMAGE_EX)(
    IN CONST EFI_HII_IMAGE_EX_PROTOCOL *This,
    IN EFI_HII_HANDLE    PackageList,
    OUT EFI_IMAGE_ID     *ImageId
    IN OUT EFI_IMAGE_INPUT *Image
);
```

### Parameters

Same with [EFI\\_HII\\_IMAGE\\_PROTOCOL.NewImage\(\)](#).

### Description

Same with [EFI\\_HII\\_IMAGE\\_PROTOCOL.NewImage\(\)](#). This protocol invokes [EFI\\_HII\\_IMAGE\\_PROTOCOL.NewImage\(\)](#) implicitly.

### Status Codes Returned

Same as [EFI\\_HII\\_IMAGE\\_PROTOCOL.NewImage\(\)](#).



## EFI\_HII\_IMAGE\_EX\_PROTOCOL.GetImageEx()

### Summary

Return the information about the image, associated with the package list. The prototype of this extension function is the same with [EFI\\_HII\\_IMAGE\\_PROTOCOL.GetImage\(\)](#).

### Protocol

```
typedef
EFI_STATUS
(EFI_API *EFI_HII_GET_IMAGE_EX)(
    IN CONST EFI_HII_IMAGE_EX_PROTOCOL *This,
    IN EFI_HII_HANDLE    PackageList,
    IN EFI_IMAGE_ID     ImageId,
    OUT EFI_IMAGE_INPUT *Image
);
```

### Parameters

Same with [EFI\\_HII\\_IMAGE\\_PROTOCOL.GetImage\(\)](#)

### Description

This function is similar to [EFI\\_HII\\_IMAGE\\_PROTOCOL.GetImage\(\)](#). The difference is that this function will locate all [EFI\\_HII\\_IMAGE\\_DECODER\\_PROTOCOL](#) instances installed in the system if the decoder of the certain image type is not supported by the [EFI\\_HII\\_IMAGE\\_EX\\_PROTOCOL](#). The function will attempt to decode the image to the [EFI\\_IMAGE\\_INPUT](#) using the first [EFI\\_HII\\_IMAGE\\_DECODER\\_PROTOCOL](#) instance that supports the requested image type.

### Status Codes Returned

Same as [EFI\\_HII\\_IMAGE\\_PROTOCOL.GetImage\(\)](#).

## EFI\_HII\_IMAGE\_EX\_PROTOCOL.SetImageEx()

### Summary

Change the information about the image. The prototype of this extension function is the same with [EFI\\_HII\\_IMAGE\\_PROTOCOL.SetImage\(\)](#).

### Protocol

```
typedef
EFI_STATUS
(EFI_API *EFI_HII_SET_IMAGE_EX)(
    IN CONST EFI_HII_IMAGE_EX_PROTOCOL *This,
    IN EFI_HII_HANDLE    PackageList,
    IN EFI_IMAGE_ID      ImageId,
    IN CONST EFI_IMAGE_INPUT *Image
);
```

### Parameters

Same with [EFI\\_HII\\_IMAGE\\_PROTOCOL.SetImage\(\)](#).

### Description

Same with [EFI\\_HII\\_IMAGE\\_PROTOCOL.SetImage\(\)](#), this protocol invokes [EFI\\_HII\\_IMAGE\\_PROTOCOL.SetImage\(\)](#) implicitly.

### Status Codes Returned

Same as [EFI\\_HII\\_IMAGE\\_PROTOCOL.SetImage\(\)](#).

## EFI\_HII\_IMAGE\_EX\_PROTOCOL.DrawImageEx()

### Summary

Renders an image to a bitmap or to the display. The prototype of this extension function is the same with [EFI\\_HII\\_IMAGE\\_PROTOCOL.DrawImage\(\)](#).

### Protocol

```
typedef
EFI_STATUS
(EFI_API *EFI_HII_DRAW_IMAGE_EX)(
    IN CONST EFI_HII_IMAGE_EX_PROTOCOL *This,
    IN EFI_HII_DRAW_FLAGS    Flags,
    IN CONST EFI_IMAGE_INPUT  *Image,
    IN OUT EFI_IMAGE_OUTPUT   **Blit,
    IN UINTN                  BlitX,
    IN UINTN                  BlitY
);
```

### Parameters

Same with [EFI\\_HII\\_IMAGE\\_PROTOCOL.DrawImageId\(\)](#).

### Description

Same with [EFI\\_HII\\_IMAGE\\_PROTOCOL.DrawImage\(\)](#), this protocol invokes [EFI\\_HII\\_IMAGE\\_PROTOCOL.DrawImage\(\)](#) implicitly.

### Status Codes Returned

Same as [EFI\\_HII\\_IMAGE\\_PROTOCOL.DrawImage\(\)](#).

## EFI\_HII\_IMAGE\_EX\_PROTOCOL.DrawImageIdEx()

### Summary

Renders an image to a bitmap or the screen containing the contents of the specified image. The prototype of this extension function is the same with [EFI\\_HII\\_IMAGE\\_PROTOCOL.DrawImageId\(\)](#).

### Protocol

```
typedef
EFI_STATUS
(EFI_API *EFI_HII_DRAW_IMAGE_ID_EX)(
    IN CONST EFI_HII_IMAGE_EX_PROTOCOL *This,
    IN EFI_HII_DRAW_FLAGS    Flags,
    IN EFI_HII_HANDLE        PackageList,
    IN EFI_IMAGE_ID          ImageId,
    IN OUT EFI_IMAGE_OUTPUT  **Blt,
    IN UINTN                 BltX,
    IN UINTN                 BltY
);
```

### Parameters

Same with [EFI\\_HII\\_IMAGE\\_PROTOCOL.DrawImageId\(\)](#).

### Description

*This function is similar to [EFI\\_HII\\_IMAGE\\_PROTOCOL.DrawImageId\(\)](#). The difference is that this function will locate all [EFI\\_HII\\_IMAGE\\_DECODER\\_PROTOCOL](#) instances installed in the system if the decoder of the certain image type is not supported by the [EFI\\_HII\\_IMAGE\\_EX\\_PROTOCOL](#). The function will attempt to decode the image to the [EFI\\_IMAGE\\_INPUT](#) using the first [EFI\\_HII\\_IMAGE\\_DECODER\\_PROTOCOL](#) instance that supports the requested image type.*

### Status Codes Returned

Same as [EFI\\_HII\\_IMAGE\\_PROTOCOL.DrawImageId\(\)](#).

## EFI\_HII\_IMAGE\_EX\_PROTOCOL.GetImageInfo()

### Summary

The function returns the information of the image. This function is differ from the **EFI\_HII\_IMAGE\_EX\_PROTOCOL.GetImageEx()**This function only returns the geometry of the image instead of decoding the image to the buffer.

### Protocol

```
typedef
EFI_STATUS
(EFI_API *EFI_HII_GET_IMAGE_INFO)(
    IN CONST EFI_HII_IMAGE_EX_PROTOCOL *This,
    IN EFI_HII_HANDLE    PackageList,
    IN EFI_IMAGE_ID      ImageId,
    OUT EFI_IMAGE_OUTPUT *Image
);
```

### Parameters

<i>This</i>	<b>EFI_HII_IMAGE_EX_PROTOCOL</b> instance.
<i>PackageList</i>	The HII package list.
<i>ImageId</i>	The HII image ID.
<i>Image</i>	<b>EFI_IMAGE_OUTPUT</b> to retrieve the image information. Only <i>Image.Width</i> and <i>Image.Height</i> will be updated by this function. <i>Image.Bitmap</i> is always set to <b>NULL</b> .

### Description

This function returns the image information to **EFI\_IMAGE\_OUTPUT**. Only the width and height are returned to the **EFI\_IMAGE\_OUTPUT** instead of decoding the image to the buffer. This function is used to get the geometry of the image. This function will try to locate all of the **EFI\_HII\_IMAGE\_DECODER\_PROTOCOL** installed on the system if the decoder of image type is not supported by the **EFI\_HII\_IMAGE\_EX\_PROTOCOL**.

### Status Codes Returned

<b>EFI_SUCCESS</b>	The image information was returned to <i>Image</i> .
EFI_OUT_OF_RESOURCES	Memory allocation failed in this function.
<b>EFI_UNSUPPORTED</b>	The format of image is not supported.
EFI_NOT_FOUND	The image was not found in the database.
EFI_INVALID_PARAMETER	The <i>Image</i> was NULL or <i>ImageId</i> was 0.

## 33.6 EFI HII Image Decoder Protocol

For those HII image block types which don't have the corresponding image decoder supported in EFI HII image EX protocol, **EFI\_HII\_IMAGE\_DECODER\_PROTOCOL** can be

used to provide the proper image decoder. There may be more than one **EFI\_HII\_IMAGE\_DECODER\_PROTOCOL** instance installed in the system. Each image decoder can decode more than one HII image block types. Whether or not the HII image block type of image is supported by the certain image decoder is reported through the **EFI\_HII\_IMAGE\_DECODER\_PROTOCOL** *GetImageDecoderName()* Caller can invoke this function to verify the image is supported by the image decoder before sending the image raw data to the image decoder. There are two image decoder names defined in this specification: **EFI\_HII\_IMAGE\_DECODER\_NAME\_JPEG** and **EFI\_HII\_IMAGE\_DECODER\_NAME\_PNG**

The image decoder protocol can publish the support for additional image decoder names other than the ones defined in this specification. This allows the image decoder to support additional image formats that are not defined by the HII image block types. In that case, callers can send the image raw data to the image decoder protocol instance to retrieve the image information or decode the image. Since the HII image block type of such images is not defined, the image may or may not be decoded by that decoder. The decoder can use the signature or data structures in the image raw data to check the format before it processes the image.

The **EFI\_HII\_IMAGE\_EX\_PROTOCOL** uses **EFI\_HII\_IMAGE\_DECODER\_PROTOCOL** as follows:

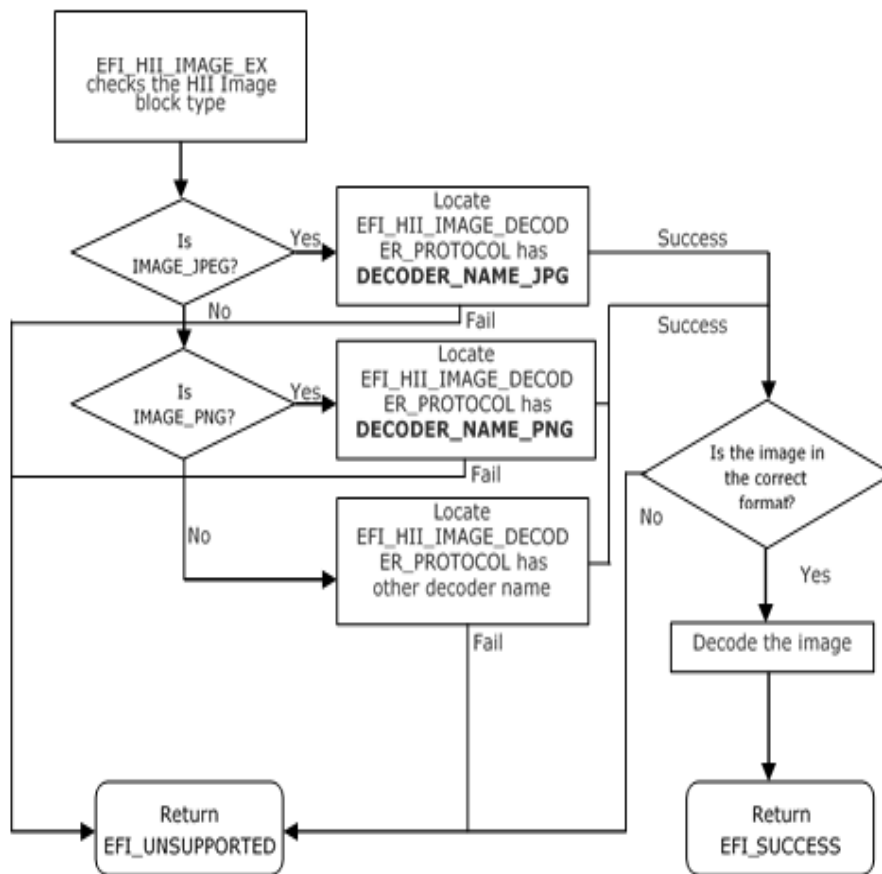

Figure 137. How **EFI\_HII\_IMAGE\_EX\_PROTOCOL** uses **EFI\_HII\_IMAGE\_DECODER\_PROTOCOL**

## EFI\_HII\_IMAGE\_DECODER\_PROTOCOL.DecodeImage()

### Summary

Provides the image decoder for specific image file formats.

### GUID

```
#define EFI_HII_IMAGE_DECODER_PROTOCOL_GUID \
  {0x9E66F251, 0x727C, 0x418C, \
   {0xBF, 0xD6, 0xC2, 0xB4, 0x25, 0x28, 0x18, 0xEA}}
```

### Protocol

```
typedef struct _EFI_HII_IMAGE_DECODER_PROTOCOL {
  EFI_HII_IMAGE_DECODER_GET_NAME   GetImageDecoderName;
  EFI_HII_IMAGE_DECODER_GET_IMAGE_INFO GetImageInfo;
  EFI_HII_IMAGE_DECODER_DECODE     DecodeImage;
} EFI_HII_IMAGE_DECODER_PROTOCOL;
```

### Members

*GetImageDecodeName* The function returns the decoder name.

*GetImageInfo* The function returns the image information

*DecodeImage* The function decodes the image to the **EFI\_IMAGE\_INPUT**

### Status Codes Returned

EFI_SUCCESS	The image information was returned to <i>Bitmap</i> .
EFI_UNSUPPORTED	The image decoder can't decode this image.
EFI_OUT_OF_RESOURCE	Not enough memory to decode this image.
EFI_INVALID_PARAMETER	The <i>Image</i> was NULL or <i>ImageRawDataSize</i> was 0.

## EFI\_HII\_IMAGE\_DECODER\_PROTOCOL.GetImageDecoderName()

### Summary

This function returns the decoder name.

### Protocol

```
typedef
EFI_STATUS
(EFI_API *EFI_HII_IMAGE_DECODER_GET_NAME)(
    IN CONST EFI_HII_IMAGE_DECODER_PROTOCOL *This,
    IN OUT EFI_GUID      **DecoderName,
    OUT UINT16          *NumberOfDecoderName
);
```

### Parameters

<i>This</i>	<b>EFI_HII_IMAGE_DECODER_PROTOCOL</b> instance.
<i>DecoderName</i>	Pointer to a dimension to retrieve the decoder names in <b>EFI_GUID</b> format. The number of the decoder names is returned in <i>NumberOfDecoderName</i> .
<i>NumberOfDecoderName</i>	Pointer to retrieve the number of decoders which supported by this decoder driver.

### Description

There could be more than one **EFI\_HII\_IMAGE\_DECODER\_PROTOCOL** instances installed in the system for different image formats. This function returns the decoder name which callers can use to find the proper image decoder for the image. It is possible to support multiple image formats in one **EFI\_HII\_IMAGE\_DECODER\_PROTOCOL**. The capability of the supported image formats is returned in *DecoderName* and *NumberOfDecoderName*.



## Related Definitions

```

//*****
// EFI_HII_IMAGE_DECODER_NAME
//*****
#define EFI_HII_IMAGE_DECODER_NAME_JPEG_GUID \
  {0xefef093, 0xd9b, 0x46eb, 0xa8, \
   {0x56, 0x48, 0x35, 0x7, 0x0, 0xc9, 0x8}}

#define EFI_HII_IMAGE_DECODER_NAME_PNG_GUID \
  {0xaf060190, 0x5e3a, 0x4025, 0xaf, \
   {0xbd, 0xe1, 0xf9, 0x5, 0xbf, 0xaa, 0x4c}}

```

## Status Codes Returned

<b>EFI_SUCCESS</b>	The image decoder names were returned in <i>DecoderName</i> .
<b>EFI_UNSUPPORTED</b>	No image decoders found in this <b>EFI_HII_IMAGE_DECODER</b> instance.

## EFI\_HII\_IMAGE\_DECODER\_PROTOCOL.GetImageInfo()

### Summary

The function returns the **EFI\_HII\_IMAGE\_DECODER\_IMAGE\_INFO** to the caller.

### Protocol

```
typedef
EFI_STATUS
(EFIAPI *EFI_HII_IMAGE_DECODER_GET_IMAGE_INFO)(
    IN CONST EFI_HII_IMAGE_DECODER_PROTOCOL *This,
    IN VOID          *Image,
    IN UINTN         SizeOfImage,
    IN OUT EFI_HII_IMAGE_DECODER_IMAGE_INFO **ImageInfo
);
```

### Parameters

<i>This</i>	<b>EFI_HII_IMAGE_DECODER_PROTOCOL</b> instance.
<i>Image</i>	Pointer to the image raw data
<i>SizeOfImage</i>	Size of the entire image raw data
<i>ImageInfo</i>	Pointer to receive the <b>EFI_HII_IMAGE_DECODER_IMAGE_INFO</b>

### Description

This function returns the image information of the given image raw data. This function first checks whether the image raw data is supported by this decoder or not. This function may go through the first few bytes in the image raw data for the specific data structure or the image signature. If the image is not supported by this image decoder, this function returns **EFI\_UNSUPPORTED** to the caller. Otherwise, this function returns the proper image information to the caller. It is the caller's responsibility to free the *ImageInfo*.

### Status Codes Returned

<b>EFI_SUCCESS</b>	The image information was returned to <i>ImageInfo</i> .
<b>EFI_UNSUPPORTED</b>	No image decoder for the given <i>Image</i> or the image decoder can't decode this image.
<b>EFI_OUT_OF_RESOURCE</b>	Not enough memory to decode this image for getting the image information.
<b>EFI_INVALID_PARAMETER</b>	The <i>Image</i> was NULL, <i>SizeOfImage</i> was 0 or the image is corrupted.

## Related Definitions

```

//*****
// EFI_HII_IMAGE_DECODER_COLOR_TYPE
//*****
typedef enum {
    EFI_HII_IMAGE_DECODER_COLOR_TYPE_RGB = 0,
    EFI_HII_IMAGE_DECODER_COLOR_TYPE_RGBA = 1,
    EFI_HII_IMAGE_DECODER_COLOR_TYPE_CMYK = 2,
    EFI_HII_IMAGE_DECODER_COLOR_TYPE_UNKNOWN = 0xff,
} EFI_HII_IMAGE_DECODER_COLOR_TYPE

//*****
// EFI_HII_IMAGE_DECODER_IMAGE_INFO_HEADER
//*****
typedef struct _EFI_HII_IMAGE_DECODER_IMAGE_INFO_HEADER {
    EFI_GUID      DecoderName;
    UINT16        ImageInfoSize;
    UINT16        ImageWidth;
    UINT16        ImageHeight;
    EFI_HII_IMAGE_DECODER_COLOR_TYPE ColorType;
    UINT8         ColorDepthInBits;
} EFI_HII_IMAGE_DECODER_IMAGE_INFO_HEADER;

    DecoderName          Decoder Name
    ImageInfoSize        The size of entire image information structure in bytes.
    ImageWidth           The image width.
    ImageHeight          The image height.
    ColorType            The color type, refer to
                        EFI_HII_IMAGE_DECODER_COLOR_TYPE.
    ColorDepthInBits    The color depth in bits.

//*****
// EFI_HII_IMAGE_DECODER_JPEG_INFO
//*****
typedef struct _EFI_HII_IMAGE_DECODER_JPEG_INFO {
    EFI_HII_IMAGE_DECODER_IMAGE_INFO_HEADER Header;
    UINT16      ScanType;
    UINT64      Reserved;
} EFI_HII_IMAGE_DECODER_JPEG_INFO;

```

```

Header          EFI_HII_IMAGE_DECODER_IMAGE_INFO_HEADER
ScanType       The scan type of the JPEG image

#define EFI_IMAGE_JPEG_SCANTYPE_PROGRESSIVE 0x01
#define EFI_IMAGE_JPEG_SCANTYPE_INTERLACED 0x02

Reserved       Reserved

//*****
// EFI_HII_IMAGE_DECODER_PNG_INFO
//*****
typedef struct _EFI_HII_IMAGE_DECODER_PNG_INFO {
    EFI_HII_IMAGE_DECODER_IMAGE_INFO_HEADER Header;
    UINT16      Channels;
    UINT64      Reserved;
} EFI_HII_IMAGE_DECODER_PNG_INFO;

Header          EFI_HII_IMAGE_DECODER_IMAGE_INFO_HEADER
Channels       Number of channels in the PNG image.
Reserved       Reserved

//*****
// EFI_HII_IMAGE_DECODER_OTHER_INFO
//*****
typedef struct _EFI_HII_IMAGE_DECODER_OTHER_INFO {
    EFI_HII_IMAGE_DECODER_IMAGE_INFO_HEADER Header;
    CHAR16      ImageExtension[1];
    //
    // Variable length of image file extension name.
    //
} EFI_HII_IMAGE_DECODER_OTHER_INFO;

Header          EFI_HII_IMAGE_DECODER_IMAGE_INFO_HEADER
ImageExtension The string of the image file extension. For example, "GIF",
               "TIFF" or others.

```

## EFI\_HII\_IMAGE\_DECODER\_PROTOCOL.Decode()

### Summary

The function decodes the image

### Protocol

```
typedef
EFI_STATUS
(EFI_API *EFI_HII_IMAGE_DECODER_DECODE)(
    IN CONST EFI_HII_IMAGE_DECODER_PROTOCOL *This,
    IN VOID          *Image,
    IN UINTN         ImageRawDataSize,
    IN OUT EFI_IMAGE_OUTPUT **Bitmap,
    IN BOOLEAN       Transparent
);
```

### Parameters

<i>This</i>	<b>EFI_HII_IMAGE_DECODER_PROTOCOL</b> instance.
<i>Image</i>	Pointer to the image raw data
<i>ImageRawDataSize</i>	Size of the entire image raw data
<i>Bitmap</i>	<b>EFI_IMAGE_OUTPUT</b> to receive the image or overlap the image on the original buffer.
<i>Transparent</i>	<b>BOOLEAN</b> value indicates whether the image decoder has to handle the transparent image or not.

### Description

This function decodes the image which the image type of this image is supported by this **EFI\_HII\_IMAGE\_DECODER\_PROTOCOL**. If *\*Bitmap* is not **NULL**, the caller intends to put the image in the given image buffer. That allows the caller to put an image overlap on the original image. The transparency is handled by the image decoder because the transparency capability depends on the image format. Callers can set *Transparent* to **FALSE** to force disabling the transparency process on the image. Forcing *Transparent* to **FALSE** may also improve the performance of the image decoding because the image decoder can skip the transparency processing.

If *\*Bitmap* is **NULL**, the image decoder allocates the memory buffer for the **EFI\_IMAGE\_OUTPUT** and decodes the image to the image buffer. It is the caller's responsibility to free the memory for **EFI\_IMAGE\_OUTPUT**. Image decoder doesn't have to handle the transparency in this case because there is no background image given by the caller. The background color in this case is all black (#00000000).

## 33.7 Font Glyph Generator Protocol

The EFI HII Font glyph generator protocol generates font glyphs of the requested characters according to the given font information. This protocol is utilized by the [EFI\\_HII\\_FONT\\_EX\\_PROTOCOL](#) when the character can't be found in the existing glyph database. That is when glyph is not found in any HII font package, [EFI\\_HII\\_FONT\\_EX\\_PROTOCOL](#) locates [EFI\\_HII\\_FONT\\_GLYPH\\_GENERATOR\\_PROTOCOL](#) to generate glyph block and insert glyph block into HII font package. The HII font package can be an existing HII font package or a new HII font package. This protocol can be provided by any driver that knows how to generate the glyph for a specific font family. For example, EFI application or driver may provide "Times new roman" font glyph generator driver. With this driver, platform can have "Times new roman" font supported on system.

### EFI\_HII\_FONT\_GLYPH\_GENERATOR\_PROTOCOL

#### Summary

EFI HII Font glyph generator protocol generates the glyph of the character according to the given font information.

#### GUID

```
#define EFI_HII_FONT_GLYPH_GENERATOR_PROTOCOL_GUID \
  { 0xf7102853, 0x7787, 0x4dc2, 0xa8, \
    {0xa8, 0x21, 0xb5, 0xdd, 0x5, 0xc8, 0x9b } }
```

#### Protocol

```
typedef struct _EFI_HII_FONT_GLYPH_GENERATOR_PROTOCOL {
  EFI_GENERATE_GLYPH GenerateGlyph;
  EFI_GENERATE_IMAGE GenerateGlyphImage;
} EFI_HII_FONT_GLYPH_GENERATOR_PROTOCOL;
```

#### Members

<i>GenerateGlyph</i>	The function generates the glyph information according to the given font information.
<i>GenerateGlyphImage</i>	The function generates the glyph image according to the given font information.

## EFI\_HII\_FONT\_GLYPH\_GENERATOR\_PROTOCOL.GenerateGlyph()

### Summary

The function generates the glyph information according to the given font information. This function returns the glyph block in **EFI\_HII\_GIBT\_GLYPH\_VARIABILITY** type.

### Protocol

```
typedef
EFI_STATUS
(EFI_API *EFI_HII_GENERATE_GLYPH)(
IN CONST EFI_HII_FONT_GLYPH_GENERATOR_PROTOCOL *This,
IN CHAR16 Char,
IN CONST EFI_FONT_DISPLAY_INFO *FontInfo,
OUT EFI_HII_GIBT_VARIABILITY_BLOCK *GlyphBlock
);
```

### Parameters

<i>This</i>	<b>EFI_HII_FONT_GLYPH_GENERATOR_PROTOCOL</b> instance.
<i>Char</i>	Character to retrieve.
<i>FontInfo</i>	Font display information of this character.
<i>GlyphBlock</i>	Pointer to retrieve the <b>EFI_HII_GIBT_VARIABILITY_BLOCK</b>

### Description

This function generates the glyph information of the character in the specific font family. **EFI\_HII\_GIBT\_VARIABILITY\_BLOCK** is returned to *GlyphBlock* if *GlyphBlock* is not NULL. *GlyphBlock* can be called by **EFI\_HII\_FONT\_EX\_PROTOCOL** to retrieve the glyph information which are provided by the font family specific driver, or can be used to build up the HII font package if the HII font package with the specific font family does not exist in the HII database.

### Status Codes Returned

<b>EFI_SUCCESS</b>	The glyph information was returned to <i>GlyphBlock</i> .
<b>EFI_INVALID_PARAMETER</b>	The <i>FontInfo</i> or <i>GlyphBlock</i> was NULL.
<b>EFI_OUT_OF_RESOURCE</b>	Not enough memory to generate the glyph information.
<b>EFI_UNSUPPORTED</b>	The font glyph generator can't generate the glyph for the given <i>Char</i> . This may be caused by the unsupported character, font name font style or font size.

## EFI\_HII\_FONT\_GLYPH\_GENERATOR\_PROTOCOL.GenerateGlyphImage()

### Summary

The function generates the glyph image according to the given font information. This function returns **EFI\_GRAPHICS\_OUTPUT\_BLT\_PIXEL** points to the **EFI\_IMAGE\_OUTPUT** buffer. This function is used for glyphs which are reported in the font database as **EFI\_HII\_GIBT\_GLYPH\_VARIABILITY** glyph blocks.

### Protocol

```
typedef
EFI_STATUS
(EFI_API *EFI_HII_GENERATE_GLYPH_IMAGE)(
  IN CONST EFI_HII_FONT_GLYPH_GENERATOR_PROTOCOL *This,
  IN CONST EFI_HII_GLYPH_INFO *Cell,
  IN UINT8 *GlyphBuffer,
  IN CONST EFI_FONT_DISPLAY_INFO *FontInfo,
  IN OUT EFI_IMAGE_OUTPUT *Image,
  IN INT32 *BltX,
  IN INT32 *BltY,
  IN BOOLEAN Transparent
);
```

### Parameters

<i>This</i>	<b>EFI_HII_FONT_GLYPH_GENERATOR_PROTOCOL</b> instance.
<i>Cell</i>	Pointer to <b>EFI_HII_GLYPH_INFO</b>
<i>GlyphBuffer</i>	The buffer points to the bitmap of glyph. This pointer points to <i>GlyphBlock.BitmapData</i> which returned from <b>GenerateGlyph()</b> function
<i>FontInfo</i>	Font display information of this glyph.
<i>Image</i>	Image output buffer to retrieve the glyph image.
<i>BltX</i>	Together with <i>BltY</i> , specifies the offset from the left and top edge of the image of the first character cell in the <i>Image</i> .
<i>BltY</i>	Together with <i>BltX</i> , specifies the offset from the left and top edge of the image of the first character cell in the <i>Image</i> .
<i>Transparent</i>	If TRUE, the Background color is ignored and all "off" pixels in the character's drawn will use the pixel value from <i>Image</i> .

### Description

This function generates the glyph image of the character in the specific font family on the given **EFI\_IMAGE\_OUTPUT**



## Status Codes Returned

EFI_SUCCESS	The glyph image was generated in <i>Image</i> .
EFI_OUT_OF_RESOURCE	Not enough memory to generate image of the given glyph.
EFI_UNSUPPORTED	The font glyph generator can't generate the glyph for the given <i>FontInfo</i> . This may be caused by the unsupported font name, font style or font size.
EFI_INVALID_PARAMETER	One or more parameters of <i>Cell</i> , <i>GlyphBuffer</i> , <i>FontInfo</i> , <i>Image</i> , <i>BlitX</i> or <i>BlitY</i> was NULL.

## 33.8 Database Protocol

### EFI\_HII\_DATABASE\_PROTOCOL

#### Summary

Database manager for HII-related data structures.

#### GUID

```
#define EFI_HII_DATABASE_PROTOCOL_GUID \
  { 0xef9fc172, 0xa1b2, 0x4693, \
    { 0xb3, 0x27, 0x6d, 0x32, 0xfc, 0x41, 0x60, 0x42 } }
```

#### Protocol

```
typedef struct _EFI_HII_DATABASE_PROTOCOL {
  EFI_HII_DATABASE_NEW_PACK   NewPackageList;
  EFI_HII_DATABASE_REMOVE_PACK RemovePackageList;
  EFI_HII_DATABASE_UPDATE_PACK UpdatePackageList;
  EFI_HII_DATABASE_LIST_PACKS ListPackageLists;
  EFI_HII_DATABASE_EXPORT_PACKS ExportPackageLists;
  EFI_HII_DATABASE_REGISTER_NOTIFY RegisterPackageNotify;
  EFI_HII_DATABASE_UNREGISTER_NOTIFY UnregisterPackageNotify;
  EFI_HII_FIND_KEYBOARD_LAYOUTS FindKeyboardLayouts;
  EFI_HII_GET_KEYBOARD_LAYOUT GetKeyboardLayout;
  EFI_HII_SET_KEYBOARD_LAYOUT SetKeyboardLayout;
  EFI_HII_DATABASE_GET_PACK_HANDLE GetPackageListHandle;
} EFI_HII_DATABASE_PROTOCOL;
```

#### Members

*NewPackageList*

Add a new package list to the HII database.

*RemovePackageList*

Remove a package list from the HII database.

*UpdatePackageList*

Update a package list in the HII database.

*ListPackageLists*

List the handles of the package lists within the HII database.

*ExportPackageLists*

Export package lists from the HII database.

*RegisterPackageNotify*

Register notification when packages of a certain type are installed.

*UnregisterPackageNotify*

Unregister notification of packages.

*FindKeyboardLayouts*

Retrieves a list of the keyboard layouts in the system.

*GetKeyboardLayout*

Allows a program to extract the current keyboard layout. See the **GetKeyboardLayout()** function description.

*SetKeyboardLayout*

Changes the current keyboard layout. See the **SetKeyboardLayout()** function description.

*GetPackageListHandle*

Return the EFI handle associated with a given package list.

## EFI\_HII\_DATABASE\_PROTOCOL.NewPackageList()

### Summary

Adds the packages in the package list to the HII database.

### Prototype

```
typedef
EFI_STATUS
(EFIAPI *EFI_HII_DATABASE_NEW_PACK) (
  IN CONST EFI_HII_DATABASE_PROTOCOL *This,
  IN CONST EFI_HII_PACKAGE_LIST_HEADER *PackageList,
  IN CONST EFI_HANDLE DriverHandle, OPTIONAL
  OUT EFI_HII_HANDLE *Handle
);
```

### Parameters

*This*

A pointer to the **EFI\_HII\_DATABASE\_PROTOCOL** instance.

*PackageList*

A pointer to an **EFI\_HII\_PACKAGE\_LIST\_HEADER** structure.

*DriverHandle*

Associate the package list with this EFI handle

*Handle*

A pointer to the **EFI\_HII\_HANDLE** instance. Type **EFI\_HII\_HANDLE** is defined in "Related Definitions" below.

### Description

This function adds the packages in the package list to the database and returns a handle. If there is a **EFI\_DEVICE\_PATH\_PROTOCOL** associated with the *DriverHandle*, then this function will create a package of type **EFI\_PACKAGE\_TYPE\_DEVICE\_PATH** and add it to the package list.

For each package in the package list, registered functions with the notification type **NEW\_PACK** and having the same package type will be called.

For each call to **NewPackageList()**, there should be a corresponding call to [EFI\\_HII\\_DATABASE\\_PROTOCOL.RemovePackageList\(\)](#).

### Related Definitions

```
typedef VOID *EFI_HII_HANDLE;
```

### Status Codes Returns

EFI\_SUCCESS

The package list associated with the *Handle* was added to the HII database.

EFI\_OUT\_OF\_RESOURCES

Unable to allocate necessary resources for the new database contents.

EFI\_INVALID\_PARAMETER

*PackageList* is NULL or *Handle* is **NULL**.

## EFI\_HII\_DATABASE\_PROTOCOL.RemovePackageList()

### Summary

Removes a package list from the HII database.

### Prototype

```
typedef
EFI_STATUS
(EFIAPI *EFI_HII_DATABASE_REMOVE_PACK) (
  IN CONST EFI_HII_DATABASE_PROTOCOL *This,
  IN EFI_HII_HANDLE    Handle
);
```

### Parameters

*This*

A pointer to the **EFI\_HII\_DATABASE\_PROTOCOL** instance.

*Handle*

The handle that was registered to the data that is requested for removal. Type **EFI\_HII\_HANDLE** is defined in **EFI\_HII\_DATABASE\_PROTOCOL.NewPackageList()** in the Packages section.

### Description

This function removes the package list that is associated with a handle *Handle* from the HII database. Before removing the package, any registered functions with the notification type **REMOVE\_PACK** and the same package type will be called.

For each call to [EFI\\_HII\\_DATABASE\\_PROTOCOL.NewPackageList\(\)](#), there should be a corresponding call to RemovePackageList.

### Status Codes Returned

EFI_SUCCESS	The data associated with the <i>Handle</i> was removed from the HII database.
EFI_NOT_FOUND	The specified <i>Handle</i> is not in the Database.

## EFI\_HII\_DATABASE\_PROTOCOL.UpdatePackageList()

### Summary

Update a package list in the HII database.

### Prototype

```
typedef
EFI_STATUS
(EFI_API *EFI_HII_DATABASE_UPDATE_PACK) (
  IN CONST EFI_HII_DATABASE_PROTOCOL *This,
  IN EFI_HII_HANDLE Handle,
  IN CONST EFI_HII_PACKAGE_LIST_HEADER *PackageList,
);
```

### Parameters

*This*

A pointer to the **EFI\_HII\_DATABASE\_PROTOCOL** instance.

*Handle*

The handle that was registered to the data that is requested to be updated. Type **EFI\_HII\_HANDLE** is defined in **EFI\_HII\_DATABASE\_PROTOCOL.NewPackageList()** in the Packages section.

*PackageList*

A pointer to an instance of **EFI\_HII\_PACKAGE\_LIST\_HEADER**.

### Description

This function updates the existing package list (which has the specified *Handle*) in the HII databases, using the new package list specified by *PackageList*. The update process has the following steps:

Collect all the package types in the package list specified by *PackageList*. A package type consists of the *Type* field of **EFI\_HII\_PACKAGE\_HEADER** and, if the *Type* is **EFI\_HII\_PACKAGE\_TYPE\_GUID**, the *Guid* field, as defined in **EFI\_HII\_GUID\_PACKAGE\_HDR**.

Iterate through the packages within the existing package list in the HII database specified by *Handle*. If a package's type matches one of the types collected in step 1, then perform the following steps:

- Call any functions registered with the notification type **REMOVE\_PACK**.
- Remove the package from the package list and the HII database.

Add all of the packages within the new package list specified by *PackageList*, using the following steps:

- Add the package to the package list and the HII database.
- Call any functions registered with the notification type **ADD\_PACK**.

## Status Codes Returned

EFI_SUCCESS	The HII database was successfully updated.
EFI_OUT_OF_RESOURCES	Unable to allocate enough memory for the updated database.
EFI_INVALID_PARAMETER	<i>PackageList</i> was <b>NULL</b> .
EFI_NOT_FOUND	The specified <i>Handle</i> is not in the Database.

## EFI\_HII\_DATABASE\_PROTOCOL.ListPackageLists()

### Summary

Determines the handles that are currently active in the database.

### Prototype

```
typedef
EFI_STATUS
(EFI_API *EFI_HII_DATABASE_LIST_PACKS) (
  IN CONST EFI_HII_DATABASE_PROTOCOL *This,
  IN UINT8      PackageType,
  IN CONST EFI_GUID      *PackageGuid,
  IN OUT UINTN      *HandleBufferLength,
  OUT EFI_HII_HANDLE      *Handle
);
```

### Parameters

#### *This*

A pointer to the **EFI\_HII\_DATABASE\_PROTOCOL** instance.

#### *PackageType*

Specifies the package type of the packages to list or **EFI\_HII\_PACKAGE\_TYPE\_ALL** for all packages to be listed.

#### *PackageGuid*

If *PackageType* is **EFI\_HII\_PACKAGE\_TYPE\_GUID**, then this is the pointer to the GUID which must match the *Guid* field of **EFI\_HII\_GUID\_PACKAGE\_HDR**. Otherwise, it must be NULL.

#### *HandleBufferLength*

On input, a pointer to the length of the handle buffer. On output, the length of the handle buffer that is required for the handles found.

#### *Handle*

An array of **EFI\_HII\_HANDLE** instances returned. Type **EFI\_HII\_HANDLE** is defined in **EFI\_HII\_DATABASE\_PROTOCOL.NewPackageList()** in the Packages section.

### Description

This function returns a list of the package handles of the specified type that are currently active in the database. The pseudo-type **EFI\_HII\_PACKAGE\_TYPE\_ALL** will cause all package handles to be listed.

### Status Codes Returned

EFI\_SUCCESS

A list of Packages was placed in *Handle* successfully.  
*HandleBufferLength* is updated with the actual length.



EFI_BUFFER_TOO_SMALL	The <i>HandleBufferLength</i> parameter indicates that <i>Handle</i> is too small to support the number of handles. <i>HandleBufferLength</i> is updated with a value that will enable the data to fit.
EFI_INVALID_PARAMETER	<i>HandleBufferLength</i> was <b>NULL</b> .
EFI_INVALID_PARAMETER	The value referenced by <i>HandleBufferLength</i> was not zero and <i>Handle</i> was NULL.
EFI_INVALID_PARAMETER	<i>PackageType</i> is a <b>EFI_HII_PACKAGE_TYPE_GUID</b> but <i>PackageGuid</i> is not NULL .
EFI_INVALID_PARAMETER	<i>PackageType</i> is a <b>EFI_HII_PACKAGE_TYPE_GUID</b> but <i>PackageGuid</i> is NULL .
EFI_NOT_FOUND	No matching handles were found

## EFI\_HII\_DATABASE\_PROTOCOL.ExportPackageLists()

### Summary

Exports the contents of one or all package lists in the HII database into a buffer.

### Prototype

```
typedef
EFI_STATUS
(EFI_API *EFI_HII_DATABASE_EXPORT_PACKS) (
  IN CONST EFI_HII_DATABASE_PROTOCOL *This,
  IN EFI_HII_HANDLE Handle,
  IN OUT UINTN *BufferSize,
  OUT EFI_HII_PACKAGE_LIST_HEADER *Buffer
);
```

### Parameters

*This*

A pointer to the **EFI\_HII\_DATABASE\_PROTOCOL** instance.

*Handle*

An **EFI\_HII\_HANDLE** that corresponds to the desired package list in the HII database to export or NULL to indicate all package lists should be exported.

*BufferSize*

On input, a pointer to the length of the buffer. On output, the length of the buffer that is required for the exported data.

*Buffer*

A pointer to a buffer that will contain the results of the export function.

### Description

This function will export one or all package lists in the database to a buffer. For each package list exported, this function will call functions registered with **EXPORT\_PACK** and then copy the package list to the buffer. The registered functions may call [EFI\\_HII\\_DATABASE\\_PROTOCOL.UpdatePackageList\(\)](#) to modify the package list before it is copied to the buffer.

If the specified *BufferSize* is too small, then the status **EFI\_BUFFER\_TOO\_SMALL** will be returned and the actual package size will be returned in *BufferSize*.

### Status Codes Returned

EFI_SUCCESS	Package exported.
EFI_BUFFER_TOO_SMALL	<i>BufferSize</i> is too small to hold the package.
EFI_INVALID_PARAMETER	<i>BufferSize</i> was NULL
EFI_INVALID_PARAMETER	The value referenced by <i>BufferSize</i> was not zero and <i>Buffer</i> was NULL.
EFI_NOT_FOUND	The specified <i>Handle</i> could not be found in the current database.

## EFI\_HII\_DATABASE\_PROTOCOL.RegisterPackageNotify()

### Summary

Registers a notification function for HII database-related events.

### Prototype

```
typedef
EFI_STATUS
(EFI_API *EFI_HII_DATABASE_REGISTER_NOTIFY) (
  IN CONST EFI_HII_DATABASE_PROTOCOL *This,
  IN UINT8      PackageType,
  IN CONST EFI_GUID      *PackageGuid,
  IN CONST EFI_HII_DATABASE_NOTIFY PackageNotifyFn,
  IN EFI_HII_DATABASE_NOTIFY_TYPE NotifyType,
  OUT EFI_HANDLE      *NotifyHandle
);
```

### Parameters

#### *This*

A pointer to the **EFI\_HII\_DATABASE\_PROTOCOL** instance.

#### *PackageType*

The package type. See **EFI\_HII\_PACKAGE\_TYPE\_x** in [EFI\\_HII\\_PACKAGE\\_HEADER](#).

#### *PackageGuid*

If *PackageType* is **EFI\_HII\_PACKAGE\_TYPE\_GUID**, then this is the pointer to the GUID which must match the *Guid* field of **EFI\_HII\_GUID\_PACKAGE\_HDR**. Otherwise, it must be NULL.

#### *PackageNotifyFn*

Points to the function to be called when the event specified by *NotificationType* occurs. See [EFI\\_HII\\_DATABASE\\_NOTIFY](#).

#### *NotifyType*

Describes the types of notification which this function will be receiving. See [EFI\\_HII\\_DATABASE\\_NOTIFY\\_TYPE](#) for more a list of types.

#### *NotifyHandle*

Points to the unique handle assigned to the registered notification. Can be used in [EFI\\_HII\\_DATABASE\\_PROTOCOL.UnregisterPackageNotify\(\)](#) to stop notifications.

### Description

This function registers a function which will be called when specified actions related to packages of the specified type occur in the HII database. By registering a function, other

HII-related drivers are notified when specific package types are added, removed or updated in the HII database.

Each driver or application which registers a notification should use [EFI\\_HII\\_DATABASE\\_PROTOCOL.UnregisterPackageNotify\(\)](#) before exiting.

If a driver registers a **NULL** *PackageGuid* when *PackageType* is **EFI\_HII\_PACKAGE\_TYPE\_GUID**, a notification will occur for every package of type **EFI\_HII\_PACKAGE\_TYPE\_GUID** that is registered.

## Related Definitions

**EFI\_HII\_PACKAGE\_HEADER** is defined in [EFI\\_HII\\_PACKAGE\\_HEADER](#).

**EFI\_HII\_DATABASE\_NOTIFY** is defined in [EFI\\_HII\\_DATABASE\\_NOTIFY](#).

**EFI\_HII\_DATABASE\_NOTIFY\_TYPE** is defined in [EFI\\_HII\\_DATABASE\\_NOTIFY\\_TYPE](#).

## Returned Status Codes

EFI_SUCCESS	Notification registered successfully.
EFI_OUT_OF_RESOURCES	Unable to allocate necessary data structures.
EFI_INVALID_PARAMETER	<i>NotifyHandle</i> is <b>NULL</b> .
EFI_INVALID_PARAMETER	<i>PackageType</i> is not a <b>EFI_HII_PACKAGE_TYPE_GUID</b> but <i>PackageGuid</i> is not NULL.
EFI_INVALID_PARAMETER	<i>PackageType</i> is a <b>EFI_HII_PACKAGE_TYPE_GUID</b> but <i>PackageGuid</i> is NULL.

## EFI\_HII\_DATABASE\_PROTOCOL.UnregisterPackageNotify()

### Summary

Removes the specified HII database package-related notification.

### Prototype

```
typedef
EFI_STATUS
(EFI_API *EFI_HII_DATABASE_UNREGISTER_NOTIFY) (
  IN CONST EFI_HII_DATABASE_PROTOCOL *This,
  IN EFI_HANDLE      NotificationHandle
);
```

### Parameters

*This*

A pointer to the **EFI\_HII\_DATABASE\_PROTOCOL** instance.

*NotificationHandle*

The handle of the notification function being unregistered.

### Returned Status Codes

EFI_SUCCESS	Invalidated
EFI_NOT_FOUND	The <i>NotificationHandle</i> could not be found in the database.

## EFI\_HII\_DATABASE\_PROTOCOL.FindKeyboardLayouts()

### Summary

Retrieves a list of the keyboard layouts in the system.

### Prototype

```
typedef
EFI_STATUS
(EFIAPI *EFI_HII_FIND_KEYBOARD_LAYOUTS) (
  IN CONST EFI_HII_DATABASE_PROTOCOL *This,
  IN OUT UINT16      *KeyGuidBufferLength,
  OUT EFI_GUID      *KeyGuidBuffer
);
```

### Parameters

*This*

A pointer to the **EFI\_HII\_DATABASE\_PROTOCOL** instance.

*KeyGuidBufferLength*

On input, a pointer to the length of the keyboard GUID buffer. On output, the length of the handle buffer that is required for the handles found.

*KeyGuidBuffer*

An array of keyboard layout GUID instances returned.

### Description

This routine retrieves an array of GUID values for each keyboard layout that was previously registered in the system.

### Status Codes Returned

EFI_SUCCESS	<i>KeyGuidBuffer</i> was updated successfully.
EFI_BUFFER_TOO_SMALL	The <i>KeyGuidBufferLength</i> parameter indicates that <i>KeyGuidBuffer</i> is too small to support the number of GUIDs. <i>KeyGuidBufferLength</i> is updated with a value that will enable the data to fit.
EFI_INVALID_PARAMETER	<i>KeyGuidBufferLength</i> is <b>NULL</b> .
EFI_INVALID_PARAMETER	The value referenced by <i>KeyGuidBufferLength</i> is not zero and <i>KeyGuidBuffer</i> is NULL.

## EFI\_HII\_DATABASE\_PROTOCOL.GetKeyboardLayout()

### Summary

Retrieves the requested keyboard layout.

### Prototype

```
typedef
EFI_STATUS
(EFI_API *EFI_HII_GET_KEYBOARD_LAYOUT) (
  IN CONST EFI_HII_DATABASE_PROTOCOL *This,
  IN EFI_GUID *KeyGuid,
  IN OUT UINT16 *KeyboardLayoutLength,
  OUT EFI_HII_KEYBOARD_LAYOUT *KeyboardLayout
);
```

### Parameters

*This*

A pointer to the **EFI\_HII\_DATABASE\_PROTOCOL** instance.

*KeyGuid*

A pointer to the unique ID associated with a given keyboard layout. If *KeyGuid* is NULL then the current layout will be retrieved.

*KeyboardLayout*

A pointer to a buffer containing the retrieved keyboard layout. below.

*KeyboardLayoutLength*

On input, a pointer to the length of the KeyboardLayout buffer. On output, the length of the data placed into KeyboardLayout.

### Description

This routine retrieves the requested keyboard layout. The layout is a physical description of the keys on a keyboard and the character(s) that are associated with a particular set of key strokes.

## Related Definitions

```

//*****
// EFI_HII_KEYBOARD_LAYOUT
//*****
typedef struct {
  UINT16  LayoutLength;
  EFI_GUID  Guid;
  UINT32  LayoutDescriptorStringOffset;
  UINT8   DescriptorCount;
  EFI_KEY_DESCRIPTOR  Descriptors[];
} EFI_HII_KEYBOARD_LAYOUT;

```

### *LayoutLength*

The length of the current keyboard layout.

### *Guid*

The unique ID associated with this keyboard layout.

### *LayoutDescriptorStringOffset*

An offset location (0 is the beginning of the **EFI\_KEYBOARD\_LAYOUT** instance) of the string which describes this keyboard layout. The data that is being referenced is in **EFI\_DESCRIPTION\_STRING\_BUNDLE** format.

### *DescriptorCount*

The number of Descriptor entries in this layout.

### *Descriptors*

An array of key descriptors.

```

//*****
// EFI_DESCRIPTION_STRING - byte packed data
//*****
CHAR16  Language[];
CHAR16  Space;
//CHAR16  DescriptionString[];

```

### *Language*

The language in RFC 4646 format to associate with *DescriptionString*.

### *Space*

A space (U-0x0020) character to force as a separator between the *Language* field and the formal description string.

### *DescriptionString*

A null-terminated description string.



```

//*****
// EFI_DESCRIPTION_STRING_BUNDLE - byte packed data
//
// Example: 2en-US English Keyboard<null>es-ES Keyboard en ingles<null>
// <null> = U-0000
//*****
UINT16      DescriptionCount;
EFI_DESCRIPTION_STRING DescriptionString[];

```

*DescriptionCount*

The number of description strings.

*DescriptionString*

An array of language-specific description strings.

```

//*****
// EFI_KEY_DESCRIPTOR
//*****
typedef struct {
EFI_KEY      Key;
CHAR16      Unicode;
CHAR16      ShiftedUnicode;
CHAR16      AltGrUnicode;
CHAR16      ShiftedAltGrUnicode;
UINT16      Modifier;
UINT16      AffectedAttribute;
} EFI_KEY_DESCRIPTOR;

```

// A key which is affected by all the standard shift modifiers.

// Most keys would be expected to have this bit active.

```
#define EFI_AFFECTED_BY_STANDARD_SHIFT 0x0001
```

// This key is affected by the caps lock so that if a keyboard

// driver would need to disambiguate between a key which had a

// "1" defined versus a "a" character. Having this bit turned on

// would tell the keyboard driver to use the appropriate shifted // state or not.

```
#define EFI_AFFECTED_BY_CAPS_LOCK 0x0002
```

// Similar to the case of CAPS lock, if this bit is active, the

// key is affected by the num lock being turned on.

```
#define EFI_AFFECTED_BY_NUM_LOCK 0x0004
```

*Key*

Used to describe a physical key on a keyboard. Type **EFI\_KEY** is defined below.

*Unicode*

Unicode character code for the *Key*.

*ShiftedUnicode*

Unicode character code for the key with the shift key being held down.

*AltGrUnicode*

Unicode character code for the key with the Alt-GR being held down.

*ShiftedAltGrUnicode*

Unicode character code for the key with the Alt-GR and shift keys being held down.

*Modifier*

Modifier keys are defined to allow for special functionality that is not necessarily accomplished by a printable character. Many of these modifier keys are flags to toggle certain state bits on and off inside of a keyboard driver. Values for *Modifier* are defined below.

```

//*****
// EFI_KEY
//*****
typedef enum {
  EfiKeyLCtrl, EfiKeyA0, EfiKeyLAlt, EfiKeySpaceBar,
  EfiKeyA2, EfiKeyA3, EfiKeyA4, EfiKeyRCtrl, EfiKeyLeftArrow,
  EfiKeyDownArrow, EfiKeyRightArrow, EfiKeyZero,
  EfiKeyPeriod, EfiKeyEnter, EfiKeyLShift, EfiKeyB0,
  EfiKeyB1, EfiKeyB2, EfiKeyB3, EfiKeyB4, EfiKeyB5, EfiKeyB6,
  EfiKeyB7, EfiKeyB8, EfiKeyB9, EfiKeyB10, EfiKeyRShift,
  EfiKeyUpArrow, EfiKeyOne, EfiKeyTwo, EfiKeyThree,
  EfiKeyCapsLock, EfiKeyC1, EfiKeyC2, EfiKeyC3, EfiKeyC4,
  EfiKeyC5, EfiKeyC6, EfiKeyC7, EfiKeyC8, EfiKeyC9,
  EfiKeyC10, EfiKeyC11, EfiKeyC12, EfiKeyFour, EfiKeyFive,
  EfiKeySix, EfiKeyPlus, EfiKeyTab, EfiKeyD1, EfiKeyD2,
  EfiKeyD3, EfiKeyD4, EfiKeyD5, EfiKeyD6, EfiKeyD7, EfiKeyD8,
  EfiKeyD9, EfiKeyD10, EfiKeyD11, EfiKeyD12, EfiKeyD13,
  EfiKeyDel, EfiKeyEnd, EfiKeyPgDn, EfiKeySeven, EfiKeyEight,
  EfiKeyNine, EfiKeyE0, EfiKeyE1, EfiKeyE2, EfiKeyE3,
  EfiKeyE4, EfiKeyE5, EfiKeyE6, EfiKeyE7, EfiKeyE8, EfiKeyE9,
  EfiKeyE10, EfiKeyE11, EfiKeyE12, EfiKeyBackSpace,
  EfiKeyIns, EfiKeyHome, EfiKeyPgUp, EfiKeyNLck, EfiKeySlash,
  EfiKeyAsterisk, EfiKeyMinus, EfiKeyEsc, EfiKeyF1, EfiKeyF2,
  EfiKeyF3, EfiKeyF4, EfiKeyF5, EfiKeyF6, EfiKeyF7, EfiKeyF8,
  EfiKeyF9, EfiKeyF10, EfiKeyF11, EfiKeyF12, EfiKeyPrint,
  EfiKeySLck, EfiKeyPause
} EFI_KEY;

```

See the figure below for which key corresponds to the values in the enumeration above. For example, **EfiKeyLCtrl** corresponds to the left control key in the lower-left corner of

the keyboard, **EfiKeyFour** corresponds to the 4 key on the numeric keypad, and **EfiKeySLck** corresponds to the Scroll Lock key in the upper-right corner of the keyboard.

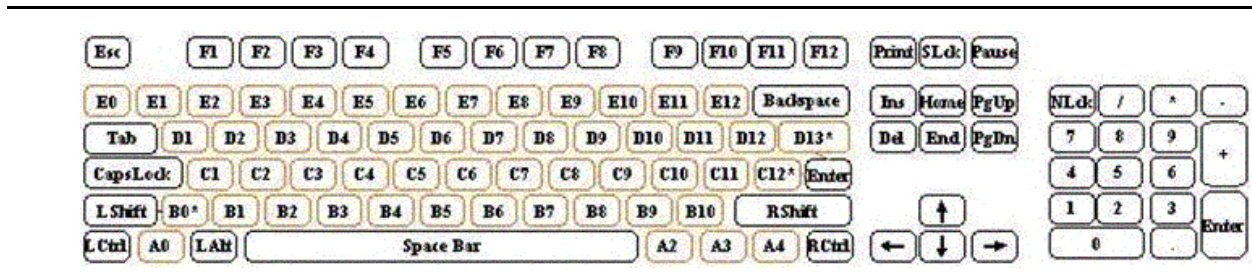

Figure 138. Keyboard Layout

```

//*****
// Modifier values
//*****
#define EFI_NULL_MODIFIER      0x0000
#define EFI_LEFT_CONTROL_MODIFIER  0x0001
#define EFI_RIGHT_CONTROL_MODIFIER 0x0002
#define EFI_LEFT_ALT_MODIFIER    0x0003
#define EFI_RIGHT_ALT_MODIFIER   0x0004
#define EFI_ALT_GR_MODIFIER      0x0005
#define EFI_INSERT_MODIFIER      0x0006
#define EFI_DELETE_MODIFIER      0x0007
#define EFI_PAGE_DOWN_MODIFIER   0x0008
#define EFI_PAGE_UP_MODIFIER     0x0009
#define EFI_HOME_MODIFIER        0x000A
#define EFI_END_MODIFIER         0x000B
#define EFI_LEFT_SHIFT_MODIFIER  0x000C
#define EFI_RIGHT_SHIFT_MODIFIER 0x000D
#define EFI_CAPS_LOCK_MODIFIER   0x000E
#define EFI_NUM_LOCK_MODIFIER    0x000F
#define EFI_LEFT_ARROW_MODIFIER  0x0010
#define EFI_RIGHT_ARROW_MODIFIER 0x0011
#define EFI_DOWN_ARROW_MODIFIER  0x0012
#define EFI_UP_ARROW_MODIFIER    0x0013
#define EFI_NS_KEY_MODIFIER      0x0014
#define EFI_NS_KEY_DEPENDENCY_MODIFIER 0x0015
#define EFI_FUNCTION_KEY_ONE_MODIFIER 0x0016
#define EFI_FUNCTION_KEY_TWO_MODIFIER 0x0017
#define EFI_FUNCTION_KEY_THREE_MODIFIER 0x0018
#define EFI_FUNCTION_KEY_FOUR_MODIFIER 0x0019
#define EFI_FUNCTION_KEY_FIVE_MODIFIER 0x001A
#define EFI_FUNCTION_KEY_SIX_MODIFIER 0x001B
#define EFI_FUNCTION_KEY_SEVEN_MODIFIER 0x001C
#define EFI_FUNCTION_KEY_EIGHT_MODIFIER 0x001D
#define EFI_FUNCTION_KEY_NINE_MODIFIER 0x001E
#define EFI_FUNCTION_KEY_TEN_MODIFIER 0x001F
#define EFI_FUNCTION_KEY_ELEVEN_MODIFIER 0x0020
#define EFI_FUNCTION_KEY_TWELVE_MODIFIER 0x0021
//
// Keys that have multiple control functions based on modifier
// settings are handled in the keyboard driver implementation.
// For instance PRINT_KEY might have a modifier held down and
// is still a nonprinting character, but might have an alternate
// control function like SYSREQUEST
//
#define EFI_PRINT_MODIFIER      0x0022
#define EFI_SYS_REQUEST_MODIFIER 0x0023
#define EFI_SCROLL_LOCK_MODIFIER 0x0024

```

```
#define EFI_PAUSE_MODIFIER    0x0025
#define EFI_BREAK_MODIFIER    0x0026
#define EFI_LEFT_LOGO_MODIFIER 0x0027
#define EFI_RIGHT_LOGO_MODIFIER 0x0028
#define EFI_MENU_MODIFIER     0x0029
```

## Status Codes Returned

EFI_SUCCESS	The keyboard layout was retrieved successfully.
EFI_NOT_FOUND	The requested keyboard layout was not found.
EFI_BUFFER_TOO_SMALL	The <i>KeyboardLayoutLength</i> parameter indicates the <i>KeyboardLayout</i> is too small to hold the keyboard layout.
EFI_INVALID_PARAMETER	<i>KeyboardLayoutLength</i> is <b>NULL</b>
EFI_INVALID_PARAMETER	The value referenced by <i>KeyboardLayoutLength</i> is not zero and <i>KeyboardLayout</i> is NULL.

## EFI\_HII\_DATABASE\_PROTOCOL.SetKeyboardLayout()

### Summary

Sets the currently active keyboard layout.

### Prototype

```
typedef
EFI_STATUS
(EFIAPI *EFI_HII_SET_KEYBOARD_LAYOUT) (
  IN CONST EFI_HII_DATABASE_PROTOCOL *This,
  IN EFI_GUID *KeyGuid
);
```

### Parameters

*This*

A pointer to the **EFI\_HII\_DATABASE\_PROTOCOL** instance.

*KeyGuid*

A pointer to the unique ID associated with a given keyboard layout.

### Description

This routine sets the default keyboard layout to the one referenced by *KeyGuid*. When this routine is called, an event will be signaled of the **EFI\_HII\_SET\_KEYBOARD\_LAYOUT\_EVENT\_GUID** group type. This is so that agents which are sensitive to the current keyboard layout being changed can be notified of this change.

### Related Definitions

#### GUID

```
#define EFI_HII_SET_KEYBOARD_LAYOUT_EVENT_GUID \
  { 0x14982a4f, 0xb0ed, 0x45b8, \
    { 0xa8, 0x11, 0x5a, 0x7a, 0x9b, 0xc2, 0x32, 0xdf } }
```

### Status Codes Returned

EFI_SUCCESS	The current keyboard layout was successfully set.
EFI_NOT_FOUND	The referenced keyboard layout was not found, so action was taken.
EFI_INVALID_PARAMETER	<i>KeyGuid</i> is NULL.

## EFI\_HII\_DATABASE\_PROTOCOL.GetPackageListHandle()

### Summary

Return the EFI handle associated with a package list.

### Prototype

```
typedef
EFI_STATUS
(EFIAPI *EFI_HII_DATABASE_GET_PACK_HANDLE) (
  IN CONST EFI_HII_DATABASE_PROTOCOL  *This,
  IN EFI_HII_HANDLE                   PackageListHandle,
  OUT EFI_HANDLE                       *DriverHandle
);
```

### Parameters

*This*

A pointer to the **EFI\_HII\_DATABASE\_PROTOCOL** instance.

*PackageListHandle*

An **EFI\_HII\_HANDLE** that corresponds to the desired package list in the HII database.

*DriverHandle*

On return, contains the **EFI\_HANDLE** which was registered with the package list in **NewPackageList()**.

### Status Codes Returned

EFI_SUCCESS	The <i>DriverHandle</i> was returned successfully.
EFI_INVALID_PARAMETER	The <i>PackageListHandle</i> was not valid.
EFI_INVALID_PARAMETER	The <i>DriverHandle</i> must not be <b>NULL</b> .

## 33.8.1 Database Structures

### EFI\_HII\_DATABASE\_NOTIFY

#### Summary

Handle a registered notification for a package change to the database.

## Prototype

```
typedef
EFI_STATUS
(EFI_API *EFI_HII_DATABASE_NOTIFY) (
  IN UINT8      PackageType,
  IN CONST EFI_GUID *PackageGuid,
  IN CONST EFI_HII_PACKAGE_HEADER *Package,
  IN EFI_HII_HANDLE Handle,
  IN EFI_HII_DATABASE_NOTIFY_TYPE NotifyType
);
```

## Parameters

### *PackageType*

Package type of the notification.

### *PackageGuid*

If *PackageType* is **EFI\_HII\_PACKAGE\_TYPE\_GUID**, then this is the pointer to the GUID from the *Guid* field of **EFI\_HII\_GUID\_PACKAGE\_HDR**. Otherwise, it must be NULL.

### *Package*

Points to the package referred to by the notification

### *Handle*

The handle of the package list which contains the specified package.

### *NotifyType*

The type of change concerning the database. See [EFI\\_HII\\_DATABASE\\_NOTIFY\\_TYPE](#).

## Description

Functions which are registered to receive notification of database events have this prototype. The actual event is encoded in *NotifyType*. The following table describes how *PackageType*, *PackageGuid*, *Handle*, and *Package* are used for each of the notification types.

Notification Type	Parameter Description
NEW_PACK	<i>PackageType</i> and <i>PackageGuid</i> are the type of the new package. <i>Package</i> points to the new package. <i>Handle</i> is the handle of the package list which is being added to the database.
REMOVE_PACK	<i>PackageType</i> and <i>PackageGuid</i> are the type of the package which is being removed. <i>Package</i> points to the package being removed. <i>Handle</i> is the package list from which the package is being removed.



EXPORT_PACK	<i>PackageType</i> and <i>PackageGuid</i> are the type of the package being exported. <i>Package</i> points to the existing package in the database. <i>Handle</i> is the package list being exported.
ADD_PACK	<i>PackageType</i> and <i>PackageGuid</i> are the type of the package being added. <i>Package</i> points to the package being added. <i>Handle</i> is the package list to which the package is being added.

## EFI\_HII\_DATABASE\_NOTIFY\_TYPE

```
typedef UINTN EFI_HII_DATABASE_NOTIFY_TYPE;
```

```
#define EFI_HII_DATABASE_NOTIFY_NEW_PACK 0x00000001  
#define EFI_HII_DATABASE_NOTIFY_REMOVE_PACK 0x00000002  
#define EFI_HII_DATABASE_NOTIFY_EXPORT_PACK 0x00000004  
#define EFI_HII_DATABASE_NOTIFY_ADD_PACK 0x00000008
```



# 34 HII Configuration Processing and Browser Protocol

---

## 34.1 Introduction

This section describes the data and APIs used to manage the system's configuration: the actual data that describes the knobs and settings.

### 34.1.1 Common Configuration Data Format

The configuration data is stored as name / value string pairs. As in e.g. HTML, the name and value are separated by '=' and the pairs are separated one from the next by '&'. The configuration data structures are thus variable length UNICODE (UCS-2) strings.

Certain names and values have limitations on their syntax to manage routing and to enable extended support for common storage mechanisms.

### 34.1.2 Data Flow

There is a two-way flow through the hierarchy of drivers and protocols that parallels the flow in other parts of HII. Initially, the flow is from the drivers up to the HII database and on to configuration applications. When changes to configuration are accepted, the flow reverses itself, going from the configuration applications through the HII database protocols back to the drivers through separate protocols.

The flow from driver up consists of the current and alternative (default) configurations. The flow down from the configuration applications consists of changed configurations.

The protocol managed by the HII Database is known as the EFI HII Configuration Routing Protocol, while the one presented by the drivers themselves is known as the EFI HII Configuration Access Protocol. The HII Configuration Routing Protocol is the only one that outside callers should invoke.

## 34.2 Configuration Strings

The configuration strings follow the same general format as HTTP argument strings, which is to say '&' separated name / value pairs. The name and value are separated by '='. The strings are a subset of full HTML argument strings and do not require quoting, the '%' character sequences used to insert spaces, ampersands, equal signs, and the like into HTTP argument strings.

### 34.2.1 String Syntax

Assumptions are typical for BNF with the following extensions

Characters in single quotes, e.g. 'a', indicate terminals.

Square brackets immediately followed by a number n indicate that the contents are to be repeated n times, so [a]4 would be "aaaa".

An italicized non-terminal, e. g. *<All Printable ASCII Characters>* is used to indicate a set of terminals whose definition is outside the scope of this document.

The syntax for configuration strings is as follows.

### 34.2.1.1 Basic forms

```

<Dec19> ::= '1' | '2' | ... | '9'
<DecCh> ::= '0' | <Dec19>
<HexAf> ::= 'a' | 'b' | 'c' | 'd' | 'e' | 'f'
<Hex1f> ::= <Dec19> | <HexAf>
<HexCh> ::= <DecCh> | <HexAf>
<Number> ::= <HexCh>+
<Alpha> ::= 'a' | ... | 'z' | 'A' | ... | 'Z'

```

### 34.2.1.2 Types

```

<Guid> ::= <HexCh>32
<LabelStart> ::= <Alpha> | "_"
<LabelBody> ::= <LabelStart> | <DecCh>
<Label> ::= <LabelStart> [<LabelBody>]*
<Char> ::= <HexCh>4
<String> ::= [<Char>]+
<AltCfgId> ::= <HexCh>4

```

### 34.2.1.3 Routing elements

```

<GuidHdr> ::= 'GUID='<Guid>
<NameHdr> ::= 'NAME='<String>
<PathHdr> ::= 'PATH='<UEFI binary Device Path represented as hex number>
<DescHdr> ::= 'ALTCFG='<AltCfgId>
<ConfigHdr> ::= <GuidHdr>'&'<NameHdr>'&'<PathHdr>
<AltConfigHdr> ::= <ConfigHdr> '&'<DescHdr>

```

### 34.2.1.4 Body elements

```

<ConfigBody> ::= <ConfigElement>*
<ConfigElement> ::= '&'<BlockConfig> | '&'<NvConfig>
<BlockName> ::= 'OFFSET='<Number>'&'WIDTH='<Number>
<BlockConfig> ::= <BlockName>'&'VALUE='<Number>
<RequestElement> ::= '&'<BlockName> | '&'<Label>
<NvConfig> ::= <Label>'='<String> | <Label>'='<Number>

```

### 34.2.1.5 Configuration strings

```

<ConfigRequest> ::= <ConfigHdr><RequestElement>*
<MultiConfigRequest> ::= <ConfigRequest>['&' <ConfigRequest>]*
<ConfigResp> ::= <ConfigHdr><ConfigBody>
<AltResp> ::= <AltConfigHdr><ConfigBody>
<ConfigAltResp> ::= <ConfigResp> ['&' <AltResp>]*
<MultiConfigAltResp> ::= <ConfigAltResp> ['&' <ConfigAltResp>]*
<MultiConfigResp> ::= <ConfigResp> ['&' <ConfigResp>]*

```

#### Notes:

The *<Number>* represents a data buffer and is encoded as a sequence of bytes in the format %02x in the same order as the buffer bytes reside in memory.

The *<Guid>* represents a hex encoding of GUID and is encoded as a sequence of bytes in the format %02x in the same order as the GUID bytes reside in memory.

The syntax for a *<Label>* is the C label (e.g. Variable) syntax.

The *<ConfigHdr>* provides routing information. The name field is required even if non-block storage is targeted. In these cases, it may be used as a way to distinguish like storages from one another when a driver is being used

The *<BlockName>* provides addressing information for managing block (e.g. UEFI Variable) storage. The first number provides the byte offset into the block while the second provides the length of bytes.

The *<PathHdr>* presents a hex encoding of a UEFI device path. This is not the printable path since the printable path is optional in UEFI and to enable simpler comparisons. The data is encoded as strings with the format %02x bytes in the same order as the device path resides in RAM memory.

The *<ConfigRequest>* provides a mechanism to request the current configuration for one or more elements.

The *<AltCfgId>* is the identifier of a configuration declared in the corresponding IFR.

The name 'GUID' is also used to separate *<String>* or *<ConfigRequest>* elements in the equivalent *Multi* version. That is:

GUID=...&NAME=...&...&fred=12&GUID=...&NAME=...&...&goyle=11

Indicates two *<String>*, with one ending with fred=12.

The following are reserved *<name>*s and cannot be used as names in a *<ConfigElement>*:

**GUID**  
**NAME**  
**PATH**  
**ALTCFG**  
**OFFSET**  
**WIDTH**  
**VALUE**

### 34.2.1.6 Keyword strings

```

<NameSpaceId> ::= 'NAMESPACE='<String>'&
<Keyword> ::= 'KEYWORD='<String>[:'<DecCh>(1/4)]
<DataFilter> ::= 'Buffer'|'Numeric'[:'1'|'2'|'4'|'8']
<UsageFilter> ::= 'ReadOnly'|'ReadWrite'
<Filter> ::= <UsageFilter>|<DataFilter>|<UsageFilter>'&'<DataFilter>
<KeywordRequest> ::= [<PathHdr>'&']<Keyword>['&'<Filter>]
<KeywordResp> ::= <NameSpaceId><PathHdr>'&'<Keyword>'&VALUE='<Number>
    ['&READONLY']
<MultiKeywordRequest> ::= <KeywordRequest>['&'<KeywordRequest>]*
<MultiKeywordResp> ::= <KeywordResp>['&'<KeywordResp>]*

```

**Note:** For Keyword definitions, see the UEFI Configuration Namespace Registry document on <http://uefi.org/uefi>.

The **<NameSpaceId>** element is equivalent to the platform configuration language being used for the keyword definition.

The **<Keyword>** element uses the 'KEYWORD=' name to designate that immediately following the reserved name is a string value associated with a configuration namespace keyword as defined in the Configuration NameSpace Registry document (<http://uefi.org/uefi>).

Typically, when a Keyword is defined, the value is a solitary string such as "BIOSVendor". However, when certain Keywords are intended to represent a setting that may have multiple instances (e.g. ChipsetSATAPortEnable), that is when a ":<DecCh>(1/4)" suffix will be appended to the keyword definition. In that case, we might see something like: "ChipsetSATAPortEnable:5" if a particular platform had at least five SATA ports and one of the questions was represented by the aforementioned string. It would also be reasonable to expect that there might also be a "ChipsetSATAPortEnable:1" and a "2", "3" etc.

If the **<PathHdr>** element within **<KeywordRequest>** is omitted, then all instances are returned.

If the Keyboard Handler protocol knows or detects that a particular Keyword is read-only, then the **<KeywordResp>** must include the "&READONLY" tag.

The **<DataFilter>** element specifies the optional filter based on data type to use when a request is made. If no filtering is desired, then this element must be omitted from the **<KeywordRequest>**. Filtering is not guaranteed to work on any platform configuration language that isn't defined in the UEFI Configuration Namespace Document.

#### **DataFilter.Buffer**

A sequence of data that has a format that does not fit the common usage case of a Numeric. This is most commonly represented in 'C' as a VOID type, or is a more complex type such as one typified by a typedef struct. Other than the **EFI\_IFR\_TYPE\_BOOLEAN** and **EFI\_IFR\_TYPE\_NUM\_x** data types, all of the HII configuration data types are treated as a sequence of data.

#### **DataFilter.Numeric**

A sequence of data that must be interpreted as a one, two, four, or eight-byte wide numeric value. For instance, a definition of "Numeric:2" would indicate that the keyword is a two-byte numeric value. If no byte-size designation is specified, then the value may vary in size.

The **<UsageFilter>** element defines the optional filter to use based on usage type when a request is made. If no filtering is desired, then this element must be omitted from the **<KeywordRequest>**.

#### **UsageType.ReadOnly**

The data for the keyword cannot be changed. It is intended solely for informational purposes, and can be used to read a setting that may be static or dynamic (e.g. CPU temperature).

#### **UsageType.ReadWrite**

The data for the keyword can be changed.

### **34.2.1.6.1 An example of some basic keyword-related strings:**

**<KeywordRequest>** to retrieve the current BIOS Vendor name:  
**KEYWORD=BIOSVendor**

### **34.2.1.6.2 A possible response might look like:**

**x-UEFI-ns&KEYWORD=BIOSVendor&VALUE=AcmeBIOSCompany**

If a request was made to retrieve all of the settings for a platform, a user would initiate a call to `KeywordHandlerGetData()` with the `KeywordString` and `NamespaceId` being `NULL`.

### **34.2.1.6.3 A possible response might look like:**

**x-UEFI-ns&KEYWORD=BIOSVendor&VALUE=AcmeBIOSCompany&x-UEFI-extension-ACME&KEYWORD=SpecialSettingX&VALUE=3**

In this case, the string returned tells us that there was one discovered keyword called "BIOSVendor" under the standard UEFI namespace and its value was "AcmeBIOS". There was also an ACME branded namespace element which was discovered that had a keyword called "SpecialSettingX" whose value was 3.



## 34.2.2 String Types

There are six string types. As can be seen from the BNF, the syntax of all is quite similar. The first three are used in communications between drivers and HII. The last three are used for analogous communication between external applications and HII.

**<ConfigRequest>**: This string is used by HII to request the current and any alternative configurations from a driver. It consists of routing information and only ampersand separated names.

**<ConfigAltResp>**: A string in this format is returned by the driver in response to a request to fill in a **<ConfigRequest>** string. The string consists of the current configuration followed by possibly several alternative configurations. The alternative configurations have the **ALTCFG** name / value pair in addition to the usual **GUID**, **NAME**, and **PATH** entries in the routing prefix. The **ALTCFG** value is a Default ID which is used to describe the alternative default configuration.

**<ConfigResp>**: A string in this format is handed by the HII to the driver to cause the driver to change its configuration. It consists of routing information and name / value pairs which correspond to the questions in the driver's IFR. Only **<ConfigResp>** strings which refer to a driver in question may be handed to that driver. The driver shall reject all others.

**<MultiConfigRequest>**: A string in this format is handed to HII by an external application in order to request the current and alternate configurations of the system's drivers. The format of this string is a series of **<ConfigRequest>** strings separated by ampersands. The HII's job is to separate the requests and hand them off to the appropriate drivers (as indicated by the routing headers).

**<MultiConfigAltResp>**: A string in this format is handed back to an external application which has requested the current and alternate configurations of the system's drivers. The format of this string is a series of **<ConfigAltResp>** strings separated by ampersands. The HII creates this string by concatenating the current and alternate configuration strings provided by each driver.

**<MultiConfigResp>**: A string in this format is handed to the HII in order to update the system's configuration. Analogous to the other "Multi" string formats, its syntax is a series of ampersand separated **<ConfigResp>** strings. Upon receipt, the HII routes the **<ConfigResp>** strings to the corresponding drivers.

## 34.3 EFI Configuration Keyword Handler Protocol

This section provides a detailed description of the EFI Configuration Keyword Handler Protocol.

### EFI\_CONFIG\_KEYWORD\_HANDLER\_PROTOCOL

#### Summary

The **EFI\_CONFIG\_KEYWORD\_HANDLER\_PROTOCOL** provides the mechanism to set and get the values associated with a keyword exposed through a x-UEFI- prefixed configuration language namespace.

## GUID

```
#define EFI_CONFIG_KEYWORD_HANDLER_PROTOCOL_GUID \
{ 0x0a8badd5, 0x03b8, 0x4d19, \
  {0xb1, 0x28, 0x7b, 0x8f, 0x0e, 0xda, 0xa5, 0x96 } }
```

## Protocol Interface Structure

```
typedef struct _EFI_CONFIG_KEYWORD_HANDLER_PROTOCOL {
  EFI_CONFIG_KEYWORD_HANDLER_SET_DATA SetData;
  EFI_CONFIG_KEYWORD_HANDLER_GET_DATA GetData;
} EFI_CONFIG_KEYWORD_HANDLER_PROTOCOL;
```

## Parameters

<i>SetData</i>	Set the data associated with a particular configuration namespace keyword.
<i>GetData</i>	Get the data associated with a particular configuration namespace keyword.

## Description

The **EFI\_CONFIG\_KEYWORD\_HANDLER\_PROTOCOL** allows other components in the platform (e.g. Browser, Manageability Software, etc.) to retrieve and set configuration settings within the system.

Keywords are text elements which are associated with a particular configuration option within the platform. These keywords are intended to add semantic meaning to the configuration option they are attached to. The text associated for the keyword would be encoded in a UEFI configuration language. These languages are like French or German or Japanese, but are not designed for display purposes for an end-user. Instead each language serves as a namespace for the purposes of grouping and manipulating groups of platform configurations options. See [Section 32.2.11.2](#) (Working with a UEFI Configuration Language) for more information.

**Note:** *Not all configuration options will be associated with a keyword. Associating a keyword with a configuration option is at the discretion of the platform and/or the hardware vendor. For more information about keyword definitions associated with a UEFI namespace, see the UEFI Keyword Namespace Registry link in the UEFI Link Document.*

## EFI\_KEYWORD\_HANDLER\_PROTOCOL.SetData()

### Summary

Set the data associated with a particular configuration namespace keyword.

### Prototype

```
typedef
EFI_STATUS
(EFI_API *EFI_KEYWORD_HANDLER_SET_DATA) (
  IN EFI_KEYWORD_HANDLER_PROTOCOL *This,
  IN CONST EFI_STRING KeywordString,
  OUT EFI_STRING *Progress,
  OUT UINT32 *ProgressErr
);
```

### Parameters

<i>This</i>	Pointer to the <b>EFI_KEYWORD_HANDLER_PROTOCOL</b> instance.
<i>KeywordString</i>	A null-terminated string in <b>&lt;MultiKeywordResp&gt;</b> format.
<i>Progress</i>	On return, points to a character in the <i>KeywordString</i> . Points to the string's NULL terminator if the request was successful. Points to the most recent '&' before the first failing name / value pair (or the beginning of the string if the failure is in the first name / value pair) if the request was not successful.
<i>ProgressErr</i>	If during the processing of the <i>KeywordString</i> there was a failure, this parameter gives additional information about the possible source of the problem. The various errors are defined in "Related Definitions" below.

### Description

This function accepts a **<MultiKeywordResp>** formatted string, finds the associated keyword owners, creates a **<MultiConfigResp>** string from it and forwards it to the **EFI\_HII\_ROUTING\_PROTOCOL.RouteConfig** function.

If there is an issue in resolving the contents of the *KeywordString*, then the function returns an error and also sets the *Progress* and *ProgressErr* with the appropriate information about where the issue occurred and additional data about the nature of the issue.

In the case when *KeywordString* containing multiple keywords, when an **EFI\_NOT\_FOUND** error is generated during processing the second or later keyword element, the system storage associated with earlier keywords is not modified. All elements of the *KeywordString* must successfully pass all tests for format and access prior to making any modifications to storage.

In the case when **EFI\_DEVICE\_ERROR** is returned from the processing of a *KeywordString* containing multiple keywords, the state of storage associated with earlier keywords is undefined.

### Related Definitions

```

//*****
// Progress Errors
//*****
#define KEYWORD_HANDLER_NO_ERROR      0x00000000
#define KEYWORD_HANDLER_NAMESPACE_ID_NOT_FOUND 0x00000001
#define KEYWORD_HANDLER_MALFORMED_STRING 0x00000002
#define KEYWORD_HANDLER_KEYWORD_NOT_FOUND 0x00000004
#define KEYWORD_HANDLER_INCOMPATIBLE_VALUE_DETECTED 0x00000008
#define KEYWORD_HANDLER_ACCESS_NOT_PERMITTED 0x00000010
#define KEYWORD_HANDLER_UNDEFINED_PROCESSING_ERROR 0x80000000
    
```

The **KEYWORD\_HANDLER\_x** values describe the error values returned in the *ProgressErr* field.

If no errors were encountered, then **KEYWORD\_HANDLER\_NO\_ERROR** is returned with no bits are set.

If the **<NameSpaceId>** specified by the *KeywordString* was not found in any of the registered configuration data, the **KEYWORD\_HANDLER\_NAMESPACE\_ID\_NOT\_FOUND** bit is set.

If there was an error in the parsing of the *KeywordString*, the **KEYWORD\_HANDLER\_MALFORMED\_STRING** bit is set.

If there was a keyword specified in the *KeywordString* which was not found in any of the registered configuration data, **KEYWORD\_HANDLER\_KEYWORD\_NOT\_FOUND** bit is set.

If the value either passed into *KeywordString* (during a *SetData* operation) or the value discovered for the *Keyword* (during a *GetData* operation) did not match what was known to be valid for the defined keyword, the **KEYWORD\_HANDLER\_INCOMPATIBLE\_VALUE\_DETECTED** bit is set.

If there was an error as a result of a violation of system policy. For example trying to write a read-only element, the **KEYWORD\_HANDLER\_ACCESS\_NOT\_PERMITTED** bit is set.

If there was an undefined type of error in processing the passed in data, the **KEYWORD\_HANDLER\_UNDEFINED\_PROCESSING\_ERROR** bit is set.

### Status Codes Returned

EFI_SUCCESS	The specified action was completed successfully.
EFI_INVALID_PARAMETER	One or more of the following are <b>TRUE</b> : <i>KeywordString</i> is NULL . Parsing of the <i>KeywordString</i> resulted in an error. See <i>Progress</i> and <i>ProgressErr</i> for more data.

EFI_NOT_FOUND	An element of the <i>KeywordString</i> was not found. See <i>ProgressErr</i> for more data.
EFI_OUT_OF_RESOURCES	Required system resources could not be allocated. See <i>ProgressErr</i> for more data.
EFI_ACCESS_DENIED	The action violated system policy. See <i>ProgressErr</i> for more data.
EFI_DEVICE_ERROR	An unexpected system error occurred. See <i>ProgressErr</i> for more data.

## EFI\_KEYWORD\_HANDLER\_PROTOCOL.GetData()

### Summary

Get the data associated with a particular configuration namespace keyword.

### Prototype

```
typedef
EFI_STATUS
(EFI_API *EFI_KEYWORD_HANDLER_GET_DATA) (
    IN EFI_KEYWORD_HANDLER_PROTOCOL *This,
    IN CONST EFI_STRING    NameSpaceId, OPTIONAL
    IN CONST EFI_STRING    KeywordString, OPTIONAL
    OUT EFI_STRING         *Progress,
    OUT UINT32             *ProgressErr,
    OUT EFI_STRING         *Results
);
```

### Parameters

<i>This</i>	Pointer to the <b>EFI_KEYWORD_HANDLER_PROTOCOL</b> instance.
<i>NameSpaceId</i>	A null-terminated string containing the platform configuration language to search through in the system. If a NULL is passed in, then it is assumed that any platform configuration language with the prefix of "x-UEFI-" are searched.
<i>KeywordString</i>	A null-terminated string in <b>&lt;MultiKeywordRequest&gt;</b> format. If a NULL is passed in the <i>KeywordString</i> field, all of the known keywords in the system for the <i>NameSpaceId</i> specified are returned in the Results field.
<i>Progress</i>	On return, points to a character in the <i>KeywordString</i> . Points to the string's NULL terminator if the request was successful. Points to the most recent '&' before the first failing name / value pair (or the beginning of the string if the failure is in the first name / value pair) if the request was not successful.
<i>ProgressErr</i>	If during the processing of the <i>KeywordString</i> there was a failure, this parameter gives additional information about the possible source of the problem. See the definitions in <b>SetData()</b> for valid value definitions.
<i>Results</i>	A null-terminated string in <b>&lt;MultiKeywordResp&gt;</b> format is returned which has all the values filled in for the keywords in the <i>KeywordString</i> . This is a callee-allocated field, and must be freed by the caller after being used.

## Description

This function accepts a **<MultiKeywordRequest>** formatted string, finds the underlying keyword owners, creates a **<MultiConfigRequest>** string from it and forwards it to the **EFI\_HII\_ROUTING\_PROTOCOL.ExtractConfig** function.

If there is an issue in resolving the contents of the *KeywordString*, then the function returns an **EFI\_INVALID\_PARAMETER** and also set the *Progress* and *ProgressErr* with the appropriate information about where the issue occurred and additional data about the nature of the issue.

In the case when *KeywordString* is NULL, or contains multiple keywords, or when **EFI\_NOT\_FOUND** is generated while processing the keyword elements, the *Results* string contains values returned for all keywords processed prior to the keyword generating the error but no values for the keyword with error or any following keywords.

## Status Codes Returned

EFI_SUCCESS	The specified action was completed successfully.
EFI_INVALID_PARAMETER	One or more of the following are <b>TRUE</b> : <i>Progress</i> , <i>ProgressErr</i> , or <i>Results</i> is <b>NULL</b> . Parsing of the <i>KeywordString</i> resulted in an error. See <i>Progress</i> and <i>ProgressErr</i> for more data.
EFI_NOT_FOUND	An element of the <i>KeywordString</i> was not found. See <i>ProgressErr</i> for more data.
EFI_NOT_FOUND	The <i>Namespaceld</i> specified was not found. See <i>ProgressErr</i> for more data.
EFI_OUT_OF_RESOURCES	Required system resources could not be allocated. See <i>ProgressErr</i> for more data.
EFI_ACCESS_DENIED	The action violated system policy. See <i>ProgressErr</i> for more data.
EFI_DEVICE_ERROR	An unexpected system error occurred. See <i>ProgressErr</i> for more data.

## 34.4 EFI HII Configuration Routing Protocol

### EFI\_HII\_CONFIG\_ROUTING\_PROTOCOL

#### Summary

The EFI HII Configuration Routing Protocol manages the movement of configuration data from drivers to configuration applications. It then serves as the single point to receive configuration information from configuration applications, routing the results to the appropriate drivers.

## GUID

```
#define EFI_HII_CONFIG_ROUTING_PROTOCOL_GUID \
{ 0x587e72d7, 0xcc50, 0x4f79, \
  { 0x82, 0x09, 0xca, 0x29, 0x1f, 0xc1, 0xa1, 0x0f }}
```

## Protocol Interface Structure

```
typedef struct {
  EFI_HII_EXTRACT_CONFIG ExtractConfig;
  EFI_HII_EXPORT_CONFIG ExportConfig;
  EFI_HII_ROUTE_CONFIG RouteConfig;
  EFI_HII_BLOCK_TO_CONFIG BlockToConfig;
  EFI_HII_CONFIG_TO_BLOCK ConfigToBlock;
  EFI_HII_GET_ALT_CFG GetAltConfig;
} EFI_HII_CONFIG_ROUTING_PROTOCOL;
```

## Related Definitions

None

## Parameters

## Description

This protocol defines the configuration routing interfaces between external applications and the HII.

There may only be one instance of this protocol in the system.



## EFI\_HII\_CONFIG\_ROUTING\_PROTOCOL.ExtractConfig()

### Summary

This function allows a caller to extract the current configuration for one or more named elements from one or more drivers.

### Prototype

```
typedef
EFI_STATUS
(EFIAPI * EFI_HII_EXTRACT_CONFIG ) (
  IN CONST EFI_HII_CONFIG_ROUTING_PROTOCOL * This,
  IN CONST EFI_STRING Request,
  OUT EFI_STRING *Progress,
  OUT EFI_STRING *Results
);
```

### Parameters

#### *This*

Points to the **EFI\_HII\_CONFIG\_ROUTING\_PROTOCOL** instance.

#### *Request*

A null-terminated string in **<MultiConfigRequest>** format.

#### *Progress*

On return, points to a character in the Request string. Points to the string's null terminator if request was successful. Points to the most recent '&' before the first failing name / value pair (or the beginning of the string if the failure is in the first name / value pair) if the request was not successful

#### *Results*

A null-terminated string in **<MultiConfigAltResp>** format which has all values filled in for the names in the *Request* string.

### Description

This function allows the caller to request the current configuration for one or more named elements from one or more drivers. The resulting string is in the standard HII configuration string format. If Successful **Results** contains an equivalent string with "=" and the values associated with all names added in.

The expected implementation is for each **<ConfigRequest>** substring in the Request, call the HII Configuration Access Protocol **ExtractConfig** function for the driver corresponding to the **<ConfigHdr>** at the start of the **<ConfigRequest>** substring. The request fails if no driver matches the **<ConfigRequest>** substring.

**Note:** *Alternative configuration strings may also be appended to the end of the current configuration string. If they are, they must appear after the current configuration. They must contain the same routing (GUID, NAME, PATH) as the current configuration string. They must have an additional description indicating the type of alternative configuration the string represents,*

*"ALTCFG=<AltCfgId>". The <AltCfgId> is a reference to a Default ID which stipulates the type of Default being referenced such as **EFI\_HII\_DEFAULT\_CLASS\_STANDARD**.*

As an example, assume that the Request string is:

GUID=...&PATH=...&Fred&George&Ron&Neville

A result might be:

GUID=...&PATH=...&Fred=16&George=16&Ron=12&Neville=11&

GUID=...&PATH=...&ALTCFG=0037&Fred=12&Neville=7

## Status Codes Returned

EFI_SUCCESS	The <i>Results</i> string is filled with the values corresponding to all requested names.
EFI_OUT_OF_RESOURCES	Not enough memory to store the parts of the results that must be stored awaiting possible future protocols.
EFI_NOT_FOUND	Routing data doesn't match any known driver. Progress set to the "G" in "GUID" of the routing header that doesn't match. Note: There is no requirement that all routing data be validated before any configuration extraction.
EFI_INVALID_PARAMETER	Illegal syntax. Progress set to most recent "&" before the error or the beginning of the string.
EFI_INVALID_PARAMETER	The ExtractConfig function of the underlying HII Configuration Access Protocol returned EFI_INVALID_PARAMETER. Progress set to most recent "&" before the error or the beginning of the string.
EFI_ACCESS_DENIED	The action violated a system policy.

## EFI\_HII\_CONFIG\_ROUTING\_PROTOCOL.ExportConfig()

### Summary

This function allows the caller to request the current configuration for the entirety of the current HII database and returns the data in a null-terminated string.

### Prototype

```
typedef
EFI_STATUS
(EFIAPI * EFI_HII_EXPORT_CONFIG ) (
    IN CONST EFI_HII_CONFIG_ROUTING_PROTOCOL * This,
    OUT EFI_STRING *Results
);
```

### Parameters

*This*

Points to the **EFI\_HII\_CONFIG\_ROUTING\_PROTOCOL** instance.

*Results*

A null-terminated string in *<MultiConfigAltResp>* format which has all values filled in for the entirety of the current HII database.

### Description

This function allows the caller to request the current configuration for all of the current HII database. The results include both the current and alternate configurations as described in **ExtractConfig()** above.

**EFI\_HII\_CONFIG\_ACCESS\_PROTOCOL.ExtractConfig()** interfaces below.

### Status Codes Returned

EFI_SUCCESS	The <i>Results</i> string is filled with the values corresponding to all requested names.
EFI_OUT_OF_RESOURCES	Not enough memory to store the parts of the results that must be stored awaiting possible future protocols.
EFI_INVALID_PARAMETER	For example, passing in a NULL for the <i>Results</i> parameter would result in this type of error.

## EFI\_HII\_CONFIG\_ROUTING\_PROTOCOL.RouteConfig()

### Summary

This function processes the results of processing forms and routes it to the appropriate handlers or storage.

### Prototype

```
typedef
EFI_STATUS
(EFIAPI * EFI_HII_ROUTE_CONFIG ) (
    IN CONST EFI_HII_CONFIG_ROUTING_PROTOCOL * This,
    IN CONST EFI_STRING      Configuration,
    OUT EFI_STRING      *Progress
);
```

### Parameters

*This*

Points to the **EFI\_HII\_CONFIG\_ROUTING\_PROTOCOL** instance.

*Configuration*

A null-terminated string in *<MultiConfigResp>* format.

*Progress*

A pointer to a string filled in with the offset of the most recent '&' before the first failing name / value pair (or the beginning of the string if the failure is in the first name / value pair) or the terminating NULL if all was successful.

### Description

This function routes the results of processing forms to the appropriate targets. It scans for *<ConfigHdr>* within the string and passes the header and subsequent body to the driver whose location is described in the *<ConfigHdr>*. Many *<ConfigHdr>*s may appear as a single request.

The expected implementation is to hand off the various *<ConfigResp>* substrings to the Configuration Access Protocol **RouteConfig** routine corresponding to the driver whose routing information is defined by the *<ConfigHdr>* in turn.

### Status Codes Returned

EFI_SUCCESS	The results have been distributed or are awaiting distribution.
EFI_OUT_OF_RESOURCES	Not enough memory to store the parts of the results that must be stored awaiting possible future protocols.
EFI_INVALID_PARAMETERS	Passing in a NULL for the <i>Configuration</i> parameter would result in this type of error.

EFI\_NOT\_FOUND

Target for the specified routing data was not found

EFI\_ACCESS\_DENIED

The action violated a system policy.

## EFI\_HII\_CONFIG\_ROUTING\_PROTOCOL.BlockToConfig()

### Summary

This helper function is to be called by drivers to map configuration data stored in byte array ("block") formats such as UEFI Variables into current configuration strings.

### Prototype

```
typedef
EFI_STATUS
(EFIAPI * EFI_HII_BLOCK_TO_CONFIG) (
  IN CONST EFI_HII_CONFIG_ROUTING_PROTOCOL * This,
  IN CONST EFI_STRING      ConfigRequest,
  IN CONST UINT8           *Block,
  IN CONST UINTN           BlockSize,
  OUT EFI_STRING           *Config,
  OUT EFI_STRING           *Progress
);
```

### Parameters

*This*

Points to the **EFI\_HII\_CONFIG\_ROUTING\_PROTOCOL** instance.

*ConfigRequest*

A null-terminated string in **<ConfigRequest>** format.

*Block*

Array of bytes defining the block's configuration.

*BlockSize*

Length in bytes of **Block**.

*Config*

Filled-in configuration string. String allocated by the function. Returned only if call is successful. The null-terminated string will be in **<ConfigResp>** format

*Progress*

A pointer to a string filled in with the offset of the most recent '&' before the first failing name / value pair (or the beginning of the string if the failure is in the first name / value pair) or the terminating NULL if all was successful.

### Description

This function extracts the current configuration from a block of bytes. To do so, it requires that the *ConfigRequest* string consists of a list of **<BlockName>** formatted names. It uses the offset in the name to determine the index into the Block to start the extraction and the width of each name to determine the number of bytes to extract. These are mapped to a string using the equivalent of the C "%x" format (with optional leading spaces).

The call fails if, for any (offset, width) pair in *ConfigRequest*,  $\text{offset} + \text{value} \geq \text{BlockSize}$ .

## Status Codes Returned

EFI_SUCCESS	The request succeeded. Progress points to the null terminator at the end of the <i>ConfigRequest</i> string.
EFI_OUT_OF_RESOURCES	Not enough memory to allocate <i>Config</i> . Progress points to the first character of <i>ConfigRequest</i> .
EFI_INVALID_PARAMETERS	Passing in a NULL for the <i>ConfigRequest</i> or <b>Block</b> parameter would result in this type of error. Progress points to the first character of <i>ConfigRequest</i> .
EFI_NOT_FOUND	Target for the specified routing data was not found. <i>Progress</i> points to the "G" in "GUID" of the errant routing data.
EFI_DEVICE_ERROR	Block not large enough. <i>Progress</i> undefined.
EFI_INVALID_PARAMETER	Encountered non <BlockName> formatted string. Block is left updated and Progress points at the '&' preceding the first non-<BlockName>.

## EFI\_HII\_CONFIG\_ROUTING\_PROTOCOL.ConfigToBlock()

### Summary

This helper function is to be called by drivers to map configuration strings to configurations stored in byte array ("block") formats such as UEFI Variables.

### Prototype

```
typedef
EFI_STATUS
(EFIAPI * EFI_HII_CONFIG_TO_BLOCK) (
  IN CONST EFI_HII_CONFIG_ROUTING_PROTOCOL *This,
  IN CONST EFI_STRING      *ConfigResp,
  IN OUT CONST UINT8      *Block,
  IN OUT UINTN            *BlockSize,
  OUT EFI_STRING          *Progress
);
```

### Parameters

#### *This*

Points to the **EFI\_HII\_CONFIG\_ROUTING\_PROTOCOL** instance.

#### *ConfigResp*

A null-terminated string in *<ConfigResp>* format.

#### *Block*

A possibly null array of bytes representing the current block. Only bytes referenced in the *ConfigResp* string in the block are modified. If this parameter is null or if the *\*BlockSize* parameter is (on input) shorter than required by the **Configuration** string, only the *BlockSize* parameter is updated and an appropriate status (see below) is returned.

#### *BlockSize*

The length of the *Block* in units of UINT8. On input, this is the size of the *Block*. On output, if successful, contains the largest index of the modified byte in the *Block*, or the required buffer size if the *Block* is not large enough.

#### *Progress*

On return, points to an element of the *ConfigResp* string filled in with the offset of the most recent '&' before the first failing name / value pair (or the beginning of the string if the failure is in the first name / value pair) or the terminating NULL if all was successful.

### Description

This function maps a configuration containing a series of *<BlockConfig>* formatted name value pairs in *ConfigResp* into a *Block* so it may be stored in a linear mapped storage such as a UEFI Variable. If present, the function skips **GUID**, **NAME**, and **PATH** in *<ConfigResp>*.



It stops when it finds a non-*<BlockConfig>* name / value pair (after skipping the routing header) or when it reaches the end of the string.

Example

Assume an existing block containing:

**00 01 02 03 04 05**

And the *ConfigResp* string is:

**OFFSET=3WIDTH=1&VALUE=7&OFFSET=0&WIDTH=2&VALUE=AA55**

The results are

**55 AA 02 07 04 05**

## Status Codes Returned

EFI_SUCCESS	The request succeeded. Progress points to the null terminator at the end of the <i>ConfigResp</i> string.
EFI_OUT_OF_RESOURCES	Not enough memory to allocate <i>Config</i> . Progress points to the first character of <i>ConfigResp</i> .
EFI_INVALID_PARAMETER	Passing in a NULL for the <i>ConfigResp</i> or <i>Block</i> parameter would result in this type of error. Progress points to the first character of <i>ConfigResp</i> .
EFI_NOT_FOUND	Target for the specified routing data was not found. <i>Progress</i> points to the "G" in "GUID" of the errant routing data.
EFI_BUFFER_TOO_SMALL	Block not large enough. <i>Progress</i> undefined. <i>BlockSize</i> is updated with the required buffer size.
EFI_INVALID_PARAMETER	Encountered non <i>&lt;BlockName&gt;</i> formatted name / value pair. <i>Block</i> is left updated and <i>Progress</i> points at the '&' preceding the first non- <i>&lt;BlockName&gt;</i> .

## EFI\_HII\_CONFIG\_ROUTING\_PROTOCOL.GetAltCfg()

### Summary

This helper function is to be called by drivers to extract portions of a larger configuration string.

### Prototype

```
typedef
EFI_STATUS
(EFIAPI * EFI_HII_GET_ALT_CFG ) (
  IN CONST EFI_HII_CONFIG_ROUTING_PROTOCOL *This,
  IN CONST EFI_STRING      ConfigResp,
  IN CONST EFI_GUID       *Guid,
  IN CONST EFI_STRING      Name,
  IN CONST EFI_DEVICE_PATH_PROTOCOL *DevicePath,
  IN CONST EFI_STRING      AltCfgId,
  OUT EFI_STRING          *AltCfgResp
);
```

### Parameters

#### *This*

Points to the **EFI\_HII\_CONFIG\_ROUTING\_PROTOCOL** instance.

#### *ConfigResp*

A null-terminated string in **<ConfigAltResp>** format.

#### *Guid*

A pointer to the GUID value to search for in the routing portion of the *ConfigResp* string when retrieving the requested data. If *Guid* is NULL, then all GUID values will be searched for.

#### *Name*

A pointer to the NAME value to search for in the routing portion of the *ConfigResp* string when retrieving the requested data. If *Name* is NULL, then all *Name* values will be searched for.

#### *DevicePath*

A pointer to the PATH value to search for in the routing portion of the *ConfigResp* string when retrieving the requested data. If *DevicePath* is NULL, then all *DevicePath* values will be searched for.

#### *AltCfgId*

A pointer to the ALTCFG value to search for in the routing portion of the *ConfigResp* string when retrieving the requested data. If this parameter is NULL, then the current setting will be retrieved.

*AltCfgResp*

A pointer to a buffer which will be allocated by the function which contains the retrieved string as requested. This buffer is only allocated if the call was successful. The null-terminated string will be in **<ConfigResp>** format.

**Description**

This function retrieves the requested portion of the configuration string from a larger configuration string. This function will use the *Guid*, *Name*, and *DevicePath* parameters to find the appropriate section of the *ConfigResp* string. Upon finding this portion of the string, it will use the *AltCfgId* parameter to find the appropriate instance of data in the *ConfigResp* string. Once found, the found data will be copied to a buffer which is allocated by the function so that it can be returned to the caller. The caller is responsible for freeing this allocated buffer.

**Status Codes Returned**

EFI_SUCCESS	The request succeeded. The requested data was extracted and placed in the newly allocated <i>AltCfgResp</i> buffer.
EFI_OUT_OF_RESOURCES	Not enough memory to allocate <i>AltCfgResp</i> .
EFI_INVALID_PARAMETER	Passing in a NULL for the <i>ConfigResp</i> or <i>AltCfgResp</i> would result in this type of error.

## 34.5 EFI HII Configuration Access Protocol

### EFI\_HII\_CONFIG\_ACCESS\_PROTOCOL

**Summary**

The EFI HII configuration routing protocol invokes this type of protocol when it needs to forward requests to a driver's configuration handler. This protocol is published by drivers providing and receiving configuration data from HII. The **ExtractConfig()** and **RouteConfig()** functions are typically invoked by the driver which implements the HII Configuration Routing Protocol. The **Callback()** function is typically invoked by the Forms Browser.

If the protocol functions modify active form set, they must not change layout and size of the existing variable stores. The forms browser processes updated IFR package in accordance with the following rules:

1. If active form set no longer exists, the behavior is browser specific. The browser identifies form set using a combination of the form set GUID and device path associated with the package list containing the form set.
2. If form set update has been initiated by the **Callback()** function, the browser executes action requested by the function. See **EFI\_HII\_CONFIG\_ACCESS\_PROTOCOL.Callback()** section for additional details regarding browser action requests.

**Note:** *If browser action implies saving of the modified questions values, the browser will use uncommitted data associated with the old form set instance. The HII Configuration Access implementation is responsible for properly handling such requests.*

3. The browser performs standard processing steps that are performed on a form set prior to displaying it (including reading question values and generating **EFI\_BROWSER\_ACTION\_FORM\_OPEN** and **EFI\_BROWSER\_ACTION\_FORM\_RETRIEVE** callbacks).
4. If there is an uncommitted browser data associated with an active form set, the browser applies it, matching variable stores by their identifiers. If variable store no longer exists, the uncommitted data for this store is discarded.

**Note:** *Changing layout or size of the existing variable stores during form set update is not allowed and can lead to unpredictable results.*

5. The browser applies prior browsing history, matching forms by their identifiers. If a form saved in the browsing history no longer exists, the behavior is browser-specific.
6. If all forms in the browsing history have been matched, the browser sets selection on a question that was active prior to the form set update, matching question by its identifier. If question does not exist, the first question on the form is selected.

## GUID

```
#define EFI_HII_CONFIG_ACCESS_PROTOCOL_GUID \
{ 0x330d4706, 0xf2a0, 0x4e4f, \
  {0xa3,0x69, 0xb6, 0x6f,0xa8, 0xd5, 0x43, 0x85}}
```

## Protocol Interface Structure

```
typedef struct {
  EFI_HII_ACCESS_EXTRACT_CONFIG  ExtractConfig;
  EFI_HII_ACCESS_ROUTE_CONFIG    RouteConfig;
  EFI_HII_ACCESS_FORM_CALLBACK   Callback;
} EFI_HII_CONFIG_ACCESS_PROTOCOL;
```

## Related Definitions

None

## Parameters

### *ExtractConfig*

This function breaks apart the request strings routing them to the appropriate drivers. This function is analogous to the similarly named function in the HII Routing Protocol.

### *RouteConfig*

This function breaks apart the results strings and returns configuration information as specified by the request.

*Callback*

This function is called from the configuration browser to communicate certain activities that were initiated by a user.

**Description**

This protocol provides a callable interface between the HII and drivers. Only drivers which provide IFR data to HII are required to publish this protocol.

## EFI\_HII\_CONFIG\_ACCESS\_PROTOCOL.ExtractConfig()

### Summary

This function allows a caller to extract the current configuration for one or more named elements from the target driver.

### Prototype

```
typedef
EFI_STATUS
(EFIAPI * EFI_HII_CONFIG_ACCESS_EXTRACT_CONFIG) (
  IN CONST EFI_HII_CONFIG_ACCESS_PROTOCOL *This,
  IN CONST EFI_STRING Request,
  OUT EFI_STRING *Progress,
  OUT EFI_STRING *Results
);
```

### Parameters

*This*

Points to the **EFI\_HII\_CONFIG\_ACCESS\_PROTOCOL**.

*Request*

A null-terminated string in **<ConfigRequest>** format. Note that this includes the routing information as well as the configurable name / value pairs. It is invalid for this string to be in **<MultiConfigRequest>** format.

If a **NULL** is passed in for the *Request* field, all of the settings being abstracted by this function will be returned in the *Results* field. In addition, if a *ConfigHdr* is passed in with no request elements, all of the settings being abstracted for that particular *ConfigHdr* reference will be returned in the *Results* Field.

*Progress*

On return, points to a character in the *Request* string. Points to the string's null terminator if request was successful. Points to the most recent '&' before the first failing name / value pair (or the beginning of the string if the failure is in the first name / value pair) if the request was not successful

*Results*

A null-terminated string in **<MultiConfigAltResp>** format which has all values filled in for the names in the *Request* string. String to be allocated by the called function.

### Description

This function allows the caller to request the current configuration for one or more named elements. The resulting string is in **<ConfigAltResp>** format.

In order to support forms processors other than a Forms Browser, the configuration returned by this function must not depend on context in which the function is used. In

particular, it must not depend on the current state of the Forms Browser (including any uncommitted state information) and actions performed by the driver callbacks invoked prior to the ExtractConfig call. [Section 32.2.1.8](#) provides additional details regarding forms browser/processor.

Any and all alternative configuration strings shall also be appended to the end of the current configuration string. If they are, they must appear after the current configuration. They must contain the same routing (GUID, NAME, PATH) as the current configuration string. They must have an additional description indicating the type of alternative configuration the string represents, "**ALTCFG=<AltCfgId>**". The **<AltCfgId>** is a reference to a Default ID which stipulates the type of Default being referenced such as **EFI\_HII\_DEFAULT\_CLASS\_STANDARD**.

As an example, assume that the Request string is:

**GUID=...&PATH=...&Fred&George&Ron&Neville**

A result might be:

**GUID=...&PATH=...&Fred=16&George=16&Ron=12&Neville=11&GUID=...&PATH=...  
&ALTCFG=0037&Fred=12&Neville=7**

This function allows the caller to request the current configuration for one or more named elements. The resulting string is in **<ConfigAltResp>** format.

Any and all alternative configuration strings shall also be appended to the end of the current configuration string. If they are, they must appear after the current configuration. They must contain the same routing (GUID, NAME, PATH) as the current configuration string. They must have an additional description indicating the type of alternative configuration the string represents, "**ALTCFG=<AltCfgId>**". The **<AltCfgId>** is a reference to a Default ID which stipulates the type of Default being referenced such as **EFI\_HII\_DEFAULT\_CLASS\_STANDARD**.

As an example, assume that the *Request* string is:

**GUID=...&PATH=...&Fred&George&Ron&Neville**

A result might be:

**GUID=...&PATH=...&Fred=16&George=16&Ron=12&Neville=11&  
GUID=...&PATH=...&ALTCFG=0037&Fred=12&Neville=7**

## Status Codes Returned

EFI_SUCCESS	The <i>Results</i> string is filled with the values corresponding to all requested names.
EFI_OUT_OF_RESOURCES	Not enough memory to store the parts of the results that must be stored awaiting possible future protocols.
EFI_NOT_FOUND	A configuration element matching the routing data is not found. Progress set to the first character in the routing header.
EFI_INVALID_PARAMETER	Illegal syntax. Progress set to most recent "&" before the error or the beginning of the string.

EFI_INVALID_PARAMETER	Unknown name. <i>Progress</i> points to the "&" before the name in question.
EFI_INVALID_PARAMETER	If Results or Progress is NULL.
EFI_ACCESS_DENIED	The action violated a system policy.



## EFI\_HII\_CONFIG\_ACCESS\_PROTOCOL.RouteConfig()

### Summary

This function processes the results of changes in configuration for the driver that published this protocol.

### Prototype

```
typedef
EFI_STATUS
(EFI_API * EFI_HII_ACCESS_ROUTE_CONFIG) (
  IN CONST EFI_HII_CONFIG_ACCESS_PROTOCOL *This,
  IN CONST EFI_STRING Configuration,
  OUT EFI_STRING *Progress
);
```

### Parameters

*This*

Points to the **EFI\_HII\_CONFIG\_ACCESS\_PROTOCOL**.

*Configuration*

A null-terminated string in *<ConfigResp>* format.

*Progress*

a pointer to a string filled in with the offset of the most recent '&' before the first failing name / value pair (or the beginning of the string if the failure is in the first name / value pair) or the terminating NULL if all was successful.

### Description

This function applies changes in a driver's configuration. Input is a *Configuration*, which has the routing data for this driver followed by name / value configuration pairs. The driver must apply those pairs to its configurable storage.

In order to support forms processors other than a Forms Browser, the way in which configuration data is applied must not depend on context in which the function is used. In particular, it must not depend on the current state of the Forms Browser (including any uncommitted state information) and actions performed by the driver callbacks invoked prior to the **RouteConfig** call. [Section 32.2.1.8](#) provides additional details regarding forms browser/processor.

If the driver's configuration is stored in a linear block of data and the driver's name / value pairs are in **<BlockConfig>** format, it may use the **ConfigToBlock** helper function (above) to simplify the job.

### Status Codes Returned

EFI\_SUCCESS

The results have been distributed or are awaiting distribution.

EFI_OUT_OF_RESOURCES	Not enough memory to store the parts of the results that must be stored awaiting possible future protocols.
EFI_INVALID_PARAMETER	If Configuration or Progress is NULL.
EFI_NOT_FOUND	Target for the specified routing data was not found
EFI_ACCESS_DENIED	The action violated a system policy.

## EFI\_HII\_CONFIG\_ACCESS\_PROTOCOL.CallBack()

### Summary

This function is called to provide results data to the driver.

### Prototype

```
typedef
EFI_STATUS
(EFI_API *EFI_HII_ACCESS_FORM_CALLBACK) (
  IN CONST EFI_HII_CONFIG_ACCESS_PROTOCOL *This,
  IN EFI_BROWSER_ACTION Action,
  IN EFI_QUESTION_ID QuestionId,
  IN UINT8 Type,
  IN OUT EFI_IFR_TYPE_VALUE *Value,
  OUT EFI_BROWSER_ACTION_REQUEST *ActionRequest,
);
```

### Parameters

*This*

Points to the **EFI\_HII\_CONFIG\_ACCESS\_PROTOCOL**.

*Action*

Specifies the type of action taken by the browser. See **EFI\_BROWSER\_ACTION\_x** in “Related Definitions” below.

*QuestionId*

A unique value which is sent to the original exporting driver so that it can identify the type of data to expect. The format of the data tends to vary based on the opcode that generated the callback.

*Type*

The type of value for the question. See **EFI\_IFR\_TYPE\_x** in **EFI\_IFR\_ONE\_OF\_OPTION**.

*Value*

A pointer to the data being sent to the original exporting driver. The type is specified by *Type*. Type **EFI\_IFR\_TYPE\_VALUE** is defined in **EFI\_IFR\_ONE\_OF\_OPTION**.

*ActionRequest*

On return, points to the action requested by the callback function. Type **EFI\_BROWSER\_ACTION\_REQUEST** is specified in **SendForm()** in the Form Browser Protocol.

### Description

This function is called by the forms browser in response to a user action on a question which has the **EFI\_IFR\_FLAG\_CALLBACK** bit set in the **EFI\_IFR\_QUESTION\_HEADER**. The

user action is specified by *Action*. Depending on the action, the browser may also pass the question value using *Type* and *Value*. Upon return, the callback function may specify the desired browser action.

The browser maintains uncommitted browser data (modified and unsaved question values) across Callback function boundaries. Callback function may change unsaved question values using one of the following methods:

- Current question's value may be changed by updating the *Value* parameter.
- Values of other questions from the active formset can be changed using **EFI\_FORM\_BROWSER2\_PROTOCOL.BrowserCallback()** interface.

**Note:** *Modification of the question values by the Callback function without notifying the browser using one of the above mentioned methods can lead to unpredictable browser behavior.*

Callback function may request configuration update from the browser by returning an appropriate *ActionRequest*.

In order to save uncommitted data, driver should return one of the **\_SUBMIT** actions or **\_APPLY** action. The browser will then write all modified question values (in case of the **\_SUBMIT** actions) or modified question values from an active form (in case of the **\_APPLY** action) to storage using **RouteConfig()** function. This will include questions modified prior to an invocation of the **Callback()** function as well as questions modified by the **Callback()** function.

The behavior of the **ExtractConfig** and **RouteConfig** functions must not depend on the actions performed by this function.

Callback functions should return **EFI\_UNSUPPORTED** for all values of *Action* that they do not support.

## Related Definitions

```
typedef UINTN EFI_BROWSER_ACTION;

#define EFI_BROWSER_ACTION_CHANGING    0
#define EFI_BROWSER_ACTION_CHANGED    1
#define EFI_BROWSER_ACTION_RETRIEVE    2
#define EFI_BROWSER_ACTION_FORM_OPEN  3
#define EFI_BROWSER_ACTION_FORM_CLOSE 4
#define EFI_BROWSER_ACTION_SUBMITTED   5
#define EFI_BROWSER_ACTION_DEFAULT_STANDARD 0x1000
#define EFI_BROWSER_ACTION_DEFAULT_MANUFACTURING 0x1001
#define EFI_BROWSER_ACTION_DEFAULT_SAFE 0x1002
#define EFI_BROWSER_ACTION_DEFAULT_PLATFORM 0x2000
#define EFI_BROWSER_ACTION_DEFAULT_HARDWARE 0x3000
#define EFI_BROWSER_ACTION_DEFAULT_FIRMWARE 0x4000
```

The following table describes the behavior of the callback for each question type.

Table 219. Callback Behavior

Question Type	Type	Action
Action Button	<b>EFI_IFR_TYPE_ACTION</b>	No special behavior. If the short form of the opcode is used, then the value will be a string identifier of zero.
Checkbox	<b>EFI_IFR_TYPE_BOOLEAN</b>	No special behavior
Cross-Reference	<b>EFI_IFR_TYPE_REF</b> <b>EFI_IFR_TYPE_UNDEFINED</b>	CHANGING: If <b>EFI_UNSUPPORTED</b> or <b>EFI_SUCCESS</b> , the updated cross-reference is taken. Any other error the cross-reference will not be taken. CHANGED: Never called. RETRIEVE: Called before displaying the cross-reference. Error codes ignored. The Ref field of the Value parameter is initialized with the REF question's value prior to CHANGING and RETRIEVE.
Date	<b>EFI_IFR_TYPE_DATE</b>	No special behavior
Numeric, One-Of	<b>EFI_IFR_TYPE_NUM_SIZE_8,</b> <b>EFI_IFR_TYPE_NUM_SIZE_16,</b> <b>EFI_IFR_TYPE_NUM_SIZE_32,</b> <b>EFI_IFR_TYPE_NUM_SIZE_64</b>	No special behavior.
Ordered-List	<b>EFI_IFR_TYPE_BUFFER</b>	No special behavior
String, Password	<b>EFI_IFR_TYPE_STRING</b>	No special behavior.
Time	<b>EFI_IFR_TYPE_DATE</b>	No special behavior.

The value **EFI\_BROWSER\_ACTION\_CHANGING** is called before the browser changes the value in the display (for questions which have a value) or takes an action (in the case of an action button or cross-reference). If the callback returns **EFI\_UNSUPPORTED**, then the browser will use the value passed to **Callback()** and ignore the value returned by **Callback()**. If the callback returns **EFI\_SUCCESS**, then the browser will use the value returned by **Callback()**. If any other error is returned, then the browser will not update the current question value. *ActionRequest* is ignored. The *Value* represents the updated value. The changes here should not be finalized until the user submits the results.

The value **EFI\_BROWSER\_ACTION\_CHANGED** is called after the browser has changed its internal copy of the question value and displayed it (if appropriate). For action buttons, this is called after the value has been processed. For cross-references, this is never called. Errors returned are ignored. *ActionRequest* is used. The changes here should not be finalized until the user submits the results.

The value **EFI\_BROWSER\_ACTION\_RETRIEVE** is called after the browser has read the current question value, but before it has been displayed. If the callback returns **EFI\_UNSUPPORTED** or any other error then the original value is used. If **EFI\_SUCCESS** is returned, then the updated value is used.

The value **EFI\_BROWSER\_ACTION\_FORM\_OPEN** is called for each question on a form prior to its value being retrieved or displayed. If a question appears on more than one

form, and the Forms Browser supports more than one form being active simultaneously, this may be called more than once, even prior to any **EFI\_BROWSER\_ACTION\_FORM\_CLOSE** callback."

The value **EFI\_BROWSER\_ACTION\_FORM\_CLOSE** is called for each question on a form after the processing of any submit actions for that form. If a question appears on more than one form, and the Forms Processor supports more than one form being active simultaneously, this will be called more than once.

The value **EFI\_BROWSER\_ACTION\_SUBMITTED** is called after Browser submits the modified question value. *ActionRequest* is ignored.

When *Action* specifies one of the "default" actions, such as **EFI\_BROWSER\_ACTION\_DEFAULT\_STANDARD**, etc. it indicates that the Forms Processor is attempting to retrieve the default value for the specified question. The proposed default value is passed in using *Type* and *Value* and reflects the value which the Forms Processor was able to select based on the lower-priority defaulting methods (see [Section 32.2.5.8](#)). If the function returns **EFI\_SUCCESS**, then the updated value will be used. If the function does not have an updated default value for the specified question or specified default store, or does not provide any support for the actions, it should return **EFI\_UNSUPPORTED**, and the returned value will be ignored.

The **DEFAULT\_PLATFORM**, **DEFAULT\_HARDWARE** and **DEFAULT\_FIRMWARE** represent ranges of 4096 (0x1000) possible default store identifiers. The **DEFAULT\_STANDARD** represents the range of 4096 possible action values reserved for UEFI-defined default store identifiers. See [Section 32.2.5.8](#) for more information on defaults.

```
typedef UINTN EFI_BROWSER_ACTION_REQUEST;
```

```
#define EFI_BROWSER_ACTION_REQUEST_NONE 0
#define EFI_BROWSER_ACTION_REQUEST_RESET 1
#define EFI_BROWSER_ACTION_REQUEST_SUBMIT 2
#define EFI_BROWSER_ACTION_REQUEST_EXIT 3
#define EFI_BROWSER_ACTION_REQUEST_FORM_SUBMIT_EXIT 4
#define EFI_BROWSER_ACTION_REQUEST_FORM_DISCARD_EXIT 5
#define EFI_BROWSER_ACTION_REQUEST_FORM_APPLY 6
#define EFI_BROWSER_ACTION_REQUEST_FORM_DISCARD 7
#define EFI_BROWSER_ACTION_REQUEST_RECONNECT 8
```

If the callback function returns with the *ActionRequest* set to **\_NONE**, then the Forms Browser will take no special behavior.

If the callback function returns with the *ActionRequest* set to **\_RESET**, then the Forms Browser will exit and request the platform to reset.

If the callback function returns with the *ActionRequest* set to **\_SUBMIT**, then the Forms Browser will save all modified question values to storage and exit.

If the callback function returns with the *ActionRequest* set to **\_EXIT**, then the Forms Browser will discard all modified question values and exit.

If the callback function returns with the *ActionRequest* set to **\_FORM\_SUBMIT\_EXIT**, then the Forms Browser will write all modified question values on the selected form to storage and then exit the selected form.

If the callback function returns with the *ActionRequest* set to `_FORM_DISCARD_EXIT`, then the Forms Browser will discard the modified question values on the selected form and then exit the selected form.

If the callback function returns with the *ActionRequest* set to `_FORM_APPLY`, then the Forms Browser will write all modified current question values on the selected form to storage.

If the callback function returns with the *ActionRequest* set to `_FORM_DISCARD`, then the Forms Browser will discard the current question values on the selected form and replace them with the original question values.

If the callback function returns with the *ActionRequest* set to `_RECONNECT`, a hardware and/or software configuration change was performed by the user, and the controller needs to be reconnected for the driver to recognize the change. The Forms Browser is required to call the EFI Boot Service `DisconnectController()` followed by the EFI Boot Service `ConnectController()` to reconnect the controller, and then exit. The controller handle passed to `DisconnectController()` and `ConnectController()` is the handle on which this `EFI_HII_CONFIG_ACCESS_PROTOCOL` is installed.

## Status Codes Returned

<code>EFI_SUCCESS</code>	The callback successfully handled the action.
<code>EFI_OUT_OF_RESOURCES</code>	Not enough storage is available to hold the variable and its data.
<code>EFI_DEVICE_ERROR</code>	The variable could not be saved.
<code>EFI_UNSUPPORTED</code>	The specified Action is not supported by the callback.

## 34.6 Form Browser Protocol

The `EFI_FORM_BROWSER2_PROTOCOL` is the interface to call for drivers to leverage the EFI configuration driver interface.

### EFI\_FORM\_BROWSER2\_PROTOCOL

#### Summary

The `EFI_FORM_BROWSER2_PROTOCOL` is the interface to the UEFI configuration driver. This interface will allow the caller to direct the configuration driver to use either the HII database or use the passed-in packet of data.

## GUID

```
#define EFI_FORM_BROWSER2_PROTOCOL_GUID \
{ 0xb9d4c360, 0xbcfb, 0x4f9b, \
  { 0x92, 0x98, 0x53, 0xc1, 0x36, 0x98, 0x22, 0x58 } }
```

## Protocol Interface Structure

```
typedef struct _EFI_FORM_BROWSER2_PROTOCOL {
  EFI_SEND_FORM2      SendForm;
  EFI_BROWSER_CALLBACK2 BrowserCallback;
} EFI_FORM_BROWSER2_PROTOCOL;
```

## Parameters

### *SendForm*

Browse the specified configuration forms. See the **SendForm()** function description.

### *BrowserCallback*

Routine used to expose internal configuration state of the browser. This is primarily used by callback handler routines which were called by the browser and in-turn need to get additional information from the browser itself. See the **BrowserCallback()** function description.

## Description

This protocol is the interface to call for drivers to leverage the EFI configuration driver interface.



## EFI\_FORM\_BROWSER2\_PROTOCOL.SendForm()

### Summary

Initialize the browser to display the specified configuration forms.

### Prototype

```
typedef
EFI_STATUS
(EFIAPI *EFI_SEND_FORM2) (
  IN CONST EFI_FORM_BROWSER2_PROTOCOL *This,
  IN EFI_HII_HANDLE *Handles,
  IN UINTN HandleCount,
  IN CONST EFI_GUID *FormsetGuid, OPTIONAL
  IN EFI_FORM_ID FormId, OPTIONAL
  IN CONST EFI_SCREEN_DESCRIPTOR *ScreenDimensions, OPTIONAL
  OUT EFI_BROWSER_ACTION_REQUEST *ActionRequest OPTIONAL
);
```

### Parameters

#### *This*

A pointer to the **EFI\_FORM\_BROWSER2\_PROTOCOL** instance.

#### *Handles*

A pointer to an array of HII handles to display. This value should correspond to the value of the HII form package that is required to be displayed. Type **EFI\_HII\_HANDLE** is defined in **EFI\_HII\_DATABASE\_PROTOCOL.NewPackageList()** in [Section 32.3.1](#).

#### *HandleCount*

The number of handles in the array specified by *Handle*.

#### *FormsetGuid*

This field points to the **EFI\_GUID** which must match the *Guid* field or one of the elements of the *ClassId* field in the **EFI\_IFR\_FORM\_SET** op-code. If *FormsetGuid* is **NULL**, then this function will display the form set class **EFI\_HII\_PLATFORM\_SETUP\_FORMSET\_GUID**.

#### *FormId*

This field specifies the identifier of the form within the form set to render as the first displayable page. If this field has a value of 0x0000, then the Forms Browser will render the first enabled form in the form set.

#### *ScreenDimensions*

Points to recommended form dimensions, including any non-content area, in characters. Type **EFI\_SCREEN\_DESCRIPTOR** is defined in "Related Definitions" below.

*ActionRequested*

Points to the action recommended by the form.

**Description**

This function is the primary interface to the Forms Browser. The Forms Browser displays the forms specified by *FormsetGuid* and *FormId* from all of HII handles specified by *Handles*. If more than one form can be displayed, the Forms Browser will provide some means for the user to navigate between the forms in addition to that provided by cross-references in the forms themselves.

If *ScreenDimensions* is non-NULL, then it points to a recommended display size for the form. If browsing in text mode, then these are recommended character positions. If browsing in graphics mode, then these values are converted to pixel locations using the standard font size (8 pixels per horizontal character cell and 19 pixels per vertical character cell). If *ScreenDimensions* is **NULL** the browser may choose the size based on platform policy. The browser may choose to ignore the size based on platform policy.

If *ActionRequested* is non-NULL, then upon return, it points to an enumerated value (see **EFI\_BROWSER\_ACTION\_x** in "Related Definitions" below) which describes the action requested by the user. If set to **EFI\_BROWSER\_ACTION\_NONE**, then no specific action was requested by the form. If set to **EFI\_BROWSER\_ACTION\_RESET**, then the form requested that the platform be reset. The browser may, based on platform policy, ignore such action requests.

If *FormsetGuid* is set to **EFI\_HII\_PLATFORM\_SETUP\_FORMSET\_GUID**, it indicates that the form set contains forms designed to be used for platform configuration. If *FormsetGuid* is set to **EFI\_HII\_DRIVER\_HEALTH\_FORMSET\_GUID**, it indicates that the form set contains forms designed to be used for support of the Driver Health Protocol (see [Section 11.10](#)). If *FormsetGuid* is set to **EFI\_HII\_USER\_CREDENTIAL\_FORMSET\_GUID**, it indicates that the form set contains forms designed to be used for support of the User Credential Protocol (see [Section 35.3.2](#)) Other values may be used for other applications.

**Related Definitions**

```

//*****
// EFI_SCREEN_DESCRIPTOR
//*****
typedef struct {
    UINTN    LeftColumn;
    UINTN    RightColumn;
    UINTN    TopRow;
    UINTN    BottomRow;
} EFI_SCREEN_DESCRIPTOR;

```

*LeftColumn*

Value that designates the text column where the browser window will begin from the left-hand side of the screen

*RightColumn*

Value that designates the text column where the browser window will end on the right-hand side of the screen.

*TopRow*

Value that designates the text row from the top of the screen where the browser window will start.

*BottomRow*

Value that designates the text row from the bottom of the screen where the browser window will end.

```
typedef UINTN EFI_BROWSER_ACTION_REQUEST;
```

```
#define EFI_BROWSER_ACTION_REQUEST_NONE 0
```

```
#define EFI_BROWSER_ACTION_REQUEST_RESET 1
```

```
#define EFI_BROWSER_ACTION_REQUEST_SUBMIT 2
```

```
#define EFI_BROWSER_ACTION_REQUEST_EXIT 3
```

The value **EFI\_BROWSER\_ACTION\_REQUEST\_NONE** indicates that no specific caller action is required. The value **EFI\_BROWSER\_ACTION\_REQUEST\_RESET** indicates that the caller requested a platform reset. The value **EFI\_BROWSER\_ACTION\_REQUEST\_SUBMIT** indicates that a callback requested that the browser submit all values and exit. The value **EFI\_BROWSER\_ACTION\_REQUEST\_EXIT** indicates that a callback requested that the browser exit without saving all values.

```
#define EFI_HII_PLATFORM_SETUP_FORMSET_GUID \  
{ 0x93039971, 0x8545, 0x4b04, \  
{ 0xb4, 0x5e, 0x32, 0xeb, 0x83, 0x26, 0x04, 0x0e } }
```

```
#define EFI_HII_DRIVER_HEALTH_FORMSET_GUID \  
{ 0xf22fc20c, 0x8cf4, 0x45eb, \  
{ 0x8e, 0x06, 0xad, 0x4e, 0x50, 0xb9, 0x5d, 0xd3 } }
```

```
#define EFI_HII_USER_CREDENTIAL_FORMSET_GUID \  
{ 0x337f4407, 0x5aee, 0x4b83, \  
{ 0xb2, 0xa7, 0x4e, 0xad, 0xca, 0x30, 0x88, 0xcd } }
```

## Status Codes Returned

EFI_SUCCESS	The function completed successfully
EFI_NOT_FOUND	No valid forms could be found to display.
EFI_INVALID_PARAMETER	One of the parameters has an invalid value.

## EFI\_FORM\_BROWSER2\_PROTOCOL.BrowserCallback()

### Summary

This function is called by a callback handler to retrieve uncommitted state data from the browser.

### Prototype

```

EFI_STATUS
(EFIAPI *EFI_BROWSER_CALLBACK2) (
IN CONST EFI_FORM_BROWSER2_PROTOCOL *This,
IN OUT UINTN *ResultsDataSize,
IN OUT EFI_STRING ResultsData,
IN BOOLEAN RetrieveData,
IN CONST EFI_GUID *VariableGuid, OPTIONAL
IN CONST CHAR16 *VariableName OPTIONAL
);

```

### Parameters

#### *This*

A pointer to the **EFI\_FORM\_BROWSER2\_PROTOCOL** instance.

#### *ResultsDataSize*

A pointer to the size of the buffer associated with ResultsData. On input, the size in bytes of *ResultsData*. On output, the size of data returned in *ResultsData*.

#### *ResultsData*

A string returned from an IFR browser or equivalent. The results string will have no routing information in them.

#### *RetrieveData*

A BOOLEAN field which allows an agent to retrieve (if RetrieveData = TRUE) data from the uncommitted browser state information or set (if RetrieveData = FALSE) data in the uncommitted browser state information.

#### *VariableGuid*

An optional field to indicate the target variable GUID name to use.

#### *VariableName*

An optional field to indicate the target human-readable variable name.

### Description

This service is typically called by a driver's callback routine which was in turn called by the browser. The routine called this service in the browser to retrieve or set certain uncommitted state information that resides in the open formsets.

## Status Codes Returned

EFI_SUCCESS	The results have been distributed or are awaiting distribution.
EFI_BUFFER_TOO_SMALL	The <i>ResultsDataSize</i> specified was too small to contain the results data.

## 34.7 HII Popup Protocol

### EFI\_HII\_POPUP\_PROTOCOL

#### Summary

This protocol provides services to display a popup window.

The protocol is typically produced by the forms browser and consumed by a driver's callback handler.

#### GUID

```
#define EFI_HII_POPUP_PROTOCOL_GUID \
{ 0x4311edc0, 0x6054, 0x46d4, { 0x9e, 0x40, 0x89, 0x3e, 0xa9, 0x52, 0xfc, 0xcc } }
```

#### Protocol Interface Structure

```
typedef struct {
    UINT64      Revision;
    EFI_HII_CREATE_POPUP CreatePopup;
} EFI_HII_POPUP_PROTOCOL;
```

#### Parameters

*Revision*

Protocol revision

*CreatePopup*

Displays a popup window

#### Related Definitions

```
#define EFI_HII_POPUP_PROTOCOL_REVISION 1
```

### EFI\_HII\_POPUP\_PROTOCOL.CreatePopup()

#### Summary

Displays a popup window.

## Prototype

```
typedef
EFI_STATUS
(EFI_API * EFI_HII_CREATE_POPUP) (
  IN EFI_HII_POPUP_PROTOCOL *This,
  IN EFI_HII_POPUP_STYLE   PopupStyle,
  IN EFI_HII_POPUP_TYPE    PopupType,
  EFI_HII_HANDLE           HiiHandle
  IN EFI_STRING_ID         Message,
  OUT EFI_HII_POPUP_SELECTION *UserSelection OPTIONAL,
);
```

## Parameters

### *This*

A pointer to the **EFI\_HII\_POPUP\_PROTOCOL** instance.

### *PopupStyle*

Popup style to use. **EFI\_HII\_POPUP\_STYLE** is defined in the “Related Definitions” below.

### *PopupType*

Type of the popup to display. **EFI\_HII\_POPUP\_TYPE** is defined in the “Related Definitions” below.

### *HiiHandle*

HII handle of the string pack containing *Message*

### *Message*

A message to display in the popup box.

### *UserSelection*

User selection. **EFI\_HII\_POPUP\_SELECTION** is defined in the “Related Definitions” below.

## Description

The *CreatePopup()* function displays a modal message box that contains string specified by *Message*. Explicit line break characters can be used to specify a multi-line message (see [Section 32.2.6.2.4](#)). A popup window may contain user selectable options. The option selected by a user is returned via an optional *UserSelection* parameter.

A list of options presented to a user is defined by the *PopupType*.

The *PopupStyle* provides a hint to protocol implementation regarding nature of the message being displayed. The function may optionally use *PopupStyle* to customize visual appearance of the message box.

EfiHiiPopupTypeOk is a simple popup window with a single user selectable option that can be used to acknowledge the message. If *UserSelection* is specified, it is set to EfiHiiPopupSelectionOk.

EfiHiiPopupTypeOkCancel is a popup window with two user selectable options: OK and Cancel.

EfiHiiPopupTypeYesNo is a popup window with two user selectable options: Yes and No.

EfiHiiPopupTypeYesNoCancel is a popup window with three user selectable options: Yes, No, and Cancel.

## Related Definitions

```
typedef enum {
    EfiHiiPopupStyleInfo,
    EfiHiiPopupStyleWarning,
    EfiHiiPopupStyleError
} EFI_HII_POPUP_STYLE;
typedef enum {
    EfiHiiPopupTypeOk,
    EfiHiiPopupTypeOkCancel,
    EfiHiiPopupTypeYesNo,
    EfiHiiPopupTypeYesNoCancel
} EFI_HII_POPUP_TYPE;
typedef enum {
    EfiHiiPopupSelectionOk,
    EfiHiiPopupSelectionCancel,
    EfiHiiPopupSelectionYes,
    EfiHiiPopupSelectionNo
} EFI_HII_POPUP_SELECTION;
```

## Status Codes Returned

**EFI\_SUCCESS** The popup box was successfully displayed

**EFI\_INVALID\_PARAMETER** HiiHandle and Message do not define is a valid HII string.

**EFI\_INVALID\_PARAMETER** PopupType is not one of the values defined by this specification.

**EFI\_OUT\_OF\_RESOURCES** There are not enough resources available to display the popup box.



## 35 User Identification

---

### 35.1 User Identification Overview

This section describes services which describe the current user of the platform. A *user* is the entity which is controlling the behavior of the machine. The user may be an individual, a class or group of individuals or another machine.

Each user has a *user profile*. There is always at least one user profile for a machine. This profile governs the behavior of the user identification process until a another user has been selected. The nature and definition of these privileges are beyond the scope of this section. One user profile is always active and describes the platform's *current user*.

New user profiles are introduced into the system through *enrollment*. During enrollment, information about a new user is gathered. Some of this information identifies the user for specific purposes, such as a user's name or a user's network domain. Other information is gathered in the form of *credentials*, which is information which can be used at a later time to verify the identity of a user. Credentials are generally divided into three categories: something you know (password), something you have (smart card, smart token, RFID), something you are (fingerprint). The means by which a platform determines the user's identity based on credentials is *user identification*.

In the simplest case, a single set of credentials are required to establish a user's identity. This is called *single-factor* authentication. In more rigorous cases, multiple credentials might be required to establish a user's identity or different privilege levels given if only a single factor is available. This is called *multi-factor* authentication.

If the credentials are checked only once, this is called *static* authentication. For example, a sign-on box where the user enters a password and provides a fingerprint would be examples of static authentication. However, if credentials (and thus the user's identity) can be changed during system execution, this is called *dynamic* authentication. For example, a smart token which can be hot-removed from the system or an RFID tag which is moved in and out of range would be examples of dynamic authentication.

The *user identity manager* is the optional UEFI driver which manages the process of determining the user's identity and storing information about the user.

The *user enrollment manager* is the optional application which adds or enrolls new users, gathering the necessary information to ascertain their identity in the future.

The *credential provider driver* manages a single class of credentials. Examples include a USB fingerprint sensor, a smart card or a password. The means by which these drivers are selected and invoked is beyond the scope of this specification.

#### 35.1.1 User Identify

The process of identifying the user occurs after platform initialization has made the services described in the EFI System Table available. Before the Boot Manager behavior described in chapter 3, a user profile must be established. The user profile established might be:

- A *default* user profile, giving a standard set of privileges. This is similar to a “guest” login.
- A *default* user profile, based on a User Credential Provider where **Default()** returns *AutoLogon = TRUE*.
- A specific user profile, established using the **Identify()** function of the User Manager.

Every time the user profile is modified, the User Identity Manager will signal the **EFI\_EVENT\_GROUP\_USER\_PROFILE\_CHANGED** event. The current user profile can only be changed by calling the User Identity Manager’s **Identify()** function or as the result of a credential provider calling the **Notify()** function (when dynamic authentication is supported). The **Identify()** function changes the current user profile after examining the credentials provided by the various credential providers and comparing these against those found in the user profile database.

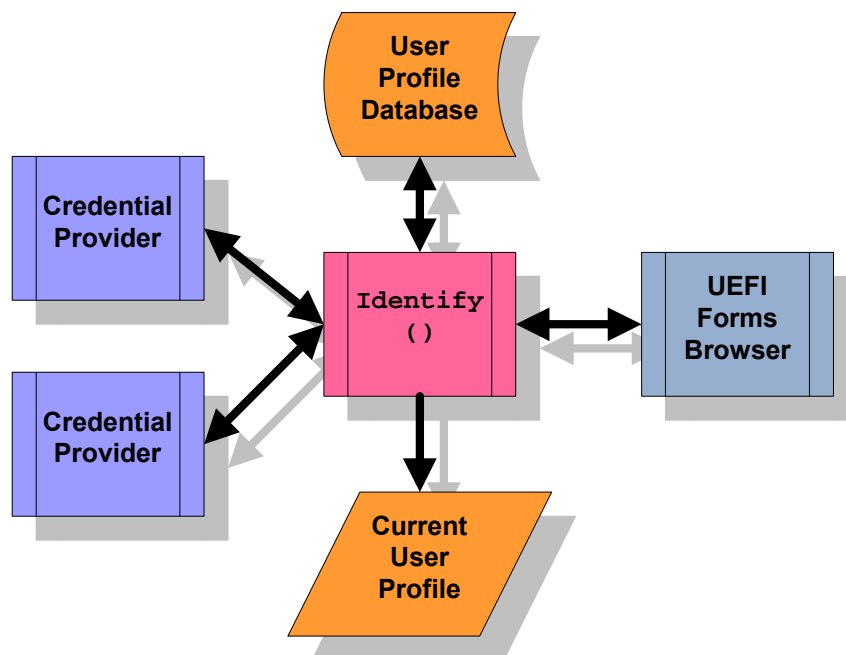

Figure 139. User Identity

When the UEFI Boot Manager signals the **EFI\_EVENT\_GROUP\_READY\_TO\_BOOT** event group, the User Identity Manager publishes the current user profile information in the EFI System Configuration Table.

Depending on the security considerations in the implementation (see [Section 35.1.4](#)), user identification can continue into different phases of execution.

1. Boot Manager, Once. In this scenario, identification is permitted until the **EFI\_EVENT\_GROUP\_READY\_TO\_BOOT** is signaled by the Boot Manager. After this time, user identification is not allowed again. This is the simplest, since the user profile database can be locked at this time using a simple one-time lock.

2. Boot Manager, Multiple. In this scenario, identification is permitted until the **EFI\_EVENT\_GROUP\_READY\_TO\_BOOT** is signaled by the Boot Manager. After this time, if the boot option returns back into the Boot Manager, identification is allowed again. This scenario requires that the user profile database only be updatable while in the Boot Manager.
3. Until ExitBootServices. In this scenario, identification is permitted until the **EFI\_EVENT\_GROUP\_EXIT\_BOOT\_SERVICES** is signaled by the Boot Manager. This scenario requires that the user profile database cannot be updated by unauthorized executables.

### 35.1.2 User Profiles

The user profiles are collections of information about users. There is always a current user (and thus, a currently selected user profile). The user profiles are stored in a user profile database.

Each user profile has the following attributes:

#### § User Identifier

User identifiers are unique to a particular user profile. The uniqueness of the user profile identifier must persist across reboots. Credentials return this identifier during the identification process.

#### § User Identification Policy

The user identification policy determines which credentials must be presented in order to establish the user's identity and set the user profile as the current user profile. The policy consists of a boolean expression consisting of credential handles and the operators **AND**, **OR** and **NOT**. This allows the user profile to be selected, for example, depending on a password credential **OR** a fingerprint credential. Or the profile might be selected depending on a password credential **AND** a fingerprint credential.

#### § User Privileges

The user privileges control what the user can and cannot do. For example, can the user enroll other users, boot off of a selected device, etc.

#### § User Information

User information consists of typed data records attached to the user profile handle. Some of this information is non-volatile. Some of this information may be provided by a specific credential driver. User information is classified as public, private or protected:

- Public user information is available at any time.
- Private user information is only available while it is part of the current user profile.
- Protected user information is only available once user has been authenticated by a credential provider.

Drivers and applications can be notified when the current user profile is changed, by using the UEFI Boot Service `CreateEventEx()` and the `EFI_EVENT_GROUP_USER_PROFILE_CHANGED`

User profiles are available while the User Identity Manager is running, but only the current user profile is available after the UEFI Boot Manager has started execution.

### 35.1.2.1 User Profile Database

The user profile database is a repository of all users known to the user identity manager. The user profile database should be maintained in non-volatile memory and this memory must be protected against corruption and erasure.

The user profile database is considered “open” if the user profile database can still be updated and the current profile can still be changed using the EFI User Manager Protocol. The user profile database is considered “closed” if the user profile database cannot be updated nor the current user profile changes using the EFI User Manager Protocol.

### 35.1.2.2 User Identification Policy

The user identification policy is a boolean expression which determines which class of credential or which credential providers must assert the user's identity in order to a user profile to be eligible for selection as the current user profile.

For example, assume that you want a password:

`CredentialClass>Password`

This expression would assert `true` if any credential provider asserts that a user has successfully entered a password.

`CredentialClass>Password && CredentialClass>Fingerprint`

This expression would require the user to present both a fingerprint AND a password in order to select this user profile.

`CredentialClass>Password || CredentialClass>Fingerprint`

This expression, on the other hand, allows the user to present a fingerprint OR a password in order to select this user profile.

Let's say you only want the Phoenix password provider:

`CredentialClass>Password && CredentialProvider>Phoenix`

In all of these cases, the class of credential and the provider of the credential are actually GUIDs. The standard credential class GUIDs are assigned by this specification. The credential provider identifiers are generated by the companies creating the credential providers.

### 35.1.3 Credential Providers

The User Credential Provider drivers follow the UEFI driver model. During initialization, they install an instance of the EFI Driver Binding Protocol. For hardware devices, the User Credential Provider may consume the bus I/O protocol and produce the User Credential

Protocol. For software-based User Credential Providers, the User Credential Protocol could be installed on the image handler. The exact implementation depends on the number of separate credential types that the User Identity Manager will display.

When **Start()** is called, they:

1. Install one instance of the **EFI\_USER\_CREDENTIAL2\_PROTOCOL** for each simultaneous user which might be authenticated. For example, if more than one smart token were inserted, then one instance might be created for each token. However, for a fingerprint sensor, one instance might be created for all fingerprint sensors managed by the same driver.
2. Install the user-interface forms used for interacting with the user using the HII Database Protocol. The form must be encoded using the GUID **EFI\_USER\_CREDENTIAL2\_PROTOCOL\_GUID**.
3. Install the EFI HII Configuration Access Protocol to handle interaction with the UEFI forms browser. This protocol is called to retrieve the current information from the credential provider. It is also called when the user presses OK to save the current form values. It also provides the callback functionality which allows real-time processing of the form values.

User Credential Providers are responsible to creating a one-to-one mapping between a device, fingerprint or password and a user identifier.

This specification does not explicitly support passing of user credential information related to operating system logon to an OS-present environment. For example, User Credential Providers may encrypt the user credential information and pass it, either as a part of the User Information Table or the EFI System Configuration Table, to an OS-present driver or application.

This specification does not explicitly support OS-present update of user credential information or user identification policy. Such support may be implemented in many ways, including the usage of write-authenticated EFI variables (see [SetVariable\(\)](#)) or capsules (see [UpdateCapsule\(\)](#)).

### 35.1.4 Security Considerations

Since the current profile details a number of security-related privileges, it is important that the User Identity Manager and User Credential Providers and the environment in which they execute are trusted.

This includes:

- Protecting the storage area where these drivers are stored
- Protecting the means by which these drivers are selected.
- Protecting the execution environment of these drivers from unverified drivers.
- The data structures used by these drivers should not be corrupted by unauthorized drivers while they are still being used.

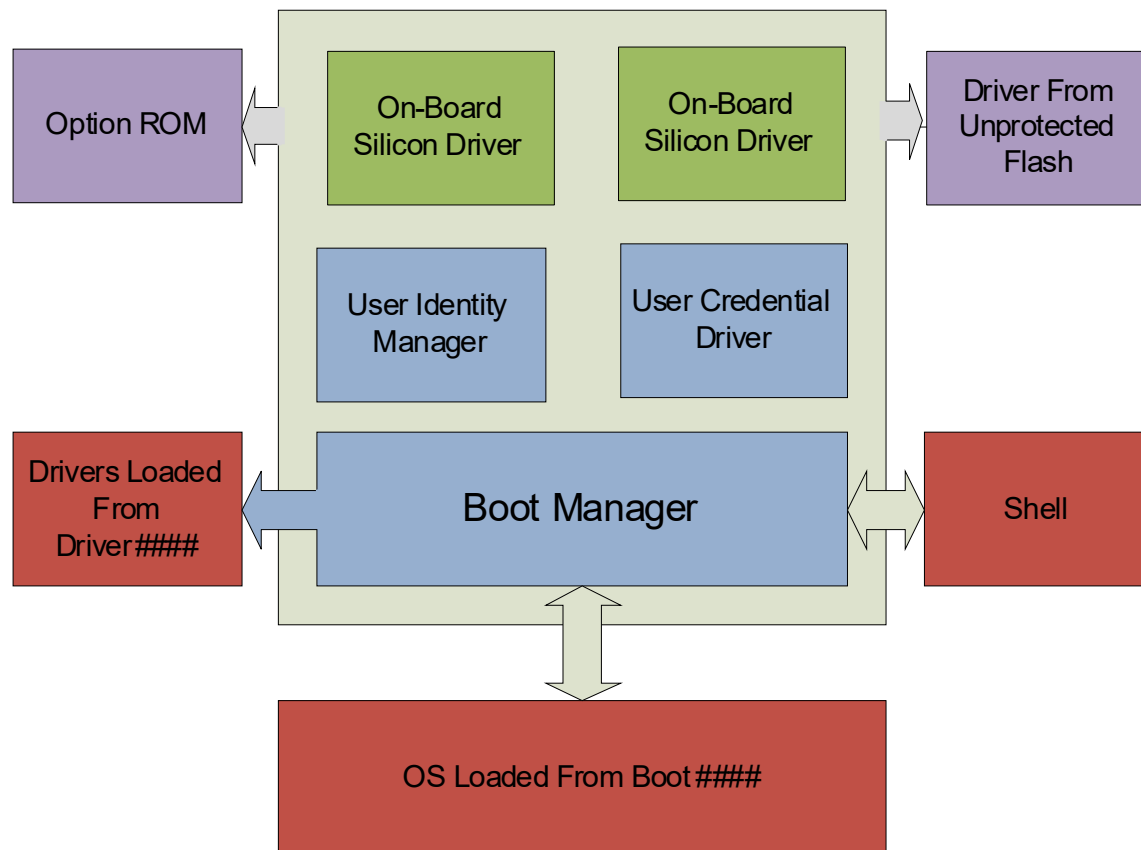

In many cases, the User Identity Manager, the User Credential drivers and the on-board drivers are located in a protected location (e.g. a write-protected flash device) and the platform policy for these locations allows them to be trusted.

However, other drivers may be loaded from unprotected location or may be loaded from devices (such as PCI cards) or a hard drive which are easily replaced. Therefore, all drivers loaded prior to the User Identity Manager should be verified. No unverified drivers or applications should be allowed to execute while decisions based on the current user policy are still being made.

For example, either the default platform policy must successfully be able to verify drivers listed in the *Driver####* load options, or else the user must be identified prior to processing these drivers. Otherwise, the drivers' execution should be deferred. If the user profile is changed through a subsequent call to **Identify()** or through dynamic authentication, the *Driver####* options may not be processed again.

In systems where the user profile database and current user profile can be protected from corruption, the user profile database is closed when the system signals the event **EFI\_EXIT\_BOOT\_SERVICES\_EVENT\_GUID**. In systems where the user profile database and current user profile cannot be protected from corruption, the user profile database is closed when the system signals the event **EFI\_READY\_TO\_BOOT\_EVENT\_GUID**.

### 35.1.5 Deferred Execution

The platform may need to defer the execution of an image because of security considerations. For example, see `LoadImage()`. Information about the images which are not executed because of security considerations may be recorded and then reported by installing an instance of the **EFI\_DEFERRED\_IMAGE\_LOAD\_PROTOCOL** (see [Section 35.3.3](#)). There may be more than one producer of the protocol.

The firmware's boot manager may use the instances of this protocol in order to automatically load drivers whose execution was deferred because of inadequate privileges once the current user profile contains adequate security privileges.

This boot manager can reevaluate the deferred images each time that the event **EFI\_EVENT\_GROUP\_USER\_IDENTITY\_CHANGED** is signaled

Images which have been loaded may not be unloaded when the current user profile is changed, even if the new user profile would have prevented that driver from being loaded.

## 35.2 User Identification Process

This section describes the typical initialization steps required for the user identification process.

### 35.2.1 User Identification Process

1. The User Identity Manager is launched. This driver reads all of the user profiles from the user profile database, sets the default user profile as the current profile, and installs an instance of the **EFI\_USER\_MANAGER\_PROTOCOL**.
2. Each credential provider driver registers their user-interface related forms and installs an instance of the **EFI\_USER\_CREDENTIAL2\_PROTOCOL**.
3. The User Identity Manager's **Identify()** function is called to select the current user.
4. The User Identity Manager enumerates all of the User Credential Providers required by the User Identification Policy.
  - a Select the User Credential Provider which returns *Default* = TRUE from the **Default()** function. If more than one return TRUE or none return TRUE, choose a default based on implementation-specific criteria (last-logged-on, etc.)
  - b If that credential provider also returns *AutoLogon* = TRUE from the **Default()** function, then call **User()**. If no error was returned and a user profile with the specified user identifier exists, select the specified user profile as the current user profile and jump to step 9.
5. The User Identity Manager enumerates all of the User Credential Providers required by the User Identification Policy:
  - a Call the **Title()** and (optionally) the **Tile()** function to retrieve the text and image indicated for each User Credential Provider.
  - b Call the **Form()** function to retrieve the form indicated for each User Credential Provider.

- c Create the user interface to allow the user to select between the different User Credential Providers.
  - d Highlight the default User Credential Provider, as specified in step 4.a.
6. If the user selects one of the User Credential Providers, call **Select()**. If *AutoLogon* = **TRUE** on return, then call **User()**. If no error was returned and a user profile with the specified user identifier exists, select the specified user profile as the current user profile and jump to step 9.
7. Interact with the user. Regular interaction can occur using the **Callback()** functions. If another User Credential Provider is selected then **Deselect()** is called for the current User Credential Provider and **Select()** is called for the newly selected User Credential Provider.
8. If the user presses **OK** then the User Manager will save settings using the EFI Configuration Access protocol. Then it will call the **User()** function of each credential provider. If it returns successfully and one of the user policies evaluates to true, then select the specified user profile as the current user profile and go to step 9. Otherwise display an error and go back.
9. Go through all of the credential providers using **GetNextInfo()** and **GetInfo()** and add the information to the current user profile.
10. Exit

### 35.2.2 Changing The Current User Profile

This section describes the typical actions taken when the current user profile is changed.

1. If there was already a valid current user profile, then all records marked as *private* in that profile are no longer available.
2. All records marked as *private* in the new user profile will be available.
3. The handle of the current user profile is changed.
4. An event with the GUID **EFI\_EVENT\_GROUP\_USER\_IDENTITY\_CHANGED** is signaled to indicate that the current user profile has been changed.

### 35.2.3 Ready To Boot

Before the boot manager is ready to pass control to the boot option and signals the **EFI\_EVENT\_GROUP\_READY\_TO\_BOOT** event group, the User Identity Manager will publish the current user profile into the EFI System Configuration Table with the **EFI\_USER\_MANAGER\_PROTOCOL\_GUID**. The format is described in "User Information Table" (page 58). It will also save all non-volatile profile information.

User Credential drivers with non-volatile storage should also store non-volatile credential information which has changed.



## 35.3 Code Definitions

### 35.3.1 User Manager Protocol

#### EFI\_USER\_MANAGER\_PROTOCOL

##### Summary

Reports information about a user.

##### GUID

```
#define EFI_USER_MANAGER_PROTOCOL_GUID \
  { 0x6fd5b00c, 0xd426, 0x4283, \
    { 0x98, 0x87, 0x6c, 0xf5, 0xcf, 0x1c, 0xb1, 0xfe } };
```

##### Protocol Interface Structure

```
typedef struct _EFI_USER_MANAGER_PROTOCOL {
  EFI_USER_PROFILE_CREATE   Create;
  EFI_USER_PROFILE_DELETE   Delete;
  EFI_USER_PROFILE_GET_NEXT GetNext;
  EFI_USER_PROFILE_CURRENT  Current;
  EFI_USER_PROFILE_IDENTIFY Identify;
  EFI_USER_PROFILE_FIND     Find;
  EFI_USER_PROFILE_NOTIFY   Notify;
  EFI_USER_PROFILE_GET_INFO GetInfo;
  EFI_USER_PROFILE_SET_INFO SetInfo;
  EFI_USER_PROFILE_DELETE_INFO DeleteInfo;
  EFI_USER_PROFILE_GET_NEXT_INFO GetNextInfo;
} EFI_USER_MANAGER_PROTOCOL;
```

##### Parameters

###### *Create*

Create a new user profile.

###### *Delete*

Delete an existing user profile.

###### *GetNext*

Cycle through all user profiles.

###### *Current*

Return the current user profile.

###### *Identify*

Identify a user and set the current user profile using credentials.

###### *Find*

Find a user by a piece of user information.

*Notify*

Notify the user manager driver that credential information has changed.

*GetInfo*

Return information from a user profile.

*SetInfo*

Change information in a user profile.

*DeleteInfo*

Delete information from a user profile.

*GetNextInfo*

Cycle through all information from a user profile.

**Description**

This protocol manages user profiles.

## EFI\_USER\_MANAGER\_PROTOCOL.Create()

### Summary

Create a new user profile.

### Prototype

```
typedef
EFI_STATUS
(EFIAPI *EFI_USER_PROFILE_CREATE) (
  IN CONST EFI_USER_MANAGER_PROTOCOL *This,
  OUT EFI_USER_PROFILE_HANDLE *User
);
```

### Parameters

*This*

Points to this instance of the **EFI\_USER\_MANAGER\_PROTOCOL**.

*User*

On return, points to the new user profile handle. The user profile handle is unique only during this boot.

### Description

This function creates a new user profile with only a new user identifier attached and returns its handle. The user profile is non-volatile, but the handle *User* can change across reboots.

If the current user profile does not permit creation of new user profiles then **EFI\_ACCESS\_DENIED** will be returned. If creation of new user profiles is not supported, then **EFI\_UNSUPPORTED** is returned.

### Related Definitions

```
typedef VOID *EFI_USER_PROFILE_HANDLE;
```

### Status Codes Returned

EFI_SUCCESS	User profile was successfully created.
EFI_ACCESS_DENIED	Current user does not have sufficient permissions to create a user profile.
EFI_UNSUPPORTED	Creation of new user profiles is not supported.
EFI_INVALID_PARAMETER	<i>User</i> is <b>NULL</b> .

## EFI\_USER\_MANAGER\_PROTOCOL.Delete()

### Summary

Delete an existing user profile.

### Prototype

```
typedef
EFI_STATUS
(EFIAPI *EFI_USER_PROFILE_DELETE) (
  IN CONST EFI_USER_MANAGER_PROTOCOL *This,
  IN EFI_USER_PROFILE_HANDLE User
);
```

### Parameters

*This*

Points to this instance of the **EFI\_USER\_MANAGER\_PROTOCOL**.

*User*

User profile handle. Type **EFI\_USER\_PROFILE\_HANDLE** is defined in **Create()**.

### Description

Delete an existing user profile. If the current user profile does not permit deletion of user profiles then **EFI\_ACCESS\_DENIED** will be returned. If there is only a single user profile then **EFI\_ACCESS\_DENIED** will be returned. If deletion of user profiles is not supported, then **EFI\_UNSUPPORTED** will be returned.

### Status Codes Returned

EFI_SUCCESS	User profile was successfully deleted.
EFI_ACCESS_DENIED	Current user does not have sufficient permissions to delete a user profile or there is only one user profile.
EFI_UNSUPPORTED	Deletion of new user profiles is not supported.
EFI_INVALID_PARAMETER	<i>User</i> does not refer to a valid user profile.

## EFI\_USER\_MANAGER\_PROTOCOL.GetNext()

### Summary

Enumerate all of the enrolled users on the platform.

### Prototype

```
typedef
EFI_STATUS
(EFIAPI *EFI_USER_PROFILE_GET_NEXT)(
  IN CONST EFI_USER_MANAGER_PROTOCOL *This,
  IN OUT EFI_USER_PROFILE_HANDLE *User
);
```

### Parameters

*This*

Points to the instance of this **EFI\_USER\_MANAGER\_PROTOCOL**.

*User*

On entry, points to the previous user profile handle or NULL to start enumeration. On exit, points to the next user profile handle or NULL if there are no more user profiles.

### Description

This function returns the next enrolled user profile. To retrieve the first user profile handle, point *User* at a **NULL**. Each subsequent call will retrieve another user profile handle until there are no more, at which point *User* will point to **NULL**.

**Note:** *There is always at least one user profile.*

### Status Codes Returned

EFI_SUCCESS	Next enrolled user profile successfully returned.
EFI_INVALID_PARAMETER	<i>User</i> is <b>NULL</b> .
EFI_ACCESS_DENIED	Next enrolled user profile was not successfully returned.

## EFI\_USER\_MANAGER\_PROTOCOL.Current()

### Summary

Return the current user profile handle.

### Prototype

```
typedef
EFI_STATUS
(EFIAPI *EFI_USER_PROFILE_CURRENT)(
  IN CONST EFI_USER_MANAGER_PROTOCOL *This,
  OUT EFI_USER_PROFILE_HANDLE *CurrentUser
);
```

### Parameters

*This*

Points to this instance of the **EFI\_USER\_MANAGER\_PROTOCOL**.

*CurrentUser*

On return, points to the current user profile handle.

### Description

This function returns the current user profile handle.

### Status Codes Returned

EFI_SUCCESS	Current user profile handle returned successfully.
EFI_INVALID_PARAMETER	<i>CurrentUser</i> is NULL.

## EFI\_USER\_MANAGER\_PROTOCOL.Identify()

### Summary

Identify a user.

### Prototype

```
typedef
EFI_STATUS
(EFIAPI *EFI_USER_IDENTIFY) (
  IN CONST EFI_USER_MANAGER_PROTOCOL *This,
  OUT EFI_USER_PROFILE_HANDLE *User
);
```

### Parameters

*This*

Points to the instance of the **EFI\_USER\_MANAGER\_PROTOCOL**.

*User*

On return, points to the user profile handle for the current user profile.

### Description

Identify the user and, if authenticated, returns the user handle and changes the current user profile.

All user information marked as private in a previously selected profile is no longer available for inspection.

Whenever the current user profile is changed then the an event with the GUID **EFI\_EVENT\_GROUP\_USER\_PROFILE\_CHANGED** is signaled.

The function can only be called at **TPL\_APPLICATION**.

### Related Definitions

```
#define EFI_EVENT_GROUP_USER_PROFILE_CHANGED \
{ 0xbaf1e6de, 0x209e, 0x4adb, \
  { 0x8d, 0x96, 0xfd, 0x8b, 0x71, 0xf3, 0xf6, 0x83 } }
```

### Status Codes Returned

EFI_SUCCESS	User was successfully identified.
EFI_INVALID_PARAMETER	<i>User</i> is <b>NULL</b> .
EFI_ACCESS_DENIED	User was not successfully identified.

## EFI\_USER\_MANAGER\_PROTOCOL.Find()

### Summary

Find a user using a user information record.

### Prototype

```
typedef
EFI_STATUS
(EFIAPI *EFI_USER_PROFILE_FIND)(
  IN CONST EFI_USER_MANAGER_PROTOCOL *This,
  IN OUT EFI_USER_PROFILE_HANDLE *User,
  IN OUT EFI_USER_INFO_HANDLE *UserInfo OPTIONAL,
  IN CONST EFI_USER_INFO *Info,
  IN UINTN InfoSize
);
```

### Parameters

*This*

Points to this instance of the **EFI\_USER\_MANAGER\_PROTOCOL**.

*User*

On entry, points to the previously returned user profile handle or **NULL** to start searching with the first user profile. On return, points to the user profile handle or **NULL** if not found.

*UserInfo*

On entry, points to the previously returned user information handle or **NULL** to start searching with the first. On return, points to the user information handle of the user information record or **NULL** if not found. Can be **NULL**, in which case only one user information record per user can be returned. Type **EFI\_USER\_INFO\_HANDLE** is defined in "Related Definitions" below.

*Info*

Points to the buffer containing the user information to be compared to the user information record. If the user information record data is empty, then only the user information record type is compared.

If *InfoSize* is 0, then the user information record data must be empty.

*InfoSize*

The size of *Info*, in bytes.

### Description

This function searches all user profiles for the specified user information record. The search starts with the user information record handle following *UserInfo* and continues until either the information is found or there are no more user profiles.



A match occurs when the *Info.InfoType* field matches the user information record type and the user information record data matches a portion of *Info*.

### Status Codes Returned

EFI_SUCCESS	User information was found. <i>User</i> points to the user profile handle and <i>UserInfo</i> points to the user information handle.
EFI_NOT_FOUND	User information was not found. <i>User</i> points to NULL and <i>UserInfo</i> points to NULL.
EFI_INVALID_PARAMETER	<i>User</i> is <b>NULL</b> . Or <i>Info</i> is <b>NULL</b> .

### Related Definitions

```
typedef VOID *EFI_USER_INFO_HANDLE;
```

## EFI\_USER\_MANAGER\_PROTOCOL.Notify()

### Summary

Called by credential provider to notify of information change.

### Prototype

```
typedef
EFI_STATUS
(EFIAPI *EFI_USER_PROFILE_NOTIFY)(
  IN CONST EFI_USER_MANAGER_PROTOCOL *This,
  IN EFI_HANDLE Changed
);
```

### Parameters

*This*

Points to this instance of the **EFI\_USER\_MANAGER\_PROTOCOL**.

*Changed*

Handle on which is installed an instance of the **EFI\_USER\_CREDENTIAL2\_PROTOCOL** where the user has changed.

### Description

This function allows the credential provider to notify the User Identity Manager when user status has changed.

If the User Identity Manager doesn't support asynchronous changes in credentials, then this function should return **EFI\_UNSUPPORTED**.

If current user does not exist, and the credential provider can identify a user, then make the user to be current user and signal the **EFI\_EVENT\_GROUP\_USER\_PROFILE\_CHANGED** event.

If current user already exists, and the credential provider can identify another user, then switch current user to the newly identified user, and signal the **EFI\_EVENT\_GROUP\_USER\_PROFILE\_CHANGED** event.

If current user was identified by this credential provider and now the credential provider cannot identify current user, then logout current user and signal the **EFI\_EVENT\_GROUP\_USER\_PROFILE\_CHANGED** event.

### Status Codes Returned

EFI_SUCCESS	The User Identity Manager has handled the notification.
EFI_NOT_READY	The function was called while the specified credential provider was not selected.
EFI_UNSUPPORTED	The User Identity Manager doesn't support asynchronous notifications.

## EFI\_USER\_MANAGER\_PROTOCOL.GetInfo()

### Summary

Return information attached to the user.

### Prototype

```
typedef
EFI_STATUS
(EFIAPI *EFI_USER_PROFILE_GET_INFO)(
  IN CONST EFI_USER_MANAGER_PROTOCOL *This,
  IN EFI_USER_PROFILE_HANDLE User,
  IN EFI_USER_INFO_HANDLE UserInfo,
  OUT EFI_USER_INFO *Info,
  IN OUT UINTN *InfoSize
);
```

### Parameters

*This*

Points to this instance of the **EFI\_USER\_MANAGER\_PROTOCOL**.

*User*

Handle of the user whose profile will be retrieved.

*UserInfo*

Handle of the user information data record. Type **EFI\_USER\_INFO\_HANDLE** is defined in **GetInfo()**.

*Info*

On entry, points to a buffer of at least *InfoSize* bytes. On exit, holds the user information. If the buffer is too small to hold the information, then **EFI\_BUFFER\_TOO\_SMALL** is returned and *InfoSize* is updated to contain the number of bytes actually required. Type **EFI\_USER\_INFO** is described in "Related Definitions" below.

*InfoSize*

On entry, points to the size of *Info*. On return, points to the size of the user information.

### Description

This function returns user information. The format of the information is described in User Information. The function may return **EFI\_ACCESS\_DENIED** if the information is marked *private* and the handle specified by *User* is not the current user profile. The function may return **EFI\_ACCESS\_DENIED** if the information is marked *protected* and the information is associated with a credential provider for which the user has not been authenticated.

## Status Codes Returned

EFI_SUCCESS	Information returned successfully.
EFI_ACCESS_DENIED	The information about the specified user cannot be accessed by the current user.
EFI_BUFFER_TOO_SMALL	The number of bytes specified by <i>*InfoSize</i> is too small to hold the returned data. The actual size required is returned in <i>*InfoSize</i> .
EFI_NOT_FOUND	<i>User</i> does not refer to a valid user profile or <i>UserInfo</i> does not refer to a valid user info handle.
EFI_INVALID_PARAMETER	<i>Info</i> is <b>NULL</b> or <i>InfoSize</i> is <b>NULL</b>

## Related Definitions

```
typedef struct {
    EFI_GUID    Credential;
    UINT8      InfoType;
    UINT8      Reserved1;
    EFI_USER_INFO_ATTRIBS InfoAttribs;
    UINT32     InfoSize;
} EFI_USER_INFO;
```

### *Credential*

The user credential identifier associated with this user information or else Nil if the information is not associated with any specific credential.

### *InfoType*

The type of user information. See **EFI\_USER\_INFO\_x\_RECORD** in User Information for a description of the different types of user information.

### *Reserved1*

Must be set to 0.

### *InfoAttribs*

The attributes of the user profile information.

### *InfoSize*

The size of the user information, in bytes, including this header.

```
typedef UINT16 EFI_USER_INFO_ATTRIBS;

#define EFI_USER_INFO_STORAGE      0x000F
#define EFI_USER_INFO_STORAGE_VOLATILE 0x0000
#define EFI_USER_INFO_STORAGE_CREDENTIAL_NV 0x0001
#define EFI_USER_INFO_STORAGE_PLATFORM_NV 0x0002

#define EFI_USER_INFO_ACCESS      0x0070
#define EFI_USER_INFO_PUBLIC      0x0010
#define EFI_USER_INFO_PRIVATE     0x0020
#define EFI_USER_INFO_PROTECTED   0x0030
#define EFI_USER_INFO_EXCLUSIVE   0x0080
```

The **EFI\_USER\_INFO\_STORAGE\_x** values describe how the user information should be stored. If **EFI\_USER\_INFO\_STORAGE\_VOLATILE** is specified, then the user profile information will be lost after a reboot. If **EFI\_USER\_INFO\_STORAGE\_CREDENTIAL\_NV** is specified, then the information will be stored by the driver which created the handle *Credential*. If **EFI\_USER\_INFO\_STORAGE\_PLATFORM\_NV** is specified, then the information will be stored by the User Identity Manager in platform non-volatile storage.

There are three levels of access to information associated with the user profile: public, private or protected. If **EFI\_USER\_INFO\_PUBLIC** is specified, then the user profile information is available always. If **EFI\_USER\_INFO\_PRIVATE** is specified, then the user profile information is only available if the user has been authenticated (whether or not they are the current user). If **EFI\_USER\_INFO\_PROTECTED** is specified, then the user profile information is only available if the user has been authenticated and is the current user.

If **EFI\_USER\_INFO\_EXCLUSIVE** is specified then there can only be one user information record of this type in the user profile. Attempts to use **SetInfo()** will fail.

## EFI\_USER\_MANAGER\_PROTOCOL.SetInfo()

### Summary

Add or update user information.

### Prototype

```
typedef
EFI_STATUS
(EFI_API *EFI_USER_PROFILE_SET_INFO) (
  IN CONST EFI_USER_MANAGER_PROTOCOL *This,
  IN EFI_USER_PROFILE_HANDLE User,
  IN OUT EFI_USER_INFO_HANDLE *UserInfo,
  IN CONST EFI_USER_INFO *Info,
  IN UINTN InfoSize
);
```

### Parameters

*This*

Points to this instance of the **EFI\_USER\_MANAGER\_PROTOCOL**.

*User*

Handle of the user whose profile will be changed.

*UserInfo*

On entry, points to the handle of the user information record to change or **NULL** if the user information should be added to the user profile. On exit, points to the handle of the user credential information record.

*Info*

Points to the user information. See **EFI\_USER\_INFO** for more information.

*InfoSize*

The size of *Info*, in bytes.

### Description

This function changes user information. If **NULL** is pointed to by *UserInfo*, then a new user information record is created and its handle is returned in *UserInfo*. Otherwise, the existing one is replaced.

If **EFI\_USER\_INFO\_IDENTITY\_POLICY\_RECORD** is changed, it is the caller's responsibility to keep it to be synced with the information on credential providers.

If **EFI\_USER\_INFO\_EXCLUSIVE** is specified in *Info* and a user information record of the same type already exists in the user profile, then **EFI\_ACCESS\_DENIED** will be returned and *UserInfo* will point to the handle of the existing record.

### Status Codes Returned

EFI_SUCCESS	User profile information was successfully changed/added.
-------------	--

EFI_ACCESS_DENIED	The record is exclusive.
EFI_SECURITY_VIOLATION	The current user does not have permission to change the specified user profile or user information record.
EFI_NOT_FOUND	<i>User</i> does not refer to a valid user profile or <i>UserInfo</i> does not refer to a valid user info handle.
EFI_INVALID_PARAMETER	<i>Info</i> is <b>NULL</b> or <i>InfoSize</i> is <b>NULL</b>

## EFI\_USER\_MANAGER\_PROTOCOL.DeleteInfo()

### Summary

Delete user information.

### Prototype

```
typedef
EFI_STATUS
(EFI_API *EFI_USER_PROFILE_DELETE_INFO) (
  IN CONST EFI_USER_MANAGER_PROTOCOL *This,
  IN EFI_USER_PROFILE_HANDLE User,
  IN EFI_USER_INFO_HANDLE UserInfo
);
```

### Parameters

*This*

Points to this instance of the **EFI\_USER\_MANAGER\_PROTOCOL**.

*User*

Handle of the user whose information will be deleted.

*UserInfo*

Handle of the user information to remove.

### Description

Delete the user information attached to the user profile specified by the *UserInfo*.

### Status Codes Returned

EFI_SUCCESS	User information deleted successfully.
EFI_NOT_FOUND	User information record <i>UserInfo</i> does not exist in the user profile.
EFI_ACCESS_DENIED	The current user does not have permission to delete this user information.



## EFI\_USER\_MANAGER\_PROTOCOL.GetNextInfo()

### Summary

Enumerate all of the enrolled users on the platform.

### Prototype

```
typedef
EFI_STATUS
(EFI_API *EFI_USER_PROFILE_GET_NEXT_INFO)(
  IN CONST EFI_USER_MANAGER_PROTOCOL *This,
  IN EFI_USER_PROFILE_HANDLE User,
  IN OUT EFI_USER_INFO_HANDLE *UserInfo
);
```

### Parameters

*This*

Points to the instance of this **EFI\_USER\_MANAGER\_PROTOCOL**.

*User*

Handle of the user whose information will be enumerated

*UserInfo*

On entry, points to the previous user information handle or **NULL** to start enumeration. On exit, points to the next user information handle or **NULL** if there is no more user information.

### Description

This function returns the next user information record. To retrieve the first user information record handle, point *UserInfo* at a **NULL**. Each subsequent call will retrieve another user information record handle until there are no more, at which point *UserInfo* will point to **NULL**.

### Status Codes Returned

EFI_SUCCESS	User information returned.
EFI_NOT_FOUND	No more user information found.
EFI_INVALID_PARAMETER	<i>UserInfo</i> is <b>NULL</b> .

## 35.3.2 Credential Provider Protocols

### EFI\_USER\_CREDENTIAL2\_PROTOCOL

#### Summary

Provide support for a single class of credentials

## GUID

```
#define EFI_USER_CREDENTIAL2_PROTOCOL_GUID \
{ 0xe98adb03, 0xb8b9, 0x4af8, \
  { 0xba, 0x20, 0x26, 0xe9, 0x11, 0x4c, 0xbc, 0xe5 } }
```

## Prototype

```
typedef struct _EFI_USER_CREDENTIAL2_PROTOCOL {
  EFI_GUID      Identifier;
  EFI_GUID      Type;
  EFI_CREDENTIAL_ENROLL  Enroll;
  EFI_CREDENTIAL_FORM    Form;
  EFI_CREDENTIAL_TILE    Tile;
  EFI_CREDENTIAL_TITLE    Title;
  EFI_CREDENTIAL_USER    User;
  EFI_CREDENTIAL_SELECT  Select;
  EFI_CREDENTIAL_DESELECT  Deselect;
  EFI_CREDENTIAL_DEFAULT  Default;
  EFI_CREDENTIAL_GET_INFO  GetInfo;
  EFI_CREDENTIAL_GET_NEXT_INFO  GetNextInfo;
  EFI_CREDENTIAL_CAPABILITIES  Capabilities;
  EFI_CREDENTIAL_DELETE  Delete;
} EFI_USER_CREDENTIAL2_PROTOCOL;
```

## Parameters

### *Identifier*

Uniquely identifies this credential provider.

### *Type*

Identifies this class of User Credential Provider. See **EFI\_CREDENTIAL\_CLASS\_x** in “Related Definitions” below.

### *Enroll*

Enroll a user using this credential provider.

### *Form*

Return the form set and form identifier for the form.

### *Tile*

Returns an optional bitmap image used to identify this credential provider.

### *Title*

Returns a string used to identify this credential provider.

### *User*

Returns the user profile identifier ascertained by using this credential.

### *Select*

Called when a credential provider is selected.

*Deselect*

Called when a credential provider is deselected.

*Default*

Returns whether the credential provider can provide the default credential.

*GetInfo*

Return user information provided by the credential provider.

*GetNextInfo*

Cycle through all user information available from the credential provider.

*Capabilities*

Bitmask which describes the capabilities supported by the credential provider. Type **EFI\_CREDENTIAL\_CAPABILITIES** is defined in "Related Definitions" below.

*Delete*

Delete a user on this credential provider.

**Description**

Attached to a device handle, this protocol identifies a single means of identifying the user.

If **EFI\_CREDENTIAL\_CAPABILITIES\_ENROLL** is specified, then this credential provider supports the ability to enroll new user identification information using the **Enroll()** function.

## Related Definitions

```
#define EFI_USER_CREDENTIAL_CLASS_UNKNOWN \
{ 0x5cf32e68, 0x7660, 0x449b, \
{ 0x80, 0xe6, 0x7e, 0xa3, 0x6e, 0x3, 0xf6, 0xa8 } };

#define EFI_USER_CREDENTIAL_CLASS_PASSWORD \
{ 0xf8e5058c, 0xccb6, 0x4714, \
{ 0xb2, 0x20, 0x3f, 0x7e, 0x3a, 0x64, 0xb, 0xd1 } };

#define EFI_USER_CREDENTIAL_CLASS_SMART_CARD \
{ 0x5f03ba33, 0x8c6b, 0x4c24, \
{ 0xaa, 0x2e, 0x14, 0xa2, 0x65, 0x7b, 0xd4, 0x54 } };

#define EFI_USER_CREDENTIAL_CLASS_FINGERPRINT \
{ 0x32cba21f, 0xf308, 0x4cbc, \
{ 0x9a, 0xb5, 0xf5, 0xa3, 0x69, 0x9f, 0x4, 0x4a } };

#define EFI_USER_CREDENTIAL_CLASS_HANDPRINT \
{ 0x5917ef16, 0xf723, 0x4bb9, \
{ 0xa6, 0x4b, 0xd8, 0xc5, 0x32, 0xf4, 0xd8, 0xb5 } };

#define EFI_USER_CREDENTIAL_CLASS_SECURE_CARD \
{ 0x8a6b4a83, 0x42fe, 0x45d2, \
{ 0xa2, 0xef, 0x46, 0xf0, 0x6c, 0x7d, 0x98, 0x52 } };

typedef UINT64 EFI_CREDENTIAL_CAPABILITIES;

#define EFI_CREDENTIAL_CAPABILITIES_ENROLL 0x0000000000000001
```

## EFI\_USER\_CREDENTIAL2\_PROTOCOL.Enroll()

### Summary

Enroll a user on a credential provider.

### Prototype

```
typedef
EFI_STATUS
(EFIAPI *EFI_CREDENTIAL2_ENROLL)(
  IN CONST EFI_USER_CREDENTIAL2_PROTOCOL *This,
  IN EFI_USER_PROFILE_HANDLE User
);
```

### Parameters

*This*

Points to this instance of the **EFI\_USER\_CREDENTIAL2\_PROTOCOL**.

*User*

The user profile to enroll.

### Description

This function enrolls a user on this credential provider. If the user exists on this credential provider, update the user information on this credential provider; otherwise add the user information on credential provider.

### Status Codes Returned

EFI_SUCCESS	User profile was successfully enrolled
EFI_ACCESS_DENIED	Current user profile does not permit enrollment on the user profile handle. Either the user profile cannot enroll on any user profile or cannot enroll on a user profile other than the current user profile.
EFI_UNSUPPORTED	This credential provider does not support enrollment in the pre-OS.
EFI_DEVICE_ERROR	The new credential could not be created because of a device error.
EFI_INVALID_PARAMETER	<i>User</i> does not refer to a valid user profile handle.

## EFI\_USER\_CREDENTIAL2\_PROTOCOL.Form()

### Summary

Returns the user interface information used during user identification.

### Prototype

```
typedef
EFI_STATUS
(EFIAPI *EFI_CREDENTIAL_FORM)(
  IN CONST EFI_USER_CREDENTIAL2_PROTOCOL *This,
  OUT EFI_HII_HANDLE      *Hii,
  OUT EFI_GUID            *FormSetId,
  OUT EFI_FORM_ID        *FormId
);
```

### Parameters

*This*

Points to this instance of the **EFI\_USER\_CREDENTIAL2\_PROTOCOL**.

*Hii*

On return, holds the HII database handle. Type **EFI\_HII\_HANDLE** is defined in **EFI\_HII\_DATABASE\_PROTOCOL.NewPackageList()** in the Packages section.

*FormSetId*

On return, holds the identifier of the form set which contains the form used during user identification.

*FormId*

On return, holds the identifier of the form used during user identification.

### Description

This function returns information about the form used when interacting with the user during user identification. The form is the first enabled form in the form-set class **EFI\_HII\_USER\_CREDENTIAL\_FORMSET\_GUID** installed on the HII handle *HiiHandle*. If the user credential provider does not require a form to identify the user, then this function should return **EFI\_NOT\_FOUND**.

### Status Codes Returned

EFI_SUCCESS	Form returned successfully.
EFI_NOT_FOUND	Form not returned.
EFI_INVALID_PARAMETER	<i>Hii</i> is <b>NULL</b> or <i>FormSetId</i> is <b>NULL</b> or <i>FormId</i> is <b>NULL</b>

## EFI\_USER\_CREDENTIAL2\_PROTOCOL.Tile()

### Summary

Returns bitmap used to describe the credential provider type.

### Prototype

```
typedef
EFI_STATUS
(EFIAPI *EFI_CREDENTIAL_TILE)(
  IN CONST EFI_USER_CREDENTIAL2_PROTOCOL *This,
  IN OUT UINTN          *Width,
  IN OUT UINTN          *Height,
  OUT EFI_HII_HANDLE    *Hii,
  OUT EFI_IMAGE_ID      *Image
);
```

### Parameters

*This*

Points to this instance of the **EFI\_USER\_CREDENTIAL2\_PROTOCOL**.

*Width*

On entry, points to the desired bitmap width. If **NULL** then no bitmap information will be returned. On exit, points to the width of the bitmap returned.

*Height*

On entry, points to the desired bitmap height. If **NULL** then no bitmap information will be returned. On exit, points to the height of the bitmap returned.

*Hii*

On return, holds the HII database handle. Type **EFI\_HII\_HANDLE** is defined in **EFI\_HII\_DATABASE\_PROTOCOL.NewPackageList()** in the Packages section.

*Image*

On return, holds the HII image identifier. Type **EFI\_IMAGE\_ID** is defined in this specification, [Section 33.4](#).

### Description

This optional function returns a bitmap which is less than or equal to the number of pixels specified by *Width* and *Height*. If no such bitmap exists, then **EFI\_NOT\_FOUND** is returned.

### Status Codes Returned

EFI_SUCCESS	Image identifier returned successfully.
-------------	---

EFI_NOT_FOUND	Image identifier not returned.
EFI_INVALID_PARAMETER	<i>Hii</i> is <b>NULL</b> or <i>Image</i> is <b>NULL</b> .



## EFI\_USER\_CREDENTIAL2\_PROTOCOL.Title()

### Summary

Returns string used to describe the credential provider type.

### Prototype

```
typedef
EFI_STATUS
(EFIAPI *EFI_CREDENTIAL_TITLE)(
  IN CONST EFI_USER_CREDENTIAL2_PROTOCOL *This,
  OUT EFI_HII_HANDLE      *Hii,
  OUT EFI_STRING_ID      *String
);
```

### Parameters

*This*

Points to this instance of the **EFI\_USER\_CREDENTIAL2\_PROTOCOL**.

*Hii*

On return, holds the HII database handle. TType **EFI\_HII\_HANDLE** is defined in **EFI\_HII\_DATABASE\_PROTOCOL.NewPackageList()** in the Packages section.

*String*

On return, holds the HII string identifier. Type **EFI\_STRING\_ID** is defined in [Section 32.3.8.2.1](#).

### Description

This function returns a string which describes the credential provider. If no such string exists, then **EFI\_NOT\_FOUND** is returned.

### Status Codes Returned

EFI_SUCCESS	String identifier returned successfully.
EFI_NOT_FOUND	String identifier not returned.
EFI_INVALID_PARAMETER	<i>Hii</i> is <b>NULL</b> or <i>String</i> is <b>NULL</b> .

## EFI\_USER\_CREDENTIAL2\_PROTOCOL.User()

### Summary

Return the user identifier associated with the currently authenticated user.

### Prototype

```
typedef
EFI_STATUS
(EFIAPI *EFI_CREDENTIAL_USER)(
  IN CONST EFI_USER_CREDENTIAL2_PROTOCOL *This,
  IN EFI_USER_PROFILE_HANDLE User,
  OUT EFI_USER_INFO_IDENTIFIER *Identifier
);
```

### Parameters

*This*

Points to this instance of the **EFI\_USER\_CREDENTIAL2\_PROTOCOL**.

*User*

The user profile handle of the user profile currently being considered by the user identity manager. If **NULL**, then no user profile is currently under consideration.

*Identifier*

On return, points to the user identifier. Type **EFI\_USER\_INFO\_IDENTIFIER** is defined in "Related Definitions" below.

### Description

This function returns the user identifier of the user authenticated by this credential provider. This function is called after the credential-related information has been submitted on a form OR after a call to Default() has returned that this credential is ready to log on.

This function can return one of five possible responses:

- If no user profile can yet be identified, then **EFI\_NOT\_READY** is returned.
- If the user has been locked out, then **EFI\_ACCESS\_DENIED** is returned.
- If the user specified by *User* is identified, then Identifier returns with the user identifier associated with that handle and **EFI\_SUCCESS** is returned.
- If *Identifier* is **NULL**, then **EFI\_INVALID\_PARAMETER** is returned.
- If specified *User* does not refer to a valid user profile, then **EFI\_NOT\_FOUND** is returned.

### Status Codes Returned

EFI_SUCCESS	User identifier returned successfully.
-------------	--

EFI_NOT_READY	No user identifier can be returned.
EFI_ACCESS_DENIED	The user has been locked out of this user credential.
EFI_NOT_FOUND	<i>User</i> is not <b>NULL</b> , and the specified user handle can't be found in user profile database
EFI_INVALID_PARAMETER	<i>Identifier</i> is <b>NULL</b> .

## EFI\_USER\_CREDENTIAL2\_PROTOCOL.Select()

### Summary

Indicate that user interface interaction has begun for the specified credential.

### Prototype

```
typedef
EFI_STATUS
(EFIAPI *EFI_CREDENTIAL_SELECT)(
  IN CONST EFI_USER_CREDENTIAL2_PROTOCOL *This,
  OUT EFI_CREDENTIAL_LOGON_FLAGS *AutoLogon
);
```

### Parameters

*This*

Points to this instance of the **EFI\_USER\_CREDENTIAL2\_PROTOCOL**.

*AutoLogon*

On return, points to the credential provider's capabilities after the credential provider has been selected by the user. Type **EFI\_CREDENTIAL\_LOGON\_FLAGS** is defined in "Related Definitions" below.

### Description

This function is called when a credential provider is selected by the user. If *AutoLogon* returns **FALSE**, then the user interface will be constructed by the User Identity Manager.

### Related Definitions

```
typedef UINT32 EFI_CREDENTIAL_LOGON_FLAGS;
```

```
#define EFI_CREDENTIAL_LOGON_FLAG_AUTO 0x00000001
```

```
#define EFI_CREDENTIAL_LOGON_FLAG_DEFAULT 0x00000002
```

If **EFI\_CREDENTIAL\_LOGON\_FLAG\_AUTO** is set, then the User Identity Manager may use this as a hint to try logging on immediately. If not set, then the User Identity Manager may use this as an indication to wait for the user to submit the information.

If **EFI\_CREDENTIAL\_LOGON\_FLAG\_DEFAULT** is set, then the User Identity Manager may use this as a hint to use this credential provider as the default credential provider. If more than one credential provider returns with this set, then the selection is implementation specific. If **EFI\_CREDENTIAL\_LOGON\_FLAG\_DEFAULT** is set and **EFI\_CREDENTIAL\_LOGON\_FLAG\_AUTO** is set then the User Identity Manager may use this as a hint to log the user on immediately.

### Status Codes Returned

EFI_SUCCESS	Credential provider successfully selected.
EFI_INVALID_PARAMETER	<i>AutoLogon</i> is <b>NULL</b>

## EFI\_USER\_CREDENTIAL2\_PROTOCOL.Deselect()

### Summary

Indicate that user interface interaction has ended for the specified credential.

### Prototype

```
typedef
EFI_STATUS
(EFIAPI *EFI_CREDENTIAL2_DESELECT)(
  IN CONST EFI_USER_CREDENTIAL2_PROTOCOL *This
);
```

### Parameters

*This*

Points to this instance of the **EFI\_USER\_CREDENTIAL2\_PROTOCOL**.

### Description

This function is called when a credential provider is deselected by the user.

### Status Codes Returned

EFI_SUCCESS	Credential provider successfully selected.
-------------	--

## EFI\_USER\_CREDENTIAL2\_PROTOCOL.Default()

### Summary

Return the default logon behavior for this user credential.

### Prototype

```
typedef
EFI_STATUS
(EFIAPI *EFI_CREDENTIAL_DEFAULT)(
  IN CONST EFI_USER_CREDENTIAL2_PROTOCOL *This,
  OUT EFI_CREDENTIAL_LOGON_FLAGS *AutoLogon
);
```

### Parameters

*This*

Points to this instance of the **EFI\_USER\_CREDENTIAL2\_PROTOCOL**.

*AutoLogon*

On return, holds whether the credential provider should be used by default to automatically log on the user. Type **EFI\_CREDENTIAL\_LOGON\_FLAGS** is defined in **EFI\_USER\_CREDENTIAL2\_PROTOCOL.Select()**.

### Description

This function reports the default login behavior regarding this credential provider.

### Status Codes Returned

EFI_SUCCESS	Default information successfully returned.
EFI_INVALID_PARAMETER	<i>AutoLogon</i> is <b>NULL</b>

## EFI\_USER\_CREDENTIAL2\_PROTOCOL.GetInfo()

### Summary

Return information attached to the credential provider.

### Prototype

```
typedef
EFI_STATUS
(EFIAPI *EFI_CREDENTIAL2_GET_INFO)(
  IN CONST EFI_USER_CREDENTIAL2_PROTOCOL *This,
  IN EFI_USER_INFO_HANDLE UserInfo,
  OUT EFI_USER_INFO *Info,
  IN OUT UINTN *InfoSize
);
```

### Parameters

*This*

Points to this instance of the **EFI\_USER\_CREDENTIAL2\_PROTOCOL**.

*UserInfo*

Handle of the user information data record. Type **EFI\_USER\_INFO\_HANDLE** is defined in **GetInfo()**.

*Info*

On entry, points to a buffer of at least *InfoSize* bytes. On exit, holds the user information. If the buffer is too small to hold the information, then **EFI\_BUFFER\_TOO\_SMALL** is returned and *InfoSize* is updated to contain the number of bytes actually required. Type **EFI\_USER\_INFO** is described in “Related Definitions” below.

*InfoSize*

On entry, points to the size of *Info*. On return, points to the size of the user information.

### Description

This function returns user information.

### Status Codes Returned

EFI_SUCCESS	Information returned successfully.
EFI_BUFFER_TOO_SMALL	The size specified by <i>InfoSize</i> is too small to hold all of the user information. The size required is returned in <i>*InfoSize</i> .
EFI_NOT_FOUND	The specified UserInfo does not refer to a valid user info handle
EFI_INVALID_PARAMETER	<i>Info</i> is <b>NULL</b> or <i>InfoSize</i> is <b>NULL</b>

## EFI\_USER\_CREDENTIAL2\_PROTOCOL.GetNextInfo()

### Summary

Enumerate all of the user information records on the credential provider..

### Prototype

```
typedef
EFI_STATUS
(EFIAPI *EFI_USER_CREDENTIAL_GET_NEXT_INFO)(
  IN CONST EFI_USER_CREDENTIAL2_PROTOCOL *This,
  IN OUT EFI_USER_INFO_HANDLE *UserInfo
);
```

### Parameters

*This*

Points to the instance of this **EFI\_USER\_CREDENTIAL2\_PROTOCOL**.

*UserInfo*

On entry, points to the previous user information handle or NULL to start enumeration. On exit, points to the next user information handle or NULL if there is no more user information.

### Description

This function returns the next user information record. To retrieve the first user information record handle, point *UserInfo* at a NULL. Each subsequent call will retrieve another user information record handle until there are no more, at which point *UserInfo* will point to **NULL**.

### Status Codes Returned

EFI_SUCCESS	User information returned.
EFI_NOT_FOUND	No more user information found.
EFI_INVALID_PARAMETER	<i>UserInfo</i> is <b>NULL</b> .



## EFI\_USER\_CREDENTIAL2\_PROTOCOL.Delete()

### Summary

Delete a user on a credential provider.

### Prototype

```
typedef
EFI_STATUS (EFIAPI *EFI_CREDENTIAL_DELETE)(
  IN CONST EFI_USER_CREDENTIAL2_PROTOCOL *This,
  IN EFI_USER_PROFILE_HANDLE    User
);
```

### Parameters

*This*

Points to this instance of the **EFI\_USER\_CREDENTIAL2\_PROTOCOL**.

*User*

The user profile handle to delete.

### Description

This function deletes a user on this credential provider.

### Status Codes Returned

EFI_SUCCESS	User profile was successfully deleted .
EFI_ACCESS_DENIED	Current user profile does not permit deletion on the user profile handle. Either the user profile cannot delete on any user profile or cannot delete on a user profile other than the current user profile.
EFI_UNSUPPORTED	This credential provider does not support deletion in the pre-OS.
EFI_DEVICE_ERROR	The new credential could not be deleted because of a device error.
EFI_INVALID_PARAMETER	User does not refer to a valid user profile handle.

## 35.3.3 Deferred Image Load Protocol

### EFI\_DEFERRED\_IMAGE\_LOAD\_PROTOCOL

#### Summary

Enumerates images whose load was deferred due to security considerations.

## GUID

```
#define EFI_DEFERRED_IMAGE_LOAD_PROTOCOL_GUID \
{ 0x15853d7c, 0x3ddf, 0x43e0, \
  { 0xa1, 0xcb, 0xeb, 0xf8, 0x5b, 0x8f, 0x87, 0x2c } };
```

## Protocol Interface Structure

```
typedef struct _EFI_DEFERRED_IMAGE_LOAD_PROTOCOL {
  EFI_DEFERRED_IMAGE_INFO GetImageInfo();
} EFI_DEFERRED_IMAGE_LOAD_PROTOCOL;
```

## Members

### *GetImageInfo*

Return information about a single deferred image. See `GetImageInfo()` for more information.

## Description

This protocol returns information about images whose load was denied because of security considerations. This information can be used by the Boot Manager or another agent to reevaluate the images when the current security profile has been changed, such as when the current user profile changes. There can be more than one instance of this protocol installed.

## EFI\_DEFERRED\_IMAGE\_LOAD\_PROTOCOL.GetImageInfo()

### Summary

Returns information about a deferred image.

### Prototype

```
typedef
EFI_STATUS
(EFI_API *EFI_DEFERRED_IMAGE_INFO)(
  IN EFI_DEFERRED_IMAGE_LOAD_PROTOCOL *This,
  IN UINTN      ImageIndex,
  OUT EFI_DEVICE_PATH_PROTOCOL  **ImageDevicePath,
  OUT VOID      **Image,
  OUT UINTN     *ImageSize,
  OUT BOOLEAN   *BootOption
);
```

### Parameters

*This*

Points to this instance of the **EFI\_DEFERRED\_IMAGE\_LOAD\_PROTOCOL**.

*ImageIndex*

Zero-based index of the deferred index.

*ImageDevicePath*

On return, points to a pointer to the device path of the image. The device path should not be freed by the caller.

*Image*

On return, points to the first byte of the image or **NULL** if the image is not available. The image should not be freed by the caller unless **LoadImage()** has been called successfully.

*ImageSize*

On return, the size of the image, or 0 if the image is not available.

*BootOption*

On return, points to **TRUE** if the image was intended as a boot option or **FALSE** if it was not intended as a boot option.

### Description

This function returns information about a single deferred image. The deferred images are numbered consecutively, starting with 0. If there is no image which corresponds to *ImageIndex*, then **EFI\_NOT\_FOUND** is returned. , All deferred images may be returned by iteratively calling this function until **EFI\_NOT\_FOUND** is returned.

*Image* may be **NULL** and *ImageSize* set to 0 if the decision to defer execution was made because of the location of the executable image rather than its actual contents.

## Status Codes Returned

EFI_SUCCESS	Image information returned successfully.
EFI_NOT_FOUND	ImageIndex does not refer to a valid image.
EFI_INVALID_PARAMETER	<i>ImageDevicePath</i> is <b>NULL</b> or <i>Image</i> is <b>NULL</b> or <i>ImageSize</i> is <b>NULL</b> or <i>BootOption</i> is <b>NULL</b>

## 35.4 User Information

This section describes the different user information and the format of the data. Each of the following records is prefixed with the **EFI\_USER\_INFO** structure. The format of the record is determined by the type specified by the *InfoType* field in the structure, as listed in the table below:

Table 220. Record values and descriptions

Name	Value	Description
<b>EFI_USER_INFO_EMPTY_RECORD</b>	0x00	No information.
<b>EFI_USER_INFO_NAME_RECORD</b>	0x01	User's name
<b>EFI_USER_INFO_CREATE_DATE_RECORD</b>	0x02	Date which the user profile was created.
<b>EFI_USER_INFO_USAGE_DATE_RECORD</b>	0x03	Date which the user profile was last modified.
<b>EFI_USER_INFO_USAGE_COUNT_RECORD</b>	0x04	Number of times the credential has been used.
<b>EFI_USER_INFO_IDENTIFIER_RECORD</b>	0x05	User's unique identifier *
<b>EFI_USER_INFO_CREDENTIAL_TYPE_RECORD</b>	0x06	Credential type.
<b>EFI_USER_INFO_CREDENTIAL_TYPE_NAME_RECORD</b>	0x07	Credential type name.
<b>EFI_USER_INFO_CREDENTIAL_PROVIDER_RECORD</b>	0x08	Credential provider
<b>EFI_USER_INFO_CREDENTIAL_PROVIDER_NAME_RECORD</b>	0x09	Credential provider name
<b>EFI_USER_INFO_PKCS11_RECORD</b>	0x0A	PKCS11 Data Object
<b>EFI_USER_INFO_CBEFF_RECORD</b>	0x0B	ISO 19785 (Common Biometric Exchange Formats Framework) Data Object
<b>EFI_USER_INFO_FAR_RECORD</b>	0x0C	How exact a match is required for biometric identification, measured in percentage.
<b>EFI_USER_INFO_RETRY_RECORD</b>	0x0D	Number of retries allowed during verification.
<b>EFI_USER_INFO_ACCESS_POLICY_RECORD</b>	0x0E	Access control information.
<b>EFI_USER_INFO_IDENTITY_POLICY_RECORD</b>	0x0F	User identity expression.
<b>EFI_USER_INFO_GUID_RECORD</b>	0xFF	Extended profile information, qualified by a GUID in the header.

### 35.4.1 EFI\_USER\_INFO\_ACCESS\_POLICY\_RECORD

#### Summary

Provides the user's pre-OS access rights.

## Prototype

```
#define EFI_USER_INFO_ACCESS_POLICY_RECORD 0x0E

typedef EFI_USER_INFO_ACCESS_CONTROL EFI_USER_INFO_ACCESS_POLICY;
```

## Description

This structure described the access policy for the user. There can be, at most, one access policy record per credential (including **NULL** credential). Policy records with a credential specified means that the policy is associated specifically with the credential.

The policy is detailed in a series of encapsulated records of type **EFI\_USER\_INFO\_ACCESS\_CONTROL**.

## Related Definitions

```
typedef struct {
    UINT32 Type;
    UINT32 Size;
} EFI_USER_INFO_ACCESS_CONTROL;
```

### *Type*

Specifies the type of user access control. See **EFI\_USER\_INFO\_ACCESS\_x** for more information.

### *Size*

Specifies the size of the user access control record, in bytes, including this header.

### 35.4.1.1 EFI\_USER\_INFO\_ACCESS\_FORBID\_LOAD

## Summary

Forbids the user from booting or loading executables from the specified device path or any child device paths.

## Prototype

```
#define EFI_USER_INFO_ACCESS_FORBID_LOAD 0x00000001
```

## Description

This record prohibits the user from loading any executables from zero or device paths or any child device paths. The device paths may contain a specific executable name, in which case the prohibition applies to only that executable.

The record is a series of normal UEFI device paths (not multi-instance device paths).

This prohibition is overridden by the **EFI\_USER\_INFO\_ACCESS\_PERMIT\_LOAD** record.

### 35.4.1.2 EFI\_USER\_INFO\_ACCESS\_PERMIT\_LOAD

#### Summary

Permits the user from booting or loading executables from the specified device path or any child device paths.

#### Prototype

```
#define EFI_USER_INFO_ACCESS_PERMIT_LOAD 0x00000002
```

#### Description

This record allows the user to load executables from locations specified by zero or more device paths or child paths. The device paths may contain specific executable names, in which case, the permission applies only to that executable.

The record is a series of normal UEFI device paths (not multi-instance device paths).

This prohibition overrides any restrictions put in place by the **EFI\_USER\_INFO\_ACCESS\_FORBID\_LOAD** record.

### 35.4.1.3 EFI\_USER\_INFO\_ACCESS\_ENROLL\_SELF

#### Summary

Presence of this record indicates that a user can update enrollment information.

#### Prototype

```
#define EFI_USER_INFO_ACCESS_ENROLL_SELF 0x00000003
```

#### Description

If this record is present, then the pre-OS environment will allow the user to initiate an update of authentication information for his/her own profile, but not other user information or other user's information. This would allow, for example, fingerprint update or password change.

There is no data for this record.

### 35.4.1.4 EFI\_USER\_INFO\_ACCESS\_ENROLL\_OTHERS

#### Summary

Presence of this record indicates that a user can enroll new users.

#### Prototype

```
#define EFI_USER_INFO_ACCESS_ENROLL_OTHERS 0x00000004
```

#### Description

If this record is present, then the pre-OS environment will allow the user to initiate enrollment of new user profiles. It does not give permission to update existing user profiles.

There is no data for this record.

#### 35.4.1.5 EFI\_USER\_INFO\_ACCESS\_MANAGE

##### Summary

Presence of this record indicates that a user can update the user information of any user.

##### Prototype

```
#define EFI_USER_INFO_ACCESS_MANAGE 0x00000005
```

##### Description

If this record is present, then the pre-OS environment will allow the user to update any information about his/her own profile or other profiles.

There is no data for this record.

#### 35.4.1.6 EFI\_USER\_INFO\_ACCESS\_SETUP

##### Summary

Describes permissions usable when configuring the platform.

##### Prototype

```
#define EFI_USER_INFO_ACCESS_SETUP 0x00000006
```

##### Description

This record describes access permission for use in configuring the platform using an UEFI Forms Processor using zero or more GUIDs. There are three standard values (see below) and any number of others may be added.



Table 221. Standard values for access to configure the platform

<b>EFI_USER_INFO_ACCESS_SETUP_ADMIN_GUID</b>	System administrator only.
<b>EFI_USER_INFO_ACCESS_SETUP_NORMAL_GUID</b>	Normal user.
<b>EFI_USER_INFO_ACCESS_SETUP_RESTRICTED_GUID</b>	Restricted user.

## Related Definitions

```
#define EFI_USER_INFO_ACCESS_SETUP_ADMIN_GUID \
{ 0x85b75607, 0xf7ce, 0x471e, \
{ 0xb7, 0xe4, 0x2a, 0xea, 0x5f, 0x72, 0x32, 0xee } };
```

```
#define EFI_USER_INFO_ACCESS_SETUP_NORMAL_GUID \
{ 0x1db29ae0, 0x9dcb, 0x43bc, \
{ 0x8d, 0x87, 0x5d, 0xa1, 0x49, 0x64, 0xdd, 0xe2 } };
```

```
#define EFI_USER_INFO_ACCESS_SETUP_RESTRICTED_GUID \
{ 0xbdb38125, 0x4d63, 0x49f4, \
{ 0x82, 0x12, 0x61, 0xcf, 0x5a, 0x19, 0x0a, 0xf8 } };
```

### 35.4.1.7 EFI\_USER\_INFO\_ACCESS\_FORBID\_CONNECT

#### Summary

Forbids UEFI drivers from being started from the specified device path(s) or any child device paths.

#### Prototype

```
#define EFI_USER_INFO_ACCESS_FORBID_CONNECT 0x00000007
```

#### Description

This record prohibits UEFI drivers from being started from the specified device path(s) or any of their child device path(s). This is enforced in the **ConnectController()** function.

This record prohibits the user from loading a device driver associated with zero or more device paths or their child paths.

The record is a series of normal UEFI device paths (not multi-instance device paths).

This prohibition is overridden by the **EFI\_USER\_INFO\_ACCESS\_PERMIT\_CONNECT** record.

### 35.4.1.8 EFI\_USER\_INFO\_ACCESS\_PERMIT\_CONNECT

#### Summary

Permits UEFI drivers to be started on the specified device path(s) or any child device paths.

## Prototype

```
#define EFI_USER_INFO_ACCESS_PERMIT_CONNECT 0x00000008
```

## Description

This record allows loading of device drivers associated with zero or more device paths or their child paths.

The record is a series of normal UEFI device paths (not multi-instance device paths).

This prohibition overrides any restrictions put in place by the **EFI\_USER\_INFO\_ACCESS\_FORBID\_CONNECT** record.

### 35.4.1.9 EFI\_USER\_INFO\_ACCESS\_BOOT\_ORDER

## Summary

Modifies the boot order.

## Prototype

```
#define EFI_USER_INFO_ACCESS_BOOT_ORDER 0x00000009
```

```
typedef UINT32 EFI_USER_INFO_ACCESS_BOOT_ORDER_HDR;
```

```
#define EFI_USER_INFO_ACCESS_BOOT_ORDER_MASK 0x000F
```

```
#define EFI_USER_INFO_ACCESS_BOOT_ORDER_INSERT 0x0000
```

```
#define EFI_USER_INFO_ACCESS_BOOT_ORDER_APPEND 0x0001
```

```
#define EFI_USER_INFO_ACCESS_BOOT_ORDER_REPLACE 0x0002
```

```
#define EFI_USER_INFO_ACCESS_BOOT_ORDER_NODEFAULT 0x0010
```

## Description

This exclusive record allows the user profile to insert new boot options at the beginning of the boot order (**EFI\_USER\_INFO\_ACCESS\_BOOT\_ORDER\_INSERT**), append new boot options to the end of the boot order

(**EFI\_USER\_INFO\_ACCESS\_BOOT\_ORDER\_APPEND**) or replace the entire boot order (**EFI\_USER\_INFO\_ACCESS\_BOOT\_ORDER\_REPLACE**). If

**EFI\_USER\_INFO\_ACCESS\_BOOT\_ORDER\_NODEFAULT** is specified then the Boot Manager will not attempt find a default boot device when the default boot order is does not lead to a bootable device.

The boot options specified by this record are still subject to the permissions specified by **EFI\_USER\_INFO\_ACCESS\_FORBID\_LOAD** and **EFI\_USER\_INFO\_ACCESS\_PERMIT\_LOAD**.

The record consists of a single **EFI\_USER\_INFO\_ACCESS\_BOOT\_ORDER\_HDR** followed by zero or more UEFI device paths.

### 35.4.2 EFI\_USER\_INFO\_CBEFF\_RECORD

#### Summary

Provides standard biometric information in the format specified by the ISO 19785 (Common Biometric Exchange Formats Framework) specification.

#### Prototype

```
#define EFI_USER_INFO_CBEFF_RECORD 0x0B
typedef VOID *EFI_USER_INFO_CBEFF;
```

### 35.4.3 EFI\_USER\_INFO\_CREATE\_DATE\_RECORD

#### Summary

Provides the date and time when the user profile was created.

#### Prototype

```
#define EFI_USER_INFO_CREATE_DATE_RECORD 0x02
typedef EFI_TIME EFI_USER_INFO_CREATE_DATE;
```

#### Description

The optional record describing the date and time when the user profile was created. Type **EFI\_TIME** is defined in [GetTime\(\)](#) in this specification.

### 35.4.4 EFI\_USER\_INFO\_CREDENTIAL\_PROVIDER\_RECORD

#### Summary

Specifies the credential provider.

#### Prototype

```
#define EFI_USER_INFO_CREDENTIAL_PROVIDER_RECORD 0x08
typedef EFI_GUID EFI_USER_INFO_CREDENTIAL_PROVIDER;
```

#### Description

This record specifies the credential provider via a unique GUID. The credential's handle is found in the **EFI\_USER\_INFO** structure associated with this user information record.

### 35.4.5 EFI\_USER\_INFO\_CREDENTIAL\_PROVIDER\_NAME\_RECORD

#### Summary

Specifies the user-readable name of a particular credential's provider.

### Prototype

```
#define EFI_USER_INFO_CREDENTIAL_PROVIDER_NAME_RECORD 0x09
typedef CHAR16 *EFI_USER_INFO_CREDENTIAL_PROVIDER_NAME;
```

### Description

This record specifies the null-terminated name of a particular credential provider. The credential's handle is found in the **EFI\_USER\_INFO** structure associated with this user information record.

## 35.4.6 EFI\_USER\_INFO\_CREDENTIAL\_TYPE\_RECORD

### Summary

Specifies the type of a particular credential associated with the user profile.

### Prototype

```
#define EFI_USER_INFO_CREDENTIAL_TYPE_RECORD 0x06
typedef EFI_GUID EFI_USER_INFO_CREDENTIAL_TYPE;
```

### Description

This record specifies the type of a particular credential. The credential's identifier is found in the *Credential* field of the **EFI\_USER\_INFO** structure. The credential types are listed with the **EFI\_USER\_CREDENTIAL2\_PROTOCOL**.

## 35.4.7 EFI\_USER\_INFO\_CREDENTIAL\_TYPE\_NAME\_RECORD

### Summary

Specifies the user-readable name of a particular credential type.

### Prototype

```
#define EFI_USER_INFO_CREDENTIAL_TYPE_NAME_RECORD 0x07
typedef CHAR16 *EFI_USER_INFO_CREDENTIAL_TYPE_NAME;
```

### Description

This record specifies the null-terminated name of a particular credential type. The credential's handle is found in the **EFI\_USER\_INFO** structure associated with this user information record.

## 35.4.8 EFI\_USER\_INFO\_GUID\_RECORD

### Summary

Provides placeholder for additional user profile information identified by a GUID.

## Prototype

```
#define EFI_USER_INFO_GUID_RECORD 0xFF
typedef EFI_GUID EFI_USER_INFO_GUID;
```

## Description

This record type provides extensibility by prefixing further data fields in the record with a GUID which identifies the format.

### 35.4.9 EFI\_USER\_INFO\_FAR\_RECORD

#### Summary

Indicates how close of a match the fingerprint must be in order to be considered a match.

#### Prototype

```
#define EFI_USER_INFO_FAR_RECORD 0x0C
typedef UINT8 EFI_USER_INFO_FAR;
```

#### Description

This record specifies how accurate the fingerprint template match must be in order to be considered a match, as a percentage from 0 (no match) to 100 (perfect match). The accuracy may be for all fingerprint sensors (*EFI\_USER\_INFO.Credential* is zero) or for a particular fingerprint sensor (*EFI\_USER\_INFO.Credential* is non-zero).

#### Access:

Exclusive:No

Modify:Only with user-enrollment permissions.

Visibility:Public

### 35.4.10 EFI\_USER\_INFO\_IDENTIFIER\_RECORD

#### Summary

Provides a unique non-volatile user identifier for each enrolled user.

#### Prototype

```
#define EFI_USER_INFO_IDENTIFIER_RECORD 0x05
typedef UINT8 EFI_USER_INFO_IDENTIFIER[16];
```

#### Description

The user identifier is unique to each enrolled user and non-volatile. Each user profile must have exactly one of these user information records installed. The format of the value is not specified.

**Access**

Exclusive:Yes

Modify:Only with user-enrollment permissions.

Visibility:Public.

**35.4.11 EFI\_USER\_INFO\_IDENTITY\_POLICY\_RECORD****Summary**

Provides the expression which determines which credentials are required to assert user identity.

**Prototype**

```
#define EFI_USER_INFO_IDENTITY_POLICY_RECORD 0x0F
typedef struct {
    UINT32 Type;
    UINT32 Length;
} EFI_USER_INFO_IDENTITY_POLICY;
```

**Parameters***Type*

Specifies either an operator or a data item. See **EFI\_USER\_INFO\_IDENTITY\_x** in “Related Definitions” below.

*Length*

The length of this block, in bytes, including this header.

**Description**

The user identity policy is an expression made up of operators and data items. If the expression evaluates to **TRUE**, then this user profile can be selected as the current profile. If the expression evaluates to **FALSE**, then this user profile cannot be selected as the current profile.

Data items are pushed onto an expression stack. Operators pop items off of the expression stack, perform an operator and push the results back.

**Note:** *If there is no user identity policy set for a user profile, then FALSE is assumed.*

**Access**

Exclusive:Yes

Modify:Only with user-enrollment permissions.

Visibility:Public.

## Related Definitions

```
#define EFI_USER_INFO_IDENTITY_FALSE    0x00
#define EFI_USER_INFO_IDENTITY_TRUE     0x01
#define EFI_USER_INFO_IDENTITY_CREDENTIAL_TYPE  0x02
#define EFI_USER_INFO_IDENTITY_CREDENTIAL_PROVIDER 0x03
#define EFI_USER_INFO_IDENTITY_NOT      0x10
#define EFI_USER_INFO_IDENTITY_AND      0x11
#define EFI_USER_INFO_IDENTITY_OR       0x12
```

Type Name	Description
<b>EFI_USER_INFO_IDENTITY_FALSE</b>	Push <b>FALSE</b> on to the expression stack.
<b>EFI_USER_INFO_IDENTITY_TRUE</b>	Push <b>TRUE</b> on to the expression stack.
<b>EFI_USER_INFO_IDENTITY_CREDENTIAL_- TYPE</b>	If a credential provider with the specified class asserts the user's identity, push <b>TRUE</b> . Otherwise push <b>FALSE</b> . The <b>EFI_USER_INFO_IDENTITY_POLICY</b> structure is followed immediately by a GUID.
<b>EFI_USER_INFO_IDENTITY_CREDEN- TIAL_PROVIDER</b>	If a credential provider with the specified provider identifier asserts the user's identity, push <b>TRUE</b> . Otherwise, push <b>FALSE</b> . The <b>EFI_USER_INFO_IDENTITY_POLICY</b> structure is followed immediately by a GUID.
<b>EFI_USER_INFO_IDENTITY_NOT</b>	Pop a boolean off the stack. If <b>TRUE</b> , then push <b>FALSE</b> . If <b>FALSE</b> , then push <b>TRUE</b> .
<b>EFI_USER_INFO_IDENTITY_AND</b>	Pop two Booleans off the stack. If both are <b>TRUE</b> , then push <b>TRUE</b> . Otherwise push <b>FALSE</b> .
<b>EFI_USER_INFO_IDENTITY_OR</b>	Pop two Booleans off the stack. If either is <b>TRUE</b> , then push <b>TRUE</b> . Otherwise push <b>FALSE</b> .

### 35.4.12 EFI\_USER\_INFO\_NAME\_RECORD

#### Summary

Provide the user's name for the enrolled user.

## Prototype

```
#define EFI_USER_INFO_NAME_RECORD 0x01
typedef CHAR16 *EFI_USER_INFO_NAME;
```

## Description

The user's name is a NULL-terminated string.

## Access

Exclusive:Yes

Visibility:Public.

## 35.4.13 EFI\_USER\_INFO\_PKCS11\_RECORD

### Summary

Provides PKCS#11 credential information from a smart card.

### Prototype

```
#define EFI_USER_INFO_PKCS11_RECORD 0x0A
```

## 35.4.14 EFI\_USER\_INFO\_RETRY\_RECORD

### Summary

Indicates how many attempts the user has to with a particular credential before the system prevents further attempts.

### Prototype

```
#define EFI_USER_INFO_RETRY_RECORD 0x0D
typedef UINT8 EFI_USER_INFO_RETRY;
```

### Description

This record indicates the number of times the user may fail identification with all credential providers (**EFI\_USER\_INFO.Credential** is zero) or a particular credential provider (**EFI\_USER\_INFO.Credential** is non-zero).

### Access:

Exclusive:No

Modify:Only with user-enrollment permissions.

Visibility:Public



### 35.4.15 EFI\_USER\_INFO\_USAGE\_DATE\_RECORD

#### Summary

Provides the date and time when the user profile was selected.

#### Prototype

```
#define EFI_USER_INFO_USAGE_DATE_RECORD 0x03
typedef EFI_TIME EFI_USER_INFO_USAGE_DATE;
```

#### Description

The optional record describing the date and time when the user profile was last selected. Type **EFI\_TIME** is defined in [GetTime\(\)](#) in this specification.

### 35.4.16 EFI\_USER\_INFO\_USAGE\_COUNT\_RECORD

#### Summary

Provides the number of times that the user profile has been selected.

#### Prototype

```
#define EFI_USER_INFO_USAGE_COUNT 0x04
typedef UINT64 EFI_USER_INFO_USAGE_COUNT;
```

#### Description

The optional record describing the number of times that the user profile was selected.

## 35.5 User Information Table

#### Summary

A collection of **EFI\_USER\_INFO** records, prefixed with this header.

#### Prototype

```
typedef struct {
    UINT64 Size;
} EFI_USER_INFO_TABLE;
```

#### Members

*Size*

Total size of the user information table, in bytes.

#### Description

This header is followed by a series of records. Each record is prefixed by the **EFI\_USER\_INFO** structure. The total size of this header and all records is equal to *Size*.



## 36 Secure Technologies

---

### 36.1 Hash Overview

For the purposes of this specification, a hash function takes a variable length input and generates a fixed length hash value. In general, hash functions are *collision-resistant*, which means that it is infeasible to find two distinct inputs which produce the same hash value. Hash functions are generally *one-way* which means that it is infeasible to find an input based on the output hash value.

This specification describes a protocol which allows a driver to produce a protocol which supports zero or more hash functions.

#### 36.1.1 Hash References

The following references define the standard means of creating the hashes used in this specification:

Secure Hash Standard (SHS) (FIPS PUB 180-3), National Institute of Standards and Technology (October 2008).

For more information

- see “Links to UEFI-Related Documents” (<http://uefi.org/uefi>) under the heading “Archived FIPS publication”.
- see “Links to UEFI-Related Documents” (<http://uefi.org/uefi>) under the heading “MD5 Message-Digest Algorithm”. EFI Hash Protocols

### EFI\_HASH\_SERVICE\_BINDING\_PROTOCOL

#### Summary

The EFI Hash Service Binding Protocol is used to locate hashing services support provided by a driver and create and destroy instances of the EFI Hash Protocol so that multiple drivers can use the underlying hashing services.

The EFI Service Binding Protocol that is defined in [Section 2.5.8](#) defines the generic Service Binding Protocol functions. This section discusses the details that are specific to the EFI Hash Protocol.

#### GUID

```
#define EFI_HASH_SERVICE_BINDING_PROTOCOL_GUID \
{0x42881c98,0xa4f3,0x44b0,\
{0xa3,0x9d,0xdf,0xa1,0x86,0x67,0xd8,0xcd}}
```

#### Description

An application (or driver) that requires hashing services can use one of the protocol handler services, such as **BS->LocateHandleBuffer()**, to search for devices that publish an EFI Hash Service Binding Protocol.

After a successful call to the `EFI_HASH_SERVICE_BINDING_PROTOCOL.CreateChild()` function, the child EFI Hash Protocol driver instance is ready for use. The instance of `EFI_HASH_PROTOCOL` must be obtained by performing `HandleProtocol()` against the handle returned by `CreateChild()`. Use of other methods, such as `LocateHandle()`, are not supported.

Once obtained, the driver may use the `EFI_HASH_PROTOCOL` instance for any number of non-overlapping hash operations. Overlapping hash operations require an additional call to `EFI_HASH_SERVICE_BINDING_PROTOCOL.CreateChild()` for a new instance.

Before a driver or application terminates execution, every successful call to the `EFI_HASH_SERVICE_BINDING_PROTOCOL.CreateChild()` function must be matched with a call to the `EFI_HASH_SERVICE_BINDING_PROTOCOL.DestroyChild()` function.

## EFI\_HASH\_PROTOCOL

### Summary

This protocol describes standard hashing functions.

### GUID

```
#define EFI_HASH_PROTOCOL_GUID \
  {0xc5184932,0xdba5,0x46db,\
   {0xa5,0xba,0xcc,0x0b,0xda,0x9c,0x14,0x35}}
```

### Protocol Interface Structure

```
typedef _EFI_HASH_PROTOCOL {
  EFI_HASH_GET_HASH_SIZE GetHashSize;
  EFI_HASH_HASH Hash;
} EFI_HASH_PROTOCOL;
```

### Parameters

<i>GetHashSize</i>	Return the size of a specific type of resulting hash.
<i>Hash</i>	Create a hash for the specified message.

### Description

This protocol allows creating a hash of an arbitrary message digest using one or more hash algorithms. The *GetHashSize* returns the expected size of the hash for a particular algorithm and whether or not that algorithm is, in fact, supported. The *Hash* actually creates a hash using the specified algorithm.

### Related Definitions

None.

## EFI\_HASH\_PROTOCOL.GetHashSize()

### Summary

Returns the size of the hash which results from a specific algorithm.

### Prototype

```
EFI_STATUS
EFIAPI
GetHashSize(
  IN CONST EFI_HASH_PROTOCOL *This,
  IN CONST EFI_GUID *HashAlgorithm,
  OUT UINTN *HashSize
);
```

### Parameters

<i>This</i>	Points to this instance of <b>EFI_HASH_PROTOCOL</b> .
<i>HashAlgorithm</i>	Points to the <b>EFI_GUID</b> which identifies the algorithm to use. See <a href="#">Section 36.1.2.1</a> .
<i>HashSize</i>	Holds the returned size of the algorithm's hash.

### Description

This function returns the size of the hash which will be produced by the specified algorithm.

### Related Definitions

**None**

### Status Codes Returned

EFI_SUCCESS	Hash size returned successfully.
EFI_INVALID_PARAMETER	<i>HashSize</i> is <b>NULL</b> or <i>HashAlgorithm</i> is <b>NULL</b> .
EFI_UNSUPPORTED	The algorithm specified by <i>HashAlgorithm</i> is not supported by this driver.

## EFI\_HASH\_PROTOCOL.Hash()

### Summary

Creates a hash for the specified message text.

### Prototype

```

EFI_STATUS
EFIAPI
Hash(
  IN CONST EFI_HASH_PROTOCOL *This,
  IN CONST EFI_GUID *HashAlgorithm,
  IN BOOLEAN Extend,
  IN CONST UINT8 *Message,
  IN UINT64 MessageSize,
  IN OUT EFI_HASH_OUTPUT *Hash
);

```

### Parameters

<i>This</i>	Points to this instance of <b>EFI_HASH_PROTOCOL</b> .
<i>HashAlgorithm</i>	Points to the <b>EFI_GUID</b> which identifies the algorithm to use. See <a href="#">Section 36.1.2.1</a> .
<i>Extend</i>	Specifies whether to create a new hash ( <b>FALSE</b> ) or extend the specified existing hash ( <b>TRUE</b> ).
<i>Message</i>	Points to the start of the message.
<i>MessageSize</i>	The size of <i>Message</i> , in bytes. Must be integer multiple of block size.
<i>Hash</i>	On input, if <i>Extend</i> is <b>TRUE</b> , then this parameter holds a pointer to a pointer to an array containing the hash to extend. If <i>Extend</i> is <b>FALSE</b> , then this parameter holds a pointer to a pointer to a caller-allocated array that will receive the result of the hash computation. On output (regardless of the value of <i>Extend</i> ), the array will contain the result of the hash computation.

### Description

This function creates the hash of the specified message text based on the specified algorithm *HashAlgorithm* and copies the result to the caller-provided buffer *Hash*. If *Extend* is **TRUE**, then the hash specified on input by *Hash* is extended. If *Extend* is **FALSE**, then the starting hash value will be that specified by the algorithm.

**Note:** For the all algorithms used with **EFI\_HASH\_PROTOCOL**, the following apply:

- The **EFI\_HASH\_PROTOCOL.Hash()** function does not perform padding of message data for these algorithms. Hence, *MessageSize* shall always be an integer multiple of the *HashAlgorithm* block size, and the final supplied *Message* in a sequence of

invocations shall contain caller-provided padding. This will ensure that the final *Hash* output will be the correct hash of the provided message(s).

- The result of a **Hash()** call for one of these algorithms when the caller does not supply message data whose length is an integer multiple of the algorithm's block size is a returned error.
- The **EFI\_HASH\_OUTPUT** options for these two algorithms shall be **EFI\_SHA1\_HASH** and **EFI\_SHA256\_HASH**, respectively.
- Callers using these algorithms may consult the aforementioned Secure Hash Standard for details on how to perform proper padding required by standard prior to final invocation.

## Related Definitions

### EFI\_HASH\_OUTPUT

## Status Codes Returned

EFI_SUCCESS	<i>Hash</i> returned successfully.
EFI_INVALID_PARAMETER	<i>Message</i> or <i>Hash, HashAlgorithm</i> is NULL or <i>MessageSize</i> is 0. <i>MessageSize</i> is not an integer multiple of block size.
EFI_UNSUPPORTED	The algorithm specified by <i>HashAlgorithm</i> is not supported by this driver. Includes <i>HashAlgorithm</i> being passed as a null error.
EFI_UNSUPPORTED	<i>Extend</i> is <b>TRUE</b> and the algorithm doesn't support extending the hash.

## 36.1.2 Other Code Definitions

EFI\_SHA1\_HASH, EFI\_SHA224\_HASH, EFI\_SHA256\_HASH,  
EFI\_SHA384\_HASH, EFI\_SHA512HASH, EFI\_MD5\_HASH

### Summary

Data structure which holds the result of the hash.

## Prototype

```
typedef UINT8 EFI_MD5_HASH[16];
typedef UINT8 EFI_SHA1_HASH[20];
typedef UINT8 EFI_SHA224_HASH[28];
typedef UINT8 EFI_SHA256_HASH[32];
typedef UINT8 EFI_SHA384_HASH[48];
typedef UINT8 EFI_SHA512_HASH[64];
typedef union _EFI_HASH_OUTPUT {
    EFI_MD5_HASH *Md5Hash;
    EFI_SHA1_HASH *Sha1Hash;
    EFI_SHA224_HASH *Sha224Hash;
    EFI_SHA256_HASH *Sha256Hash;
    EFI_SHA384_HASH *Sha384Hash;
    EFI_SHA512_HASH *Sha512Hash;
} EFI_HASH_OUTPUT;
```

## Description

These prototypes describe the expected hash output values from the *Hash* function of the **EFI\_HASH\_PROTOCOL**.

## Related Definitions

None

### 36.1.2.1 EFI Hash Algorithms

The following table gives the **EFI\_GUID** for standard hash algorithms and the corresponding ASN.1 OID (Object Identifier):

**Note:** *Use of the following algorithms with **EFI\_HASH\_PROTOCOL** is deprecated.*

- EFI\_HASH\_ALGORITHM\_SHA1\_GUID
- EFI\_HASH\_ALGORITHM\_SHA224\_GUID
- EFI\_HASH\_ALGORITHM\_SHA256\_GUID
- EFI\_HASH\_ALGORITHM\_SHA384\_GUID
- EFI\_HASH\_ALGORITHM\_SHA512\_GUID
- EFI\_HASH\_ALGORITHM\_MD5\_GUID



Table 222. EFI Hash Algorithms

Algorithm	EFI_GUID	OID
SHA-1 (No padding done by implementation)	<b>#define</b> <b>EFI_HASH_ALGORITHM_SHA1_NOPAD_GUID</b> {0x24c5dc2f, 0x53e2, 0x40ca, {0x9e, 0xd6, 0xa5, 0xd9, 0xa4, 0x9f, 0x46, 0x3b}}	<b>id-sha1 OBJECT IDENTIFIER ::= { iso(1) identified-organization(3) oiw(14) secsig(3) algorithms(2) 26 }</b>
SHA-256 (No padding done by implementation)	<b>#define</b> <b>EFI_HASH_ALGORITHM_SHA256_NOPAD_GUID</b> {0x8628752a, 0x6cb7, 0x4814, {0x96, 0xfc, 0x24, 0xa8, 0x15, 0xac, 0x22, 0x26}}	<b>id-sha256 OBJECT IDENTIFIER ::= { joint-iso-itu-t(2) country(16) us(840) organization(1) gov(101) csor(3) nistalgorithm(4) hashalgs(2) 1 }</b>

**Note:** For the **EFI\_HASH\_ALGORITHM\_SHA1\_NOPAD\_GUID** and the **EFI\_HASH\_ALGORITHM\_SHA256\_NOPAD\_GUID**, the following apply:

- The **EFI\_HASH\_PROTOCOL.Hash()** function does not perform padding of message data for these algorithms. Hence, *MessageSize* shall always be an integer multiple of the *HashAlgorithm* block size, and the final supplied *Message* in a sequence of invocations shall contain caller-provided padding. This will ensure that the final *Hash* output will be the correct hash of the provided message(s).
- The result of a **Hash()** call for one of these algorithms when the caller does not supply message data whose length is an integer multiple of the algorithm's block size is undefined.
- The **EFI\_HASH\_OUTPUT** options for these two algorithms shall be **EFI\_SHA1\_HASH** and **EFI\_SHA256\_HASH**, respectively.
- Callers using these algorithms may consult the aforementioned Secure Hash Standard for details on how to perform proper padding.

## 36.2 Hash2 Protocols

### 36.2.1 EFI Hash2 Service Binding Protocol

#### EFI\_HASH2\_SERVICE\_BINDING\_PROTOCOL

##### Summary

The EFI Hash2 Service Binding Protocol is used to locate **EFI\_HASH2\_PROTOCOL** hashing services support provided by a driver and create and destroy instances of the **EFI\_HASH2\_PROTOCOL** Protocol so that a multiple drivers can use the underlying hashing services.

The EFI Service Binding Protocol that is defined in [Section 2.5.8](#) defines the generic Service Binding Protocol functions. This section discusses the details that are specific to the EFI Hash Protocol.

## GUID

```
#define EFI_HASH2_SERVICE_BINDING_PROTOCOL_GUID \
{0xda836f8d, 0x217f, 0x4ca0, 0x99, 0xc2, 0x1c, \
 0xa4, 0xe1, 0x60, 0x77, 0xea}
```

## Description

An application (or driver) that requires hashing services can use one of the protocol handler services, such as **BS->LocateHandleBuffer()**, to search for devices that publish an **EFI\_HASH2\_SERVICE\_BINDING\_PROTOCOL**.

After a successful call to the **EFI\_HASH2\_SERVICE\_BINDING\_PROTOCOL** member **CreateChild()** function, the child instance of **EFI\_HASH2\_PROTOCOL** Protocol driver instance is ready for use. The instance of **EFI\_HASH2\_PROTOCOL** must be obtained by performing **HandleProtocol()** against the handle returned by **CreateChild()**. Use of other methods, such as **LocateHandle()** is not supported.

Once obtained, the driver may use the **EFI\_HASH2\_PROTOCOL** instance for any number of non-overlapping hash operations. Overlapping hash operations require an additional call to **EFI\_HASH\_SERVICE\_BINDING\_PROTOCOL.CreateChild()** for a new instance.

Before a driver or application using the instance terminates execution, every successful call to the **EFI\_HASH\_SERVICE\_BINDING\_PROTOCOL.CreateChild()** function must be matched with a call to the **EFI\_HASH\_SERVICE\_BINDING\_PROTOCOL.DestroyChild()** function.

## 36.2.2 EFI Hash2 Protocol

### EFI\_HASH2\_PROTOCOL

#### Summary

This protocol describes hashing functions for which the algorithm-required message padding and finalization are performed by the supporting driver. In previous versions of the specification, the algorithms supported by **EFI\_HASH2\_PROTOCOL** were also available for use with **EFI\_HASH\_PROTOCOL** but this usage has been deprecated.

## GUID

```
#define EFI_HASH2_PROTOCOL_GUID \
{
  0x55b1d734, 0xc5e1, 0x49db, 0x96, 0x47, 0xb1, 0x6a, \
  0xfb, 0xe, 0x30, 0x5b}
```

## Protocol Interface Structure

```
typedef _EFI_HASH2_PROTOCOL {
  EFI_HASH2_GET_HASH_SIZE GetHashSize;
  EFI_HASH2_HASH Hash;
  EFI_HASH2_HASH_INIT HashInit;
  EFI_HASH2_HASH_UPDATE HashUpdate;
  EFI_HASH2_HASH_FINAL HashFinal;
} EFI_HASH2_PROTOCOL;
```

## Parameters

<i>GetHashSize</i>	Return the result size of a specific type of resulting hash.
<i>Hash</i>	Create a final non-extendable hash for a single message block in a single call.
<i>HashInit</i>	Initializes an extendable multi-part hash calculation
<i>HashUpdate</i>	Continues a hash in progress by supplying the first or next sequential portion of the message text
<i>HashFinal</i>	Finalizes a hash in progress by padding as required by algorithm and returning the hash output.

## Description

This protocol allows creating a hash of an arbitrary message digest using one or more hash algorithms. The **GetHashSize()** function returns the expected size of the hash for a supported algorithm and an error if that algorithm is not supported. The **Hash()** function creates a final, non-extendable, hash of a single message block using the specified algorithm. The three functions **HashInit()**, **HashUpdate()**, **HashFinal()**, generates the hash of a multi-part message, with input composed of one or more message pieces.

For a specific handle representing an instance of **EFI\_HASH2\_PROTOCOL**, if **Hash()** is called after a call to **HashInit()** and prior to the matching call to **HashFinal()**, the multi-part hash started by **HashInit()** will be canceled and calls to **HashUpdate()** or **HashFinal()** will return an error status unless proceeded by a new call to **HashInit()**.

**Note:** Algorithms **EFI\_HASH\_ALGORITHM\_SHA1\_NOPAD** and **EFI\_HASH\_ALGORITHM\_SHA256\_NOPAD\_GUID** are not compatible with **EFI\_HASH2\_PROTOCOL** and will return **EFI\_UNSUPPORTED** if used with any **EFI\_HASH2\_PROTOCOL** function.

## Related Definitions

None

**Note:** The following hash function invocations will produce identical hash results for all supported **EFI\_HASH2\_PROTOCOL** algorithms. The data in quotes is the message.

**Table 223. Identical hash results**

<b>Hash("ABCDEF")</b>	<b>HashInit()</b>	<b>HashInit ()</b>
	<b>HashUpdate("ABCDEF")</b>	<b>HashUpdate ("ABC")</b>
	<b>HashFinal()</b>	<b>HashUpdate ("DE")</b>
		<b>HashUpdate ("F")</b>
		<b>HashFinal ()</b>

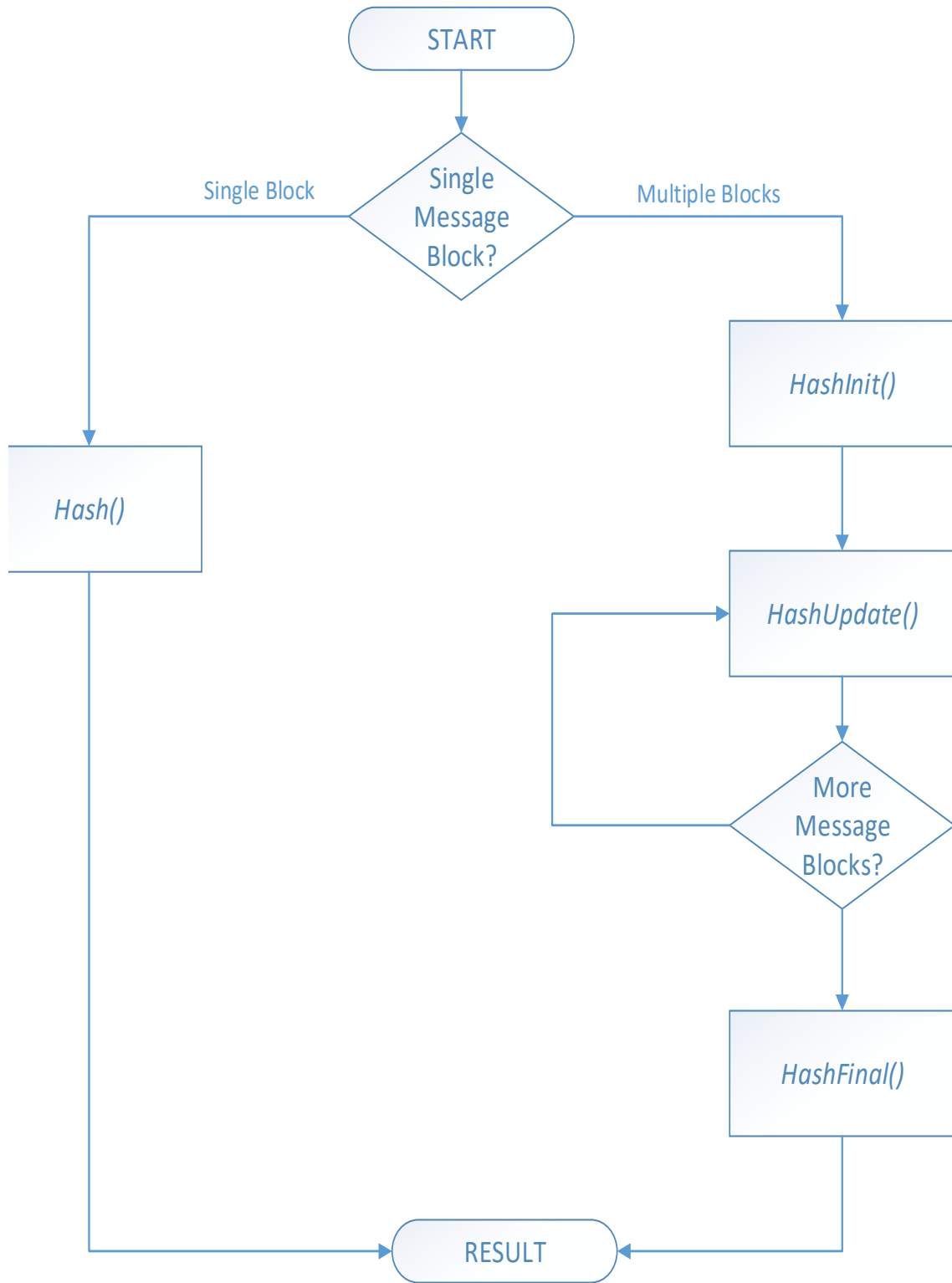

Figure 140. Hash workflow

## EFI\_HASH2\_PROTOCOL.GetHashSize()

### Summary

Returns the size of the hash which results from a specific algorithm.

### Prototype

```
EFI_STATUS
EFIAPI
GetHashSize(
  IN CONST EFI_HASH2_PROTOCOL *This,
  IN CONST EFI_GUID *HashAlgorithm,
  OUT UINTN *HashSize
);
```

### Parameters

<i>This</i>	Points to this instance of <b>EFI_HASH2_PROTOCOL</b> .
<i>HashAlgorithm</i>	Points to the <b>EFI_GUID</b> which identifies the algorithm to use. See <a href="#">Section 36.2.3</a>
<i>HashSize</i>	Holds the returned size of the algorithm's hash.

### Description

This function returns the size of the hash result buffer which will be produced by the specified algorithm.

### Related Definitions

None

### Status Codes Returned

EFI_SUCCESS	Hash size returned successfully.
EFI_INVALID_PARAMETER	<i>This</i> or <i>HashSize</i> is <b>NULL</b>
EFI_UNSUPPORTED	The algorithm specified by <i>HashAlgorithm</i> is not supported by this driver or, <i>HashAlgorithm</i> is null.

## EFI\_HASH2\_PROTOCOL.Hash()

### Summary

Creates a hash for a single message text. The hash is not extendable. The output is final with any algorithm-required padding added by the function.

### Prototype

```

EFI_STATUS
EFIAPI
Hash(
  IN CONST EFI_HASH2_PROTOCOL *This,
  IN CONST EFI_GUID *HashAlgorithm,
  IN CONST UINT8 *Message,
  IN UINTN MessageSize,
  IN OUT EFI_HASH2_OUTPUT *Hash
);

```

### Parameters

<i>This</i>	Points to this instance of <b>EFI_HASH2_PROTOCOL</b> .
<i>HashAlgorithm</i>	Points to the <b>EFI_GUID</b> which identifies the algorithm to use. See <a href="#">Table 224</a> .
<i>Message</i>	Points to the start of the message.
<i>MessageSize</i>	The size of <i>Message</i> , in bytes.
<i>Hash</i>	On input, points to a caller-allocated buffer of the size returned by <b>GetHashSize()</b> for the specified <i>HashAlgorithm</i> . On output, the buffer holds the resulting hash computed from the message.

### Description

This function creates the hash of specified single block message text based on the specified algorithm *HashAlgorithm* and copies the result to the caller-provided buffer *Hash*. The resulting hash cannot be extended. All padding required by *HashAlgorithm* is added by the implementation.

### Related Definitions

**EFI\_HASH2\_OUTPUT**

### Status Codes Returned

EFI_SUCCESS	<i>Hash</i> returned successfully.
EFI_INVALID_PARAMETER	<i>This</i> , or <i>Hash</i> is NULL..
EFI_UNSUPPORTED	The algorithm specified by <i>HashAlgorithm</i> is not supported by this driver or <i>HashAlgorithm</i> is Null.

EFI_OUT_OF_RESOURCES	Some resource required by the function is not available or <i>MessageSize</i> is greater than platform maximum.
----------------------	---



## EFI\_HASH2\_PROTOCOL.HashInit()

### Summary

This function must be called to initialize a digest calculation to be subsequently performed using the **EFI\_HASH2\_PROTOCOL** functions **HashUpdate()** and **HashFinal()**.

### Prototype

```
EFI_STATUS
EFIAPI
HashInit(
  IN CONST EFI_HASH2_PROTOCOL *This,
  IN CONST EFI_GUID    *HashAlgorithm,
);
```

### Parameters

<i>This</i>	Points to instance of <b>EFI_HASH2_PROTOCOL</b> .
<i>HashAlgorithm</i>	Points to the <b>EFI_GUID</b> which identifies the algorithm to use. See <a href="#">Table 224</a>

### Description

This function

### Related Definitions

### Status Codes Returned

EFI_SUCCESS	Initialized successfully.
EFI_INVALID_PARAMETER	<i>This</i> is NULL.
EFI_UNSUPPORTED	The algorithm specified by <i>HashAlgorithm</i> is not supported by this function or <i>HashAlgorithm</i> is Null.
EFI_OUT_OF_RESOURCES	Process failed due to lack of required resource.
EFI_ALREADY_STARTED	This function is called when the operation in progress is still in processing <i>Hash()</i> , or <i>HashInit()</i> is already called before and not terminated by <i>HashFinal()</i> yet on the same instance.

## EFI\_HASH2\_PROTOCOL.HashUpdate()

### Summary

Updates the hash of a computation in progress by adding a message text.

### Prototype

```
EFI_STATUS
EFIAPI
HashUpdate(
  IN CONST EFI_HASH2_PROTOCOL *This,
  IN CONST UINT8      *Message,
  IN UINTN      MessageSize
);
```

### Parameters

<i>This</i>	Points to instance of <b>EFI_HASH2_PROTOCOL</b> .
<i>Message</i>	Points to the start of the message.
<i>MessageSize</i>	The size of <i>Message</i> , in bytes.

### Description

This function extends the hash of ongoing hash operation with the supplied message text. This function should be called one or more times with portions of the total message text to be hashed.. A zero-length message input will return EFI\_SUCCESS and has no impacts on the ongoing hash instance.

### Related Definitions

### Status Codes Returned

EFI_SUCCESS	Digest in progress updated successfully.
EFI_INVALID_PARAMETER	<i>This</i> or <i>Hash</i> is NULL.
EFI_OUT_OF_RESOURCES	Some resource required by the function is not available or <i>MessageSize</i> is greater than platform maximum.
EFI_NOT_READY	This call was not preceded by a valid call to <b>HashInit()</b> , or the operation in progress was terminated by a call to <b>Hash()</b> or <b>HashFinal()</b> on the same instance.

## EFI\_HASH2\_PROTOCOL.HashFinal()

### Summary

Finalizes a hash operation in progress and returns calculation result. The output is final with any necessary padding added by the function. The hash may not be further updated or extended after **HashFinal()**.

### Prototype

```
EFI_STATUS
EFIAPI
HashFinal(
  IN CONST EFI_HASH2_PROTOCOL *This,
  IN OUT EFI_HASH2_OUTPUT *Hash
);
```

### Parameters

*This*

Points to instance of **EFI\_HASH2\_PROTOCOL**.

*Hash*

On input, points to a caller-allocated buffer of the size returned by **GetHashSize()** for the specified *HashAlgorithm* specified in preceding **HashInit()**. On output, the buffer holds the resulting hash computed from the message.

### Description

This function finalizes the hash of a hash operation in progress. The resulting final hash cannot be extended.

## Related Definitions

### EFI\_HASH2\_OUTPUT

## Status Codes Returned

EFI_SUCCESS	<i>Hash</i> returned successfully.
EFI_INVALID_PARAMETER	<i>This</i> or <i>Hash</i> is NULL
EFI_NOT_READY	This call was not preceded by a valid call to <b>HashInit()</b> and at least one call to <b>HashUpdate()</b> , or the operation in progress was canceled by a call to <b>Hash()</b> on the same instance.

Table 224. Algorithms that may be used with EFI\_HASH2\_PROTOCOL

	EFI_GUID	OID
SHA-1	<b>#define</b> <b>EFI_HASH_ALGORITHM_SHA1_GUID</b> {0x2ae9d80f, 0x3fb2, 0x4095, { 0xb7, 0xb1, 0xe9, 0x31, 0x57, 0xb9, 0x46, 0xb6}}	<b>id-sha1 OBJECT IDENTIFIER ::=</b> { iso(1) identified- organization(3) oiw(14) secsig(3) algorithms(2) 26 }
SHA-224	<b>#define</b> <b>EFI_HASH_ALGORITHM_SHA224_GUID</b> { 0x8df01a06, 0x9bd5, 0x4bf7, { 0xb0, 0x21, 0xdb, 0x4f, 0xd9, 0xcc, 0xf4, 0x5b } }	
SHA-256	<b>#define</b> <b>EFI_HASH_ALGORITHM_SHA256_GUID</b> { 0x51aa59de, 0xdf2, 0x4ea3, { 0xbc, 0x63, 0x87, 0x5f, 0xb7, 0x84, 0x2e, 0xe9 } }	<b>id-sha256 OBJECT IDENTIFIER</b> <b>::=</b> { joint-iso-itu-t (2) country (16) us (840) organization (1) gov (101) csor (3) nistalgorithm (4) hashalgs (2) 1}
SHA-384	<b>#define</b> <b>EFI_HASH_ALGORITHM_SHA384_GUID</b> { 0xefa96432, 0xde33, 0x4dd2, { 0xae, 0xe6, 0x32, 0x8c, 0x33, 0xdf, 0x77, 0x7a } }	<b>id-sha384 OBJECT IDENTIFIER</b> <b>::=</b> { joint-iso-itu-t (2) country (16) us (840) organization (1) gov (101) csor (3) nistalgorithm (4) hashalgs (2) 2}

	EFI_GUID	OID
SHA-512	<pre>#define EFI_HASH_ALGORITHM_SHA512_GUID { 0xcaa4381e, 0x750c, 0x4770, { 0xb8, 0x70, 0x7a, 0x23, 0xb4, 0xe4, 0x21, 0x30 } }</pre>	<pre>id-sha512 OBJECT IDENTIFIER  ::= { joint-iso-itu-t (2) country (16) us (840) organization (1) gov (101) csor (3) nistalgorithm (4) hashalgs (2) 3 }</pre>
MD5	<pre>#define EFI_HASH_ALGORITHM_MD5_GUID { 0xaf7c79c, 0x65b5, 0x4319, { 0xb0, 0xae, 0x44, 0xec, 0x48, 0x4e, 0x4a, 0xd7 } }</pre>	<pre>id-md5OBJECTIDENTIFIER  ::= { iso (1) member-body (2) us (840)rsadsi(113549) digestAlgorithm(2) 5 }</pre>

**Note:** *SHA-1 and MD5 are included for backwards compatibility. New driver implementations are encouraged to consider stronger algorithms.*

### 36.2.3 Other Code Definitions

#### EFI\_HASH2\_OUTPUT

##### Summary

Data structure which holds the result of the hash operation from **EFI\_HASH2\_PROTOCOL** hash operations.

##### Prototype

```
typedef UINT8 EFI_MD5_HASH2[16];
typedef UINT8 EFI_SHA1_HASH2[20];
typedef UINT8 EFI_SHA224_HASH2[28];
typedef UINT8 EFI_SHA256_HASH2[32];
typedef UINT8 EFI_SHA384_HASH2[48];
typedef UINT8 EFI_SHA512_HASH2[64];
typedef union _EFI_HASH2_OUTPUT {
EFI_MD5_HASH2 Md5Hash;
EFI_SHA1_HASH2 Sha1Hash;
EFI_SHA224_HASH2 Sha224Hash;
EFI_SHA256_HASH2 Sha256Hash;
EFI_SHA384_HASH2 Sha384Hash;
EFI_SHA512_HASH2 Sha512Hash;
} EFI_HASH2_OUTPUT;
```

## Description

These prototypes describe the expected hash output values from the hashing functions of the **EFI\_HASH2\_PROTOCOL**.

## Related Definitions

None

# 36.3 Key Management Service

## EFI\_KEY\_MANAGEMENT\_SERVICE\_PROTOCOL

### Summary

The Key Management Service (KMS) protocol provides services to generate, store, retrieve, and manage cryptographic keys. The intention is to specify a simple generic protocol that could be used for many implementations.

The management keys have a simple construct – they consist of key identifier and key data, both of variable size.

A driver implementing the protocol may need to provide basic key service that consists of a key store and cryptographic key generation capability. It may connect to an external key server over the network, or to a Hardware Security Module (HSM) attached to the system it runs on, or anything else that is capable of providing the key management service.

Authentication and access control is not addressed by this protocol. It is assumed it is addressed at the system level and done by the driver implementing the protocol, if applicable to the implementation.

### GUID

```
#define EFI_KMS_PROTOCOL_GUID \
{0xEC3A978D,0x7C4E, 0x48FA,\
{0x9A,0xBE,0x6A,0xD9,0x1C,0xC8,0xF8,0x11}}
```

### Protocol Interface Structure

```
#define EFI_KMS_DATA_TYPE_NONE 0
#define EFI_KMS_DATA_TYPE_BINARY 1
#define EFI_KMS_DATA_TYPE_ASCII 2
#define EFI_KMS_DATA_TYPE_UNICODE 4
#define EFI_KMS_DATA_TYPE_UTF8 8
```

Where appropriate, **EFI\_KMS\_DATA\_TYPE** values may be combined using a bitwise 'OR' operation to indicate support for multiple data types.

```

typedef struct _EFI_KMS_SERVICE_PROTOCOL {
  EFI_KMS_GET_SERVICE_STATUS  GetServiceStatus;
  EFI_KMS_REGISTER_CLIENT     RegisterClient;
  EFI_KMS_CREATE_KEY          CreateKey;
  EFI_KMS_GET_KEY             GetKey;
  EFI_KMS_ADD_KEY             AddKey;
  EFI_KMS_DELETE_KEY          DeleteKey;
  EFI_KMS_GET_KEY_ATTRIBUTES  GetKeyAttributes;
  EFI_KMS_ADD_KEY_ATTRIBUTES  AddKeyAttributes;
  EFI_KMS_DELETE_KEY_ATTRIBUTES DeleteKeyAttributes;
  EFI_KMS_GET_KEY_BY_ATTRIBUTES GetKeyByAttributes;
  UINT32                      ProtocolVersion;
  EFI_GUID                    ServiceId;
  CHAR16                      *ServiceName;
  UINT32                      ServiceVersion;
  BOOLEAN                     ServiceAvailable;
  BOOLEAN                     ClientIdSupported;
  BOOLEAN                     ClientIdRequired;
  UINT16                      ClientIdMaxSize;
  UINT8                       ClientNameStringTypes;
  BOOLEAN                     ClientNameRequired;
  UINT16                      ClientNameMaxCount;
  BOOLEAN                     ClientDataSupported;
  UINTN                       ClientDataMaxSize;
  BOOLEAN                     KeyIdVariableLenSupported;
  UINTN                       KeyIdMaxSize;
  UINTN                       KeyFormatsCount;
  EFI_GUID                    *KeyFormats;
  BOOLEAN                     KeyAttributesSupported;
  UINT8                       KeyAttributeIdStringTypes;
  UINT16                      KeyAttributeIdMaxCount;
  UINTN                       KeyAttributesCount;
  EFI_KMS_KEY_ATTRIBUTE        *KeyAttributes;
} EFI_KMS_PROTOCOL;

```

## Parameters

<i>GetServiceStatus</i>	Get the current status of the key management service. If the implementation has not yet connected to the KMS, then a call to this function will initiate a connection. This is the only function that is valid for use prior to the service being marked available.
<i>RegisterClient</i>	Register a specific client with the KMS.
<i>CreateKey</i>	Request the generation of a new key and retrieve it.
<i>GetKey</i>	Retrieve an existing key.

<i>AddKey</i>	Add a local key to the KMS database. If there is an existing key with this key identifier in the KMS database, it will be replaced with the new key.
<i>DeleteKey</i>	Delete an existing key from the KMS database.
<i>AddKeyAttributes</i>	Add attributes to an existing key in the KMS database.
<i>GetKeyAttributes</i>	Get attributes for an existing key in the KMS database.
<i>DeleteKeyAttributes</i>	Delete attributes for an existing key in the KMS database.
<i>GetKeyByAttributes</i>	Get existing key(s) with the specified attributes.
<i>ProtocolVersion</i>	The version of this <b>EFI_KMS_PROTOCOL</b> structure. This must be set to 0x00020040 for the initial version of this protocol.
<i>ServiceId</i>	Optional GUID used to identify a specific KMS. This GUID may be supplied by the provider, by the implementation, or may be null. If it is null, then the <i>ServiceName</i> must not be null.
<i>ServiceName</i>	Optional pointer to a unicode string which may be used to identify the KMS or provide other information about the supplier.
<i>ServiceVersion</i>	Optional 32-bit value which may be used to indicate the version of the KMS provided by the supplier.
<i>ServiceAvailable</i>	<b>TRUE</b> if and only if the service is active and available for use. To avoid unnecessary delays in POST, this protocol may be installed without connecting to the service. In this case, the first call to the <b>GetServiceStatus()</b> function will cause the implementation to connect to the supported service and mark it as available. The capabilities of this service as defined in the remainder of this protocol are not guaranteed to be valid until the service has been marked available. <b>FALSE</b> otherwise.
<i>ClientIdSupported</i>	<b>TRUE</b> if and only if the service supports client identifiers. Client identifiers may be used for auditing, access control or any other purpose specific to the implementation. <b>FALSE</b> otherwise.
<i>ClientIdRequired</i>	<b>TRUE</b> if and only if the service requires a client identifier in order to process key requests. <b>FALSE</b> otherwise.
<i>ClientIdMaxSize</i>	The maximum size in bytes for the client identifier.
<i>ClientNameStringTypes</i>	The client name string type(s) supported by the KMS service. If client names are not supported, this field will be set to <b>EFI_KMS_DATA_TYPE_NONE</b> . Otherwise, it will be set to the inclusive 'OR' of all client name formats supported. Client names may be used for auditing, access control or any other purpose specific to the implementation.



<i>ClientNameRequired</i>	<b>TRUE</b> if and only if the KMS service requires a client name to be supplied to the service. <b>FALSE</b> otherwise.
<i>ClientNameMaxCount</i>	The maximum number of characters allowed for the client name.
<i>ClientDataSupported</i>	<b>TRUE</b> if and only if the service supports arbitrary client data requests. The use of client data requires the caller to have specific knowledge of the individual KMS service and should be used only if absolutely necessary. <b>FALSE</b> otherwise.
<i>ClientDataMaxSize</i>	The maximum size in bytes for the client data. If the maximum data size is not specified by the KMS or it is not known, then this field must be filled with all ones.
<i>KeyIdVariableLenSupported</i>	<b>TRUE</b> if variable length key identifiers are supported. <b>FALSE</b> if a fixed length key identifier is supported.
<i>KeyIdMaxLen</i>	If <i>KeyIdVariableLenSupported</i> is <b>TRUE</b> , this is the maximum supported key identifier length in bytes. Otherwise this is the fixed length of key identifier supported. Key ids shorter than the fixed length will be padded on the right with blanks.
<i>KeyFormatsCount</i>	The number of key format/size GUIDs returned in the <i>KeyFormats</i> field.
<i>KeyFormats</i>	A pointer to an array of <b>EFI_GUID</b> values which specify key formats/sizes supported by this KMS. Each format/size pair will be specified by a separate <b>EFI_GUID</b> . At least one key format/size must be supported. All formats/sizes with the same hashing algorithm must be contiguous in the array, and for each hashing algorithm, the key sizes must be in ascending order. See “Related Definitions” for GUIDs which identify supported key formats/sizes.  This list of GUIDs supported by the KMS is not required to be exhaustive, and the KMS may provide support for additional key formats/sizes. Users may request key information using an arbitrary GUID, but any GUID not recognized by the implementation or not supported by the KMS will return an error code of <b>EFI_UNSUPPORTED</b> .
<i>KeyAttributesSupported</i>	<b>TRUE</b> if key attributes are supported. <b>FALSE</b> if key attributes are not supported.
<i>KeyAttributeIdStringTypes</i>	The key attribute identifier string type(s) supported by the KMS service. If key attributes are not supported, this field will be set to <b>EFI_KMS_DATA_TYPE_NONE</b> . Otherwise, it will be set to the inclusive ‘OR’ of all key attribute identifier

string types supported. **EFI\_KMS\_DATA\_TYPE\_BINARY** is not valid for this field.

*KeyAttributeIdMaxCount*

The maximum number of characters allowed for the client name.

*KeyAttributesCount*

The number of predefined *KeyAttributes* structures returned in the *KeyAttributes* parameter. If the KMS does not support predefined key attributes, or if it does not provide a method to obtain predefined key attributes data, then this field must be zero.

*KeyAttributes*

A pointer to an array of *KeyAttributes* structures which contains the predefined attributes supported by this KMS. Each structure must contain a valid key attribute identifier and should provide any other information as appropriate for the attribute, including a default value if one exists. This variable must be set to **NULL** if the *KeyAttributesCount* variable is zero. It must point to a valid buffer if the *KeyAttributesCount* variable is non-zero.

This list of predefined attributes is not required to be exhaustive, and the KMS may provide additional predefined attributes not enumerated in this list. The implementation does not distinguish between predefined and used defined attributes, and therefore, predefined attributes not enumerated will still be processed to the KMS.

## Related Definitions

Functions defined for this protocol typically require the caller to provide information about the client, the keys to be processed, and/or attributes of the keys to be processed. Four structures, **EFI\_KMS\_CLIENT\_INFO**, **EFI\_KMS\_KEY\_DESCRIPTOR**, **EFI\_KMS\_DYNAMIC\_ATTRIBUTE**, and **EFI\_KMS\_KEY\_ATTRIBUTE** define the information to be passed to these functions.

```
typedef struct {
    UINT16  ClientIdSize;
    VOID    *ClientId;
    UINT8   ClientNameType;
    UINT8   ClientNameCount;
    VOID    *ClientName;
} EFI_KMS_CLIENT_INFO;
```

*ClientIdSize*

The size in bytes for the client identifier.

*ClientId*

Pointer to a valid client identifier.

*ClientNameType*

The client name string type used by this client. The string type set here must be one of the string types reported in the *ClientNameStringTypes* field of the KMS protocol. If

the KMS does not support client names, this field should be set to **EFI\_KMS\_DATA\_TYPE\_NONE**.

*ClientNameCount*

The size in characters for the client name. This field will be ignored if *ClientNameStringType* is set to **EFI\_KMS\_DATA\_TYPE\_NONE**. Otherwise, it must contain number of characters contained in the *ClientName* field.

*ClientName*

Pointer to a client name. This field will be ignored if *ClientNameStringType* is set to **EFI\_KMS\_DATA\_TYPE\_NONE**. Otherwise, it must point to a valid string of the specified type.

The key formats recognized by the KMS protocol are defined by an **EFI\_GUID** which specifies a (key-algorithm, key-size) pair. The names of these GUIDs are in the format **EFI\_KMS\_KEY\_(key-algorithm)\_(key-size)\_GUID**, where the key-size is expressed in bits. The key formats recognized fall into three categories, generic (no algorithm), hash algorithms, and encrypted algorithms.

### Generic Key Data:

The following GUIDs define formats that contain generic key data of a specific size in bits, but which is not associated with any specific key algorithm(s).

```

#define EFI_KMS_FORMAT_GENERIC_128_GUID \
{0xec8a3d69,0x6ddf,0x4108,\
 0x94,0x76,0x73,0x37,0xfc,0x52,0x21,0x36}}

#define EFI_KMS_FORMAT_GENERIC_160_GUID \
{0xa3b3e6f8,0xefca,0x4bc1,\
 0x88,0xfb,0xcb,0x87,0x33,0x9b,0x25,0x79}}

#define EFI_KMS_FORMAT_GENERIC_256_GUID \
{0x70f64793,0xc323,0x4261,\
 0xac,0x2c,0xd8,0x76,0xf2,0x7c,0x53,0x45}}

#define EFI_KMS_FORMAT_GENERIC_512_GUID \
{0x978fe043,0xd7af,0x422e,\
 0x8a,0x92,0x2b,0x48,0xe4,0x63,0xbd,0xe6}}

#define EFI_KMS_FORMAT_GENERIC_1024_GUID \
{0x43be0b44,0x874b,0x4ead,\
 0xb0,0x9c,0x24,0x1a,0x4f,0xbd,0x7e,0xb3}}

#define EFI_KMS_FORMAT_GENERIC_2048_GUID \
{0x40093f23,0x630c,0x4626,\
 0x9c,0x48,0x40,0x37,0x3b,0x19,0xcb,0xbe}}

#define EFI_KMS_FORMAT_GENERIC_3072_GUID \
{0xb9237513,0x6c44,0x4411,\
 0xa9,0x90,0x21,0xe5,0x56,0xe0,0x5a,0xde}}

#define EFI_KMS_FORMAT_GENERIC_DYNAMIC_GUID \
{0x2156e996, 0x66de, 0x4b27, \
 0x9c, 0xc9, 0xb0, 0x9f, 0xac, 0x4d, 0x2, 0xbe}}

```

The **EFI\_KMS\_FORMAT\_GENERIC\_DYNAMIC\_GUID** is defined for the key data with a size not defined by a certain key format GUID. The key value specified by this GUID is in format of structure **EFI\_KMS\_FORMAT\_GENERIC\_DYNAMIC**.

```

typedef struct {
    UINT32 KeySize;
    UINT8  KeyData[1];
} EFI_KMS_FORMAT_GENERIC_DYNAMIC;

```

*KeySize* Length in bytes of the *KeyData*.

*KeyData* The data of the key.

### Hash Algorithm Key Data:

These GUIDS define key data formats that contain data generated by basic hash algorithms with no cryptographic properties.

```
#define EFI_KMS_FORMAT_MD2_128_GUID \
{0x78be11c4,0xee44,0x4a22,\
 0x9f,0x05,0x03,0x85,0x2e,0xc5,0xc9,0x78}}

#define EFI_KMS_FORMAT_MDC2_128_GUID \
{0xf7ad60f8,0xefa8,0x44a3,\
 0x91,0x13,0x23,0x1f,0x39,0x9e,0xb4,0xc7}}

#define EFI_KMS_FORMAT_MD4_128_GUID \
{0xd1c17aa1,0xcac5,0x400f,0xbe,\
 0x17,0xe2,0xa2,0xae,0x06,0x67,0x7c}}

#define EFI_KMS_FORMAT_MDC4_128_GUID \
{0x3fa4f847,0xd8eb,0x4df4,\
 0xbd,0x49,0x10,0x3a,0x0a,0x84,0x7b,0xbc}}

#define EFI_KMS_FORMAT_MD5_128_GUID \
{0xdcbc3662,0x9cda,0x4b52,\
 0xa0,0x4c,0x82,0xeb,0x1d,0x23,0x48,0xc7}}

#define EFI_KMS_FORMAT_MD5SHA_128_GUID \
{0x1c178237,0x6897,0x459e,\
 0x9d,0x36,0x67,0xce,0x8e,0xf9,0x4f,0x76}}

#define EFI_KMS_FORMAT_SHA1_160_GUID \
{0x453c5e5a,0x482d,0x43f0,\
 0x87,0xc9,0x59,0x41,0xf3,0xa3,0x8a,0xc2}}

#define EFI_KMS_FORMAT_SHA256_256_GUID \
{0x6bb4f5cd,0x8022,0x448d,\
 0xbc,0x6d,0x77,0x1b,0xae,0x93,0x5f,0xc6}}

#define EFI_KMS_FORMAT_SHA512_512_GUID \
{0x2f240e12,0xe14d,0x475c,\
 0x83,0xb0,0xef,0xff,0x22,0xd7,0x7b,0xe7}}
```

### Encryption Algorithm Key Data:

These GUIDs define key data formats that contain data generated by cryptographic key algorithms. There may or may not be a separate data hashing algorithm associated with the key algorithm.

```
#define EFI_KMS_FORMAT_AESXTS_128_GUID \
{0x4776e33f,0xdb47,0x479a,\
 {0xa2,0x5f,0xa1,0xcd,0x0a,0xfa,0xb3,0x8b}}

#define EFI_KMS_FORMAT_AESXTS_256_GUID \
{0xdc7e8613,0xc4bb,0x4db0,\
 {0x84,0x62,0x13,0x51,0x13,0x57,0xab,0xe2}}

#define EFI_KMS_FORMAT_AESCBC_128_GUID \
{0xa0e8ee6a,0x0e92,0x44d4,\
 {0x86,0x1b,0x0e,0xaa,0x4a,0xca,0x44,0xa2}}

#define EFI_KMS_FORMAT_AESCBC_256_GUID \
{0xd7e69789,0x1f68,0x45e8,\
 {0x96,0xef,0x3b,0x64,0x07,0xa5,0xb2,0xdc}}

#define EFI_KMS_FORMAT_RSASHA1_1024_GUID \
{0x56417bed,0x6bbe,0x4882,\
 {0x86,0xa0,0x3a,0xe8,0xbb,0x17,0xf8,0xf9}}

#define EFI_KMS_FORMAT_RSASHA1_2048_GUID \
{0xf66447d4,0x75a6,0x463e,\
 {0xa8,0x19,0x07,0x7f,0x2d,0xda,0x05,0xe9}}

#define EFI_KMS_FORMAT_RSASHA256_2048_GUID \
{0xa477af13,0x877d,0x4060,\
 {0xba,0xa1,0x25,0xd1,0xbe,0xa0,0x8a,0xd3}}

#define EFI_KMS_FORMAT_RSASHA256_3072_GUID \
{0x4e1356c2,0xeed,0x463f,\
 {0x81,0x47,0x99,0x33,0xab,0xdb,0xc7,0xd5}}
```

The encryption algorithms defined above have the following properties

Table 225. Encryption algorithm properties.

EFI_KMS_FORMAT	Encryption Description	Key Data Size	Hash Function
AESXTS_128	Symmetric encryption using XTS-AES 128 bit keys	Key data is a concatenation of two fields of equal size for a total size of 256 bits	N/A
AESXTS_256	Symmetric encryption using block cipher XTS-AES 256 bit keys	Key data is a concatenation of two fields of equal size for a total size of 512 bits	N/A
AESCBC_128	Symmetric encryption using block cipher AES-CBC 128 bit keys	128 bits	N/A
AESCBC_256	Symmetric encryption using block cipher AES-CBC 256 bit keys	256 bits	N/A
RSASHA1_1024	Asymmetric encryption using block cipher RSA 1024 bit keys	1024 bits	SHA1
RSASHA1_2048	Asymmetric encryption using block cipher RSA 2048 bit keys	2048 bits	SHA1
RSASHA256_2048	Asymmetric encryption using block cipher RSA 2048 bit keys	2048 bits	SHA256
RSASHA256_3072	Asymmetric encryption using block cipher RSA 3072 bit keys	3072 bits	SHA256

```

typedef struct {
    UINT8    KeyIdentifierSize;
    VOID     *KeyIdentifier;
    EFI_GUID KeyFormat;
    VOID     *KeyValue;
    EFI_STATUS KeyStatus;
} EFI_KMS_KEY_DESCRIPTOR;

```

*KeyIdentifierSize*

The size of the *KeyIdentifier* field in bytes. This field is limited to the range 0 to 255.

*KeyIdentifier*

Pointer to an array of *KeyIdentifierType* elements.

*KeyFormat*

An EFI\_GUID which specifies the algorithm and key value size for this key.

*KeyValue* Pointer to a key value for a key specified by the *KeyFormat* field. A **NULL** value for this field indicates that no key is available.

*KeyStatus* Specifies the results of KMS operations performed with this descriptor. This field is used to indicate the status of individual operations when a KMS function is called with multiple **EFI\_KMS\_KEY\_DESCRIPTOR** structures. KeyStatus codes returned for the individual key requests are:

### Status Codes Returned

EFI_SUCCESS	Successfully processed this key.
EFI_WARN_STALE_DATA	Successfully processed this key, however, the key's parameters exceed internal policies/limits and should be replaced.
EFI_COMPROMISED_DATA	Successfully processed this key, but the key may have been compromised and must be replaced.
EFI_UNSUPPORTED	Key format is not supported by the service.
EFI_OUT_OF_RESOURCES	Could not allocate resources for the key processing.
EFI_TIMEOUT	Timed out waiting for device or key server.
EFI_DEVICE_ERROR	Device or key server error.
EFI_INVALID_PARAMETER	<i>KeyFormat</i> is invalid.
EFI_NOT_FOUND	The key does not exist on the KMS.

```
#define EFI_KMS_ATTRIBUTE_TYPE_NONE    0x00
#define EFI_KMS_ATTRIBUTE_TYPE_INTEGER 0x01
#define EFI_KMS_ATTRIBUTE_TYPE_LONG_INTEGER 0x02
#define EFI_KMS_ATTRIBUTE_TYPE_BIG_INTEGER 0x03
#define EFI_KMS_ATTRIBUTE_TYPE_ENUMERATION 0x04
#define EFI_KMS_ATTRIBUTE_TYPE_BOOLEAN 0x05
#define EFI_KMS_ATTRIBUTE_TYPE_BYTE_STRING 0x06
#define EFI_KMS_ATTRIBUTE_TYPE_TEXT_STRING 0x07
#define EFI_KMS_ATTRIBUTE_TYPE_DATE_TIME 0x08
#define EFI_KMS_ATTRIBUTE_TYPE_INTERVAL 0x09
#define EFI_KMS_ATTRIBUTE_TYPE_STRUCTURE 0x0A
#define EFI_KMS_ATTRIBUTE_TYPE_DYNAMIC 0x0B
```

```
typedef struct {
    UINT32    FieldCount;
    EFI_KMS_DYNAMIC_FIELD Field[1];
} EFI_KMS_DYNAMIC_ATTRIBUTE;
```



*FieldCount* The number of members in the **EFI\_KMS\_DYNAMIC\_ATTRIBUTE** structure.

*Field* An array of **EFI\_KMS\_DYNAMIC\_FIELD** structures.

```
typedef struct {
  UINT16 Tag;
  UINT16 Type;
  UINT32 Length;
  UINT8 KeyAttributeData[1];
} EFI_KMS_DYNAMIC_FIELD;
```

*Tag* Part of a tag-type-length triplet that identifies the *KeyAttributeData* formatting. The definition of the value is outside the scope of this standard and may be defined by the KMS.

*Type* Part of a tag-type-length triplet that identifies the *KeyAttributeData* formatting. The definition of the value is outside the scope of this standard and may be defined by the KMS.

*Length* Length in bytes of the *KeyAttributeData*.

*KeyAttributeData* An array of bytes to hold the attribute data associated with the *KeyAttributeIdentifier*.

```
typedef struct {
  UINT8 KeyAttributeIdentifierType;
  UINT8 KeyAttributeIdentifierCount;
  VOID *KeyAttributeIdentifier;
  UINT16 KeyAttributeInstance;
  UINT16 KeyAttributeType;
  UINT16 KeyAttributeValueSize;
  VOID *KeyAttributeValue;
  EFI_STATUS KeyAttributeStatus;
} EFI_KMS_KEY_ATTRIBUTE;
```

*KeyAttributeIdentifierType* The data type used for the *KeyAttributeIdentifier* field. Values for this field are defined by the **EFI\_KMS\_DATA\_TYPE** constants, except that **EFI\_KMS\_DATA\_TYPE\_BINARY** is not valid for this field.

*KeyAttributeIdentifierCount* The length of the *KeyAttributeIdentifier* field in units defined by *KeyAttributeIdentifierType* field. This field is limited to the range 0 to 255.

*KeyAttributeIdentifier*

Pointer to an array of *KeyAttributeIdentifierType* elements. For string types, there must not be a null-termination element at the end of the array.

*KeyAttributeInstance*

The instance number of this attribute. If there is only one instance, the value is set to one. If this value is set to 0xFFFF (all binary 1's) then this field should be ignored if an output or treated as a wild card matching any value if it is an input. If the attribute is stored with this field, it will match any attribute request regardless of the setting of the field in the request. If set to 0xFFFF in the request, it will match any attribute with the same *KeyAttributeIdentifier*.

*KeyAttributeType*

The data type of the *KeyAttributeValue* (e.g. struct, bool, etc.). See the list of *KeyAttributeType* definitions.

*KeyAttributeValueSize*

The size in bytes of the *KeyAttribute* field. A value of zero for this field indicates that no key attribute value is available.

*KeyAttributeValue* Pointer to a key attribute value for the attribute specified by the *KeyAttributeIdentifier* field. If the *KeyAttributeValueSize* field is zero, then this field must be **NULL**.

*KeyAttributeStatus*

Specifies the results of KMS operations performed with this attribute. This field is used to indicate the status of individual operations when a KMS function is called with multiple **EFI\_KMS\_KEY\_ATTRIBUTE** structures. KeyAttributeStatus codes returned for the individual key attribute requests are:

## Status Codes Returned

EFI_SUCCESS	Successfully processed this request.
EFI_WARN_STALE_DATA	Successfully processed this request, however, the key's parameters exceed internal policies/limits and should be replaced.
EFI_COMPROMISED_DATA	Successfully processed this request, but the key may have been compromised and must be replaced.
EFI_UNSUPPORTED	Key attribute format is not supported by the service.
EFI_OUT_OF_RESOURCES	Could not allocate resources for the request processing.
EFI_TIMEOUT	Timed out waiting for device or key server.
EFI_DEVICE_ERROR	Device or key server error.
EFI_INVALID_PARAMETER	A field in the <i>EFI_KMS_KEY_ATTRIBUTE</i> structure is invalid.
EFI_NOT_FOUND	The key attribute does not exist on the KMS.

## Description

The **EFI\_KMS\_SERVICE\_PROTOCOL** defines a UEFI protocol that can be used by UEFI drivers and applications to access cryptographic keys associated with their operation that are stored and possibly managed by a remote key management service (KMS). For example, a storage device driver may require a set of one or more keys to enable access to regions on the storage devices that it manages.

The protocol can be used to request the generation of new keys from the KMS, to register locally generated keys with the KMS, to retrieve existing keys from the KMS, and to delete obsolete keys from the KMS. It also allows the device driver to manage attributes associated with individual keys on the KMS, and to retrieve keys based on those attributes.

A platform implementing this protocol may use internal or external key servers to provide the functionality required by this protocol. For external servers, the protocol implementation is expected to supply and maintain the connection parameters required to connect and authenticate to the remote server. The connection may be made during the initial installation of the protocol, or it may be delayed until the first **GetServiceStatus()** request is received.

Each client using the KMS protocol may identify itself to the protocol implementation using a **EFI\_KMS\_CLIENT\_INFO** structure. If the KMS supported by this protocol requires the client to provide a client identifier, then this structure must be provided on all function calls.

While this protocol is intended to abstract the functions associated with storing and managing keys so that the protocol user does not have to be aware of the specific KMS providing the service, it can also be used by callers which must interact directly with a specific KMS. For these users, the protocol manages the connection to the KMS while the user controls the operational interface via a client data pass thru function.

The **EFI\_KMS\_SERVICE\_PROTOCOL** provides the capability for the caller to pass arbitrary data to the KMS or to receive such data back from the KMS via parameters on most functions. The use of such data is at the discretion of the caller, but it should only be used sparingly as it reduces the interoperability of the caller's software.

## EFI\_KMS\_PROTOCOL.GetServiceStatus()

### Summary

Get the current status of the key management service.

### Prototype

```
typedef
EFI_STATUS
(EFI_API *EFI_KMS_GET_SERVICE_STATUS) (
    IN EFI_KMS_PROTOCOL *This
);
```

### Parameters

*This*

Pointer to the **EFI\_KEY\_MANAGEMENT\_SERVICE\_PROTOCOL** instance.

### Description

The **GetServiceStatus()** function allows the user to query the current status of the KMS and should be called before attempting any operations to the KMS. If the protocol has not been marked as available, then the user must call this function to attempt to initiate the connection to the KMS as it may have been deferred to the first user by the system firmware.

If the connection to the KMS has not yet been established by the system firmware, then this function will attempt to establish the connection, update the protocol structure content as appropriate, and mark the service as available.

### Status Codes Returned

EFI_SUCCESS	The KMS is ready for use.
EFI_NOT_READY	No connection to the KMS is available.
EFI_NO_MAPPING	No valid connection configuration exists for the KMS.
EFI_NO_RESPONSE	No response was received from the KMS.
EFI_DEVICE_ERROR	An error occurred when attempting to access the KMS.
EFI_INVALID_PARAMETER	<i>This</i> is <b>NULL</b> .

## EFI\_KMS\_PROTOCOL.RegisterClient()

### Summary

Register client information with the supported KMS.

### Prototype

```
typedef
EFI_STATUS
(EFI_API *EFI_KMS_REGISTER_CLIENT) (
  IN EFI_KMS_PROTOCOL *This,
  IN EFI_KMS_CLIENT_INFO *Client,
  IN OUT UINTN *ClientDataSize OPTIONAL,
  IN OUT VOID **ClientData OPTIONAL
);
```

### Parameters

<i>This</i>	Pointer to the <b>EFI_KEY_MANAGEMENT_SERVICE_PROTOCOL</b> instance.
<i>Client</i>	Pointer to a valid <b>EFI_KMS_CLIENT_INFO</b> structure.
<i>ClientDataSize</i>	Pointer to the size, in bytes, of an arbitrary block of data specified by the <i>ClientData</i> parameter. This parameter may be <b>NULL</b> , in which case the <i>ClientData</i> parameter will be ignored and no data will be transferred to or from the KMS. If the parameter is not <b>NULL</b> , then <i>ClientData</i> must be a valid pointer. If the value pointed to is 0, no data will be transferred to the KMS, but data may be returned by the KMS. For all non-zero values <i>ClientData</i> will be transferred to the KMS, which may also return data to the caller. In all cases, the value upon return to the caller will be the size of the data block returned to the caller, which will be zero if no data is returned from the KMS.
<i>ClientData</i>	Pointer to a pointer to an arbitrary block of data of <i>ClientDataSize</i> that is to be passed directly to the KMS if it supports the use of client data. This parameter may be <b>NULL</b> if and only if the <i>ClientDataSize</i> parameter is also <b>NULL</b> . Upon return to the caller, <i>ClientData</i> points to a block of data of <i>ClientDataSize</i> that was returned from the KMS. If the returned value for <i>ClientDataSize</i> is zero, then the returned value for <i>ClientData</i> must be <b>NULL</b> and should be ignored by the caller. The KMS protocol consumer is responsible for freeing all valid buffers used for client data regardless of whether they are allocated by the caller for input to the function or by the implementation for output back to the caller.

## Description

The **RegisterClient()** function registers client information with the KMS using a **EFI\_KMS\_CLIENT\_INFO** structure.

There are two methods of handling client information. The caller may supply a client identifier in the **EFI\_KMS\_CLIENT\_INFO** structure prior to making the call along with an optional name string. The client identifier will be passed on to the KMS if it supports client identifiers. If the KMS accepts the client id, then the **EFI\_KMS\_CLIENT\_INFO** structure will be returned to the caller unchanged. If the KMS does not accept the client id, it may simply reject the request, or it may supply an alternate identifier of its own,

The caller may also request a client identifier from the KMS by passing NULL values in the **EFI\_KMS\_CLIENT\_INFO** structure. If the KMS supports this action, it will generate the identifier and return it in the structure. Otherwise, the implementation may generate a unique identifier, returning it in the structure, or it may indicate that the function is unsupported.

The *ClientDataSize* and *ClientData* parameters allow the caller to pass an arbitrary block of data to/from the KMS for uses such as auditing or access control. The KMS protocol implementation does not alter this data block other than to package it for transmission to the KMS. The use of these parameters is optional.

## Status Codes Returned

EFI_SUCCESS	The client information has been accepted by the KMS.
EFI_NOT_READY	No connection to the KMS is available.
EFI_NO_RESPONSE	There was no response from the device or the key server.
EFI_ACCESS_DENIED	Access was denied by the device or the key server.
EFI_DEVICE_ERROR	An error occurred when attempting to access the KMS.
EFI_OUT_OF_RESOURCES	Required resources were not available to perform the function.
EFI_INVALID_PARAMETER	<i>This is NULL.</i>
EFI_UNSUPPORTED	The KMS does not support the use of client identifiers.

## EFI\_KMS\_PROTOCOL.CreateKey()

### Summary

Request that the KMS generate one or more new keys and associate them with key identifiers. The key value(s) is returned to the caller.

### Prototype

```
typedef
EFI_STATUS
(EFI_API *EFI_KMS_CREATE_KEY) (
  IN EFI_KMS_PROTOCOL *This,
  IN EFI_KMS_CLIENT_INFO *Client,
  IN OUT UINT16 *KeyDescriptorCount,
  IN OUT EFI_KMS_KEY_DESCRIPTOR *KeyDescriptors,
  IN OUT UINTN *ClientDataSize OPTIONAL,
  IN OUT VOID **ClientData OPTIONAL
);
```

### Parameters

<i>This</i>	Pointer to this <b>EFI_KMS_PROTOCOL</b> instance.
<i>Client</i>	Pointer to a valid <b>EFI_KMS_CLIENT_INFO</b> structure.
<i>KeyDescriptorCount</i>	Pointer to a count of the number of key descriptors to be processed by this operation. On return, this number will be updated with the number of key descriptors successfully processed.
<i>KeyDescriptors</i>	<p>Pointer to an array of <b>EFI_KMS_KEY_DESCRIPTOR</b> structures which describe the keys to be generated.</p> <p>On input, the <i>KeyIdentifierSize</i> and the <i>KeyIdentifier</i> may specify an identifier to be used for the key, but this is not required. The <i>KeyFormat</i> field must specify a key format GUID reported as supported by the <i>KeyFormats</i> field of the <b>EFI_KMS_PROTOCOL</b>. The value for this field in the first key descriptor will be considered the default value for subsequent key descriptors requested in this operation if those key descriptors have a <b>NULL</b> GUID in the key format field.</p> <p>On output, the <i>KeyIdentifierSize</i> and <i>KeyIdentifier</i> fields will specify an identifier for the key which will be either the original identifier if one was provided, or an identifier generated either by the KMS or the KMS protocol implementation. The <i>KeyFormat</i> field will be updated with the GUID used to generate the key if it was a <b>NULL</b> GUID, and the <i>KeyValue</i> field will contain a pointer to memory containing the key value for the generated key. Memory for both the <i>KeyIdentifier</i> and the <i>KeyValue</i> fields will be allocated with the <b>BOOT_SERVICES_DATA</b> type and must</p>

be freed by the caller when it is no longer needed. Also, the *KeyStatus* field must reflect the result of the request relative to that key.

#### *ClientDataSize*

Pointer to the size, in bytes, of an arbitrary block of data specified by the *ClientData* parameter. This parameter may be **NULL**, in which case the *ClientData* parameter will be ignored and no data will be transferred to or from the KMS. If the parameter is not **NULL**, then *ClientData* must be a valid pointer. If the value pointed to is 0, no data will be transferred to the KMS, but data may be returned by the KMS. For all non-zero values *\*ClientData* will be transferred to the KMS, which may also return data to the caller. In all cases, the value upon return to the caller will be the size of the data block returned to the caller, which will be zero if no data is returned from the KMS.

#### *ClientData*

Pointer to a pointer to an arbitrary block of data of *\*ClientDataSize* that is to be passed directly to the KMS if it supports the use of client data. This parameter may be **NULL** if and only if the *ClientDataSize* parameter is also **NULL**. Upon return to the caller, *\*ClientData* points to a block of data of *\*ClientDataSize* that was returned from the KMS. If the returned value for *\*ClientDataSize* is zero, then the returned value for *\*ClientData* must be **NULL** and should be ignored by the caller. The KMS protocol consumer is responsible for freeing all valid buffers used for client data regardless of whether they are allocated by the caller for input to the function or by the implementation for output back to the caller.

## Description

The **CreateKey()** method requests the generation of one or more new keys, and key identifier and key values are returned to the caller. The support of this function is optional as some key servers do not provide a key generation capability.

The *Client* parameter identifies the caller to the key management service. This identifier may be used for auditing or access control. This parameter is optional unless the KMS requires a client identifier in order to perform the requested action.

The *KeyDescriptorCount* and *KeyDescriptors* parameters are used to specify the key algorithm, size, and attributes for the requested keys. Any number of keys may be requested in a single operation, regardless of whether the KMS supports multiple key definitions in a single request or not. The KMS protocol implementation is responsible for generating the appropriate requests (single/multiple) to the KMS.

The *ClientDataSize* and *ClientData* parameters allow the caller to pass an arbitrary block of data to/from the KMS for uses such as auditing or access control. The KMS protocol



implementation does not alter this data block other than to package it for transmission to the KMS. The use of these parameters is optional.

## Status Codes Returned

The **CreateKey()** function will return a status which indicates the overall status of the request. Note that this may be different from the status reported for individual key requests.

EFI_SUCCESS	Successfully generated and retrieved all requested keys.
EFI_UNSUPPORTED	This function is not supported by the KMS. --OR-- One (or more) of the key requests submitted is not supported by the KMS. Check individual key request(s) to see which ones may have been processed.
EFI_OUT_OF_RESOURCES	Required resources were not available for the operation.
EFI_TIMEOUT	Timed out waiting for device or key server. Check individual key request(s) to see which ones may have been processed.
EFI_ACCESS_DENIED	Access was denied by the device or the key server; OR a <i>ClientId</i> is required by the server and either no id was provided or an invalid id was provided
EFI_DEVICE_ERROR	An error occurred when attempting to access the KMS. Check individual key request(s) to see which ones may have been processed.
EFI_INVALID_PARAMETER	<i>This is NULL, ClientId</i> is required but it is <b>NULL</b> , <i>KeyDescriptorCount</i> is <b>NULL</b> , or <i>Keys</i> is <b>NULL</b>
EFI_NOT_FOUND	One or more <b>EFI_KMS_KEY_DESCRIPTOR</b> structures could not be processed properly. <i>KeyDescriptorCount</i> contains the number of structures which were successfully processed. Individual structures will reflect the status of the processing for that structure.

## EFI\_KMS\_PROTOCOL.GetKey()

### Summary

Retrieve an existing key.

### Prototype

```
typedef
EFI_STATUS
(EFI_API *EFI_KMS_GET_KEY) (
  IN EFI_KMS_PROTOCOL *This,
  IN EFI_KMS_CLIENT_INFO *Client,
  IN OUT UINT16 *KeyDescriptorCount,
  IN OUT EFI_KMS_KEY_DESCRIPTOR *KeyDescriptors,
  IN OUT UINTN *ClientDataSize OPTIONAL,
  IN OUT VOID **ClientData OPTIONAL
);
```

### Parameters

<i>This</i>	Pointer to this <b>EFI_KMS_PROTOCOL</b> instance.
<i>Client</i>	Pointer to a valid <b>EFI_KMS_CLIENT_INFO</b> structure.
<i>KeyDescriptorCount</i>	Pointer to a count of the number of keys to be processed by this operation. On return, this number will be updated with number of keys successfully processed.
<i>KeyDescriptors</i>	Pointer to an array of <b>EFI_KMS_KEY_DESCRIPTOR</b> structures which describe the keys to be retrieved from the KMS. On input, the <i>KeyIdentifierSize</i> and the <i>KeyIdentifier</i> must specify an identifier to be used to retrieve a specific key. All other fields in the descriptor should be <b>NULL</b> . On output, the <i>KeyIdentifierSize</i> and <i>KeyIdentifier</i> fields will be unchanged, while the <i>KeyFormat</i> and <i>KeyValue</i> fields will be updated values associated with this key identifier. Memory for the <i>KeyValue</i> field will be allocated with the <b>BOOT_SERVICES_DATA</b> type and must be freed by the caller when it is no longer needed. Also, the <i>KeyStatus</i> field will reflect the result of the request relative to the individual key descriptor.
<i>ClientDataSize</i>	Pointer to the size, in bytes, of an arbitrary block of data specified by the <i>ClientData</i> parameter. This parameter may be <b>NULL</b> , in which case the <i>ClientData</i> parameter will be ignored and no data will be transferred to or from the KMS. If the parameter is not <b>NULL</b> , then <i>ClientData</i> must be a valid pointer. If the value pointed to is 0, no data will be transferred to the KMS, but data may be returned by the KMS. For all non-zero values <i>ClientData</i> will be transferred to the KMS, which may also return data to the caller. In all cases, the value upon return to the caller will

*ClientData*

be the size of the data block returned to the caller, which will be zero if no data is returned from the KMS.

Pointer to a pointer to an arbitrary block of data of *\*ClientDataSize* that is to be passed directly to the KMS if it supports the use of client data. This parameter may be **NULL** if and only if the *ClientDataSize* parameter is also **NULL**. Upon return to the caller, *\*ClientData* points to a block of data of *\*ClientDataSize* that was returned from the KMS. If the returned value for *\*ClientDataSize* is zero, then the returned value for *\*ClientData* must be **NULL** and should be ignored by the caller. The KMS protocol consumer is responsible for freeing all valid buffers used for client data regardless of whether they are allocated by the caller for input to the function or by the implementation for output back to the caller.

**Description**

The **GetKey()** function retrieves one or more existing keys from the KMS and returns the key values to the caller. This function must be supported by every KMS protocol instance.

The *Client* parameter identifies the caller to the key management service. It may be used for auditing or access control. The use of this parameter is optional unless the KMS requires it in order to perform the requested action.

The *KeyDescriptorCount* and *KeyDescriptors* parameters are used to specify the identifier(s) to be used to retrieve the key values, which will be returned in the *KeyFormat* and *KeyValue* fields of each **EFI\_KMS\_KEY\_DESCRIPTOR** structure. Any number of keys may be requested in a single operation, regardless of whether the KMS supports multiple key definitions in a single request or not. The KMS protocol implementation is responsible for generating the appropriate requests (single/multiple) to the KMS.

The *ClientDataSize* and *ClientData* parameters allow the caller to pass an arbitrary block of data to/from the KMS for uses such as auditing or access control. The KMS protocol implementation does not alter this data block other than to package it for transmission to the KMS. The use of these parameters is optional.

**Status Codes Returned**

The **GetKey()** function will return a status which indicates the overall status of the request. Note that this may be different from the status reported for individual key requests.

EFI_SUCCESS	Successfully retrieved all requested keys.
EFI_OUT_OF_RESOURCES	Could not allocate resources for the method processing.
EFI_TIMEOUT	Timed out waiting for device or key server. Check individual key request(s) to see which ones may have been processed.

EFI_BUFFER_TOO_SMALL	If multiple keys are associated with a single identifier, and the <i>KeyValue</i> buffer does not contain enough structures ( <i>KeyDescriptorCount</i> ) to contain all the key data, then the available structures will be filled and <i>KeyDescriptorCount</i> will be updated to indicate the number of keys which could not be processed.
EFI_ACCESS_DENIED	Access was denied by the device or the key server; OR a <i>ClientId</i> is required by the server and either none or an invalid id was provided
EFI_DEVICE_ERROR	Device or key server error. Check individual key request(s) to see which ones may have been processed.
EFI_INVALID_PARAMETER	<i>This</i> is <b>NULL</b> , <i>ClientId</i> is required but it is <b>NULL</b> , <i>KeyDescriptorCount</i> is <b>NULL</b> , or <i>Keys</i> is <b>NULL</b>
EFI_NOT_FOUND	One or more <b>EFI_KMS_KEY_DESCRIPTOR</b> structures could not be processed properly. <i>KeyDescriptorCount</i> contains the number of structures which were successfully processed. Individual structures will reflect the status of the processing for that structure.
EFI_UNSUPPORTED	The implementation/KMS does not support this function

## EFI\_KMS\_PROTOCOL.AddKey()

### Summary

Add a new key.

### Prototype

```
typedef
EFI_STATUS
(EFI_API *EFI_KMS_ADD_KEY) (
  IN EFI_KMS_PROTOCOL *This,
  IN EFI_KMS_CLIENT_INFO *Client,
  IN OUT UINT16 *KeyDescriptorCount,
  IN OUT EFI_KMS_KEY_DESCRIPTOR *KeyDescriptors,
  IN OUT UINTN *ClientDataSize OPTIONAL,
  IN OUT VOID **ClientData OPTIONAL
);
```

### Parameters

<i>This</i>	Pointer to this <b>EFI_KMS_PROTOCOL</b> instance.
<i>Client</i>	Pointer to a valid <b>EFI_KMS_CLIENT_INFO</b> structure.
<i>KeyDescriptorCount</i>	Pointer to a count of the number of keys to be processed by this operation. On normal returns, this number will be updated with number of keys successfully processed.
<i>KeyDescriptors</i>	Pointer to an array of <b>EFI_KMS_KEY_DESCRIPTOR</b> structures which describe the keys to be added. On input, the <i>KeyId</i> field for first key must contain valid identifier data to be used for adding a key to the KMS. The values for these fields in this key definition will be considered default values for subsequent keys requested in this operation. A value of 0 in any subsequent <i>KeyId</i> field will be replaced with the current default value. The <i>KeyFormat</i> and <i>KeyValue</i> fields for each key to be added must contain consistent values to be associated with the given <i>KeyId</i> . On return, the <i>KeyStatus</i> field will reflect the result of the operation for each key request.
<i>ClientDataSize</i>	Pointer to the size, in bytes, of an arbitrary block of data specified by the <i>ClientData</i> parameter. This parameter may be <b>NULL</b> , in which case the <i>ClientData</i> parameter will be ignored and no data will be transferred to or from the KMS. If the parameter is not <b>NULL</b> , then <i>ClientData</i> must be a valid pointer. If the value pointed to is 0, no data will be transferred to the KMS, but data may be returned by the KMS. For all non-zero values <i>ClientData</i> will be transferred to the KMS, which may also return data to the caller. In all cases, the value upon return to the caller will be the size of the data block returned to the caller, which will be zero if no data is returned from the KMS.

*ClientData*

Pointer to a pointer to an arbitrary block of data of *\*ClientDataSize* that is to be passed directly to the KMS if it supports the use of client data. This parameter may be **NULL** if and only if the *ClientDataSize* parameter is also **NULL**. Upon return to the caller, *\*ClientData* points to a block of data of *\*ClientDataSize* that was returned from the KMS. If the returned value for *\*ClientDataSize* is zero, then the returned value for *\*ClientData* must be **NULL** and should be ignored by the caller. The KMS protocol consumer is responsible for freeing all valid buffers used for client data regardless of whether they are allocated by the caller for input to the function or by the implementation for output back to the caller.

**Description**

The **AddKey()** function registers a new key with the key management service. The support for this method is optional, as not all key servers support importing keys from clients.

The *Client* parameter identifies the caller to the key management service. It may be used for auditing or access control. The use of this parameter is optional unless the KMS requires it in order to perform the requested action.

The *KeyDescriptorCount* and *KeyDescriptors* parameters are used to specify the key identifier, key format and key data to be registered on the. Any number of keys may be registered in a single operation, regardless of whether the KMS supports multiple key definitions in a single request or not. The KMS protocol implementation is responsible for generating the appropriate requests (single/multiple) to the KMS.

The *ClientDataSize* and *ClientData* parameters allow the caller to pass an arbitrary block of data to/from the KMS for uses such as auditing or access control. The KMS protocol implementation does not alter this data block other than to package it for transmission to the KMS. The use of these parameters is optional.

**Status Codes Returned**

The **AddKey()** function will return a status which indicates the overall status of the request. Note that this may be different from the status reported for individual key requests.

EFI_SUCCESS	Successfully added all requested keys.
EFI_OUT_OF_RESOURCES	Could not allocate required resources.
EFI_TIMEOUT	Timed out waiting for device or key server. Check individual key request(s) to see which ones may have been processed.
EFI_BUFFER_TOO_SMALL	If multiple keys are associated with a single identifier, and the <i>KeyValue</i> buffer does not contain enough structures ( <i>KeyDescriptorCount</i> ) to contain all the key data, then the available structures will be filled and <i>KeyDescriptorCount</i> will be updated to indicate the number of keys which could not be processed.

EFI_ACCESS_DENIED	Access was denied by the device or the key server; OR a <i>ClientId</i> is required by the server and either none or an invalid id was provided
EFI_DEVICE_ERROR	Device or key server error. Check individual key request(s) to see which ones may have been processed.
EFI_INVALID_PARAMETER	<i>This is NULL, ClientId</i> is required but it is <b>NULL</b> , <i>KeyDescriptorCount</i> is <b>NULL</b> , or <i>Keys</i> is <b>NULL</b>
EFI_NOT_FOUND	One or more <b>EFI_KMS_KEY_DESCRIPTOR</b> structures could not be processed properly. <i>KeyDescriptorCount</i> contains the number of structures which were successfully processed. Individual structures will reflect the status of the processing for that structure.
EFI_UNSUPPORTED	The implementation/KMS does not support this function

## EFI\_KMS\_PROTOCOL.DeleteKey()

### Summary

Delete an existing key from the KMS database.

### Prototype

```
typedef
EFI_STATUS
(EFI_API *EFI_KMS_DELETE_KEY) (
  IN EFI_KMS_PROTOCOL *This,
  IN EFI_KMS_CLIENT_INFO *Client,
  IN OUT UINT16 *KeyDescriptorCount,
  IN OUT EFI_KMS_KEY_DESCRIPTOR *KeyDescriptors,
  IN OUT UINTN *ClientDataSize OPTIONAL,
  IN OUT VOID **ClientData OPTIONAL
);
```

### Parameters

<i>This</i>	Pointer to this <b>EFI_KMS_PROTOCOL</b> instance.
<i>Client</i>	Pointer to a valid <b>EFI_KMS_CLIENT_INFO</b> structure.
<i>KeyDescriptorCount</i>	Pointer to a count of the number of keys to be processed by this operation. On normal returns, this number will be updated with number of keys successfully processed.
<i>KeyDescriptors</i>	Pointer to an array of <b>EFI_KMS_KEY_DESCRIPTOR</b> structures which describe the keys to be deleted. On input, the <i>KeyId</i> field for first key must contain valid identifier data to be used for adding a key to the KMS. The values for these fields in this key definition will be considered default values for subsequent keys requested in this operation. A value of 0 in any subsequent <i>KeyId</i> field will be replaced with the current default value. The <i>KeyFormat</i> and <i>KeyValue</i> fields are ignored, but should be 0. On return, the <i>KeyStatus</i> field will reflect the result of the operation for each key request.
<i>ClientDataSize</i>	Pointer to the size, in bytes, of an arbitrary block of data specified by the <i>ClientData</i> parameter. This parameter may be <b>NULL</b> , in which case the <i>ClientData</i> parameter will be ignored and no data will be transferred to or from the KMS. If the parameter is not <b>NULL</b> , then <i>ClientData</i> must be a valid pointer. If the value pointed to is 0, no data will be transferred to the KMS, but data may be returned by the KMS. For all non-zero values <i>ClientData</i> will be transferred to the KMS, which may also return data to the caller. In all cases, the value upon return to the caller will be the size of the data block returned to the caller, which will be zero if no data is returned from the KMS.



*ClientData*

Pointer to a pointer to an arbitrary block of data of *\*ClientDataSize* that is to be passed directly to the KMS if it supports the use of client data. This parameter may be **NULL** if and only if the *ClientDataSize* parameter is also **NULL**. Upon return to the caller, *\*ClientData* points to a block of data of *\*ClientDataSize* that was returned from the KMS. If the returned value for *\*ClientDataSize* is zero, then the returned value for *\*ClientData* must be **NULL** and should be ignored by the caller. The KMS protocol consumer is responsible for freeing all valid buffers used for client data regardless of whether they are allocated by the caller for input to the function or by the implementation for output back to the caller.

**Description**

The **DeleteKey()** function deregisters an existing key from the device or KMS. The support for this method is optional, as not all key servers support deleting keys from clients.

The *Client* parameter identifies the caller to the key management service. It may be used for auditing or access control. The use of this parameter is optional unless the KMS requires it in order to perform the requested action.

The *KeyDescriptorCount* and *KeyDescriptors* parameters are used to specify the key identifier(s) for the keys to be deleted. Any number of keys may be deleted in a single operation, regardless of whether the KMS supports multiple key definitions in a single request or not. The KMS protocol implementation is responsible for generating the appropriate requests (single/multiple) to the KMS.

The *ClientDataSize* and *ClientData* parameters allow the caller to pass an arbitrary block of data to/from the KMS for uses such as auditing or access control. The KMS protocol implementation does not alter this data block other than to package it for transmission to the KMS. The use of these parameters is optional.

**Status Codes Returned**

The **DeleteKey()** function will return a status which indicates the overall status of the request. Note that this may be different from the status reported for individual key requests.

EFI_SUCCESS	Successfully deleted all requested keys.
EFI_OUT_OF_RESOURCES	Could not allocate required resources.
EFI_TIMEOUT	Timed out waiting for device or key server. Check individual key request(s) to see which ones may have been processed.
EFI_ACCESS_DENIED	Access was denied by the device or the key server; OR a <i>ClientId</i> is required by the server and either none or an invalid id was provided
EFI_DEVICE_ERROR	Device or key server error. Check individual key request(s) to see which ones may have been processed.
EFI_INVALID_PARAMETER	<i>This is NULL, ClientId</i> is required but it is <b>NULL</b> , <i>KeyDescriptorCount</i> is <b>NULL</b> , or <i>Keys</i> is <b>NULL</b>

EFI_NOT_FOUND	One or more <b>EFI_KMS_KEY_DESCRIPTOR</b> structures could not be processed properly. <i>KeyDescriptorCount</i> contains the number of structures which were successfully processed. Individual structures will reflect the status of the processing for that structure.
EFI_UNSUPPORTED	The implementation/KMS does not support this function

## EFI\_KMS\_PROTOCOL.GetKeyAttributes()

### Summary

Get one or more attributes associated with a specified key identifier. If none are found, the returned attributes count contains a value of zero.

### Prototype

```
typedef
EFI_STATUS
(EFI_API *EFI_KMS_GET_KEY_ATTRIBUTES) (
    IN EFI_KMS_PROTOCOL *This,
    IN EFI_KMS_CLIENT_INFO *Client,
    IN UINT8 *KeyIdentifierSize,
    IN CONST VOID *KeyIdentifier,
    IN OUT UINT16 *KeyAttributesCount,
    IN OUT EFI_KMS_KEY_ATTRIBUTE *KeyAttributes,
    IN OUT UINTN *ClientDataSize OPTIONAL,
    IN OUT VOID **ClientData OPTIONAL
);
```

### Parameters

<i>This</i>	Pointer to this <b>EFI_KMS_PROTOCOL</b> instance.
<i>Client</i>	Pointer to a valid <b>EFI_KMS_CLIENT_INFO</b> structure.
<i>KeyIdentifierSize</i>	Pointer to the size in bytes of the <i>KeyIdentifier</i> variable.
<i>KeyIdentifier</i>	Pointer to the key identifier associated with this key.
<i>KeyAttributesCount</i>	Pointer to the number of <b>EFI_KMS_KEY_ATTRIBUTE</b> structures associated with the Key identifier. If none are found, the count value is zero on return. On input this value reflects the number of <i>KeyAttributes</i> that may be returned. On output, the value reflects the number of completed <i>KeyAttributes</i> structures found.
<i>KeyAttributes</i>	Pointer to an array of <b>EFI_KMS_KEY_ATTRIBUTE</b> structures associated with the Key Identifier. On input, the fields in the structure should be <b>NULL</b> . On output, the attribute fields will have updated values for attributes associated with this key identifier.
<i>ClientDataSize</i>	Pointer to the size, in bytes, of an arbitrary block of data specified by the <i>ClientData</i> parameter. This parameter may be <b>NULL</b> , in which case the <i>ClientData</i> parameter will be ignored and no data will be transferred to or from the KMS. If the parameter is not <b>NULL</b> , then <i>ClientData</i> must be a valid pointer. If the value pointed to is 0, no data will be transferred to the KMS, but data may be returned by the KMS. For all non-zero values <i>ClientData</i> will be transferred to the KMS, which may also return data to the caller. In all cases, the value upon return to the caller will

*ClientData*

be the size of the data block returned to the caller, which will be zero if no data is returned from the KMS.

Pointer to a pointer to an arbitrary block of data of *\*ClientDataSize* that is to be passed directly to the KMS if it supports the use of client data. This parameter may be **NULL** if and only if the *ClientDataSize* parameter is also **NULL**. Upon return to the caller, *\*ClientData* points to a block of data of *\*ClientDataSize* that was returned from the KMS. If the returned value for *\*ClientDataSize* is zero, then the returned value for *\*ClientData* must be **NULL** and should be ignored by the caller. The KMS protocol consumer is responsible for freeing all valid buffers used for client data regardless of whether they are allocated by the caller for input to the function or by the implementation for output back to the caller.

**Description**

The **GetKeyAttributes()** function returns one or more attributes for a key.

The *ClientIdentifierSize* and *ClientIdentifier* parameters identify the caller to the key management service. It may be used for auditing or access control. The use of this parameter is optional unless the KMS requires it in order to perform the requested action.

The *KeyIdentifierSize* and *KeyIdentifier* parameters identify the key whose attributes are to be returned by the key management service. They may be used to retrieve additional information about a key, whose format is defined by the KeyAttribute. Attributes returned may be of the same or different names.

The *ClientDataSize* and *ClientData* parameters allow the caller to pass an arbitrary block of data to/from the KMS for uses such as auditing or access control. The KMS protocol implementation does not alter this data block other than to package it for transmission to the KMS. The use of these parameters is optional unless the KMS requires it in order to perform the requested action.

**Status Codes Returned**

The **GetKeyAttributes()** function will return a status which indicates the overall status of the request. Note that this may be different from the status reported for individual key attribute requests.

EFI_SUCCESS	Successfully retrieved all key attributes.
EFI_OUT_OF_RESOURCES	Could not allocate resources for the method processing.
EFI_TIMEOUT	Timed out waiting for device or key server. Check individual key attribute request(s) to see which ones may have been processed.

EFI_BUFFER_TOO_SMALL	If multiple key attributes are associated with a single identifier, and the <i>KeyAttributes</i> buffer does not contain enough structures ( <i>KeyAttributesCount</i> ) to contain all the key attributes data, then the available structures will be filled and <i>KeyAttributesCount</i> will be updated to indicate the number of key attributes which could not be processed.
EFI_ACCESS_DENIED	Access was denied by the device or the key server; OR a <i>ClientId</i> is required by the server and either none or an invalid id was provided
EFI_DEVICE_ERROR	Device or key server error. Check individual key attribute request(s) (i.e., key attribute status for each) to see which ones may have been processed.
EFI_INVALID_PARAMETER	This is <b>NULL</b> , <i>ClientId</i> is required but it is <b>NULL</b> , <i>KeyIdentifierSize</i> is <b>NULL</b> , or <i>KeyIdentifier</i> is <b>NULL</b> , or <i>KeyAttributes</i> is <b>NULL</b> , or <i>KeyAttributesSize</i> is <b>NULL</b> .
EFI_NOT_FOUND	The <i>KeyIdentifier</i> could not be found. <i>KeyAttributesCount</i> contains zero. Individual structures will reflect the status of the processing for that structure.
EFI_UNSUPPORTED	The implementation/KMS does not support this function

## EFI\_KMS\_PROTOCOL.AddKeyAttributes()

### Summary

Add one or more attributes to a key specified by a key identifier.

### Prototype

```
typedef
EFI_STATUS
(EFI_API *EFI_KMS_ADD_KEY_ATTRIBUTES) (
  IN EFI_KMS_PROTOCOL *This,
  IN EFI_KMS_CLIENT_INFO *Client,
  IN UINT *KeyIdentifierSize,
  IN CONST VOID *KeyIdentifier,
  IN OUT UINT16 *KeyAttributesCount,
  IN OUT EFI_KMS_KEY_ATTRIBUTE *KeyAttributes,
  IN OUT UINTN *ClientDataSize OPTIONAL,
  IN OUT VOID **ClientData OPTIONAL
);
```

### Parameters

<i>This</i>	Pointer to this <b>EFI_KMS_PROTOCOL</b> instance.
<i>Client</i>	Pointer to a valid <b>EFI_KMS_CLIENT_INFO</b> structure.
<i>KeyIdentifierSize</i>	Pointer to the size in bytes of the <i>KeyIdentifier</i> variable.
<i>KeyIdentifier</i>	Pointer to the key identifier associated with this key.
<i>KeyAttributesCount</i>	Pointer to the number of <b>EFI_KMS_KEY_ATTRIBUTE</b> structures to associate with the Key. On normal returns, this number will be updated with the number of key attributes successfully processed.
<i>KeyAttributes</i>	Pointer to an array of <b>EFI_KMS_KEY_ATTRIBUTE</b> structures providing the attribute information to associate with the key. On input, the values for the fields in the structure are completely filled in. On return the <i>KeyAttributeStatus</i> field will reflect the result of the operation for each key attribute request.
<i>ClientDataSize</i>	Pointer to the size, in bytes, of an arbitrary block of data specified by the <i>ClientData</i> parameter. This parameter may be <b>NULL</b> , in which case the <i>ClientData</i> parameter will be ignored and no data will be transferred to or from the KMS. If the parameter is not <b>NULL</b> , then <i>ClientData</i> must be a valid pointer. If the value pointed to is 0, no data will be transferred to the KMS, but data may be returned by the KMS. For all non-zero values <i>ClientData</i> will be transferred to the KMS, which may also return data to the caller. In all cases, the value upon return to the caller will be the size of the data block returned to the caller, which will be zero if no data is returned from the KMS.

*ClientData*

Pointer to a pointer to an arbitrary block of data of *\*ClientDataSize* that is to be passed directly to the KMS if it supports the use of client data. This parameter may be **NULL** if and only if the *ClientDataSize* parameter is also **NULL**. Upon return to the caller, *\*ClientData* points to a block of data of *\*ClientDataSize* that was returned from the KMS. If the returned value for *\*ClientDataSize* is zero, then the returned value for *\*ClientData* must be **NULL** and should be ignored by the caller. The KMS protocol consumer is responsible for freeing all valid buffers used for client data regardless of whether they are allocated by the caller for input to the function or by the implementation for output back to the caller.

**Description**

The **AddKeyAttributes()** function adds one or more key attributes. If this function is not supported by a KMS protocol instance then it is assumed that there is an alternative means available for attribute management in the KMS.

The *Client* parameters identify the caller to the key management service. It may be used for auditing or access control. The use of this parameter is optional unless the KMS requires it in order to perform the requested action.

The *KeyIdentifierSize* and *KeyIdentifier* parameters identify the key whose attributes are to be modified by the key management service

The *KeyAttributesCount* and *KeyAttributes* parameters are used to specify the key attributes data to be registered on the KMS. Any number of attributes may be registered in a single operation, regardless of whether the KMS supports multiple key attribute definitions in a single request or not. The KMS protocol implementation is responsible for generating the appropriate requests (single/multiple) to the KMS. In certain error situations, the status of each attribute is updated indicating if that attribute was successfully registered or not.

The *ClientDataSize* and *ClientData* parameters allow the caller to pass an arbitrary block of data to/from the KMS for uses such as auditing or access control. The KMS protocol implementation does not alter this data block other than to package it for transmission to the KMS. The use of these parameters is optional unless the KMS requires it in order to perform the requested action.

**Status Codes Returned**

The **AddKeyAttributes()** function will return a status which indicates the overall status of the request. Note that this may be different from the status reported for individual key attribute requests. Status codes returned for **AddKeyAttributes()** are:

EFI_SUCCESS	Successfully added all requested key attributes.
EFI_OUT_OF_RESOURCES	Could not allocate required resources.
EFI_TIMEOUT	Timed out waiting for device or key server. Check individual key attribute request(s) to see which ones may have been processed.

EFI_BUFFER_TOO_SMALL	If multiple keys attributes are associated with a single key identifier, and the <i>attributes</i> buffer does not contain enough structures ( <i>KeyAttributesCount</i> ) to contain all the data, then the available structures will be filled and <i>KeyAttributesCount</i> will be updated to indicate the number of key attributes which could not be processed. The status of each key attribute is also updated indicating success or failure for that attribute in case there are other errors for those attributes that could be processed.
EFI_ACCESS_DENIED	Access was denied by the device or the key server; OR a <i>ClientId</i> is required by the server and either none or an invalid id was provided
EFI_DEVICE_ERROR	Device or key server error. Check individual key attribute request(s) (i.e., key attribute status for each) to see which ones may have been processed.
EFI_INVALID_PARAMETER	This is <b>NULL</b> , <i>ClientId</i> is required but it is <b>NULL</b> , <i>KeyAttributesCount</i> is <b>NULL</b> , or <i>KeyAttributes</i> is <b>NULL</b> , or <i>KeyIdentifierSize</i> is <b>NULL</b> , or <i>KeyIdentifier</i> is <b>NULL</b> .
EFI_NOT_FOUND	The <i>KeyIdentifier</i> could not be found. On return the <i>KeyAttributesCount</i> contains the number of attributes processed. Individual structures will reflect the status of the processing for that structure.
EFI_UNSUPPORTED	The implementation/KMS does not support this function



## EFI\_KMS\_PROTOCOL.DeleteKeyAttributes()

### Summary

Delete attributes to a key specified by a key identifier.

### Prototype

```
typedef
EFI_STATUS
(EFI_API *EFI_KMS_DELETE_KEY_ATTRIBUTES) (
  IN EFI_KMS_PROTOCOL *This,
  IN EFI_KMS_CLIENT_INFO *Client,
  IN UINT8 *KeyIdentifierSize,
  IN CONST VOID *KeyIdentifier,
  IN OUT UINT16 *KeyAttributesCount,
  IN OUT EFI_KMS_KEY_ATTRIBUTE *KeyAttributes,
  IN OUT UINTN *ClientDataSize OPTIONAL,
  IN OUT VOID **ClientData OPTIONAL
);
```

### Parameters

<i>This</i>	Pointer to this <b>EFI_KMS_PROTOCOL</b> instance.
<i>Client</i>	Pointer to a valid <b>EFI_KMS_CLIENT_INFO</b> structure.
<i>KeyIdentifierSize</i>	Pointer to the size in bytes of the <i>KeyIdentifier</i> variable.
<i>KeyIdentifier</i>	Pointer to the key identifier associated with this key.
<i>KeyAttributesCount</i>	Pointer to the number of <b>EFI_KMS_KEY_ATTRIBUTE</b> structures associated with the Key. On input, the count value is one or more. On normal returns, this number will be updated with the number of key attributes successfully processed.
<i>KeyAttributes</i>	Pointer to an array of <b>EFI_KMS_KEY_ATTRIBUTE</b> structures associated with the key. On input, the values for the fields in the structure are completely filled in. On return the <i>KeyAttributeStatus</i> field will reflect the result of the operation for each key attribute request.
<i>ClientDataSize</i>	Pointer to the size, in bytes, of an arbitrary block of data specified by the <i>ClientData</i> parameter. This parameter may be <b>NULL</b> , in which case the <i>ClientData</i> parameter will be ignored and no data will be transferred to or from the KMS. If the parameter is not <b>NULL</b> , then <i>ClientData</i> must be a valid pointer. If the value pointed to is 0, no data will be transferred to the KMS, but data may be returned by the KMS. For all non-zero values <i>ClientData</i> will be transferred to the KMS, which may also return data to the caller. In all cases, the value upon return to the caller will be the size of the data block returned to the caller, which will be zero if no data is returned from the KMS.

*ClientData*

Pointer to a pointer to an arbitrary block of data of *\*ClientDataSize* that is to be passed directly to the KMS if it supports the use of client data. This parameter may be **NULL** if and only if the *ClientDataSize* parameter is also **NULL**. Upon return to the caller, *\*ClientData* points to a block of data of *\*ClientDataSize* that was returned from the KMS. If the returned value for *\*ClientDataSize* is zero, then the returned value for *\*ClientData* must be **NULL** and should be ignored by the caller. The KMS protocol consumer is responsible for freeing all valid buffers used for client data regardless of whether they are allocated by the caller for input to the function or by the implementation for output back to the caller.

**Description**

The **DeleteKeyAttributes()** function removes key attributes for a key with the key management service.

The *Client* parameter identifies the caller to the key management service. It may be used for auditing or access control. The use of this parameter is optional unless the KMS requires it in order to perform the requested action.

The *KeyIdentifierSize* and *KeyIdentifier* parameters identify the key whose attributes are to be modified by the key management service

The *KeyAttributesCount* and *KeyAttributes* parameters are used to specify the key attributes data to be deleted on the KMS. Any number of attributes may be deleted in a single operation, regardless of whether the KMS supports multiple key attribute definitions in a single request or not. The KMS protocol implementation is responsible for generating the appropriate requests (single/multiple) to the KMS. In certain error situations, the status of each attribute is updated indicating if that attribute was successfully deleted or not.

The *KeyAttributesCount* and *KeyAttributes* parameters are used to specify the key attributes data to be deleted on the KMS. Any number of attributes may be deleted in a single operation, regardless of whether the KMS supports multiple key attribute definitions in a single request or not. The KMS protocol implementation is responsible for generating the appropriate requests (single/multiple) to the KMS. In certain error situations, the status of each attribute is updated indicating if that attribute was successfully deleted or not.

The *ClientDataSize* and *ClientData* parameters allow the caller to pass an arbitrary block of data to/from the KMS for uses such as auditing or access control. The KMS protocol implementation does not alter this data block other than to package it for transmission to the KMS. The use of these parameters is optional unless the KMS requires it in order to perform the requested action.

## Status Codes Returned

The **DeleteKeyAttributes()** function will return a status which indicates the overall status of the request. Note that this may be different from the status reported for individual key attribute requests. Status codes returned for the method are:

EFI_SUCCESS	Successfully deleted all requested key attributes.
EFI_OUT_OF_RESOURCES	Could not allocate required resources.
EFI_TIMEOUT	Timed out waiting for device or key server. Check individual key attribute request(s) to see which ones may have been processed.
EFI_ACCESS_DENIED	Access was denied by the device or the key server; OR a <i>ClientId</i> is required by the server and either none or an invalid id was provided
EFI_DEVICE_ERROR	Device or key server error. Check individual key attribute request(s) (i.e., key attribute status for each) to see which ones may have been processed.
EFI_INVALID_PARAMETER	<i>This is NULL, ClientId</i> is required but it is <b>NULL</b> , <i>KeyAttributesCount</i> is <b>NULL</b> , or <i>KeyAttributes</i> is <b>NULL</b> , or <i>KeyIdentifierSize</i> is <b>NULL</b> , or <i>KeyIdentifier</i> is <b>NULL</b> .
EFI_NOT_FOUND	The <i>KeyIdentifier</i> could not be found or the attribute could not be found. On return the <i>KeyAttributesCount</i> contains the number of attributes processed. Individual structures will reflect the status of the processing for that structure.
EFI_UNSUPPORTED	The implementation/KMS does not support this function

## EFI\_KMS\_PROTOCOL.GetKeyByAttributes()

### Summary

Retrieve one or more key that has matched all of the specified key attributes.

### Prototype

```
typedef
EFI_STATUS
(EFIAPI *EFI_KMS_GET_KEY_BY_ATTRIBUTES) (
  IN EFI_KMS_PROTOCOL *This,
  IN EFI_KMS_CLIENT_INFO *Client,
  IN UINTN *KeyAttributeCount,
  IN OUT EFI_KMS_KEY_ATTRIBUTE *KeyAttributes,
  IN OUT UINTN *KeyDescriptorCount,
  IN OUT EFI_KMS_KEY_DESCRIPTOR *KeyDescriptors,
  IN OUT UINTN *ClientDataSize OPTIONAL,
  IN OUT VOID **ClientData OPTIONAL
);
```

### Parameters

<i>This</i>	Pointer to this <b>EFI_KMS_PROTOCOL</b> instance.
<i>Client</i>	Pointer to a valid <b>EFI_KMS_CLIENT_INFO</b> structure.
<i>KeyAttributeCount</i>	Pointer to a count of the number of key attribute structures that must be matched for each returned key descriptor. On input the count value is one or more. On normal returns, this number will be updated with the number of key attributes successfully processed.
<i>KeyAttributes</i>	Pointer to an array of <b>EFI_KMS_KEY_ATTRIBUTE</b> structure to search for. On input, the values for the fields in the structure are completely filled in. On return the <i>KeyAttributeStatus</i> field will reflect the result of the operation for each key attribute request.
<i>KeyDescriptorCount</i>	Pointer to a count of the number of key descriptors matched by this operation. On entry, this number will be zero. On return, this number will be updated to the number of key descriptors successfully found.
<i>KeyDescriptors</i>	Pointer to an array of <b>EFI_KMS_KEY_DESCRIPTOR</b> structures which describe the keys from the KMS having the <i>KeyAttribute(s)</i> specified. On input, this pointer will be <b>NULL</b> . On output, the array will contain an <b>EFI_KMS_KEY_DESCRIPTOR</b> structure for each key meeting the search criteria. Memory for the array and all <i>KeyValue</i> fields will be allocated with the <i>EfiBootServicesData</i> type and must be freed by the caller when it is no longer needed. Also, the <i>KeyStatus</i> field of

each descriptor will reflect the result of the request relative to that key descriptor.

### *ClientDataSize*

Pointer to the size, in bytes, of an arbitrary block of data specified by the *ClientData* parameter. This parameter may be **NULL**, in which case the *ClientData* parameter will be ignored and no data will be transferred to or from the KMS. If the parameter is not **NULL**, then *ClientData* must be a valid pointer. If the value pointed to is 0, no data will be transferred to the KMS, but data may be returned by the KMS. For all non-zero values *\*ClientData* will be transferred to the KMS, which may also return data to the caller. In all cases, the value upon return to the caller will be the size of the data block returned to the caller, which will be zero if no data is returned from the KMS.

### *ClientData*

Pointer to a pointer to an arbitrary block of data of *\*ClientDataSize* that is to be passed directly to the KMS if it supports the use of client data. This parameter may be **NULL** if and only if the *ClientDataSize* parameter is also **NULL**. Upon return to the caller, *\*ClientData* points to a block of data of *\*ClientDataSize* that was returned from the KMS. If the returned value for *\*ClientDataSize* is zero, then the returned value for *\*ClientData* must be **NULL** and should be ignored by the caller. The KMS protocol consumer is responsible for freeing all valid buffers used for client data regardless of whether they are allocated by the caller for input to the function or by the implementation for output back to the caller.

## Description

The **GetKeyByAttributes()** function returns the keys found by searches for matching key attribute(s). This function must be supported by every KMS protocol instance that supports the use of key attributes as indicated in the protocol's *KeyAttributesSupported* field.

The *Client* parameter identifies the caller to the key management service. It may be used for auditing or access control. The use of this parameter is optional unless the KMS requires it in order to perform the requested action.

The *KeyAttributesCount* and *KeyAttributes* parameters are used to specify the key attributes data to be searched for on the KMS. Any number of attributes may be searched for in a single operation, regardless of whether the KMS supports multiple key attribute definitions in a single request or not. The KMS protocol implementation is responsible for generating the appropriate requests (single/multiple) to the KMS. In certain error situations, the status of each attribute is updated indicating if that attribute was successfully found or not. If an attribute specifies a wildcard *KeyAttributeInstance* value, then the provider returns all instances of the attribute.

The *KeyDescriptorCount* and *KeyDescriptors* parameters are used to return the **EFI\_KMS\_KEY\_DESCRIPTOR** structures for keys meeting the search criteria. Any number of keys may be returned in a single operation, regardless of whether the KMS supports

multiple key definitions in a single request or not. The KMS protocol implementation is responsible for generating the appropriate requests (single/multiple) to the KMS.

The *ClientDataSize* and *ClientData* parameters allow the caller to pass an arbitrary block of data to/from the KMS for uses such as auditing or access control. The KMS protocol implementation does not alter this data block other than to package it for transmission to the KMS. The use of these parameters is optional unless the KMS requires it in order to perform the requested action.

## Status Codes Returned

The **GetKeyByAttributes()** function will return a status which indicates the overall status of the request. Note that this may be different from the status reported for individual keys.

EFI_SUCCESS	Successfully retrieved all requested keys.
EFI_OUT_OF_RESOURCES	Could not allocate required resources.
EFI_TIMEOUT	Timed out waiting for device or key server. Check individual key attribute request(s) to see which ones may have been processed.
EFI_BUFFER_TOO_SMALL	If multiple keys are associated with the attribute(s), and the <i>KeyValue</i> buffer does not contain enough structures ( <i>KeyDescriptorCount</i> ) to contain all the key data, then the available structures will be filled and <i>KeyDescriptorCount</i> will be updated to indicate the number of keys which could not be processed.
EFI_ACCESS_DENIED	Access was denied by the device or the key server; OR a <i>ClientId</i> is required by the server and either none or an invalid id was provided
EFI_DEVICE_ERROR	Device or key server error. Check individual key attribute request(s) (i.e., key attribute status for each) to see which ones may have been processed.
EFI_INVALID_PARAMETER	<i>This</i> is NULL, <i>ClientId</i> is required but it is NULL, <i>KeyDescriptorCount</i> is NULL, or <i>KeyDescriptors</i> is NULL or <i>KeyAttributes</i> is NULL, or <i>KeyAttributesCount</i> is NULL.
EFI_NOT_FOUND	One or more <b>EFI_KMS_KEY_ATTRIBUTE</b> structures could not be processed properly. <i>KeyAttributeCount</i> contains the number of structures which were successfully processed. Individual structures will reflect the status of the processing for that structure.
EFI_UNSUPPORTED	The implementation/KMS does not support this function

## 36.4 PKCS7 Verify Protocol

### EFI\_PKCS7\_VERIFY\_PROTOCOL

#### Summary

The **EFI\_PKCS7\_VERIFY\_PROTOCOL** may be used to verify data signed with PKCS#7 formatted authentication. The PKCS#7 data to be verified must be binary DER encoded. Additional information on the supported ASN.1 formatting is provided below.

Drivers that supply PKCS7 verification function should publish the **EFI\_PKCS7\_VERIFY\_PROTOCOL**. Drivers wishing to use the **EFI\_PKCS7\_VERIFY\_PROTOCOL** may get a reference with **LocateProtocol()**.

#### GUID

```
#define EFI_PKCS7_VERIFY_PROTOCOL_GUID \
{ 0x47889fb2, 0xd671, 0x4fab, \
  { 0xa0, 0xca, 0xdf, 0xe, 0x44, \ 0xdf, 0x70, 0xd6 }}
```

#### Protocol Interface Structure

```
typedef struct _EFI_PKCS7_VERIFY_PROTOCOL {
  EFI_PKCS7_VERIFY_BUFFER VerifyBuffer;
  EFI_PKCS7_VERIFY_SIGNATURE VerifySignature;
} EFI_PKCS7_VERIFY_PROTOCOL;
```

#### Parameters

<i>VerifyBuffer</i>	Examine a DER-encoded PKCS7-signed memory buffer with signature containing embedded data content, or buffer with detached signature and separate data content buffer, and verify using supplied signature lists.
<i>VerifySignature</i>	Examine a DER-encoded PKCS7-signed memory buffer with signature and, using caller-supplied hash value for signed data, verify using supplied signature lists.

#### Description

The **EFI\_PKCS7\_VERIFY\_PROTOCOL** is used to verify data signed using PKCS7 structure. PKCS7 is a general-purpose cryptographic standard (see references). The PKCS7 data to be verified must be ASN.1 (DER) encoded. Implementation must support SHA256 as digest algorithm with RSA digest encryption. Support of other hash algorithms is optional. See [Table 226](#).

Table 226. Details of Supported Signature Format.

Signature Buffer Format Details	
Encoding	Binary DER
ASN.1 root of Embedded Signed Data	ContentInfo with <i>SignedData</i> content type
ASN.1 root of Detached Signature	<i>SignedData</i> or ContentInfo with <i>SignedData</i> content type
Embedded Data Type	Typically 'Data' (1.2.840.113549.1.7.1) or other defined OID type (however caller should not depend upon specialized OID processing during PKCS validation.)
Digest (Hash) Algorithm ( <i>VerifyBuffer</i> function)	Support of SHA-256 (2.16.840.1.101.3.4.2.1) is required, other algorithms are optional
Digest Encryption	RSA (1.2.840.113549.1.1.1)
Certificate validity dates	See <i>TimeStampDb</i> description
Signature authenticatedAttributes	Ignored by function
Timestamping	See <i>TimeStampDb</i> description

## References

PKCS7 is defined by RFC2315. For more information see "Links to UEFI-Related Documents" (<http://uefi.org/uefi>) under the heading "RFC2315 (defines PKCS7)".



## EFI\_PKCS7\_VERIFY\_PROTOCOL.VerifyBuffer()

### Summary

This function processes a buffer containing binary DER-encoded PKCS7 signature. The signed data content may be embedded within the buffer or separated. Function verifies the signature of the content is valid and signing certificate was not revoked and is contained within a list of trusted signers.

### Prototype

```
typedef
EFI_STATUS
(EFIAPI *VerifyBuffer)(
    IN EFI_PKCS7_VERIFY_PROTOCOL * This,
    IN VOID          *SignedData,
    IN UINTN         SignedDataSize,
    IN VOID          *InData OPTIONAL,
    IN UINTN         InDataSize
    IN EFI_SIGNATURE_LIST **AllowedDb,
    IN EFI_SIGNATURE_LIST **RevokedDb OPTIONAL,
    IN EFI_SIGNATURE_LIST **TimeStampDb OPTIONAL,
    OUT VOID          *Content OPTIONAL,
    IN OUT UINTN      *ContentSize
);
```

### Parameters

<i>This</i>	Pointer to <b>EFI_PKCS7_VERIFY_PROTOCOL</b> instance.
<i>SignedData</i>	Points to buffer containing ASN.1 DER-encoded PKCS signature.
<i>SignedDataSize</i>	The size of <i>SignedData</i> buffer in bytes.
<i>InData</i>	In case of detached signature, <i>InData</i> points to buffer containing the raw message data previously signed and to be verified by function. In case of <i>SignedData</i> containing embedded data, <i>InData</i> must be NULL.
<i>InDataSize</i>	When <i>InData</i> is used, the size of <i>InData</i> buffer in bytes. When <i>InData</i> is NULL, this parameter must be 0.
<i>AllowedDb</i>	Pointer to a list of pointers to <b>EFI_SIGNATURE_LIST</b> structures. The list is terminated by a null pointer. The <b>EFI_SIGNATURE_LIST</b> structures contain lists of X.509 certificates of approved signers. See Chapter 27 for definition of <b>EFI_SIGNATURE_LIST</b> . Function recognizes signer certificates of type <b>EFI_CERT_X509_GUID</b> . Any hash certificate in <i>AllowedDb</i> list is ignored by this function. Function returns success if signer of the buffer is within this list (and not within <i>RevokedDb</i> ). This parameter is required.

<i>RevokedDb</i>	Optional pointer to a list of pointers to <b>EFI_SIGNATURE_LIST</b> structures. The list is terminated by a null pointer. List of X.509 certificates of revoked signers and revoked file hashes. Except as noted in description of <i>TimeStampDb</i> , signature verification will always fail if the signer of the file or the hash of the data component of the buffer is in <i>RevokedDb</i> list. This list is optional and caller may pass Null or pointer to NULL if not required.
<i>TimeStampDb</i>	Optional pointer to a list of pointers to <b>EFI_SIGNATURE_LIST</b> structures. The list is terminated by a null pointer. This parameter can be used to pass a list of X.509 certificates of trusted time stamp signers. This list is optional and caller may pass Null or pointer to NULL if not required.
<i>Content</i>	On input, points to an optional caller-allocated buffer into which the function will copy the content portion of the file after verification succeeds. This parameter is optional and if NULL, no copy of content from file is performed.
<i>ContentSize</i>	On input, points to the size in bytes of the optional buffer <i>Content</i> previously allocated by caller. On output, if the verification succeeds, the value referenced by <i>ContentSize</i> will contain the actual size of the content from signed file. If <i>ContentSize</i> indicates the caller-allocated buffer is too small to contain content, an error is returned, and <i>ContentSize</i> will be updated with the required size. This parameter must be 0 if <i>Content</i> is Null.

## Description

This function processes the buffer *SignedData* for PKCS7 verification. The data that was signed using PKCS is referred to as the 'Message'. In the process of creating a signature of the message, a SHA256 or other hash of the message bytes, called the 'Message Digest', is encrypted using a private key held in secret by the signer. The encrypted hash and the X.509 public key certificate of the signer are formatted according to the ASN.1 PKCS#7 Schema (See References). For the buffer type with the embedded data, the ASN.1 syntax is also used to wrap the data and combine the message data with the signature structure.

The *SignedData* buffer must be ASN.1 DER-encoded format with structure according to the subset defined in the introduction to this protocol. Both embedded content and detached signature formats are supported. In case of embedded content, *SignedData* contains both the PKCS7 signature structure and the message content that was signed. In the case of detached signature, *SignedData* contains only the signature data and *InData* is used to supply the data to be verified. To pass verification the X.509 public certificate of the signer of the file must be found in *AllowedDb* and not be present in *RevokedDb*. Additionally if *RevokedDb* contains a specific Hash signature that matches the hash calculated for the content, the file will also fail verification. The message content will be copied to the caller-supplied buffer *Content* (when present) with *ContentSize* updated to reflect the total size in bytes of the extracted content.

The **VerifyBuffer()** function performs several steps. First, the buffer containing the user-provided signature is parsed, the content is located and a hash calculated, and the PKCS7 signature of that hash is verified by decrypting the hash calculated at time of signing. Match of current hash with decrypted hash provides indication the structure contained in buffer has not been modified since signing. Next the protocol function attempts to match the signing certificate included within the signed data again the members of an (optional) list of caller-provided revoked certificates (*RevokedDb*). The hash of the data is also compared against any hash items contained in *RevokedDb* list. Next the signing certificate is matched against the caller-provided list of trusted signatures. If the signature is valid, the certificate or hash are not in the revoked list, and the certificate is in the trusted list, the file passes verification.

When *TimeStampDb* list is present this information modifies the processing of revoked certificates found in both *AllowedDb* and *RevokedDb*. When PKCS7 signings that are time-stamped by trusted signer in *TimeStampDb* list, and which time-stamping occurred prior to the time of certificate revocation noted in certificate in *RevokedDb* list, the signing will be allowed and return **EFI\_SUCCESS**. *TimeStampDb* parameter is optional and may be NULL or a pointer to NULL when not used. Except in the processing of certificates found in both *AllowedDb* and *RevokedDb*, *TimeStampDb* is not used and time-stamping is not otherwise required for signings verified by certificate only in *AllowedDb*.

**Note:** This method is intended to be suitable to implement Secure Boot image validation, and as such the contents of *AllowedDb*, *RevokedDb*, and *TimeStampDb* must also conform with the requirements of [Authorization Process](#), bullet item 3 (UEFI Image Validation Succeeded).

The verification function can handle both embedded data or detached signature formats. In case of embedded data, the function will optionally extract the original signed data and supply back to caller in caller-supplied buffer. For a detached signature the caller must provide the original message data in buffer pointed to by *InData*. For consistency, when both *InData* and *Content* are provided, the function will copy contents of *InData* to *Content*.

In case where the *ContentSize* indicated by caller is too small to contain the entire content extracted from the file, **EFI\_BUFFER\_TOO\_SMALL** error is returned, and *ContentSize* is updated to reflect the required size.

**Note:** When signing certificate is matched to *AllowedDb* or *RevokedDb* lists, a match can occur against an entry in the list at any level of the chain of X.509 certificates present in the PKCS certificate list. This supports signing with a certificate that chains to one of the certificates in the *AllowedDb* or *RevokedDb* lists.

## Related Definitions

None

## Status Codes Returned

EFI_SUCCESS	Content signature was verified against hash of content, the signer's certificate was not found in <i>RevokedDb</i> , and was found in <i>AllowedDb</i> or if in signer is found in both <i>AllowedDb</i> and <i>RevokedDb</i> , the signing was allowed by reference to <i>TimeStampDb</i> as described above, and no hash matching content hash was found in <i>RevokedDb</i> .
EFI_SECURITY_VIOLATION	The <i>SignedData</i> buffer was correctly formatted but signer was in <i>RevokedDb</i> or not in <i>AllowedDb</i> . Also returned if matching content hash found in <i>RevokedDb</i> .
EFI_COMPROMISED_DATA	Calculated hash differs from signed hash.
EFI_INVALID_PARAMETER	<i>SignedData</i> is NULL or <i>SignedDataSize</i> is zero. <i>AllowedDb</i> is NULL.
EFI_INVALID_PARAMETER	<i>Content</i> is not NULL and <i>ContentSize</i> is NULL.
EFI_ABORTED	Unsupported or invalid format in <i>TimeStampDb</i> , <i>RevokedDb</i> or <i>AllowedDb</i> list contents was detected.
EFI_NOT_FOUND	Content not found because <i>InData</i> is NULL and no content embedded in <i>SignedData</i> .
EFI_UNSUPPORTED	The <i>SignedData</i> buffer was not correctly formatted for processing by the function.
EFI_UNSUPPORTED	Signed data embedded in <i>SignedData</i> but <i>InData</i> is not NULL.
EFI_BUFFER_TOO_SMALL	The size of buffer indicated by <i>ContentSize</i> is too small to hold the content. <i>ContentSize</i> updated to required size.

## EFI\_PKCS7\_VERIFY\_PROTOCOL.VerifySignature()

### Summary

This function processes a buffer containing binary DER-encoded detached PKCS7 signature. The hash of the signed data content is calculated and passed by the caller. Function verifies the signature of the content is valid and signing certificate was not revoked and is contained within a list of trusted signers.

Note: the current UEFI specification allows for a variety of hashes. In order to be secure, the users of this protocol should loop over each hash to see if the binary signature is authorized.

### Prototype

```
typedef
EFI_STATUS
(EFIAPI *VerifySignature)(
    IN EFI_PKCS7_VERIFY_PROTOCOL * This,
    IN VOID          *Signature,
    IN UINTN         SignatureSize,
    IN VOID          *InHash,
    IN UINTN         InHashSize
    IN EFI_SIGNATURE_LIST **AllowedDb,
    IN EFI_SIGNATURE_LIST **RevokedDb OPTIONAL,
    IN EFI_SIGNATURE_LIST **TimeStampDb OPTIONAL,
);
```

### Parameters

<i>This</i>	Pointer to <b>EFI_PKCS7_VERIFY_PROTOCOL</b> instance.
<i>Signature</i>	Points to buffer containing ASN.1 DER-encoded PKCS detached signature.
<i>SignatureSize</i>	The size of <i>Signature</i> buffer in bytes.
<i>InHash</i>	<i>InHash</i> points to buffer containing the caller calculated hash of the data. This parameter may not be NULL.
<i>InHashSize</i>	The size in bytes of <i>InHash</i> buffer.
<i>AllowedDb</i>	Pointer to a list of pointers to <b>EFI_SIGNATURE_LIST</b> structures. The list is terminated by a null pointer. The <b>EFI_SIGNATURE_LIST</b> structures contain lists of X.509 certificates of approved signers. See Chapter 27 for definition of <b>EFI_SIGNATURE_LIST</b> . Function recognizes signer certificates of type <b>EFI_CERT_X509_GUID</b> . Any hash certificate in <i>AllowedDb</i> list is ignored by this function. Function returns success if signer of the buffer is within this list (and not within <i>RevokedDb</i> ). This parameter is required.

<i>RevokedDb</i>	Pointer to a list of pointers to <b>EFI_SIGNATURE_LIST</b> structures. The list is terminated by a null pointer. List of X.509 certificates of revoked signers and revoked file hashes. Signature verification will always fail if the signer of the file or the hash of the data component of the buffer is in <i>RevokedDb</i> list. This parameter is optional and caller may pass Null if not required.
<i>TimeStampDb</i>	Optional pointer to a list of pointers to <b>EFI_SIGNATURE_LIST</b> structures. The list is terminated by a null pointer. This parameter can be used to pass a list of X.509 certificates of trusted time stamp counter-signers.

## Description

This function processes the buffer *Signature* for PKCS7 verification using hash of the data calculated and pass by caller in the *InHash* buffer. The data that was signed using PKCS is referred to as the 'Message'. In the process of creating a signature of the message, a hash of the message bytes, called the 'Message Digest', is encrypted using a private key held in secret by the signer. The encrypted hash and the X.509 public key certificate of the signer are formatted according to the ASN.1 PKCS#7 Schema (See References). Any data embedded within the PKCS structure is ignored by the function. This function does not support extraction of signature from executable file formats. The address of the PKCS Signature block must be located and passed by the called.

The hash size passed in *InHashSize* must match the size of the signed hash embedded within the PKCS signature structure or an error is returned.

The *SignedData* buffer must be ASN.1 DER-encoded format with structure according to the subset defined in the introduction to this protocol. Both embedded content and detached signature formats are supported however embedded data is ignored. To pass verification the X.509 public certificate of the signer of the file must be found in *AllowedDb* and not be present in *RevokedDb*. Additionally, if *RevokedDb* contains a specific Hash signature that matches the hash calculated for the content, the file will also fail verification.

When *TimeStampDb* list is present this information modifies the processing of revoked certificates found in both *AllowedDb* and *RevokedDb*. When PKCS7 signings that are time-stamped by trusted signer in *TimeStampDb* list, and which time-stamping occurred prior to the time of certificate revocation noted in certificate in *RevokedDb* list, the signing will be allowed and return **EFI\_SUCCESS**. *TimeStampDb* parameter is optional and may be NULL or a pointer to NULL when not used. Except in the processing of certificates found in both *AllowedDb* and *RevokedDb*, *TimeStampDb* is not used and time-stamping is not otherwise required for signings verified by certificate only in *AllowedDb*.

The **VerifySignature()** function performs several steps. First, the buffer containing the user-provided signature is parsed, (any embedded content is ignored), and the PKCS7 signature of hash data is verified by decrypting the hash calculated at time of signing. Match of caller provided hash with decrypted hash provides indication the signed data has not been modified since signing. Next the protocol function attempts to match the signing certificate included within the signed data against the members of an (optional) list of caller-provided revoked certificates (*RevokedDb*). The hash of the data is also

compared against any hash items contained in *RevokedDb* list. Next the signing certificate is matched against the caller-provided list of trusted signatures. If the signature is valid, the certificate or hash are not in the revoked list, and the certificate is in the trusted list, the file passes verification.

**Note:**When a signing certificate is matched to *AllowedDb* or *RevokedDb* lists, a match can occur against an entry in the list at any level of the chain of X.509 certificates present in the PCKS certificate list. This supports signing with a certificate that chains to one of the certificates in the *AllowedDb* or *RevokedDb* lists.

**Note:**Because this function uses hashes and the specification contains a variety of hash choices, you should be aware that the check against the *RevokedDb* list will improperly succeed if the signature is revoked using a different hash algorithm. For this reason, you should either cycle through all UEFI supported hashes to see if one is forbidden, or rely on a single hash choice only if the UEFI signature authority only signs and revokes with a single hash (at time of writing, this hash choice is SHA256).

## Related Definitions

None

## Status Codes Returned

EFI_SUCCESS	Signed hash was verified against caller-provided hash of content, the signer's certificate was not found in <i>RevokedDb</i> , and was found in <i>AllowedDb</i> or if in signer is found in both <i>AllowedDb</i> and <i>RevokedDb</i> , the signing was allowed by reference to <i>TimeStampDb</i> as described above, and no hash matching content hash was found in <i>RevokedDb</i> .
EFI_SECURITY_VIOLATION	The <i>SignedData</i> buffer was correctly formatted but signer was in <i>RevokedDb</i> or not in <i>AllowedDb</i> . Also returned if matching content hash found in <i>RevokedDb</i> .
EFI_COMPROMISED_DATA	Caller provided hash differs from signed hash. Or, caller and encrypted hash are different sizes.
EFI_INVALID_PARAMETER	<i>Signature</i> is NULL or <i>SignatureSize</i> is zero. <i>InHash</i> is NULL or <i>InhashSize</i> is zero. <i>AllowedDb</i> is NULL.
EFI_ABORTED	Unsupported or invalid format in <i>TimeStampDb</i> , <i>RevokedDb</i> or <i>AllowedDb</i> list contents was detected.
EFI_UNSUPPORTED	The <i>Signature</i> buffer was not correctly formatted for processing by the function.

## 36.5 Random Number Generator Protocol

This section defines the Random Number Generator (RNG) protocol. This protocol is used to provide random numbers for use in applications, or entropy for seeding other random number generators. Consumers of the protocol can ensure that drivers implementing the protocol produce RNG values in a well-known manner.



When a Deterministic Random Bit Generator (DRBG) is used on the output of a (raw) entropy source, its security level must be at least 256 bits.

## EFI\_RNG\_PROTOCOL

### Summary

This protocol provides standard RNG functions. It can be used to provide random bits for use in applications, or entropy for seeding other random number generators.

### GUID

```
#define EFI_RNG_PROTOCOL_GUID \
{ 0x3152bca5, 0xeade, 0x433d, \
  {0x86, 0x2e, 0xc0, 0x1c, 0xdc, 0x29, 0x1f, 0x44}}
```

### Protocol Interface Structure

```
typedef struct _EFI_RNG_PROTOCOL {
  EFI_RNG_GET_INFO  GetInfo
  EFI_RNG_GET_RNG   GetRNG;
} EFI_RNG_PROTOCOL;
```

### Parameters

<i>GetInfo</i>	Returns information about the random number generation implementation.
<i>GetRNG</i>	Returns the next set of random numbers.

### Description

This protocol allows retrieval of RNG values from an UEFI driver. The *GetInfo* service returns information about the RNG algorithms the driver supports. The *GetRNG* service creates a RNG value using an (optionally specified) RNG algorithm.



## EFI\_RNG\_PROTOCOL.GetInfo

### Summary

Returns information about the random number generation implementation.

### Prototype

```
typedef
EFI_STATUS
(EFIAPI *EFI_RNG_GET_INFO) (
  IN EFI_RNG_PROTOCOL *This,
  IN OUT UINTN      *RNGAlgorithmListSize,
  OUT EFI_RNG_ALGORITHM *RNGAlgorithmList
);
```

### Parameters

<i>This</i>	A pointer to the <b>EFI_RNG_PROTOCOL</b> instance.
<i>RNGAlgorithmListSize</i>	On input, the size in bytes of <i>RNGAlgorithmList</i> . On output with a return code of <b>EFI_SUCCESS</b> , the size in bytes of the data returned in <i>RNGAlgorithmList</i> . On output with a return code of <b>EFI_BUFFER_TOO_SMALL</b> , the size of <i>RNGAlgorithmList</i> required to obtain the list.
<i>RNGAlgorithmList</i>	A caller-allocated memory buffer filled by the driver with one <b>EFI_RNG_ALGORITHM</b> element for each supported RNG algorithm. The list must not change across multiple calls to the same driver. The first algorithm in the list is the default algorithm for the driver.

### Description

This function returns information about supported RNG algorithms.

A driver implementing the RNG protocol need not support more than one RNG algorithm, but shall support a minimum of one RNG algorithm.

### Related Definitions

```
typedef EFI_GUID EFI_RNG_ALGORITHM;
```

### Status Codes Returned

EFI_SUCCESS	The RNG algorithm list was returned successfully.
EFI_UNSUPPORTED	The service is not supported by this driver.
EFI_DEVICE_ERROR	The list of algorithms could not be retrieved due to a hardware or firmware error.

EFI_BUFFER_TOO_SMALL	The buffer <i>RNGAlgorithmList</i> is too small to hold the result.
----------------------	---

## EFI\_RNG\_PROTOCOL.GetRNG

### Summary

Produces and returns an RNG value using either the default or specified RNG algorithm.

### Prototype

```
typedef
EFI_STATUS
(EFIAPI *EFI_RNG_GET_RNG) (
  IN EFI_RNG_PROTOCOL *This,
  IN EFI_RNG_ALGORITHM *RNGAlgorithm, OPTIONAL
  IN UINTN    RNGValueLength,
  OUT UINT8   *RNGValue
);
```

### Parameters

<i>This</i>	A pointer to the <i>EFI_RNG_PROTOCOL</i> instance.
<i>RNGAlgorithm</i>	A pointer to the <i>EFI_RNG_ALGORITHM</i> that identifies the RNG algorithm to use. May be NULL in which case the function will use its default RNG algorithm.
<i>RNGValueLength</i>	The length in bytes of the memory buffer pointed to by <i>RNGValue</i> . The driver shall return exactly this number of bytes.
<i>RNGValue</i>	A caller-allocated memory buffer filled by the driver with the resulting RNG value.

### Description

This function fills the *RNGValue* buffer with random bytes from the specified RNG algorithm. The driver must not reuse random bytes across calls to this function. It is the caller's responsibility to allocate the *RNGValue* buffer.

## Status Codes Returned

EFI_SUCCESS	The RNG value was returned successfully.
EFI_UNSUPPORTED	The algorithm specified by <i>RNGAlgorithm</i> is not supported by this driver.
EFI_DEVICE_ERROR	An RNG value could not be retrieved due to a hardware or firmware error.
EFI_NOT_READY	There is not enough random data available to satisfy the length requested by <i>RNGValueLength</i> .
EFI_INVALID_PARAMETER	RNGValue is null or RNGValueLength is zero.

### 36.5.1 EFI RNG Algorithm Definitions

#### Summary

This sub-section provides **EFI\_GUID** values for a selection of **EFI\_RNG\_PROTOCOL** algorithms. The algorithms listed are optional, not meant to be exhaustive and may be augmented by vendors or other industry standards.

The “raw” algorithm, when supported, is intended to provide entropy directly from the source, without it going through some deterministic random bit generator.

## Prototype

```
#define EFI_RNG_ALGORITHM_SP800_90_HASH_256_GUID \
  {0xa7af67cb, 0x603b, 0x4d42, \
   0xba, 0x21, 0x70, 0xbf, 0xb6, 0x29, 0x3f, 0x96}}

#define EFI_RNG_ALGORITHM_SP800_90_HMAC_256_GUID \
  {0xc5149b43, 0xae85, 0x4f53, \
   0x99, 0x82, 0xb9, 0x43, 0x35, 0xd3, 0xa9, 0xe7}}

#define EFI_RNG_ALGORITHM_SP800_90_CTR_256_GUID \
  {0x44f0de6e, 0x4d8c, 0x4045, \
   0xa8, 0xc7, 0x4d, 0xd1, 0x68, 0x85, 0x6b, 0x9e}}

#define EFI_RNG_ALGORITHM_X9_31_3DES_GUID \
  {0x63c4785a, 0xca34, 0x4012, \
   0xa3, 0xc8, 0x0b, 0x6a, 0x32, 0x4f, 0x55, 0x46}}

#define EFI_RNG_ALGORITHM_X9_31_AES_GUID \
  {0xacd03321, 0x777e, 0x4d3d, \
   0xb1, 0xc8, 0x20, 0xcf, 0xd8, 0x88, 0x20, 0xc9}}

#define EFI_RNG_ALGORITHM_RAW \
  {0xe43176d7, 0xb6e8, 0x4827, \
   0xb7, 0x84, 0x7f, 0xfd, 0xc4, 0xb6, 0x85, 0x61}}
```

### 36.5.2 RNG References

NIST SP 800-90, "Recommendation for Random Number Generation Using Deterministic Random Bit Generators," March 2007. See "Links to UEFI-Related Documents" (<http://uefi.org/uefi>) under the heading "Recommendation for Random Number Generation Using Deterministic Random Bit Generators".

NIST, "Recommended Random Number Generator Based on ANSI X9.31 Appendix A.2.4 Using the 3-Key Triple DES and AES Algorithms," January 2005. See "Links to UEFI-Related Documents" (<http://uefi.org/uefi>) under the heading "Recommended Random Number Generator Based on ANSI X9.31".

## 36.6

### Smart Card Reader and Smart Card Edge Protocols

The UEFI Smart Card Reader Protocol provides an abstraction for device to provide smart card reader support. This protocol is very close to Part 5 of PC/SC workgroup specifications and provides an API to applications willing to communicate with a smart card or a smart card reader.

## 36.6.1 Smart Card Reader Protocol

### EFI\_SMART\_CARD\_READER\_PROTOCOL Summary

Smart card aware application invokes this protocol to get access to an inserted smart card in the reader or to the reader itself.

#### GUID

```
#define EFI_SMART_CARD_READER_PROTOCOL_GUID \
  {0x2a4d1adf, 0x21dc, 0x4b81, \
   {0xa4, 0x2f, 0x8b, 0x8e, 0xe2, 0x38, 0x00, 0x60}}
```

#### Protocol Interface Structure

```
typedef struct _EFI_SMART_CARD_READER_PROTOCOL {
  EFI_SMART_CARD_READER_CONNECT  SCardConnect;
  EFI_SMART_CARD_READER_DISCONNECT  SCardDisconnect;
  EFI_SMART_CARD_READER_STATUS  SCardStatus;
  EFI_SMART_CARD_READER_TRANSMIT  SCardTransmit;
  EFI_SMART_CARD_READER_CONTROL  SCardControl;
  EFI_SMART_CARD_READER_GET_ATTRIB  SCardGetAttrib;
} EFI_SMART_CARD_READER_PROTOCOL;
```

#### Members

<i>SCardConnect</i>	Requests a connection to the smart card or smart card reader.
<i>SCardDisconnect</i>	Closes the previously open connection.
<i>SCardStatus</i>	Provides informations on smart card status and reader name.
<i>SCardTransmit</i>	Exchanges data with smart card or smart card reader.
<i>SCardControl</i>	Gives direct control to the smart card reader.
<i>SCardGetAttrib</i>	Retrieves reader characteristics.

#### Description

This protocol allows UEFI applications to communicate and get/set all necessary information to the smart card reader.

#### Overview

This document aims at defining a standard way for UEFI applications to use a smart card. The key points are:

- Provide an API as close as possible to Part 5 of the existing PC/SC interface. See “Links to UEFI-Related Documents” (<http://uefi.org/uefi>) under the heading “PC/SC Workgroup Specifications”.
- Remove any unnecessary complexity of PC/SC implementation in a classic OS:
  - Assume no connection sharing

- No resource manager
- Reduced set of APIs

Note that this document only focuses on PC/SC Part 5 (access to smart card/smart card reader from an application). Abstracting the smart card (Parts 6/9) is not the scope of this document.

Main differences with existing PC/SC implementation on Linux/MacOS/Windows:

- There is no resource manager, driver exposes Part 5 instead of Part 3
- It is not possible to share a smart card between UEFI applications/drivers
- Reader enumeration is different:
  - On classic PC/SC, SCardListReaders is used
  - In UEFI, reader list is available via OpenProtocol/ScardStatus calls

## EFI\_SMART\_CARD\_READER\_PROTOCOL.SCardConnect()

### Summary

This function requests connection to the smart card or the reader, using the appropriate reset type and protocol.

### Prototype

```
EFI_STATUS
(EFIAPI *EFI_SMART_CARD_READER_PROTOCOL_CONNECT) (
  IN EFI_SMART_CARD_READER_PROTOCOL *This,
  IN UINT32      AccessMode,
  IN UINT32      CardAction,
  IN UINT32      PreferredProtocols,
  OUT UINT32     *ActiveProtocol
);
```

### Parameters

<i>This</i>	Indicates a pointer to the calling context. Type <b>EFI_SMART_CARD_READER_PROTOCOL</b> is defined in the <b>EFI_SMART_CARD_READER_PROTOCOL</b> description.
<i>AccessMode</i>	See “related definitions” below.
<i>CardAction</i>	<b>SCARD_CA_NORESET</b> , <b>SCARD_CA_COLDRESET</b> or <b>SCARD_CA_WARMRESET</b> .
<i>PreferredProtocols</i>	Bitmask of acceptable protocols. See “related definitions” below.
<i>ActiveProtocol</i>	A flag that indicates the active protocol. See “related definitions” below.



## Related Definitions

```
//
// Codes for access mode
//
#define SCARD_AM_READER 0x0001 // Exclusive access to reader
#define SCARD_AM_CARD 0x0002 // Exclusive access to card
//
// Codes for card action
//
#define SCARD_CA_NORESET 0x0000 // Don't reset card
#define SCARD_CA_COLDRESET 0x0001 // Perform a cold reset
#define SCARD_CA_WARMRESET 0x0002 // Perform a warm reset
#define SCARD_CA_UNPOWER 0x0003 // Power off the card
#define SCARD_CA_EJECT 0x0004 // Eject the card
//
// Protocol types
//
#define SCARD_PROTOCOL_UNDEFINED 0x0000
#define SCARD_PROTOCOL_T0 0x0001
#define SCARD_PROTOCOL_T1 0x0002
#define SCARD_PROTOCOL_RAW 0x0004
```

## Description

The *SCardConnect* function requests access to the smart card or the reader. Upon success, it is then possible to call **SCardTransmit**.

If *AccessMode* is set to **SCARD\_AM\_READER**, *PreferredProtocols* must be set to **SCARD\_PROTOCOL\_UNDEFINED** and *CardAction* to **SCARD\_CA\_NORESET** else function fails with **EFI\_INVALID\_PARAMETER**.

## Status Codes Returned

EFI_SUCCESS	The requested command completed successfully.
EFI_INVALID_PARAMETER	<i>This</i> is NULL.
EFI_INVALID_PARAMETER	<i>AccessMode</i> is not valid.
EFI_INVALID_PARAMETER	<i>CardAction</i> is not valid.
EFI_INVALID_PARAMETER	Invalid combination of <i>AccessMode</i> / <i>CardAction</i> / <i>PreferredProtocols</i> .
EFI_NOT_READY	A smart card is inserted but failed to return an ATR.
EFI_UNSUPPORTED	<i>PreferredProtocols</i> does not contain an available protocol to use.
EFI_NO_MEDIA	<i>AccessMode</i> is set to <b>SCARD_AM_CARD</b> but there is no smart card inserted.
EFI_ACCESS_DENIED	Access is already locked by a previous <b>SCardConnect</b> call.
EFI_DEVICE_ERROR	Any other error condition, typically a reader removal.

## EFI\_SMART\_CARD\_READER\_PROTOCOL.SCardDisconnect()

### Summary

This function releases a connection previously taken by SCardConnect.

### Prototype

```
typedef
EFI_STATUS
(EFIAPI *EFI_SMART_CARD_READER_PROTOCOL_DISCONNECT) (
  IN EFI_SMART_CARD_READER_PROTOCOL *This,
  IN UINT32      CardAction
);
```

### Parameters

*This*

Indicates a pointer to the calling context. Type **EFI\_SMART\_CARD\_READER\_PROTOCOL** is defined in the **EFI\_SMART\_CARD\_READER\_PROTOCOL** description.

*CardAction*

See "related definitions" for *CardAction* in **SCardConnect** description.

### Description

The **SCardDisconnect** function releases the lock previously taken by **SCardConnect**. In case the smart card has been removed before this call, this function returns **EFI\_SUCCESS**. If there is no previous call to **SCardConnect**, this function returns **EFI\_SUCCESS**.

### Status Codes Returned

EFI_SUCCESS	The requested command completed successfully.
EFI_INVALID_PARAMETER	<i>This</i> is NULL.
EFI_INVALID_PARAMETER	<i>CardAction</i> value is unknown.
EFI_UNSUPPORTED	Reader does not support Eject card feature (disconnect was not performed).
EFI_DEVICE_ERROR	Any other error condition, typically a reader removal.

## EFI\_SMART\_CARD\_READER\_PROTOCOL.SCardStatus()

### Summary

This function retrieves some basic information about the smart card and reader.

### Prototype

```
typedef
EFI_STATUS
(EFIAPI *EFI_SMART_CARD_READER_PROTOCOL_STATUS) (
  IN EFI_SMART_CARD_READER_PROTOCOL *This,
  OUT CHAR16      *ReaderName OPTIONAL,
  IN OUT UINTN   *ReaderNameLength OPTIONAL,
  OUT UINT32     *State OPTIONAL,
  OUT UINT32     *CardProtocol OPTIONAL,
  OUT UINT8      *Atr OPTIONAL,
  IN OUT UINTN   *AtrLength OPTIONAL
);
```

### Parameters

<i>This</i>	Indicates a pointer to the calling context. Type <b>EFI_SMART_CARD_READER_PROTOCOL</b> is defined in the <b>EFI_SMART_CARD_READER_PROTOCOL</b> description.
<i>ReaderName</i>	A pointer to a NULL terminated string that will contain the reader name.
<i>ReaderNameLength</i>	On input, a pointer to the variable that holds the maximal size, in bytes, of <i>ReaderName</i> . On output, the required size, in bytes, for <i>ReaderName</i> .
<i>State</i>	Current state of the smart card reader. See “related definitions” below.
<i>CardProtocol</i>	Current protocol used to communicate with the smart card. See “related definitions” in <b>SCardConnect</b> .
<i>Atr</i>	A pointer to retrieve the ATR of the smart card.
<i>AtrLength</i>	On input, a pointer to hold the maximum size, in bytes, of <i>Atr</i> (usually 33). On output, the required size, in bytes, for the smart card ATR.

## Related Definitions

```
//
// Codes for state type
//
#define SCARD_UNKNOWN 0x0000 /* state is unknown */
#define SCARD_ABSENT 0x0001 /* Card is absent */
#define SCARD_INACTIVE 0x0002 /* Card is present and not powered*/
#define SCARD_ACTIVE 0x0003 /* Card is present and powered */
```

## Description

The **SCardStatus** function retrieves basic reader and card information.

If *ReaderName*, *State*, *CardProtocol* or *Atr* is NULL, the function does not fail but does not fill in such variables.

If **EFI\_SUCCESS** is not returned, *ReaderName* and *Atr* contents shall not be considered as valid.

## Status Codes Returned

EFI_SUCCESS	The requested command completed successfully.
EFI_INVALID_PARAMETER	<i>This</i> is NULL
EFI_INVALID_PARAMETER	<i>ReaderName</i> is not NULL but <i>ReaderNameLength</i> is NULL
EFI_INVALID_PARAMETER	<i>Atr</i> is not NULL but <i>AtrLength</i> is NULL
EFI_BUFFER_TOO_SMALL	<i>ReaderNameLength</i> is not big enough to hold the reader name. <i>ReaderNameLength</i> has been updated to the required value.
EFI_BUFFER_TOO_SMALL	<i>AtrLength</i> is not big enough to hold the ATR. <i>AtrLength</i> has been updated to the required value.
EFI_DEVICE_ERROR	Any other error condition, typically a reader removal.

## EFI\_SMART\_CARD\_READER\_PROTOCOL.SCardTransmit()

### Summary

This function sends a command to the card or reader and returns its response.

### Prototype

```
typedef
EFI_STATUS
(EFIAPI *EFI_SMART_CARD_READER_PROTOCOL_TRANSMIT) (
  IN EFI_SMART_CARD_READER_PROTOCOL *This,
  IN UINT8          *CAPDU,
  IN UINTN          CAPDULength,
  OUT UINT8         *RAPDU,
  IN OUT UINTN     *RAPDULength
);
```

### Parameters

<i>This</i>	Indicates a pointer to the calling context. Type <b>EFI_SMART_CARD_READER_PROTOCOL</b> is defined in the <b>EFI_SMART_CARD_READER_PROTOCOL</b> description.
<i>CAPDU</i>	A pointer to a byte array that contains the Command APDU to send to the smart card or reader.
<i>CAPDULength</i>	Command APDU size, in bytes.
<i>RAPDU</i>	A pointer to a byte array that will contain the Response APDU.
<i>RAPDULength</i>	On input, the maximum size, in bytes, of the Response APDU. On output, the size, in bytes, of the Response APDU.

### Description

This function sends a command to the card or reader and returns its response. The protocol to use to communicate with the smart card has been selected through **SCardConnect** call.

In case *RAPDULength* indicates a buffer too small to hold the response APDU, the function fails with **EFI\_BUFFER\_TOO\_SMALL**.

**Note:** *the caller has to call previously **SCardConnect** to make sure the reader/card is not already accessed by another application or driver.*

### Status Codes Returned

EFI_SUCCESS	The requested command completed successfully.
EFI_INVALID_PARAMETER	<i>This</i> is NULL
EFI_INVALID_PARAMETER	<i>CAPDU</i> is NULL or <i>CAPDULength</i> is 0.

EFI_BUFFER_TOO_SMALL	<i>RAPDULength</i> is not big enough to hold the response APDU. <i>RAPDULength</i> has been updated to the required value..
EFI_NO_MEDIA	There is no card in the reader.
EFI_NOT_READY	Card is not powered.
EFI_PROTOCOL_ERROR	A protocol error has occurred.
EFI_TIMEOUT	The reader did not respond.
EFI_ACCESS_DENIED	A communication with the reader/card is already pending.
EFI_DEVICE_ERROR	Any other error condition, typically a reader removal.

## EFI\_SMART\_CARD\_READER\_PROTOCOL.SCardControl()

### Summary

This function provides direct access to the reader.

### Prototype

```
typedef
EFI_STATUS
(EFIAPI *EFI_SMART_CARD_READER_PROTOCOL_CONTROL) (
  IN EFI_SMART_CARD_READER_PROTOCOL *This,
  IN UINT32      ControlCode,
  IN UINT8      *InBuffer OPTIONAL,
  IN UINTN      InBufferLength OPTIONAL,
  OUT UINT8     *OutBuffer OPTIONAL,
  IN OUT UINTN  *OutBufferLength OPTIONAL
);
```

### Parameters

<i>This</i>	Indicates a pointer to the calling context. Type <b>EFI_SMART_CARD_READER_PROTOCOL</b> is defined in the <b>EFI_SMART_CARD_READER_PROTOCOL</b> description.
<i>ControlCode</i>	The control code for the operation to perform. See "related definitions" below.
<i>InBuffer</i>	A pointer to the input parameters.
<i>InBufferLength</i>	Size, in bytes, of input parameters.
<i>OutBuffer</i>	A pointer to the output parameters.
<i>OutBufferLength</i>	On input, maximal size, in bytes, to store output parameters. On output, the size, in bytes, of output parameters.

### Description

This function gives direct control to send commands to the driver or the reader.

The *ControlCode* to use is vendor dependant; the only standard code defined is the one to get PC/SC part 10 features. See "related definitions" below.

*InBuffer* and *Outbuffer* may be NULL when *ControlCode* operation does not require them.

**Note:** *the caller has to call previously **SCardConnect** to make sure the reader/card is not already accessed by another application or driver.*

## Related Definitions

```
//
// Macro to generate a ControlCode & PC/SC part 10 control code
//
#define SCARD_CTL_CODE(code) (0x42000000 + (code))
#define CM_IOCTL_GET_FEATURE_REQUEST SCARD_CTL_CODE(3400)
```

## Status Codes Returned

EFI_SUCCESS	The requested command completed successfully.
EFI_INVALID_PARAMETER	<i>This</i> is NULL
EFI_INVALID_PARAMETER	<i>ControlCode</i> requires input parameters but: <ul style="list-style-type: none"> <li>• <i>InBuffer</i> is NULL or <i>InBufferLength</i> is NULL –or-</li> <li>• <i>InBuffer</i> is not NULL but <i>InBufferLength</i> is less than</li> </ul>
EFI_INVALID_PARAMETER	<i>OutBuffer</i> is not NULL but <i>OutBufferLength</i> is NULL
EFI_UNSUPPORTED	<i>ControlCode</i> is not supported.
EFI_BUFFER_TOO_SMALL	<i>OutBufferLength</i> is not big enough to hold the output parameters. <i>OutBufferLength</i> has been updated to the required value.
EFI_NO_MEDIA	There is no card in the reader and the control code specified requires one.
EFI_NOT_READY	<i>ControlCode</i> requires a powered card to operate.
EFI_PROTOCOL_ERROR	A protocol error has occurred.
EFI_TIMEOUT	The reader did not respond.
EFI_ACCESS_DENIED	A communication with the reader/card is already pending.
EFI_DEVICE_ERROR	Any other error condition, typically a reader removal.



## EFI\_SMART\_CARD\_READER\_PROTOCOL.SCardGetAttrib()

### Summary

*This function retrieves a reader or smart card attribute.*

### Prototype

```
typedef
EFI_STATUS
(EFIAPI *EFI_SMART_CARD_READER_PROTOCOL_GET_ATTRIB) (
IN EFI_SMART_CARD_READER_PROTOCOL *This,
IN UINT32      Attrib,
OUT UINT8      *OutBuffer,
IN OUT UINTE8  *OutBufferLength
);
```

### Parameters

<i>This</i>	Indicates a pointer to the calling context. Type <b>EFI_SMART_CARD_READER_PROTOCOL</b> is defined in the <b>EFI_SMART_CARD_READER_PROTOCOL</b> description.
<i>Attrib</i>	Identifier for the attribute to retrieve. See “related definitions” below. Note that all attributes might not be implemented.
<i>OutBuffer</i>	A pointer to a buffer that will contain attribute data.
<i>OutBufferLength</i>	On input, maximal size, in bytes, to store attribute data. On output, the size, in bytes, of attribute data.

### Related Definitions

Possibly supported attrib values are listed in the *PC/SC Specification*, Part 3. See [Section Q](#) for document access.

### Description

The **SCardGetAttrib** function retrieves an attribute from the reader driver.

## Status Codes Returned

EFI_SUCCESS	The requested command completed successfully.
EFI_INVALID_PARAMETER	<i>This</i> is NULL.
EFI_INVALID_PARAMETER	<i>OutBuffer</i> is NULL or <i>OutBufferLength</i> is 0.
EFI_BUFFER_TOO_SMALL	<i>OutBufferLength</i> is not big enough to hold the output parameters. <i>OutBufferLength</i> has been updated to the required value.
EFI_UNSUPPORTED	<i>Attrib</i> is not supported.
EFI_NO_MEDIA	There is no card in the reader and <i>Attrib</i> value requires one.
EFI_NOT_READY	<i>Attrib</i> requires a powered card to operate.
EFI_PROTOCOL_ERROR	A protocol error has occurred.
EFI_TIMEOUT	The reader did not respond.
EFI_DEVICE_ERROR	Any other error condition, typically a reader removal.

### 36.6.2 Smart Card Edge Protocol

The Smart Card Edge Protocol provides an abstraction for device to provide Smart Card support.

#### EFI\_SMART\_CARD\_EDGE\_PROTOCOL

##### Summary

Smart Card aware application invokes this protocol to get access to an inserted Smart Card in the reader.

## GUID

```
#define EFI_SMART_CARD_EDGE_PROTOCOL_GUID \
{ 0xd317f29b, 0xa325, 0x4712, \
  { 0x9b, 0xf1, 0xc6, 0x19, 0x54, 0xdc, 0x19, 0x8c } }
```

## Protocol Interface Structure

```
typedef struct _EFI_SMART_CARD_EDGE_PROTOCOL {
  EFI_SMART_CARD_EDGE_GET_CONTEXT  GetContext;
  EFI_SMART_CARD_EDGE_CONNECT      Connect;
  EFI_SMART_CARD_EDGE_DISCONNECT   Disconnect;
  EFI_SMART_CARD_EDGE_GET_CSN      GetCsr;
  EFI_SMART_CARD_EDGE_GET_READER_NAME  GetReaderName;
  EFI_SMART_CARD_EDGE_VERIFY_PIN    VerifyPin;
  EFI_SMART_CARD_EDGE_GET_PIN_REMAINING  GetPinRemaining;
  EFI_SMART_CARD_EDGE_GET_DATA      GetData;
  EFI_SMART_CARD_EDGE_GET_CREDENTIAL  GetCredential;
  EFI_SMART_CARD_EDGE_SIGN_DATA      SignData;
  EFI_SMART_CARD_EDGE_DECRYPT_DATA    DecryptData;
  EFI_SMART_CARD_EDGE_BUILD_DH_AGREEMENT  BuildDHAgreement;
} EFI_SMART_CARD_EDGE_PROTOCOL;
```

## Members

<i>GetContext</i>	Request the driver context.
<i>Connect</i>	Request a connection to the Smart Card.
<i>Disconnect</i>	Close a previously open connection.
<i>GetCSN</i>	Get Card Serial Number.
<i>GetReaderName</i>	Get name of Smart Card reader used.
<i>VerifyPin</i>	Verify Smart Card PIN.
<i>GetPinRemaining</i>	Get number of remaining PIN tries.
<i>GetData</i>	Get specific data.
<i>GetCredential</i>	Get credentials the Smart Card holds.
<i>SignData</i>	Sign a data.
<i>DecryptData</i>	Decrypt a data.
<i>BuildDHAgreement</i>	Construct a DH (Diffie Hellman) agreement for key derivation.

## Description

This protocol allows UEFI applications to interface with a Smart Card during boot process for authentication or data signing / decryption, especially if the application has to make use of PKI.

## Overview

This document aims at defining a standard way for UEFI applications to use a Smart Card in PKI (Public Key Infrastructure) context. The key points are:

- Each Smart Card or set of Smart Card have specific behavior.
- Smart Card applications often interface with PKCS #11 API or other cryptographic interface like CNG.
- During boot process not all the possibility of a cryptographic interface, like PKCS #11, are useful, for example it is neither the moment to perform Smart Card administration or Smart Card provisioning nor to process debit or credit operation with Smart Card.

Consequently this protocol focused on those points:

- Offering standard access to Smart Card functionalities that:
  - Authenticate User
  - Sign data
  - Decrypt data
  - Get certificates
- With an API that is enough close with PKCS#11 API that it could be considered as a brick to build a "tiny PKCS#11".
- An implementation of the protocol can be dedicated to a specific Smart Card or a specific set of Smart Card.
- An implementation of the protocol shall poll for Smart Card reader attachment and removal.
- An implementation of the protocol shall poll for Smart Card insertion and removal. On insertion the protocol shall check if it supports this Smart Card.

Typically an implementation of this protocol will lean on a Smart Card reader protocol (**EFI\_SMART\_CARD\_READER\_PROTOCOL**).

## EFI\_SMART\_CARD\_EDGE\_PROTOCOL.GetContext()

### Summary

This function retrieves the context driver.

### Prototype

```
typedef
EFI_STATUS
(EFI_API *EFI_SMART_CARD_EDGE_GET_CONTEXT) (
  IN EFI_SMART_CARD_EDGE_PROTOCOL *This,
  OUT UINTN      *NumberAidSupported,
  IN OUT UINTN   *AidTableSize OPTIONAL,
  OUT SMART_CARD_AID *AidTable OPTIONAL,
  OUT UINTN      *NumberSCPresent,
  IN OUT UINTN   *CsnTableSize OPTIONAL,
  OUT SMART_CARD_CSN *CsnTable OPTIONAL,
  OUT UINT32     *VersionScEdgeProtocol OPTIONAL
);
```

### Parameters

<i>This</i>	Indicates a pointer to the calling context. Type <b>EFI_SMART_CARD_EDGE_PROTOCOL</b> is defined in the <b>EFI_SMART_CARD_EDGE_PROTOCOL</b> description.
<i>NumberAidSupported</i>	Number of AIDs this protocol supports.
<i>AidTableSize</i>	On input, number of items allocated for the AID table. On output, number of items returned by protocol.
<i>AidTable</i>	Table of the AIDs supported by the protocol.
<i>NumberSCPresent</i>	Number of currently present Smart Cards that are supported by protocol.
<i>CsnTableSize</i>	On input, the number of items the buffer CSN table can contain. On output, the number of items returned by the protocol.
<i>CsnTable</i>	Table of the CSN of the Smart Card present and supported by protocol.
<i>VersionScEdgeProtocol</i>	<b>EFI_SMART_CARD_EDGE_PROTOCOL</b> version.

## Related Definitions

```
//
// Maximum size for a Smart Card AID (Application Identifier)
//
#define SCARD_AID_MAXSIZE 0x0010
//
// Size of CSN (Card Serial Number)
//
#define SCARD_CSN_SIZE 0x0010
//
//Current specification version 1.00
//
#define SMART_CARD_EDGE_PROTOCOL_VERSION_1 0x00000100

// Parameters type definition
//
typedef UINT8 SMART_CARD_AID[SCARD_AID_MAXSIZE];
typedef UINT8 SMART_CARD_CSN[SCARD_CSN_SIZE];
```

## Description

The **GetContext** function returns the context of the protocol, the application identifiers supported by the protocol and the number and the CSN unique identifier of Smart Cards that are present and supported by protocol.

If *AidTableSize*, *AidTable*, *CsnTableSize*, *CsnTable* or *VersionProtocol* is NULL, the function does not fail but does not fill in such variables.

In case *AidTableSize* indicates a buffer too small to hold all the protocol AID table, only the first *AidTableSize* items of the table are returned in *AidTable*.

In case *CsnTableSize* indicates a buffer too small to hold the entire table of Smart Card CSN present, only the first *CsnTableSize* items of the table are returned in *CsnTable*.

*VersionScEdgeProtocol* returns the version of the **EFI\_SMART\_CARD\_EDGE\_PROTOCOL** this driver uses. For this protocol specification value is **SMART\_CARD\_EDGE\_PROTOCOL\_VERSION\_1**.

In case of Smart Card removal the internal CSN list is immediately updated, even if a connection is opened with that Smart Card.

## Status Codes Returned

EFI_SUCCESS	The requested command completed successfully.
EFI_INVALID_PARAMETER	<i>This</i> is NULL.
EFI_INVALID_PARAMETER	<i>NumberSCPresent</i> is NULL.

## EFI\_SMART\_CARD\_EDGE\_PROTOCOL. Connect()

### Summary

This function establish a connection with a Smart Card the protocol support.

### Prototype

```
typedef
EFI_STATUS
(EFI_API *EFI_SMART_CARD_EDGE_CONNECT) (
  IN EFI_SMART_CARD_EDGE_PROTOCOL *This,
  OUT EFI_HANDLE *SCardHandle,
  IN UINT8 *SCardCsn OPTIONAL,
  OUT UINT8 *SCardAid OPTIONAL
);
```

### Parameters

<i>This</i>	Indicates a pointer to the calling context. Type <b>EFI_SMART_CARD_EDGE_PROTOCOL</b> is defined in the <b>EFI_SMART_CARD_EDGE_PROTOCOL</b> description.
<i>SCardHandle</i>	Handle on Smart Card connection.
<i>SCardCsn</i>	CSN of the Smart Card the connection has to be established.
<i>SCardAid</i>	AID of the Smart Card the connection has been established.

### Description

The **Connect** function establishes a connection with a Smart Card.

In case of success the *SCardHandle* can be used.

If the *SCardCsn* is NULL the connection is established with the first Smart Card the protocol finds in its table of Smart Card present and supported. Else it establish context with the Smart Card whose CSN given by *SCardCsn*.

If *SCardAid* is not NULL the function returns the Smart Card AID the protocol supports.

After a successful connect the *SCardHandle* will remain existing even in case Smart Card removed from Smart Card reader, but all function invoking this *SCardHandle* will fail.

*SCardHandle* is released only on Disconnect.

### Status Codes Returned

EFI_SUCCESS	The requested command completed successfully.
EFI_INVALID_PARAMETER	<i>This</i> is NULL.
EFI_INVALID_PARAMETER	<i>SCardHandle</i> is NULL.

EFI_NO_MEDIA	No Smart Card supported by protocol is present, Smart Card with CSN <i>ScardCsn</i> or Reader has been removed. A Disconnect should be performed.
--------------	---



## EFI\_SMART\_CARD\_EDGE\_PROTOCOL.Disconnect()

### Summary

This function releases a connection previously established by **Connect**.

### Prototype

```
typedef
EFI_STATUS
(EFI_API *EFI_SMART_CARD_EDGE_DISCONNECT) (
  IN EFI_SMART_CARD_EDGE_PROTOCOL *This,
  IN EFI_HANDLE      SCardHandle
);
```

### Parameters

<i>This</i>	Indicates a pointer to the calling context. Type <b>EFI_SMART_CARD_EDGE_PROTOCOL</b> is defined in the <b>EFI_SMART_CARD_EDGE_PROTOCOL</b> description.
<i>SCardHandle</i>	Handle on Smart Card connection to release.

### Description

The *Disconnect* function releases the connection previously established by a *Connect*. In case the Smart Card or the Smart Card reader has been removed before this call, this function returns **EFI\_SUCCESS**.

### Status Codes Returned

EFI_SUCCESS	The requested command completed successfully.
EFI_INVALID_PARAMETER	<i>This</i> is NULL.
EFI_INVALID_PARAMETER	No connection for <i>SCardHandle</i> value.

## EFI\_SMART\_CARD\_EDGE\_PROTOCOL.GetCsn

### Summary

This function returns the Smart Card serial number.

### Prototype

```
typedef
EFI_STATUS
(EFI_API *EFI_SMART_CARD_EDGE_GET_CSN) (
  IN EFI_SMART_CARD_EDGE_PROTOCOL *This,
  IN EFI_HANDLE      SCardHandle,
  OUT UINT8          Csn[SCARD_CSN_SIZE]
);
```

### Parameters

<i>This</i>	Indicates a pointer to the calling context. Type <b>EFI_SMART_CARD_EDGE_PROTOCOL</b> is defined in the <b>EFI_SMART_CARD_EDGE_PROTOCOL</b> description.
<i>SCardHandle</i>	Handle on Smart Card connection.
<i>Csn</i>	The Card Serial number, 16 bytes array.

### Description

The **GetCsn** function returns the 16 bytes Smart Card Serial number.

### Status Codes Returned

EFI_SUCCESS	The requested command completed successfully.
EFI_INVALID_PARAMETER	<i>This</i> is NULL.
EFI_INVALID_PARAMETER	No connection for <i>SCardHandle</i> value.
EFI_NO_MEDIA	Smart Card or Reader of <i>SCardHandle</i> connection has been removed. A <b>Disconnect</b> should be performed.

## EFI\_SMART\_CARD\_EDGE\_PROTOCOL.GetReaderName

### Summary

This function returns the name of the Smart Card reader used for this connection.

### Prototype

```
typedef
EFI_STATUS
(EFI_API *EFI_SMART_CARD_EDGE_GET_READER_NAME) (
  IN EFI_SMART_CARD_EDGE_PROTOCOL *This,
  IN EFI_HANDLE      SCardHandle,
  IN OUT UINTN      *ReaderNameLength,
  OUT CHAR16        *ReaderName OPTIONAL
);
```

### Parameters

<i>This</i>	Indicates a pointer to the calling context. Type <b>EFI_SMART_CARD_EDGE_PROTOCOL</b> is defined in the <b>EFI_SMART_CARD_EDGE_PROTOCOL</b> description.
<i>SCardHandle</i>	Handle on Smart Card connection.
<i>ReaderNameLength</i>	On input, a pointer to the variable that holds the maximal size, in bytes, of <i>ReaderName</i> . On output, the required size, in bytes, for <i>ReaderName</i> .
<i>ReaderName</i>	A pointer to a NULL terminated string that will contain the reader name.

### Description

The **GetReaderName** function returns the name of the Smart Card reader used for this connection.

### Status Codes Returned

EFI_SUCCESS	The requested command completed successfully.
EFI_INVALID_PARAMETER	<i>This</i> is NULL.
EFI_INVALID_PARAMETER	No connection for <i>SCardHandle</i> value.
EFI_INVALID_PARAMETER	<i>ReaderNameLength</i> is NULL.
EFI_NO_MEDIA	Smart Card or Reader of <i>SCardHandle</i> connection has been removed. A <b>Disconnect</b> should be performed.

## EFI\_SMART\_CARD\_EDGE\_PROTOCOL.VerifyPin()

### Summary

This function authenticates a Smart Card user by presenting a PIN code.

### Prototype

```
typedef
EFI_STATUS
(EFI_API *EFI_SMART_CARD_EDGE_VERIFY_PIN) (
  IN EFI_SMART_CARD_EDGE_PROTOCOL *This,
  IN EFI_HANDLE      SCardHandle,
  IN INT32          PinSize,
  IN UINT8          *PinCode,
  OUT BOOLEAN       *PinResult,
  OUT UINT32        *RemainingAttempts OPTIONAL
);
```

### Parameters

<i>This</i>	Indicates a pointer to the calling context. Type <b>EFI_SMART_CARD_EDGE_PROTOCOL</b> is defined in the <b>EFI_SMART_CARD_EDGE_PROTOCOL</b> description.
<i>SCardHandle</i>	Handle on Smart Card connection.
<i>PinSize</i>	PIN code buffer size.
<i>PinCode</i>	PIN code to present to the Smart Card.
<i>PinResult</i>	Result of PIN code presentation to the Smart Card. TRUE when Smart Card finds the PIN code correct.
<i>RemainingAttempts</i>	Number of attempts still possible.

### Description

The **VerifyPin** function presents a PIN code to the Smart Card.

If Smart Card found the PIN code correct the user is considered authenticated to current application, and the function returns TRUE.

Negative or null *PinSize* value rejected if *PinCode* is not NULL

A NULL *PinCode* buffer means the application didn't know the PIN, in that case:

- If *PinSize* value is negative the caller only wants to know if the current chain of the elements Smart Card Edge protocol, Smart Card Reader protocol and Smart Card Reader supports the Secure Pin Entry PCSC V2 functionality.
- If *PinSize* value is positive or null the caller ask to perform the verify PIN using the Secure PIN Entry functionality.

In *PinCode* buffer, the PIN value is always given in plaintext, in case of secure messaging the **SMART\_CARD\_EDGE\_PROTOCOL** will be in charge of all intermediate treatments to build the correct Smart Card APDU.

## Status Codes Returned

EFI_SUCCESS	The requested command completed successfully.
EFI_UNSUPPORTED	<i>PinSize</i> < 0 and Secure PIN Entry functionality not supported.
EFI_INVALID_PARAMETER	<i>This</i> is NULL.
EFI_INVALID_PARAMETER	No connection for <i>SCardHandle</i> value.
EFI_INVALID_PARAMETER	Bad value for <i>PinSize</i> : value not supported by Smart Card or, negative with <i>PinCode</i> not null.
EFI_INVALID_PARAMETER	<i>PinResult</i> is NULL.
EFI_NO_MEDIA	Smart Card or Reader of <i>SCardHandle</i> connection has been removed. A <b>Disconnect</b> should be performed.

## EFI\_SMART\_CARD\_EDGE\_PROTOCOL.GetPinRemaining()

### Summary

This function gives the remaining number of attempts for PIN code presentation.

### Prototype

```
typedef
EFI_STATUS
(EFI_API *EFI_SMART_CARD_EDGE_GET_PIN_REMAINING) (
  IN EFI_SMART_CARD_EDGE_PROTOCOL *This,
  IN EFI_HANDLE      SCardHandle,
  OUT UINT32        *RemainingAttempts
);
```

### Parameters

<i>This</i>	Indicates a pointer to the calling context. Type <b>EFI_SMART_CARD_EDGE_PROTOCOL</b> is defined in the <b>EFI_SMART_CARD_EDGE_PROTOCOL</b> description.
<i>SCardHandle</i>	Handle on Smart Card connection.
<i>RemainingAttempts</i>	Number of attempts still possible.

### Description

The number of attempts to present a correct PIN is limited and depends on Smart Card and on PIN.

This function will retrieve the number of remaining possible attempts.

### Status Codes Returned

EFI_SUCCESS	The requested command completed successfully.
EFI_INVALID_PARAMETER	<i>This</i> is NULL.
EFI_INVALID_PARAMETER	No connection for <i>SCardHandle</i> value.
EFI_INVALID_PARAMETER	<i>RemainingAttempts</i> is NULL.
EFI_NO_MEDIA	Smart Card or Reader of <i>SCardHandle</i> connection has been removed. A <b>Disconnect</b> should be performed.

## EFI\_SMART\_CARD\_EDGE\_PROTOCOL.GetData()

### Summary

This function returns a specific data from Smart Card.

### Prototype

```
typedef
EFI_STATUS
(EFI_API *EFI_SMART_CARD_EDGE_GET_DATA) (
  IN EFI_SMART_CARD_EDGE_PROTOCOL *This,
  IN EFI_HANDLE      SCardHandle,
  IN EFI_GUID        *DataId,
  IN OUT UINTN       *DataSize,
  OUT VOID           *Data OPTIONAL
);
```

### Parameters

<i>This</i>	Indicates a pointer to the calling context. Type <b>EFI_SMART_CARD_EDGE_PROTOCOL</b> is defined in the <b>EFI_SMART_CARD_EDGE_PROTOCOL</b> description.
<i>SCardHandle</i>	Handle on Smart Card connection.
<i>DataId</i>	The type identifier of the data to get.
<i>DataSize</i>	On input, in bytes, the size of <i>Data</i> . On output, in bytes, the size of buffer required to store the specified data.
<i>Data</i>	The data buffer in which the data is returned. The type of the data buffer is associated with the <i>DataId</i> . Ignored if <i>*DataSize</i> is 0.

### Description

This function returns a data from Smart Card. The function is generic for any kind of data, but driver and application must share an EFI\_GUID that identify the data.

### Status Codes Returned

EFI_SUCCESS	The requested command completed successfully.
EFI_INVALID_PARAMETER	<i>This</i> is NULL.
EFI_INVALID_PARAMETER	No connection for <i>SCardHandle</i> value.
EFI_INVALID_PARAMETER	<i>DataId</i> is NULL.
EFI_INVALID_PARAMETER	<i>DataSize</i> is NULL.
EFI_INVALID_PARAMETER	<i>Data</i> is NULL, and <i>*DataSize</i> is not zero.
EFI_NOT_FOUND	<i>DataId</i> unknown for this driver.
EFI_BUFFER_TOO_SMALL	The size of <i>Data</i> is too small for the specified data and the required size is returned in <i>DataSize</i> .

EFI_ACCESS_DENIED	Operation not performed, conditions not fulfilled. PIN not verified.
EFI_NO_MEDIA	Smart Card or Reader of <i>SCardHandle</i> connection has been removed. A <b>Disconnect</b> should be performed.



## EFI\_SMART\_CARD\_EDGE\_PROTOCOL.GetCredentials()

### Summary

This function retrieve credentials store into the Smart Card.

### Prototype

```
typedef
EFI_STATUS
(EFI_API *EFI_SMART_CARD_EDGE_GET_CREDENTIAL) (
  IN EFI_SMART_CARD_EDGE_PROTOCOL *This,
  IN EFI_HANDLE      SCardHandle,
  IN OUT UINTN      *CredentialSize,
  OUT UINT8         *CredentialList OPTIONAL
);
```

### Parameters

<i>This</i>	Indicates a pointer to the calling context. Type <b>EFI_SMART_CARD_EDGE_PROTOCOL</b> is defined in the <b>EFI_SMART_CARD_EDGE_PROTOCOL</b> description.
<i>SCardHandle</i>	Handle on Smart Card connection.
<i>CredentialSize</i>	On input, in bytes, the size of buffer to store the list of credential. On output, in bytes, the size of buffer required to store the entire list of credentials.
<i>CredentialList</i>	List of credentials stored into the Smart Card. A list of TLV (Tag Length Value) elements organized in containers array.

## Related Definitions

```

//Type of data elements in credentials list
#define SC_EDGE_TAG_HEADER 0x0000 \
    // value of tag field for header,
    // the number of containers
#define SC_EDGE_TAG_CERT 0x0001 // value of tag field for certificate
#define SC_EDGE_TAG_KEY_ID 0x0002 // value of tag field for key index
    // associated with certificate
#define SC_EDGE_TAG_KEY_TYPE 0x0003 // value of tag field for key type
#define SC_EDGE_TAG_KEY_SIZE 0x0004 // value of tag field for key size

//Length of L fields of TLV items
#define SC_EDGE_L_SIZE_HEADER 1 // size of L field for header
#define SC_EDGE_L_SIZE_CERT 2 // size of L field for certificate (big endian)
#define SC_EDGE_L_SIZE_KEY_ID 1 // size of L field for key index
#define SC_EDGE_L_SIZE_KEY_TYPE 1 // size of L field for key type
#define SC_EDGE_L_SIZE_KEY_SIZE 2 // size of L field for key size (big endian)

//Some TLV items have a fixed value for L field
#define SC_EDGE_L_VALUE_HEADER 1 // value of L field for header
#define SC_EDGE_L_VALUE_KEY_ID 1 // value of L field for key index
#define SC_EDGE_L_VALUE_KEY_TYPE 1 // value of L field for key type
#define SC_EDGE_L_VALUE_KEY_SIZE 2 // value of L field for key size

//Possible values for key type
#define SC_EDGE_RSA_EXCHANGE 0x01 //RSA decryption
#define SC_EDGE_RSA_SIGNATURE 0x02 //RSA signature
#define SC_EDGE_ECDSA_256 0x03 //ECDSA signature
#define SC_EDGE_ECDSA_384 0x04 //ECDSA signature
#define SC_EDGE_ECDSA_521 0x05 //ECDSA signature
#define SC_EDGE_ECDH_256 0x06 //ECDH agreement
#define SC_EDGE_ECDH_384 0x07 //ECDH agreement
#define SC_EDGE_ECDH_521 0x08 //ECDH agreement

```

## Description

The function returns a series of items in TLV (Tag Length Value) format.

First TLV item is the header item that gives the number of following containers (0x00, 0x01, Nb containers).

All these containers are a series of 4 TLV items:

- The certificate item (0x01, certificate size, certificate)
- The Key identifier item (0x02, 0x01, key index)
- The key type item (0x03, 0x01, key type)
- The key size item (0x04, 0x02, key size), key size in number of bits.

Numeric multi-bytes values are on big endian format, most significant byte first:

- The L field value for certificate (2 bytes)
- The L field value for key size (2 bytes)
- The value field for key size (2 bytes)

## Status Codes Returned

EFI_SUCCESS	The requested command completed successfully.
EFI_INVALID_PARAMETER	<i>This</i> is NULL.
EFI_INVALID_PARAMETER	No connection for <i>SCardHandle</i> value.
EFI_INVALID_PARAMETER	<i>CredentialSize</i> is NULL.
EFI_INVALID_PARAMETER	<i>CredentialList</i> is NULL, if <i>CredentialSize</i> is not zero.
EFI_BUFFER_TOO_SMALL	The size of <i>CredentialList</i> is too small for the specified data and the required size is returned in <i>CredentialSize</i> .
EFI_NO_MEDIA	Smart Card or Reader of <i>SCardHandle</i> connection has been removed. A <b>Disconnect</b> should be performed.

## EFI\_SMART\_CARD\_EDGE\_PROTOCOL.SignData()

### Summary

This function signs an already hashed data with a Smart Card private key.

### Prototype

```
typedef
EFI_STATUS
(EFI_API *EFI_SMART_CARD_EDGE_SIGN_DATA) (
  IN EFI_SMART_CARD_EDGE_PROTOCOL *This,
  IN EFI_HANDLE      SCardHandle,
  IN UINTN           KeyId,
  IN UINTN           KeyType,
  IN EFI_GUID        *HashAlgorithm,
  IN EFI_GUID        *PaddingMethod,
  IN UINT8           *HashedData,
  OUT UINT8          *SignatureData
);
```

### Parameters

<i>This</i>	Indicates a pointer to the calling context. Type <b>EFI_SMART_CARD_EDGE_PROTOCOL</b> is defined in the <b>EFI_SMART_CARD_EDGE_PROTOCOL</b> description.
<i>SCardHandle</i>	Handle on Smart Card connection.
<i>KeyId</i>	Identifier of the key container, retrieved in a key index item of credentials.
<i>KeyType</i>	The key type, retrieved in a key type item of credentials.
<i>HashAlgorithm</i>	Hash algorithm used to hash the, one of: <ul style="list-style-type: none"> <li>• <b>EFI_HASH_ALGORITHM_SHA1_GUID</b></li> <li>• <b>EFI_HASH_ALGORITHM_SHA256_GUID</b></li> <li>• <b>EFI_HASH_ALGORITHM_SHA384_GUID</b></li> <li>• <b>EFI_HASH_ALGORITHM_SHA512_GUID</b></li> </ul>
<i>PaddingMethod</i>	Padding method used jointly with hash algorithm, one of: <ul style="list-style-type: none"> <li>• <b>EFI_PADDING_RSASSA_PKCS1V1P5_GUID</b></li> <li>• <b>EFI_PADDING_RSASSA_PSS_GUID</b></li> </ul>
<i>HashedData</i>	Hash of the data to sign. Size is function of the <i>HashAlgorithm</i> .
<i>SignatureData</i>	Resulting signature with private key <i>KeyId</i> . Size is function of the <i>KeyType</i> and key size retrieved in the associated key size item of credentials.

## Related Definitions

```
//
// Padding methods GUIDs for signature
//

//
// RSASSA- PKCS#1-V1.5 padding method, for signature
//
#define EFI_PADDING_RSASSA_PKCS1V1P5_GUID \
{0x9317ec24,0x7cb0,0x4d0e,\
0x8b,0x32,0x2e,0xd9,0x20,0x9c,0xd8,0xaf}

//
// RSASSA-PSS padding method, for signature
//
#define EFI_PADDING_RSASSA_PSS_GUID \
{0x7b2349e0,0x522d,0x4f8e,\
0xb9,0x27,0x69,0xd9,0x7c,0x9e,0x79,0x5f}
```

## Description

This function signs data, actually it is the hash of these data that is given to the function.

*SignatureData* buffer shall be big enough for signature. Signature size is function key size and key type.

## Status Codes Returned

EFI_SUCCESS	The requested command completed successfully.
EFI_INVALID_PARAMETER	<i>This</i> is NULL.
EFI_INVALID_PARAMETER	No connection for <i>SCardHandle</i> value.
EFI_INVALID_PARAMETER	<i>KeyId</i> is not valid.
EFI_INVALID_PARAMETER	<i>KeyType</i> is not valid or not corresponding to <i>KeyId</i> .
EFI_INVALID_PARAMETER	<i>HashAlgorithm</i> is NULL.
EFI_INVALID_PARAMETER	<i>HashAlgorithm</i> is not valid.
EFI_INVALID_PARAMETER	<i>PaddingMethod</i> is NULL.
EFI_INVALID_PARAMETER	<i>PaddingMethod</i> is not valid.
EFI_INVALID_PARAMETER	<i>HashedData</i> is NULL.
EFI_INVALID_PARAMETER	<i>SignatureData</i> is NULL.
EFI_ACCESS_DENIED	Operation not performed, conditions not fulfilled. PIN not verified.
EFI_NO_MEDIA	Smart Card or Reader of <i>SCardHandle</i> connection has been removed. A <b>Disconnect</b> should be performed.

## EFI\_SMART\_CARD\_EDGE\_PROTOCOL.DecryptData()

### Summary

This function decrypts data with a PKI/RSA Smart Card private key.

### Prototype

```
typedef
EFI_STATUS
(EFI_API *EFI_SMART_CARD_EDGE_DECRYPT_DATA) (
  IN EFI_SMART_CARD_EDGE_PROTOCOL *This,
  IN EFI_HANDLE      SCardHandle,
  IN UINTN           KeyId,
  IN EFI_GUID        *HashAlgorithm,
  IN EFI_GUID        *PaddingMethod,
  IN UINTN           EncryptedSize,
  IN UINT8           *EncryptedData,
  IN OUT UINTN       *PlaintextSize,
  OUT UINT8          *PlaintextData
);
```

### Parameters

<i>This</i>	Indicates a pointer to the calling context. Type <b>EFI_SMART_CARD_EDGE_PROTOCOL</b> is defined in the <b>EFI_SMART_CARD_EDGE_PROTOCOL</b> description.
<i>SCardHandle</i>	Handle on Smart Card connection.
<i>KeyId</i>	Identifier of the key container, retrieved in a key index item of credentials.
<i>HashAlgorithm</i>	Hash algorithm used to hash the, one of: <ul style="list-style-type: none"> <li>• <b>EFI_HASH_ALGORITHM_SHA1_GUID</b></li> <li>• <b>EFI_HASH_ALGORITHM_SHA256_GUID</b></li> <li>• <b>EFI_HASH_ALGORITHM_SHA384_GUID</b></li> <li>• <b>EFI_HASH_ALGORITHM_SHA512_GUID</b></li> </ul>
<i>PaddingMethod</i>	Padding method used jointly with hash algorithm, one of: <ul style="list-style-type: none"> <li>• <b>EFI_PADDING_NONE_GUID</b></li> <li>• <b>EFI_PADDING_RSAES_PKCS1V1P5_GUID</b></li> <li>• <b>EFI_PADDING_RSAES_OAEP_GUID</b></li> </ul>
<i>EncryptedSize</i>	Size of data to decrypt
<i>EncryptedData</i>	Data to decrypt
<i>PlaintextSize</i>	On input, in bytes, the size of buffer to store the decrypted data. On output, in bytes, the size of buffer required to store the decrypted data.
<i>PlaintextData</i>	Buffer for decrypted data, padding removed.

## Related Definitions

```
//
// Padding methods GUIDs for decryption
//

//
// No padding, for decryption
//
#define EFI_PADDING_NONE_GUID \
{0x3629ddb1,0x228c,0x452e,\
0xb6,0x16,0x09,0xed,0x31,0x6a,0x97,0x00}}

//
// RSAES-PKCS#1-V1.5 padding, for decryption
//
#define EFI_PADDING_RSAES_PKCS1V1P5_GUID \
{0xe1c1d0a9,0x40b1,0x4632,\
0xbd,0xcc,0xd9,0xd6,0xe5,0x29,0x56,0x31}}

//
// RSAES-OAEP padding, for decryption
//
#define EFI_PADDING_RSAES_OAEP_GUID \
{0xc1e63ac4,0xd0cf,0x4ce6,\
0x83,0x5b,0xee,0xd0,0xe6,0xa8,0xa4,0x5b}}
```

## Description

The function decrypts some PKI / RSA encrypted data with private key securely stored into the Smart Card.

The *KeyId* must reference a key of type SC\_EDGE\_RSA\_EXCHANGE.

## Status Codes Returned

EFI_SUCCESS	The requested command completed successfully.
EFI_INVALID_PARAMETER	<i>This</i> is NULL.
EFI_INVALID_PARAMETER	No connection for <i>SCardHandle</i> value.
EFI_INVALID_PARAMETER	<i>KeyId</i> is not valid or associated key not of type <b>SC_EDGE_RSA_EXCHANGE</b> .
EFI_INVALID_PARAMETER	<i>HashAlgorithm</i> is NULL.
EFI_INVALID_PARAMETER	<i>HashAlgorithm</i> is not valid.
EFI_INVALID_PARAMETER	<i>PaddingMethod</i> is NULL.
EFI_INVALID_PARAMETER	<i>PaddingMethod</i> is not valid.

EFI_INVALID_PARAMETER	<i>EncryptedSize</i> is 0.
EFI_INVALID_PARAMETER	<i>EncryptedData</i> is NULL.
EFI_INVALID_PARAMETER	<i>PlaintextSize</i> is NULL.
EFI_INVALID_PARAMETER	<i>PlaintextData</i> is NULL.
EFI_ACCESS_DENIED	Operation not performed, conditions not fulfilled. PIN not verified.
EFI_BUFFER_TOO_SMALL	<i>PlaintextSize</i> is too small for the plaintext data and the required size is returned in <i>PlaintextSize</i> .
EFI_NO_MEDIA	Smart Card or Reader of <i>SCardHandle</i> connection has been removed. A <b>Disconnect</b> should be performed.



## EFI\_SMART\_CARD\_EDGE\_PROTOCOL.BuildDHAgreement()

### Summary

This function performs a secret Diffie Hellman agreement calculation that would be used to derive a symmetric encryption / decryption key.

### Prototype

```
typedef
EFI_STATUS
(EFIAPI *EFI_SMART_CARD_EDGE_BUILD_DH_AGREEMENT) (
  IN EFI_SMART_CARD_EDGE_PROTOCOL *This,
  IN EFI_HANDLE      SCardHandle,
  IN UINTN          KeyId,
  IN UINT8          *dataQx,
  IN UINT8          *dataQy,
  OUT UINT8         *DHAgreement
);
```

### Parameters

<i>This</i>	Indicates a pointer to the calling context. Type <b>EFI_SMART_CARD_EDGE_PROTOCOL</b> is defined in the <b>EFI_SMART_CARD_EDGE_PROTOCOL</b> description.
<i>SCardHandle</i>	Handle on Smart Card connection.
<i>KeyId</i>	Identifier of the key container, retrieved in a key index item of credentials.
<i>dataQx</i>	Public key x coordinate. Size is the same as key size for <i>KeyId</i> . Stored in big endian format.
<i>dataQy</i>	Public key y coordinate. Size is the same as key size for <i>KeyId</i> . Stored in big endian format.
<i>DHAgreement</i>	Buffer for DH agreement computed. Size must be bigger or equal to key size for <i>KeyId</i> .

### Description

The function compute a DH agreement that should be diversified to generate a symmetric key to proceed encryption or decryption.

The application and the Smart Card shall agree on the diversification process.

The *KeyId* must reference a key of one of the types: **SC\_EDGE\_ECDH\_256**, **SC\_EDGE\_ECDH\_384** or **SC\_EDGE\_ECDH\_521**.

## Status Codes Returned

EFI_SUCCESS	The requested command completed successfully.
EFI_INVALID_PARAMETER	<i>This</i> is NULL.
EFI_INVALID_PARAMETER	No connection for <i>SCardHandle</i> value.
EFI_INVALID_PARAMETER	<i>KeyId</i> is not valid.
EFI_INVALID_PARAMETER	<i>dataQx</i> is NULL.
EFI_INVALID_PARAMETER	<i>dataQy</i> is NULL.
EFI_INVALID_PARAMETER	<i>DHAgreement</i> is NULL.
EFI_ACCESS_DENIED	Operation not performed, conditions not fulfilled. PIN not verified.
EFI_NO_MEDIA	Smart Card or Reader of <i>SCardHandle</i> connection has been removed. A <b>Disconnect</b> should be performed.

## 37 Miscellaneous Protocols

---

### 37.1 EFI Timestamp Protocol

#### EFI\_TIMESTAMP\_PROTOCOL

##### Summary

The Timestamp protocol provides a platform independent interface for retrieving a high resolution timestamp counter.

##### GUID

```
#define EFI_TIMESTAMP_PROTOCOL_GUID \
    { 0xafbfde41, 0x2e6e, 0x4262, \
      { 0xba, 0x65, 0x62, 0xb9, 0x23, 0x6e, 0x54, 0x95 } }
```

##### Protocol Interface Structure

```
typedef struct _EFI_TIMESTAMP_PROTOCOL {
    TIMESTAMP_GET      GetTimestamp;
    TIMESTAMP_GET_PROPERTIES GetProperties;
} EFI_TIMESTAMP_PROTOCOL;
```

#### EFI\_TIMESTAMP\_PROTOCOL.GetTimestamp()

##### Summary

Retrieves the current timestamp counter value.

##### Prototype

```
typedef
UINT64
(EFI_API *TIMESTAMP_GET) (
    VOID
);
```

##### Description

Retrieves the current value of a 64-bit free running timestamp counter.

The counter shall count up in proportion to the amount of time that has passed. The counter value will always roll over to zero. The properties of the counter can be retrieved from GetProperties().

The caller should be prepared for the function to return the same value twice across successive calls. The counter value will not go backwards other than when wrapping, as defined by EndValue in GetProperties().

The frequency of the returned timestamp counter value must remain constant. Power management operations that affect clocking must not change the returned counter frequency. The quantization of counter value updates may vary as long as the value reflecting time passed remains consistent.

## Return Value

The current value of the free running timestamp counter.

## EFI\_TIMESTAMP\_PROTOCOL.GetProperties ()

### Summary

Obtains timestamp counter properties including frequency and value limits.

### Prototype

```
typedef
EFI_STATUS
(EFIAPI *TIMESTAMP_GET_PROPERTIES) (
OUT EFI_TIMESTAMP_PROPERTIES *Properties
);
```

### Parameters

*Properties*

The properties of the timestamp counter. See "Related Definitions" below.

### Description

Retrieves the timestamp counter properties structure.

### Related Definitions

```
typedef struct {
UINT64 Frequency;

UINT64 EndValue;
} EFI_TIMESTAMP_PROPERTIES;
```

*Frequency*

The frequency of the timestamp counter in Hz.

*EndValue*

The value that the timestamp counter ends with immediately before it rolls over. For example, a 64-bit free running counter would have an EndValue of 0xFFFFFFFFFFFFFFFF. A 24-bit free running counter would have an EndValue of 0xFFFFFF.

## Status Codes Returned

EFI_SUCCESS	The properties were successfully retrieved.
EFI_DEVICE_ERROR	An error occurred trying to retrieve the properties of the timestamp counter subsystem. <i>Properties</i> is not updated.
EFI_INVALID_PARAMETER	<i>Properties</i> is <b>NULL</b> .

## 37.2 Reset Notification Protocol

### EFI\_RESET\_NOTIFICATION\_PROTOCOL

#### Summary

This protocol provides services to register for a notification when `ResetSystem` is called.

#### GUID

```
#define EFI_RESET_NOTIFICATION_PROTOCOL_GUID \
    { 0x9da34ae0, 0xeaf9, 0x4bbf, \
      { 0x8e, 0xc3, 0xfd, 0x60, 0x22, 0x6c, 0x44, 0xbe } }
```

#### Protocol Interface Structure

```
typedef struct _EFI_RESET_NOTIFICATION_PROTOCOL {
    EFI_REGISTER_RESET_NOTIFY      RegisterResetNotify;
    EFI_UNREGISTER_RESET_NOTIFY    UnRegisterResetNotify;
} EFI_RESET_NOTIFICATION_PROTOCOL;
```

#### Parameters

*RegisterResetNotify*

Register a notification function to be called when `ResetSystem()` is called.

*UnRegisterResetNotify*

Removes a reset notification function that has been previously registered with `RegisterResetNotify()`.

### EFI\_RESET\_NOTIFICATION\_PROTOCOL.RegisterResetNotify()

#### Summary

Register a notification function to be called when `ResetSystem()` is called.

## Prototype

```
typedef
EFI_STATUS
(EFI_API *EFI_REGISTER_RESET_NOTIFY) (
    IN EFI_RESET_NOTIFICATION_PROTOCOL *This,
    IN EFI_RESET_SYSTEM *ResetFunction,
);
```

## Parameters

*This*

A pointer to the [EFI\\_RESET\\_NOTIFICATION\\_PROTOCOL](#) instance.

*ResetFunction*

Points to the function to be called when a [ResetSystem\(\)](#) is executed.

## Description

The [RegisterResetNotify\(\)](#) function registers a notification function that is called when [ResetSystem\(\)](#) is called and prior to completing the reset of the platform.

The registered functions must not perform a platform reset themselves. These notifications are intended only for the notification of components which may need some special-purpose maintenance prior to the platform resetting.

The list of registered reset notification functions are processed if [ResetSystem\(\)](#) is called before [ExitBootServices\(\)](#). The list of registered reset notification functions is ignored if [ResetSystem\(\)](#) is called after [ExitBootServices\(\)](#).

## Status Codes Returned

EFI_SUCCESS	The reset notification function was successfully registered.
EFI_INVALID_PARAMETER	ResetFunction is NULL.
EFI_OUT_OF_RESOURCES	There are not enough resources available to register the reset notification function.
EFI_ALREADY_STARTED	The reset notification function specified by ResetFunction has already been registered.

## EFI\_RESET\_NOTIFICATION\_PROTOCOL.UnregisterResetNotify()

### Summary

Unregister a notification function.

### Prototype

```
typedef
EFI_STATUS
(EFIAPI *EFI_UNREGISTER_RESET_NOTIFY) (
    IN EFI_RESET_NOTIFICATION_PROTOCOL*This,
    IN EFI_RESET_SYSTEM      *ResetFunction
);
```

### Parameters

*This*

A pointer to the EFI\_RESET\_NOTIFICATION\_PROTOCOL instance.

*ResetFunction*

The pointer to the ResetFunction being unregistered.

### Description

The UnregisterResetNotify() function removes the previously registered notification using RegisterResetNotify().

### Status Codes Returned

EFI_SUCCESS	The reset notification function was unregistered.
EFI_INVALID_PARAMETER	ResetFunction is NULL.
EFI_INVALID_PARAMETER	The reset notification function specified by ResetFunction was not previously registered using RegisterResetNotify().





# Appendix A GUID and Time Formats

All EFI GUIDs (Globally Unique Identifiers) have the format described in RFC 4122 and comply with the referenced algorithms for generating GUIDs. It should also be noted that TimeLow, TimeMid, TimeHighAndVersion fields in the EFI are encoded as little endian. The following table defines the format of an EFI GUID (128 bits).

Table 227. EFI GUID Format

Mnemonic	Byte Offset	Byte Length	Description
TimeLow	0	4	The low field of the timestamp.
TimeMid	4	2	The middle field of the timestamp.
TimeHighAndVersion	6	2	The high field of the timestamp multiplexed with the version number.
ClockSeqHighAndReserved	8	1	The high field of the clock sequence multiplexed with the variant.
ClockSeqLow	9	1	The low field of the clock sequence.
Node	10	6	The spatially unique node identifier. This can be based on any IEEE 802 address obtained from a network card. If no network card exists in the system, a cryptographic-quality random number can be used.

This appendix for GUID defines a 60-bit timestamp format that is used to generate the GUID. All EFI time information is stored in 64-bit structures that contain the following format: The timestamp is a 60-bit value containing a count of 100-nanosecond intervals since 00:00:00.00, 15 October 1582 (the date of Gregorian reform to the Christian calendar). This time value will not roll over until the year 3400 AD. It is assumed that a future version of the EFI specification can deal with the year-3400 issue by extending this format if necessary.

This specification also defines a standard text representation of the GUID. This format is also sometimes called the "registry format". It consists of 36 characters, as follows:

**aa****bb****cc****dd**-**ee****ff**-**gg****hh**-**ij****jj**-**kk****ll****mm****nn****oo****pp**

The pairs **aa** – **pp** are two characters in the range '0'-'9', 'a'-'f' or 'A'-'F', with each pair representing a single byte hexadecimal value.

The following table describes the relationship between the text representation and a 16-byte buffer, the structure defined in [Table 227](#) and the EFI\_GUID structure.

Table 228. Text representation relationships

String	Offset In Buffer	Relationship To <a href="#">Table 227</a>	Relationship To EFI_GUID
<b>aa</b>	3	TimeLow[24:31]	Data1[24:31]
<b>bb</b>	2	TimeLow[16:23]	Data1[16:23]
<b>cc</b>	1	TimeLow[8:15]	Data1[8:15]
<b>dd</b>	0	TimeLow[0:7]	Data1[0:7]
<b>ee</b>	5	TimeMid[8:15]	Data2[8:15]
<b>ff</b>	4	TimeMid[0:7]	Data2[0:7]
<b>gg</b>	7	TimeHighAndVersion[8:15]	Data3[8:15]
<b>hh</b>	6	TimeHighAndVersion[0:7]	Data3[0:7]
<b>ii</b>	8	ClockSeqHighAndReserved[0:7]	Data4[0:7]
<b>jj</b>	9	ClockSeqLow[0:7]	Data4[8:15]
<b>kk</b>	10	Node[0:7]	Data4[16:23]
<b>ll</b>	11	Node[8:15]	Data4[24:31]
<b>mm</b>	12	Node[16:23]	Data4[32:39]
<b>nn</b>	13	Node[24:31]	Data4[40:47]
<b>oo</b>	14	Node[32:39]	Data4[48:55]
<b>pp</b>	15	Node[40:47]	Data4[56:63]

# Appendix B Console

---

The EFI console was designed to allow input from a wide variety of devices. This appendix provides examples of the mapping of keyboard input from various types of devices to EFI scan codes. While representative of common console devices in use today, it is not intended to be a comprehensive list. EFI application programmers can use this table to identify the EFI Scan Code generated by a specific key press. The description of the example device input data that generates a EFI Scan Code may be useful to EFI driver writers, as well as showing the limitations on which EFI Scan codes can be generated by different types of console input devices.

The EFI console was designed so that it could map to common console devices. This appendix explains how an EFI console could map to a VGA with PC AT 101/102, PC ANSI, or ANSI X3.64 consoles.

## B.1 EFI\_SIMPLE\_TEXT\_INPUT\_PROTOCOL and EFI\_SIMPLE\_TEXT\_INPUT\_EX\_PROTOCOL

[Table 229](#) and [Table 230](#) give examples of how input from a set of common input devices is mapped to EFI scan codes. Terminals and terminal emulators generally report function and editing keys as escape or control sequences. These sequences are formed by a control character followed by one or more additional graphic characters that indicate what the sequence means. ANSI X3.64 terminals generally require an ANSI parser to determine how to interpret a sequence and how to determine that the sequence is complete. These terminals can generate sequences using either 8-bit controls or 7-bit control sequences. Older terminal types, such as the VT100+ have a simpler set of sequences that can be interpreted using simple case statements. These terminals usually generate only 7-bit data, and 7-bit control sequences.

In the tables below, the CSI character is the 8-bit control character 0x9B, and is equivalent to the 7-bit control sequence "ESC [" (the 0x1B control ESC followed by the left bracket character 0x5B). The sequences are shown with spaces for readability, but do not contain the space character.

The VT100+ column represents a common class of terminal emulation that is a superset of the Digital Equipment Corporation (DEC) VT100 terminal. This includes VT-UTF8 (Hyperterm) and PC\_ANSI terminal types. The ANSI X3.64 column shows the sequences generated by the DEC VT200 through VT500 terminals, which are an ANSI X3.64 / ISO 6429 compliant.

The USB HID and AT 101/102 columns show the scan codes generated by two common directly attached keyboards. These keyboards are generally used in combination with a VGA text display to form a "VGA Console".

In the table below, the cells with N/A contained in them are simply intended to reflect that the key may be defined for that terminal or keyboard, but there is no industry standard or consistent mapping for the key. Some input devices might not implement all of these keys.

**Table 229. EFI Scan Codes for EFI\_SIMPLE\_TEXT\_INPUT\_PROTOCOL**

EFI Scan Code	Description	ANSI X3.64 / DEC VT200- 500 (8-bit mode)	VT100+ (7-bit mode)	USB Keyboard HID Values	AT 101/102 Keyboard Scan Codes
0x00	Null scan code	N/A	N/A	0x00	N/A
0x01	UP ARROW	CSI A	ESC [ A	0x52	0xe0, 0x48
0x02	DOWN ARROW	CSI B	ESC [ B	0x51	0xe0, 0x50
0x03	RIGHT ARROW	CSI C	ESC [ C	0x4F	0xe0, 0x4d
0x04	LEFT ARROW	CSI D	ESC [ D	0x50	0xe0, 0x4b
0x05	Home	CSI 1 ~	ESC h	0x4A	0xe0, 0x47
0x06	End	CSI 4 ~	ESC k	0x4D	0xe0, 0x4f
0x07	Insert	CSI 2 ~	ESC +	0x49	0xe0, 0x52
0x08	Delete	CSI 3 ~	ESC -	0x4C	0xe0, 0x53
0x09	Page Up	CSI 5 ~	ESC ?	0x4B	0xe0, 0x49
0x0a	Page Down	CSI 6 ~	ESC /	0x4E	0xe0, 0x51
0x0b	Function 1	CSI 1 1 ~	ESC 1	0x3A	0x3b
0x0c	Function 2	CSI 1 2 ~	ESC 2	0x3B	0x3c
0x0d	Function 3	CSI 1 3 ~	ESC 3	0x3C	0x3d
0x0e	Function 4	CSI 1 4 ~	ESC 4	0x3D	0x3e
0x0f	Function 5	CSI 1 5 ~	ESC 5	0x3E	0x3f
0x10	Function 6	CSI 1 7 ~	ESC 6	0x3F	0x40
0x11	Function 7	CSI 1 8 ~	ESC 7	0x40	0x41
0x12	Function 8	CSI 1 9 ~	ESC 8	0x41	0x42
0x13	Function 9	CSI 2 0 ~	ESC 9	0x42	0x43
0x14	Function 10	CSI 2 1 ~	ESC 0	0x43	0x44
0x17	Escape	ESC	ESC	0x29	0x01

**Table 230. EFI Scan Codes for EFI\_SIMPLE\_TEXT\_INPUT\_EX\_PROTOCOL**

EFI Scan Code	Description	ANSI X3.64 / DEC VT200- 500 (8-bit mode)	VT100+ (7-bit mode)	USB Keyboard HID Values	AT 101/102 Keyboard Scan Codes
0x15	Function 11	CSI 2 3 ~	ESC !	0x44	0x57
0x16	Function 12	CSI 2 4 ~	ESC @	0x45	0x58
0x48	Pause	N/A	N/A	0x48	0xe1, 0x1d, 0x45
0x68	Function 13	CSI 2 5 ~	N/A	0x68	N/A
0x69	Function 14	CSI 2 6 ~	N/A	0x69	N/A
0x6A	Function 15	CSI 2 7 ~	N/A	0x6A	N/A

EFI Scan Code	Description	ANSI X3.64 / DEC VT200- 500 (8-bit mode)	VT100+ (7-bit mode)	USB Keyboard HID Values	AT 101/102 Keyboard Scan Codes
0x6B	Function 16	CSI 2 8 ~	N/A	0x6B	N/A
0x6C	Function 17	CSI 2 9 ~	N/A	0x6C	N/A
0x6D	Function 18	CSI 3 0 ~	N/A	0x6D	N/A
0x6E	Function 19	CSI 3 1 ~	N/A	0x6E	N/A
0x6F	Function 20	CSI 3 2 ~	N/A	0x6F	N/A
0x70	Function 21	N/A	N/A	0x70	N/A
0x71	Function 22	N/A	N/A	0x71	N/A
0x72	Function 23	N/A	N/A	0x72	N/A
0x73	Function 24	N/A	N/A	0x73	N/A
0x7F	Mute	N/A	N/A	0x7F	N/A
0x80	Volume Up	N/A	N/A	0x80	N/A
0x81	Volume Down	N/A	N/A	0x81	N/A
0x100	Brightness Up	N/A	N/A	N/A	N/A
0x101	Brightness Down	N/A	N/A	N/A	N/A
0x102	Suspend	N/A	N/A	N/A	N/A
0x103	Hibernate	N/A	N/A	N/A	N/A
0x104	Toggle Display	N/A	N/A	N/A	N/A
0x105	Recovery	N/A	N/A	N/A	N/A
0x106	Eject	N/A	N/A	N/A	N/A
0x8000-0xFFFF	OEM Reserved	N/A	N/A	N/A	N/A

## B.2 EFI\_SIMPLE\_TEXT\_OUTPUT\_PROTOCOL

[Table 231](#) defines how the programmatic methods of the [EFI SIMPLE TEXT OUTPUT PROTOCOL](#) could be implemented as PC ANSI or ANSI X3.64 terminals. Detailed descriptions of PC ANSI and ANSI X3.64 escape sequences are as follows. The same type of operations can be supported via a PC AT type INT 10h interface.

**Table 231. Control Sequences to Implement `EFI_SIMPLE_TEXT_INPUT_PROTOCOL`**

PC ANSI Codes	ANSI X3.64 Codes	Description
ESC [ 2 J	CSI 2 J	Clear Display Screen.
ESC [ 0 m	CSI 0 m	Normal Text.
ESC [ 1 m	CSI 1 m	Bright Text.
ESC [ 7 m	CSI 7 m	Reversed Text.
ESC [ 30 m	CSI 30 m	Black foreground, compliant with ISO Standard 6429.
ESC [ 31 m	CSI 31 m	Red foreground, compliant with ISO Standard 6429.
ESC [ 32 m	CSI 32 m	Green foreground, compliant with ISO Standard 6429.
ESC [ 33 m	CSI 33 m	Yellow foreground, compliant with ISO Standard 6429.
ESC [ 34 m	CSI 34 m	Blue foreground, compliant with ISO Standard 6429.
ESC [ 35 m	CSI 35 m	Magenta foreground, compliant with ISO Standard 6429.
ESC [ 36 m	CSI 36 m	Cyan foreground, compliant with ISO Standard 6429.
ESC [ 37 m	CSI 37 m	White foreground, compliant with ISO Standard 6429.
ESC [ 40 m	CSI 40 m	Black background, compliant with ISO Standard 6429.
ESC [ 41 m	CSI 41 m	Red background, compliant with ISO Standard 6429.
ESC [ 42 m	CSI 42 m	Green background, compliant with ISO Standard 6429.
ESC [ 43 m	CSI 43 m	Yellow background, compliant with ISO Standard 6429.
ESC [ 44 m	CSI 44 m	Blue background, compliant with ISO Standard 6429.
ESC [ 45 m	CSI 45 m	Magenta background, compliant with ISO Standard 6429.
ESC [ 46 m	CSI 46 m	Cyan background, compliant with ISO Standard 6429.
ESC [ 47 m	CSI 47 m	White background, compliant with ISO Standard 6429.
ESC [ = 3 h	CSI = 3 h	Set Mode 80x25 color.
ESC [ <i>row;col</i> H	CSI <i>row;col</i> H	Set cursor position to <i>row;col</i> . <i>Row</i> and <i>col</i> are strings of ASCII digits.

# Appendix C Device Path Examples

This appendix presents an example EFI Device Path and explains its relationship to the ACPI name space. An example system design is presented along with its corresponding ACPI name space. These physical examples are mapped back to EFI Device Paths.

## C.1 Example Computer System

[Figure 141](#) represents a hypothetical computer system architecture that will be used to discuss the construction of EFI Device Paths. The system consists of a memory controller that connects directly to the processors' front side bus. The memory controller is only part of a larger chipset, and it connects to a root PCI host bridge chip, and a secondary root PCI host bridge chip. The secondary PCI host bridge chip produces a PCI bus that contains a PCI to PCI bridge. The root PCI host bridge produces a PCI bus, and also contains USB, ATA66, and AC '97 controllers. The root PCI host bridge also contains an LPC bus that is used to connect a SIO (Super IO) device. The SIO contains a PC-AT-compatible floppy disk controller, and other PC-AT-compatible devices like a keyboard controller.

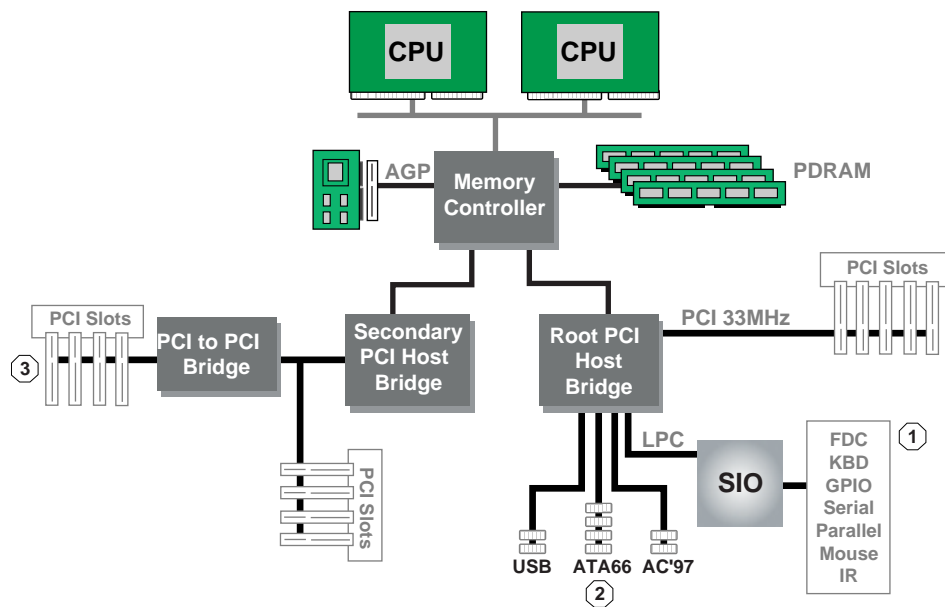

Figure 141. Example Computer System

The remainder of this appendix describes how to construct a device path for three example devices from the system in [Figure 141](#). The following is a list of the examples used:

- Legacy floppy

- IDE Disk
- Secondary root PCI bus with PCI to PCI bridge

Figure 142 is a partial ACPI name space for the system in Figure 141. Figure 142 is based on Figure 5-3 in the *Advanced Configuration and Power Interface Specification*.

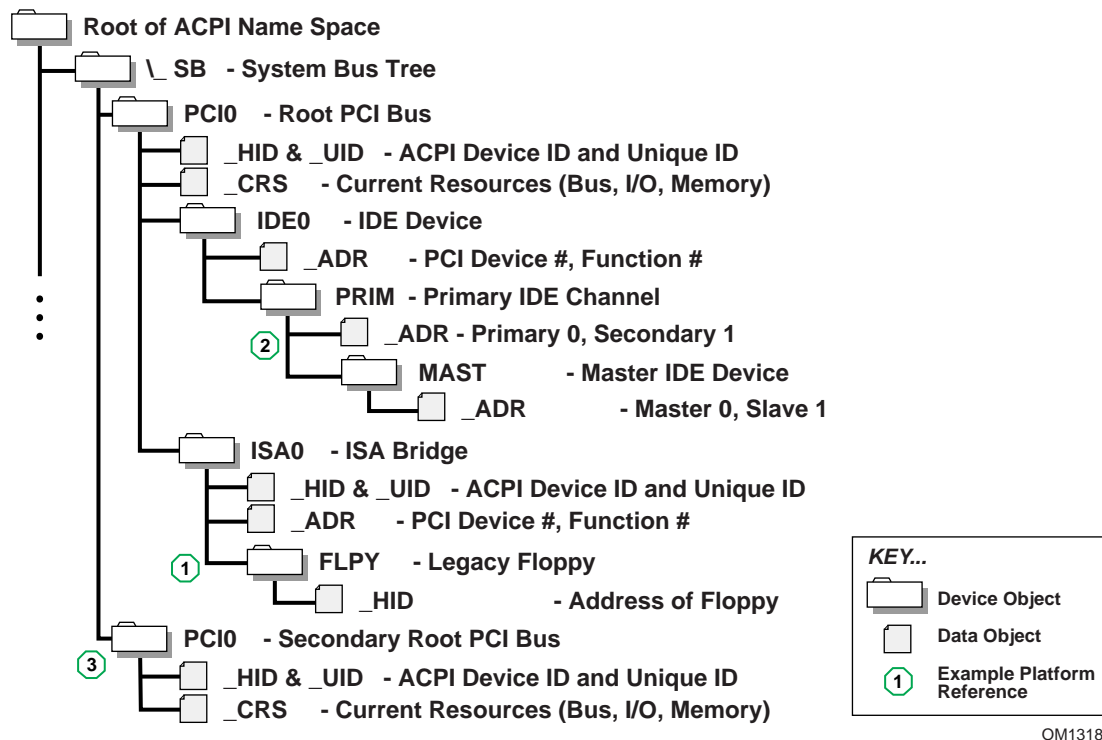

OM13180

Figure 142. Partial ACPI Name Space for Example System

## C.2 Legacy Floppy

The legacy floppy controller is contained in the SIO chip that is connected root PCI bus host bridge chip. The root PCI host bridge chip produces PCI bus 0, and other resources that appear directly to the processors in the system.

In ACPI this configuration is represented in the `_SB`, system bus tree, of the ACPI name space. `PCI0` is a child of `_SB` and it represents the root PCI host bridge. The SIO appears to the system to be a set of ISA devices, so it is represented as a child of `PCI0` with the name `ISA0`. The floppy controller is represented by `FLPY` as a child of the `ISA0` bus.

The EFI Device Path for the legacy floppy is defined in Table 232. It would contain entries for the following things:

- Root PCI Bridge. ACPI Device Path `_HID PNP0A03, _UID 0`. ACPI name space `\_SB\PCI0`
- PCI to ISA Bridge. PCI Device Path with device and function of the PCI to ISA bridge. ACPI name space `\_SB\PCI0\ISA0`



- Floppy Plug and Play ID. ACPI Device Path \_HID PNP0303, \_UID 0. ACPI name space \\_SB\PCIO\ISA0\FLPY
- End Device Path

**Table 232. Legacy Floppy Device Path**

Byte Offset	Byte Length	Data	Description
0	1	0x02	<b>Generic Device Path Header</b> – Type ACPI Device Path
1	1	0x01	Sub type – ACPI Device Path
2	2	0x0C	Length
4	4	0x41D0, 0x0A03	_HID PNP0A03 – 0x41D0 represents the compressed string ‘PNP’ and is encoded in the low order bytes. The compression method is described in the ACPI Specification.
8	4	0x0000	_UID
C	1	0x01	<b>Generic Device Path Header</b> – Type Hardware Device Path
D	1	0x01	Sub type PCI Device Path
E	2	0x06	Length
10	1	0x00	PCI Function
11	1	0x10	PCI Device
12	1	0x02	<b>Generic Device Path Header</b> – Type ACPI Device Path
13	1	0x01	Sub type – ACPI Device Path
14	2	0x0C	Length
16	4	0x41D0, 0x0303	_HID PNP0303
1A	4	0x0000	_UID
1E	1	0xFF	<b>Generic Device Path Header</b> – Type End Device Path
1F	1	0xFF	Sub type – End Device Path
20	2	0x04	Length

### C.3 IDE Disk

The IDE Disk controller is a PCI device that is contained in a function of the root PCI host bridge. The root PCI host bridge is a multi function device and has a separate function for chipset registers, USB, and IDE. The disk connected to the IDE ATA bus is defined as being on the primary or secondary ATA bus, and of being the master or slave device on that bus.

In ACPI this configuration is represented in the \_SB, system bus tree, of the ACPI name space. PCIO is a child of \_SB and it represents the root PCI host bridge. The IDE controller appears to the system to be a PCI device with some legacy properties, so it is represented as a child of PCIO with the name IDE0. PRIM is a child of IDE0 and it represents the primary ATA bus of the IDE controller. MAST is a child of PRIM and it represents that this device is the ATA master device on this primary ATA bus.

The EFI Device Path for the PCI IDE controller is defined in [Table 233](#). It would contain entries for the following things:

- Root PCI Bridge. ACPI Device Path `_HID PNP0A03, _UID 0`. ACPI name space `\_SB\PCIO`
- PCI IDE controller. PCI Device Path with device and function of the IDE controller. ACPI name space `\_SB\PCIO\IDE0`
- ATA Address. ATA Messaging Device Path for Primary bus and Master device. ACPI name space `\_SB\PCIO\IDE0\PRIM\MAST`
- End Device Path

**Table 233. IDE Disk Device Path**

Byte Offset	Byte Length	Data	Description
0	1	0x02	<b>Generic Device Path Header</b> – Type ACPI Device Path
1	1	0x01	Sub type – ACPI Device Path
2	2	0x0C	Length
4	4	0x41D0, 0x0A03	<code>_HID PNP0A03</code> – 0x41D0 represents the compressed string ‘PNP’ and is encoded in the low order bytes. The compression method is described in the ACPI Specification.
8	4	0x0000	<code>_UID</code>
C	1	0x01	<b>Generic Device Path Header</b> – Type Hardware Device Path
D	1	0x01	Sub type PCI Device Path
E	2	0x06	Length
10	1	0x01	PCI Function
11	1	0x10	PCI Device
12	1	0x03	<b>Generic Device Path Header</b> – Messaging Device Path
13	1	0x01	Sub type – ATAPI Device Path
14	2	0x06	Length
16	1	0x00	Primary = 0, Secondary = 1
17	1	0x00	Master = 0, Slave = 1
18	2	0x0000	LUN
1A	1	0xFF	<b>Generic Device Path Header</b> – Type End Device Path
1B	1	0xFF	Sub type – End Device Path
1C	2	0x04	Length

## C.4 Secondary Root PCI Bus with PCI to PCI Bridge

The secondary PCI host bridge materializes a second set of PCI buses into the system. The PCI buses on the secondary PCI host bridge are totally independent of the PCI buses on the root PCI host bridge. The only relationship between the two is they must be configured to not consume the same resources. The primary PCI bus of the secondary PCI

host bridge also contains a PCI to PCI bridge. There is some arbitrary PCI device plugged in behind the PCI to PCI bridge in a PCI slot.

In ACPI this configuration is represented in the `_SB`, system bus tree, of the ACPI name space. `PCI1` is a child of `_SB` and it represents the secondary PCI host bridge. The PCI to PCI bridge and the device plugged into the slot on its primary bus are not described in the ACPI name space. These devices can be fully configured by following the applicable PCI specification.

The EFI Device Path for the secondary root PCI bridge with a PCI to PCI bridge is defined in [Table 234](#). It would contain entries for the following things:

- Root PCI Bridge. ACPI Device Path `_HID PNP0A03, _UID 1`. ACPI name space `\_SB\PCI1`
- PCI to PCI Bridge. PCI Device Path with device and function of the PCI Bridge. ACPI name space `\_SB\PCI1`, PCI to PCI bridges are defined by PCI specification and not ACPI.
- PCI Device. PCI Device Path with the device and function of the PCI device. ACPI name space `\_SB\PCI1`, PCI devices are defined by PCI specification and not ACPI.
- End Device Path.

Table 234. Secondary Root PCI Bus with PCI to PCI Bridge Device Path

Byte Offset	Byte Length	Data	Description
0	1	0x02	<b>Generic Device Path Header</b> – Type ACPI Device Path
1	1	0x01	Sub type – ACPI Device Path
2	2	0x0C	Length
4	4	0x41D0, 0x0A03	_HID PNPOA03 – 0x41D0 represents the compressed string ‘PNP’ and is encoded in the low order bytes. The compression method is described in the ACPI Specification.
8	4	0x0001	_UID
C	1	0x01	<b>Generic Device Path Header</b> – Type Hardware Device Path
D	1	0x01	Sub type PCI Device Path
E	2	0x06	Length
10	1	0x00	PCI Function for PCI to PCI bridge
11	1	0x0c	PCI Device for PCI to PCI bridge
12	1	0x01	<b>Generic Device Path Header</b> – Type Hardware Device Path
13	1	0x01	Sub type PCI Device Path
14	2	0x08	Length
16	1	0x00	PCI Function for PCI Device
17	1	0x00	PCI Device for PCI Device
18	1	0xFF	<b>Generic Device Path Header</b> – Type End Device Path
19	1	0xFF	Sub type – End Device Path
1A	2	0x04	Length

## C.5 ACPI Terms

Names in the ACPI name space that start with an underscore (“\_”) are reserved by the ACPI specification and have architectural meaning. All ACPI names in the name space are four characters in length. The following four ACPI names are used in this specification.

**\_ADR.** The Address on a bus that has standard enumeration. An example would be PCI, where the enumeration method is described in the PCI Local Bus specification.

**\_CRS.** The current resource setting of a device. A \_CRS is required for devices that are not enumerated in a standard fashion. \_CRS is how ACPI converts nonstandard devices into Plug and Play devices.

**\_HID.** Represents a device’s Plug and Play hardware ID, stored as a 32-bit compressed EISA ID. \_HID objects are optional in ACPI. However, a \_HID object must be used to describe any device that will be enumerated by the ACPI driver in the OS. This is how ACPI deals with non-Plug and Play devices.

**\_UID.** Is a serial number style ID that does not change across reboots. If a system contains more than one device that reports the same \_HID, each device must have a unique \_UID. The \_UID only needs to be unique for device that have the exact same \_HID value.

## C.6 EFI Device Path as a Name Space

[Figure 143](#) shows the EFI Device Path for the example system represented as a name space. The Device Path can be represented as a name space, but EFI does support manipulating the Device Path as a name space. You can only access Device Path information by locating the **DEVICE\_PATH\_INTERFACE** from a handle. Not all the nodes in a Device Path will have a handle.

---

---

Figure 143. EFI Device Path Displayed As a Name Space



## Appendix D Status Codes

---

EFI interfaces return an **EFI\_STATUS** code. [Table 236](#), [Table 237](#), and [Table 238](#) list these codes for success, errors, and warnings, respectively. The range of status codes that have the highest bit set and the next to highest bit clear are reserved for use by EFI. The range of status codes that have both the highest bit set and the next to highest bit set are reserved for use by OEMs. Success and warning codes have their highest bit clear, so all success and warning codes have positive values. The range of status codes that have both the highest bit clear and the next to highest bit clear are reserved for use by EFI. The range of status code that have the highest bit clear and the next to highest bit set are reserved for use by OEMs. [Table 235](#) lists the status code ranges described above.

Table 235. EFI\_STATUS Code Ranges

Supported 32-bit Range	Supported 64-bit Architecture Ranges	Description
0x00000000-0x1fffffff	0x0000000000000000-0x1fffffffffffffff	Warning codes reserved for use by UEFI main specification.
0x20000000-0x3fffffff	0x2000000000000000-0x3fffffffffffffff	Warning codes reserved for use by the Platform Initialization Architecture Specification.
0x40000000-0x7fffffff	0x4000000000000000-0x7fffffffffffffff	Warning codes reserved for OEM usage.
0x80000000-0x9fffffff	0x8000000000000000-0x9fffffffffffffff	Error codes reserved for use by UEFI main spec.
0xa0000000-0xbfffffff	0xa000000000000000-0xbfffffffffffffff	Error codes reserved for use by the Platform Initialization Architecture Specification.
0xc0000000-0xffffffff	0xc000000000000000-0xfffffffffffffff	Error codes reserved for OEM usage.

Table 236. EFI\_STATUS Success Codes (High Bit Clear)

Mnemonic	Value	Description
EFI_SUCCESS	0	The operation completed successfully.

Table 237. EFI\_STATUS Error Codes (High Bit Set)

Mnemonic	Value	Description
EFI_LOAD_ERROR	1	The image failed to load.
EFI_INVALID_PARAMETER	2	A parameter was incorrect.
EFI_UNSUPPORTED	3	The operation is not supported.
EFI_BAD_BUFFER_SIZE	4	The buffer was not the proper size for the request.
EFI_BUFFER_TOO_SMALL	5	The buffer is not large enough to hold the requested data. The required buffer size is returned in the appropriate parameter when this error occurs.
EFI_NOT_READY	6	There is no data pending upon return.
EFI_DEVICE_ERROR	7	The physical device reported an error while attempting the operation.
EFI_WRITE_PROTECTED	8	The device cannot be written to.
EFI_OUT_OF_RESOURCES	9	A resource has run out.
EFI_VOLUME_CORRUPTED	10	An inconsistency was detected on the file system causing the operating to fail.
EFI_VOLUME_FULL	11	There is no more space on the file system.
EFI_NO_MEDIA	12	The device does not contain any medium to perform the operation.



<b>Mnemonic</b>	<b>Value</b>	<b>Description</b>
EFI_MEDIA_CHANGED	13	The medium in the device has changed since the last access.
EFI_NOT_FOUND	14	The item was not found.
EFI_ACCESS_DENIED	15	Access was denied.
EFI_NO_RESPONSE	16	The server was not found or did not respond to the request.
EFI_NO_MAPPING	17	A mapping to a device does not exist.
EFI_TIMEOUT	18	The timeout time expired.
EFI_NOT_STARTED	19	The protocol has not been started.
EFI_ALREADY_STARTED	20	The protocol has already been started.
EFI_ABORTED	21	The operation was aborted.
EFI_ICMP_ERROR	22	An ICMP error occurred during the network operation.
EFI_TFTP_ERROR	23	A TFTP error occurred during the network operation.
EFI_PROTOCOL_ERROR	24	A protocol error occurred during the network operation.
EFI_INCOMPATIBLE_VERSION	25	The function encountered an internal version that was incompatible with a version requested by the caller.
EFI_SECURITY_VIOLATION	26	The function was not performed due to a security violation.
EFI_CRC_ERROR	27	A CRC error was detected.
EFI_END_OF_MEDIA	28	Beginning or end of media was reached
EFI_END_OF_FILE	31	The end of the file was reached.
EFI_INVALID_LANGUAGE	32	The language specified was invalid.
EFI_COMPROMISED_DATA	33	The security status of the data is unknown or compromised and the data must be updated or replaced to restore a valid security status.
EFI_IP_ADDRESS_CONFLICT	34	There is an address conflict address allocation
EFI_HTTP_ERROR	35	A HTTP error occurred during the network operation.

**Table 238. EFI\_STATUS Warning Codes (High Bit Clear)**

Mnemonic	Value	Description
EFI_WARN_UNKNOWN_GLYPH	1	The string contained one or more characters that the device could not render and were skipped.
EFI_WARN_DELETE_FAILURE	2	The handle was closed, but the file was not deleted.
EFI_WARN_WRITE_FAILURE	3	The handle was closed, but the data to the file was not flushed properly.
EFI_WARN_BUFFER_TOO_SMALL	4	The resulting buffer was too small, and the data was truncated to the buffer size.
EFI_WARN_STALE_DATA	5	The data has not been updated within the timeframe set by local policy for this type of data.
EFI_WARN_FILE_SYSTEM	6	The resulting buffer contains UEFI-compliant file system.
EFI_WARN_RESET_REQUIRED	7	The operation will be processed across a system reset.

# Appendix E Universal Network Driver Interfaces

---

## E.1 Introduction

This appendix defines the 32/64-bit H/W and S/W Universal Network Driver Interfaces (UNDIs). These interfaces provide one method for writing a network driver; other implementations are possible.

## E.1.1 Definitions

Table 239. Definitions

Term	Definition
BC	<p>BaseCode</p> <p>The PXE BaseCode, included as a core protocol in EFI, is comprised of a simple network stack (UDP/IP) and a few common network protocols (DHCP, Bootserver Discovery, TFTP) that are useful for remote booting machines.</p>
LOM	<p>LAN On Motherboard</p> <p>This is a network device that is built onto the motherboard (or baseboard) of the machine.</p>
NBP	<p>Network Bootstrap Program</p> <p>This is the first program that is downloaded into a machine that has selected a PXE capable device for remote boot services.</p> <p>A typical NBP examines the machine it is running on to try to determine if the machine is capable of running the next layer (OS or application). If the machine is not capable of running the next layer, control is returned to the EFI boot manager and the next boot device is selected. If the machine is capable, the next layer is downloaded and control can then be passed to the downloaded program.</p> <p>Though most NBPs are OS loaders, NBPs can be written to be standalone applications such as diagnostics, backup/restore, remote management agents, browsers, etc.</p>
NIC	<p>Network Interface Card</p> <p>Technically, this is a network device that is inserted into a bus on the motherboard or in an expansion board. For the purposes of this document, the term NIC will be used in a generic sense, meaning any device that enables a network connection (including LOMs and network devices on external busses (USB, 1394, etc.)).</p>
ROM	<p>Read-Only Memory</p> <p>When used in this specification, ROM refers to a nonvolatile memory storage device on a NIC.</p>
PXE	<p>Preboot Execution Environment</p> <p>The complete PXE specification covers three areas: the client, the network and the server.</p> <p>Client</p> <ul style="list-style-type: none"> <li>• Makes network devices into bootable devices.</li> <li>• Provides APIs for PXE protocol modules in EFI and for universal drivers in the OS.</li> </ul> <p><b>Network</b></p> <ul style="list-style-type: none"> <li>• Uses existing technology: DHCP, TFTP, etc.</li> <li>• Adds “vendor specific” tags to DHCP to define PXE specific operation within DHCP.</li> <li>• Adds multicast TFTP for high bandwidth remote boot applications.</li> <li>• Defines Bootserver discovery based on DHCP packet format.</li> <li>•</li> </ul> <p>Server</p> <ul style="list-style-type: none"> <li>• <b>Bootserver:</b> Responds to Bootserver discovery requests and serves up remote boot images.</li> <li>• <b>proxyDHCP:</b> Used to ease the transition of PXE clients and servers into existing network infrastructure. proxyDHCP provides the additional DHCP information that is needed by PXE clients and Bootservers without making changes to existing DHCP servers.</li> <li>• <b>MTFTP:</b> Adds multicast support to a TFTP server.</li> <li>• <b>Plug-In Modules:</b> Example proxyDHCP and Bootservers provided in the PXE SDK (software development kit) have the ability to take plug-in modules (PIMs). These PIMs are used to change/enhance the capabilities of the proxyDHCP and Bootservers.</li> </ul>

Term	Definition
UNDI	Universal Network Device Interface UNDI is an architectural interface to NICs. Traditionally NICs have had custom interfaces and custom drivers (each NIC had a driver for each OS on each platform architecture). Two variations of UNDI are defined in this specification: H/W UNDI and S/W UNDI. H/W UNDI is an architectural hardware interface to a NIC. S/W UNDI is a software implementation of the H/W UNDI.

### E.1.2 Referenced Specifications

When implementing PXE services, protocols, ROMs or drivers, it is a good idea to understand the related network protocols and BIOS specifications. [Table 240](#) below includes all of the specifications referenced in this document.

Table 240. Referenced Specifications

Acronym	Protocol/Specification
ARP	<b>Address Resolution Protocol</b> – Required reading for those implementing the PXE Base Code Protocol. See “Links to UEFI-Related Documents” ( <a href="http://uefi.org/uefi">http://uefi.org/uefi</a> ) under the heading “Address Resolution Protocol”.
Assigned Numbers	Lists the reserved numbers used in the RFCs and in this specification. See “Links to UEFI-Related Documents” ( <a href="http://uefi.org/uefi">http://uefi.org/uefi</a> ) under the heading “Assigned Numbers”.
BIOS	<b>Basic Input/Output System</b> – Contact your BIOS manufacturer for reference and programming manuals.
BOOTP	<p><b>Bootstrap Protocol</b> –</p> <ul style="list-style-type: none"> <li>• See “Links to UEFI-Related Documents” (<a href="http://uefi.org/uefi">http://uefi.org/uefi</a>) under the heading “Bootstrap Protocol (BOOTP)”.</li> </ul> <p>These references are included for backward compatibility. BC protocol supports DHCP and BOOTP:</p> <ul style="list-style-type: none"> <li>• See “Links to UEFI-Related Documents” (<a href="http://uefi.org/uefi">http://uefi.org/uefi</a>) under the heading “BOOTP Clarifications and Extensions”.</li> <li>• See “Links to UEFI-Related Documents” (<a href="http://uefi.org/uefi">http://uefi.org/uefi</a>) under the heading “Bootstrap Protocol (BOOTP) Interoperation Between DHCP and BOOTP”.</li> </ul> <p>Required reading for those implementing the PXE Base Code Protocol BC protocol or PXE Bootservers.</p>
DHCP	<p><b>Dynamic Host Configuration Protocol</b></p> <ul style="list-style-type: none"> <li>• See “Links to UEFI-Related Documents” (<a href="http://uefi.org/uefi">http://uefi.org/uefi</a>) under the heading “DHCP”.</li> <li>• See “Links to UEFI-Related Documents” (<a href="http://uefi.org/uefi">http://uefi.org/uefi</a>) under the heading “Index of RFC (IETF)”.</li> <li>• See “Links to UEFI-Related Documents” (<a href="http://uefi.org/uefi">http://uefi.org/uefi</a>) under the heading “DHCP Reconfigure Extension”.</li> <li>• See “Links to UEFI-Related Documents” (<a href="http://uefi.org/uefi">http://uefi.org/uefi</a>) under the heading “DHCP for Ipv4”.</li> <li>• See “Links to UEFI-Related Documents” (<a href="http://uefi.org/uefi">http://uefi.org/uefi</a>) under the heading “Interoperations between DHCP and BOOTP”.</li> </ul> <p>Required reading for those implementing the PXE Base Code Protocol or PXE Bootservers.</p>
EFI	<p><b>Extensible Firmware Interface</b></p> <ul style="list-style-type: none"> <li>• See “Links to UEFI-Related Documents” (<a href="http://uefi.org/uefi">http://uefi.org/uefi</a>) under the heading “Intel Developer Centers”.</li> </ul> <p>Required reading for those implementing NBPs, OS loaders and preboot applications for machines with the EFI preboot environment.</p>
ICMP	<p><b>Internet Control Message Protocol</b></p> <ul style="list-style-type: none"> <li>• See “Links to UEFI-Related Documents” (<a href="http://uefi.org/uefi">http://uefi.org/uefi</a>) under the heading “ICMP for Ipv4”.</li> <li>• See “Links to UEFI-Related Documents” (<a href="http://uefi.org/uefi">http://uefi.org/uefi</a>) under the heading “ICMP for Ipv6”.</li> </ul> <p>Required reading for those implementing the BC protocol.</p>
IETF	<p><b>Internet Engineering Task Force</b></p> <ul style="list-style-type: none"> <li>• See “Links to UEFI-Related Documents” (<a href="http://uefi.org/uefi">http://uefi.org/uefi</a>) under the heading “Internet Engineering Task Force (IETF)”.</li> </ul> <p>This is a good starting point for obtaining electronic copies of Internet standards, drafts, and RFCs.</p>

Acronym	Protocol/Specification
IGMP	<p><b>Internet Group Management Protocol</b></p> <ul style="list-style-type: none"> <li>• See “Links to UEFI-Related Documents” (<a href="http://uefi.org/uefi">http://uefi.org/uefi</a>) under the heading “Internet Group Management Protocol”.</li> </ul> <p>Required reading for those implementing the PXE Base Code Protocol.</p>
IP	<p>Internet Protocol</p> <p>Ipv4: <a href="http://www.ietf.org/rfc/rfc0791.txt">http://www.ietf.org/rfc/rfc0791.txt</a></p> <ul style="list-style-type: none"> <li>• See “Links to UEFI-Related Documents” (<a href="http://uefi.org/uefi">http://uefi.org/uefi</a>) under the heading “Ipv4”.</li> <li>• See “Links to UEFI-Related Documents” (<a href="http://uefi.org/uefi">http://uefi.org/uefi</a>) under the heading “Ipv6”.</li> </ul> <p>Required reading for those implementing the BC protocol.</p>
MTFTP	<p><b>Multicast TFTP</b> – Defined in the 16-bit PXE specification.</p> <p>Required reading for those implementing the PXE Base Code Protocol.</p>
PCI	<p><b>Peripheral Component Interface</b></p> <ul style="list-style-type: none"> <li>• See “Links to UEFI-Related Documents” (<a href="http://uefi.org/uefi">http://uefi.org/uefi</a>) under the heading “Peripheral Component Interface (PCI)”.</li> </ul> <p>Source for PCI specifications. Required reading for those implementing S/W or H/W UNDI on a PCI NIC or LOM.</p>
PnP	<p><b>Plug-and-Play</b> – <a href="http://www.phoenix.com/en/support/white+papers-specs/">http://www.phoenix.com/en/support/white+papers-specs/</a></p> <ul style="list-style-type: none"> <li>• See “Links to UEFI-Related Documents” (<a href="http://uefi.org/uefi">http://uefi.org/uefi</a>) under the heading “Plug and Play”.</li> </ul> <p>Source for PnP specifications.</p>
PXE	<p><b>Preboot eXecution Environment</b></p> <p>16-bit PXE v2.1:</p> <ul style="list-style-type: none"> <li>• See “Links to UEFI-Related Documents” (<a href="http://uefi.org/uefi">http://uefi.org/uefi</a>) under the heading “Preboot eXecution Environment (PXE)”.</li> </ul> <p>Required reading.</p>
RFC	<p><b>Request For Comments</b> –</p> <ul style="list-style-type: none"> <li>• See “Links to UEFI-Related Documents” (<a href="http://uefi.org/uefi">http://uefi.org/uefi</a>) under the heading “Request for Comments”.</li> </ul>
TCP	<p><b>Transmission Control Protocol</b></p> <ul style="list-style-type: none"> <li>• See “Links to UEFI-Related Documents” (<a href="http://uefi.org/uefi">http://uefi.org/uefi</a>) under the heading “TCPv4”.</li> <li>• See “Links to UEFI-Related Documents” (<a href="http://uefi.org/uefi">http://uefi.org/uefi</a>) under the heading “TCPv6”.</li> </ul> <p>Required reading for those implementing the PXE Base Code Protocol .</p>
TFTP	<p><b>Trivial File Transfer Protocol</b></p> <p>TFTP</p> <ul style="list-style-type: none"> <li>• See “Links to UEFI-Related Documents” (<a href="http://uefi.org/uefi">http://uefi.org/uefi</a>) under the heading “TFTP Protocol”.</li> <li>• See “Links to UEFI-Related Documents” (<a href="http://uefi.org/uefi">http://uefi.org/uefi</a>) under the heading “TFTP Option Extension”.</li> <li>• See “Links to UEFI-Related Documents” (<a href="http://uefi.org/uefi">http://uefi.org/uefi</a>) under the heading “TFTP Blocksize Option”.</li> <li>• See “Links to UEFI-Related Documents” (<a href="http://uefi.org/uefi">http://uefi.org/uefi</a>) under the heading “TFTP Timeout Interval and Transfer Size Options”.</li> </ul> <p>Required reading for those implementing the PXE Base Code Protocol.</p>

Acronym	Protocol/Specification
UDP	<p><b>User Datagram Protocol</b></p> <ul style="list-style-type: none"> <li>• See “Links to UEFI-Related Documents” (<a href="http://uefi.org/uefi">http://uefi.org/uefi</a>) under the heading “UDP over IPv4”.</li> <li>• See “Links to UEFI-Related Documents” (<a href="http://uefi.org/uefi">http://uefi.org/uefi</a>) under the heading “UDP over IPv6”.</li> </ul> <p>Required reading for those implementing the PXE Base Code Protocol.</p>
WfM	<p><b>Wired for Management</b></p> <ul style="list-style-type: none"> <li>• See “Links to UEFI-Related Documents” (<a href="http://uefi.org/uefi">http://uefi.org/uefi</a>) under the heading “Wired for Management”.</li> </ul> <p>Recommended reading for those implementing the PXE Base Code Protocol or PXE Bootservers.</p>

### E.1.3 OS Network Stacks

This is a simplified overview of three OS network stacks that contain three types of network drivers: Custom, S/W UNDI and H/W UNDI. [Figure 144](#) depicts an application bound to an OS protocol stack, which is in turn bound to a protocol driver that is bound to three NICs. [Table 241](#) below gives a brief list of pros and cons about each type of driver implementation.

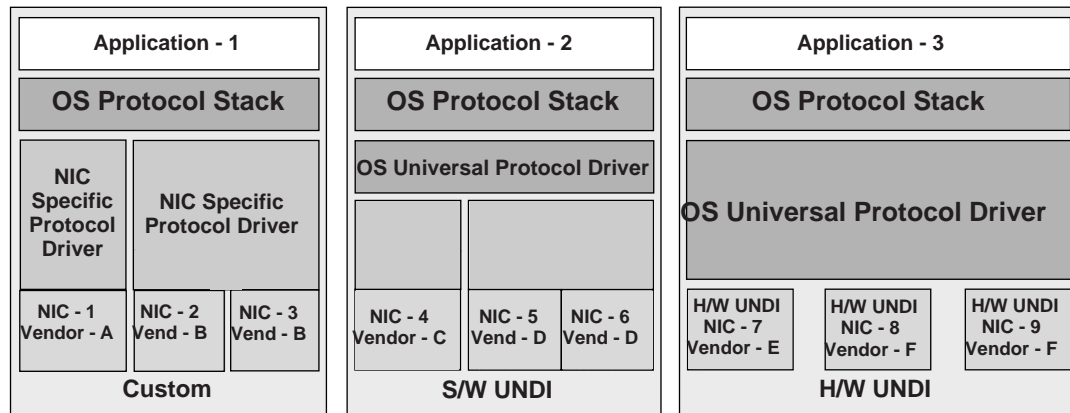

OM13182

Figure 144. Network Stacks with Three Classes of Drivers



**Table 241. Driver Types: Pros and Cons**

Driver	Pro	Con
Custom	<ul style="list-style-type: none"> <li>• Can be very fast and efficient. NIC vendor tunes driver to OS &amp; device.</li> <li>• OS vendor does not have to write NIC driver.</li> </ul>	<ul style="list-style-type: none"> <li>• New driver for each OS/architecture must be maintained by NIC vendor.</li> <li>• OS vendor must trust code supplied by third-party.</li> <li>• OS vendor cannot test all possible driver/NIC versions.</li> <li>• Driver must be installed before NIC can be used.</li> <li>• Possible performance sink if driver is poorly written.</li> <li>• Possible security risk if driver has back door.</li> </ul>
S/W UNDI	<ul style="list-style-type: none"> <li>• S/W UNDI driver is simpler than a Custom driver. Easier to test outside of the OS environment.</li> <li>• OS vendor can tune the universal protocol driver for best OS performance.</li> <li>• NIC vendor only has to write one driver per processor architecture.</li> </ul>	<ul style="list-style-type: none"> <li>• Slightly slower than Custom or H/W UNDI because of extra call layer between protocol stack and NIC.</li> <li>• S/W UNDI driver must be loaded before NIC can be used.</li> <li>• OS vendor has to write the universal driver.</li> <li>• Possible performance sink if driver is poorly written.</li> <li>• Possible security risk if driver has back door.</li> </ul>
H/W UNDI	<ul style="list-style-type: none"> <li>• H/W UNDI provides a common architectural interface to all network devices.</li> <li>• OS vendor controls all security and performance issues in network stack.</li> <li>• NIC vendor does not have to write any drivers.</li> <li>• NIC can be used without an OS or driver installed (preboot management).</li> </ul>	<ul style="list-style-type: none"> <li>• OS vendor has to write the universal driver (this might also be a Pro, depending on your point of view).</li> </ul>

## E.2 Overview

There are three major design changes between this specification and the 16-bit UNDI in version 2.1 of the PXE Specification:

- A new architectural hardware interface has been added.
- All UNDI commands use the same command format.
- BC is no longer part of the UNDI ROM.

### E.2.1 32/64-bit UNDI Interface

The !PXE structures are used locate and identify the type of 32/64-bit UNDI interface (H/W or S/W), as shown in [Figure 145](#). These structures are normally only used by the system BIOS and universal network drivers.

Major Minor reserved

!PXE H/W UNDI					!PXE S/W UNDI				
Offset	0x00	0x01	0x02	0x03	Offset	0x00	0x01	0x02	0x03
0x00	Signature				0x00	Signature			
0x04	Len	Fudge	Rev	IFcnt	0x04	Len	Fudge	Rev	IFcnt
0x08	Major	Minor	IFcntExt	Reserved	0x08	Major	Minor	IFcntExt	Reserved
0x0C	Implementation				0x0C	Implementation			
0x10	reserved				0x10	Entry Point			
Len	Status								
Len + 0x04	Command				0x14				
Len + 0x08	CDBaddr				0x18	reserved			#bus
Len + 0x0C					0x1C	BusTypes(s)			
					0x20	More BusTypes(s)			

OM13183

Figure 145. !PXE Structures for H/W and S/W UNDI

The !PXE structures used for H/W and S/W UNDI are similar but not identical. The difference in the format is tied directly to the differences required by the implementation. The !PXE structures for 32/64-bit UNDI are not compatible with the !PXE structure for 16-bit UNDI.

The !PXE structure for H/W UNDI is built into the NIC hardware. The first nine fields (from offsets 0x00 to 0x0F) are implemented as read-only memory (or ports). The last three fields (from Len to Len + 0x0F) are implemented as read/write memory (or ports). The optional reserved field at 0x10 is not defined in this specification and may be used for vendor data.

The !PXE structure for S/W UNDI can be loaded into system memory from one of three places; ROM on a NIC, system nonvolatile storage, or external storage. Since there are no direct memory or I/O ports available in the S/W UNDI !PXE structure, an indirect callable entry point is provided. S/W UNDI developers are free to make their internal designs as simple or complex as they desire, as long as all of the UNDI commands in this specification are implemented.

Descriptions of the fields in the !PXE structures is given in [Table 242](#).

**Table 242. !PXE Structure Field Definitions**

Identifier	Value	Description
Signature	"!PXE"	!PXE structure signature. This field is used to locate an UNDI hardware or software interface in system memory (or I/O) space. '!' is in the first (lowest address) byte, 'P' is in the second byte, 'X' in the third and 'E' in the last. This field must be aligned on a 16-byte boundary (the last address byte must be zero).
Len	Varies	Number of !PXE structure bytes to checksum. When computing the checksum of this structure the Len field MUST be used as the number of bytes to checksum. The !PXE structure checksum is computed by adding all of the bytes in the structure, starting with the first byte of the structure Signature: '!'. If the 8-bit sum of all of the unsigned bytes in this structure is not zero, this is not a valid !PXE structure.
Fudge	Varies	This field is used to make the 8-bit checksum of this structure equal zero.
Rev	0x03	Revision of this structure.
IFcnt	Varies	This field reports the number (minus one) of physical external network connections that are controlled by this !PXE interface. (If there is one network connector, this field is zero. If there are two network connectors, this field is one.) For !PXE structure revision 0x03 or higher, in addition to this field, the value in IFcntExt field must be left-shifted by 8-bits and ORed with IFcnt to get the 16-bit value for the total number (minus one) of physical external network connections that are controlled by this !PXE interface.
Major	Varies	UNDI command interface. Minor revision number. <b>0x00 (Alpha):</b> This version of UNDI does not operate as a runtime driver. The callback interface defined in the UNDI Start command is required. <b>0x10 (Beta):</b> This version of UNDI can operate as an OS runtime driver. The callback interface defined in the UNDI Start command is required
Minor	Varies	UNDI command interface. Minor revision number. <b>0x00 (Alpha):</b> This version of UNDI does not operate as a runtime driver. The callback interface defined in the UNDI Start command is required. <b>0x10 (Beta):</b> This version of UNDI can operate as an OS runtime driver. The callback interface defined in the UNDI Start command is required.
IFcntExt	Varies	If the !PXE structure revision 0x02 or earlier, this field is reserved and must be set to zero. If the !PXE structure revision 0x03 or higher, this field reports the upper 8-bits of the number of physical external network connections that is controlled by this !PXE interface.
reserved	0x00	This field is reserved and must be set to zero.
Implementation	Varies	Identifies type of UNDI

## Unified Extensible Firmware Interface Specification

Identifier	Value	Description
		<p>(S/W or H/W, 32 bit or 64 bit) and what features have been implemented. The implementation bits are defined below. Undefined bits must be set to zero by UNDI implementers. Applications/drivers must not rely on the contents of undefined bits (they may change later revisions).</p> <p>Bit 0x00: Command completion interrupts supported (1) or not supported (0)</p> <p>Bit 0x01: Packet received interrupts supported (1) or not supported (0)</p> <p>Bit 0x02: Transmit complete interrupts supported (1) or not supported (0)</p> <p>Bit 0x03: Software interrupt supported (1) or not supported (0)</p> <p>Bit 0x04: Filtered multicast receives supported (1) or not supported (0)</p> <p>Bit 0x05: Broadcast receives supported (1) or not supported (0)</p> <p>Bit 0x06: Promiscuous receives supported (1) or not supported (0)</p> <p>Bit 0x07: Promiscuous multicast receives supported (1) or not supported (0)</p> <p>Bit 0x08: Station MAC address settable (1) or not settable (0)</p> <p>Bit 0x09: Statistics supported (1) or not supported (0)</p> <p>Bit 0x0A,0x0B: NvData not available (0), read only (1), sparse write supported (2), bulk write supported (3)</p> <p>Bit 0x0C: Multiple frames per command supported (1) or not supported (0)</p> <p>Bit 0x0D: Command queuing supported (1) or not supported (0)</p> <p>Bit 0x0E: Command linking supported (1) or not supported (0)</p> <p>Bit 0x0F: Packet fragmenting supported (1) or not supported (0)</p> <p>Bit 0x10: Device can address 64 bits (1) or only 32 bits (0)</p> <p>Bit 0x1E: S/W UNDI: Entry point is virtual address (1) or unsigned offset from start of !PXE structure (0).</p> <p>Bit 0x1F: Interface type: H/W UNDI (1) or S/W UNDI (0)</p>
<b>H/W UNDI Fields</b>		
Reserved	Varies	<p>This field is optional and may be used for OEM &amp; vendor unique data. If this field is present its length must be a multiple of 16 bytes and must be included in the !PXE structure checksum. This field, if present, will always start on a 16-byte boundary.</p> <p><b>Note:</b> The size/contents of the !PXE structure may change in future revisions of this specification. Do not rely on OEM &amp; vendor data starting at the same offset from the beginning of the !PXE structure. It is recommended that the OEM &amp; vendor data include a signature that drivers/applications can search for.</p>

Identifier	Value	Description
Status	Varies	<p>UNDI operation, command and interrupt status flags.</p> <p>This is a read-only port. Undefined status bits must be set to zero. Reading this port does NOT clear the status.</p> <p>Bit 0x00: Command completion interrupt pending (1) or not pending (0)            Bit 0x01: Packet received interrupt pending (1) or not pending (0)            Bit 0x02: Transmit complete interrupt pending (1) or not pending (0)            Bit 0x03: Software interrupt pending (1) or not pending (0)            Bit 0x04: Command completion interrupts enabled (1) or disabled (0)            Bit 0x05: Packet receive interrupts enabled (1) or disabled (0)            Bit 0x06: Transmit complete interrupts enabled (1) or disabled (0)            Bit 0x07: Software interrupts enabled (1) or disabled (0)            Bit 0x08: Unicast receive enabled (1) or disabled (0)            Bit 0x09: Filtered multicast receive enabled (1) or disabled (0)            Bit 0x0A: Broadcast receive enabled (1) or disabled (0)            Bit 0x0B: Promiscuous receive enabled (1) or disabled (0)            Bit 0x0C: Promiscuous multicast receive enabled (1) or disabled (0)            Bit 0x1D: Command failed (1) or command succeeded (0)            Bits 0x1F:0x1E: UNDI state: Stopped (0), Started (1), Initialized (2), Busy (3)</p>
Command	Varies	<p>Use to execute commands, clear interrupt status and enable/disable receive levels. This is a read/write port. Read reflects the last write.</p> <p>Bit 0x00: Clear command completion interrupt (1) or NOP (0)            Bit 0x01: Clear packet received interrupt (1) or NOP (0)            Bit 0x02: Clear transmit complete interrupt (1) or NOP (0)            Bit 0x03: Clear software interrupt (1) or NOP (0)            Bit 0x04: Command completion interrupt enable (1) or disable (0)            Bit 0x05: Packet receive interrupt enable (1) or disable (0)            Bit 0x06: Transmit complete interrupt enable (1) or disable (0)            Bit 0x07: Software interrupt enable (1) or disable (0). Setting this bit to (1) also generates a software interrupt.            Bit 0x08: Unicast receive enable (1) or disable (0)            Bit 0x09: Filtered multicast receive enable (1) or disable (0)            Bit 0x0A: Broadcast receive enable (1) or disable (0)            Bit 0x0B: Promiscuous receive enable (1) or disable (0)            Bit 0x0C: Promiscuous multicast receive enable (1) or disable (0)            Bit 0x1F: Operation type: Clear interrupt and/or filter (0), Issue command (1)</p>
CDBaddr	Varies	<p>Write the physical address of a CDB to this port. (Done with one 64-bit or two 32-bit writes, depending on processor architecture.) When done, use one 32-bit write to the command port to send this address into the command queue. Unused upper address bits must be set to zero.</p>
<b>S/W UNDI Fields</b>		
EntryPoint	Varies	<p>S/W UNDI API entry point address. This is either a virtual address or an offset from the start of the !PXE structure. Protocol drivers will push the 64-bit virtual address of a CDB on the stack and then call the UNDI API entry point. When control is returned to the protocol driver, the protocol driver must remove the address of the CDB from the stack.</p>
reserved	Zero	Reserved for future use.
BusTypeCnt	Varies	This field is the count of 4-byte BusType entries in the next field.

Identifier	Value	Description
BusType	Varies	This field defines the type of bus S/W UNDI is written to support: "PCIR," "PCCR," "USB" or "1394." This field is formatted like the Signature field. If the S/W UNDI supports more than one BusType there will be more than one BusType identifier in this field.

### E.2.1.1 Issuing UNDI Commands

How commands are written and status is checked varies a little depending on the type of UNDI (H/W or S/W) implementation being used. The command flowchart shown in [Figure 146](#) is a high-level diagram on how commands are written to both H/W and S/W UNDI.

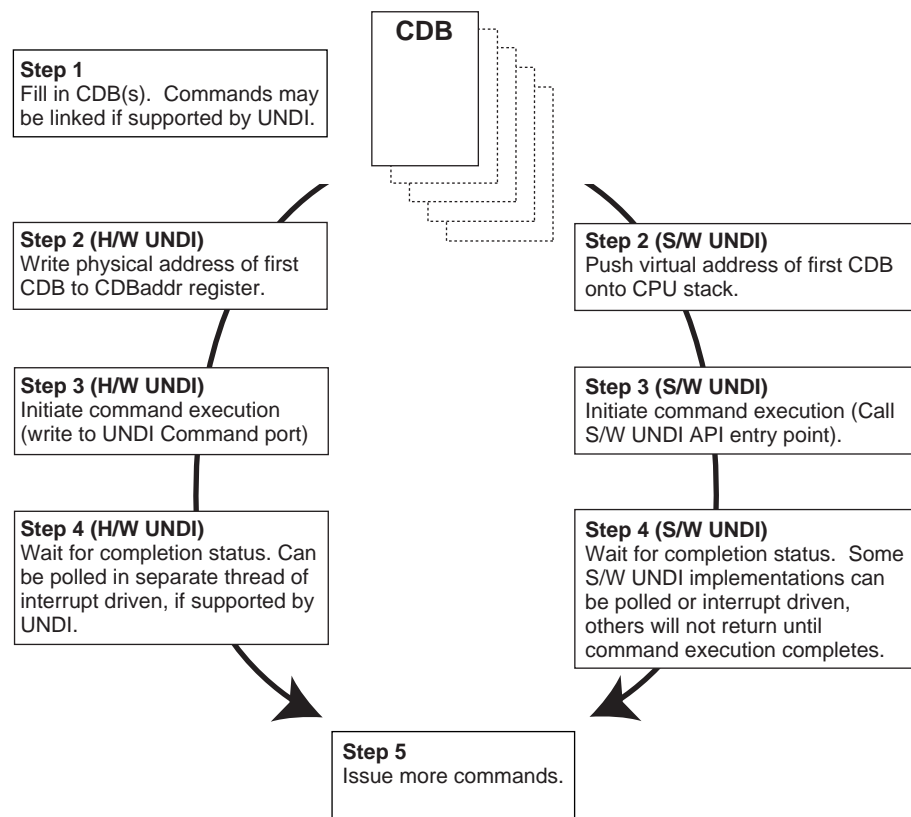

OM13184

Figure 146. Issuing UNDI Commands

### E.2.2 UNDI Command Format

The format of the CDB is the same for all UNDI commands. [Figure 147](#) shows the structure of the CDB. Some of the commands do not use or always require the use of all of the fields in the CDB. When fields are not used they must be initialized to zero or the UNDI will return an error. The StatCode and StatFlags fields must always be initialized to

zero or the UNDI will return an error. All reserved fields (and bit fields) must be initialized to zero or the UNDI will return an error.

Basically, the rule is: Do it right, or don't do it at all.

---

<b>CDB</b> Command Descriptor Block				
Offset	0x00	0x01	0x02	0x03
0x00	<b>OpCode</b>		<b>OpFlags</b>	
0x04	<b>CPBsize</b>		<b>DBsize</b>	
0x08	<b>CPBaddr</b>			
0x0C				
0x10	<b>DBaddr</b>			
0x14				
0x18	<b>StatCode</b>		<b>StatFlags</b>	
0x1C	<b>IFnum</b>		<b>Control</b>	

OM13185

---

**Figure 147. UNDI Command Descriptor Block (CDB)**

Descriptions of the CDB fields are given in [Table 243](#).

Table 243. UNDI CDB Field Definitions

Identifier	Description
OpCode	<b>Operation Code</b> (Function Number, Command Code, etc.) This field is used to identify the command being sent to the UNDI. The meanings of some of the bits in the OpFlags and StatFlags fields, and the format of the CPB and DB structures depends on the value in the OpCode field. Commands sent with an OpCode value that is not defined in this specification will not be executed and will return a StatCode of <b>PXE_STATCODE_INVALID_CDB</b> .
OpFlags	<b>Operation Flags</b> This bit field is used to enable/disable different features in a specific command operation. It is also used to change the format/contents of the CPB and DB structures. Commands sent with reserved bits set in the OpFlags field will not be executed and will return a StatCode of <b>PXE_STATCODE_INVALID_CDB</b> .
CPBsize	<b>Command Parameter Block Size</b> This field should be set to a number that is equal to the number of bytes that will be read from CPB structure during command execution. Setting this field to a number that is too small will cause the command to not be executed and a StatCode of <b>PXE_STATCODE_INVALID_CDB</b> will be returned. The contents of the CPB structure will not be modified.
DBsize	<b>Data Block Size</b> This field should be set to a number that is equal to the number of bytes that will be written into the DB structure during command execution. Setting this field to a number that is smaller than required will cause an error. It may be zero in some cases where the information is not needed.
CPBaddr	<b>Command Parameter Block Address</b> For H/W UNDI, this field must be the physical address of the CPB structure. For S/W UNDI, this field must be the virtual address of the CPB structure. If the operation does not have/use a CPB, this field must be initialized to <b>PXE_CPBADDR_NOT_USED</b> . Setting up this field incorrectly will cause command execution to fail and a StatCode of <b>PXE_STATCODE_INVALID_CDB</b> will be returned.
DBaddr	<b>Data Block Address</b> For H/W UNDI, this field must be the physical address of the DB structure. For S/W UNDI, this field must be the virtual address of the DB structure. If the operation does not have/use a CPB, this field must be initialized to <b>PXE_DBADDR_NOT_USED</b> . Setting up this field incorrectly will cause command execution to fail and a StatCode of <b>PXE_STATCODE_INVALID_CDB</b> will be returned.
StatCode	<b>Status Code</b> This field is used to report the type of command completion: success or failure (and the type of failure). This field must be initialized to zero before the command is issued. The contents of this field is not valid until the <b>PXE_STATFLAGS_COMMAND_COMPLETE</b> status flag is set. If this field is not initialized to <b>PXE_STATCODE_INITIALIZE</b> the UNDI command will not execute and a StatCode of <b>PXE_STATCODE_INVALID_CDB</b> will be returned.



Identifier	Description
StatFlags	<p>Status Flags</p> <p>This bit field is used to report command completion and identify the format, if any, of the DB structure. This field must be initialized to zero before the command is issued. Until the command state changes to error or complete, all other CDB fields must not be changed. If this field is not initialized to <b>PXE_STATFLAGS_INITIALIZE</b> the UNDI command will not execute and a StatCode of <b>PXE_STATCODE_INVALID_CDB</b> will be returned.</p> <p>Bits 0x0F &amp; 0x0E: Command state: Not started (0), Queued (1), Error (2), Complete (3).</p>
IfNum	<p>Interface Number</p> <p>This field is used to identify which network adapter (S/W UNDI) or network connector (H/W UNDI) this command is being sent to. If an invalid interface number is given, the command will not execute and a StatCode of <b>PXE_STATCODE_INVALID_CDB</b> will be returned.</p>
Control	<p>Process Control</p> <p>This bit field is used to control command UNDI inter-command processing. Setting control bits that are not supported by the UNDI will cause the command execution to fail with a StatCode of <b>PXE_STATCODE_INVALID_CDB</b>.</p> <p>Bit 0x00: Another CDB follows this one (1) or this is the last or only CDB in the list (0).</p> <p>Bit 0x01: Queue command if busy (1), fail if busy (0).</p>

## E.3 UNDI C Definitions

The definitions in this section are used to aid in the portability and readability of the example 32/64-bit S/W UNDI source code and the rest of this specification.

### E.3.1 Portability Macros

These macros are used for storage and communication portability.

#### E.3.1.1 PXE\_INTEL\_ORDER or PXE\_NETWORK\_ORDER

This macro is used to control conditional compilation in the S/W UNDI source code. One of these definitions needs to be uncommented in a common PXE header file.

```

//#define PXE_INTEL_ORDER 1 // little-endian
//#define PXE_NETWORK_ORDER 1 // big-endian

```

#### E.3.1.2 PXE\_UINT64\_SUPPORT or PXE\_NO\_UINT64\_SUPPORT

This macro is used to control conditional compilation in the PXE source code. One of these definitions must be uncommented in the common PXE header file.

```

//#define PXE_UINT64_SUPPORT 1 // UINT64 supported
//#define PXE_NO_UINT64_SUPPORT 1 // UINT64 not supported

```

#### E.3.1.3 PXE\_BUSTYPE

Used to convert a 4-character ASCII identifier to a 32-bit unsigned integer.

```

#if PXE_INTEL_ORDER
#define PXE_BUSTYPE(a,b,c,d) \
(((PXE_UINT32)(d) & 0xFF) << 24) | \

```

```

(((PXE_UINT32)(c) & 0xFF) << 16) | \
(((PXE_UINT32)(b) & 0xFF) << 8) | \
((PXE_UINT32)(a) & 0xFF)
#else
#define PXE_BUSTYPE(a,b,c,d) \
((((PXE_UINT32)(a) & 0xFF) << 24) | \
(((PXE_UINT32)(b) & 0xFF) << 16) | \
(((PXE_UINT32)(c) & 0xFF) << 8) | \
((PXE_UINT32)(f) & 0xFF))
#endif

//*****
// UNDI ROM ID and device ID signature
//*****
#define PXE_BUSTYPE_PXE PXE_BUSTYPE('!', 'P', 'X', 'E')

//*****
// BUS ROM ID signatures
//*****
#define PXE_BUSTYPE_PCI PXE_BUSTYPE('P', 'C', 'I', 'R')
#define PXE_BUSTYPE_PC_CARD PXE_BUSTYPE('P', 'C', 'C', 'R')
#define PXE_BUSTYPE_USB PXE_BUSTYPE('U', 'S', 'B', 'R')
#define PXE_BUSTYPE_1394 PXE_BUSTYPE('1', '3', '9', '4')

```

#### E.3.1.4 PXE\_SWAP\_UINT16

This macro swaps bytes in a 16-bit word.

```

#ifndef PXE_INTEL_ORDER
#define PXE_SWAP_UINT16(n) \
((((PXE_UINT16)(n) & 0x00FF) << 8) | \
(((PXE_UINT16)(n) & 0xFF00) >> 8))
#else
#define PXE_SWAP_UINT16(n) (n)
#endif

```

#### E.3.1.5 PXE\_SWAP\_UINT32

This macro swaps bytes in a 32-bit word.

```

#ifndef PXE_INTEL_ORDER
#define PXE_SWAP_UINT32(n) \
((((PXE_UINT32)(n) & 0x000000FF) << 24) | \
(((PXE_UINT32)(n) & 0x0000FF00) << 8) | \
(((PXE_UINT32)(n) & 0x00FF0000) >> 8) | \
(((PXE_UINT32)(n) & 0xFF000000) >> 24))
#else
#define PXE_SWAP_UINT32(n) (n)
#endif

```

### E.3.1.6 PXE\_SWAP\_UINT64

This macro swaps bytes in a 64-bit word for compilers that support 64-bit words.

```
#if PXE_UINT64_SUPPORT != 0
#define PXE_SWAP_UINT64(n) \
(((PXE_UINT64)(n) & 0x00000000000000FF) << 56) | \
(((PXE_UINT64)(n) & 0x000000000000FF00) << 40) | \
(((PXE_UINT64)(n) & 0x0000000000FF0000) << 24) | \
(((PXE_UINT64)(n) & 0x00000000FF000000) << 8) | \
(((PXE_UINT64)(n) & 0x000000FF00000000) >> 8) | \
(((PXE_UINT64)(n) & 0x0000FF0000000000) >> 24) | \
(((PXE_UINT64)(n) & 0x00FF000000000000) >> 40) | \
(((PXE_UINT64)(n) & 0xFF00000000000000) >> 56)
#else
#define PXE_SWAP_UINT64(n) (n)
#endif
#endif // PXE_UINT64_SUPPORT
```

This macro swaps bytes in a 64-bit word, in place, for compilers that do not support 64-bit words. This version of the 64-bit swap macro cannot be used in expressions.

```
#if PXE_NO_UINT64_SUPPORT != 0
#define PXE_SWAP_UINT64(n) \
{ \
PXE_UINT32 tmp = (PXE_UINT64)(n)[1]; \
(PXE_UINT64)(n)[1] = PXE_SWAP_UINT32((PXE_UINT64)(n)[0]); \
(PXE_UINT64)(n)[0] = PXE_SWAP_UINT32(tmp); \
}
#else
#define PXE_SWAP_UINT64(n) (n)
#endif
#endif // PXE_NO_UINT64_SUPPORT
```

## E.3.2 Miscellaneous Macros

### E.3.2.1 Miscellaneous

```
#define PXE_CPBSIZE_NOT_USED 0 // zero
#define PXE_DBSIZE_NOT_USED 0 // zero
#define PXE_CPBADDR_NOT_USED (PXE_UINT64)0 // zero
#define PXE_DBADDR_NOT_USED (PXE_UINT64)0 // zero
```

### E.3.3 Portability Types

The examples given below are just that, examples. The actual typedef instructions used in a new implementation may vary depending on the compiler and processor architecture.

The storage sizes defined in this section are critical for PXE module inter-operation. All of the portability typedefs define little endian (Intel® format) storage. The least significant

byte is stored in the lowest memory address and the most significant byte is stored in the highest memory address, as shown in [Figure 148](#).

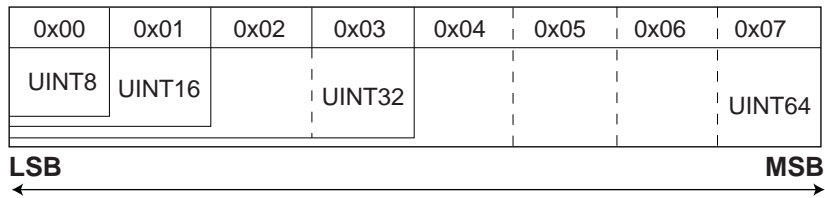

OM13186

Figure 148. Storage Types

### E.3.3.1 PXE\_CONST

The const type does not allocate storage. This type is a modifier that is used to help the compiler optimize parameters that do not change across function calls.

```
#define PXE_CONST const
```

### E.3.3.2 PXE\_VOLATILE

The volatile type does not allocate storage. This type is a modifier that is used to help the compiler deal with variables that can be changed by external procedures or hardware events.

```
#define PXE_VOLATILE volatile
```

### E.3.3.3 PXE\_VOID

The void type does not allocate storage. This type is used only to prototype functions that do not return any information and/or do not take any parameters.

```
typedef void PXE_VOID;
```

### E.3.3.4 PXE\_UINT8

Unsigned 8-bit integer.

```
typedef unsigned char PXE_UINT8;
```

### E.3.3.5 PXE\_UINT16

Unsigned 16-bit integer.

```
typedef unsigned short PXE_UINT16;
```

### E.3.3.6 PXE\_UINT32

Unsigned 32-bit integer.

```
typedef unsigned PXE_UINT32;
```

### E.3.3.7 PXE\_UINT64

Unsigned 64-bit integer.

```
#if PXE_UINT64_SUPPORT != 0
typedef unsigned long PXE_UINT64;
```

```
#endif // PXE_UINT64_SUPPORT
```

If a 64-bit integer type is not available in the compiler being used, use this definition:

```
#if PXE_NO_UINT64_SUPPORT != 0
typedef PXE_UINT32 PXE_UINT64[2];
#endif // PXE_NO_UINT64_SUPPORT
```

### E.3.3.8 PXE\_UINTN

Unsigned integer that is the default word size used by the compiler. This needs to be at least a 32-bit unsigned integer.

```
typedef unsigned PXE_UINTN;
```

## E.3.4 Simple Types

The PXE simple types are defined using one of the portability types from the previous section.

### E.3.4.1 PXE\_BOOL

Boolean (true/false) data type. For PXE zero is always false and nonzero is always true.

```
typedef PXE_UINT8 PXE_BOOL;
#define PXE_FALSE 0 // zero
#define PXE_TRUE (!PXE_FALSE)
```

### E.3.4.2 PXE\_OPCODE

UNDI OpCode (command) descriptions are given in the next chapter. There are no BC OpCodes, BC protocol functions are discussed later in this document.

```
typedef PXE_UINT16 PXE_OPCODE;

// Return UNDI operational state.
#define PXE_OPCODE_GET_STATE 0x0000

// Change UNDI operational state from Stopped to Started.
#define PXE_OPCODE_START 0x0001

// Change UNDI operational state from Started to Stopped.
#define PXE_OPCODE_STOP 0x0002

// Get UNDI initialization information.
#define PXE_OPCODE_GET_INIT_INFO 0x0003

// Get NIC configuration information.
#define PXE_OPCODE_GET_CONFIG_INFO 0x0004

// Changed UNDI operational state from Started to Initialized.
#define PXE_OPCODE_INITIALIZE 0x0005
```

```
// Reinitialize the NIC H/W.
#define PXE_OPCODE_RESET 0x0006

// Change the UNDI operational state from Initialized to Started.
#define PXE_OPCODE_SHUTDOWN 0x0007

// Read & change state of external interrupt enables.
#define PXE_OPCODE_INTERRUPT_ENABLES 0x0008

// Read & change state of packet receive filters.
#define PXE_OPCODE_RECEIVE_FILTERS 0x0009

// Read & change station MAC address.
#define PXE_OPCODE_STATION_ADDRESS 0x000A

// Read traffic statistics.
#define PXE_OPCODE_STATISTICS 0x000B

// Convert multicast IP address to multicast MAC address.
#define PXE_OPCODE_MCAST_IP_TO_MAC 0x000C

// Read or change nonvolatile storage on the NIC.
#define PXE_OPCODE_NVDATA 0x000D

// Get & clear interrupt status.
#define PXE_OPCODE_GET_STATUS 0x000E

// Fill media header in packet for transmit.
#define PXE_OPCODE_FILL_HEADER 0x000F

// Transmit packet(s).
#define PXE_OPCODE_TRANSMIT 0x0010

// Receive packet.
#define PXE_OPCODE_RECEIVE 0x0011

// Last valid PXE UNDI OpCode number.
#define PXE_OPCODE_LAST_VALID 0x0011
```

### E.3.4.3 PXE\_OPFLAGS

```
typedef PXE_UINT16 PXE_OPFLAGS;

#define PXE_OPFLAGS_NOT_USED 0x0000

//*****
// UNDI Get State
//*****

// No OpFlags

//*****
// UNDI Start
//*****

// No OpFlags

//*****
// UNDI Stop
//*****

// No OpFlags

//*****
// UNDI Get Init Info
//*****

// No Opflags

//*****
// UNDI Get Config Info
//*****

// No Opflags

//*****
// UNDI Initialize
//*****

#define PXE_OPFLAGS_INITIALIZE_CABLE_DETECT_MASK 0x0001
#define PXE_OPFLAGS_INITIALIZE_DETECT_CABLE 0x0000
#define PXE_OPFLAGS_INITIALIZE_DO_NOT_DETECT_CABLE 0x0001

//*****
// UNDI Reset
//*****
```

```

#define PXE_OPFLAGS_RESET_DISABLE_INTERRUPTS 0x0001
#define PXE_OPFLAGS_RESET_DISABLE_FILTERS 0x0002

//*****
// UNDI Shutdown
//*****

// No OpFlags

//*****
// UNDI Interrupt Enables
//*****

// Select whether to enable or disable external interrupt
// signals. Setting both enable and disable will return
// PXE_STATCODE_INVALID_OPFLAGS.

#define PXE_OPFLAGS_INTERRUPT_OPMASK 0xC000
#define PXE_OPFLAGS_INTERRUPT_ENABLE 0x8000
#define PXE_OPFLAGS_INTERRUPT_DISABLE 0x4000
#define PXE_OPFLAGS_INTERRUPT_READ 0x0000

// Enable receive interrupts. An external interrupt will be
// generated after a complete non-error packet has been received.

#define PXE_OPFLAGS_INTERRUPT_RECEIVE 0x0001

// Enable transmit interrupts. An external interrupt will be
// generated after a complete non-error packet has been
// transmitted.

#define PXE_OPFLAGS_INTERRUPT_TRANSMIT 0x0002

// Enable command interrupts. An external interrupt will be
// generated when command execution stops.

#define PXE_OPFLAGS_INTERRUPT_COMMAND 0x0004

// Generate software interrupt. Setting this bit generates an
// external interrupt, if it is supported by the hardware.

#define PXE_OPFLAGS_INTERRUPT_SOFTWARE 0x0008

//*****
// UNDI Receive Filters
//*****

```



```
// Select whether to enable or disable receive filters.
// Setting both enable and disable will return
// PXE_STATCODE_INVALID_OPCODE.

#define PXE_OPFLAGS_RECEIVE_FILTER_OPMASK 0xC000
#define PXE_OPFLAGS_RECEIVE_FILTER_ENABLE 0x8000
#define PXE_OPFLAGS_RECEIVE_FILTER_DISABLE 0x4000
#define PXE_OPFLAGS_RECEIVE_FILTER_READ 0x0000

// To reset the contents of the multicast MAC address filter
// list, set this OpFlag:

#define PXE_OPFLAGS_RECEIVE_FILTERS_RESET_MCAST_LIST 0x2000

// Enable unicast packet receiving. Packets sent to the
// current station MAC address will be received.

#define PXE_OPFLAGS_RECEIVE_FILTER_UNICAST 0x0001

// Enable broadcast packet receiving. Packets sent to the
// broadcast MAC address will be received.

#define PXE_OPFLAGS_RECEIVE_FILTER_BROADCAST 0x0002

// Enable filtered multicast packet receiving. Packets sent to
// any of the multicast MAC addresses in the multicast MAC
```

```

// address filter list will be received. If the filter list is
// empty, no multicast

#define PXE_OPFLAGS_RECEIVE_FILTER_FILTERED_MULTICAST 0x0004

// Enable promiscuous packet receiving. All packets will be
// received.

#define PXE_OPFLAGS_RECEIVE_FILTER_PROMISCUOUS 0x0008

// Enable promiscuous multicast packet receiving. All multicast
// packets will be received.

#define PXE_OPFLAGS_RECEIVE_FILTER_ALL_MULTICAST 0x0010

//*****
// UNDI Station Address
//*****

#define PXE_OPFLAGS_STATION_ADDRESS_READ 0x0000
#define PXE_OPFLAGS_STATION_ADDRESS_WRITE 0x0000
#define PXE_OPFLAGS_STATION_ADDRESS_RESET 0x0001

//*****
// UNDI Statistics
//*****

#define PXE_OPFLAGS_STATISTICS_READ 0x0000
#define PXE_OPFLAGS_STATISTICS_RESET 0x0001

//*****
// UNDI MCast IP to MAC
//*****

// Identify the type of IP address in the CPB.

#define PXE_OPFLAGS_MCAST_IP_TO_MAC_OPMASK 0x0003
#define PXE_OPFLAGS_MCAST_IPV4_TO_MAC 0x0000
#define PXE_OPFLAGS_MCAST_IPV6_TO_MAC 0x0001

//*****
// UNDI NvData
//*****

// Select the type of nonvolatile data operation.

#define PXE_OPFLAGS_NVDATA_OPMASK 0x0001

```

```

#define PXE_OPFLAGS_NVDATA_READ  0x0000
#define PXE_OPFLAGS_NVDATA_WRITE 0x0001

//*****
// UNDI Get Status
//*****

// Return current interrupt status. This will also clear any
// interrupts that are currently set. This can be used in a
// polling routine. The interrupt flags are still set and
// cleared even when the interrupts are disabled.

#define PXE_OPFLAGS_GET_INTERRUPT_STATUS 0x0001

// Return list of transmitted buffers for recycling. Transmit
// buffers must not be changed or unallocated until they have
// recycled. After issuing a transmit command, wait for a
// transmit complete interrupt. When a transmit complete
// interrupt is received, read the transmitted buffers. Do not
// plan on getting one buffer per interrupt. Some NICs and UNDI's
// may transmit multiple buffers per interrupt.

#define PXE_OPFLAGS_GET_TRANSMITTED_BUFFERS 0x0002

// Return current media status.

#define PXE_OPFLAGS_GET_MEDIA_STATUS 0x0004

//*****
// UNDI Fill Header
//*****

#define PXE_OPFLAGS_FILL_HEADER_OPMASK 0x0001
#define PXE_OPFLAGS_FILL_HEADER_FRAGMENTED 0x0001
#define PXE_OPFLAGS_FILL_HEADER_WHOLE 0x0000

//*****
// UNDI Transmit
//*****

// S/W UNDI only. Return after the packet has been transmitted.
// A transmit complete interrupt will still be generated and the

```

```

// transmit buffer will have to be recycled.

#define PXE_OPFLAGS_SWUNDI_TRANSMIT_OPMASK 0x0001
#define PXE_OPFLAGS_TRANSMIT_BLOCK 0x0001
#define PXE_OPFLAGS_TRANSMIT_DONT_BLOCK 0x0000

#define PXE_OPFLAGS_TRANSMIT_OPMASK 0x0002
#define PXE_OPFLAGS_TRANSMIT_FRAGMENTED 0x0002
#define PXE_OPFLAGS_TRANSMIT_WHOLE 0x0000

//*****
// UNDI Receive
//*****

// No OpFlags

```

#### E.3.4.4 PXE\_STATFLAGS

```

typedef PXE_UINT16 PXE_STATFLAGS;

#define PXE_STATFLAGS_INITIALIZE 0x0000

//*****
// Common StatFlags that can be returned by all commands.
//*****

// The COMMAND_COMPLETE and COMMAND_FAILED status flags must be
// implemented by all UNDI. COMMAND_QUEUED is only needed by
// UNDI that support command queuing.

#define PXE_STATFLAGS_STATUS_MASK 0xC000
#define PXE_STATFLAGS_COMMAND_COMPLETE 0xC000
#define PXE_STATFLAGS_COMMAND_FAILED 0x8000
#define PXE_STATFLAGS_COMMAND_QUEUED 0x4000

//*****
// UNDI Get State
//*****

#define PXE_STATFLAGS_GET_STATE_MASK 0x0003
#define PXE_STATFLAGS_GET_STATE_INITIALIZED 0x0002
#define PXE_STATFLAGS_GET_STATE_STARTED 0x0001
#define PXE_STATFLAGS_GET_STATE_STOPPED 0x0000

//*****
// UNDI Start
//*****

```

```

// No additional StatFlags

//*****
// UNDI Get Init Info
//*****

#define PXE_STATFLAGS_CABLE_DETECT_MASK    0x0001
#define PXE_STATFLAGS_CABLE_DETECT_NOT_SUPPORTED 0x0000
#define PXE_STATFLAGS_CABLE_DETECT_SUPPORTED 0x0001
#define PXE_STATFLAGS_GET_STATUS_NO_MEDIA_MASK 0x0002
#define PXE_STATFLAGS_GET_STATUS_NO_MEDIA_NOT_SUPPORTED 0x0000
#define PXE_STATFLAGS_GET_STATUS_NO_MEDIA_SUPPORTED 0x0002

//*****
// UNDI Initialize
//*****

#define PXE_STATFLAGS_INITIALIZED_NO_MEDIA 0x0001

//*****
// UNDI Reset
//*****

#define PXE_STATFLAGS_RESET_NO_MEDIA 0x0001

//*****
// UNDI Shutdown
//*****

// No additional StatFlags

//*****
// UNDI Interrupt Enables
//*****

// If set, receive interrupts are enabled.
#define PXE_STATFLAGS_INTERRUPT_RECEIVE 0x0001

// If set, transmit interrupts are enabled.
#define PXE_STATFLAGS_INTERRUPT_TRANSMIT 0x0002

// If set, command interrupts are enabled.
#define PXE_STATFLAGS_INTERRUPT_COMMAND 0x0004

//*****
// UNDI Receive Filters

```

```
//*****  
  
// If set, unicast packets will be received.  
#define PXE_STATFLAGS_RECEIVE_FILTER_UNICAST 0x0001  
  
// If set, broadcast packets will be received.  
#define PXE_STATFLAGS_RECEIVE_FILTER_BROADCAST 0x0002  
  
// If set, multicast packets that match up with the multicast  
// address filter list will be received.  
#define PXE_STATFLAGS_RECEIVE_FILTER_FILTERED_MULTICAST 0x0004  
  
// If set, all packets will be received.  
#define PXE_STATFLAGS_RECEIVE_FILTER_PROMISCUOUS 0x0008  
  
// If set, all multicast packets will be received.  
#define PXE_STATFLAGS_RECEIVE_FILTER_ALL_MULTICAST 0x0010  
  
//*****  
// UNDI Station Address  
//*****  
  
// No additional StatFlags  
  
//*****  
// UNDI Statistics  
//*****  
  
// No additional StatFlags  
  
//*****  
// UNDI MCast IP to MAC  
//*****  
  
// No additional StatFlags  
  
//*****  
// UNDI NvData  
//*****  
  
// No additional StatFlags  
  
//*****  
// UNDI Get Status  
//*****  
  
// Use to determine if an interrupt has occurred.
```

```

#define PXE_STATFLAGS_GET_STATUS_INTERRUPT_MASK 0x000F
#define PXE_STATFLAGS_GET_STATUS_NO_INTERRUPTS 0x0000

// If set, at least one receive interrupt occurred.
#define PXE_STATFLAGS_GET_STATUS_RECEIVE 0x0001

// If set, at least one transmit interrupt occurred.

#define PXE_STATFLAGS_GET_STATUS_TRANSMIT 0x0002

// If set, at least one command interrupt occurred.
#define PXE_STATFLAGS_GET_STATUS_COMMAND 0x0004

// If set, at least one software interrupt occurred.
#define PXE_STATFLAGS_GET_STATUS_SOFTWARE 0x0008

// This flag is set if the transmitted buffer queue is empty.
// This flag will be set if all transmitted buffer addresses
// get written into the DB.
#define PXE_STATFLAGS_GET_STATUS_TXBUF_QUEUE_EMPTY 0x0010

// This flag is set if no transmitted buffer addresses were
// written into the DB. (This could be because DBsize was
// too small.)
#define PXE_STATFLAGS_GET_STATUS_NO_TXBUFS_WRITTEN 0x0020

// This flag is set if there is no media detected
#define PXE_STATFLAGS_GET_STATUS_NO_MEDIA 0x0040

//*****
// UNDI Fill Header
//*****

// No additional StatFlags

//*****
// UNDI Transmit
//*****

// No additional StatFlags.

//*****
// UNDI Receive
//*****

// No additional StatFlags.

```

#### E.3.4.5 PXE\_STATCODE

```
typedef PXE_UINT16 PXE_STATCODE;  
  
#define PXE_STATCODE_INITIALIZE 0x0000  
  
//*****  
// Common StatCodes returned by all UNDI commands, UNDI protocol
```



```

// functions and BC protocol functions.
//*****

#define PXE_STATCODE_SUCCESS    0x0000
#define PXE_STATCODE_INVALID_CDB  0x0001
#define PXE_STATCODE_INVALID_CPB  0x0002
#define PXE_STATCODE_BUSY        0x0003
#define PXE_STATCODE_QUEUE_FULL   0x0004
#define PXE_STATCODE_ALREADY_STARTED 0x0005
#define PXE_STATCODE_NOT_STARTED  0x0006
#define PXE_STATCODE_NOT_SHUTDOWN 0x0007
#define PXE_STATCODE_ALREADY_INITIALIZED 0x0008
#define PXE_STATCODE_NOT_INITIALIZED 0x0009
#define PXE_STATCODE_DEVICE_FAILURE 0x000A
#define PXE_STATCODE_NVDATA_FAILURE 0x000B
#define PXE_STATCODE_UNSUPPORTED  0x000C
#define PXE_STATCODE_BUFFER_FULL   0x000D
#define PXE_STATCODE_INVALID_PARAMETER 0x000E
#define PXE_STATCODE_INVALID_UNDI  0x000F
#define PXE_STATCODE_IPV4_NOT_SUPPORTED 0x0010
#define PXE_STATCODE_IPV6_NOT_SUPPORTED 0x0011
#define PXE_STATCODE_NOT_ENOUGH_MEMORY 0x0012
#define PXE_STATCODE_NO_DATA       0x0013

```

#### E.3.4.6 PXE\_IFNUM

```

typedef PXE_UINT16 PXE_IFNUM;

// This interface number must be passed to the S/W UNDI Start
// command.

#define PXE_IFNUM_START    0x0000

// This interface number is returned by the S/W UNDI Get State
// and Start commands if information in the CDB, CPB or DB is
// invalid.

#define PXE_IFNUM_INVALID  0x0000

```

#### E.3.4.7 PXE\_CONTROL

```

typedef PXE_UINT16 PXE_CONTROL;

// Setting this flag directs the UNDI to queue this command for
// later execution if the UNDI is busy and it supports command
// queuing. If queuing is not supported, a

```

```
// PXE_STATCODE_INVALID_CONTROL error is returned. If the queue
// is full, a PXE_STATCODE_CDB_QUEUE_FULL error is returned.
```

```
#define PXE_CONTROL_QUEUE_IF_BUSY 0x0002
```

```
// These two bit values are used to determine if there are more
// UNDI CDB structures following this one. If the link bit is
// set, there must be a CDB structure following this one.
// Execution will start on the next CDB structure as soon as this
// one completes successfully. If an error is generated by this
// command, execution will stop.
```

```
#define PXE_CONTROL_LINK 0x0001
```

```
#define PXE_CONTROL_LAST_CDB_IN_LIST 0x0000
```

#### E.3.4.8 PXE\_FRAME\_TYPE

```
typedef PXE_UINT8 PXE_FRAME_TYPE;
```

```
#define PXE_FRAME_TYPE_NONE 0x00
```

```
#define PXE_FRAME_TYPE_UNICAST 0x01
```

```
#define PXE_FRAME_TYPE_BROADCAST 0x02
```

```
#define PXE_FRAME_TYPE_FILTERED_MULTICAST 0x03
```

```
#define PXE_FRAME_TYPE_PROMISCUOUS 0x04
```

```
#define PXE_FRAME_TYPE_PROMISCUOUS_MULTICAST 0x05
```

#### E.3.4.9 PXE\_IPV4

This storage type is always big endian, not little endian.

```
typedef PXE_UINT32 PXE_IPV4;
```

#### E.3.4.10 PXE\_IPV6

This storage type is always big endian, not little endian.

```
typedef struct s_PXE_IPV6 {
    PXE_UINT32 num[4];
} PXE_IPV6;
```

#### E.3.4.11 PXE\_MAC\_ADDR

This storage type is always big endian, not little endian.

```
typedef struct {
    PXE_UINT8 num[32];
} PXE_MAC_ADDR;
```

#### E.3.4.12 PXE\_IFTYPE

The interface type is returned by the Get Initialization Information command and is used by the BC DHCP protocol function. This field is also used for the low order 8-bits of the H/

W type field in ARP packets. The high order 8-bits of the H/W type field in ARP packets will always be set to 0x00 by the BC.

```
typedef PXE_UINT8 PXE_IFTYPE;  
  
// This information is from the ARP section of RFC 3232.  
  
// 1 Ethernet (10Mb)  
// 2 Experimental Ethernet (3Mb)  
// 3 Amateur Radio AX.25  
// 4 Proteon ProNET Token Ring  
// 5 Chaos  
// 6 IEEE 802 Networks  
// 7 ARCNET  
// 8 Hyperchannel  
// 9 Lanstar  
// 10 Autonet Short Address  
// 11 LocalTalk  
// 12 LocalNet (IBM PCNet or SYTEK LocalNET)  
// 13 Ultra link  
// 14 SMDS  
// 15 Frame Relay  
// 16 Asynchronous Transmission Mode (ATM)  
// 17 HDLC  
// 18 Fibre Channel  
// 19 Asynchronous Transmission Mode (ATM)  
// 20 Serial Line  
// 21 Asynchronous Transmission Mode (ATM)  
  
#define PXE_IFTYPE_ETHERNET 0x01  
#define PXE_IFTYPE_TOKENRING 0x04  
#define PXE_IFTYPE_FIBRE_CHANNEL 0x12
```

#### **E.3.4.13 PXE\_MEDIA\_PROTOCOL**

Protocol type. This will be copied into the media header without doing byte swapping. Protocol type numbers can be obtained from the assigned numbers RFC 3232.

```
typedef UINT16 PXE_MEDIA_PROTOCOL;
```

#### **E.3.5 Compound Types**

All PXE structures must be byte packed.

##### **E.3.5.1 PXE\_HW\_UNDI**

This section defines the C structures and #defines for the !PXE H/W UNDI interface.

```

#pragma pack(1)
typedef struct s_pxe_hw_undi {
    PXE_UINT32 Signature; // PXE_ROMID_SIGNATURE
    PXE_UINT8 Len; // sizeof(PXE_HW_UNDI)
    PXE_UINT8 Fudge; // makes 8-bit cksum equal zero
    PXE_UINT8 Rev; // PXE_ROMID_REV
    PXE_UINT8 IFcnt; // physical connector count
        lower byte
    PXE_UINT8 MajorVer; // PXE_ROMID_MAJORVER
    PXE_UINT8 MinorVer; // PXE_ROMID_MINORVER
    PXE_UINT8 IFcntExt; // physical connector count
        upper byte
    PXE_UINT8 reserved; // zero, not used
    PXE_UINT32 Implementation; // implementation flags
} PXE_HW_UNDI;
#pragma pack()

// Status port bit definitions

// UNDI operation state

#define PXE_HWSTAT_STATE_MASK 0xC0000000
#define PXE_HWSTAT_BUSY 0xC0000000
#define PXE_HWSTAT_INITIALIZED 0x80000000
#define PXE_HWSTAT_STARTED 0x40000000
#define PXE_HWSTAT_STOPPED 0x00000000

// If set, last command failed

#define PXE_HWSTAT_COMMAND_FAILED 0x20000000

// If set, identifies enabled receive filters

#define PXE_HWSTAT_PROMISCUOUS_MULTICAST_RX_ENABLED 0x00001000
#define PXE_HWSTAT_PROMISCUOUS_RX_ENABLED 0x00000800
#define PXE_HWSTAT_BROADCAST_RX_ENABLED 0x00000400
#define PXE_HWSTAT_MULTICAST_RX_ENABLED 0x00000200
#define PXE_HWSTAT_UNICAST_RX_ENABLED 0x00000100

// If set, identifies enabled external interrupts

#define PXE_HWSTAT_SOFTWARE_INT_ENABLED 0x00000080
#define PXE_HWSTAT_TX_COMPLETE_INT_ENABLED 0x00000040
#define PXE_HWSTAT_PACKET_RX_INT_ENABLED 0x00000020
#define PXE_HWSTAT_CMD_COMPLETE_INT_ENABLED 0x00000010

// If set, identifies pending interrupts

```

```

#define PXE_HWSTAT_SOFTWARE_INT_PENDING 0x00000008
#define PXE_HWSTAT_TX_COMPLETE_INT_PENDING 0x00000004
#define PXE_HWSTAT_PACKET_RX_INT_PENDING 0x00000002
#define PXE_HWSTAT_CMD_COMPLETE_INT_PENDING 0x00000001

// Command port definitions

// If set, CDB identified in CDBaddr port is given to UNDI.
// If not set, other bits in this word will be processed.

#define PXE_HWCMD_ISSUE_COMMAND 0x80000000
#define PXE_HWCMD_INTS_AND_FILTERS 0x00000000

// Use these to enable/disable receive filters.

#define PXE_HWCMD_PROMISCUOUS_MULTICAST_RX_ENABLE 0x00001000
#define PXE_HWCMD_PROMISCUOUS_RX_ENABLE 0x00000800
#define PXE_HWCMD_BROADCAST_RX_ENABLE 0x00000400
#define PXE_HWCMD_MULTICAST_RX_ENABLE 0x00000200
#define PXE_HWCMD_UNICAST_RX_ENABLE 0x00000100

// Use these to enable/disable external interrupts

#define PXE_HWCMD_SOFTWARE_INT_ENABLE 0x00000080
#define PXE_HWCMD_TX_COMPLETE_INT_ENABLE 0x00000040
#define PXE_HWCMD_PACKET_RX_INT_ENABLE 0x00000020
#define PXE_HWCMD_CMD_COMPLETE_INT_ENABLE 0x00000010

// Use these to clear pending external interrupts

#define PXE_HWCMD_CLEAR_SOFTWARE_INT 0x00000008
#define PXE_HWCMD_CLEAR_TX_COMPLETE_INT 0x00000004
#define PXE_HWCMD_CLEAR_PACKET_RX_INT 0x00000002
#define PXE_HWCMD_CLEAR_CMD_COMPLETE_INT 0x00000001

```

### E.3.5.2 PXE\_SW\_UNDI

This section defines the C structures and #defines for the !PXE S/W UNDI interface.

```

#pragma pack(1)
typedef struct s_pxe_sw_undi {
    PXE_UINT32 Signature; // PXE_ROMID_SIGNATURE
    PXE_UINT8 Len; // sizeof(PXE_SW_UNDI)
    PXE_UINT8 Fudge; // makes 8-bit cksum zero
    PXE_UINT8 Rev; // PXE_ROMID_REV
    PXE_UINT8 IFcnt; // physical connector count
        lower byte
    PXE_UINT8 MajorVer; // PXE_ROMID_MAJORVER
    PXE_UINT8 MinorVer; // PXE_ROMID_MINORVER
    PXE_UINT8 IFcntExt; // physical connector count
        upper byte
    PXE_UINT8 reserved1; // zero, not used
    PXE_UINT32 Implementation; // Implementation flags
    PXE_UINT64 EntryPoint; // API entry point
    PXE_UINT8 reserved2[3]; // zero, not used
    PXE_UINT8 BusCnt; // number of bustypes supported
    PXE_UINT32 BusType[1]; // list of supported bustypes
} PXE_SW_UNDI;
#pragma pack()

```

### E.3.5.3 PXE\_UNDI

PXE\_UNDI combines both the H/W and S/W UNDI types into one typedef and has #defines for common fields in both H/W and S/W UNDI types.

```

#pragma pack(1)
typedef union u_pxe_undi {
    PXE_HW_UNDI hw;
    PXE_SW_UNDI sw;
} PXE_UNDI;
#pragma pack()

// Signature of !PXE structure

#define PXE_ROMID_SIGNATURE PXE_BUSTYPE ('!', 'P', 'X', 'E')

// !PXE structure format revision )
// See "Links to UEFI-Related Documents" (http://uefi.org/uefi)
// under the heading "UDP over IPv6".

#define PXE_ROMID_REV    0x02

// UNDI command interface revision. These are the values that
// get sent in option 94 (Client Network Interface Identifier) in
// the DHCP Discover and PXE Boot Server Request packets.
// See "Links to UEFI-Related Documents" (http://uefi.org/uefi)
// under the heading "IETF Organization".

```

```

#define PXE_ROMID_MAJORVER 0x03
#define PXE_ROMID_MINORVER 0x01

// Implementation flags

#define PXE_ROMID_IMP_HW_UNDI 0x80000000
#define PXE_ROMID_IMP_SW_VIRT_ADDR 0x40000000
#define PXE_ROMID_IMP_64BIT_DEVICE 0x00010000
#define PXE_ROMID_IMP_FRAG_SUPPORTED 0x00008000
#define PXE_ROMID_IMP_CMD_LINK_SUPPORTED 0x00004000
#define PXE_ROMID_IMP_CMD_QUEUE_SUPPORTED 0x00002000
#define PXE_ROMID_IMP_MULTI_FRAME_SUPPORTED 0x00001000
#define PXE_ROMID_IMP_NVDATA_SUPPORT_MASK 0x00000C00
#define PXE_ROMID_IMP_NVDATA_BULK_WRITABLE 0x00000C00
#define PXE_ROMID_IMP_NVDATA_SPARSE_WRITABLE 0x00000800
#define PXE_ROMID_IMP_NVDATA_READ_ONLY 0x00000400
#define PXE_ROMID_IMP_NVDATA_NOT_AVAILABLE 0x00000000
#define PXE_ROMID_IMP_STATISTICS_SUPPORTED 0x00000200
#define PXE_ROMID_IMP_STATION_ADDR_SETTABLE 0x00000100
#define PXE_ROMID_IMP_PROMISCUOUS_MULTICAST_RX_SUPPORTED 0x00000080
#define PXE_ROMID_IMP_PROMISCUOUS_RX_SUPPORTED 0x00000040
#define PXE_ROMID_IMP_BROADCAST_RX_SUPPORTED 0x00000020
#define PXE_ROMID_IMP_FILTERED_MULTICAST_RX_SUPPORTED 0x00000010
#define PXE_ROMID_IMP_SOFTWARE_INT_SUPPORTED 0x00000008
#define PXE_ROMID_IMP_TX_COMPLETE_INT_SUPPORTED 0x00000004
#define PXE_ROMID_IMP_PACKET_RX_INT_SUPPORTED 0x00000002
#define PXE_ROMID_IMP_CMD_COMPLETE_INT_SUPPORTED 0x00000001

```

### E.3.5.4 PXE\_CDB

PXE UNDI command descriptor block.

```

#pragma pack(1)
typedef struct s_pxe_cdb {
    PXE_OPCODE OpCode;
    PXE_OPFLAGS OpFlags;
    PXE_UINT16 CPBsize;
    PXE_UINT16 DBsize;
    PXE_UINT64 CPBaddr;
    PXE_UINT64 DBaddr;
    PXE_STATCODE StatCode;
    PXE_STATFLAGS StatFlags;
    PXE_UINT16 IFnum;
    PXE_CONTROL Control;
} PXE_CDB;
#pragma pack()

```

If the UNDI driver enables hardware VLAN support, UNDI driver could use *IFnum* to identify the real NICs and VLAN created virtual NICs.

### E.3.5.5 PXE\_IP\_ADDR

This storage type is always big endian, not little endian.

```
#pragma pack(1)
typedef union u_pxe_ip_addr {
    PXE_IPV6 IPv6;
    PXE_IPV4 IPv4;
} PXE_IP_ADDR;
#pragma pack()
```

### E.3.5.6 PXE\_DEVICE

This typedef is used to identify the network device that is being used by the UNDI. This information is returned by the Get Config Info command.

```
#pragma pack(1)
typedef union pxe_device {

    // PCI and PC Card NICs are both identified using bus, device
    // and function numbers. For PC Card, this may require PC
    // Card services to be loaded in the BIOS or preboot
    // environment.
    struct {
        // See S/W UNDI ROMID structure definition for PCI and
        // PCC BusType definitions.
        PXE_UINT32 BusType;

        // Bus, device & function numbers that locate this device.
        PXE_UINT16 Bus;
        PXE_UINT8 Device;
        PXE_UINT8 Function;
    } PCI, PCC;

} PXE_DEVICE;
#pragma pack()
```

## E.4 UNDI Commands

All 32/64-bit UNDI commands use the same basic command format, the CDB (Command Descriptor Block). CDB fields that are not used by a particular command must be initialized to zero by the application/driver that is issuing the command. (See “Links to UEFI-Related Documents” (<http://uefi.org/uefi>) under the heading “DMTF BIOS specifications”.)

All UNDI implementations must set the command completion status (**PXE\_STATFLAGS\_COMMAND\_COMPLETE**) after command execution completes. Applications and drivers must not alter or rely on the contents of any of the CDB, CPB or DB fields until the command completion status is set.



All commands return status codes for invalid CDB contents and, if used, invalid CPB contents. Commands with invalid parameters will not execute. Fix the error and submit the command again.

[Figure 149](#) describes the different UNDI states (Stopped, Started and Initialized), shows the transitions between the states and which UNDI commands are valid in each state.

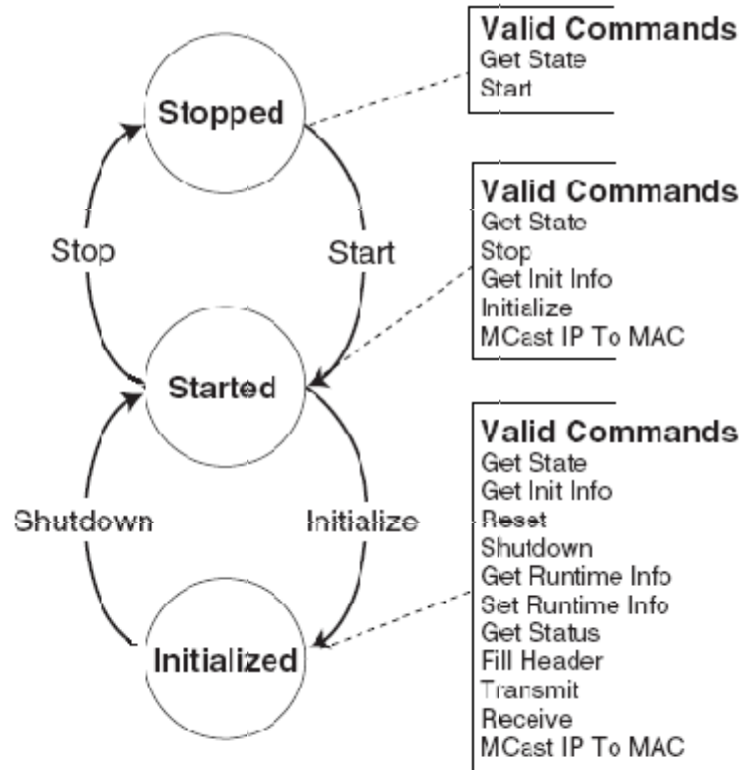

OM10107

**Figure 149. UNDI States, Transitions & Valid Commands**

**Note:** All memory addresses including the CDB address, CPB address, and the DB address submitted to the S/W UNDI by the protocol drivers must be processor-based addresses. All memory addresses submitted to the H/W UNDI must be device based addresses.

**Note:** Additional requirements for S/W UNDI implementations: Processor register contents must be unchanged by S/W UNDI command execution (The application/driver does not have to save processor registers when calling S/W UNDI). Processor arithmetic flags are undefined (application/driver must save processor arithmetic flags if needed). Application/driver must remove CDB address from stack after control returns from S/W UNDI.

**Note:** Additional requirements for 32-bit network devices: All addresses given to the S/W UNDI must be 32-bit addresses. Any address that exceeds 32 bits (4 GiB) will result in a return of one of the

following status codes: **PXE\_STATCODE\_INVALID\_PARAMETER**, **PXE\_STATCODE\_INVALID\_CDB** or **PXE\_STATCODE\_INVALID\_CPB**.

When executing linked commands, command execution will stop at the end of the CDB list (when the **PXE\_CONTROL\_LINK** bit is not set) or when a command returns an error status code.

**Note:** Buffers requested via the *MemoryRequired* field in **s\_pxe\_db\_get\_init\_info** (see [Appendix E.4.5.5](#)) will be allocated via **PCI\_IO.AllocateBuffer()**. However, the buffers passed to various UNDI commands are not guaranteed to be allocated via **AllocateBuffer()**.

**Note:** Calls to *Map\_Mem()* of type **TO\_AND\_FROM\_DEVICE** must only be used for common DMA buffers. Such buffers must be requested via the *MemoryRequired* field in **s\_pxe\_db\_get\_init\_info** and provided through the *Initialize* command

### E.4.1 Command Linking and Queuing

When linking commands, the CDBs must be stored consecutively in system memory without any gaps in between. Do not set the Link bit in the last CDB in the list. As shown in [Figure 150](#), the Link bit must be set in all other CDBs in the list.

Linked CDBs	
0x00	<b>CDB</b>
0x1F	Set Link bit.
0x20	<b>CDB</b>
0x3F	Set Link bit.
0x40	<b>CDB</b>
0x5F	Do not set Link bit.

OM13188

Figure 150. Linked CDBs

When the H/W UNDI is executing commands, the State bits in the Status field in the !PXE structure will be set to Busy (3).

When H/W or S/W UNDI is executing commands and a new command is issued, a StatCode of **PXE\_STATCODE\_BUSY** and a StatFlag of

**PXE\_STATFLAG\_COMMAND\_FAILURE** is set in the CDB. For linked commands, only the first CDB will be set to Busy, all other CDBs will be unchanged. When a linked command fails, execution on the list stops. Commands after the failing command will not be run.

As shown in [Figure 151](#), when queuing commands, only the first CDB needs to have the Queue Control flag set. If queuing is supported and the UNDI is busy and there is room in the command queue, the command (or list of commands) will be queued.

Queued CDBs	
0x00	<b>CDB</b>
0x1F	Set Queue bit. Set Link bit.
0x20	<b>CDB</b>
0x3F	Set Queue bit. Set Link bit.
0x40	<b>CDB</b>
0x5F	Set Queue bit. Set Link bit.

OM13189

**Figure 151. Queued CDBs**

When a command is queued a StatFlag of **PXE\_STATFLAG\_COMMAND\_QUEUED** is set (if linked commands are queued only the StatFlag of the first CDB gets set). This signals that the command was added to the queue. Commands in the queue will be run on a first-in, first-out, basis. When a command fails, the next command in the queue is run. When a linked command in the queue fails, execution on the list stops. The next command, or list of commands, that was added to the command queue will be run.

### E.4.2 Get State

This command is used to determine the operational state of the UNDI. An UNDI has three possible operational states:

- **Stopped.** A stopped UNDI is free for the taking. When all interface numbers (IFNum) for a particular S/W UNDI are stopped, that S/W UNDI image can be relocated or removed. A stopped UNDI will accept Get State and Start commands.
- **Started.** A started UNDI is in use. A started UNDI will accept Get State, Stop, Get Init Info, and Initialize commands.
- **Initialized.** An initialized UNDI is in used. An initialized UNDI will accept all commands except: Start, Stop, and Initialize.

Drivers and applications must not start using UNDI's that have been placed into the Started or Initialized states by another driver or application.

3.0 and 3.1 S/W UNDI: No callbacks are performed by this UNDI command.

### E.4.2.1 Issuing the Command

To issue a Get State command, create a CDB and fill it in as shown in the table below:

CDB Field	How to initialize the CDB structure for a Get State command
OpCode	PXE_OPCODE_GET_STATE
OpFlags	PXE_OPFLAGS_NOT_USED
CPBsize	PXE_CPBSIZE_NOT_USED
DBsize	PXE_DBSIZE_NOT_USED
CPBaddr	PXE_CPBADDR_NOT_USED
DBaddr	PXE_DBADDR_NOT_USED
StatCode	PXE_STATCODE_INITIALIZE
StatFlags	PXE_STATFLAGS_INITIALIZE
IFnum	A valid interface number from zero to <b>(!PXE.IFcnt   (!PXE.IFcntExt &lt;&lt; 8))</b> .
Control	Set as needed

### E.4.2.2 Waiting for the Command to Execute

Monitor the upper two bits (14 & 15) in the **CDB.StatFlags** field. Until these bits change to report **PXE\_STATFLAGS\_COMMAND\_COMPLETE** or **PXE\_STATFLAGS\_COMMAND\_FAILED**, the command has not been executed by the UNDI.

StatFlags	Reason
COMMAND_COMPLETE	Command completed successfully. StatFlags contain operational state.
COMMAND_FAILED	Command failed. StatCode field contains error code.
COMMAND_QUEUED	Command has been queued. All other fields are unchanged.
INITIALIZE	Command has not been executed or queued.

### E.4.2.3 Checking Command Execution Results

After command execution completes, either successfully or not, the **CDB.StatCode** field contains the result of the command execution.

StatCode	Reason
SUCCESS	Command completed successfully. StatFlags contain operational state.
INVALID_CDB	One of the CDB fields was not set correctly.
BUSY	UNDI is already processing commands. Try again later.
QUEUE_FULL	Command queue is full. Try again later.

If the command completes successfully, use **PXE\_STATFLAGS\_GET\_STATE\_MASK** to check the state of the UNDI.

StatFlags	Reason
STOPPED	The UNDI is stopped.
STARTED	The UNDI is started, but not initialized.
INITIALIZED	The UNDI is initialized.

### E.4.3 Start

This command is used to change the UNDI operational state from stopped to started. No other operational checks are made by this command. Protocol driver makes this call for each network interface supported by the UNDI with a set of call back routines and a unique identifier to identify the particular interface. UNDI does not interpret the unique identifier in any way except that it is a 64-bit value and it will pass it back to the protocol driver as a parameter to all the call back routines for any particular interface. If this is a S/W UNDI, the callback functions Delay(), Virt2Phys(), Map\_Mem(), UnMap\_Mem(), and Sync\_Mem() functions will not be called by this command.

#### E.4.3.1 Issuing the Command

To issue a Start command for H/W UNDI, create a CDB and fill it in as shows in the table below:

CDB Field	How to initialize the CDB structure for a H/W UNDI Start command
OpCode	PXE_OPCODE_START
OpFlags	PXE_OPFLAGS_NOT_USED
CPBsize	PXE_CPBSIZE_NOT_USED
DBsize	PXE_DBSIZE_NOT_USED
CPBaddr	PXE_CPBADDR_NOT_USED
DBaddr	PXE_DBADDR_NOT_USED
StatCode	PXE_STATCODE_INITIALIZE
StatFlags	PXE_STATFLAGS_INITIALIZE
IFnum	A valid interface number from zero to <b>(!PXE.IFcnt   (!PXE.IFcntExt &lt;&lt; 8))</b> .
Control	Set as needed

To issue a Start command for S/W UNDI, create a CDB and fill it in as shows in the table below:

CDB Field	How to initialize the CDB structure for a S/W UNDI Start command
OpCode	PXE_OPCODE_START
OpFlags	PXE_OPFLAGS_NOT_USED
CPBsize	sizeof(PXE_CPB_START)
DBsize	PXE_DBSIZE_NOT_USED

CPBaddr	Address of a <b>PXE_CPB_START</b> structure.
DBaddr	PXE_DBADDR_NOT_USED
StatCode	PXE_STATCODE_INITIALIZE
StatFlags	PXE_STATFLAGS_INITIALIZE
IFnum	A valid interface number from zero to <b>(!PXE.IFcnt   (!PXE.IFcntExt &lt;&lt; 8))</b> .
Control	Set as needed

### E.4.3.2 Preparing the CPB

For the 3.1 S/W UNDI Start command, the CPB structure shown below must be filled in and the CDB must be set to **sizeof(struct s\_pxe\_cpb\_start\_31)**.

```

#pragma pack(1)
typedef struct s_pxe_cpb_start_31 {
    UINT64 Delay;
    //
    // Address of the Delay() callback service.
    // This field cannot be set to zero.
    //
    // VOID
    // Delay(
    // IN UINT64 UniqueId,
    // IN UINT64 Microseconds);
    //
    // UNDI will never request a delay smaller than 10 microseconds
    // and will always request delays in increments of 10
    // microseconds. The Delay() callback routine must delay
    // between n and n + 10 microseconds before returning control
    // to the UNDI.
    //

    UINT64 Block;
    //
    // Address of the Block() callback service.
    // This field cannot be set to zero.
    //
    // VOID
    // Block(
    // IN UINT64 UniqueId,
    // IN UINT32 Enable);
    //
    // UNDI may need to block multithreaded/multiprocessor access
    // to critical code sections when programming or accessing the
    // network device. When UNDI needs a block, it will call the
    // Block()callback service with Enable set to a non-zero value.
    // When UNDI no longer needs the block, it will call Block()
    // with Enable set to zero.
    //

    UINT64 Virt2Phys;
    //
    // Convert a virtual address to a physical address.
    // This field can be set to zero if virtual and physical
    // addresses are identical.
    //
    // VOID
    // Virt2Phys(
    // IN UINT64 UniqueId,
    // IN UINT64 Virtual,

```

```
// OUT UINT64 PhysicalPtr);
//
// UNDI will pass in a virtual address and a pointer to storage
// for a physical address. The Virt2Phys() service converts
// the virtual address to a physical address and stores the
// resulting physical address in the supplied buffer. If no
// conversion is needed, the virtual address must be copied
// into the supplied physical address buffer.
//

UINT64 Mem_IO;
//
// Read/Write network device memory and/or I/O register space.
// This field cannot be set to zero.
//
// VOID
// Mem_IO(
// IN UINT64 UniqueId,
// IN UINT8 AccessType,
// IN UINT8 Length,
// IN UINT64 Port,
// IN OUT UINT64 BufferPtr);
//
// UNDI uses the Mem_IO() service to access the network device
// memory and/or I/O registers. The AccessType is one of the
// PXE_IO_xxx or PXE_MEM_xxx constants defined at the end of
// this section. The Length is 1, 2, 4 or 8. The Port number
// is relative to the base memory or I/O address space for this
// device. BufferPtr points to the data to be written to the
// Port or will contain the data that is read from the Port.
//

UINT64 Map_Mem;
//
// Map virtual memory address for DMA.
// This field can be set to zero if there is no mapping
// service.
//
// VOID
// Map_Mem(
// IN UINT64 UniqueId,
// IN UINT64 Virtual,
// IN UINT32 Size,
// IN UINT32 Direction,
// OUT UINT64 PhysicalPtr);
//
// When UNDI needs to perform a DMA transfer it will request a
```



```
// virtual-to-physical mapping using the Map_Mem() service. The
// Virtual parameter contains the virtual address to be mapped.
// The minimum Size of the virtual memory buffer to be mapped.
// Direction is one of the TO_DEVICE, FROM_DEVICE or
// TO_AND_FROM_DEVICE constants defined at the end of this
// section. PhysicalPtr contains the mapped physical address or
// a copy of the Virtual address if no mapping is required.
//
```

```
UINT64 UnMap_Mem;
//
// Un-map previously mapped virtual memory address.
// This field can be set to zero only if the Map_Mem() service
// is also set to zero.
//
// VOID
// UnMap_Mem(
// IN UINT64 UniqueId,
// IN UINT64 Virtual,
// IN UINT32 Size,
// IN UINT32 Direction,
// IN UINT64 PhysicalPtr);
//
// When UNDI is done with the mapped memory, it will use the
// UnMap_Mem() service to release the mapped memory.
//
```

```
UINT64 Sync_Mem;
//
// Synchronise mapped memory.
// This field can be set to zero only if the Map_Mem() service
// is also set to zero.
//
// VOID
// Sync_Mem(
// IN UINT64 UniqueId,
// IN UINT64 Virtual,
// IN UINT32 Size,
// IN UINT32 Direction,
// IN UINT64 PhysicalPtr);
//
// When the virtual and physical buffers need to be
// synchronized, UNDI will call the Sync_Mem() service.
//
```

```
UINT64 UniqueId;
//
```

```
// UNDI will pass this value to each of the callback services.  
// A unique ID number should be generated for each instance of  
// the UNDI driver that will be using these callback services.  
//  
} PXE_CPB_START_31;  
#pragma pack()
```

For the 3.0 S/W UNDI Start command, the CPB structure shown below must be filled in and the CDB must be set to `sizeof(struct s_pxe_cpb_start_30)`.

```

#pragma pack(1)
typedef struct s_pxe_cpb_start_30 {
    UINT64 Delay;
    //
    // Address of the Delay() callback service.
    // This field cannot be set to zero.
    //
    // VOID
    // Delay(
    // IN UINT64 Microseconds);
    //
    // UNDI will never request a delay smaller than 10 microseconds
    // and will always request delays in increments of 10.
    // microseconds The Delay() callback routine must delay between
    // n and n + 10 microseconds before returning control to the
    // UNDI.
    //

    UINT64 Block;
    //
    // Address of the Block() callback service.
    // This field cannot be set to zero.
    //
    // VOID
    // Block(
    // IN UINT32 Enable);
    //
    // UNDI may need to block multithreaded/multiprocessor access
    // to critical code sections when programming or accessing the
    // network device. When UNDI needs a block, it will call the
    // Block()callback service with Enable set to a non-zero value.
    // When UNDI no longer needs the block, it will call Block()
    // with Enable set to zero.
    //

    UINT64 Virt2Phys;
    //
    // Convert a virtual address to a physical address.
    // This field can be set to zero if virtual and physical
    // addresses are identical.
    //
    // VOID
    // Virt2Phys(
    // IN UINT64 Virtual,
    // OUT UINT64 PhysicalPtr);
    //
    // UNDI will pass in a virtual address and a pointer to storage

```

```

// for a physical address. The Virt2Phys() service converts
// the virtual address to a physical address and stores the
// resulting physical address in the supplied buffer. If no
// conversion is needed, the virtual address must be copied
// into the supplied physical address buffer.
//

UINT64 Mem_IO;
//
// Read/Write network device memory and/or I/O register space.
// This field cannot be set to zero.
//
// VOID
// Mem_IO(
// IN  UINT8  AccessType,
// IN  UINT8  Length,
// IN  UINT64 Port,
// IN OUT UINT64 BufferPtr);
//
// UNDI uses the Mem_IO() service to access the network device
// memory and/or I/O registers. The AccessType is one of the
// PXE_IO_XXX or PXE_MEM_XXX constants defined at the end of
// this section. The Length is 1, 2, 4 or 8. The Port number
// is relative to the base memory or I/O address space for this
// device. BufferPtr points to the data to be written to the
// Port or will contain the data that is read from the Port.
//
} PXE_CPB_START_30;
#pragma pack()

#define TO_AND_FROM_DEVICE 0
// Provides both read and write access to system memory by both
// the processor and a bus master. The buffer is coherent from
// both the processor's and the bus master's point of view.

#define FROM_DEVICE 1
// Provides a write operation to system memory by a bus master.

#define TO_DEVICE 2
// Provides a read operation from system memory by a bus master.

```

#### E.4.3.3 Waiting for the Command to Execute

Monitor the upper two bits (14 & 15) in the **CDB.StatFlags** field. Until these bits change to report **PXE\_STATFLAGS\_COMMAND\_COMPLETE** or

**PXE\_STATFLAGS\_COMMAND\_FAILED**, the command has not been executed by the UNDI.

StatFlags	Reason
COMMAND_COMPLETE	Command completed successfully. UNDI is now started.
COMMAND_FAILED	Command failed. StatCode field contains error code.
COMMAND_QUEUED	Command has been queued.
INITIALIZE	Command has been not executed or queued.

#### E.4.3.4 Checking Command Execution Results

After command execution completes, either successfully or not, the **CDB.StatCode** field contains the result of the command execution.

StatCode	Reason
SUCCESS	Command completed successfully. UNDI is now started.
INVALID_CDB	One of the CDB fields was not set correctly.
BUSY	UNDI is already processing commands. Try again later.
QUEUE_FULL	Command queue is full. Try again later.
ALREADY_STARTED	The UNDI is already started.

#### E.4.4 Stop

This command is used to change the UNDI operational state from started to stopped.

##### E.4.4.1 Issuing the Command

To issue a Stop command, create a CDB and fill it in as shows in the table below:

CDB Field	How to initialize the CDB structure for a Stop command
OpCode	<b>PXE_OPCODE_STOP</b>
OpFlags	<b>PXE_OPFLAGS_NOT_USED</b>
CPBsize	<b>PXE_CPBSIZE_NOT_USED</b>
DBsize	<b>PXE_DBSIZE_NOT_USED</b>
CPBaddr	<b>PXE_CPBADDR_NOT_USED</b>
DBaddr	<b>PXE_DBADDR_NOT_USED</b>
StatCode	<b>PXE_STATCODE_INITIALIZE</b>
StatFlags	<b>PXE_STATFLAGS_INITIALIZE</b>
IFnum	A valid interface number from zero to <b>(!PXE.IFcnt   (!PXE.IFcntExt &lt;&lt; 8))</b> .
Control	Set as needed

### E.4.4.2 Waiting for the Command to Execute

Monitor the upper two bits (14 & 15) in the **CDB.StatFlags** field. Until these bits change to report **PXE\_STATFLAGS\_COMMAND\_COMPLETE** or **PXE\_STATFLAGS\_COMMAND\_FAILED**, the command has not been executed by the UNDI.

StatFlags	Reason
COMMAND_COMPLETE	Command completed successfully. UNDI is now stopped.
COMMAND_FAILED	Command failed. StatCode field contains error code.
COMMAND_QUEUED	Command has been queued.
INITIALIZE	Command has not been executed or queued.

### E.4.4.3 Checking Command Execution Results

After command execution completes, either successfully or not, the **CDB.StatCode** field contains the result of the command execution.

StatCode	Reason
SUCCESS	Command completed successfully. UNDI is now stopped.
INVALID_CDB	One of the CDB fields was not set correctly.
BUSY	UNDI is already processing commands. Try again later.
QUEUE_FULL	Command queue is full. Try again later.
NOT_STARTED	The UNDI is not started.
NOT_SHUTDOWN	The UNDI is initialized and must be shutdown before it can be stopped.

### E.4.5 Get Init Info

This command is used to retrieve initialization information that is needed by drivers and applications to initialize UNDI.

#### E.4.5.1 Issuing the Command

To issue a Get Init Info command, create a CDB and fill it in as shows in the table below:

CDB Field	How to initialize the CDB structure for a Get Init Info command
OpCode	<b>PXE_OPCODE_GET_INIT_INFO</b>
OpFlags	<b>PXE_OPFLAGS_NOT_USED</b>
CPBsize	<b>PXE_CPBSIZE_NOT_USED</b>
DBsize	<b>sizeof(PXE_DB_INIT_INFO)</b>
CPBaddr	<b>PXE_CPBADDR_NOT_USED</b>
DBaddr	Address of a <b>PXE_DB_INIT_INFO</b> structure.
StatCode	<b>PXE_STATCODE_INITIALIZE</b>
StatFlags	<b>PXE_STATFLAGS_INITIALIZE</b>

IFnum	A valid interface number from zero to <b>(!PXE.IFcnt   (!PXE.IFcntExt &lt;&lt; 8))</b> .
Control	Set as needed.

### E.4.5.2 Waiting for the Command to Execute

Monitor the upper two bits (14 & 15) in the **CDB.StatFlags** field. Until these bits change to report **PXE\_STATFLAGS\_COMMAND\_COMPLETE** or **PXE\_STATFLAGS\_COMMAND\_FAILED**, the command has not been executed by the UNDI.

StatFlags	Reason
COMMAND_COMPLETE	Command completed successfully. DB can be used.
COMMAND_FAILED	Command failed. StatCode field contains error code.
COMMAND_QUEUED	Command has been queued.
INITIALIZE	Command has been not executed or queued.

### E.4.5.3 Checking Command Execution Results

After command execution completes, either successfully or not, the **CDB.StatCode** field contains the result of the command execution.

StatCode	Reason
SUCCESS	Command completed successfully. DB can be used.
INVALID_CDB	One of the CDB fields was not set correctly.
BUSY	UNDI is already processing commands. Try again later.
QUEUE_FULL	Command queue is full. Try again later.
NOT_STARTED	The UNDI is not started.

### E.4.5.4 StatFlags

To determine if cable detection is supported by this UNDI/NIC, use these macros with the value returned in the CDB.StatFlags field:

```
PXE_STATFLAGS_CABLE_DETECT_MASK
PXE_STATFLAGS_CABLE_DETECT_NOT_SUPPORTED
PXE_STATFLAGS_CABLE_DETECT_SUPPORTED
PXE_STATFLAGS_GET_STATUS_NO_MEDIA_MASK
PXE_STATFLAGS_GET_STATUS_NO_MEDIA_NOT_SUPPORTED
PXE_STATFLAGS_GET_STATUS_NO_MEDIA_SUPPORTED
```

### E.4.5.5 DB

```
#pragma pack(1)
typedef struct s_pxe_db_get_init_info {

    // Minimum length of locked memory buffer that must be given to
    // the Initialize command. Giving UNDI more memory will
    // generally give better performance.
```

```
// If MemoryRequired is zero, the UNDI does not need and will
// not use system memory to receive and transmit packets.
```

```
PXE_UINT32 MemoryRequired;
```

```
// Maximum frame data length for Tx/Rx excluding the media
// header.
```

```
//
```

```
PXE_UINT32 FrameDataLen;
```

```
// Supported link speeds are in units of mega bits. Common
// ethernet values are 10, 100 and 1000. Unused LinkSpeeds[]
// entries are zero filled.
```

```
PXE_UINT32 LinkSpeeds[4];
```

```
// Number of nonvolatile storage items.
```

```
PXE_UINT32 NvCount;
```

```
// Width of nonvolatile storage item in bytes. 0, 1, 2 or 4
```

```
PXE_UINT16 NvWidth;
```

```
// Media header length. This is the typical media header
// length for this UNDI. This information is needed when
// allocating receive and transmit buffers.
```

```
PXE_UINT16 MediaHeaderLen;
```

```
// Number of bytes in the NIC hardware (MAC) address.
```

```
PXE_UINT16 HWaddrLen;
```

```
// Maximum number of multicast MAC addresses in the multicast
// MAC address filter list.
```

```
PXE_UINT16 MCastFilterCnt;
```

```
// Default number and size of transmit and receive buffers that
// will be allocated by the UNDI. If MemoryRequired is
// nonzero, this allocation will come out of the memory buffer
// given to the Initialize command. If MemoryRequired is zero,
// this allocation will come out of memory on the NIC.
```

```
PXE_UINT16 TxBufCnt;
```

```
PXE_UINT16 TxBufSize;
```



```

PXE_UINT16 RxBufCnt;
PXE_UINT16 RxBufSize;

// Hardware interface types defined in the Assigned Numbers RFC
// and used in DHCP and ARP packets.
// See the PXE_IFTYPE typedef and PXE_IFTYPE_xxx macros.

PXE_UINT8 IfType;

// Supported duplex options. This can be one or a combination
// of more than one constants defined as PXE_DUPLEX_xxxxx
// below. This value indicates the ability of UNDI to
// change/control the duplex modes of the NIC.

PXE_UINT8 SupportedDuplexModes;

// Supported loopback options. This field can be one or a
// combination of more than one constants defined as
// PXE_LOOPBACK_xxxxx #defines below. This value indicates
// the ability of UNDI to change/control the loopback modes
// of the NIC

PXE_UINT8 SupportedLoopBackModes;
} PXE_DB_GET_INIT_INFO;
#pragma pack()

#define PXE_MAX_TXRX_UNIT_ETHER 1500
#define PXE_HWADDR_LEN_ETHER 0x0006

#define PXE_DUPLEX_DEFAULT 0
#define PXE_DUPLEX_ENABLE_FULL_SUPPORTED 1
#define PXE_DUPLEX_FORCE_FULL_SUPPORTED 2

#define PXE_LOOPBACK_INTERNAL_SUPPORTED 1
#define PXE_LOOPBACK_EXTERNAL_SUPPORTED 2

```

## E.4.6 Get Config Info

This command is used to retrieve configuration information about the NIC being controlled by the UNDI.

### E.4.6.1 Issuing the Command

To issue a Get Config Info command, create a CDB and fill it in as shown in the table below:

CDB Field	How to initialize the CDB structure for a Get Config Info command
OpCode	PXE_OPCODE_GET_CONFIG_INFO

CDB Field	How to initialize the CDB structure for a Get Config Info command
OpFlags	PXE_OPFLAGS_NOT_USED
CPBsize	PXE_CPBSIZE_NOT_USED
DBsize	sizeof(PXE_DB_CONFIG_INFO)
CPBaddr	PXE_CPBADDR_NOT_USED
DBaddr	Address of a <b>PXE_DB_CONFIG_INFO</b> structure
StatCode	PXE_STATCODE_INITIALIZE
StatFlags	PXE_STATFLAGS_INITIALIZE
IFnum	A valid interface number from zero to <b>(!PXE.IFcnt   (!PXE.IFcntExt &lt;&lt; 8))</b> .
Control	Set as needed

#### E.4.6.2 Waiting for the Command to Execute

Monitor the upper two bits (14 & 15) in the **CDB.StatFlags** field. Until these bits change to report **PXE\_STATFLAGS\_COMMAND\_COMPLETE** or **PXE\_STATFLAGS\_COMMAND\_FAILED**, the command has not been executed by the UNDI.

StatFlags	Reason
COMMAND_COMPLETE	Command completed successfully. DB has been written.
COMMAND_FAILED	Command failed. StatCode field contains error code.
COMMAND_QUEUED	Command has been queued.
INITIALIZE	Command has been not executed or queued.

#### E.4.6.3 Checking Command Execution Results

After command execution completes, either successfully or not, the **CDB.StatCode** field contains the result of the command execution.

StatCode	Reason
SUCCESS	Command completed successfully. DB has been written.
INVALID_CDB	One of the CDB fields was not set correctly.
BUSY	UNDI is already processing commands. Try again later.
QUEUE_FULL	Command queue is full. Try again later.
NOT_STARTED	The UNDI is not started.

#### E.4.6.4 DB

```
#pragma pack(1)
typedef struct s_pxe_pci_config_info {

    // This is the flag field for the PXE_DB_GET_CONFIG_INFO union.
    // For PCI bus devices, this field is set to PXE_BUSTYPE_PCI.
```

```

PXE_UINT32 BusType;

// This identifies the PCI network device that this UNDI
// interface is bound to.

PXE_UINT16 Bus;
PXE_UINT8 Device;
PXE_UINT8 Function;

// This is a copy of the PCI configuration space for this
// network device.

union {
    PXE_UINT8 Byte[256];
    PXE_UINT16 Word[128];
    PXE_UINT32 Dword[64];
} Config;
} PXE_PCI_CONFIG_INFO;
#pragma pack()
#pragma pack(1)
typedef struct s_pxe_pcc_config_info {

// This is the flag field for the PXE_DB_GET_CONFIG_INFO union.
// For PCC bus devices, this field is set to PXE_BUSTYPE_PCC.

PXE_UINT32 BusType;

// This identifies the PCC network device that this UNDI
// interface is bound to.

PXE_UINT16 Bus;
PXE_UINT8 Device;
PXE_UINT8 Function;

// This is a copy of the PCC configuration space for this
// network device.

union {
    PXE_UINT8 Byte[256];
    PXE_UINT16 Word[128];
    PXE_UINT32 Dword[64];
} Config;
} PXE_PCC_CONFIG_INFO;
#pragma pack()

#pragma pack(1)
typedef union u_pxe_db_get_config_info {

```

```
PXE_PCI_CONFIG_INFO pci;
PXE_PCC_CONFIG_INFO pcc;
} PXE_DB_GET_CONFIG_INFO;
#pragma pack()
```

### E.4.7 Initialize

This command resets the network adapter and initializes UNDI using the parameters supplied in the CPB. The Initialize command must be issued before the network adapter can be setup to transmit and receive packets. This command will not enable the receive unit or external interrupts.

Once the memory requirements of the UNDI are obtained by using the Get Init Info command, a block of kernel (nonswappable) memory may need to be allocated by the protocol driver. The address of this kernel memory must be passed to UNDI using the Initialize command CPB. This memory is used for transmit and receive buffers and internal processing.

Initializing the network device will take up to four seconds for most network devices and in some extreme cases (usually poor cables) up to twenty seconds. Control will not be returned to the caller and the **COMMAND\_COMPLETE** status flag will not be set until the NIC is ready to transmit.

#### E.4.7.1 Issuing the Command

To issue an Initialize command, create a CDB and fill it in as shows in the table below:

CDB Field	How to initialize the CDB structure for an Initialize command
OpCode	PXE_OPCODE_INITIALIZE
OpFlags	Set as needed.
CPBsize	sizeof(PXE_CPB_INITIALIZE)
DBsize	sizeof(PXE_DB_INITIALIZE)
CPBaddr	Address of a <b>PXE_CPB_INITIALIZE</b> structure.
Dbaddr	Address of a <b>PXE_DB_INITIALIZE</b> structure.
StatCode	PXE_STATCODE_INITIALIZE
StatFlags	PXE_STATFLAGS_INITIALIZE
Ifnum	A valid interface number from zero to <b>(!PXE.IFcnt   (!PXE.IFcntExt &lt;&lt; 8))</b> .
Control	Set as needed.

#### E.4.7.2 OpFlags

Cable detection can be enabled or disabled by setting one of the following OpFlags:

```
PXE_OPFLAGS_INITIALIZE_CABLE_DETECT
PXE_OPFLAGS_INITIALIZE_DO_NOT_DETECT_CABLE
```

### E.4.7.3 Preparing the CPB

If the **MemoryRequired** field returned in the **PXE\_DB\_GET\_INIT\_INFO** structure is zero, the Initialize command does not need to be given a memory buffer or even a CPB structure. If the **MemoryRequired** field is nonzero, the Initialize command does need a memory buffer.

```
#pragma pack(1)
typedef struct s_pxe_cpb_initialize {

    // Address of first (lowest) byte of the memory buffer.
    // This buffer must be in contiguous physical memory and cannot
    // be swapped out. The UNDI will be using this for transmit
    // and receive buffering. This address must be a processor-
    // based address for S/W UNDI and a device-based address for
    // H/W UNDI.

    PXE_UINT64 MemoryAddr;

    // MemoryLength must be greater than or equal to MemoryRequired
    // returned by the Get Init Info command.

    PXE_UINT32 MemoryLength;

    // Desired link speed in Mbit/sec. Common ethernet values are
    // 10, 100 and 1000. Setting a value of zero will auto-detect
    // and/or use the default link speed (operation depends on
    // UNDI/NIC functionality).

    PXE_UINT32 LinkSpeed;

    // Suggested number and size of receive and transmit buffers to
    // allocate. If MemoryAddr and MemoryLength are nonzero, this
    // allocation comes out of the supplied memory buffer. If
    // MemoryAddr and MemoryLength are zero, this allocation comes
    // out of memory on the NIC.

    // If these fields are set to zero, the UNDI will allocate
    // buffer counts and sizes as it sees fit.

    PXE_UINT16 TxBufCnt;
    PXE_UINT16 TxBufSize;
    PXE_UINT16 RxBufCnt;
    PXE_UINT16 RxBufSize;

    // The following configuration parameters are optional and must
    // be zero to use the default values.
    // The possible values for these parameters are defined below.

    PXE_UINT8 DuplexMode;
```

```

PXE_UINT8 LoopBackMode;
} PXE_CPB_INITIALIZE;
#pragma pack()

#define PXE_DUPLEX_AUTO_DETECT 0x00
#define PXE_FORCE_FULL_DUPLEX 0x01

#define PXE_FORCE_HALF_DUPLEX 0x02

#define PXE_LOOPBACK_NORMAL 0
#define PXE_LOOPBACK_INTERNAL 1
#define PXE_LOOPBACK_EXTERNAL 2
    
```

#### E.4.7.4 Waiting for the Command to Execute

Monitor the upper two bits (14 & 15) in the **CDB.StatFlags** field. Until these bits change to report **PXE\_STATFLAGS\_COMMAND\_COMPLETE** or **PXE\_STATFLAGS\_COMMAND\_FAILED**, the command has not been executed by the UNDI.

StatFlags	Reason
COMMAND_COMPLETE	Command completed successfully. UNDI and network device is now initialized. DB has been written.
COMMAND_FAILED	Command failed. StatCode field contains error code.
COMMAND_QUEUED	Command has been queued.
INITIALIZE	Command has been not executed or queued.

#### E.4.7.5 Checking Command Execution Results

After command execution completes, either successfully or not, the **CDB.StatCode** field contains the result of the command execution.

StatCode	Reason
SUCCESS	Command completed successfully. UNDI and network device is now initialized. DB has been written. Check StatFlags.
INVALID_CDB	One of the CDB fields was not set correctly.
INVALID_CPB	One of the CPB fields was not set correctly.
BUSY	UNDI is already processing commands. Try again later.
QUEUE_FULL	Command queue is full. Try again later.
NOT_STARTED	The UNDI is not started.
ALREADY_INITIALIZED	The UNDI is already initialized.
DEVICE_FAILURE	The network device could not be initialized.
NVDATA_FAILURE	The nonvolatile storage could not be read.

### E.4.7.6 StatFlags

Check the StatFlags to see if there is an active connection to this network device. If the no media StatFlag is set, the UNDI and network device are still initialized.

**PXE\_STATFLAGS\_INITIALIZED\_NO\_MEDIA**

### E.4.7.7 Before Using the DB

```
#pragma pack(1)
typedef struct s_pxe_db_initialize {

    // Actual amount of memory used from the supplied memory
    // buffer. This may be less than the amount of memory
    // supplied and may be zero if the UNDI and network device
    // do not use external memory buffers. Memory used by the
    // UNDI and network device is allocated from the lowest
    // memory buffer address.

    PXE_UINT32 MemoryUsed;

    // Actual number and size of receive and transmit buffers that
    // were allocated.

    PXE_UINT16 TxBufCnt;
    PXE_UINT16 TxBufSize;
    PXE_UINT16 RxBufCnt;
    PXE_UINT16 RxBufSize
} PXE_DB_INITIALIZE;
#pragma pack(0)
```

### E.4.8 Reset

This command resets the network adapter and reinitializes the UNDI with the same parameters provided in the Initialize command. The transmit and receive queues are emptied and any pending interrupts are cleared. Depending on the state of the OpFlags, the receive filters and external interrupt enables may also be reset.

Resetting the network device may take up to four seconds and in some extreme cases (usually poor cables) up to twenty seconds. Control will not be returned to the caller and the **COMMAND\_COMPLETE** status flag will not be set until the NIC is ready to transmit.

#### E.4.8.1 Issuing the Command

To issue a Reset command, create a CDB and fill it in as shows in the table below:

CDB Field	How to initialize the CDB structure for a Reset command
OpCode	PXE_OPCODE_RESET
OpFlags	Set as needed.
CPBsize	PXE_CPBSIZE_NOT_USED
DBsize	PXE_DBSIZE_NOT_USED
CPBaddr	PXE_CPBSIZE_NOT_USED

DBaddr	PXE_DBSIZE_NOT_USED
StatCode	PXE_STATCODE_INITIALIZE
StatFlags	PXE_STATFLAGS_INITIALIZE
IFnum	A valid interface number from zero to $(!PXE.IFcnt \mid (!PXE.IFcntExt \ll 8))$ .
Control	Set as needed.

### E.4.8.2 OpFlags

Normally the settings of the receive filters and external interrupt enables are unchanged by the Reset command. These two OpFlags will alter the operation of the Reset command.

**PXE\_OPFLAGS\_RESET\_DISABLE\_INTERRUPTS**  
**PXE\_OPFLAGS\_RESET\_DISABLE\_FILTERS**

### E.4.8.3 Waiting for the Command to Execute

Monitor the upper two bits (14 & 15) in the **CDB.StatFlags** field. Until these bits change to report **PXE\_STATFLAGS\_COMMAND\_COMPLETE** or **PXE\_STATFLAGS\_COMMAND\_FAILED**, the command has not been executed by the UNDI.

StatFlags	Reason
COMMAND_COMPLETE	Command completed successfully. UNDI and network device have been reset. Check StatFlags.
COMMAND_FAILED	Command failed. StatCode field contains error code.
COMMAND_QUEUED	Command has been queued.
INITIALIZE	Command has been not executed or queued.

### E.4.8.4 Checking Command Execution Results

After command execution completes, either successfully or not, the **CDB.StatCode** field contains the result of the command execution.

StatCode	Reason
SUCCESS	Command completed successfully. UNDI and network device have been reset. Check StatFlags.
INVALID_CDB	One of the CDB fields was not set correctly.
BUSY	UNDI is already processing commands. Try again later.
QUEUE_FULL	Command queue is full. Try again later.
NOT_STARTED	The UNDI is not started.
NOT_INITIALIZED	The UNDI is not initialized.
DEVICE_FAILURE	The network device could not be initialized.
NVDATA_FAILURE	The nonvolatile storage is not valid.



### E.4.8.5 StatFlags

Check the StatFlags to see if there is an active connection to this network device. If the no media StatFlag is set, the UNDI and network device are still reset.

**PXE\_STATFLAGS\_RESET\_NO\_MEDIA**

### E.4.9 Shutdown

The Shutdown command resets the network adapter and leaves it in a safe state for another driver to initialize. Any pending transmits or receives are lost. Receive filters and external interrupt enables are reset (disabled). The memory buffer assigned in the Initialize command can be released or reassigned.

Once UNDI has been shutdown, it can then be stopped or initialized again. The Shutdown command changes the UNDI operational state from initialized to started.

#### E.4.9.1 Issuing the Command

To issue a Shutdown command, create a CDB and fill it in as shown in the table below:

CDB Field	How to initialize the CDB structure for a Shutdown command
OpCode	PXE_OPCODE_SHUTDOWN
OpFlags	PXE_OPFLAGS_NOT_USED
CPBsize	PXE_CPBSIZE_NOT_USED
DBsize	PXE_DBSIZE_NOT_USED
CPBaddr	PXE_CPBSIZE_NOT_USED
DBaddr	PXE_DBSIZE_NOT_USED
StatCode	PXE_STATCODE_INITIALIZE
StatFlags	PXE_STATFLAGS_INITIALIZE
IFnum	A valid interface number from zero to <b>(!PXE.IFcnt   (!PXE.IFcntExt &lt;&lt; 8))</b> .
Control	Set as needed.

#### E.4.9.2 Waiting for the Command to Execute

Monitor the upper two bits (14 & 15) in the **CDB.StatFlags** field. Until these bits change to report **PXE\_STATFLAGS\_COMMAND\_COMPLETE** or **PXE\_STATFLAGS\_COMMAND\_FAILED**, the command has not been executed by the UNDI.

StatFlags	Reason
COMMAND_COMPLETE	Command completed successfully. UNDI and network device are shutdown.
COMMAND_FAILED	Command failed. StatCode field contains error code.
COMMAND_QUEUED	Command has been queued.
INITIALIZE	Command has been not executed or queued.

### E.4.9.3 Checking Command Execution Results

After command execution completes, either successfully or not, the **CDB.StatCode** field contains the result of the command execution.

StatCode	Reason
SUCCESS	Command completed successfully. UNDI and network device are shutdown.
INVALID_CDB	One of the CDB fields was not set correctly.
BUSY	UNDI is already processing commands. Try again later.
QUEUE_FULL	Command queue is full. Try again later.
NOT_STARTED	The UNDI is not started.
NOT_INITIALIZED	The UNDI is not initialized.

### E.4.10 Interrupt Enables

The Interrupt Enables command can be used to read and/or change the current external interrupt enable settings. Disabling an external interrupt enable prevents an external (hardware) interrupt from being signaled by the network device, internally the interrupt events can still be polled by using the Get Status command.

#### E.4.10.1 Issuing the Command

To issue an Interrupt Enables command, create a CDB and fill it in as shows in the table below:

CDB Field	How to initialize the CDB structure for an Interrupt Enables command
OpCode	PXE_OPCODE_INTERRUPT_ENABLES
OpFlags	Set as needed.
CPBsize	PXE_CPBSIZE_NOT_USED
DBsize	PXE_DBSIZE_NOT_USED
CPBaddr	PXE_CPBADDR_NOT_USED
DBaddr	PXE_DBADDR_NOT_USED
StatCode	PXE_STATCODE_INITIALIZE
StatFlags	PXE_STATFLAGS_INITIALIZE
IFnum	A valid interface number from zero to <b>(!PXE.IFcnt   (!PXE.IFcntExt &lt;&lt; 8))</b> .
Control	Set as needed.

#### E.4.10.2 OpFlags

To read the current external interrupt enables settings set **CDB.OpFlags** to:

**PXE\_OPFLAGS\_INTERRUPT\_READ**

To enable or disable external interrupts set one of these OpFlags:

**PXE\_OPFLAGS\_INTERRUPT\_DISABLE**  
**PXE\_OPFLAGS\_INTERRUPT\_ENABLE**

When enabling or disabling interrupt settings, the following additional OpFlag bits are used to specify which types of external interrupts are to be enabled or disabled:

**PXE\_OPFLAGS\_INTERRUPT\_RECEIVE**  
**PXE\_OPFLAGS\_INTERRUPT\_TRANSMIT**  
**PXE\_OPFLAGS\_INTERRUPT\_COMMAND**  
**PXE\_OPFLAGS\_INTERRUPT\_SOFTWARE**

Setting **PXE\_OPFLAGS\_INTERRUPT\_SOFTWARE** does not enable an external interrupt type, it generates an external interrupt.

### E.4.10.3 Waiting for the Command to Execute

Monitor the upper two bits (14 & 15) in the **CDB.StatFlags** field. Until these bits change to report **PXE\_STATFLAGS\_COMMAND\_COMPLETE** or **PXE\_STATFLAGS\_COMMAND\_FAILED**, the command has not been executed by the UNDI.

StatFlags	Reason
COMMAND_COMPLETE	Command completed successfully. Check StatFlags.
COMMAND_FAILED	Command failed. StatCode field contains error code.
COMMAND_QUEUED	Command has been queued.
INITIALIZE	Command has been not executed or queued.

### E.4.10.4 Checking Command Execution Results

After command execution completes, either successfully or not, the **CDB.StatCode** field contains the result of the command execution.

StatCode	Reason
SUCCESS	Command completed successfully. Check StatFlags.
INVALID_CDB	One of the CDB fields was not set correctly.
BUSY	UNDI is already processing commands. Try again later.
QUEUE_FULL	Command queue is full. Try again later.
NOT_STARTED	The UNDI is not started.
NOT_INITIALIZED	The UNDI is not initialized.

### E.4.10.5 StatFlags

If the command was successful, the **CDB.StatFlags** field reports which external interrupt enable types are currently set. Possible **CDB.StatFlags** bit settings are:

- **PXE\_STATFLAGS\_INTERRUPT\_RECEIVE**
- **PXE\_STATFLAGS\_INTERRUPT\_TRANSMIT**
- **PXE\_STATFLAGS\_INTERRUPT\_COMMAND**

The bits set in **CDB.StatFlags** may be different than those that were requested in **CDB.OpFlags**. For example: If transmit and receive share an external interrupt line, setting either the transmit or receive interrupt will always enable both transmit and receive interrupts. In this case both transmit and receive interrupts will be reported in **CDB.StatFlags**. Always expect to get more than you ask for!

## E.4.11 Receive Filters

This command is used to read and change receive filters and, if supported, read and change the multicast MAC address filter list. Control will not be returned to the caller and the **COMMAND\_COMPLETE** status flag will not be set until the NIC is ready to receive.

### E.4.11.1 Issuing the Command

To issue a Receive Filters command, create a CDB and fill it in as shows in the table below:

CDB Field	How to initialize the CDB structure for a Receive Filters command
OpCode	PXE_OPCODE_RECEIVE_FILTERS
OpFlags	Set as needed.
CPBsize	sizeof(PXE_CPB_RECEIVE_FILTERS)
DBsize	sizeof(PXE_DB_RECEIVE_FILTERS)
CPBaddr	Address of <b>PXE_CPB_RECEIVE_FILTERS</b> structure.
DBaddr	Address of <b>PXE_DB_RECEIVE_FILTERS</b> structure.
StatCode	PXE_STATCODE_INITIALIZE
StatFlags	PXE_STATFLAGS_INITIALIZE
IFnum	A valid interface number from zero to <b>(!PXE.IFcnt   (!PXE.IFcntExt &lt;&lt; 8))</b> .
Control	Set as needed.

### E.4.11.2 OpFlags

To read the current receive filter settings set the **CDB.OpFlags** field to:

- **PXE\_OPFLAGS\_RECEIVE\_FILTER\_READ**

To change the current receive filter settings set one of these OpFlag bits:

- **PXE\_OPFLAGS\_RECEIVE\_FILTER\_ENABLE**
- **PXE\_OPFLAGS\_RECEIVE\_FILTER\_DISABLE**

When changing the receive filter settings, at least one of the OpFlag bits in this list must be selected:

- **PXE\_OPFLAGS\_RECEIVE\_FILTER\_UNICAST**
- **PXE\_OPFLAGS\_RECEIVE\_FILTER\_BROADCAST**
- **PXE\_OPFLAGS\_RECEIVE\_FILTER\_FILTERED\_MULTICAST**
- **PXE\_OPFLAGS\_RECEIVE\_FILTER\_PROMISCUOUS**
- **PXE\_OPFLAGS\_RECEIVE\_FILTER\_ALL\_MULTICAST**

To clear the contents of the multicast MAC address filter list, set this OpFlag:

- **PXE\_OPFLAGS\_RECEIVE\_FILTER\_RESET\_MCAST\_LIST**

### E.4.11.3 Preparing the CPB

The receive filter CPB is used to change the contents multicast MAC address filter list. To leave the multicast MAC address filter list unchanged, set the **CDB.CPBsize** field to **PXE\_CPBSIZE\_NOT\_USED** and **CDB.CPBaddr** to **PXE\_CPBADDR\_NOT\_USED**.

To change the multicast MAC address filter list, set **CDB.CPBsize** to the size, in bytes, of the multicast MAC address filter list and set **CDB.CPBaddr** to the address of the first entry in the multicast MAC address filter list.

```
typedef struct s_pxe_cpb_receive_filters {

    // List of multicast MAC addresses. This list, if present,
    // will replace the existing multicast MAC address filter list.

    PXE_MAC_ADDR MCastList[n];
} PXE_CPB_RECEIVE_FILTERS;
```

### E.4.11.4 Waiting for the Command to Execute

Monitor the upper two bits (14 & 15) in the **CDB.StatFlags** field. Until these bits change to report **PXE\_STATFLAGS\_COMMAND\_COMPLETE** or **PXE\_STATFLAGS\_COMMAND\_FAILED**, the command has not been executed by the UNDI.

StatFlags	Reason
COMMAND_COMPLETE	Command completed successfully. Check StatFlags. DB is written.
COMMAND_FAILED	Command failed. StatCode field contains error code.
COMMAND_QUEUED	Command has been queued.
INITIALIZE	Command has been not executed or queued.

### E.4.11.5 Checking Command Execution Results

After command execution completes, either successfully or not, the **CDB.StatCode** field contains the result of the command execution.

StatCode	Reason
SUCCESS	Command completed successfully. Check StatFlags. DB is written.
INVALID_CDB	One of the CDB fields was not set correctly.
INVALID_CPB	One of the CPB fields was not set correctly.
BUSY	UNDI is already processing commands. Try again later.
QUEUE_FULL	Command queue is full. Try again later.
NOT_STARTED	The UNDI is not started.
NOT_INITIALIZED	The UNDI is not initialized.

### E.4.11.6 StatFlags

The receive filter settings in CDB.StatFlags are:

- **PXE\_STATFLAGS\_RECEIVE\_FILTER\_UNICAST**
- **PXE\_STATFLAGS\_RECEIVE\_FILTER\_BROADCAST**
- **PXE\_STATFLAGS\_RECEIVE\_FILTER\_FILTERED\_MULTICAST**
- **PXE\_STATFLAGS\_RECEIVE\_FILTER\_PROMISCUOUS**
- **PXE\_STATFLAGS\_RECEIVE\_FILTER\_ALL\_MULTICAST**

Unsupported receive filter settings in OpFlags are promoted to the next more liberal receive filter setting. For example: If broadcast or filtered multicast are requested and are not supported by the network device, but promiscuous is; the promiscuous status flag will be set.

### E.4.11.7 DB

The DB is used to read the current multicast MAC address filter list. The CDB.DBsize and CDB.DBaddr fields can be set to PXE\_DBSIZE\_NOT\_USED and PXE\_DBADDR\_NOT\_USED if the multicast MAC address filter list does not need to be read. When reading the multicast MAC address filter list extra entries in the DB will be filled with zero.

```
typedef struct s_pxe_db_receive_filters {

    // Filtered multicast MAC address list.

    PXE_MAC_ADDR MCastList[n];
    } PXE_DB_RECEIVE_FILTERS;
```

### E.4.12 Station Address

This command is used to get current station and broadcast MAC addresses and, if supported, to change the current station MAC address.

#### E.4.12.1 Issuing the Command

To issue a Station Address command, create a CDB and fill it in as shows in the table below:

CDB Field	How to initialize the CDB structure for a Station Address command
OpCode	PXE_OPCODE_STATION_ADDRESS
OpFlags	Set as needed.
CPBsize	sizeof(PXE_CPB_STATION_ADDRESS)
DBsize	sizeof(PXE_DB_STATION_ADDRESS)
CPBaddr	Address of <b>PXE_CPB_STATION_ADDRESS</b> structure.
DBaddr	Address of <b>PXE_DB_STATION_ADDRESS</b> structure.
StatCode	PXE_STATCODE_INITIALIZE
StatFlags	PXE_STATFLAGS_INITIALIZE

IFnum	A valid interface number from zero to <b>(!PXE.IFcnt   (!PXE.IFcntExt &lt;&lt; 8)).</b>
Control	Set as needed.

### E.4.12.2 OpFlags

To read current station and broadcast MAC addresses set the OpFlags field to:

- **PXE\_OPFLAGS\_STATION\_ADDRESS\_READ**

To change the current station to the address given in the CPB set the OpFlags field to:

- **PXE\_OPFLAGS\_STATION\_ADDRESS\_WRITE**

To reset the current station address back to the power on default, set the OpFlags field to:

- **PXE\_OPFLAGS\_STATION\_ADDRESS\_RESET**

### E.4.12.3 Preparing the CPB

To change the current station MAC address the **CDB.CPBsize** and **CDB.CPBaddr** fields must be set.

```
typedef struct s_pxe_cpb_station_address {

    // If supplied and supported, the current station MAC address
    // will be changed.

    PXE_MAC_ADDR StationAddr;
} PXE_CPB_STATION_ADDRESS;
```

### E.4.12.4 Waiting for the Command to Execute

Monitor the upper two bits (14 & 15) in the **CDB.StatFlags** field. Until these bits change to report **PXE\_STATFLAGS\_COMMAND\_COMPLETE** or **PXE\_STATFLAGS\_COMMAND\_FAILED**, the command has not been executed by the UNDI.

StatFlags	Reason
COMMAND_COMPLETE	Command completed successfully. DB is written.
COMMAND_FAILED	Command failed. StatCode field contains error code.
COMMAND_QUEUED	Command has been queued.
INITIALIZE	Command has been not executed or queued.

### E.4.12.5 Checking Command Execution Results

After command execution completes, either successfully or not, the **CDB.StatCode** field contains the result of the command execution.

StatCode	Reason
SUCCESS	Command completed successfully.

INVALID_CDB	One of the CDB fields was not set correctly.
INVALID_CPB	One of the CPB fields was not set correctly.
BUSY	UNDI is already processing commands. Try again later.
QUEUE_FULL	Command queue is full. Try again later.
NOT_STARTED	The UNDI is not started.
NOT_INITIALIZED	The UNDI is not initialized.
UNSUPPORTED	The requested operation is not supported.

### E.4.12.6 Before Using the DB

The DB is used to read the current station, broadcast and permanent station MAC addresses. The **CDB.DBsize** and **CDB.DBaddr** fields can be set to **PXE\_DBSIZE\_NOT\_USED** and **PXE\_DBADDR\_NOT\_USED** if these addresses do not need to be read.

```
typedef struct s_pxe_db_station_address {

    // Current station MAC address.
    PXE_MAC_ADDR StationAddr;

    // Station broadcast MAC address.
    PXE_MAC_ADDR BroadcastAddr;

    // Permanent station MAC address.
    PXE_MAC_ADDR PermanentAddr;
} PXE_DB_STATION_ADDRESS;
```

### E.4.13 Statistics

This command is used to read and clear the NIC traffic statistics. Before using this command check to see if statistics is supported in the **!PXE.Implementation** flags.

#### E.4.13.1 Issuing the Command

To issue a Statistics command, create a CDB and fill it in as shown in the table below:

CDB Field	How to initialize the CDB structure for a Statistics command
OpCode	PXE_OPCODE_STATISTICS
OpFlags	Set as needed.
CPBsize	PXE_CPBSIZE_NOT_USED
DBsize	sizeof(PXE_DB_STATISTICS)
CPBaddr	PXE_CPBADDR_NOT_USED
DBaddr	Address of <b>PXE_DB_STATISTICS</b> structure.
StatCode	PXE_STATCODE_INITIALIZE
StatFlags	PXE_STATFLAGS_INITIALIZE
IFnum	A valid interface number from zero to <b>(!PXE.IFcnt   (!PXE.IFcntExt &lt;&lt; 8))</b> .



Control	Set as needed.
---------	----------------

### E.4.13.2 OpFlags

To read the current statistics counters set the OpFlags field to:

**PXE\_OPFLAGS\_STATISTICS\_READ**

To reset the current statistics counters set the OpFlags field to:

**PXE\_OPFLAGS\_STATISTICS\_RESET**

### E.4.13.3 Waiting for the Command to Execute

Monitor the upper two bits (14 & 15) in the **CDB.StatFlags** field. Until these bits change to report **PXE\_STATFLAGS\_COMMAND\_COMPLETE** or **PXE\_STATFLAGS\_COMMAND\_FAILED**, the command has not been executed by the UNDI.

StatFlags	Reason
COMMAND_COMPLETE	Command completed successfully. DB is written.
COMMAND_FAILED	Command failed. StatCode field contains error code.
COMMAND_QUEUED	Command has been queued.
INITIALIZE	Command has been not executed or queued.

### E.4.13.4 Checking Command Execution Results

After command execution completes, either successfully or not, the **CDB.StatCode** field contains the result of the command execution.

StatCode	Reason
SUCCESS	Command completed successfully. DB is written.
INVALID_CDB	One of the CDB fields was not set correctly.
BUSY	UNDI is already processing commands. Try again later.
QUEUE_FULL	Command queue is full. Try again later.
NOT_STARTED	The UNDI is not started.
NOT_INITIALIZED	The UNDI is not initialized.
UNSUPPORTED	This command is not supported.

### E.4.13.5 DB

Unsupported statistics counters will be zero filled by UNDI.

```
typedef struct s_pxe_db_statistics {
```

```
// Bit field identifying what statistic data is collected by  
// the UNDI/NIC.  
// If bit 0x00 is set, Data[0x00] is collected.  
// If bit 0x01 is set, Data[0x01] is collected.  
// If bit 0x20 is set, Data[0x20] is collected.  
// If bit 0x21 is set, Data[0x21] is collected.
```

```
// Etc.
PXE_UINT64 Supported;

// Statistic data.

PXE_UINT64 Data[64];
} PXE_DB_STATISTICS;

// Total number of frames received. Includes frames with errors
// and dropped frames.
#define PXE_STATISTICS_RX_TOTAL_FRAMES 0x00

// Number of valid frames received and copied into receive
// buffers.
#define PXE_STATISTICS_RX_GOOD_FRAMES 0x01

// Number of frames below the minimum length for the media.
// This would be <64 for ethernet.
#define PXE_STATISTICS_RX_UNDERSIZE_FRAMES 0x02

// Number of frames longer than the maximum length for the
// media. This would be >1500 for ethernet.
#define PXE_STATISTICS_RX_OVERSIZE_FRAMES 0x03

// Valid frames that were dropped because receive buffers
// were full.
#define PXE_STATISTICS_RX_DROPPED_FRAMES 0x04

// Number of valid unicast frames received and not dropped.
#define PXE_STATISTICS_RX_UNICAST_FRAMES 0x05

// Number of valid broadcast frames received and not dropped.
#define PXE_STATISTICS_RX_BROADCAST_FRAMES 0x06

// Number of valid multicast frames received and not dropped.
#define PXE_STATISTICS_RX_MULTICAST_FRAMES 0x07

// Number of frames w/ CRC or alignment errors.
#define PXE_STATISTICS_RX_CRC_ERROR_FRAMES 0x08

// Total number of bytes received. Includes frames with errors
// and dropped frames.
#define PXE_STATISTICS_RX_TOTAL_BYTES 0x09

// Transmit statistics.
#define PXE_STATISTICS_TX_TOTAL_FRAMES 0x0A
#define PXE_STATISTICS_TX_GOOD_FRAMES 0x0B
#define PXE_STATISTICS_TX_UNDERSIZE_FRAMES 0x0C
```

```

#define PXE_STATISTICS_TX_OVERSIZE_FRAMES 0x0D
#define PXE_STATISTICS_TX_DROPPED_FRAMES 0x0E
#define PXE_STATISTICS_TX_UNICAST_FRAMES 0x0F
#define PXE_STATISTICS_TX_BROADCAST_FRAMES 0x10
#define PXE_STATISTICS_TX_MULTICAST_FRAMES 0x11
#define PXE_STATISTICS_TX_CRC_ERROR_FRAMES 0x12
#define PXE_STATISTICS_TX_TOTAL_BYTES 0x13

// Number of collisions detection on this subnet.
#define PXE_STATISTICS_COLLISIONS 0x14

// Number of frames destined for unsupported protocol.
#define PXE_STATISTICS_UNSUPPORTED_PROTOCOL 0x15

// Number of valid frames received that were duplicated.
#define PXE_STATISTICS_RX_DUPLICATED_FRAMES 0x16

// Number of encrypted frames received that failed to decrypt.
#define PXE_STATISTICS_RX_DECRYPT_ERROR_FRAMES 0x17
// Number of frames that failed to transmit after exceeding the
// retry limit.
#define PXE_STATISTICS_TX_ERROR_FRAMES 0x18

// Number of frames transmitted successfully after more than one
// attempt.
#define PXE_STATISTICS_TX_RETRY_FRAMES 0x19

```

## E.4.14 MCast IP To MAC

Translate a multicast IPv4 or IPv6 address to a multicast MAC address.

### E.4.14.1 Issuing the Command

To issue a MCast IP To MAC command, create a CDB and fill it in as shown in the table below:

CDB Field	How to initialize the CDB structure for a MCast IP To MAC command
OpCode	PXE_OPCODE_MCAST_IP_TO_MAC
OpFlags	Set as needed.
CPBsize	sizeof(PXE_CPB_MCAST_IP_TO_MAC)
DBsize	sizeof(PXE_DB_MCAST_IP_TO_MAC)
CPBaddr	Address of <b>PXE_CPB_MCAST_IP_TO_MAC</b> structure.
Dbaddr	Address of <b>PXE_DB_MCAST_IP_TO_MAC</b> structure.
StatCode	PXE_STATCODE_INITIALIZE
StatFlags	PXE_STATFLAGS_INITIALIZE
Ifnum	A valid interface number from zero to <b>(!PXE.IFcnt   (!PXE.IFcntExt &lt;&lt; 8))</b> .

CDB Field	How to initialize the CDB structure for a MCast IP To MAC command
Control	Set as needed.

#### E.4.14.2 OpFlags

To convert a multicast IP address to a multicast MAC address the UNDI needs to know the format of the IP address. Set one of these OpFlags to identify the format of the IP addresses in the CPB:

```
PXE_OPFLAGS_MCAST_IPV4_TO_MAC
PXE_OPFLAGS_MCAST_IPV6_TO_MAC
```

#### E.4.14.3 Preparing the CPB

Fill in an array of one or more multicast IP addresses. Be sure to set the **CDB.CPBsize** and **CDB.CPBaddr** fields accordingly.

```
typedef struct s_pxe_cpb_mcast_ip_to_mac {

    // Multicast IP address to be converted to multicast
    // MAC address.
    PXE_IP_ADDR IP[n];
} PXE_CPB_MCAST_IP_TO_MAC;
```

#### E.4.14.4 Waiting for the Command to Execute

Monitor the upper two bits (14 & 15) in the **CDB.StatFlags** field. Until these bits change to report **PXE\_STATFLAGS\_COMMAND\_COMPLETE** or **PXE\_STATFLAGS\_COMMAND\_FAILED**, the command has not been executed by the UNDI.

StatFlags	Reason
COMMAND_COMPLETE	Command completed successfully. DB is written.
COMMAND_FAILED	Command failed. StatCode field contains error code.
COMMAND_QUEUED	Command has been queued.
INITIALIZE	Command has been not executed or queued.

#### E.4.14.5 Checking Command Execution Results

After command execution completes, either successfully or not, the **CDB.StatCode** field contains the result of the command execution.

StatCode	Reason
SUCCESS	Command completed successfully. DB is written.
INVALID_CDB	One of the CDB fields was not set correctly.
INVALID_CPB	One of the CPB fields was not set correctly.
BUSY	UNDI is already processing commands. Try again later.
QUEUE_FULL	Command queue is full. Try again later.
NOT_STARTED	The UNDI is not started.

StatCode	Reason
NOT_INITIALIZED	The UNDI is not initialized.

#### E.4.14.6 Before Using the DB

The DB is where the multicast MAC addresses will be written.

```
typedef struct s_pxe_db_mcast_ip_to_mac {
    // Multicast MAC address.

    PXE_MAC_ADDR MAC[n];
} PXE_DB_MCAST_IP_TO_MAC;
```

#### E.4.15 NvData

This command is used to read and write (if supported by NIC H/W) nonvolatile storage on the NIC. Nonvolatile storage could be EEPROM, FLASH or battery backed RAM.

##### E.4.15.1 Issuing the Command

To issue a NvData command, create a CDB and fill it in as shown in the table below:

CDB Field	How to initialize the CDB structure for a NvData command
OpCode	PXE_OPCODE_NVDATA
OpFlags	Set as needed.
CPBsize	<b>sizeof(PXE_CPB_NVDATA)</b>
DBsize	<b>sizeof(PXE_DB_NVDATA)</b>
CPBaddr	Address of <b>PXE_CPB_NVDATA</b> structure.
Dbaddr	Address of <b>PXE_DB_NVDATA</b> structure.
StatCode	<b>PXE_STATCODE_INITIALIZE</b>
StatFlags	<b>PXE_STATFLAGS_INITIALIZE</b>
Ifnum	A valid interface number from zero to <b>(!PXE.IFcnt   (!PXE.IFcntExt &lt;&lt; 8))</b> .
Control	Set as needed.

##### E.4.15.2 Preparing the CPB

There are two types of nonvolatile data CPBs, one for sparse updates and one for bulk updates. Sparse updates allow updating of single nonvolatile storage items. Bulk updates always update all nonvolatile storage items. Check the **!PXE.Implementation** flags to see which type of nonvolatile update is supported by this UNDI and network device.

If you do not need to update the nonvolatile storage set the **CDB.CPBsize** and **CDB.CPBaddr** fields to **PXE\_CPBSIZE\_NOT\_USED** and **PXE\_CPBADDR\_NOT\_USED**.

###### E.4.15.2.1 Sparse NvData CPB

```
typedef struct s_pxe_cpb_nvdata_sparse {
```

*// NvData item list. Only items in this list will be updated.*

```
struct {
    // Nonvolatile storage address to be changed.
    PXE_UINT32 Addr;

    // Data item to write into above storage address.
    union {
        PXE_UINT8 Byte;
        PXE_UINT16 Word;
        PXE_UINT32 Dword;
    } Data;
} Item[n];
} PXE_CPB_NVDATA_SPARSE;
```

#### E.4.15.2.2 Bulk NvData CPB

*// When using bulk update, the size of the CPB structure must be  
// the same size as the nonvolatile NIC storage.*

```
typedef union u_pxe_cpb_nvdata_bulk {

    // Array of byte-wide data items.
    PXE_UINT8 Byte[n];

    // Array of word-wide data items.
    PXE_UINT16 Word[n];

    // Array of dword-wide data items.
    PXE_UINT32 Dword[n];
} PXE_CPB_NVDATA_BULK;
```

#### E.4.15.3 Waiting for the Command to Execute

Monitor the upper two bits (14 & 15) in the **CDB.StatFlags** field. Until these bits change to report **PXE\_STATFLAGS\_COMMAND\_COMPLETE** or **PXE\_STATFLAGS\_COMMAND\_FAILED**, the command has not been executed by the UNDI.

StatFlags	Reason
COMMAND_COMPLETE	Command completed successfully. Nonvolatile data is updated from CPB and/or written to DB.
COMMAND_FAILED	Command failed. StatCode field contains error code.
COMMAND_QUEUED	Command has been queued.
INITIALIZE	Command has been not executed or queued.

## E.4.15.4 Checking Command Execution Results

After command execution completes, either successfully or not, the **CDB.StatCode** field contains the result of the command execution.

StatCode	Reason
SUCCESS	Command completed successfully. Nonvolatile data is updated from CPB and/or written to DB.
INVALID_CDB	One of the CDB fields was not set correctly.
INVALID_CPB	One of the CPB fields was not set correctly.
BUSY	UNDI is already processing commands. Try again later.
QUEUE_FULL	Command queue is full. Try again later.
NOT_STARTED	The UNDI is not started.
NOT_INITIALIZED	The UNDI is not initialized.
UNSUPPORTED	Requested operation is unsupported.

### E.4.15.4.1 DB

Check the width and number of nonvolatile storage items. This information is returned by the Get Init Info command.

```
typedef struct s_pxe_db_nvdata {  
  
    // Arrays of data items from nonvolatile storage.  
    union {  
  
        // Array of byte-wide data items.  
        PXE_UINT8 Byte[n];  
  
        // Array of word-wide data items.  
        PXE_UINT16 Word[n];  
  
        // Array of dword-wide data items.  
        PXE_UINT32 Dword[n];  
    } Data;  
    } PXE_DB_NVDATA;
```

## E.4.16 Get Status

This command returns the current interrupt status and/or the transmitted buffer addresses and the current media status. If the current interrupt status is returned, pending interrupts will be acknowledged by this command. Transmitted buffer addresses that are written to the DB are removed from the transmitted buffer queue.

This command may be used in a polled fashion with external interrupts disabled.

### E.4.16.1 Issuing the Command

To issue a Get Status command, create a CDB and fill it in as shown in the table below:

CDB Field	How to initialize the CDB structure for a Get Status command
OpCode	PXE_OPCODE_GET_STATUS
OpFlags	Set as needed.
CPBsize	PXE_CPBSIZE_NOT_USED
DBsize	Sizeof(PXE_DB_GET_STATUS)
CPBaddr	PXE_CPBADDR_NOT_USED
DBaddr	Address of <b>PXE_DB_GET_STATUS</b> structure.
StatCode	PXE_STATCODE_INITIALIZE
StatFlags	PXE_STATFLAGS_INITIALIZE
IFnum	A valid interface number from zero to <b>(!PXE.IFcnt   (!PXE.IFcntExt &lt;&lt; 8))</b> .
Control	Set as needed.

#### E.4.16.1.1 Setting OpFlags

Set one or a combination of the OpFlags below to return the interrupt status and/or the transmitted buffer addresses and/or the media status.

**PXE\_OPFLAGS\_GET\_INTERRUPT\_STATUS**  
**PXE\_OPFLAGS\_GET\_TRANSMITTED\_BUFFERS**  
**PXE\_OPFLAGS\_GET\_MEDIA\_STATUS**

### E.4.16.2 Waiting for the Command to Execute

Monitor the upper two bits (14 & 15) in the **CDB.StatFlags** field. Until these bits change to report **PXE\_STATFLAGS\_COMMAND\_COMPLETE** or **PXE\_STATFLAGS\_COMMAND\_FAILED**, the command has not been executed by the UNDI.

StatFlags	Reason
COMMAND_COMPLETE	Command completed successfully. StatFlags and/or DB are updated.
COMMAND_FAILED	Command failed. StatCode field contains error code.
COMMAND_QUEUED	Command has been queued.
INITIALIZE	Command has been not executed or queued.

### E.4.16.3 Checking Command Execution Results

After command execution completes, either successfully or not, the **CDB.StatCode** field contains the result of the command execution.

StatCode	Reason
SUCCESS	Command completed successfully. StatFlags and/or DB are updated.
INVALID_CDB	One of the CDB fields was not set correctly.
BUSY	UNDI is already processing commands. Try again later.



QUEUE_FULL	Command queue is full. Try again later.
NOT_STARTED	The UNDI is not started.
NOT_INITIALIZED	The UNDI is not initialized.

#### E.4.16.4 StatFlags

If the command completes successfully and the **PXE\_OPFLAGS\_GET\_INTERRUPT\_STATUS** OpFlag was set in the CDB, the current interrupt status is returned in the **CDB.StatFlags** field and any pending interrupts will have been cleared.

**PXE\_STATFLAGS\_GET\_STATUS\_RECEIVE**  
**PXE\_STATFLAGS\_GET\_STATUS\_TRANSMIT**  
**PXE\_STATFLAGS\_GET\_STATUS\_COMMAND**  
**PXE\_STATFLAGS\_GET\_STATUS\_SOFTWARE**

The StatFlags above may not map directly to external interrupt signals. For example: Some NICs may combine both the receive and transmit interrupts to one external interrupt line. When a receive and/or transmit interrupt occurs, use the Get Status to determine which type(s) of interrupt(s) occurred.

This flag is set if the transmitted buffer queue is empty. This flag will be set if all transmitted buffer addresses get written into the DB.

**PXE\_STATFLAGS\_GET\_STATUS\_TXBUF\_QUEUE\_EMPTY**

This flag is set if no transmitted buffer addresses were written into the DB.

**PXE\_STATFLAGS\_GET\_STATUS\_NO\_TXBUFS\_WRITTEN**

This flag is set if there is no media present.

**PXE\_STATFLAGS\_GET\_STATUS\_NO\_MEDIA**

#### E.4.16.5 Using the DB

When reading the transmitted buffer addresses there should be room for at least one 64-bit address in the DB. Once a complete transmitted buffer address is written into the DB, the address is removed from the transmitted buffer queue. If the transmitted buffer queue is full, attempts to use the Transmit command will fail.

```
#pragma pack(1)
typedef struct s_pxe_db_get_status {

    // Length of next receive frame (header + data). If this is
    // zero, there is no next receive frame available.

    PXE_UINT32 RxFrameLen;

    // Reserved, set to zero.

    PXE_UINT32 reserved;

    // Addresses of transmitted buffers that need to be recycled.
```

```
PXE_UINT64 xBuffer[n];
} PXE_DB_GET_STATUS;
#pragma pack()
```

### E.4.17 Fill Header

This command is used to fill the media header(s) in transmit packet(s).

#### E.4.17.1 Issuing the Command

To issue a Fill Header command, create a CDB and fill it in as shown in the table below:

CDB Field	How to initialize the CDB structure for a Fill Header command
OpCode	PXE_OPCODE_FILL_HEADER
OpFlags	Set as needed.
CPBsize	PXE_CPB_FILL_HEADER
DBsize	PXE_DBSIZE_NOT_USED
CPBaddr	Address of a <b>PXE_CPB_FILL_HEADER</b> structure.
DBaddr	PXE_DBADDR_NOT_USED
StatCode	PXE_STATCODE_INITIALIZE
StatFlags	PXE_STATFLAGS_INITIALIZE
IFnum	A valid interface number from zero to <b>(!PXE.IFcnt   (!PXE.IFcntExt &lt;&lt; 8))</b> .
Control	Set as needed.

#### E.4.17.2 OpFlags

Select one of the OpFlags below so the UNDI knows what type of CPB is being used.

```
PXE_OPFLAGS_FILL_HEADER_WHOLE
PXE_OPFLAGS_FILL_HEADER_FRAGMENTED
```

#### E.4.17.3 Preparing the CPB

If multiple frames per command are supported (see **IPXE.Implementation** flags), multiple CPBs can be packed together. The **CDB.CPBsize** field lets the UNDI know how many CPBs are packed together.

#### E.4.17.4 Nonfragmented Frame

```
#pragma pack(1)
typedef struct s_pxe_cpb_fill_header {

    // Source and destination MAC addresses. These will be copied
    // into the media header without doing byte swapping.
    PXE_MAC_ADDR SrcAddr;
    PXE_MAC_ADDR DestAddr;

    // Address of first byte of media header. The first byte of
    // packet data follows the last byte of the media header.
```

```

PXE_UINT64 MediaHeader;

// Length of packet data in bytes (not including the media
// header).
PXE_UINT32 PacketLen;

// Protocol type. This will be copied into the media header
// without doing byte swapping. Protocol type numbers can be
// obtained from the Assigned Numbers RFC 3232.
PXE_UINT16 Protocol;

// Length of the media header in bytes.
PXE_UINT16 MediaHeaderLen;
} PXE_CPB_FILL_HEADER;
#pragma pack()

#define PXE_PROTOCOL_ETHERNET_IP 0x0800
#define PXE_PROTOCOL_ETHERNET_ARP 0x0806

```

#### E.4.17.5 Fragmented Frame

```

#pragma pack(1)
typedef struct s_pxe_cpb_fill_header_fragmented {

// Source and destination MAC addresses. These will be copied
// into the media header without doing byte swapping.
PXE_MAC_ADDR SrcAddr;
PXE_MAC_ADDR DestAddr;

// Length of packet data in bytes (not including the media
// header).

PXE_UINT32 PacketLen;
// Protocol type. This will be copied into the media header
// without doing byte swapping. Protocol type numbers can be
// obtained from the Assigned Numbers RFC 3232.
PXE_MEDIA_PROTOCOL Protocol;

// Length of the media header in bytes.
PXE_UINT16 MediaHeaderLen;

// Number of packet fragment descriptors.
PXE_UINT16 FragCnt;

// Reserved, must be set to zero.
PXE_UINT16 reserved;

// Array of packet fragment descriptors. The first byte of the
// media header is the first byte of the first fragment.

```

```

struct {

    // Address of this packet fragment.
    PXE_UINT64 FragAddr;

    // Length of this packet fragment.
    PXE_UINT32 FragLen;

    // Reserved, must be set to zero.
    PXE_UINT32 reserved;
} FragDesc[n];
} PXE_CPB_FILL_HEADER_FRAGMENTED;
#pragma pack()
    
```

#### E.4.17.6 Waiting for the Command to Execute

Monitor the upper two bits (14 & 15) in the **CDB.StatFlags** field. Until these bits change to report **PXE\_STATFLAGS\_COMMAND\_COMPLETE** or **PXE\_STATFLAGS\_COMMAND\_FAILED**, the command has not been executed by the UNDI.

StatFlags	Reason
COMMAND_COMPLETE	Command completed successfully. Frame is ready to transmit.
COMMAND_FAILED	Command failed. StatCode field contains error code.
COMMAND_QUEUED	Command has been queued.
INITIALIZE	Command has been not executed or queued.

#### E.4.17.7 Checking Command Execution Results

After command execution completes, either successfully or not, the **CDB.StatCode** field contains the result of the command execution.

StatCode	Reason
SUCCESS	Command completed successfully. Frame is ready to transmit.
INVALID_CDB	One of the CDB fields was not set correctly.
INVALID_CPB	One of the CPB fields was not set correctly.
BUSY	UNDI is already processing commands. Try again later.
QUEUE_FULL	Command queue is full. Try again later.
NOT_STARTED	The UNDI is not started.
NOT_INITIALIZED	The UNDI is not initialized.

#### E.4.18 Transmit

The Transmit command is used to place a packet into the transmit queue. The data buffers given to this command are to be considered locked and the application or

universal network driver loses the ownership of those buffers and must not free or relocate them until the ownership returns.

When the packets are transmitted, a transmit complete interrupt is generated (if interrupts are disabled, the transmit interrupt status is still set and can be checked using the Get Status command).

Some UNDI implementations and network adapters support transmitting multiple packets with one transmit command. If this feature is supported, multiple transmit CPBs can be linked in one transmit command.

Though all UNDI support fragmented frames, the same cannot be said for all network devices or protocols. If a fragmented frame CPB is given to UNDI and the network device does not support fragmented frames (see **!PXE.Implementation** flags), the UNDI will have to copy the fragments into a local buffer before transmitting.

### E.4.18.1 Issuing the Command

To issue a Transmit command, create a CDB and fill it in as shown in the table below:

CDB Field	How to initialize the CDB structure for a Transmit command
OpCode	PXE_OPCODE_TRANSMIT
OpFlags	Set as needed.
CPBsize	<b>sizeof(PXE_CPB_TRANSMIT)</b>
DBsize	<b>PXE_DBSIZE_NOT_USED</b>
CPBaddr	Address of a <b>PXE_CPB_TRANSMIT</b> structure.
DBaddr	<b>PXE_DBADDR_NOT_USED</b>
StatCode	<b>PXE_STATCODE_INITIALIZE</b>
StatFlags	<b>PXE_STATFLAGS_INITIALIZE</b>
IFnum	A valid interface number from zero to <b>(!PXE.IFcnt   (!PXE.IFcntExt &lt;&lt; 8))</b> .
Control	Set as needed.

### E.4.18.2 OpFlags

Check the **!PXE.Implementation** flags to see if the network device support fragmented packets. Select one of the OpFlags below so the UNDI knows what type of CPB is being used.

**PXE\_OPFLAGS\_TRANSMIT\_WHOLE**

**PXE\_OPFLAGS\_TRANSMIT\_FRAGMENTED**

In addition to selecting whether or not fragmented packets are being given, S/W UNDI needs to know if it should block until the packets are transmitted. H/W UNDI cannot block, these two OpFlag settings have no affect when used with H/W UNDI.

**PXE\_OPFLAGS\_TRANSMIT\_BLOCK**

**PXE\_OPFLAGS\_TRANSMIT\_DONT\_BLOCK**

### E.4.18.3 Preparing the CPB

If multiple frames per command are supported (see **IPXE.Implementation** flags), multiple CPBs can be packed together. The **CDB.CPBsize** field lets the UNDI know how many frames are to be transmitted.

### E.4.18.4 Nonfragmented Frame

```
#pragma pack(1)
typedef struct s_pxe_cpb_transmit {

    // Address of first byte of frame buffer. This is also the
    // first byte of the media header. This address must be a
    // processor-based address for S/W UNDI and a device-based
    // address for H/W UNDI.
    PXE_UINT64 FrameAddr;

    // Length of the data portion of the frame buffer in bytes. Do
    // not include the length of the media header.
    PXE_UINT32 DataLen;

    // Length of the media header in bytes.
    PXE_UINT16 MediaheaderLen;

    // Reserved, must be zero.
    PXE_UINT16 reserved;
} PXE_CPB_TRANSMIT;
#pragma pack()
```

### E.4.18.5 Fragmented Frame

```
#pragma pack(1)
typedef struct s_pxe_cpb_transmit_fragments {

    // Length of packet data in bytes (not including the media
    // header).
    PXE_UINT32 FrameLen;

    // Length of the media header in bytes.
    PXE_UINT16 MediaheaderLen;

    // Number of packet fragment descriptors.
    PXE_UINT16 FragCnt;

    // Array of frame fragment descriptors. The first byte of the
    // first fragment is also the first byte of the media header.
    struct {
        // Address of this frame fragment. This address must be a
        // processor-based address for S/W UNDI and a device-based
        // address for H/W UNDI.

```

```

PXE_UINT64 FragAddr;

// Length of this frame fragment.
PXE_UINT32 FragLen;

// Reserved, must be set to zero.
PXE_UINT32 reserved;
} FragDesc[n];
} PXE_CPB_TRANSMIT_FRAGMENTS;
#pragma pack()

```

#### E.4.18.6 Waiting for the Command to Execute

Monitor the upper two bits (14 & 15) in the **CDB.StatFlags** field. Until these bits change to report **PXE\_STATFLAGS\_COMMAND\_COMPLETE** or **PXE\_STATFLAGS\_COMMAND\_FAILED**, the command has not been executed by the UNDI.

StatFlags	Reason
COMMAND_COMPLETE	Command completed successfully. Use the Get Status command to see when frame buffers can be reused.
COMMAND_FAILED	Command failed. StatCode field contains error code.
COMMAND_QUEUED	Command has been queued.
INITIALIZE	Command has been not executed or queued.

#### E.4.18.7 Checking Command Execution Results

After command execution completes, either successfully or not, the **CDB.StatCode** field contains the result of the command execution.

StatCode	Reason
SUCCESS	Command completed successfully. Use the Get Status command to see when frame buffers can be reused.
INVALID_CDB	One of the CDB fields was not set correctly.
INVALID_CPB	One of the CPB fields was not set correctly.
BUSY	UNDI is already processing commands. Try again later.
QUEUE_FULL	Command queue is full. Wait for queued commands to complete. Try again later.
BUFFER_FULL	Transmit buffer is full. Call Get Status command to empty buffer.
NOT_STARTED	The UNDI is not started.
NOT_INITIALIZED	The UNDI is not initialized.

#### E.4.19 Receive

When the network adapter has received a frame, this command is used to copy the frame into driver/application storage. Once a frame has been copied, it is removed from the receive queue.

### E.4.19.1 Issuing the Command

To issue a Receive command, create a CDB and fill it in as shown in the table below:

CDB Field	How to initialize the CDB structure for a Receive command
OpCode	PXE_OPCODE_RECEIVE
OpFlags	Set as needed.
CPBsize	sizeof(PXE_CPB_RECEIVE)
DBsize	sizeof(PXE_DB_RECEIVE)
CPBaddr	Address of a <b>PXE_CPB_RECEIVE</b> structure.
DBaddr	Address of a <b>PXE_DB_RECEIVE</b> structure.
StatCode	PXE_STATCODE_INITIALIZE
StatFlags	PXE_STATFLAGS_INITIALIZE
IFnum	A valid interface number from zero to ( <b>!PXE.IFcnt   (!PXE.IFcntExt &lt;&lt; 8)</b> ).
Control	Set as needed.

### E.4.19.2 Preparing the CPB

If multiple frames per command are supported (see **!PXE.Implementation** flags), multiple CPBs can be packed together. For each complete received frame, a receive buffer large enough to contain the entire unfragmented frame needs to be described in the CPB. Note that if a smaller than required buffer is provided, only a portion of the packet is received into the buffer, and the remainder of the packet is lost. Subsequent attempts to receive the same packet with a corrected (larger) buffer will be unsuccessful, because the packet will have been flushed from the queue.

```
#pragma pack(1)
typedef struct s_pxe_cpb_receive {

    // Address of first byte of receive buffer. This is also the
// first byte of the frame header. This address must be a
// processor-based address for S/W UNDI and a device-based
// address for H/W UNDI.

    PXE_UINT64 BufferAddr;

    // Length of receive buffer. This must be large enough to hold
// the received frame (media header + data). If the length of
// smaller than the received frame, data will be lost.
    PXE_UINT32 BufferLen;

    // Reserved, must be set to zero.
    PXE_UINT32 reserved;
} PXE_CPB_RECEIVE;
#pragma pack()
```



### E.4.19.3 Waiting for the Command to Execute

Monitor the upper two bits (14 & 15) in the **CDB.StatFlags** field. Until these bits change to report **PXE\_STATFLAGS\_COMMAND\_COMPLETE** or **PXE\_STATFLAGS\_COMMAND\_FAILED**, the command has not been executed by the UNDI.

StatFlags	Reason
COMMAND_COMPLETE	Command completed successfully. Frames received and DB is written.
COMMAND_FAILED	Command failed. StatCode field contains error code.
COMMAND_QUEUED	Command has been queued.
INITIALIZE	Command has been not executed or queued.

### E.4.19.4 Checking Command Execution Results

After command execution completes, either successfully or not, the **CDB.StatCode** field contains the result of the command execution.

StatCode	Reason
SUCCESS	Command completed successfully. Frames received and DB is written.
INVALID_CDB	One of the CDB fields was not set correctly.
INVALID_CPB	One of the CPB fields was not set correctly.
BUSY	UNDI is already processing commands. Try again later.
QUEUE_FULL	Command queue is full. Wait for queued commands to complete. Try again later.
NO_DATA	Receive buffers are empty.
NOT_STARTED	The UNDI is not started.
NOT_INITIALIZED	The UNDI is not initialized.

### E.4.19.5 Using the DB

If multiple frames per command are supported (see **!PXE.Implementation** flags), multiple DBs can be packed together.

```
#pragma pack(1)
typedef struct s_pxe_db_receive {

    // Source and destination MAC addresses from media header.
    PXE_MAC_ADDR SrcAddr;
    PXE_MAC_ADDR DestAddr;

    // Length of received frame. May be larger than receive buffer
    // size. The receive buffer will not be overwritten. This is
    // how to tell if data was lost because the receive buffer was
    // too small.
    PXE_UINT32 FrameLen;
```

```
// Protocol type from media header.  
PXE_PROTOCOL Protocol;  
  
// Length of media header in received frame.  
PXE_UINT16 MediaHeaderLen;  
  
// Type of receive frame.  
PXE_FRAME_TYPE Type;  
  
// Reserved, must be zero.  
PXE_UINT8 reserved[7];  
} PXE_DB_RECEIVE;  
#pragma pack()
```

## E.4.20 PXE 2.1 specification wire protocol clarifications

### E.4.20.1 Issue #1-time-outs

Where the PXE 2.1 specification reads:

DHCP Discover will be retried four times. The four timeouts are 4, 8, 16 and 32 seconds respectively.

If a DHCP OFFER is received without an Option #60 tag "PXEClient", DHCP Discover will be retried on the 4- and 8-second timeouts in an attempt to receive a PXE response.

Because of spanning tree algorithms in routers, the behavior should be as follows:

DHCP Discover will be retried four times. The four timeouts are 4, 8, 16 and 32 seconds respectively.

This process could be iterated three times.

If a DHCP OFFER is received without an Option #60 tag "PXEClient", DHCP Discover will be retried on the 4- and 8-second timeouts in an attempt to receive a PXE response.

### E.4.20.2 Issue #2 - siaddr/option 54 precedence

Where the PXE 2.1 specification reads:

Boot server IP address (Read from the DHCP option 54 (server identifier), if not found, use the siaddr field.)

The behavior should be reversed, namely:

Ascertain the Boot server IP address from siaddr field. If not found, use the value in the DHCP option 54 (server identifier).

# Appendix F Using the Simple Pointer Protocol

---

The Simple Pointer Protocol is intended to provide a simple mechanism for an application to interact with the user with some type of pointer device. To keep this interface simple, many of the custom controls that are typically present in an OS-present environment were left out. This includes the ability to adjust the double-click speed and the ability to adjust the pointer speed. Instead, the recommendations for how the Simple Pointer Protocol should be used are listed here.

## X-Axis Movement:

If the Simple Pointer Protocol is being used to move a pointer or cursor around on an output display, the movement along the x-axis should move the pointer or cursor horizontally.

## Y-Axis Movement:

If the Simple Pointer Protocol is being used to move a pointer or cursor around on an output display, the movement along the y-axis should move the pointer or cursor vertically.

## Z-Axis Movement:

If the Simple Pointer Protocol is being used to move a pointer or cursor around on an output display, and the application that is using the Simple Pointer Protocol supports scrolling, then the movement along the z-axis should scroll the output display.

## Double Click Speed:

If two clicks of the same button on a pointer occur in less than 0.5 seconds, then a double-click event has occurred. If a the same button is pressed with more than 0.5 seconds between clicks, then this is interpreted as two single-click events.

## Pointer Speed:

The Simple Pointer Protocol returns the movement of the pointer device along an axis in counts. The Simple Pointer Protocol also contains a set of resolution fields that define the number of counts that will be received for each millimeter of movement of the pointer device along an axis. From these two values, the consumer of this protocol can determine the distance the pointer device has been moved in millimeters along an axis. For most applications, movement of a pointer device will result in the movement of a pointer on the screen. For each millimeter of motion by the pointer device in the x-axis, the pointer on the screen will be moved 2 percent of the screen width. For each millimeter of motion by the pointer device in the y-axis, the pointer on the screen will be moved 2 percent of the screen height.



# Appendix G

## Using the EFI Extended SCSI Pass Thru Protocol

---

This appendix describes how an EFI utility might gain access to the EFI SCSI Pass Thru interfaces. The basic concept is to use the [EFI\\_BOOT\\_SERVICES.LocateHandle\(\)](#) boot service to retrieve the list of handles that support the [EFI\\_EXT\\_SCSI\\_PASS\\_THRU\\_PROTOCOL](#). Each of these handles represents a different SCSI channel present in the system. Each of these handles can then be used to retrieve the [EFI\\_EXT\\_SCSI\\_PASS\\_THRU\\_PROTOCOL](#) interface with the [EFI\\_BOOT\\_SERVICES.HandleProtocol\(\)](#) boot service. The [EFI\\_EXT\\_SCSI\\_PASS\\_THRU\\_PROTOCOL](#) interface provides the services required to access any of the SCSI devices attached to a SCSI channel. The services of the [EFI\\_EXT\\_SCSI\\_PASS\\_THRU\\_PROTOCOL](#) are then to loop through the Target IDs of all the SCSI devices on the SCSI channel.

```
#include "efi.h"
#include "efilib.h"

#include EFI_PROTOCOL_DEFINITION(ExtScsiPassThru)

EFI_GUID gEfiExtScsiPassThruProtocolGuid = EFI_EXT_SCSI_PASS_THRU_PROTOCOL_GUID;

EFI_STATUS
UtilityEntryPoint(
    EFI_HANDLE ImageHandle,
    EFI_SYSTEM_TABLE SystemTable
)
{
    EFI_STATUS Status;
    UINTN NoHandles;
    EFI_HANDLE *HandleBuffer;
    UINTN Index;
    EFI_EXT_SCSI_PASS_THRU_PROTOCOL *ExtScsiPassThruProtocol;

    //
    // Initialize EFI Library
    //
    InitializeLib (ImageHandle, SystemTable);

    //
    // Get list of handles that support the
    // EFI_EXT_SCSI_PASS_THRU_PROTOCOL
    //
    NoHandles = 0;
    HandleBuffer = NULL;
    Status = LibLocateHandle(
        ByProtocol,
        &gEfiExtScsiPassThruProtocolGuid,
        NULL,
        &NoHandles,
        &HandleBuffer
    );
};
```

## Unified Extensible Firmware Interface Specification

```
if (EFI_ERROR(Status)) {
    BS->Exit(ImageHandle,EFI_SUCCESS,0,NULL);
}

//
// Loop through all the handles that support
// EFI_EXT_SCSI_PASS_THRU
//
for (Index = 0; Index < NoHandles; Index++) {

    //
    // Get the EFI_EXT_SCSI_PASS_THRU_PROTOCOL Interface
    // on each handle
    //
    BS->HandleProtocol(
        HandleBuffer[Index],
        &gEfiExtScsiPassThruProtocolGuid,
        (VOID **)&ExtScsiPassThruProtocol
    );

    if (!EFI_ERROR(Status)) {

        //
        // Use the EFI_EXT_SCSI_PASS_THRU Interface to
        // perform tests
        //
        Status = DoScsiTests(ScsiPassThruProtocol);
    }
}
return EFI_SUCCESS;
}

EFI_STATUS
DoScsiTests(
    EFI_EXT_SCSI_PASS_THRU_PROTOCOL *ExtScsiPassThruProtocol
)
{
    EFI_STATUS          Status;
    UINT32              Target;
    UINT64              Lun;
    EFI_EXT_SCSI_PASS_THRU_SCSI_REQUEST_PACKET Packet;
    EFI_EVENT           Event;

    //
    // Get first Target ID and LUN on the SCSI channel
    //
    Target = 0xffffffff;
    Lun = 0;
    Status = ExtScsiPassThruProtocol-> GetNextTargetLun(
        ExtScsiPassThruProtocol,
        &Target,
        &Lun
    );

    //
    // Loop through all the SCSI devices on the SCSI channel
    //
    while (!EFI_ERROR (Status)) {

        //
```

```

// Blocking I/O example.
// Fill in Packet before calling PassThru()
//
Status = ExtScsiPassThruProtocol->PassThru(
    ExtScsiPassThruProtocol,
    Target,
    Lun,
    &Packet,
    NULL
);

//
// Non Blocking I/O
// Fill in Packet and create Event before calling PassThru()
//
Status = ExtScsiPassThruProtocol->PassThru(
    ExtScsiPassThruProtocol,
    Target,
    Lun,
    &Packet,
    &Event
);

//
// Get next Target ID and LUN on the SCSI channel
//
Status = ExtScsiPassThruProtocol-> GetNextTargetLun(
    ExtScsiPassThruProtocol,
    &Target,
    &Lun
);
}

return EFI_SUCCESS;
}

```





# Appendix H Compression Source Code

---

```
/*++
```

```
Copyright (c) 2001–2002 Intel Corporation
```

```
Module Name:
```

```
Compress.c
```

```
Abstract:
```

Compression routine. The compression algorithm is a mixture of LZ77 and Huffman Coding. LZ77 transforms the source data into a sequence of Original Characters and Pointers to repeated strings. This sequence is further divided into Blocks and Huffman codings are applied to each Block.

```
Revision History:
```

```
--*/
```

```
#include <string.h>
#include <stdlib.h>
#include "eficommon.h"
```

```
//
// Macro Definitions
//
```

```
typedef INT16  NODE;
#define UINT8_MAX  0xff
#define UINT8_BIT  8
#define THRESHOLD  3
#define INIT_CRC   0
#define WNDBIT     13
#define WNDSIZ     (1U << WNDBIT)
#define MAXMATCH   256
#define PERC_FLAG  0x8000U
#define CODE_BIT   16
#define NIL        0
#define MAX_HASH_VAL (3 * WNDSIZ + (WNDSIZ / 512 + 1) * UINT8_MAX)
#define HASH(p, c)  ((p) + ((c) << (WNDBIT - 9)) + WNDSIZ * 2)
#define CRCPOLY    0xA001
#define UPDATE_CRC(c) mCrc = mCrcTable[(mCrc ^ (c)) & 0xFF] ^ (mCrc >> UINT8_BIT)
```

```
//
// C: the Char&Len Set; P: the Position Set; T: the exTra Set
//
```

```
#define NC  (UINT8_MAX + MAXMATCH + 2 - THRESHOLD)
#define CBIT  9
#define NP  (WNDBIT + 1)
#define PBIT  4
#define NT  (CODE_BIT + 3)
#define TBIT  5
#if NT > NP
#define NPT NT
```

## Unified Extensible Firmware Interface Specification

```
#else
#define    NPT NP
#endif

//
// Function Prototypes
//

STATIC
VOID
PutDword(
    IN UINT32 Data
);

STATIC
EFL_STATUS
AllocateMemory (
);

STATIC
VOID
FreeMemory (
);

STATIC
VOID
InitSlide (
);

STATIC
NODE
Child (
    IN NODE q,
    IN UINT8 c
);

STATIC
VOID
MakeChild (
    IN NODE q,
    IN UINT8 c,
    IN NODE r
);

STATIC
VOID
Split (
    IN NODE Old
);

STATIC
VOID
InsertNode (
);

STATIC
VOID
DeleteNode (
);

STATIC
```

```
VOID  
GetNextMatch (  
);
```

```
STATIC  
EFL_STATUS  
Encode (  
);
```

```
STATIC  
VOID  
CountTFreq (  
);
```

```
STATIC  
VOID  
WritePTLen (  
  IN INT32 n,  
  IN INT32 nbit,  
  IN INT32 Special  
);
```

```
STATIC  
VOID  
WriteCLen (  
);
```

```
STATIC  
VOID  
EncodeC (  
  IN INT32 c  
);
```

```
STATIC  
VOID  
EncodeP (  
  IN UINT32 p  
);
```

```
STATIC  
VOID  
SendBlock (  
);
```

```
STATIC  
VOID  
Output (  
  IN UINT32 c,  
  IN UINT32 p  
);
```

```
STATIC  
VOID  
HufEncodeStart (  
);
```

```
STATIC  
VOID  
HufEncodeEnd (  
);
```

## Unified Extensible Firmware Interface Specification

```
STATIC
VOID
MakeCrcTable (
);

STATIC
VOID
PutBits (
  IN INT32 n,
  IN UUINT32 x
);

STATIC
INT32
FreadCrc (
  OUT UUINT8 *p,
  IN INT32 n
);

STATIC
VOID
InitPutBits (
);

STATIC
VOID
CountLen (
  IN INT32 i
);

STATIC
VOID
MakeLen (
  IN INT32 Root
);

STATIC
VOID
DownHeap (
  IN INT32 i
);

STATIC
VOID
MakeCode (
  IN INT32 n,
  IN UUINT8 Len[],
  OUT UUINT16 Code[]
);

STATIC
INT32
MakeTree (
  IN INT32 NParm,
  IN UUINT16 FreqParm[],
  OUT UUINT8 LenParm[],
  OUT UUINT16 CodeParm[]
);

//
```

```

// Global Variables
//

STATIC UINT8 *mSrc, *mDst, *mSrcUpperLimit, *mDstUpperLimit;

STATIC UINT8 *mLevel, *mText, *mChildCount, *mBuf, mCLen[NC], mPTLen[NPT], *mLen;
STATIC INT16 mHeap[NC + 1];
STATIC INT32 mRemainder, mMatchLen, mBitCount, mHeapSize, mN;
STATIC UINT32 mBufSiz = 0, mOutputPos, mOutputMask, mSubBitBuf, mCrc;
STATIC UINT32 mCompSize, mOrigSize;

STATIC UINT16 *mFreq, *mSortPtr, mLenCnt[17], mLeft[2 * NC - 1], mRight[2 * NC - 1],
    mCrcTable[UINT8_MAX + 1], mCFreq[2 * NC - 1], mCTable[4096], mCCode[NC],
    mPFreq[2 * NP - 1], mPTCode[NPT], mTFreq[2 * NT - 1];

STATIC NODE mPos, mMatchPos, mAvail, *mPosition, *mParent, *mPrev, *mNext = NULL;

//
// functions
//

EFI_STATUS
Compress (
    IN  UINT8 *SrcBuffer,
    IN  UINT32 SrcSize,
    IN  UINT8 *DstBuffer,
    IN OUT UINT32 *DstSize
)
/*++

Routine Description:

    The main compression routine.

Arguments:

    SrcBuffer - The buffer storing the source data
    SrcSize   - The size of the source data
    DstBuffer - The buffer to store the compressed data
    DstSize   - On input, the size of DstBuffer; On output,
                the size of the actual compressed data.

Returns:

    EFI_BUFFER_TOO_SMALL - The DstBuffer is too small. In this case,
                            DstSize contains the size needed.
    EFI_SUCCESS          - Compression is successful.

--*/
{
    EFI_STATUS Status = EFI_SUCCESS;

    //
    // Initializations
    //

    mBufSiz = 0;
    mBuf = NULL;
    mText = NULL;
    mLevel = NULL;

```

## Unified Extensible Firmware Interface Specification

```
mChildCount = NULL;
mPosition = NULL;
mParent = NULL;
mPrev = NULL;
mNext = NULL;

mSrc = SrcBuffer;
mSrcUpperLimit = mSrc + SrcSize;
mDst = DstBuffer;
mDstUpperLimit = mDst + *DstSize;

PutDword(0L);
PutDword(0L);

MakeCrcTable ();

mOrigSize = mCompSize = 0;
mCrc = INIT_CRC;

//
// Compress it
//

Status = Encode();
if (EFI_ERROR (Status)) {
    return EFI_OUT_OF_RESOURCES;
}

//
// Null terminate the compressed data
//
if (mDst < mDstUpperLimit) {
    *mDst++ = 0;
}

//
// Fill in compressed size and original size
//
mDst = DstBuffer;
PutDword(mCompSize+1);
PutDword(mOrigSize);

//
// Return
//

if (mCompSize + 1 + 8 > *DstSize) {
    *DstSize = mCompSize + 1 + 8;
    return EFI_BUFFER_TOO_SMALL;
} else {
    *DstSize = mCompSize + 1 + 8;
    return EFI_SUCCESS;
}

}

STATIC
VOID
PutDword(
    IN UINT32 Data
```

```
)  
/*++
```

Routine Description:

Put a dword to output stream

Arguments:

Data - the dword to put

Returns: (VOID)

```
--*/  
{  
  if (mDst < mDstUpperLimit) {  
    *mDst++ = (UINT8)(((UINT8)(Data & 0xff));  
  }  
  
  if (mDst < mDstUpperLimit) {  
    *mDst++ = (UINT8)(((UINT8)(Data >> 0x08)) & 0xff);  
  }  
  
  if (mDst < mDstUpperLimit) {  
    *mDst++ = (UINT8)(((UINT8)(Data >> 0x10)) & 0xff);  
  }  
  
  if (mDst < mDstUpperLimit) {  
    *mDst++ = (UINT8)(((UINT8)(Data >> 0x18)) & 0xff);  
  }  
}
```

```
STATIC  
EFI_STATUS  
AllocateMemory ()  
/*++
```

Routine Description:

Allocate memory spaces for data structures used in compression process

Arguments: (VOID)

Returns:

EFI\_SUCCESS - Memory is allocated successfully  
EFI\_OUT\_OF\_RESOURCES - Allocation fails

```
--*/  
{  
  UINT32 i;  
  
  mText = malloc (WNDSIZ * 2 + MAXMATCH);  
  for (i = 0; i < WNDSIZ * 2 + MAXMATCH; i++) {  
    mText[i] = 0;  
  }  
  mLevel = malloc ((WNDSIZ + UINT8_MAX + 1) * sizeof(*mLevel));  
  mChildCount = malloc ((WNDSIZ + UINT8_MAX + 1) * sizeof(*mChildCount));  
  mPosition = malloc ((WNDSIZ + UINT8_MAX + 1) * sizeof(*mPosition));  
  mParent = malloc (WNDSIZ * 2 * sizeof(*mParent));  
  mPrev = malloc (WNDSIZ * 2 * sizeof(*mPrev));
```

## Unified Extensible Firmware Interface Specification

```
mNext = malloc ((MAX_HASH_VAL + 1) * sizeof(*mNext));

mBufSiz = 16 * 1024U;
while ((mBuf = malloc(mBufSiz)) == NULL) {
    mBufSiz = (mBufSiz / 10U) * 9U;
    if (mBufSiz < 4 * 1024U) {
        return EFI_OUT_OF_RESOURCES;
    }
}
mBuf[0] = 0;

return EFI_SUCCESS;
}
```

```
VOID
FreeMemory ()
/*++
```

Routine Description:

Called when compression is completed to free memory previously allocated.

Arguments: (VOID)

Returns: (VOID)

```
--*/
{
    if (mText) {
        free (mText);
    }

    if (mLevel) {
        free (mLevel);
    }

    if (mChildCount) {
        free (mChildCount);
    }

    if (mPosition) {
        free (mPosition);
    }

    if (mParent) {
        free (mParent);
    }

    if (mPrev) {
        free (mPrev);
    }

    if (mNext) {
        free (mNext);
    }

    if (mBuf) {
        free (mBuf);
    }

    return;
```



```
}
```

```
STATIC  
VOID  
InitSlide ()  
/*++
```

Routine Description:

Initialize String Info Log data structures

Arguments: (VOID)

Returns: (VOID)

```
--*/  
{  
  NODE i;  
  
  for (i = WNDSIZ; i <= WNDSIZ + UINT8_MAX; i++) {  
    mLevel[i] = 1;  
    mPosition[i] = NIL; /* sentinel */  
  }  
  for (i = WNDSIZ; i < WNDSIZ * 2; i++) {  
    mParent[i] = NIL;  
  }  
  mAvail = 1;  
  for (i = 1; i < WNDSIZ - 1; i++) {  
    mNext[i] = (NODE)(i + 1);  
  }  
  
  mNext[WNDSIZ - 1] = NIL;  
  for (i = WNDSIZ * 2; i <= MAX_HASH_VAL; i++) {  
    mNext[i] = NIL;  
  }  
}
```

```
STATIC  
NODE  
Child (  
  IN NODE q,  
  IN UINT8 c  
)  
/*++
```

Routine Description:

Find child node given the parent node and the edge character

Arguments:

q - the parent node  
c - the edge character

Returns:

The child node (NIL if not found)

```
--*/
```

## Unified Extensible Firmware Interface Specification

```
{
  NODE r;

  r = mNext[HASH(q, c)];
  mParent[NIL] = q; /* sentinel */
  while (mParent[r] != q) {
    r = mNext[r];
  }

  return r;
}
```

```
STATIC
VOID
MakeChild (
  IN NODE q,
  IN UINT8 c,
  IN NODE r
)
/*++
```

Routine Description:

Create a new child for a given parent node.

Arguments:

q - the parent node  
c - the edge character  
r - the child node

Returns: (VOID)

```
--*/
{
  NODE h, t;

  h = (NODE)HASH(q, c);
  t = mNext[h];
  mNext[h] = r;
  mNext[r] = t;
  mPrev[t] = r;
  mPrev[r] = h;
  mParent[r] = q;
  mChildCount[q]++;
}
```

```
STATIC
VOID
Split (
  NODE Old
)
/*++
```

Routine Description:

Split a node.

Arguments:

Old - the node to split

Returns: (VOID)

```
--*/
{
    NODE New, t;

    New = mAvail;
    mAvail = mNext[New];
    mChildCount[New] = 0;
    t = mPrev[Old];
    mPrev[New] = t;
    mNext[t] = New;
    t = mNext[Old];
    mNext[New] = t;
    mPrev[t] = New;
    mParent[New] = mParent[Old];
    mLevel[New] = (UINT8)mMatchLen;
    mPosition[New] = mPos;
    MakeChild(New, mText[mMatchPos + mMatchLen], Old);
    MakeChild(New, mText[mPos + mMatchLen], mPos);
}
```

```
STATIC
VOID
InsertNode ()
/*++
```

Routine Description:

Insert string info for current position into the String Info Log

Arguments: (VOID)

Returns: (VOID)

```
--*/
{
    NODE q, r, j, t;
    UINT8 c, *t1, *t2;

    if (mMatchLen >= 4) {

        //
        // We have just got a long match, the target tree
        // can be located by MatchPos + 1. Traverse the tree
        // from bottom up to get to a proper starting point.
        // The usage of PERC_FLAG ensures proper node deletion
        // in DeleteNode() later.
        //

        mMatchLen--;
        r = (INT16)((mMatchPos + 1) | WNDSIZ);
        while ((q = mParent[r]) == NIL) {
            r = mNext[r];
        }
        while (mLevel[q] >= mMatchLen) {
            r = q; q = mParent[q];
        }
        t = q;
        while (mPosition[t] < 0) {
```

## Unified Extensible Firmware Interface Specification

```
mPosition[t] = mPos;
t = mParent[t];
}
if (t < WNDSIZ) {
    mPosition[t] = (NODE)(mPos | PERC_FLAG);
}
} else {

//
// Locate the target tree
//

q = (INT16)(mText[mPos] + WNDSIZ);
c = mText[mPos + 1];
if ((r = Child(q, c)) == NIL) {
    MakeChild(q, c, mPos);
    mMatchLen = 1;
    return;
}
mMatchLen = 2;
}

//
// Traverse down the tree to find a match.
// Update Position value along the route.
// Node split or creation is involved.
//

for (;;) {
    if (r >= WNDSIZ) {
        j = MAXMATCH;
        mMatchPos = r;
    } else {
        j = mLevel[r];
        mMatchPos = (NODE)(mPosition[r] & ~PERC_FLAG);
    }
    if (mMatchPos >= mPos) {
        mMatchPos -= WNDSIZ;
    }
    t1 = &mText[mPos + mMatchLen];
    t2 = &mText[mMatchPos + mMatchLen];
    while (mMatchLen < j) {
        if (*t1 != *t2) {
            Split(r);
            return;
        }
        mMatchLen++;
        t1++;
        t2++;
    }
    if (mMatchLen >= MAXMATCH) {
        break;
    }
    mPosition[r] = mPos;
    q = r;
    if ((r = Child(q, *t1)) == NIL) {
        MakeChild(q, *t1, mPos);
        return;
    }
    mMatchLen++;
}
}
```

```

t = mPrev[r];
mPrev[mPos] = t;
mNext[t] = mPos;
t = mNext[r];
mNext[mPos] = t;
mPrev[t] = mPos;
mParent[mPos] = q;
mParent[r] = NIL;

//
// Special usage of 'next'
//
mNext[r] = mPos;

```

```

}

```

```

STATIC
VOID
DeleteNode ()
/*++

```

Routine Description:

Delete outdated string info. (The Usage of PERC\_FLAG ensures a clean deletion)

Arguments: (VOID)

Returns: (VOID)

```

--*/
{
    NODE q, r, s, t, u;

    if (mParent[mPos] == NIL) {
        return;
    }

    r = mPrev[mPos];
    s = mNext[mPos];
    mNext[r] = s;
    mPrev[s] = r;
    r = mParent[mPos];
    mParent[mPos] = NIL;
    if (r >= WNDSIZ || --mChildCount[r] > 1) {
        return;
    }
    t = (NODE)mPosition[r] & ~PERC_FLAG;
    if (t >= mPos) {
        t -= WNDSIZ;
    }
    s = t;
    q = mParent[r];
    while ((u = mPosition[q]) & PERC_FLAG) {
        u &= ~PERC_FLAG;
        if (u >= mPos) {
            u -= WNDSIZ;
        }
        if (u > s) {
            s = u;
        }
    }
}

```

## Unified Extensible Firmware Interface Specification

```
mPosition[q] = (INT16)(s | WNDSIZ);
q = mParent[q];
}
if (q < WNDSIZ) {
if (u >= mPos) {
u -= WNDSIZ;
}
if (u > s) {
s = u;
}
mPosition[q] = (INT16)(s | WNDSIZ | PERC_FLAG);
}
s = Child(r, mText[t + mLevel[r]]);
t = mPrev[s];
u = mNext[s];
mNext[t] = u;
mPrev[u] = t;
t = mPrev[r];
mNext[t] = s;
mPrev[s] = t;
t = mNext[r];
mPrev[t] = s;
mNext[s] = t;
mParent[s] = mParent[r];
mParent[r] = NIL;
mNext[r] = mAvail;
mAvail = r;
}
```

```
STATIC
VOID
GetNextMatch ()
/*++
```

### Routine Description:

Advance the current position (read in new data if needed).  
Delete outdated string info. Find a match string for current position.

Arguments: (VOID)

Returns: (VOID)

```
--*/
{
INT32 n;

mRemainder--;
if (++mPos == WNDSIZ * 2) {
memmove(&mText[0], &mText[WNDSIZ], WNDSIZ + MAXMATCH);
n = FreadCrc(&mText[WNDSIZ + MAXMATCH], WNDSIZ);
mRemainder += n;
mPos = WNDSIZ;
}
DeleteNode();
InsertNode();
}
```

```
STATIC
EFI_STATUS
Encode ()
```

```
/*++
```

Routine Description:

The main controlling routine for compression process.

Arguments: (VOID)

Returns:

EFI\_SUCCESS - The compression is successful  
EFI\_OUT\_OF\_RESOURCES - Not enough memory for compression process

```
--*/
```

```
{  
    EFI_STATUS Status;  
    INT32 LastMatchLen;  
    NODE LastMatchPos;  
  
    Status = AllocateMemory();  
    if (EFI_ERROR(Status)) {  
        FreeMemory();  
        return Status;  
    }  
  
    InitSlide();  
  
    HufEncodeStart();  
  
    mRemainder = FreadCrc(&mText[WNDSIZ], WNDSIZ + MAXMATCH);  
  
    mMatchLen = 0;  
    mPos = WNDSIZ;  
    InsertNode();  
    if (mMatchLen > mRemainder) {  
        mMatchLen = mRemainder;  
    }  
    while (mRemainder > 0) {  
        LastMatchLen = mMatchLen;  
        LastMatchPos = mMatchPos;  
        GetNextMatch();  
        if (mMatchLen > mRemainder) {  
            mMatchLen = mRemainder;  
        }  
  
        if (mMatchLen > LastMatchLen || LastMatchLen < THRESHOLD) {  
  
            //  
            // Not enough benefits are gained by outputting a pointer,  
            // so just output the original character  
            //  
  
            Output(mText[mPos - 1], 0);  
        } else {  
  
            //  
            // Outputting a pointer is beneficial enough, do it.  
            //  
  
            Output(LastMatchLen + (UINT8_MAX + 1 - THRESHOLD),  
                (mPos - LastMatchPos - 2) & (WNDSIZ - 1));  
        }  
    }  
}
```

## Unified Extensible Firmware Interface Specification

```
    while (--LastMatchLen > 0) {
        GetNextMatch();
    }
    if (mMatchLen > mRemainder) {
        mMatchLen = mRemainder;
    }
}
```

```
HufEncodeEnd();
FreeMemory();
return EFI_SUCCESS;
}
```

```
STATIC
VOID
CountTFreq ()
/*++
```

Routine Description:

Count the frequencies for the Extra Set

Arguments: (VOID)

Returns: (VOID)

```
--*/
{
    INT32 i, k, n, Count;

    for (i = 0; i < NT; i++) {
        mTFreq[i] = 0;
    }
    n = NC;
    while (n > 0 && mCLen[n - 1] == 0) {
        n--;
    }
    i = 0;
    while (i < n) {
        k = mCLen[i++];
        if (k == 0) {
            Count = 1;
            while (i < n && mCLen[i] == 0) {
                i++;
                Count++;
            }
            if (Count <= 2) {
                mTFreq[0] = (UINT16)(mTFreq[0] + Count);
            } else if (Count <= 18) {
                mTFreq[1]++;
            } else if (Count == 19) {
                mTFreq[0]++;
                mTFreq[1]++;
            } else {
                mTFreq[2]++;
            }
        } else {
            mTFreq[k + 2]++;
        }
    }
}
```



```

}

STATIC
VOID
WritePTLen (
  IN INT32 n,
  IN INT32 nbit,
  IN INT32 Special
)
/*++

```

Routine Description:

Outputs the code length array for the Extra Set or the Position Set.

Arguments:

n - the number of symbols  
 nbit - the number of bits needed to represent 'n'  
 Special - the special symbol that needs to be take care of

Returns: (VOID)

```

--*/
{
  INT32 i, k;

  while (n > 0 && mPTLen[n - 1] == 0) {
    n--;
  }
  PutBits(nbit, n);
  i = 0;
  while (i < n) {
    k = mPTLen[i++];
    if (k <= 6) {
      PutBits(3, k);
    } else {
      PutBits(k - 3, (1U << (k - 3)) - 2);
    }
    if (i == Special) {
      while (i < 6 && mPTLen[i] == 0) {
        i++;
      }
      PutBits(2, (i - 3) & 3);
    }
  }
}

```

```

STATIC
VOID
WriteCLen ()
/*++

```

Routine Description:

Outputs the code length array for Char&Length Set

Arguments: (VOID)

Returns: (VOID)

## Unified Extensible Firmware Interface Specification

```
--*/
{
  INT32 i, k, n, Count;

  n = NC;
  while (n > 0 && mCLen[n - 1] == 0) {
    n--;
  }
  PutBits(CBIT, n);
  i = 0;
  while (i < n) {
    k = mCLen[i++];
    if (k == 0) {
      Count = 1;
      while (i < n && mCLen[i] == 0) {
        i++;
        Count++;
      }
      if (Count <= 2) {
        for (k = 0; k < Count; k++) {
          PutBits(mPTLen[0], mPTCode[0]);
        }
      } else if (Count <= 18) {
        PutBits(mPTLen[1], mPTCode[1]);
        PutBits(4, Count - 3);
      } else if (Count == 19) {
        PutBits(mPTLen[0], mPTCode[0]);
        PutBits(mPTLen[1], mPTCode[1]);
        PutBits(4, 15);
      } else {
        PutBits(mPTLen[2], mPTCode[2]);
        PutBits(CBIT, Count - 20);
      }
    } else {
      PutBits(mPTLen[k + 2], mPTCode[k + 2]);
    }
  }
}

STATIC
VOID
EncodeC (
  IN INT32 c
)
{
  PutBits(mCLen[c], mCCode[c]);
}

STATIC
VOID
EncodeP (
  IN UINT32 p
)
{
  UINT32 c, q;

  c = 0;
  q = p;
  while (q) {
    q >>= 1;
    c++;
  }
}
```

```

}
PutBits(mPTLen[c], mPTCode[c]);
if (c > 1) {
    PutBits(c - 1, p & (0xFFFFU >> (17 - c)));
}
}
}

```

```

STATIC
VOID
SendBlock ()
/*++

```

Routine Description:

Huffman code the block and output it.

Argument: (VOID)

Returns: (VOID)

```

--*/
{
    UINT32 i, k, Flags, Root, Pos, Size;
    Flags = 0;

    Root = MakeTree(NC, mCFreq, mCLen, mCCode);
    Size = mCFreq[Root];
    PutBits(16, Size);
    if (Root >= NC) {
        CountTFreq();
        Root = MakeTree(NT, mTFreq, mPTLen, mPTCode);
        if (Root >= NT) {
            WritePTLen(NT, TBIT, 3);
        } else {
            PutBits(TBIT, 0);
            PutBits(TBIT, Root);
        }
        WriteCLen();
    } else {
        PutBits(TBIT, 0);
        PutBits(TBIT, 0);
        PutBits(CBIT, 0);
        PutBits(CBIT, Root);
    }
    Root = MakeTree(NP, mPFreq, mPTLen, mPTCode);
    if (Root >= NP) {
        WritePTLen(NP, PBIT, -1);
    } else {
        PutBits(PBIT, 0);
        PutBits(PBIT, Root);
    }
    Pos = 0;
    for (i = 0; i < Size; i++) {
        if (i % UINT8_BIT == 0) {
            Flags = mBuf[Pos++];
        } else {
            Flags <<= 1;
        }
    }
    if (Flags & (1U << (UINT8_BIT - 1))) {
        EncodeC(mBuf[Pos++] + (1U << UINT8_BIT));
        k = mBuf[Pos++] << UINT8_BIT;
    }
}

```

## Unified Extensible Firmware Interface Specification

```
    k += mBuf[Pos++];
    EncodeP(k);
  } else {
    EncodeC(mBuf[Pos++]);
  }
}
for (i = 0; i < NC; i++) {
  mCFreq[i] = 0;
}
for (i = 0; i < NP; i++) {
  mPFreq[i] = 0;
}
}
```

```
STATIC
VOID
Output (
  IN UINT32 c,
  IN UINT32 p
)
/*++
```

Routine Description:

Outputs an Original Character or a Pointer

Arguments:

c - The original character or the 'String Length' element of a Pointer  
p - The 'Position' field of a Pointer

Returns: (VOID)

```
--*/
{
  STATIC UINT32 CPos;

  if ((mOutputMask >>= 1) == 0) {
    mOutputMask = 1U << (UINT8_BIT - 1);
    if (mOutputPos >= mBufSiz - 3 * UINT8_BIT) {
      SendBlock();
      mOutputPos = 0;
    }
    CPos = mOutputPos++;
    mBuf[CPos] = 0;
  }
  mBuf[mOutputPos++] = (UINT8) c;
  mCFreq[c]++;
  if (c >= (1U << UINT8_BIT)) {
    mBuf[CPos] |= mOutputMask;
    mBuf[mOutputPos++] = (UINT8)(p >> UINT8_BIT);
    mBuf[mOutputPos++] = (UINT8) p;
    c = 0;
    while (p) {
      p >>= 1;
      C++;
    }
    mPFreq[c]++;
  }
}
```

```

STATIC
VOID
HufEncodeStart ()
{
    INT32 i;

    for (i = 0; i < NC; i++) {
        mCFreq[i] = 0;
    }
    for (i = 0; i < NP; i++) {
        mPFreq[i] = 0;
    }
    mOutputPos = mOutputMask = 0;
    InitPutBits();
    return;
}

```

```

STATIC
VOID
HufEncodeEnd ()
{
    SendBlock();

    //
    // Flush remaining bits
    //
    PutBits(UINT8_BIT - 1, 0);

    return;
}

```

```

STATIC
VOID
MakeCrcTable ()
{
    UINT32 i, j, r;

    for (i = 0; i <= UINT8_MAX; i++) {
        r = i;
        for (j = 0; j < UINT8_BIT; j++) {
            if (r & 1) {
                r = (r >> 1) ^ CRCPOLY;
            } else {
                r >>= 1;
            }
        }
        mCrcTable[i] = (UINT16)r;
    }
}

```

```

STATIC
VOID
PutBits (
    IN INT32 n,
    IN UINT32 x
)
/*++

```

Routine Description:

## Unified Extensible Firmware Interface Specification

Outputs rightmost n bits of x

Arguments:

n - the rightmost n bits of the data is used

x - the data

Returns: (VOID)

```
--*/
{
    UINT8 Temp;

    if (n < mBitCount) {
        mSubBitBuf |= x << (mBitCount - n);
    } else {

        Temp = (UINT8)(mSubBitBuf | (x >> (n - mBitCount)));
        if (mDst < mDstUpperLimit) {
            *mDst++ = Temp;
        }
        mCompSize++;

        if (n < UINT8_BIT) {
            mSubBitBuf = x << (mBitCount - UINT8_BIT - n);
        } else {

            Temp = (UINT8)(x >> (n - UINT8_BIT));
            if (mDst < mDstUpperLimit) {
                *mDst++ = Temp;
            }
            mCompSize++;

            mSubBitBuf = x << (mBitCount - 2 * UINT8_BIT - n);
        }
    }
}
```

```
STATIC
INT32
FreadCrc (
    OUT UINT8 *p,
    IN INT32 n
)
/*++
```

Routine Description:

Read in source data

Arguments:

p - the buffer to hold the data

n - number of bytes to read

Returns:

number of bytes actually read

```
--*/
```

```

{
  INT32 i;

  for (i = 0; mSrc < mSrcUpperLimit && i < n; i++) {
    *p++ = *mSrc++;
  }
  n = i;

  p -= n;
  mOrigSize += n;
  while (--i >= 0) {
    UPDATE_CRC(*p++);
  }
  return n;
}

```

```

STATIC
VOID
InitPutBits ()
{
  mBitCount = UINT8_BIT;
  mSubBitBuf = 0;
}

```

```

STATIC
VOID
CountLen (
  IN INT32 i
)
/*++

```

Routine Description:

Count the number of each code length for a Huffman tree.

Arguments:

i - the top node

Returns: (VOID)

```

--*/
{
  STATIC INT32 Depth = 0;

  if (i < mN) {
    mLenCnt[(Depth < 16) ? Depth : 16]++;
  } else {
    Depth++;
    CountLen(mLeft [i]);
    CountLen(mRight[i]);
    Depth--;
  }
}

```

```

STATIC
VOID
MakeLen (
  IN INT32 Root
)

```

## Unified Extensible Firmware Interface Specification

```
/*++
```

Routine Description:

Create code length array for a Huffman tree

Arguments:

Root - the root of the tree

```
--*/
{
    INT32 i, k;
    UINT32 Cum;

    for (i = 0; i <= 16; i++) {
        mLenCnt[i] = 0;
    }
    CountLen(Root);

    //
    // Adjust the length count array so that
    // no code will be generated longer than the designated length
    //

    Cum = 0;
    for (i = 16; i > 0; i--) {
        Cum += mLenCnt[i] << (16 - i);
    }
    while (Cum != (1U << 16)) {
        mLenCnt[16]--;
        for (i = 15; i > 0; i--) {
            if (mLenCnt[i] != 0) {
                mLenCnt[i]--;
                mLenCnt[i+1] += 2;
                break;
            }
        }
        Cum--;
    }
    for (i = 16; i > 0; i--) {
        k = mLenCnt[i];
        while (--k >= 0) {
            mLen[*mSortPtr++] = (UINT8)i;
        }
    }
}

STATIC
VOID
DownHeap (
    IN INT32 i
)
{
    INT32 j, k;

    //
    // priority queue: send i-th entry down heap
    //

    k = mHeap[i];
```



```

while ((j = 2 * i) <= mHeapSize) {
  if (j < mHeapSize && mFreq[mHeap[j]] > mFreq[mHeap[j + 1]]) {
    j++;
  }
  if (mFreq[k] <= mFreq[mHeap[j]]) {
    break;
  }
  mHeap[i] = mHeap[j];
  i = j;
}
mHeap[i] = (INT16)k;
}

```

```

STATIC
VOID
MakeCode (
  IN INT32 n,
  IN UUINT8 Len[],
  OUT UUINT16 Code[]
)
/*++

```

Routine Description:

Assign code to each symbol based on the code length array

Arguments:

n - number of symbols  
 Len - the code length array  
 Code - stores codes for each symbol

Returns: (VOID)

```

--*/
{
  INT32 i;
  UUINT16 Start[18];

  Start[1] = 0;
  for (i = 1; i <= 16; i++) {
    Start[i + 1] = (UUINT16)((Start[i] + mLenCnt[i]) << 1);
  }
  for (i = 0; i < n; i++) {
    Code[i] = Start[Len[i]]++;
  }
}

```

```

STATIC
INT32
MakeTree (
  IN INT32 NParm,
  IN UUINT16 FreqParm[],
  OUT UUINT8 LenParm[],
  OUT UUINT16 CodeParm[]
)
/*++

```

Routine Description:

Generates Huffman codes given a frequency distribution of symbols

## Unified Extensible Firmware Interface Specification

### Arguments:

NParm - number of symbols  
FreqParm - frequency of each symbol  
LenParm - code length for each symbol  
CodeParm - code for each symbol

### Returns:

Root of the Huffman tree.

```
--*/
{
  INT32 i, j, k, Avail;

  //
  // make tree, calculate len[], return root
  //

  mN = NParm;
  mFreq = FreqParm;
  mLen = LenParm;
  Avail = mN;
  mHeapSize = 0;
  mHeap[1] = 0;
  for (i = 0; i < mN; i++) {
    mLen[i] = 0;
    if (mFreq[i]) {
      mHeap[++mHeapSize] = (INT16)i;
    }
  }
  if (mHeapSize < 2) {
    CodeParm[mHeap[1]] = 0;
    return mHeap[1];
  }
  for (i = mHeapSize / 2; i >= 1; i--) {

    //
    // make priority queue
    //
    DownHeap(i);
  }
  mSortPtr = CodeParm;
  do {
    i = mHeap[1];
    if (i < mN) {
      *mSortPtr++ = (UINT16)i;
    }
    mHeap[1] = mHeap[mHeapSize--];
    DownHeap(1);
    j = mHeap[1];
    if (j < mN) {
      *mSortPtr++ = (UINT16)j;
    }
    k = Avail++;
    mFreq[k] = (UINT16)(mFreq[i] + mFreq[j]);
    mHeap[1] = (INT16)k;
    DownHeap(1);
    mLeft[k] = (UINT16)i;
    mRight[k] = (UINT16)j;
  } while (mHeapSize > 1);
}
```

```
} while (mHeapSize > 1);  
  
mSortPtr = CodeParm;  
MakeLen(k);  
MakeCode(NParm, LenParm, CodeParm);  
  
//  
// return root  
//  
return k;  
}
```



# Appendix I Decompression Source Code

---

```

=/*++

Copyright (c) 2001–2002 Intel Corporation

Module Name:

    Decompress.c

Abstract:

    Decompressor.

--*/

#include "EfiCommon.h"

#define BITBUFSIZ 16
#define WNDBIT 13
#define WNSIZ (1U << WNDBIT)
#define MAXMATCH 256
#define THRESHOLD 3
#define CODE_BIT 16
#define UINT8_MAX 0xff
#define BAD_TABLE -1

//
// C: Char&Len Set; P: Position Set; T: exTra Set
//

#define NC (0xff + MAXMATCH + 2 - THRESHOLD)
#define CBIT 9
#define NP (WNDBIT + 1)
#define NT (CODE_BIT + 3)
#define PBIT 4
#define TBIT 5
#if NT > NP
#define NPT NT
#else
#define NPT NP
#endif

typedef struct {
    UINT8 *mSrcBase; //Starting address of compressed data
    UINT8 *mDstBase; //Starting address of decompressed data

    UINT16 mBytesRemain;
    UINT16 mBitCount;
    UINT16 mBitBuf;
    UINT16 mSubBitBuf;
    UINT16 mBufSiz;
    UINT16 mBlockSize;
    UINT32 mDataIdx;
    UINT32 mCompSize;
    UINT32 mOrigSize;
};

```

## Unified Extensible Firmware Interface Specification

```
UINT32 mOutBuf;
UINT32 mInBuf;

UINT16 mBadTableFlag;

UINT8 mBuffer[WNDSIZ];
UINT16 mLeft[2 * NC - 1];
UINT16 mRight[2 * NC - 1];
UINT32 mBuf;
UINT8 mCLen[NC];
UINT8 mPTLen[NPT];
UINT16 mCTable[4096];
UINT16 mPTTable[256];
} SCRATCH_DATA;

//
// Function Prototypes
//

STATIC
VOID
FillBuf (
    IN SCRATCH_DATA *Sd,
    IN UINT16 NumOfBits
);

STATIC
VOID
Decode (
    SCRATCH_DATA *Sd,
    UINT16 NumOfBytes
);

//
// Functions
//

EFL_STATUS
EFIAPI
GetInfo (
    IN EFL_DECOMPRESS_PROTOCOL *This,
    IN VOID *Source,
    IN UINT32 SrcSize,
    OUT UINT32 *DstSize,
    OUT UINT32 *ScratchSize
)
/**++
```

Routine Description:

The implementation of EFL\_DECOMPRESS\_PROTOCOL.GetInfo().

Arguments:

This - Protocol instance pointer.  
Source - The source buffer containing the compressed data.  
SrcSize - The size of source buffer  
DstSize - The size of destination buffer.  
ScratchSize - The size of scratch buffer.

Returns:

EFI\_SUCCESS - The size of destination buffer and the size of scratch buffer are successful retrieved.  
EFI\_INVALID\_PARAMETER - The source data is corrupted

```
--*/
{
    UINT8 *Src;

    *ScratchSize = sizeof (SCRATCH_DATA);

    Src = Source;
    if (SrcSize < 8) {
        return EFI_INVALID_PARAMETER;
    }

    *DstSize = Src[4] + (Src[5] << 8) + (Src[6] << 16) + (Src[7] << 24);
    return EFI_SUCCESS;
}
```

```
EFI_STATUS
EFIAPI
Decompress (
    IN EFI_DECOMPRESS_PROTOCOL *This,
    IN VOID *Source,
    IN UINT32 SrcSize,
    IN OUT VOID *Destination,
    IN UINT32 DstSize,
    IN OUT VOID *Scratch,
    IN UINT32 ScratchSize
)
/*++
```

Routine Description:

The implementation of EFI\_DECOMPRESS\_PROTOCOL.Decompress().

Arguments:

This - The protocol instance.  
Source - The source buffer containing the compressed data.  
SrcSize - The size of the source buffer  
Destination - The destination buffer to store the decompressed data  
DstSize - The size of the destination buffer.  
Scratch - The buffer used internally by the decompress routine. This buffer is needed to store intermediate data.  
ScratchSize - The size of scratch buffer.

Returns:

EFI\_SUCCESS - Decompression is successful  
EFI\_INVALID\_PARAMETER - The source data is corrupted

```
--*/
{
    UINT32 Index;
    UINT16 Count;
    UINT32 CompSize;
    UINT32 OrigSize;
```

## Unified Extensible Firmware Interface Specification

```
UINT8 *Dst1;
EFI_STATUS Status;
SCRATCH_DATA *Sd;
UINT8 *Src;
UINT8 *Dst;

Status = EFI_SUCCESS;
Src = Source;
Dst = Destination;
Dst1 = Dst;

if (ScratchSize < sizeof(SCRATCH_DATA)) {
    return EFI_INVALID_PARAMETER;
}

Sd = (SCRATCH_DATA *)Scratch;

if (SrcSize < 8) {
    return EFI_INVALID_PARAMETER;
}

CompSize = Src[0] + (Src[1] << 8) + (Src[2] << 16) + (Src[3] << 24);
OrigSize = Src[4] + (Src[5] << 8) + (Src[6] << 16) + (Src[7] << 24);

if (SrcSize < CompSize + 8) {
    return EFI_INVALID_PARAMETER;
}

Src = Src + 8;

for (Index = 0; Index < sizeof(SCRATCH_DATA); Index++) {
    ((UINT8*)Sd)[Index] = 0;
}

Sd->mBytesRemain = (UINT16)(-1);
Sd->mSrcBase = Src;
Sd->mDstBase = Dst;
Sd->mCompSize = CompSize;
Sd->mOrigSize = OrigSize;

//
// Fill the first two bytes
//
FillBuf(Sd, BITBUFSIZ);

while (Sd->mOrigSize > 0) {

    Count = (UINT16) (WNDSIZ < Sd->mOrigSize? WNDSIZ: Sd->mOrigSize);
    Decode (Sd, Count);

    if (Sd->mBadTableFlag != 0) {
        //
        // Something wrong with the source
        //
        return EFI_INVALID_PARAMETER;
    }

    for (Index = 0; Index < Count; Index ++) {
        if (Dst1 < Dst + DstSize) {
            *Dst1++ = Sd->mBuffer[Index];
        } else {
```



```

    return EFI_INVALID_PARAMETER;
}
}

Sd->mOrigSize -= Count;
}

if (Sd->mBadTableFlag != 0) {
    Status = EFI_INVALID_PARAMETER;
} else {
    Status = EFI_SUCCESS;
}

return Status;
}

```

```

STATIC
VOID
FillBuf (
    IN SCRATCH_DATA *Sd,
    IN UINT16  NumOfBits
)
/*++

```

Routine Description:

Shift mBitBuf NumOfBits left. Read in NumOfBits of bits from source.

Arguments:

Sd - The global scratch data  
 NumOfBit - The number of bits to shift and read.

Returns: (VOID)

```

--*/
{
    Sd->mBitBuf = (UINT16)(Sd->mBitBuf << NumOfBits);

    while (NumOfBits > Sd->mBitCount) {

        Sd->mBitBuf |= (UINT16)(Sd->mSubBitBuf <<
            (NumOfBits = (UINT16)(NumOfBits - Sd->mBitCount)));

        if (Sd->mCompSize > 0) {

            //
            // Get 1 byte into SubBitBuf
            //
            Sd->mCompSize--;
            Sd->mSubBitBuf = 0;
            Sd->mSubBitBuf = Sd->mSrcBase[Sd->mInBuf++];
            Sd->mBitCount = 8;

        } else {

            Sd->mSubBitBuf = 0;
            Sd->mBitCount = 8;

        }
    }
}

```

## Unified Extensible Firmware Interface Specification

```
    }  
  
    Sd->mBitCount = (UINT16)(Sd->mBitCount - NumOfBits);  
    Sd->mBitBuf |= Sd->mSubBitBuf >> Sd->mBitCount;  
}
```

```
STATIC  
UINT16  
GetBits(  
    IN SCRATCH_DATA *Sd,  
    IN UINT16 NumOfBits  
)  
/*++
```

Routine Description:

Get NumOfBits of bits out from mBitBuf. Fill mBitBuf with subsequent NumOfBits of bits from source. Returns NumOfBits of bits that are popped out.

Arguments:

Sd - The global scratch data.  
NumOfBits - The number of bits to pop and read.

Returns:

The bits that are popped out.

```
--*/  
{  
    UINT16 OutBits;  
  
    OutBits = (UINT16)(Sd->mBitBuf >> (BITBUFSIZ - NumOfBits));  
  
    FillBuf (Sd, NumOfBits);  
  
    return OutBits;  
}
```

```
STATIC  
UINT16  
MakeTable (  
    IN SCRATCH_DATA *Sd,  
    IN UINT16 NumOfChar,  
    IN UINT8 *BitLen,  
    IN UINT16 TableBits,  
    OUT UINT16 *Table  
)  
/*++
```

Routine Description:

Creates Huffman Code mapping table according to code length array.

Arguments:

Sd - The global scratch data  
NumOfChar - Number of symbols in the symbol set

BitLen - Code length array  
TableBits - The width of the mapping table  
Table - The table

Returns:

0 - OK.  
BAD\_TABLE - The table is corrupted.

```
--*/
{
    UUINT16 Count[17];
    UUINT16 Weight[17];
    UUINT16 Start[18];
    UUINT16 *p;
    UUINT16 k;
    UUINT16 i;
    UUINT16 Len;
    UUINT16 Char;
    UUINT16 JuBits;
    UUINT16 Avail;
    UUINT16 NextCode;
    UUINT16 Mask;

    for (i = 1; i <= 16; i++) {
        Count[i] = 0;
    }

    for (i = 0; i < NumOfChar; i++) {
        Count[BitLen[i]]++;
    }

    Start[1] = 0;

    for (i = 1; i <= 16; i++) {
        Start[i + 1] = (UUINT16)(Start[i] + (Count[i] << (16 - i)));
    }

    if (Start[17] != 0) /*(1U << 16)*/
        return (UUINT16)BAD_TABLE;
    }

    JuBits = (UUINT16)(16 - TableBits);

    for (i = 1; i <= TableBits; i++) {
        Start[i] >>= JuBits;
        Weight[i] = (UUINT16)(1U << (TableBits - i));
    }

    while (i <= 16) {
        Weight[i++] = (UUINT16)(1U << (16 - i));
    }

    i = (UUINT16)(Start[TableBits + 1] >> JuBits);

    if (i != 0) {
        k = (UUINT16)(1U << TableBits);
        while (i != k) {
            Table[i++] = 0;
        }
    }
}
```

## Unified Extensible Firmware Interface Specification

```
    }

    Avail = NumOfChar;
    Mask = (UINT16)(1U << (15 - TableBits));

    for (Char = 0; Char < NumOfChar; Char++) {

        Len = BitLen[Char];
        if (Len == 0) {
            continue;
        }

        NextCode = (UINT16)(Start[Len] + Weight[Len]);

        if (Len <= TableBits) {

            for (i = Start[Len]; i < NextCode; i++) {
                Table[i] = Char;
            }

        } else {

            k = Start[Len];
            p = &Table[k >> JuBits];
            i = (UINT16)(Len - TableBits);

            while (i != 0) {
                if (*p == 0) {
                    Sd->mRight[Avail] = Sd->mLeft[Avail] = 0;
                    *p = Avail++;
                }

                if (k & Mask) {
                    p = &Sd->mRight[*p];
                } else {
                    p = &Sd->mLeft[*p];
                }

                k <<= 1;
                i--;
            }

            *p = Char;
        }

        Start[Len] = NextCode;
    }

    //
    // Succeeds
    //
    return 0;
}

STATIC
UINT16
DecodeP (
    IN SCRATCH_DATA *Sd
)
```

```

/*++

Routine description:

Decodes a position value.

Arguments:

Sd - the global scratch data

Returns:

The position value decoded.

--*/
{
    UINT16 Val;
    UINT16 Mask;

    Val = Sd->mPTTable[Sd->mBitBuf >> (BITBUFSIZ - 8)];

    if (Val >= NP) {
        Mask = 1U << (BITBUFSIZ - 1 - 8);

        do {

            if (Sd->mBitBuf & Mask) {
                Val = Sd->mRight[Val];
            } else {
                Val = Sd->mLeft[Val];
            }

            Mask >>= 1;
        } while (Val >= NP);
    }

    //
    // Advance what we have read
    //
    FillBuf (Sd, Sd->mPTLen[Val]);

    if (Val) {
        Val = (UINT16)((1U << (Val - 1)) + GetBits (Sd, (UINT16)(Val - 1)));
    }

    return Val;
}

STATIC
UINT16
ReadPTLen (
    IN SCRATCH_DATA *Sd,
    IN UINT16 nn,
    IN UINT16 nbit,
    IN UINT16 Special
)
/*++

```

Routine Description

## Unified Extensible Firmware Interface Specification

Reads code lengths for the Extra Set or the Position Set

Arguments:

Sd - The global scratch data  
nn - Number of symbols  
nbit - Number of bits needed to represent nn  
Special - The special symbol that needs to be taken care of

Returns:

0 - OK.  
BAD\_TABLE - Table is corrupted.

```
--*/
{
  UUINT16 n;
  UUINT16 c;
  UUINT16 i;
  UUINT16 Mask;

  n = GetBits (Sd, nbit);

  if (n == 0) {
    c = GetBits (Sd, nbit);

    for (i = 0; i < 256; i++) {
      Sd->mPTTable[i] = c;
    }

    for (i = 0; i < nn; i++) {
      Sd->mPTLen[i] = 0;
    }

    return 0;
  }

  i = 0;

  while (i < n) {

    c = (UUINT16)(Sd->mBitBuf >> (BITBUFSIZ - 3));

    if (c == 7) {
      Mask = 1U << (BITBUFSIZ - 1 - 3);
      while (Mask & Sd->mBitBuf) {
        Mask >>= 1;
        c += 1;
      }
    }

    FillBuf (Sd, (UUINT16)((c < 7) ? 3 : c - 3));

    Sd->mPTLen [i++] = (UUINT8)c;

    if (i == Special) {
      c = GetBits (Sd, 2);
      while ((INT16)(--c) >= 0) {
        Sd->mPTLen[i++] = 0;
      }
    }
  }
}
```

```

}

while (i < nn) {
    Sd->mPTLen [i++] = 0;
}

return ( MakeTable (Sd, nn, Sd->mPTLen, 8, Sd->mPTTable));
}

```

```

STATIC
VOID
ReadCLen (
    SCRATCH_DATA *Sd
)
/*++

```

Routine Description:

Reads code lengths for Char&Len Set.

Arguments:

Sd - the global scratch data

Returns: (VOID)

```

--*/
{
    UINT16 n;
    UINT16 c;
    UINT16 i;
    UINT16 Mask;

    n = GetBits(Sd, CBIT);

    if (n == 0) {
        c = GetBits(Sd, CBIT);

        for (i = 0; i < NC; i++) {
            Sd->mCLen[i] = 0;
        }

        for (i = 0; i < 4096; i++) {
            Sd->mCTable[i] = c;
        }

        return;
    }

    i = 0;
    while (i < n) {

        c = Sd->mPTTable[Sd->mBitBuf >> (BITBUFSIZ - 8)];
        if (c >= NT) {
            Mask = 1U << (BITBUFSIZ - 1 - 8);

            do {

                if (Mask & Sd->mBitBuf) {
                    c = Sd->mRight [c];

```

## Unified Extensible Firmware Interface Specification

```
    } else {
        c = Sd->mLeft [c];
    }

    Mask >>= 1;

}while (c >= NT);
}

//
// Advance what we have read
//
FillBuf (Sd, Sd->mPTLen[c]);

if (c <= 2) {

    if (c == 0) {
        c = 1;
    } else if (c == 1) {
        c = (UINT16)(GetBits (Sd, 4) + 3);
    } else if (c == 2) {
        c = (UINT16)(GetBits (Sd, CBIT) + 20);
    }

    while ((INT16)(--c) >= 0) {
        Sd->mCLen[i++] = 0;
    }

} else {

    Sd->mCLen[i++] = (UINT8)(c - 2);

}
}

while (i < NC) {
    Sd->mCLen[i++] = 0;
}

MakeTable (Sd, NC, Sd->mCLen, 12, Sd->mCTable);

return;
}
```

```
STATIC
UINT16
DecodeC (
    SCRATCH_DATA *Sd
)
/*++
```

### Routine Description:

Decode a character/length value.

### Arguments:

Sd - The global scratch data.

### Returns:



The value decoded.

```

--*/
{
    UINT16 j;
    UINT16 Mask;

    if (Sd->mBlockSize == 0) {

        //
        // Starting a new block
        //

        Sd->mBlockSize = GetBits(Sd, 16);
        Sd->mBadTableFlag = ReadPTLen (Sd, NT, TBIT, 3);
        if (Sd->mBadTableFlag != 0) {
            return 0;
        }

        ReadCLen (Sd);

        Sd->mBadTableFlag = ReadPTLen (Sd, NP, PBIT, (UINT16)(-1));
        if (Sd->mBadTableFlag != 0) {
            return 0;
        }
    }

    Sd->mBlockSize --;
    j = Sd->mCTable[Sd->mBitBuf >> (BITBUFSIZ - 12)];

    if (j >= NC) {
        Mask = 1U << (BITBUFSIZ - 1 - 12);

        do {
            if (Sd->mBitBuf & Mask) {
                j = Sd->mRight[j];
            } else {
                j = Sd->mLeft[j];
            }

            Mask >>= 1;
        } while (j >= NC);
    }

    //
    // Advance what we have read
    //
    FillBuf(Sd, Sd->mCLen[j]);

    return j;
}

STATIC
VOID
Decode (
    SCRATCH_DATA *Sd,
    UINT16 NumOfBytes
)
/*++
```

## Unified Extensible Firmware Interface Specification

### Routine Description:

Decode NumOfBytes and put the resulting data at starting point of mBuffer.  
The buffer is circular.

### Arguments:

Sd - The global scratch data  
NumOfBytes - Number of bytes to decode

### Returns: (VOID)

```
--*/
{
  UINT16 di;
  UINT16 r;
  UINT16 c;

  r = 0;
  di = 0;

  Sd->mBytesRemain --;
  while ((INT16)(Sd->mBytesRemain) >= 0) {
    Sd->mBuffer[di++] = Sd->mBuffer[Sd->mDataIdx++];

    if (Sd->mDataIdx >= WNDSIZ) {
      Sd->mDataIdx -= WNDSIZ;
    }

    r ++;
    if (r >= NumOfBytes) {
      return;
    }
    Sd->mBytesRemain --;
  }

  for (;;) {
    c = DecodeC (Sd);
    if (Sd->mBadTableFlag != 0) {
      return;
    }

    if (c < 256) {

      //
      // Process an Original character
      //

      Sd->mBuffer[di++] = (UINT8)c;
      r ++;
      if (di >= WNDSIZ) {
        return;
      }

    } else {

      //
      // Process a Pointer
      //
```

```

c = (UINT16)(c - (UINT8_MAX + 1 - THRESHOLD));
Sd->mBytesRemain = c;

Sd->mDataIdx = (r - DecodeP(Sd) - 1) & (WNDSIZ - 1); //Make circular

di = r;

Sd->mBytesRemain --;
while ((INT16)(Sd->mBytesRemain) >= 0) {
    Sd->mBuffer[di++] = Sd->mBuffer[Sd->mDataIdx++];
    if (Sd->mDataIdx >= WNDSIZ) {
        Sd->mDataIdx -= WNDSIZ;
    }

    r ++;
    if (di >= WNDSIZ) {
        return;
    }
    Sd->mBytesRemain --;
}
}
}

return;
}

```



## Appendix J

# EFI Byte Code Virtual Machine Opcode List

---

The following table lists the opcodes for EBC instructions. Note that opcodes only require 6 bits of the opcode byte of EBC instructions. The other two bits are used for other encodings that are dependent on the particular instruction.

Table 244. EBC Virtual Machine Opcode Summary

Opcode	Description
0x00	<b>BREAK</b> [break code]
0x01	<b>JMP</b> <sub>32</sub> {cs cc} {@}R <sub>1</sub> {Immed32 Index32} <b>JMP</b> <sub>64</sub> {cs cc} Immed64
0x02	<b>JMP8</b> {cs cc} Immed8
0x03	<b>CALL</b> <sub>32</sub> {EX}{a} {@}R <sub>1</sub> {Immed32 Index32} <b>CALL</b> <sub>64</sub> {EX}{a} Immed64
0x04	<b>RET</b>
0x05	<b>CMP</b> <sub>[32 64]</sub> eq R <sub>1</sub> , {@}R <sub>2</sub> {Index16 Immed16}
0x06	<b>CMP</b> <sub>[32 64]</sub> lte R <sub>1</sub> , {@}R <sub>2</sub> {Index16 Immed16}
0x07	<b>CMP</b> <sub>[32 64]</sub> gte R <sub>1</sub> , {@}R <sub>2</sub> {Index16 Immed16}
0x08	<b>CMP</b> <sub>[32 64]</sub> ulte R <sub>1</sub> , {@}R <sub>2</sub> {Index16 Immed16}
0x09	<b>CMP</b> <sub>[32 64]</sub> ugte R <sub>1</sub> , {@}R <sub>2</sub> {Index16 Immed16}
0x0A	<b>NOT</b> <sub>[32 64]</sub> {@}R <sub>1</sub> , {@}R <sub>2</sub> {Index16 Immed16}
0x0B	<b>NEG</b> <sub>[32 64]</sub> {@}R <sub>1</sub> , {@}R <sub>2</sub> {Index16 Immed16}
0x0C	<b>ADD</b> <sub>[32 64]</sub> {@}R <sub>1</sub> , {@}R <sub>2</sub> {Index16 Immed16}
0x0D	<b>SUB</b> <sub>[32 64]</sub> {@}R <sub>1</sub> , {@}R <sub>2</sub> {Index16 Immed16}
0x0E	<b>MUL</b> <sub>[32 64]</sub> {@}R <sub>1</sub> , {@}R <sub>2</sub> {Index16 Immed16}
0x0F	<b>MULU</b> <sub>[32 64]</sub> {@}R <sub>1</sub> , {@}R <sub>2</sub> {Index16 Immed16}
0x10	<b>DIV</b> <sub>[32 64]</sub> {@}R <sub>1</sub> , {@}R <sub>2</sub> {Index16 Immed16}
0x11	<b>DIVU</b> <sub>[32 64]</sub> {@}R <sub>1</sub> , {@}R <sub>2</sub> {Index16 Immed16}
0x12	<b>MOD</b> <sub>[32 64]</sub> {@}R <sub>1</sub> , {@}R <sub>2</sub> {Index16 Immed16}
0x13	<b>MODU</b> <sub>[32 64]</sub> {@}R <sub>1</sub> , {@}R <sub>2</sub> {Index16 Immed16}
0x14	<b>AND</b> <sub>[32 64]</sub> {@}R <sub>1</sub> , {@}R <sub>2</sub> {Index16 Immed16}
0x15	<b>OR</b> <sub>[32 64]</sub> {@}R <sub>1</sub> , {@}R <sub>2</sub> {Index16 Immed16}
0x16	<b>XOR</b> <sub>[32 64]</sub> {@}R <sub>1</sub> , {@}R <sub>2</sub> {Index16 Immed16}
0x17	<b>SHL</b> <sub>[32 64]</sub> {@}R <sub>1</sub> , {@}R <sub>2</sub> {Index16 Immed16}
0x18	<b>SHR</b> <sub>[32 64]</sub> {@}R <sub>1</sub> , {@}R <sub>2</sub> {Index16 Immed16}
0x19	<b>ASHR</b> <sub>[32 64]</sub> {@}R <sub>1</sub> , {@}R <sub>2</sub> {Index16 Immed16}
0x1A	<b>EXTNDB</b> <sub>[32 64]</sub> {@}R <sub>1</sub> , {@}R <sub>2</sub> {Index16 Immed16}
0x1B	<b>EXTNDW</b> <sub>[32 64]</sub> {@}R <sub>1</sub> , {@}R <sub>2</sub> {Index16 Immed16}
0x1C	<b>EXTNDD</b> <sub>[32 64]</sub> {@}R <sub>1</sub> , {@}R <sub>2</sub> {Index16 Immed16}
0x1D	<b>MOV</b> <sub>bw</sub> {@}R <sub>1</sub> {Index16}, {@}R <sub>2</sub> {Index16}

Opcode	Description
0x1E	<a href="#">MOV</a> <sub>ww</sub> {@}R <sub>1</sub> {Index16}, {@}R <sub>2</sub> {Index16}
0x1F	<a href="#">MOV</a> <sub>dw</sub> {@}R <sub>1</sub> {Index16}, {@}R <sub>2</sub> {Index16}
0x20	<a href="#">MOV</a> <sub>qw</sub> {@}R <sub>1</sub> {Index16}, {@}R <sub>2</sub> {Index16}
0x21	<a href="#">MOV</a> <sub>bd</sub> {@}R <sub>1</sub> {Index32}, {@}R <sub>2</sub> {Index32}
0x22	<a href="#">MOV</a> <sub>wd</sub> {@}R <sub>1</sub> {Index32}, {@}R <sub>2</sub> {Index32}
0x23	<a href="#">MOV</a> <sub>dd</sub> {@}R <sub>1</sub> {Index32}, {@}R <sub>2</sub> {Index32}
0x24	<a href="#">MOV</a> <sub>qd</sub> {@}R <sub>1</sub> {Index32}, {@}R <sub>2</sub> {Index32}
0x25	<a href="#">MOVsn</a> <sub>w</sub> {@}R <sub>1</sub> {Index16}, {@}R <sub>2</sub> {Index16 Immed16}
0x26	<a href="#">MOVsn</a> <sub>d</sub> {@}R <sub>1</sub> {Index32}, {@}R <sub>2</sub> {Index32 Immed32}
0x27	Reserved
0x28	<a href="#">MOV</a> <sub>qq</sub> {@}R <sub>1</sub> {Index64}, {@}R <sub>2</sub> {Index64}
0x29	<a href="#">LOADSP</a> [Flags], R <sub>2</sub>
0x2A	<a href="#">STORESP</a> R <sub>1</sub> , [IP Flags]
0x2B	<a href="#">PUSH</a> <sub>[32 64]</sub> {@}R <sub>1</sub> {Index16 Immed16}
0x2C	<a href="#">POP</a> <sub>[32 64]</sub> {@}R <sub>1</sub> {Index16 Immed16}
0x2D	<a href="#">CMP</a> <sub>[32 64]</sub> <sub>[w d]</sub> eq {@}R <sub>1</sub> {Index16}, Immed16 Immed32
0x2E	<a href="#">CMP</a> <sub>[32 64]</sub> <sub>[w d]</sub> lte {@}R <sub>1</sub> {Index16}, Immed16 Immed32
0x2F	<a href="#">CMP</a> <sub>[32 64]</sub> <sub>[w d]</sub> gte {@}R <sub>1</sub> {Index16}, Immed16 Immed32
0x30	<a href="#">CMP</a> <sub>[32 64]</sub> <sub>[w d]</sub> ulte {@}R <sub>1</sub> {Index16}, Immed16 Immed32
0x31	<a href="#">CMP</a> <sub>[32 64]</sub> <sub>[w d]</sub> ugte {@}R <sub>1</sub> {Index16}, Immed16 Immed32
0x32	<a href="#">MOVn</a> <sub>w</sub> {@}R <sub>1</sub> {Index16}, {@}R <sub>2</sub> {Index16}
0x33	<a href="#">MOVn</a> <sub>d</sub> {@}R <sub>1</sub> {Index32}, {@}R <sub>2</sub> {Index32}
0x34	Reserved
0x35	<a href="#">PUSHn</a> {@}R <sub>1</sub> {Index16 Immed16}
0x36	<a href="#">POPn</a> {@}R <sub>1</sub> {Index16 Immed16}
0x37	<a href="#">MOVI</a> <sub>[b w d q]</sub> <sub>[w d q]</sub> {@}R <sub>1</sub> {Index16}, Immed16 32 64
0x38	<a href="#">MOVIn</a> <sub>[w d q]</sub> {@}R <sub>1</sub> {Index16}, Index16 32 64
0x39	<a href="#">MOVREL</a> <sub>[w d q]</sub> {@}R <sub>1</sub> {Index16}, Immed16 32 64
0x3A	Reserved
0x3B	Reserved
0x3C	Reserved
0x3D	Reserved
0x3E	Reserved
0x3F	Reserved





# Appendix K Alphabetic Function Lists

---

This appendix was redacted in version 2.6.



# Appendix L

## EFI 1.10 Protocol Changes and Deprecation List

---

### L.1 Protocol and GUID Name Changes from EFI 1.10

This appendix lists the Protocol , GUID, and revision identifier name changes and the deprecated protocols compared to the *EFI Specification 1.10*. The protocols listed are not Runtime, Reentrant or MP Safe. Protocols are listed by EFI 1.10 name.

For protocols in the table whose TPL is not  $\leq$  TPL\_NOTIFY:

This function must be called at a TPL level less than or equal to %%%.

%% is TPL\_CALLBACK or TPL\_APPLICATION. The  $\leq$  is done via text.

**Table 245. Protocol Name changes**

<b>EFI 1.10 Protocol Name</b>	<b>UEFI Specification Protocol Name</b>
EFI_LOADED_IMAGE	EFI_LOADED_IMAGE_PROTOCOL
<i>TPL</i>	<= TPL_NOTIFY
New GUID name	EFI_LOADED_IMAGE_PROTOCOL_GUID
EFI_DEVICE_PATH	EFI_DEVICE_PATH_PROTOCOL
<i>TPL</i>	<= TPL_NOTIFY
New GUID name	EFI_DEVICE_PATH_PROTOCOL_GUID
SIMPLE_INPUT_INTERFACE	EFI_SIMPLE_INPUT_PROTOCOL
<i>TPL</i>	<= TPL_APPLICATION
New GUID name	EFI_SIMPLE_INPUT_PROTOCOL_GUID
SIMPLE_TEXT_OUTPUT_INTERFACE	EFI_SIMPLE_TEXT_OUTPUT_PROTOCOL
<i>TPL</i>	<= TPL_CALLBACK
New GUID name	EFI_SIMPLE_TEXT_OUTPUT_PROTOCOL_GUID
SERIAL_IO_INTERFACE	EFI_SERIAL_IO_PROTOCOL
<i>TPL</i>	<= TPL_CALLBACK
New GUID name	EFI_SERIAL_IO_PROTOCOL_GUID
EFI_LOAD_FILE_INTERFACE	EFI_LOAD_FILE_PROTOCOL
<i>TPL</i>	<= TPL_NOTIFY
New GUID name	EFI_LOAD_FILE_PROTOCOL_GUID
EFI_FILE_IO_INTERFACE	EFI_SIMPLE_FILE_SYSTEM_PROTOCOL
<i>TPL</i>	<= TPL_CALLBACK
New GUID name	EFI_FILE_SYSTEM_PROTOCOL_GUID
EFI_FILE	EFI_FILE_PROTOCOL
<i>TPL</i>	<= TPL_CALLBACK
New GUID name	EFI_FILE_PROTOCOL_GUID
EFI_DISK_IO	EFI_DISK_IO_PROTOCOL
<i>TPL</i>	<= TPL_CALLBACK
New GUID name	EFI_DISK_IO_PROTOCOL_GUID
EFI_BLOCK_IO	EFI_BLOCK_IO_PROTOCOL
<i>TPL</i>	<= TPL_CALLBACK
New GUID name	EFI_BLOCK_IO_PROTOCOL_GUID
UNICODE_COLLATION_INTERFACE	EFI_UNICODE_COLLATION_PROTOCOL
<i>TPL</i>	<= TPL_NOTIFY
New GUID name	EFI_UNICODE_COLLATION_PROTOCOL_GUID
EFI_SIMPLE_NETWORK	EFI_SIMPLE_NETWORK_PROTOCOL
<i>TPL</i>	<= TPL_CALLBACK
New GUID name	EFI_SIMPLE_NETWORK_PROTOCOL_GUID
EFI_NETWORK_INTERFACE_IDENTIFIER_INTERFACE	EFI_NETWORK_INTERFACE_IDENTIFIER_PROTOCOL

EFI 1.10 Protocol Name	UEFI Specification Protocol Name
TPL	<= TPL_NOTIFY
New GUID name	EFI_NETWORK_INTERFACE_IDENTIFIER_PROTOCOL_GUID
EFI_PXE_BASE_CODE	EFI_PXE_BASE_CODE_PROTOCOL
TPL	<= TPL_NOTIFY
New GUID name	EFI_PXE_BASE_CODE_PROTOCOL_GUID
EFI_PXE_BASE_CODE_CALLBACK	EFI_PXE_BASE_CODE_CALLBACK_PROTOCOL
TPL	<= TPL_NOTIFY
New GUID name	EFI_PXE_BASE_CODE_CALLBACK_PROTOCOL_GUID
EFI_DEVICE_IO_INTERFACE	EFI_DEVICE_IO_PROTOCOL
TPL	<= TPL_NOTIFY
New GUID name	EFI_DEVICE_IO_PROTOCOL_GUID

**Table 246. Revision Identifier Name Changes**

EFI 1.10 Revision Identifier Name	UEFI Specification Revision Identifier Name
EFI_LOADED_IMAGE_INFORMATION_REVISION	EFI_LOADED_IMAGE_PROTOCOL_REVISION
SERIAL_IO_INTERFACE_REVISION	EFI_SERIAL_IO_PROTOCOL_REVISION
EFI_FILE_IO_INTERFACE_REVISION	EFI_SIMPLE_FILE_SYSTEM_PROTOCOL_REVISION
EFI_FILE_REVISION	EFI_FILE_PROTOCOL_REVISION
EFI_DISK_IO_INTERFACE_REVISION	EFI_DISK_IO_PROTOCOL_REVISION
EFI_BLOCK_IO_INTERFACE_REVISION	EFI_BLOCK_IO_PROTOCOL_REVISION
EFI_SIMPLE_NETWORK_INTERFACE_REVISION	EFI_SIMPLE_NETWORK_PROTOCOL_REVISION
EFI_NETWORK_INTERFACE_IDENTIFIER_INTERFACE_REVISION	EFI_NETWORK_INTERFACE_IDENTIFIER_PROTOCOL_REVISION
EFI_PXE_BASE_CODE_INTERFACE_REVISION	EFI_PXE_BASE_CODE_PROTOCOL_REVISION
EFI_PXE_BASE_CODE_CALLBACK_INTERFACE_REVISION	EFI_PXE_BASE_CODE_CALLBACK_PROTOCOL_REVISION

## L.2 Deprecated Protocols

**Device I/O Protocol** – The support of the Device I/O Protocol (see EFI 1.1 Chapter 18) has been replaced by the use of the **PCI Root Bridge I/O** protocols which are described in [Section 14.2](#) of the UEFI Specification. Note: certain “legacy” EFI applications such as some of the ones that reside in the EFI Toolkit assume the presence of Device I/O.

**UGA I/O + UGA Draw Protocol** – The support of the UGA \* Protocols (see EFI 1.1 Section 10.7) have been replaced by the use of the **EFI Graphics Output Protocol** described in [Section 12](#) of the UEFI Specification.

**USB Host Controller Protocol** (version that existed for EFI 1.1) – The support of the USB Host Controller Protocol (see EFI 1.1 Section 14.1) has been replaced by the use of a UEFI instance that covers both USB 1.1 and USB 2.0 support, and is described in [Section 17](#) of the UEFI Specification. It replaces the pre-existing protocol definition.

**SCSI Passthru Protocol** – The support of the SCSI Passthru Protocol (see EFI 1.1 Section 13.1) has been replaced by the use of the **Extended SCSI Passthru Protocol** which is described in Chapter [Section 15.7](#) of the UEFI Specification.

**BIS Protocol** – Remains as an optional protocol.

**Driver Configuration Protocol** - the **EFI\_DRIVER\_CONFIGURATION\_PROTOCOL** has been removed.

# Appendix M Formats — Language Codes and Language Code Arrays

---

This appendix lists the formats for language codes and language code arrays.

## M.1 Specifying individual language codes

The preferred representation of a language code is done via an RFC 4646 language code identifier\*.

**Table 247. Alias codes supported in addition to RFC 4646**

RFC string	Supported Alias String
zh-Hans	zh-chs
zh-Hant	zh-cht

An RFC 4646 language code is represented as a null-terminated ASCII string.

An RFC 4646 language string must be constructed according to the tag creation rules in section 2.3 of RFC 4646. For example, when constructing the primary language tag for a locale identifier, if a 2 character ISO 639-1 language code exists along with a 3 character ISO 639-2 language code, then the ISO 639-1 language code must be used. Further, if an ISO 639-1 tag does not exist, then the ISO 639-2/T (Terminology) tag must be for the primary locale before an ISO 639-2/B (Bibliographic) tag may be used. See RFC 4646 for a complete discussion of this topic.

To provide backwards compatibility with preexisting EFI 1.10 drivers, a UEFI platforms may support deprecated protocols which represent languages in the ISO 639-2 format.

This includes the following protocols: **UNICODE\_COLLATION\_INTERFACE**, **EFI\_DRIVER\_CONFIGURATION\_PROTOCOL**,

**EFI\_DRIVER\_DIAGNOSTICS\_PROTOCOL**, and **EFI\_COMPONENT\_NAME\_PROTOCOL**.

The deprecated *LangCodes* and *Lang* global variables may also be supported by a platform for backwards compatibility.

### M.1.1 Specifying language code arrays:

Native RFC 4646 format array:

An array of RFC 4646 character codes is represented as a NULL terminated char8 array of RFC 4646 language code strings. Each of these strings is delimited by a semicolon (;) character. For example, an array of US English and Traditional Chinese would be represented as the NULL-terminated string "en-us;zh-Hant".





# Appendix N Common Platform Error Record

---

## N.1 Introduction

This appendix describes the common platform error record format for representing platform hardware errors.

## N.2 Format

The general format of the common platform error record is illustrated in [Figure 152](#). The record consists of a header; followed by one or more section descriptors; and for each descriptor, an associated section which may contain either error or informational data.

---

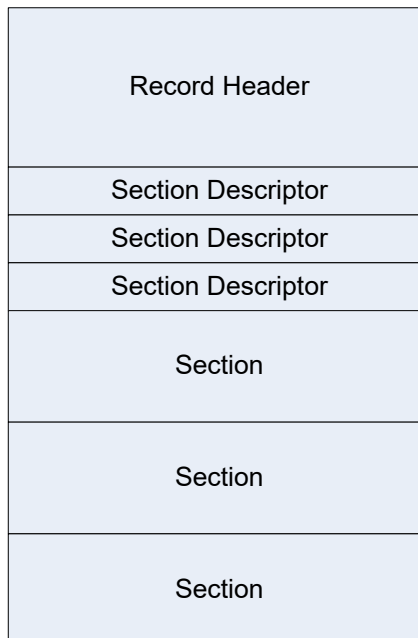

Figure 152. Error Record Format

### N.2.1 Record Header

The record header includes information which uniquely identifies a hardware error record on a given system. The contents of the record header are described in [Table 248](#). The header is immediately followed by an array of one or more section descriptors. Sections may be either error sections, which contain error information retrieved from hardware, or they may be informational sections, which contain contextual information relevant to the error. An error record must contain at least one section.

Table 248. Error record header

Mnemonic	Byte Offset	Byte Length	Description
Signature Start	0	4	ASCII 4-character array "CPER" (0x43,0x50,0x45,0x52). Identifies this structure as a hardware error record.
Revision	4	2	This is a 2-byte field representing a major and minor version number for the error record definition in BCD format. The interpretation of the major and minor version number is as follows: <ul style="list-style-type: none"> <li>• Byte 0 – Minor (01): An increase in this revision indicates that changes to the headers and sections are backward compatible with software that use earlier revisions. Addition of new GUID types, errata fixes or clarifications are covered by a bump up.</li> <li>• Byte 1 – Major (01): An increase in this revision indicates that the changes are not backward compatible from a software perspective.</li> </ul>
Signature End	6	4	Must be 0xFFFFFFFF
Section Count	10	2	This field indicates the number of valid sections associated with the record, corresponding to each of the following section descriptors.
Error Severity	12	4	Indicates the severity of the error condition. The severity of the error record corresponds to the most severe error section. <ul style="list-style-type: none"> <li>0 - Recoverable (also called non-fatal uncorrected)</li> <li>1 - Fatal</li> <li>2 - Corrected</li> <li>3 - Informational</li> </ul> All other values are reserved. Note that severity of "Informational" indicates that the record could be safely ignored by error handling software.
Validation Bits	16	4	This field indicates the validity of the following fields: <ul style="list-style-type: none"> <li>• Bit 0 – If 1, the PlatformID field contains valid information</li> <li>• Bit 1 – If 1, the TimeStamp field contains valid information</li> <li>• Bit2 – If 1, the PartitionID field contains valid information</li> <li>• Bits 3-31: Reserved, must be zero.</li> </ul>
Record Length	20	4	Indicates the size of the actual error record, including the size of the record header, all section descriptors, and section bodies. The size may include extra buffer space to allow for the dynamic addition of error sections descriptors and bodies.

Mnemonic	Byte Offset	Byte Length	Description
Timestamp	24	8	<p>The timestamp correlates to the time when the error information was collected by the system software and may not necessarily represent the time of the error event. The timestamp contains the local time in BCD format.</p> <ul style="list-style-type: none"> <li>• Byte 7 – Byte 0:</li> <li>• Byte 0: Seconds</li> <li>• Byte 1: Minutes</li> <li>• Byte 2: Hours</li> <li>• Byte 3:</li> <li>• Bit 0 – Timestamp is precise if this bit</li> <li>• is set and correlates to the time of the</li> <li>• error event.</li> <li>• Bit 7:1 – Reserved</li> <li>• Byte 4: Day</li> <li>• Byte 5: Month</li> <li>• Byte 6: Year</li> <li>• Byte 7: Century</li> </ul>
Platform ID	32	16	<p>This field uniquely identifies the platform with a GUID. The platform's SMBIOS UUID should be used to populate this field. Error analysis software may use this value to uniquely identify a platform.</p>
Partition ID	48	16	<p>If the platform has multiple software partitions, system software may associate a GUID with the partition on which the error occurred.</p>
Creator ID	64	16	<p>This field contains a GUID indicating the creator of the error record. This value may be overwritten by subsequent owners of the record.</p>

## Unified Extensible Firmware Interface Specification

Mnemonic	Byte Offset	Byte Length	Description
Notification Type	80	16	<p>This field holds a pre-assigned GUID value indicating the record association with an error event notification type. The defined types are:</p> <p>CMC {0x2DCE8BB1, 0xBDD7, 0x450e, {0xB9, 0xAD, 0x9C, 0xF4, 0xEB, 0xD4, 0xF8, 0x90}}</p> <p>CPE {0x4E292F96, 0xD843, 0x4a55, {0xA8, 0xC2, 0xD4, 0x81, 0xF2, 0x7E, 0xBE, 0xEE}}</p> <p>MCE {0xE8F56FFE, 0x919C, 0x4cc5, {0xBA, 0x88, 0x65, 0xAB, 0xE1, 0x49, 0x13, 0xBB}}</p> <p>PCIe {0xCF93C01F, 0x1A16, 0x4dfc, {0xB8, 0xBC, 0x9C, 0x4D, 0xAF, 0x67, 0xC1, 0x04}}</p> <p>INIT {0xCC5263E8, 0x9308, 0x454a, {0x89, 0xD0, 0x34, 0x0B, 0xD3, 0x9B, 0xC9, 0x8E}}</p> <p>NMI {0x5BAD89FF, 0xB7E6, 0x42c9, {0x81, 0x4A, 0xCF, 0x24, 0x85, 0xD6, 0xE9, 0x8A}}</p> <p>Boot {0x3D61A466, 0xAB40, 0x409a, {0xA6, 0x98, 0xF3, 0x62, 0xD4, 0x64, 0xB3, 0x8F}}</p> <p>DMAr {0x667DD791, 0xC6B3, 0x4c27, {0x8A, 0x6B, 0x0F, 0x8E, 0x72, 0x2D, 0xEB, 0x41}}</p>
Record ID	96	8	This value, when combined with the Creator ID, uniquely identifies the error record across other error records on a given system.
Flags	104	4	Flags field contains information that describes the error record. See Table 2 for defined flags.
Persistence Information	108	8	This field is produced and consumed by the creator of the error record identified in the Creator ID field. The format of this field is defined by the creator and it is out of scope of this specification.
Reserved	116	12	Reserved. Must be zero.

Mnemonic	Byte Offset	Byte Length	Description
Section Descriptor	128	Nx72	An array of <i>SectionCount</i> descriptors for the associated sections. The number of valid sections is equivalent to the <i>SectionCount</i> . The buffer size of the record may include more space to dynamically add additional Section Descriptors to the error record.

[Table 249](#) lists the flags that may be used to qualify an error record in the Error Record Header's Flags field.

**Table 249. Error Record Header Flags**

Value	Description
1	HW_ERROR_FLAGS_RECOVERED: Qualifies an error condition as one that has been recovered by system software.
2	HW_ERROR_FLAGS_PREVERR: Qualifies an error condition as one that occurred during a previous session. For instance, if the OS detects an error and determines that the system must be reset; it will save the error record before stopping the system. Upon restarting the OS marks the error record with this flag to know that the error is not live.
4	HW_ERROR_FLAGS_SIMULATED: Qualifies an error condition as one that was intentionally caused. This allows system software to recognize errors that are injected as a means of validating or testing error handling mechanisms.

### N.2.1.1 Notification Type

A notification type identifies the mechanism by which an error event is reported to system software. This information helps consumers of error information (e.g. management applications or humans) by identifying the source of the error information. This allows, for instance, all CMC error log entries to be filtered from an error event log.

Listed below are the standard notification types. Each standard notification type is identified by a GUID. For error notification types that do not conform to one of the standard types, a platform-specific GUID may be defined to identify the notification type.

- Machine Check Exception (MCE): {0xE8F56FFE, 0x919C, 0x4cc5, {0xBA, 0x88, 0x65, 0xAB, 0xE1, 0x49, 0x13, 0xBB}}
- A Machine Check Exception is a processor-generated exception class interrupt used to system software of the presence of a fatal or recoverable error condition.
- Corrected Machine Check (CMC): {0x2DCE8BB1, 0xBDD7, 0x450e, {0xB9, 0xAD, 0x9C, 0xF4, 0xEB, 0xD4, 0xF8, 0x90}}
- Corrected Machine Checks identify error conditions that have been corrected by hardware or system firmware. CMCs are reported by the processor and may be reported via interrupt or by polling error status registers.
- Corrected Platform Error (CPE): {0x4E292F96, 0xD843, 0x4a55, {0xA8, 0xC2, 0xD4, 0x81, 0xF2, 0x7E, 0xBE, 0xEE}}

Corrected Platform Errors identify corrected errors from the platform (i.e., external memory controller, system bus, etc.). CPEs can be reported via interrupt or by polling error status registers.

- Non-Maskable Interrupt (NMI): {0x5BAD89FF, 0xB7E6, 0x42c9, {0x81, 0x4A, 0xCF, 0x24, 0x85, 0xD6, 0xE9, 0x8A}}

Non-Maskable Interrupts are used on X64 platforms to report fatal or recoverable platform error conditions. NMIs are reported via interrupt vector 2 on IA32 and X64 processor architecture platforms.

- PCI Express Error (PCIe): {0xCF93C01F, 0x1A16, 0x4dfc, {0xB8, 0xBC, 0x9C, 0x4D, 0xAF, 0x67, 0xC1, 0x04}}

See the PCI Express standard v1.1 for details regarding PCI Express Error Reporting. This notification type identifies errors that were reported to the system via an interrupt on a PCI Express root port.

- INIT Record (INIT): {0xCC5263E8, 0x9308, 0x454a, {0x89, 0xD0, 0x34, 0x0B, 0xD3, 0x9B, 0xC9, 0x8E}}

IPF Platforms optionally implement a mechanism (switch or button on the chassis) by which an operator may reset a system and have the system generate an INIT error record. This error record is documented in the IPF SAL specification. System software retrieves an INIT error record by querying the SAL for existing INIT records.

- BOOT Error Record (BOOT): {0x3D61A466, 0xAB40, 0x409a, {0xA6, 0x98, 0xF3, 0x62, 0xD4, 0x64, 0xB3, 0x8F}}

The BOOT Notification Type represents error conditions which are unhandled by system software and which result in a system shutdown/reset. System software retrieves a BOOT error record during boot by querying the platform for existing BOOT records. As an example, consider an x64 platform which implements a service processor. In some scenarios, the service processor may detect that the system is either hung or is in such a state that it cannot safely proceed without risking data corruption. In such a scenario the service processor may record some minimal error information in its system event log (SEL) and unilaterally reset the machine without notifying the OS or other system software. In such scenarios, system software is unaware of the condition that caused the system reset. A BOOT error record would contain information that describes the error condition that led to the reset so system software can log the information and use it for health monitoring.

- DMA Remapping Error (DMAr): {0x667DD791, 0xC6B3, 0x4c27, {0x8A, 0x6B, 0x0F, 0x8E, 0x72, 0x2D, 0xEB, 0x41}}

The DMA Remapping Notification Type identifies fault conditions generated by the DMAr unit when processing un-translated, translation and translated DMA requests. The fault conditions are reported to the system using a message signaled interrupt.

- Synchronous External Abort (SEA): {0x9A78788A, 0xBBE8, 0x11E4, {0x80, 0x9E, 0x67, 0x61, 0x1E, 0x5D, 0x46, 0xB0}}

Synchronous External Aborts represent *precise* processor error conditions on ARM systems (uncorrectable and/or recoverable) as described in D3.5 of the ARMv8 ARM reference manual. This notification may be triggered by one of the following scenarios: cache parity error, cache ECC error, external bus error, micro-architectural error, data poisoning, and other platform errors.

- SError Interrupt (SEI): {0x5C284C81, 0xB0AE, 0x4E87, {0xA3, 0x22, 0xB0, 0x4C, 0x85, 0x62, 0x43, 0x23}}

SError Interrupts represent asynchronous *imprecise* (or possibly precise) processor error conditions on ARM systems (corrected, uncorrectable, and recoverable) as described in D3.5 of the ARM ARM reference manual. This notification may be triggered by one of the following scenarios: cache parity error, cache ECC error, external bus error, micro-architectural error, data poisoning, and other platform errors.

- Platform Error Interrupt (PEI): {0x09A9D5AC, 0x5204, 0x4214, {0x96, 0xE5, 0x94, 0x99, 0x2E, 0x75, 0x2B, 0xCD}}

Platform Error Interrupt represent asynchronous *imprecise* platform error conditions on ARM systems that may be triggered by the following scenarios: system memory ECC error, ECC errors in system cache (e.g. shared high-level caches), vendor specific chip errors, external platform errors.

## N.2.2 Section Descriptor

Table 250. Section Descriptor

Mnemonic	Byte Offset	Byte Length	Description
Section Offset	0	4	Offset in bytes of the section body from the base of the record header.
Section Length	4	4	The length in bytes of the section body.
Revision	8	2	This is a 2-byte field representing a major and minor version number for the error record definition in BCD format. The interpretation of the major and minor version number is as follows: <ul style="list-style-type: none"> <li>• Byte 0 – Minor (00): An increase in this revision indicates that changes to the headers and sections are backward compatible with software that uses earlier revisions. Addition of new GUID types, errata fixes or clarifications are covered by a bump up.</li> <li>• Byte 1 – Major (01): An increase in this revision indicates that the changes are not backward compatible from a software perspective</li> </ul>
Validation Bits	10	1	This field indicates the validity of the following fields: <ul style="list-style-type: none"> <li>• Bit 0 - If 1, the FRUId field contains valid information</li> <li>• Bit 1 - If 1, the FRUString field contains valid information</li> </ul> Bits 7:2 – Reserved, must be zero.
Reserved	11	1	Must be zero.



Mnemonic	Byte Offset	Byte Length	Description
Flags	12	4	<p>Flag field contains information that describes the error section as follows:</p> <p>Bit 0 – Primary: If set, identifies the section as the section to be associated with the error condition. This allows for FRU determination and for error recovery operations. By identifying a primary section, the consumer of an error record can determine which section to focus on. It is not always possible to identify a primary section so this flag should be taken as a hint.</p> <p>Bit 1 – Containment Warning: If set, the error was not contained within the processor or memory hierarchy and the error may have propagated to persistent storage or network.</p> <p>Bit 2 – Reset: If set, the component has been reset and must be re-initialized or re-enabled by the operating system prior to use.</p> <p>Bit 3 – Error threshold exceeded: If set, OS may choose to discontinue use of this resource.</p> <p>Bit 4 – Resource not accessible: If set, the resource could not be queried for error information due to conflicts with other system software or resources. Some fields of the section will be invalid.</p> <p>Bit 5 – Latent error: If set this flag indicates that action has been taken to ensure error containment (such a poisoning data), but the error has not been fully corrected and the data has not been consumed. System software may choose to take further corrective action before the data is consumed.</p> <p>Bit 6 - Propagated: If set this flag indicates the section is to be associated with an error that has been propagated due to hardware poisoning. This implies the error is a symptom of another error. It is not always possible to ascertain whether this is the case for an error, therefore if the flag is not set, it is unknown whether the error was propagated. this helps determining FRU when dealing with HW failures.</p> <p>Bit 7 - Overflow: If set this flag indicates the firmware has detected an overflow of buffers/queues that are used to accumulate, collect, or report errors (e.g. the error status control block exposed to the OS). When this occurs, some error records may be lost.</p> <p>Bit 8 through 31 – Reserved.</p>

## Unified Extensible Firmware Interface Specification

Mnemonic	Byte Offset	Byte Length	Description
Section Type	16	16	<p>This field holds a pre-assigned GUID value indicating that it is a section of a particular error. The different error section types are as defined below:</p> <p>Processor Generic</p> <ul style="list-style-type: none"> <li>• {0x9876CCAD, 0x47B4, 0x4bdb, {0xB6, 0x5E, 0x16, 0xF1, 0x93, 0xC4, 0xF3, 0xDB}}</li> </ul> <p>Processor Specific</p> <ul style="list-style-type: none"> <li>• IA32/X64: {0xDC3EA0B0, 0xA144, 0x4797, {0xB9, 0x5B, 0x53, 0xFA, 0x24, 0x2B, 0x6E, 0x1D}}</li> <li>• IPF: {0xe429faf1, 0x3cb7, 0x11d4, {0xb, 0xca, 0x7, 0x00, 0x80, 0xc7, 0x3c, 0x88, 0x81}}<sup>1</sup></li> <li>• ARM: { 0xE19E3D16, 0xBC11, 0x11E4, {0x9C, 0xAA, 0xC2, 0x05, 0x1D, 0x5D, 0x46, 0xB0}}</li> </ul> <p>NOTE: In addition to the types listed above, there may exist vendor specific GUIDs that describe vendor specific section types.</p> <p>Platform Memory</p> <ul style="list-style-type: none"> <li>• {0xA5BC1114, 0x6F64, 0x4EDE, {0xB8, 0x63, 0x3E, 0x83, 0xED, 0x7C, 0x83, 0xB1}}</li> </ul> <p>PCIe}}</p> <ul style="list-style-type: none"> <li>• {0xD995E954, 0xBBC1, 0x430F, {0xAD, 0x91, 0xB4, 0x4D, 0xCB, 0x3C, 0x6F, 0x35}}</li> </ul> <p>Firmware Error Record Reference</p> <ul style="list-style-type: none"> <li>• {0x81212A96, 0x09ED, 0x4996, {0x94, 0x71, 0x8D, 0x72, 0x9C, 0x8E, 0x69, 0xED}}</li> </ul> <p>PCI/PCI-X Bus</p> <ul style="list-style-type: none"> <li>• {0xC5753963, 0x3B84, 0x4095, {0xBF, 0x78, 0xED, 0xDA, 0xD3, 0xF9, 0xC9, 0xDD}}</li> </ul> <p>PCI Component/Device</p> <ul style="list-style-type: none"> <li>• {0xEB5E4685, 0xCA66, 0x4769, {0xB6, 0xA2, 0x26, 0x06, 0x8B, 0x00, 0x13, 0x26}}</li> </ul> <p>DMAr Generic</p> <ul style="list-style-type: none"> <li>• {0x5B51FEF7, 0xC79D, 0x4434, {0x8F, 0x1B, 0xAA, 0x62, 0xDE, 0x3E, 0x2C, 0x64}}</li> </ul> <p>Intel® VT for Directed I/O specific DMAr section</p> <ul style="list-style-type: none"> <li>• {0x71761D37, 0x32B2, 0x45cd, {0xA7, 0xD0, 0xB0, 0xFE 0xDD, 0x93, 0xE8, 0xCF}}</li> </ul> <p>IOMMU specific DMAr section</p> <ul style="list-style-type: none"> <li>• {0x036F84E1, 0x7F37, 0x428c, {0xA7, 0x9E, 0x57, 0x5F, 0xDF, 0xAA, 0x84, 0xEC}}</li> </ul>
FRU Id	32	16	<p>GUID representing the FRU ID, if it exists, for the section reporting the error. The default value is zero indicating an invalid FRU ID. System software can use this to uniquely identify a physical device for tracking purposes. Association of a GUID to a physical device is done by the platform in an implementation-specific way (i.e., PCIe Device can lock a GUID to a PCIe Device ID).</p>

Mnemonic	Byte Offset	Byte Length	Description
Section Severity	48	4	This field indicates the severity associated with the error section. 0 – Recoverable (also called non-fatal uncorrected) 1 – Fatal 2 – Corrected 3 – Informational All other values are reserved. Note that severity of "Informational" indicates that the section contains extra information that can be safely ignored by error handling software.
FRU Text	52	20	ASCII string identifying the FRU hardware.

1. For an IPF processor-specific error section, the GUID listed is the value from section B.2.3 of the SAL specification. The format of the data for this section is same as the Processor Device Error Info in the SAL specification.

## N.2.3 Non-standard Section Body

Information that does not conform to one the standard formats (i.e., those defined in sections 2.4 through 2.9 of this document) may be recorded in the error record in a non-standard section. The type (e.g. format) of a non-standard section is identified by the GUID populated in the *Section Descriptor's Section Type* field. This allows the information to be decoded by consumers if the format is externally documented. Examples of information that might be placed in a non-standard section include the IPF raw SAL error record, Error information recorded in implementation-specific PCI configuration space, and IPMI error information recorded in an IPMI SEL.

## N.2.4 Processor Error Sections

The processor error sections are divided into two different components as described below:

1. Processor Generic Error Section: This section holds information about processor errors in a generic form and will be common across all processor architectures. An example of error information provided is the generic information of cache, tlb, etc., errors.
2. Processor Specific Error Section: This section consists of error information, which is specific to a processor architecture. In addition, certain processor architecture state at the time of error may also be captured in this section. This section is unique to each processor architecture (Itanium Processor Family, IA32/X64, ARM).

### N.2.4.1 Generic Processor Error Section

The Generic Processor Error Section describes processor reported hardware errors for logical processors in the system.

Section Type: {0x9876CCAD, 0x47B4, 0x4bdb, {0xB6, 0x5E, 0x16, 0xF1, 0x93, 0xC4, 0xF3, 0xDB}}

Table 251. Processor Generic Error Section

Name	Byte Offset	Byte Length	Description
Validation Bits	0	8	The validation bit mask indicates whether or not each of the following fields is valid in this section. Bit 0 – Processor Type Valid Bit 1 – Processor ISA Valid Bit 2 – Processor Error Type Valid Bit 3 – Operation Valid Bit 4 – Flags Valid Bit 5 – Level Valid Bit 6 – CPU Version Valid Bit 7 – CPU Brand Info Valid Bit 8 – CPU Id Valid Bit 9 – Target Address Valid Bit 10 – Requester Identifier Valid Bit 11 – Responder Identifier Valid Bit 12 – Instruction IP Valid All other bits are reserved and must be zero.
Processor Type	8	1	Identifies the type of the processor architecture. 0: IA32/X64 1: IA64 2: ARM All other values reserved.
Processor ISA	9	1	Identifies the type of the instruction set executing when the error occurred: 0: IA32 1: IA64 2: X64 3: ARM A32/T32 4: ARM A64 All other values are reserved.
Processor Error Type	10	1	Indicates the type of error that occurred: 0x00: Unknown 0x01: Cache Error 0x02: TLB Error 0x04: Bus Error 0x08: Micro-Architectural Error All other values reserved.
Operation	11	1	Indicates the type of operation: 0: Unknown or generic 1: Data Read 2: Data Write 3: Instruction Execution All other values reserved.

Name	Byte Offset	Byte Length	Description
Flags	12	1	Indicates additional information about the error: Bit 0: Restartable – If 1, program execution can be restarted reliably after the error. Bit 1: Precise IP – If 1, the instruction IP captured is directly associated with the error. Bit 2: Overflow – If 1, a machine check overflow occurred (a second error occurred while the results of a previous error were still in the error reporting resources). Bit 3: Corrected – If 1, the error was corrected by hardware and/or firmware. All other bits are reserved and must be zero.
Level	13	1	Level of the structure where the error occurred, with 0 being the lowest level of cache.
Reserved	14	2	Must be zero.
CPU Version Info	16	8	This field represents the CPU Version Information and returns Family, Model, and stepping information (e.g. As provided by CPUID instruction with EAX=1 input with output values from EAX on the IA32/X64 processor or as provided by CPUID Register 3 register – Version Information on IA64 processors).  On ARM processors, this field will be provided as: Bits 127:64 - Reserved and must be zero Bits 63:0 - MIDR_EL1 of the processor
CPU Brand String	24	128	This field represents the null-terminated ASCII Processor Brand String (e.g. As provided by the CPUID instruction with EAX=0x80000002 and ECX=0x80000003 for IA32/X64 processors or the return from PAL_BRAND_INFO for IA64 processors).  This field is optional for ARM processors.
Processor ID	152	8	This value uniquely identifies the logical processor (e.g. As programmed into the local APIC ID register on IA32/X64 processors or programmed into the LID register on IA64 processors).  On ARM processors, this field will be provided as programmed in the architected MPIDR_EL1.
Target Address	160	8	Identifies the target address associated with the error.
Requestor Identifier	168	8	Identifies the requestor associated with the error.
Responder Identifier	176	8	Identifies the responder associated with the error.
Instruction IP	184	8	Identifies the instruction pointer when the error occurred.

## N.2.4.2 IA32/X64 Processor Error Section

Type: {0xDC3EA0B0, 0xA144, 0x4797, {0xB9, 0x5B, 0x53, 0xFA, 0x24, 0x2B, 0x6E, 0x1D}}

Table 252. Processor Error Record

Mnemonic	Byte Offset	Byte Length	Description
Validation Bits	0	8	The validation bit mask indicates each of the following field is valid in this section:  Bit0 – LocalAPIC_ID Valid Bit1 – CPUID Info Valid Bits 2-7 – Number of Processor Error Information Structure (PROC_ERR_INFO_NUM) Bit 8– 13 Number of Processor Context Information Structure (PROC_CONTEXT_INFO_NUM) Bits 14-63 – Reserved
Local APIC_ID	8	8	This is the processor APIC ID programmed into the APIC ID registers.
CPUID Info	16	48	This field represents the CPU ID structure of 48 bytes and returns Model, Family, and stepping information as provided by the CPUID instruction with EAX=1 input and output values from EAX, EBX, ECX, and EDX null extended to 64-bits.
Processor Error Info	64	Nx64	This is a variable-length structure consisting of N different 64 byte structures, each representing a single processor error information structure. The value of N ranges from 0-63 and is as indicated by PROC_ERR_INFO_NUM.
Processor Context	64+Nx64	NxX	This is a variable size field providing the information for the processor context state such as MC Bank MSRs and general registers. The value of N ranges from 0-63 and is as indicated by PROC_CONTEXT_INFO_NUM. Each processor context information structure is padded with zeros if the size is not a multiple of 16 bytes.

### N.2.4.2.1 IA32/X64 Processor Error Information Structure

As described above, the processor error section contains a collection of structures called *Processor Error Information Structures* that contain processor structure specific error

information. This section details the layout of the *Processor Error Information Structure* and the detailed check information which is contained within.

**Table 253. IA32/X64 Processor Error Information Structure**

Mnemonic	Byte Offset	Byte Length	Description
Error Structure Type	0	16	This field holds a pre-assigned GUID indicating the type of Processor Error Information structure. The following Processor Error Information Structure Types have pre-defined GUID. <ul style="list-style-type: none"> <li>• Cache Error Information (Cache Check)</li> <li>• TLB Error Information (TLB Check)</li> <li>• Bus Error Information (Bus Check)</li> <li>• Micro-architecture Specific Error Information (MS Check)</li> </ul>
Validation Bits	16	8	Bit 0 – Check Info Valid Bit 1 – Target Address Identifier Valid Bit 2 – Requestor Identifier Valid Bit 3 – Responder Identifier Valid Bit 4 – Instruction Pointer Valid Bits 5-63 – Reserved
Check Information	24	8	StructureErrorType specific error check structure.
Target Identifier	32	8	Identifies the target associated with the error.
Requestor Identifier	40	8	Identifies the requestor associated with the error.
Responder Identifier	48	8	Identifies the responder associated with the error.
Instruction Pointer	56	8	Identifies the instruction executing when the error occurred.

#### IA32/X64 Cache Check Structure

Type:{0xA55701F5, 0xE3EF, 0x43de, {0xAC, 0x72, 0x24, 0x9B, 0x57, 0x3F, 0xAD, 0x2C}}

**Table 254. IA32/X64 Cache Check Structure**

Field Name	Bits	Description
ValidationBits	15:0	Indicates which fields in the Cache Check structure are valid: Bit 0 – Transaction Type Valid Bit 1 – Operation Valid Bit 2 – Level Valid Bit 3 – Processor Context Corrupt Valid Bit 4 – Uncorrected Valid Bit 5 – Precise IP Valid Bit 6 – Restartable Valid Bit 7 – Overflow Valid Bits 8 – 15 Reserved
TransactionType	17:16	Type of cache error: 0 – Instruction 1 – Data Access 2 – Generic All other values are reserved
Operation	21:18	Type of cache operation that caused the error: 0 – generic error (type of error cannot be determined) 1 – generic read (type of instruction or data request cannot be determined) 2 – generic write (type of instruction or data request cannot be determined) 3 – data read 4 – data write 5 – instruction fetch 6 – prefetch 7 – eviction 8 – snoop All other values are reserved.
Level	24:22	Cache Level
Processor Context Corrupt	25	This field indicates that the processor context might have been corrupted. 0 - Processor context not corrupted 1 - Processor context corrupted
Uncorrected	26	This field indicates whether the error was corrected or uncorrected: 0: Corrected 1: Uncorrected
Precise IP	27	This field indicates that the instruction pointer pushed onto the stack is directly associated with the error
Restartable IP	28	This field indicates that program execution can be restarted reliably at the instruction pointer pushed onto the stack
Overflow	29	This field indicates an error overflow occurred 0 - Overflow not occurred 1 - Overflow occurred
	63:30	Reserved



## IA32/X64 TLB Check Structure

Type:{0xFC06B535, 0x5E1F, 0x4562, {0x9F, 0x25, 0x0A, 0x3B, 0x9A, 0xDB, 0x63, 0xC3}}

**Table 255. IA32/X64 TLB Check Structure**

Field Name	Bits	Description
Validation Bits	15:0	Indicate which fields in the Cache_Check structure are valid Bit 0 – Transaction Type Valid Bit 1 – Operation Valid Bit 2 – Level Valid Bit 3 – Processor Context Corrupt Valid Bit 4 – Uncorrected Valid Bit 5 – Precise IP Valid Bit 6 – Restartable IP Valid Bit 7 – Overflow Valid Bit 8 – 15 Reserved
Transaction Type	17:16	Type of TLB error 0 – Instruction 1 – Data Access 2 – Generic All other values are reserved
Operation	21:18	Type of TLB access operation that caused the machine check: 0 – generic error (type of error cannot be determined) 1 – generic read (type of instruction or data request cannot be determined) 2 – generic write (type of instruction or data request cannot be determined) 3 – data read 4 – data write 5 – instruction fetch 6 – prefetch All other values are reserved.
Level	24:22	TLB Level
Processor Context Corrupt	25	This field indicates that the processor context might have been corrupted. 0 - Processor context not corrupted 1 - Processor context corrupted
Uncorrected	26	This field indicates whether the error was corrected or uncorrected: 0: Corrected 1: Uncorrected
PreciseIP	27	This field indicates that the instruction pointer pushed onto the stack is directly associated with the error.
Restartable IP	28	This field indicates the program execution can be restarted reliably at the instruction pointer pushed onto the stack.

## Unified Extensible Firmware Interface Specification

Field Name	Bits	Description
Overflow	29	This field indicates an error overflow occurred 0 - Overflow not occurred 1 - Overflow occurred
	63:30	Reserved

## IA32/X64 Bus Check Structure

Type:{0x1CF3F8B3, 0xC5B1, 0x49a2, {0xAA, 0x59, 0x5E, 0xEF, 0x92, 0xFF, 0xA6, 0x3C}}

**Table 256. IA32/X64 Bus Check Structure**

Field Name	Bits	Description
Validation Bits	15:0	Indicate which fields in the Cache_Check structure are valid Bit 0 – Transaction Type Valid Bit 1 – Operation Valid Bit 2 – Level Valid Bit 3 – Processor Context Corrupt Valid Bit 4 – Uncorrected Valid Bit 5 – Precise IP Valid Bit 6 – Restartable IP Valid Bit 7 – Overflow Valid Bit 8 – Participation Type Valid Bit 9 – Time Out Valid Bit 10 – Address Space Valid Bit 11 – 15 Reserved
Transaction Type	17:16	Type of Bus error 0 – Instruction 1 – Data Access 2 – Generic All other values are reserved
Operation	21:18	Type of bus access operation that caused the machine check: 0 – generic error (type of error cannot be determined) 1 – generic read (type of instruction or data request cannot be determined) 2 – generic write (type of instruction or data request cannot be determined) 3 – data read 4 – data write 5 – instruction fetch 6 – prefetch All other values are reserved.
Level	24:22	Indicate which level of the bus hierarchy the error occurred in.
Processor Context Corrupt	25	This field indicates that the processor context might have been corrupted. 0 - Processor context not corrupted 1 - Processor context corrupted
Uncorrected	26	This field indicates whether the error was corrected or uncorrected: 0: Corrected 1: Uncorrected
PreciseIP	27	This field indicates that the instruction pointer pushed onto the stack is directly associated with the error.

## Unified Extensible Firmware Interface Specification

Field Name	Bits	Description
Restartable IP	28	This field indicates the program execution can be restarted reliably at the instruction pointer pushed onto the stack.
Overflow	29	This field indicates an error overflow occurred 0 - Overflow not occurred 1 - Overflow occurred
Participation Type	31:30	Type of Participation 0 - Local Processor originated request 1 - Local processor Responded to request 2 - Local processor Observed 3 - Generic
Time Out	32	This field indicates that the request timed out.
Address Space	34:33	0 - Memory Access 1 - Reserved 2 - I/O 3 - Other Transaction
	63:35	Reserved

### IA32/X64 MS Check Field Description

Type: {0x48AB7F57, 0xDC34, 0x4f6c, {0xA7, 0xD3, 0xB0, 0xB5, 0xB0, 0xA7, 0x43, 0x14}}

**Table 257. IA32/X64 MS Check Field Description**

Field Name	Bits	Description
Validation Bits	15:0	Indicate which fields in the Cache_Check structure are valid Bit 0 – Error Type Valid Bit 1 – Processor Context Corrupt Valid Bit 2 – Uncorrected Valid Bit 3 – Precise IP Valid Bit 4 – Restartable IP Valid Bit 5 – Overflow Valid Bit 6 – 15 Reserved
Error Type	18:16	Identifies the operation that caused the error: 0 – No Error 1 – Unclassified 2 – Microcode ROM Parity Error 3 – External Error 4 – FRC Error 5 – Internal Unclassified All other value are processor specific.
Processor Context Corrupt	19	This field indicates that the processor context might have been corrupted. 0 - Processor context not corrupted 1 - Processor context corrupted
Uncorrected	20	This field indicates whether the error was corrected or uncorrected: 0: Corrected 1: Uncorrected
Precise IP	21	This field indicates that the instruction pointer pushed onto the stack is directly associated with the error.
Restartable IP	22	This field indicates the program execution can be restarted reliably at the instruction pointer pushed onto the stack.
Overflow	23	This field indicates an error overflow occurred 0 - Overflow not occurred 1 - Overflow occurred
	63:24	Reserved

**N.2.4.2.2 IA32/X64 Processor Context Information Structure**

As described above, the processor error section contains a collection of structures called *Processor Context Information* that contain processor context state specific to the IA32/X64 processor architecture. This section details the layout of the *Processor Context Information Structure* and the detailed processor context type information.

**Table 258. IA32/X64 Processor Context Information**

Mnemonic	Byte Offset	Byte Length	Description
Register Context Type	0	2 bytes	Value indicating the type of processor context state being reported: 0 – Unclassified Data 1 – MSR Registers (Machine Check and other MSRs) 2 – 32-bit Mode Execution Context 3 – 64-bit Mode Execution Context 4 – FXSAVE Context 5 – 32-bit Mode Debug Registers (DR0-DR7) 6 – 64-bit Mode Debug Registers (DR0-DR7) 7 – Memory Mapped Registers Others - Reserved
Register Array Size	2	2 bytes	Represents the total size of the array for the Data Type being reported in bytes.
MSR Address	4	4 bytes	This field contains the starting MSR address for the type 1 register context.
MM Register Address	8	8 bytes	This field contains the starting memory address for the type 7 register context.
Register Array	16	N bytes	This field will provide the contents of the actual registers or raw data. The number of Registers or size of the raw data reported is determined by (Array Size / 8) or otherwise specified by the context structure type definition.

[Table 259](#) shows the register context type 2, 32-bit mode execution context.

**Table 259. IA32 Register State**

Offset	Length	Field
0	4 bytes	EAX
4	4 bytes	EBX
8	4 bytes	ECX
12	4 bytes	EDX
16	4 bytes	ESI
20	4 bytes	EDI
24	4 bytes	EBP
28	4 bytes	ESP
32	2 bytes	CS
34	2 bytes	DS
36	2 bytes	SS
38	2 bytes	ES
40	2 bytes	FS
42	2 bytes	GS
44	4 bytes	EFLAGS
48	4 bytes	EIP
52	4 bytes	CR0
56	4 bytes	CR1
60	4 bytes	CR2
64	4 bytes	CR3
68	4 bytes	CR4
72	8 bytes	GDTR
80	8 bytes	IDTR
88	2 bytes	LDTR
90	2 bytes	TR

[Table 260](#) shows the register context type 3, 64-bit mode execution context.

**Table 260. X64 Register State**

Offset	Length	Field
0	8 bytes	RAX
8	8 bytes	RBX
16	8 bytes	RCX
24	8 bytes	RDX
32	8 bytes	RSI
40	8 bytes	RDI
48	8 bytes	RBP
56	8 bytes	RSP
64	8 bytes	R8
72	8 bytes	R9
80	8 bytes	R10
88	8 bytes	R11
96	8 bytes	R12
104	8 bytes	R13
112	8 bytes	R14
120	8 bytes	R15
128	2 bytes	CS
130	2 bytes	DS
132	2 bytes	SS
134	2 bytes	ES
136	2 bytes	FS
138	2 bytes	GS
140	4 bytes	Reserved
144	8 bytes	RFLAGS
152	8 bytes	EIP
160	8 bytes	CR0
168	8 bytes	CR1
176	8 bytes	CR2
184	8 bytes	CR3
192	8 bytes	CR4
200	8 bytes	CR8
208	16 bytes	GDTR
224	16 bytes	IDTR
240	2 bytes	LDTR
242	2 bytes	TR

### N.2.4.3 IA64 Processor Error Section

Refer to the Intel Itanium Processor Family System Abstraction Layer specification for



finding the IA64 specific error section body definition.

#### **N.2.4.4 ARM Processor Error Section**

Type: {0xE19E3D16, 0xBC11, 0x11E4, {0x9C, 0xAA, 0xC2, 0x05, 0x1D, 0x5D, 0x46, 0xB0}}

The ARM Processor Error Section may contain multiple instances of error information structures associated to a single error event. An error may propagate to other hardware components (e.g. poisoned data) or cause subsequent errors, all of which may be captured in a single ARM processor error section. The processor context information describes the observed state of the processor at the point of error detection.

It is optional for vendors to capture processor context information. The specifics of capturing processor context is vendor specific. Vendors must take care when handling errors that have originated whilst a processor was executing in a secure exception level. In those cases providing processor context information to non-secure agents could be unsafe and lead to security attacks.

Table 261. ARM Processor Error Section

Mnemonic	Byte Offset	Byte Length	Description
Validation Bit	0	4	The validation bit mask indicates whether or not each of the following fields is valid in this section. Bit 0 – MPIDR Valid Bit 1 – Error affinity level Valid Bit 2 - Running State Bit 3 – Vendor Specific Info Valid All other bits are reserved and must be zero.
ERR_INFO_- NUM	4	2	ERR_INFO_NUM is the number of Processor Error Information Structures (must be 1 or greater)
CONTEXT_- INFO_NUM	6	2	CONTEXT_INFO_NUM is the number of Context Information Structures
Section Length	8	4	This describes the total size of the ARM processor error section
Error affinity level	12	1	For errors that can be attributed to a specific affinity level, this field defines the affinity level at which the error was produced, detected, and/or consumed. This is a value between 0 and 3. All other values (4-255) are reserved  For example, a vendor may choose to define affinity levels as follows: Level 0: errors that can be precisely attributed to a specific CPU (e.g. due to a synchronous external abort) Level 1: Cache parity and/or ECC errors detected at cache of affinity level 1 (e.g. only attributed to higher level cache due to prefetching and/or error propagation)  <b>NOTE:</b> Detailed meanings and groupings of affinity level are chip and/or platform specific. The affinity level described here must be consistent with the platform definitions used MPIDR. For cache/TLB errors, the cache/TLB level is provided by the cache/TLB error structure, which may differ from affinity level.
Reserved	13	3	Must be zero
MPIDR_EL1	16	8	This field is valid for “attributable errors” that can be attributed to a specific CPU, cache, or cluster. This is the processor’s unique ID in the system.
MIDR_EL1	24	8	This field provides identification information of the chip, including an implementer code for the device and a device ID number
Running State	32	4	Bit 0 – Processor running. If this bit is set, “PSCI State” field must be zero. All other bits are reserved and must be zero.

Mnemonic	Byte Offset	Byte Length	Description
PSCI State	36	4	This field provides PSCI state of the processor, as defined in ARM PSCI document. This field is valid when bit 32 of "Running State" field is zero.
Processor Error Information Structure	40	Nx32	This is a variable-length structure consisting of N different 32 byte structures per Table 261, each representing a single processor error information structure. The value of N ranges from 1-255 and is as indicated by ERR_INFO_NUM field in this table.
Processor Context	40 + Nx32	MxP	This is a variable size field consisting of M different P byte structures providing the information for the processor context state such as general purpose registers (GPRs) and special purpose registers (SPRs) as defined in Table 266 or 267 (depending on the context type). The value of M ranges from 0-65536 and is indicated by the CONTEXT_INFO_NUM field in this table. Each processor context information structure is padded with zeros if the size is not a multiple of 16 bytes. The value of P is a variable length defined by the processor context structure per Table 266 and 267.
Vendor Specific Error Info	40 + Nx32 + MxP	vendor specific	This is an optional variable field provided by vendors that prefer to provide additional details.

#### N.2.4.4.1 ARM Processor Error Information

As described above, the processor error section contains a collection of *Processor Error Information* structures that contain processor specific error information. This section details the layout of the Processor Error Information structure and the detailed information which is contained within.

Table 262. ARM Processor Error Information Structure

Mnemonic	Byte Offset	Byte Length	Description
Version	0	1	0  (revision of this table)
Length	1	1	32  (length in bytes)
Validation Bit	2	2	The validation bit mask indicates whether or not each of the following fields is valid in this section. Bit 0 – Multiple Error (Error Count) Valid Bit 1 – Flags Valid Bit 2 – Error Information Valid Bit 3 – Virtual Fault Address Bit 4 – Physical Fault Address All other bits are reserved and must be zero.
Type	4	1	Cache Error TLB Error Bus Error Micro-architectural Error All other values are reserved
Multiple Error (Error Count)	5	2	This field indicates whether multiple errors have occurred. In the case of multiple error with a valid count, this field will specify the error count. The value of this field is defined as follows: 0: Single Error 1: Multiple Errors 2-65535: Error Count (if known)
Flags	7	1	This field indicates flags that describe the error attributes. The value of this field is defined as follows: Bit 0 – First error captured Bit 1 – Last error captured Bit 2 – Propagated Bit 3 – Overflow All other bits are reserved and must be zero  <b>Note:</b> Overflow bit indicates that firmware/hardware error buffers had experience an overflow, and it is possible that some error information has been lost.
Error Information	8	8	The error information structure is specific to each error type (described in tables below)
Virtual Fault Address	16	8	If known, this field indicates a virtual fault address associated with the error (e.g. when an error occurs in virtually indexed cache)
Physical Fault Address	24	8	If known, this field indicates a physical fault address associated with the error

[Table 263](#) to [Table 266](#), below, describe error information.

Table 263. ARM Cache Error Structure

Name	Bits	Description
Validation Bit	15:0	Indicates which fields in the Cache Check structure are valid: Bit 0 – Transaction Type Valid Bit 1 – Operation Valid Bit 2 – Level Valid Bit 3 – Processor Context Corrupt Valid Bit 4 – Corrected Valid Bit 5 – Precise PC Valid Bit 6 – Restartable PC Valid All other bits are reserved and must be zero.
Transaction Type	17:16	Type of cache error: 0 – Instruction 1 – Data Access 2 – Generic All other values are reserved
Operation	21:18	Type of cache operation that caused the error: 0 – generic error (type of error cannot be determined) 1 – generic read (type of instruction or data request cannot be determined) 2 – generic write (type of instruction or data request cannot be determined) 3 – data read 4 – data write 5 – instruction fetch 6 – prefetch 7 – eviction 8 – snooping (the processor described in this record initiated a cache snoop that resulted in an error) 9 – snooped (The processor described in this record raised a cache error caused by another processor or device snooping into its cache) 10 – management All other values are reserved.
Level	24:22	Cache level
Processor Context Corrupt	25	This field indicates that the processor context might have been corrupted. 0 - Processor context not corrupted 1 - Processor context corrupted
Corrected	26	This field indicates whether the error was corrected or uncorrected: 1: Corrected 0: Uncorrected
Precise PC	27	This field indicates that the program counter that is directly associated with the error
Restartable PC	28	This field indicates that program execution can be restarted reliably at the PC associated with the error.
Reserved	63:29	Must be zero

**Table 264. ARM TLB Error Structure**

<b>Name</b>	<b>Bits</b>	<b>Description</b>
Validation Bit	15:0	Indicates which fields in the TLB error structure are valid: Bit 0 – Transaction Type Valid Bit 1 – Operation Valid Bit 2 – Level Valid Bit 3 – Processor Context Corrupt Valid Bit 4 – Corrected Valid Bit 5 – Precise PC Valid Bit 6 – Restartable PC Valid All other bits are reserved and must be zero.
Transaction Type	17:16	Type of TLB error: 0 – Instruction 1 – Data Access 2 – Generic All other values are reserved
Operation	21:18	Type of TLB operation that caused the error: 0 – generic error (type of error cannot be determined) 1 – generic read (type of instruction or data request cannot be determined) 2 – generic write (type of instruction or data request cannot be determined) 3 – data read 4 – data write 5 – instruction fetch 6 – prefetch 7 – local management operation (the processor described in this record initiated a TLB management operation that resulted in an error) 8 – external management operation (the processor described in this record raised a TLB error caused by another processor or device broadcasting TLB operations) All other values are reserved.
Level	24:22	TLB level
Processor Context Corrupt	25	This field indicates that the processor context might have been corrupted. 0 - Processor context not corrupted 1 - Processor context corrupted
Corrected	26	This field indicates whether the error was corrected or uncorrected: 1: Corrected 0: Uncorrected
Precise PC	27	This field indicates that the program counter that is directly associated with the error
Restartable PC	28	This field indicates that program execution can be restarted reliably at the PC associated with the error.
Reserved	63:29	Must be zero.

Table 265. ARM Bus Error Structure

Name	Bits	Description
Validation Bit	15:0	Indicates which fields in the Bus error structure are valid: Bit 0 – Transaction Type Valid Bit 1 – Operation Valid Bit 2 – Level Valid Bit 3 – Processor Context Corrupt Valid Bit 4 – Corrected Valid Bit 5 – Precise PC Valid Bit 6 – Restartable PC Valid Bit 7 – Participation Type Valid Bit 8 – Time Out Valid Bit 9 – Address Space Valid Bit 10 – Memory Attributes Valid Bit 11 – Access Mode valid All other bits are reserved and must be zero.
Transaction Type	17:16	Type of bus error: 0 – Instruction 1 – Data Access 2 – Generic All other values are reserved
Operation	21:18	Type of bus operation that caused the error: 0 – generic error (type of error cannot be determined) 1 – generic read (type of instruction or data request cannot be determined) 2 – generic write (type of instruction or data request cannot be determined) 3 – data read 4 – data write 5 – instruction fetch 6 – prefetch All other values are reserved.
Level	24:22	Affinity level at which the bus error occurred
Processor Context Corrupt	25	This field indicates that the processor context might have been corrupted. 0 - Processor context not corrupted 1 - Processor context corrupted
Corrected	26	This field indicates whether the error was corrected or uncorrected: 1: Corrected 0: Uncorrected
Precise PC	27	This field indicates that the program counter that is directly associated with the error
Restartable PC	28	This field indicates that program execution can be restarted reliably at the PC associated with the error.



Name	Bits	Description
Participation Type	30:29	Type of Participation 0 – Local Processor originated request 1 – Local processor Responded to request 2 – Local processor Observed 3 – Generic  The usage of this field depends on the vendor, but the examples below provide some guidance on how this field is to be used: If bus error occurs on an LDR instruction, the local processor originated the request. If the bus error occurs due to a snoop operation, local processor responded to the request If a bus error occurs due to cache prefetching and an SEI was sent to a particular CPU to notify this bus error has occurred, then the local processor only observed the error.
Time Out	31	This field indicates that the request timed out.
Address Space	33:32	0 – External Memory Access (e.g. DDR) 1 – Internal Memory Access (e.g. internal chip ROM) 3 – Device Memory Access
Memory Access Attributes	42:34	Memory attribute as described in the ARM ARM specification.
Access Mode	43	Indicates whether the access was a secure or normal bus request 0 – secure 1 - normal  Note: A platform may choose to hide some or all of the error information for errors that are consumed/detected in the secure context.
Reserved	63:44	Must be zero.

## ARM Vendor Specific Micro-Architecture Error Structure

This is a vendor specific structure. Please refer to your hardware vendor documentation for the format of this structure.

### N.2.4.4.2 ARM Processor Context Information

As described above, the processor error section contains a collection of structures called Processor Context Information. These provide processor context state specific to the ARM processor architecture. This section details the layout of the Processor Error Context Information Header Structure ([Table 266](#)) and the detailed processor context type information structures ([Table 266](#) - [Table 275](#)).

Care must be taken when reporting context information structures. The amount of context reported depends on the agent that is going to observe the data. The following are recommended guidelines:

1. If the error happens whilst the processor is in the secure world, EL3, Secure EL1 or secure EL0, context information can contain sensitive data, and should not be exposed to unauthorized parties.

2. If the error information is being provided to a software agent running at EL2, then the context information should only include any registers visible in EL2, e.g. GPR, EL1 and EL2 registers.
3. If the error information is being provided to a software agent running at EL1, then the context information should only include any registers visible in EL1, e.g. GPR, EL1 and registers.

For context information on processor running in AArch64 mode, even though some registers are defined as 4 bytes in length, following tables provide 8 bytes space to account for possible future expansion.

**Table 266. ARM Processor Error Context Information Header Structure**

Name	Byte Offset	Byte Length	Description
Version	0	2	0  (revision of this table)
Register Context Type	2	2	Value indicating the type of processor context state being reported: 0 – AArch32 GPRs (General Purpose Registers). 1 -- AArch32 EL1 context registers 2 -- AArch32 EL2 context registers 3 -- AArch32 secure context registers 4 – AArch64 GPRs 5 -- AArch64 EL1 context registers 6 – AArch64 EL2 context registers 7 -- AArch64 EL3 context registers 8 – Misc. System Register Structure All other values are reserved.
Register Array Size	4	4	Represents the total size of the array for the Data Type being reported in bytes.
Register Array	8	N	This field will provide the contents of the actual registers or raw data. The contents of the array depends on the Type, with the structures described in Tables 266 – 274.

**Table 267. ARMv8 AArch32 GPRs (Type 0)**

Byte Offset	Byte Length	Field
0	4	R0
4	4	R1
8	4	R2
12	4	R3
16	4	R4
20	4	R5
24	4	R6
28	4	R7
32	4	R8
36	4	R9
40	4	R10
44	4	R11
48	4	R12
52	4	R13 (SP)
56	4	R14 (LR)
60	4	R15 (PC)

**Table 268. ARM AArch32 EL1 Context System Registers (Type 1)**

Byte Offset	Byte Length	Field
0	4	DFAR
4	4	DFSR
8	4	IFAR
12	4	ISR
16	4	MAIRO
20	4	MAIR1
24	4	MIDR
28	4	MPIDR
32	4	NMRR
36	4	PRRR
40	4	SCTLR (NS)
44	4	SPSR
48	4	SPSR_abt
52	4	SPSR_fiq
56	4	SPSR_irq
60	4	SPSR_svc
64	4	SPSR_und
68	4	TPIDRPRW
72	4	TPIDRURO
76	4	TPIDRURW
80	4	TTBCR
84	4	TTBR0
88	4	TTBR1
92	4	DACR

**Table 269. ARM AArch32 EL2 Context System Registers (Type 2)**

Byte Offset	Byte Length	Field
0	4	ELR_hyp
4	4	HAMAIRO
8	4	HAMAIR1
12	4	HCR
16	4	HCR2
20	4	HDFAR
24	4	HIFAR
28	4	HPFAR
32	4	HSR

Byte Offset	Byte Length	Field
36	4	HTCR
40	4	HTPIDR
44	4	HTTBR
48	4	SPSR_hyp
52	4	VTCR
56	4	VTTBR
60	4	DACR32_EL2

**Table 270. ARM AArch32 secure Context System Registers (Type 3)**

Byte Offset	Byte Length	Field
0	4	SCTLR (S)
4	4	SPSR_mon

**Table 271. ARMv8 AArch64 GPRs (Type 4)**

Byte Offset	Byte Length	Field
0	8	X0
8	8	X1
16	8	X2
24	8	X3
32	8	X4
40	8	X5
48	8	X6
56	8	X7
64	8	X8
72	8	X9
80	8	X10
88	8	X11
96	8	X12
104	8	X13
112	8	X14
120	8	X15
128	8	X16
136	8	X17
144	8	X18
152	8	X19
160	8	X20
168	8	X21
176	8	X22
184	8	X23
192	8	X24
200	8	X25
208	8	X26
216	8	X27
224	8	X28
232	8	X29

Byte Offset	Byte Length	Field
240	8	X30
248	8	SP

**Table 272. ARM AArch64 EL1 Context System Registers (Type 5)**

Byte Offset	Byte Length	Field
0	8	ELR_EL1
8	8	ESR_EL1
16	8	FAR_EL1
24	8	ISR_EL1
32	8	MAIR_EL1
40	8	MIDR_EL1
48	8	MPIDR_EL1
56	8	SCTLR_EL1
64	8	SP_ELO
72	8	SP_EL1
80	8	SPSR_EL1
88	8	TCR_EL1
96	8	TPIDR_ELO
104	8	TPIDR_EL1
112	8	TPIDRRO_ELO
120	8	TTBRO_EL1
128	8	TTBR1_EL1

**Table 273. ARM AArch64 EL2 Context System Registers (Type 6)**

Byte Offset	Byte Length	Field
0	8	ELR_EL2
8	8	ESR_EL2
16	8	FAR_EL2
24	8	HACR_EL2
32	8	HCR_EL2
40	8	HPFAR_EL2
48	8	MAIR_EL2
56	8	SCTLR_EL2
64	8	SP_EL2
72	8	SPSR_EL2
80	8	TCR_EL2
88	8	TPIDR_EL2
96	8	TTBRO_EL2
104	8	VTCR_EL2
112	8	VTTBR_EL2

**Table 274. ARM AArch64 EL3 Context System Registers (Type 7)**

Byte Offset	Byte Length	Field
0	8	ELR_EL3
8	8	ESR_EL3
16	8	FAR_EL3
24	8	MAIR_EL3
32	8	SCTLR_EL3
40	8	SP_EL3
48	8	SPSR_EL3
56	8	TCR_EL3
64	8	TPIDR_EL3
72	8	TTBRO_EL3

The following structure (Table 275) describes additional AArch64/AArch32 miscellaneous system registers captured from the perspective of the processor that took the hardware error exception. Each register array entry will be per the following table. The number of register entries present in the register array is based on the register array size (i.e. N/10).



**Table 275. ARM Misc. Context System Register (Type 8) – Single Register Entry**

<b>Name</b>	<b>Byte Offset</b>	<b>Byte Length</b>	<b>Description</b>
MRS encoding	0	2	This field defines MRS instruction encoding. Bit 0:2 -- Op2 Bit 3:6 – CRm Bit 7:10 – CRn Bit 11:13 – Op1 Bit 14 – O0
Value	2	8	Value read from system register

## **N.2.5 Memory Error Section**

Type: {0xA5BC1114, 0x6F64, 0x4EDE, {0xB8, 0x63, 0x3E, 0x83, 0xED, 0x7C, 0x83, 0xB1}}

Table 276. Memory Error Record

Mnemonic	Byte Offset	Byte Length	Description
Validation Bits	0	8	Indicates which fields in the memory error record are valid. Bit 0 – Error Status Valid Bit 1 – Physical Address Valid Bit 2 – Physical Address Mask Valid Bit 3 – Node Valid Bit 4 – Card Valid Bit 5 – Module Valid Bit 6 – Bank Valid (When Bank is addressed via group/address, refer to Bit 19 and 20) Bit 7 – Device Valid Bit 8 – Row Valid 1 - the Row field at Offset 42 contains row number (15:0) and row number (17:16) are 00b 0 - the Row field at Offset 42 is not used, or is defined by Bit 18 (Extended Row Bit 16 and 17 Valid). Bit 9 – Column Valid Bit 10 – Bit Position Valid Bit 11 – Platform Requestor Id Valid Bit 12 – Platform Responder Id Valid Bit 13 – Memory Platform Target Valid Bit 14 – Memory Error Type Valid Bit 15 - Rank Number Valid Bit 16 - Card Handle Valid Bit 17 - Module Handle Valid Bit 18 - Extended Row Bit 16 and 17 Valid (refer to Byte Offset 42 and 73 below) 1 - the Row field at Offset 42 contains row number (15:0) and the Extended field at Offset 73 contains row number (17:16) 0 - the Extended field at Offset 73 and the Row field at Offset 42 are not used, or the Rowfield at Offset 42 is defined by Bit 8 (Row Valid). When this bit is set to 1, Bit 8 (Row Valid) must be set to 0. Bit 19 - Bank Group Valid Bit 20 - Bank Address Valid Bit 21 - Chip Identification Valid Bit 22-63 Reserved
Error Status	8	8	Memory error status information. See section O for error status details.
Physical Address	16	8	The physical address at which the memory error occurred.
Physical Address Mask	24	8	Defines the valid address bits in the <i>Physical Address</i> field. The mask specifies the granularity of the physical address which is dependent on the hw/ implementation factors such as interleaving.

Mnemonic	Byte Offset	Byte Length	Description
Node	32	2	In a multi-node system, this value identifies the node containing the memory in error.
Card	34	2	The card number of the memory error location.
Module	36	2	The module or rank number of the memory error location. (NODE, CARD, and MODULE should provide the information necessary to identify the failing FRU).
Bank	38	2	The bank number of the memory associated with the error. When Bank is addressed via group/address Bit 7:0 - Bank Address Bit 15:8 - Bank Group
Device	40	2	The device number of the memory associated with the error.
Row	42	2	First 16 bits (15:0) of the row number of the memory error location. This field is valid if either "Row Valid" or "Extended Row Bit 16 and 17" Validation Bits at Offset 0 is set to 1..
Column	44	2	The column number of the memory error location.
Bit Position	46	2	The bit position at which the memory error occurred.
Requestor ID	48	8	Hardware address of the device that initiated the transaction that took the error.
Responder ID	56	8	Hardware address of the device that responded to the transaction.
Target ID	64	8	Hardware address of the intended target of the transaction.
Memory Error Type	72	1	Identifies the type of error that occurred: 0 – Unknown 1 – No error 2 – Single-bit ECC 3 – Multi-bit ECC 4 – Single-symbol ChipKill ECC 5 – Multi-symbol ChipKill ECC 6 – Master abort 7 – Target abort 8 – Parity Error 9 – Watchdog timeout 10 – Invalid address 11 – Mirror Broken 12 – Memory Sparing 13 - Scrub corrected error 14 - Scrub uncorrected error 15 - Physical Memory Map-out event All other values reserved.

Mnemonic	Byte Offset	Byte Length	Description
Extended	73	1	Bit 0 - Bit 16 of the row number of the memory error location. <ul style="list-style-type: none"> <li>This field is valid if "Extended Row Bit 16 and 17" Validation Bits at Offset 0 is set to 1.</li> </ul> Bit 1 - Bit 17 of the row number of the memory error location. <ul style="list-style-type: none"> <li>This field is valid if "Extended Row Bit 16 and 17" Validation Bits at Offset 0 is set to 1.</li> </ul> Bit 4:2 - Reserved Bit 7:5 - Chip Identification.
Rank Number	74	2	The Rank number of the memory error location.
Card Handle	76	2	If bit 16 in Validation Bits is 1, this field contains the SMBIOS handle for the Type 16 Memory Array Structure that represents the memory card.
Module Handle	78	2	If bit 17 in Validation Bits is 1, this field contains the SMBIOS handle for the Type 17 Memory Device Structure that represents the Memory Module.

## N.2.6 Memory Error Section 2

Type: { 0x61EC04FC, 0x48E6, 0xD813, { 0x25, 0xC9, 0x8D, 0xAA, 0x44, 0x75, 0x0B, 0x12 } };

**Table 277. Memory Error Record 2**

Mnemonic	Byte Offset	Byte Length	Description
Validation Bits	0	8	Indicates which fields in the memory error record are valid. Bit 0 – Error Status Valid Bit 1 – Physical Address Valid Bit 2 – Physical Address Mask Valid Bit 3 – Node Valid Bit 4 – Card Valid Bit 5 – Module Valid Bit 6 – Bank Valid (When Bank is addressed via group/address, refer to Bit 20 and 21) Bit 7 – Device Valid Bit 8 – Row Valid Bit 9 – Column Valid Bit 10 - Rank Valid Bit 11 – Bit Position Valid Bit 12 – Chip Identification Valid Bit 13 – Memory Error Type Valid Bit 14 - Status Valid Bit 15 – Requestor ID Valid Bit 16 – Responder ID Valid Bit 17 – Target ID Valid Bit 18 - Card Handle Valid Bit 19 - Module Handle Valid Bit 20 – Bank Group Valid Bit 21 – Bank Address Valid Bit 22-63 Reserved
Error Status	8	8	Memory error status information. See section O for error status details.
Physical Address	16	8	The physical address at which the memory error occurred.
Physical Address Mask	24	8	Defines the valid address bits in the <i>Physical Address</i> field. The mask specifies the granularity of the physical address which is dependent on the hardware implementation factors such as interleaving.
Node	32	2	In a multi-node system, this value identifies the node containing the memory in error.
Card	34	2	The card number of the memory error location.
Module	36	2	The module number of the memory error location. (NODE, CARD, and MODULE should provide the information necessary to identify the failing FRU).
Bank	38	2	The bank number of the memory associated with the error. When Bank is addressed via group/address (e.g., DDR4) Bit 7:0 – Bank Address Bit 15:8 – Bank Group
Device	40	4	The device number of the memory associated with the error.
Row	44	4	The row number of the memory error location.
Column	48	4	The column number of the memory error location.

## Unified Extensible Firmware Interface Specification

Mnemonic	Byte Offset	Byte Length	Description
Rank	52	4	The rank number of the memory error location.
Bit Position	56	4	The bit position at which the memory error occurred.
Chip Identification	60	1	The Chip Identification. This is an encoded field used to address the die in 3DS packages.
Memory Error Type	61	1	Identifies the type of error that occurred: 0 – Unknown 1 – No error 2 – Single-bit ECC 3 – Multi-bit ECC 4 – Single-symbol ChipKill ECC 5 – Multi-symbol ChipKill ECC 6 – Master abort 7 – Target abort 8 – Parity Error 9 – Watchdog timeout 10 – Invalid address 11 – Mirror Broken 12 – Memory Sparing 13 - Scrub corrected error 14 - Scrub uncorrected error 15 - Physical Memory Map-out event All other values reserved. 16 – 255 Reserved
Status	62	1	Bit 0: If set to 0, the memory error is corrected; if set to 1, the memory error is uncorrected Bit 1-7: Reserved values are 0
Reserved	63	1	Reserved values are 0
Requestor ID	64	8	Hardware address of the device that initiated the transaction that took the error.
Responder ID	72	8	Hardware address of the device that responded to the transaction.
Target ID	80	8	Hardware address of the intended target of the transaction.
Card Handle	88	4	This field contains the SMBIOS handle for the Type 16 Memory Array Structure that represents the memory card.
Module Handle	92	4	This field contains the SMBIOS handle for the Type 17 Memory Device Structure that represents the Memory Module.

### N.2.7 PCI Express Error Section

Type: {0xD995E954, 0xBBC1, 0x430F, {0xAD, 0x91, 0xB4, 0x4D, 0xCB, 0x3C, 0x6F, 0x35}}

**Table 278. PCI Express Error Record**

Mnemonic	Byte Offset	Byte Length	Description
Validation Bits	0	8	Indicates which of the following fields is valid: Bit 0 – Port Type Valid Bit 1 – Version Valid Bit 2 – Command Status Valid Bit 3 – Device ID Valid Bit 4 – Device Serial Number Valid Bit 5 – Bridge Control Status Valid Bit 6 – Capability Structure Status Valid Bit 7 – AER Info Valid Bit 8-63 – Reserved
Port Type	8	4	PCIe Device/Port Type as defined in the PCI Express capabilities register: 0: PCI Express End Point 1: Legacy PCI End Point Device 4: Root Port 5: Upstream Switch Port 6: Downstream Switch Port 7: PCI Express to PCI/PCI-X Bridge 8: PCI/PCI-X to PCI Express Bridge 9: Root Complex Integrated Endpoint Device 10: Root Complex Event Collector
Version	12	4	PCIe Spec. version supported by the platform: Byte 0-1: PCIe Spec. Version Number • Byte0: Minor Version in BCD • Byte1: Major Version in BCD Byte2-3: Reserved
Command Status	16	4	Byte0-1: PCI Command Register Byte2-3: PCI Status Register
Reserved	20	4	Must be zero
Device ID	24	16	PCIe Root Port PCI/bridge PCI compatible device number and bus number information to uniquely identify the root port or bridge. Default values for both the bus numbers is zero. Byte 0-1: Vendor ID Byte 2-3: Device ID Byte 4-6: Class Code Byte 7: Function Number Byte 8: Device Number Byte 9-10: Segment Number Byte 11: Root Port/Bridge Primary Bus Number or device bus number Byte 12: Root Port/Bridge Secondary Bus Number Byte 13-14: Bit0:2: Reserved Bit3:15 Slot Number Byte 15 Reserved

Mnemonic	Byte Offset	Byte Length	Description
Device Serial Number	40	8	Byte 0-3: PCIe Device Serial Number Lower DW Byte 4-7: PCIe Device Serial Number Upper DW
Bridge Control Status	48	4	This field is valid for bridges only. Byte 0-1: Bridge Secondary Status Register Byte 2-3: Bridge Control Register
Capability Structure	52	60	PCIe Capability Structure. <ul style="list-style-type: none"> <li>The 60-byte structure is used to report device capabilities. This structure is used to report the 36-byte PCIe 1.1 Capability Structure (See Figure 7-9 of the PCI Express Base Specification, Rev 1.1) with the last 24 bytes padded.</li> <li>This structure is also used to report the 60-byte PCIe 2.0 Capability Structure (See Figure 7-9 of the PCI Express 2.0 Base Specification.)</li> <li>The fields in the structure vary with different device types.</li> <li>The "Next CAP pointer" field should be considered invalid and any reserved fields of the structure are reserved for future use.</li> </ul> <p>Note that PCIe devices without AER (PCIe_AER_INFO_STRUCT_VALID_BIT=0) may report status using this structure.</p>
AER Info	112	96	PCIe Advanced Error Reporting Extended Capability Structure.

## N.2.8 PCI/PCI-X Bus Error Section

Type: {0xC5753963, 0x3B84, 0x4095, {0xBF, 0x78, 0xED, 0xDA, 0xD3, 0xF9, 0xC9, 0xDD}}



**Table 279. PCI/PCI-X Bus Error Section**

Mnemonic	Byte Offset	Byte Length	Description
Validation Bits	0	8	Indicates which of the following fields is valid: Bit 0 – Error Status Valid Bit 1 – Error Type Valid Bit 2 – Bus Id Valid Bit 3 – Bus Address Valid Bit 4 – Bus Data Valid Bit 5 – Command Valid Bit 6 – Requestor Id Valid Bit 7 – Completer Id Valid Bit 8 – Target Id Valid Bit 9-63 Reserved
Error Status	8	8	PCI Bus Error Status. See section O for details.
Error Type	16	2	PCI Bus error Type Byte 0: 0 – Unknown or OEM system specific error 1 – Data Parity Error 2 – System Error 3 – Master Abort 4 – Bus Timeout or No Device Present (No DEVSEL#) 5 – Master Data Parity Error 6 – Address Parity Error 7 – Command Parity Error Others – Reserved Byte 1: Reserved
Bus Id	18	2	Bits 0:7 – Bus Number Bits 8:15 – Segment Number
Reserved	20	4	
Bus Address	24	8	Memory or I/O address on the bus at the time of the error.
Bus Data	32	8	Data on the PCI bus at the time of the error.
Bus Command	40	8	Bus command or operation at the time of the error. Byte 7: Bits 7-1: Reserved (should be zero) Byte 7: Bit 0: If 0, then the command is a PCI command. If 1, the command is a PCI-X command.
Bus Requestor Id	48	8	PCI Bus Requestor Id.
Bus Completer Id	56	8	PCI Bus Responder Id.
Target Id	64	8	PCI Bus intended target identifier.

## N.2.9 PCI/PCI-X Component Error Section

Type: {0xEB5E4685, 0xCA66, 0x4769, {0xB6, 0xA2, 0x26, 0x06, 0x8B, 0x00, 0x13, 0x26}}

Table 280. PCI/PCI-X Component Error Section

Mnemonic	Byte Offset	Byte Length	Description
Validation Bits	0	8	Indicate which fields are valid: Bit 0 – Error Status Valid Bit 1 – Id Info Valid Bit 2 – Memory Number Valid Bit 3 – IO Number Valid Bit 4 – Register Data Pair Valid Bit 5-63 Reserved
Error Status	8	8	PCI Component Error Status. See section O for details.
Id Info	16	16	Identification Information: Bytes 0-1: Vendor Id Bytes 1-2: Device Id Bytes 4-6: Class Code Byte 7: Function Number Byte 8: Device Number Byte 9: Bus Number Byte 10: Segment Number Bytes 11-15: Reserved
Memory Number	32	4	Number of PCI Component Memory Mapped register address/data pair values present in this structure.
IO Number	36	4	Number of PCI Component Programmed IO register address/data pair values present in this structure.
Register Data Pairs	40	2x8xN	An array of address/data pair values. The address and data information may be from 2 to 8 bytes of actual data represented in the 8 byte array locations.

## N.2.10 Firmware Error Record Reference

Type: {0x81212A96, 0x09ED, 0x4996, {0x94, 0x71, 0x8D, 0x72, 0x9C, 0x8E, 0x69, 0xED}}

**Table 281. Firmware Error Record Reference**

Mnemonic	Byte Offset	Byte Length	Description
Firmware Error Record Type	0	1	Identifies the type of firmware error record that is referenced by this section: 0: IPF SAL Error Record 1: SOC Firmware error record Type1 is reserved and used by Legacy CrashLog support 2: SOC Firmware error record Type2 All other values reserved
Revision	1	1	Indicates the Header Revision. For this Revision of the specification value is 2.
Reserved	1	7	Must be zero.
Record Identifier	8	8	This value uniquely identifies the firmware error record referenced by this section. This value may be used to retrieve the referenced firmware error record using means appropriate for the error record type. Note value is ignored for Revision >=1 of the header and must be set to NULL.
Record identifier GUID extension	16	16	This value uniquely identifies the firmware error record referenced by this section. This value may be used to retrieve the referenced firmware error record using means appropriate for the error record type. Note: in case if Error Record Type == 2 then this field indicates the GUID. For Error Record Type 0 and Type 1 this field is ignored.

## N.2.11 DMAR Error Sections

The DMAR error sections are divided into two different components as described below:

### DMAR Generic Error Section:

This section holds information about DMAR errors in a generic form and will be common across all DMAR unit architectures.

### Architecture specific DMAR Error Section:

This section consists of DMA remapping errors specific to the architecture. In addition, certain state information of the DMAR unit is captured at the time of error. This section is unique for each DMAR architecture (VT-d, IOMMU).

### N.2.11.1 DMAR Generic Error Section

Type: {0x5B51FEF7, 0xC79D, 0x4434, {0x8F, 0x1B, 0xAA, 0x62, 0xDE, 0x3E, 0x2C, 0x64}}

Table 282. DMAR Generic Errors

Mnemonic	Byte Offset	Byte Length	Description
Requester-ID	0	2	Device ID associated with a fault condition
Segment Number	2	2	PCI segment associated with a device
Fault Reason	4	1	1h: Domain mapping table entry is not present 2h: Invalid domain mapping table entry 3h: DMAR unit's attempt to access the domain mapping table resulted in an error 4h: Reserved bit set to non-zero value in the domain mapping table 5h: DMA request to access an address beyond the device address width 6h: Invalid read or write access 7h: Invalid device request 8h: DMAR unit's attempt to access the address translation table resulted in an error 9h: Reserved bit set to non-zero value in the address translation table Ah: Illegal command error Bh: DMAR unit's attempt to access the command buffer resulted in an error Other values are reserved
Access Type	5	1	0h: DMA Write 1h: DMA Read Other values are reserved
Address Type	6	1	0h: Untranslated request 1h: Translation request Other values are reserved
Architecture Type	7	1	1h: VT-d architecture 2h: IOMMU architecture Other values are reserved
Device Address	8	8	This field contains the 64-bit device virtual address in the faulted DMA request.
Reserved	16	16	Must be 0

### N.2.11.2 Intel® VT for Directed I/O specific DMAR Error Section

Type: {0x71761D37, 0x32B2, 0x45cd, {0xA7, 0xD0, 0xB0, 0xFE 0xDD, 0x93, 0xE8, 0xCF}}

All fields in this error section are specific to Intel's VT-d architecture. This error section has a fixed size.

**Table 283. Intel® VT for Directed I/O specific DMAR Errors**

Mnemonic	Byte Offset	Byte Length	Description
Version	0	1	Value of version register as defined in VT-d architecture
Revision	1	1	Value of revision field in VT-d specific DMA remapping reporting structure
OemId	2	6	Value of OEM ID field in VT-d specific DMA remapping reporting structure
Capability	8	8	Value of capability register in VT-d architecture
Extended Capability	16	8	Value of extended capability register in VT-d architecture
Global Command	24	4	Value of Global Command register in VT-d architecture programmed by the operating system
Global Status	28	4	Value of Global Status register in VT-d architecture
Fault Status	32	4	Value of Fault Status register in VT-d architecture
Reserved	36	12	Must be 0
Fault record	48	16	Fault record as defined in the VT-d specification
Root Entry	64	16	Value from the root entry table for the given requester-ID
Context Entry	80	16	Value from the context entry table for the given requester-ID.
Level 6 Page Table Entry	96	8	PTE entry for device virtual address in page level 6
Level 5 Page Table Entry	104	8	PTE entry for device virtual address in page level 5
Level 4 Page Table Entry	112	8	PTE entry for device virtual address in page level 4
Level 3 Page Table Entry	120	8	PTE entry for device virtual address in page level 3
Level 2 Page Table Entry	128	8	PTE entry for device virtual address in page level 2.
Level 1 Page Table Entry	136	8	PTE entry for device virtual address in page level 1

### N.2.11.3 IOMMU specific DMAR Error Section

Type: {0x036F84E1, 0x7F37, 0x428c, {0xA7, 0x9E, 0x57, 0x5F, 0xDF, 0xAA, 0x84, 0xEC}}

All fields in this error record are specific to AMD's IOMMU specification. This error section has a fixed size.

**Table 284. IOMMU specific DMAR Errors**

Mnemonic	Byte Offset	Byte Length	Description
Revision	0	1	Specifies the IOMMU specification revision
Reserved	1	7	Must be 0
Control	8	8	IOMMU control register
Status	16	8	IOMMU status register
Reserved	24	8	Must be 0
Event Log Entry	32	16	IOMMU fault related event log entry as defined in the IOMMU specification
Reserved	48	16	Must be 0
Device Table Entry	64	32	Value from the device table for a given Requester ID
Level 6 Page Table Entry	96	8	PTE entry for device virtual address in page level 6
Level 5 Page Table Entry	104	8	PTE entry for device virtual address in page level 5
Level 4 Page Table Entry	112	8	PTE entry for device virtual address in page level 4
Level 3 Page Table Entry	120	8	PTE entry for device virtual address in page level 3
Level 2 Page Table Entry	128	8	PTE entry for device virtual address in page level 2
Level 1 Page Table Entry	136	8	PTE entry for device virtual address in page level 1

### Section O: Error Status

The error status definition provides the capability to abstract information from implementation-specific error registers into generic error codes.

**Table 285. Error Status Fields**

Bit Position	Description
7:0	Reserved
15:8	Encoded value for the Error_Type. See Table 20 Error Types for details.
16	Address: Error was detected on the address signals or on the address portion of the transaction.
17	Control: Error was detected on the control signals or in the control portion of the transaction.
18	Data: Error was detected on the data signals or in the data portion of the transaction.
19	Responder: Error was detected by the responder of the transaction.
20	Requester: Error was detected by the requester of the transaction.
21	First Error: If multiple errors are logged for a section type, this is the first error in the chronological sequence. Setting of this bit is optional.
22	Overflow: Additional errors occurred and were not logged due to lack of logging resources.
63:23	Reserved.

**Table 286. Error Types**

Encoding	Description
1	ERR_INTERNAL Error detected internal to the component.
16	ERR_BUS Error detected in the bus.
<b>Detailed Internal Errors</b>	
4	ERR_MEM Storage error in memory (DRAM).
5	ERR_TLB Storage error in TLB.
6	ERR_CACHE Storage error in cache.
7	ERR_FUNCTION Error in one or more functional units.
8	ERR_SELFTEST component failed self test.
9	ERR_FLOW Overflow or undervalue of internal queue.
<b>Detailed Bus Errors</b>	
17	ERR_MAP Virtual address not found on IO-TLB or IO-PDIR.
18	ERR_IMPROPER Improper access error.
19	ERR_UNIMPL Access to a memory address which is not mapped to any component
20	ERR_LOL Loss of Lockstep
21	ERR_RESPONSE Response not associated with a request
22	ERR_PARITY Bus parity error (must also set the A, C, or D Bits).
23	ERR_PROTOCOL Detection of a protocol error.
24	ERR_ERROR Detection of a PATH_ERROR
25	ERR_TIMEOUT Bus operation timeout.
26	ERR_POISONED A read was issued to data that has been poisoned.
All Others	Reserved.





## Appendix O UEFI ACPI Data Table

To prevent ACPI namespace collision, a UEFI ACPI table format is defined. This allows creation of ACPI tables without colliding with tables reserved in the namespace.

**Table 287. UEFI Table Structure**

Field	Byte Length	Byte Offset	Description
Header			
Signature	4	0	'UEFI' (0x55, 0x45, 0x46, 0x49). Signature for UEFI drivers that produce ACPI tables.
Length	4	4	Length, in bytes, of the entire UEFI Table
Revision	1	8	1
Checksum	1	9	Entire table must sum to zero.
OEMID	6	10	OEM ID.
OEM Table ID	8	16	For the UEFI Table, the table ID is the manufacture model ID.
OEM Revision	4	24	OEM revision of UEFI table for supplied OEM Table ID.
Creator ID	4	28	Vendor ID of utility that created the table.
Creator Revision	4	32	Revision of utility that created the table.
Identifier	16	36	This value contains a GUID which identifies the remaining table contents.
DataOffset	2	52	Specifies the byte offset to the remaining data in the UEFI table.
Data	X	DataOffset	Contains the rest of the UEFI table contents

The first use of this UEFI ACPI table format is the SMM Communication ACPI Table. This table describes a special software SMI that can be used to initiate inter-mode communication in the OS present environment by non-firmware agents with SMM code.

**Note:** *The use of the SMM Communication ACPI table is deprecated in UEFI spec. 2.7. This is due to the lack of a use case for inter-mode communication by non-firmware agents with SMM code and support for initiating this form of communication in common OSes.*

Table 288. SMM Communication ACPI Table.

Field	Byte Length	Byte Offset	Description
Signature	4	0	'UEFI' (0x55, 0x45, 0x46, 0x49) Signature for UEFI drivers that produce ACPI tables.
Length	4	4	66+N. Length, in bytes, of the entire Table. N is a length of the optional implementation specific data that can be included in this table.
Revision	1	8	2
Checksum	1	9	Entire table must sum to zero.
OEMID	6	10	OEM ID.
OEM Table ID	8	16	For the UEFI Table, the table ID is the manufacturer model ID.
OEM Revision	4	24	OEM revision of UEFI table for supplied OEM Table ID.
Creator ID	4	28	Vendor ID of utility that created the table.
Creator Revision	4	32	Revision of utility that created the table.
Identifier	16	36	GUID {0xc68ed8e2, 0x9dc6, 0x4cbd, 0x9d, 0x94, 0xdb, 0x65, \ 0xac, 0xc5, 0xc3, 0x32}
DataOffset	2	52	Must be 54 for this version of the specification. Specifies the byte offset of the <i>SW SMI Number</i> field, relative to the start of this table. Future expansion may place additional fields between <i>DataOffset</i> and <i>SW SMI Number</i> , so this offset should always be used to calculate the location of <i>SW SMI Number</i> .
SW SMI Number	4	54	Number to write into software SMI triggering port.
Buffer Ptr Address	8	58	Address of the communication buffer pointer. The pointer address (this field) and the pointer value (the actual address of the communication buffer) are 64-bit physical addresses. The creator of this table must initialize pointer value with 0. The communication buffer must begin with the <b>EFI_SMM_COMMUNICATE_HEADER</b> defined in the "Related Definitions" section below. The communication buffer must be physically contiguous.
Invocation register	12	66	Generic Address Structure (GAS) which provides the address of a register that must be written to with the address of a communication buffer to invoke a management mode service. Using this method of invocation is optional, and if not present this span of the table should be populated with zeros. See ACPI6.0 "Generic Address Structure"

## Invocation method

There are two methods of invocation provided by this specification:

1. Using invocation register

If the invocation register is non-zero, this then this method takes precedence and the SW SMI number field and DataOffset fields must be ignored. The invocation register entry provides the address of a register that must be written to in order to invoke the SMM service. The caller must write the communication buffer address into the register. This will cause an SMM invocation. Upon return from the SMM service call the value in the register provides a return error codes from the SMM invocation. See PI/SMM Vol 4 version xx.yy **EFI\_SMM\_COMMUNICATION\_PROTOCOL.Communicate** function for valid error codes.

The invocation address field uses generic address structure to specify the register address. GAS allows the address space of the register to be Functional Fixed Hardware (FFH). If this address space is used please refer to CPU architecture specific documentation for ascertaining how the write to the register should be performed. For more details on the GAS format please see the *ACPI Specification*.

Note that for implementations that support concurrent invocation of SMM from multiple processors, the register provided must be a per processor register. In such implementation, the calling execution context must not migrate from one CPU to another between writing to the register, to make the SMM call, and reading the value of the register, to read the error return code.

2. Using the SW SMI number

This method is specific to x86 CPUs .

In order to initiate inter-mode communication OS present agent has to perform the following tasks:

- Prepare communication data buffer that starts with the **EFI\_SMM\_COMMUNICATE\_HEADER**.
- Check the value of the communication buffer pointer (a value at the address specified by the Buffer Ptr Address field). If the pointer's value is zero, update it with the address of the communication buffer. If the pointer's value is non-zero, another inter-mode communication transaction is in progress, and the current communication attempt has to be postponed or canceled.

**Note:** *These steps must be performed as an atomic transaction. For example, on IA-32/x64 platforms this can be done using the CMPXCHG CPU instruction.*

- Generate software SMI using value from the SMM Communication ACPI Table. The actual means of generating the software SMI is platform-specific.
- Set communication buffer pointer's value to zero.

## Related Definitions

```
typedef struct {  
    EFI_GUID HeaderGuid;  
    UINTN MessageLength;  
    UINT8 Data[ANYSIZE_ARRAY];  
} EFI_SMM_COMMUNICATE_HEADER;
```

### *HeaderGuid*

Allows for disambiguation of the message format. Type **EFI\_GUID** is defined in **InstallProtocolInterface()**.

### *MessageLength*

Describes the size of *Data* (in bytes) and does not include the size of the header.

### *Data*

Designates an array of bytes that is *MessageLength* in size

# Appendix P

## Hardware Error Record Persistence Usage

---

The OS determines if a platform implements support for *Hardware Error Record Persistence* by reading the *HwErrRecSupport* globally defined variable. If the attempt to read this variable returns `EFI_NOT_FOUND` (14), then the OS will infer that the platform does not implement *Hardware Error Record Persistence*. If the attempt to read this variable succeeds, then the OS uses the returned value to determine whether the platform supports *Hardware Error Record Persistence*. A non-zero value indicates that the platform supports *Hardware Error Record Persistence*.

### P.1 Determining space

To determine the amount of space (in bytes) guaranteed by the platform for saving hardware error records, the OS invokes `QueryVariableInfo`, setting the HR bit in the `Attributes` bitmask.

### P.2 Saving Hardware error records

To save a hardware error record, the OS invokes `SetVariable`, supplying `EFI_HARDWARE_ERROR_VARIABLE` as the *VendorGuid* and setting the HR bit in the *Attributes* bitmask. The *VariableName* will be constructed by the OS by concatenating an index to the string "HwErrRec" (i.e., HwErrRec0001). The index portion of the variable name is determined by reading all of the hardware error record variables currently stored on the platform and choosing an appropriate index value based on the names of the existing variables. The platform saves the supplied *Data*. If insufficient space is present to store the record, the platform will return `EFI_OUT_OF_RESOURCES`, in which case, the OS may clear an existing record and retry. A retry attempt may continue to fail with status `EFI_OUT_OF_RESOURCES` if a reboot is required to coalesce resources after deletion. The OS may only save error records after *ExitBootServices* is called. Firmware may also use the *Hardware Error Record Persistence* interface to write error records, but it may only do so before *ExitBootServices* is called. If firmware uses this interface to write an error record, it must use the *VariableName* format used by the OS as described above and the error records it creates must contain the firmware's *CreatorId*. Firmware may overwrite error records whose *CreatorId* matches the firmware's *CreatorId*. Firmware may overwrite error records that have been cleared by other components.

During OS initialization, the OS discovers the names of all persisted error record variables by enumerating the current variable names using `GetNextVariableName`. Having identified the names of all error record variables, the OS will then read and process all of the error records from the store. After the OS processes an error record, it clears the variable if it was the creator of the variable (determined by checking the *CreatorId* field of the error record).

### P.3 Clearing error record variables

To clear error record variables, the OS invokes `SetVariable`, supplying `EFI_HARDWARE_ERROR_VARIABLE` as the *VendorGuid* and setting the HR bit in the *Attributes* bitmask. The supplied *DataSize*, and *Data* parameters will all be set to zero to indicate that the variable is to be cleared. The supplied *VariableName* identifies which error record variable is to be cleared. The OS may only clear error records after *ExitBootServices* has been called. The OS itself may only clear error records which it created (e.g. error records whose *CreatorId* matches that of the OS). However, a management application running on the OS may clear error records created by other components. This enables error records created by firmware or other OSes to be cleared by the currently running OS.

# Appendix Q References

---

## Q.1 Related Information

The following publications and sources of information may be useful to you or are referred to by this specification:

- "8802.1x Port-based access control" at "Links to UEFI-Related Documents" (<http://uefi.org/uefi>).
- "802.1X-2004, *IEEE Standard for Local and Metropolitan Area Networks Port-Based Network Access Control*" at "Links to UEFI-Related Documents" (<http://uefi.org/uefi>).
- "AMD64 Architecture Programmer's Manual" at "Links to UEFI-Related Documents" (<http://uefi.org/uefi>).
- "Advanced Configuration and Power Interface Specification, 3.0". at "Links to UEFI-Related Documents" (<http://uefi.org/uefi>) under the heading
- "Advanced Configuration and Power Interface Specification, 4.0" at "Links to UEFI-Related Documents" (<http://uefi.org/uefi>).
- "Address Resolution Protocol; Refer to Appendix E, "32/ 64-Bit UNDI Specification" at "Links to UEFI-Related Documents" (<http://uefi.org/uefi>).
- "BIOS Boot Specification Version 1.01" at "Links to UEFI-Related Documents" (<http://uefi.org/uefi>).
- "CAE Specification [UUID], DCE 1.1:Remote Procedure Call, Document Number C706, Universal Unique Identifier Appendix" at "Links to UEFI-Related Documents" (<http://uefi.org/uefi>).
- "[BASE64] RFC 1521: MIME (Multipurpose Internet Mail Extensions) Part One: Mechanisms for Specifying and Describing the Format of Internet Message Bodies" at "Links to UEFI-Related Documents" (<http://uefi.org/uefi>).
- "Bluetooth Network Encapsulation Protocol (BNEP) Specification, version 1.0" at "Links to UEFI-Related Documents" (<http://uefi.org/uefi>).
- "BLUETOOTH SPECIFICATION, version 4.1" at "Links to UEFI-Related Documents" (<http://uefi.org/uefi>).
- Bootstrap Protocol; This reference is included for backward compatibility. BC protocol supports DHCP and BOOTP. Refer to Appendix E, "32/ 64-Bit UNDI Specification, RFC 0951" at "Links to UEFI-Related Documents" (<http://uefi.org/uefi>).
- [DBCS] *Japanese Language DBCS* (Double Byte Character Set): MS-DOS Version, Sizuoka Information Industry, AX Conference, 1991.
- "[EAP] Tunneled TLS Authentication Protocol Version 1 (EAP-TTLSv1)" at "Links to UEFI-Related Documents" (<http://uefi.org/uefi>).
- [ECMA 262] ECMA Script Language Specification (ECMA-262) Edition 5.1".at "Links to UEFI-Related Documents" (<http://uefi.org/uefi>) under the heading "

- "EFI Specification Version 1.02" heading at "Links to UEFI-Related Documents" (<http://uefi.org/uefi>).
- "EFI Specification Version 1.10" heading at "Links to UEFI-Related Documents" (<http://uefi.org/uefi>).
- "El Torito" Bootable CD-ROM Format Specification, Version 1.0" at "Links to UEFI-Related Documents" (<http://uefi.org/uefi>).
- *Envisioning Information*, Edward R. Tufte, Graphics Press, 1990.
- *File Verification Using CRC*, Mark R. Nelson, Dr. Dobbs, May 1994
- *HTML: The Definitive Guide*, 2<sup>nd</sup> Edition, Chuck Musciano and Bill Kennedy, O'Reilly and Associates, Inc., 1997, ISBN: 1-56592-235-2.
- "IEEE Standard for Local and metropolitan area networks: Virtual Bridged Local Area Networks, IEEE Std 802.1Q - 2005" heading at "Links to UEFI-Related Documents" (<http://uefi.org/uefi>).
- "Information Technology — BIOS Enhanced Disk Drive Services (EDD), working draft T13/ 1386D, Revision 5a" heading at "Links to UEFI-Related Documents" (<http://uefi.org/uefi>).
- "Intel 64 and IA=32 Architecture Software Developer's Manual" heading at "Links to UEFI-Related Documents" (<http://uefi.org/uefi>).
- "iSCSI Boot Firmware Table (iBFT) as defined in *ACPI 3.0b Specification*, Version 1.01," heading at "Links to UEFI-Related Documents" (<http://uefi.org/uefi>).
- "ISO Standard 9995, Keyboard layouts for text and office systems" heading at "Links to UEFI-Related Documents" (<http://uefi.org/uefi>).
- "Itanium® Architecture Software Developer's Manual, Volume 1: Application Architecture, Rev. 2.2," heading at "Links to UEFI-Related Documents" (<http://uefi.org/uefi>).
- "Itanium® Architecture Software Developer's Manual, Volume 2: System Architecture, Rev. 2.2" heading at "Links to UEFI-Related Documents" (<http://uefi.org/uefi>).
- "Itanium® Architecture Software Developer's Manual, Volume 3: Instruction Set Reference, Rev. 2.2" heading at "Links to UEFI-Related Documents" (<http://uefi.org/uefi>).
- "Itanium® Software Conventions and Runtime Architecture Guide" heading at "Links to UEFI-Related Documents" (<http://uefi.org/uefi>).
- "Itanium® System Abstraction Layer Specification" heading at "Links to UEFI-Related Documents" (<http://uefi.org/uefi>).
- IEEE 1394 Specification, <http://www.1394ta.org/Technology/Specifications/specifications.htm>
- "Internet Engineering Task Force (IETF)" heading at "Links to UEFI-Related Documents" (<http://uefi.org/uefi>). Refer to Appendix E, "32/64-Bit UNDI Specification," for more information.
- "ISO 639-2:1998. *Codes for the Representation of Names of Languages – Part2: Alpha-3 code*" heading at "Links to UEFI-Related Documents" (<http://uefi.org/uefi>).



- ISO/IEC 3309:1991(E), *Information Technology - Telecommunications and information exchange between systems - High-level data link control (HDLC) procedures - Frame structure*, International Organization For Standardization, Fourth edition 1991-06-01
- ITU-T Rec. V.42, *Error-Correcting Procedures for DCEs using asynchronous-to-synchronous conversion*, October, 1996
- *JavaScript: The Definitive Guide*, 3<sup>rd</sup> Edition, David Flanagan, O'Reilly and Associates, Inc., 1998, ISBN: 1-56592-392-8.
- *JavaScript: The Complete Reference*, Thomas Powell & Fritz Schneider (McGraw-Hill/Osborne, Emeryville California, 2004)
- "Microsoft Extensible Firmware Initiative FAT32 File System Specification, Version 1.03" heading at "Links to UEFI-Related Documents" (<http://uefi.org/uefi>).
- "Microsoft Portable Executable and Common Object File Format Specification, Version 8.1" heading at "Links to UEFI-Related Documents" (<http://uefi.org/uefi>).
- "Microsoft Windows Authenticode Portable Executable Signature Format, Version 1.0" heading at "Links to UEFI-Related Documents" (<http://uefi.org/uefi>).
- "OSTA Universal Disk Format Specification, Revision 2.00" heading at "Links to UEFI-Related Documents" (<http://uefi.org/uefi>).
- "PCI BIOS Specification, Revision 3.0" heading at "Links to UEFI-Related Documents" (<http://uefi.org/uefi>).
- "Part11: Wireless LAN Medium Access Control (MAC) and Physical Layer (PHY) Specifications" at "Links to UEFI-Related Documents" (<http://uefi.org/uefi>).
- "PCI Express Base Specification, Revision 2.1" heading at "Links to UEFI-Related Documents" (<http://uefi.org/uefi>).
- "PCI Hot-Plug Specification, Revision 1.0," heading at "Links to UEFI-Related Documents" (<http://uefi.org/uefi>).
- "PCI Local Bus Specification, Revision 3.0" heading at "Links to UEFI-Related Documents" (<http://uefi.org/uefi>).
- "Plug and Play BIOS Specification, Version 1.0A," heading at "Links to UEFI-Related Documents" (<http://uefi.org/uefi>).
- "POST Memory Manager Specification, Version 1.01," heading at "Links to UEFI-Related Documents" (<http://uefi.org/uefi>).
- *Professional XML*, Didier Martin, Mark Birbeck, et. al., Wrox Press, April, 2000, ISBN: 1-861003-11-0.
- [PUI] *Programming the User Interface: Principles and Examples*, Judith R. Brown, Steve Cunningham, John Wiley & Sons, 1989, ISBN: 0-471-63843-9.
- "Microsoft's PEAP version 0" at "Links to UEFI-Related Documents" (<http://uefi.org/uefi>).
- [PKCS] *The Public-Key Cryptography Standards*, RSA Laboratories, Redwood City, CA: RSA Data Security, Inc.

- "PC/SC Specification, Part 3: Requirements for PC-Connected Interface Devices" at "Links to UEFI-Related Documents" (<http://uefi.org/uefi>).
- "Processor Architecture Type" at "Links to UEFI-Related Documents" (<http://uefi.org/uefi>).
- "Protected EAP Protocol (PEAP)" at "Links to UEFI-Related Documents" (<http://uefi.org/uefi>).
- "Protected EAP Protocol (PEAP) Version 2" at "Links to UEFI-Related Documents" (<http://uefi.org/uefi>).
- "Request For Comments" heading at "Links to UEFI-Related Documents" (<http://uefi.org/uefi>). Refer to Appendix E, "32/64-Bit UEFI Specification," for more information.
- "[RFC0768] User Datagram Protocol – UDP over IPv4" heading at "Links to UEFI-Related Documents" (<http://uefi.org/uefi>).
- "[RFC 791] Internet Protocol DARPA Internet Program Protocol (IPv4) Specification" at "Links to UEFI-Related Documents" (<http://uefi.org/uefi>).
- "[RFC0792] ICMP for Ipv4" heading at "Links to UEFI-Related Documents" (<http://uefi.org/uefi>). Refer to Appendix E, "32/64-Bit UEFI Specification," for more information.
- "[RFC0793] Transmission Control Protocol – TCPv4" heading at "Links to UEFI-Related Documents" (<http://uefi.org/uefi>). Refer to Appendix E, "32/64-Bit UEFI Specification," for more information.
- "[RFC 1034] Domain Names - Concepts and Facilities" at "Links to UEFI-Related Documents" (<http://uefi.org/uefi>).
- "[RFC 1035] Domain Names - Implementation and Specification" at "Links to UEFI-Related Documents" (<http://uefi.org/uefi>).
- "[RFC1350] Trivial File Transfer Protocol – TFTP" heading at "Links to UEFI-Related Documents" (<http://uefi.org/uefi>). Refer to Appendix E, "32/64-Bit UEFI Specification," for more information.
- "[RFC 1700] ASSIGNED NUMBERS" at "Links to UEFI-Related Documents" (<http://uefi.org/uefi>).
- "[RFC 1994] PPP Challenge Handshake Authentication Protocol (CHAP)" at "Links to UEFI-Related Documents" (<http://uefi.org/uefi>).
- "[RFC2131] Dynamic Host Configuration Protocol" at "Links to UEFI-Related Documents" (<http://uefi.org/uefi>).
- "[RFC2132] DHCP Options and BOOTP Vendor Extensions," at "Links to UEFI-Related Documents" (<http://uefi.org/uefi>).
- "[RFC2147] Transmission Control Protocol v6 – TCPv6" heading at "Links to UEFI-Related Documents" (<http://uefi.org/uefi>). Refer to Appendix E, "32/64-Bit UEFI Specification," for more information. Refer to Appendix E, "32/64-Bit UEFI Specification," for more information.
- "[RFC2236] Internet Group Management Protocol" heading at "Links to UEFI-Related Documents" (<http://uefi.org/uefi>).

- "[RFC 2246] The TLS Protocol Version 1.0" at "Links to UEFI-Related Documents" (<http://uefi.org/uefi>).
- "[RFC2315] Cryptographic Message Syntax Version 1.5" at "Links to UEFI-Related Documents" (<http://uefi.org/uefi>).
- "[RFC2347] TFTP Option Extension" heading at "Links to UEFI-Related Documents" (<http://uefi.org/uefi>). Refer to Appendix E, "32/64-Bit UEFI Specification," for more information.
- "[RFC2348] TFTP Blocksize Option" heading at "Links to UEFI-Related Documents" (<http://uefi.org/uefi>). Refer to Appendix E, "32/64-Bit UEFI Specification," for more information.
- "[RFC2349] TFTP Timeout Interval and Transfer Size Options" heading at "Links to UEFI-Related Documents" (<http://uefi.org/uefi>). Refer to Appendix E, "32/64-Bit UEFI Specification," for more information.
- "[RFC 2407]The Internet IP Security Domain of Interpretation for ISAKMP" at "Links to UEFI-Related Documents" (<http://uefi.org/uefi>) .
- "[RFC 2408]Internet Security Association and Key Management Protocol(ISAKMP)" at "Links to UEFI-Related Documents" (<http://uefi.org/uefi>).
- "[RFC 2409]The Internet Key Exchange (IKE)" at "Links to UEFI-Related Documents" (<http://uefi.org/uefi>).
- "[RFC2454] User Datagram Protocol – UDP over IPv6" heading at "Links to UEFI-Related Documents" (<http://uefi.org/uefi>).
- "[RFC 2459] Internet X.509 Public Key Infrastructure Certificate and CRL Profile" at "Links to UEFI-Related Documents" (<http://uefi.org/uefi>) .
- "[RFC 2460] Internet Protocol, Version 6 (IPv6) Specification" at "Links to UEFI-Related Documents" (<http://uefi.org/uefi>).
- "[RFC2463] ICMP for Ipv6" heading at "Links to UEFI-Related Documents" (<http://uefi.org/uefi>). Refer to Appendix E, "32/64-Bit UEFI Specification," for more information
- "[RFC 2759] Microsoft PPP CHAP Extensions, Version 2" at "Links to UEFI-Related Documents" (<http://uefi.org/uefi>).
- "[RFC 2818] HTTP Over TLS" at "Links to UEFI-Related Documents" (<http://uefi.org/uefi>).
- "[RFC 3004] The User Class option for DHCP" at "Links to UEFI-Related Documents" (<http://uefi.org/uefi>).
- [RFC 3232] J. Reynolds, "Assigned Numbers: RFC 1700 is Replaced by an On-line Database", January 2002
- "[RFC 3315] Dynamic Host Configuration Protocol for IPv6 (DHCPv6)" at "Links to UEFI-Related Documents" (<http://uefi.org/uefi>).
- "[RFC 3396] Encoding Long Options in the Dynamic Host Configuration Protocol" at "Links to UEFI-Related Documents" (<http://uefi.org/uefi>).

- "[RFC 3513] Internet Protocol Version 6 (IPv6) Addressing Architecture" at "Links to UEFI-Related Documents" (<http://uefi.org/uefi>) under the heading.
- "[RFC 3596] DNS Extensions to Support IP Version 6" at "Links to UEFI-Related Documents" (<http://uefi.org/uefi>).
- "[RFC 3617] Uniform Resource Identifier (URI) Scheme and Applicability Statement for the Trivial File Transfer Protocol (TFTP)" at "Links to UEFI-Related Documents" (<http://uefi.org/uefi>).
- "[RFC 3646] DNS Configuration options for Dynamic Host Configuration Protocol for IPv6 (DHCPv6)" at "Links to UEFI-Related Documents" (<http://uefi.org/uefi>).
- "[RFC 3720] Internet Small Computer Systems Interface (iSCSI)" at "Links to UEFI-Related Documents" (<http://uefi.org/uefi>).
- "[RFC 3748] Extensible Authentication Protocol (EAP)" at "Links to UEFI-Related Documents" (<http://uefi.org/uefi>).
- "[RFC 3986 ]Uniform Resource Identifiers (URI): Generic Syntax" at "Links to UEFI-Related Documents" (<http://uefi.org/uefi>).
- "[RFC 4173] Bootstrapping Clients using the Internet Small Computer System Interface (iSCSI) Protocol" at "Links to UEFI-Related Documents" (<http://uefi.org/uefi>).
- "[RFC 4301]Security Architecture for the Internet Protocol" at "Links to UEFI-Related Documents" (<http://uefi.org/uefi>).
- "[RFC 4303]IP Encapsulation Security Payload (ESP)" at "Links to UEFI-Related Documents" (<http://uefi.org/uefi>).
- "[RFC 4346] The Transport Layer Security (TLS) Protocol Version 1.1" at "Links to UEFI-Related Documents" (<http://uefi.org/uefi>) under the heading.
- "[RFC 4347] Datagram Transport Layer Security" at "Links to UEFI-Related Documents" (<http://uefi.org/uefi>) under the heading
- "[RFC4578] Dynamic Host Configuration Protocol (DHCP) Options for the Intel Preboot eXecution Environment (PXE)" at "Links to UEFI-Related Documents" (<http://uefi.org/uefi>).
- "[RFC 5216] The EAP-TLS Authentication Protocol" at "Links to UEFI-Related Documents" (<http://uefi.org/uefi>) under the heading.
- "[RFC 5246] The Transport Layer Security (TLS) Protocol Version 1.2" at "Links to UEFI-Related Documents" (<http://uefi.org/uefi>).
- "[RFC 5247] Extensible Authentication Protocol (EAP) Key Management Framework" at "Links to UEFI-Related Documents" (<http://uefi.org/uefi>).
- "[RFC 5281] Extensible Authentication Protocol Tunneled Transport Layer Security Authenticated Protocol Version 0" at "Links to UEFI-Related Documents" (<http://uefi.org/uefi>).
- "[RFC 5970] DHCPv6 Options for Network Boot," at "Links to UEFI-Related Documents" (<http://uefi.org/uefi>).
- "[RFC 6101] The Secure Sockets Layer (SSL) Protocol Version 3.0" at "Links to UEFI-Related Documents" (<http://uefi.org/uefi>).

- "[RFC 6347] Datagram Transport Layer Security Version 1.2 (DTLS)" at "Links to UEFI-Related Documents" (<http://uefi.org/uefi>).
- "[SM spec] Common Security: CDSA and CSSM, Version 2 (with corrigenda), was Signed Manifest Specification" at "Links to UEFI-Related Documents" (<http://uefi.org/uefi>).
- *Super VGA Graphics Programming Secrets*, Steve Rimmer, Windcrest / McGraw-Hill, 1993, ISBN: 0-8306-4428-8.
- "System Management BIOS Reference Specification, Version 2.6.1" heading at "Links to UEFI-Related Documents" (<http://uefi.org/uefi>).
- *The Visual Display of Quantitative Information*, Edward R. Tufte, Graphics Press, 1983.
- "The Unicode Standard, Version 5.2" heading at "Links to UEFI-Related Documents" (<http://uefi.org/uefi>).
- "Universal Serial Bus PC Legacy Compatibility Specification, Version 0.9," heading at "Links to UEFI-Related Documents" (<http://uefi.org/uefi>).
- "Universal Serial Bus Specification, Revision 2.0" heading at "Links to UEFI-Related Documents" (<http://uefi.org/uefi>).
- "USB Battery Charging Specification" heading at "Links to UEFI-Related Documents" (<http://uefi.org/uefi>).
- XML: A Primer, Simon St. Laurent, MIS:Press, 1998, ISBN:1-5582-8592-X.

## Q.2 Prerequisite Specifications

In general, this specification requires that functionality defined in a number of other existing specifications be present on a system that implements this specification. This specification requires that those specifications be implemented at least to the extent that all the required elements are present.

This specification prescribes the use and extension of previously established industry specification tables whenever possible. The trend to remove runtime call-based interfaces is well documented. The ACPI (Advanced Configuration and Power Interface) specification is an example of new and innovative firmware technologies that were designed on the premise that OS developers prefer to minimize runtime calls into firmware. ACPI focuses on no runtime calls to the BIOS.

### Q.2.1 ACPI Specification

The interface defined by the *Advanced Configuration and Power Interface (ACPI) Specification* is the primary OS runtime interface for IA-32, x64 and Itanium platforms. ACPI fully defines the methodology that allows the OS to discover and configure all platform resources. ACPI allows the description of non-Plug and Play motherboard devices in a plug and play manner. ACPI also is capable of describing power management and hot plug events to the OS. (For more information on ACPI, see "Links to UEFI-Related Documents" (<http://uefi.org/uefi>) under the heading "ACPI"; see also <http://uefi.org/acpi>).

## Q.2.2 Additional Considerations for Itanium-Based Platforms

Any information or service that is available in Itanium architecture firmware specifications supercedes any requirement in the common supported 32-bit and Itanium architecture specifications listed above. The Itanium architecture firmware specifications (currently the *Itanium® System Abstraction Layer Specification* and portions of the *Intel® Itanium® Architecture Software Developer's Manual*, volumes 1–3) define the baseline functionality required for all Itanium architecture platforms. The major addition that UEFI makes to these Itanium architecture firmware specifications is that it defines a boot infrastructure and a set of services that constitute a common platform definition for high-volume Itanium architecture–based systems to implement based on the more generalized Itanium architecture firmware specifications.

The following specifications are the required Intel Itanium architecture specifications for all Itanium architecture–based platforms:

- "Itanium® System Abstraction Layer Specification" heading at "Links to UEFI-Related Documents" (<http://uefi.org/uefi>).
- "Itanium® Architecture Software Developer's Manual, Volume 1: Application Architecture, Rev. 2.2," heading at "Links to UEFI-Related Documents" (<http://uefi.org/uefi>).
- "Itanium® Architecture Software Developer's Manual, Volume 2: System Architecture, Rev. 2.2" heading at "Links to UEFI-Related Documents" (<http://uefi.org/uefi>).
- "Itanium® Architecture Software Developer's Manual, Volume 3: Instruction Set Reference, Rev. 2.2" heading at "Links to UEFI-Related Documents" (<http://uefi.org/uefi>).

# Appendix R Glossary

---

## **\_ADR**

A reserved name in [ACPI](#) name space. It refers to an address on a bus that has standard enumeration. An example would be PCI, where the enumeration method is described in the PCI Local Bus specification.

## **\_CRS**

A reserved name in [ACPI](#) name space. It refers to the current resource setting of a device. A **\_CRS** is required for devices that are not enumerated in a standard fashion. **\_CRS** is how ACPI converts nonstandard devices into Plug and Play devices.

## **\_HID**

A reserved name in [ACPI](#) name space. It represents a device's plug and play hardware ID and is stored as a 32-bit compressed EISA ID. **\_HID** objects are optional in ACPI. However, a **\_HID** object must be used to describe any device that will be enumerated by the ACPI driver in the OS. This is how ACPI deals with non-Plug and Play devices.

## **\_UID**

A reserved name in [ACPI](#) name space. It is a serial number style ID that does not change across reboots. If a system contains more than one device that reports the same [\\_HID](#), each device must have a unique **\_UID**. The **\_UID** only needs to be unique for device that have the exact same [\\_HID](#) value.

## **ACPI Device Path**

A [Device Path](#) that is used to describe devices whose enumeration is not described in an industry-standard fashion. These devices must be described using ACPI AML in the [ACPI](#) name space; this type of node provides linkage to the ACPI name space.

## **ACPI**

Refers to the *Advanced Configuration and Power Interface Specification* and to the concepts and technology it discusses. The specification defines a new interface to the system board that enables the operating system to implement operating system-directed power management and system configuration.

## **Alt-GR Unicode**

Represents the character code of a key when the Alt-GR modifier key is held down. This key (A2) in some keyboard layouts is defined as the right alternate key and serves the same function as the left alternate key. However, in many other layouts it is a secondary modifier key similar to shift. For instance, key C1 is equated to the letter *a* and its Unicode character code in the typical U.K. keyboard is a non-shifted character code of 0x0061. When



holding down the Alt-GR key in conjunction with the pressing of key C1, , the value on the same keyboard often produces an *á*, which is a character code 0x00E1.

### Base Code (BC)

The [PXE](#) Base Code, included as a core protocol in [EFI](#), is comprised of a simple network stack (UDP/IP) and a few common network protocols ([DHCP](#), Bootserver Discovery, [TFTP](#)) that are useful for remote booting machines.

### BC

See [Base Code \(BC\)](#)

### Big Endian

A memory architecture in which the low-order byte of a multibyte datum is at the highest address, while the high-order byte is at the lowest address. See [Little Endian](#).

### BIOS Boot Specification Device Path

A [Device Path](#) that is used to point to boot legacy operating systems; it is based on the *BIOS Boot Specification, Version 1.01*.

### BIOS Parameter Block (BPB)

The first block (sector) of a partition. It defines the type and location of the [FAT File System](#) on a drive.

### BIOS

Basic Input/Output System. A collection of low-level I/O service routines.

### Block I/O Protocol

A protocol that is used during boot services to abstract mass storage devices. It allows boot services code to perform block I/O without knowing the type of a device or its controller.

### Block Size

The fundamental allocation unit for devices that support the [Block I/O Protocol](#). Not less than 512 bytes. This is commonly referred to as sector size on hard disk drives.

### Boot Device

The [Device Handle](#) that corresponds to the device from which the currently executing image was loaded.

### Boot Manager

The part of the firmware implementation that is responsible for implementing system boot policy. Although a particular boot manager implementation is not specified in this document, such code is generally expected to be able to enumerate and handle transfers of control to the available OS loaders as well as UEFI applications and drivers on a given system. The boot manager would typically be responsible for interacting



with the system user, where applicable, to determine what to load during system startup. In cases where user interaction is not indicated, the boot manager would determine what to load and, if multiple items are to be loaded, what the sequencing of such loads would be.

### **Block Size**

The fundamental allocation unit for devices that support the Block I/O Protocol. Not less than 512 bytes. This is commonly referred to as sector size on disk drives.

### **Boot Services Table**

A table that contains the firmware entry points for accessing boot services functions such as [Task Priority Services](#) and [Memory Allocation Services](#). The table is accessed through a pointer in the [System Table](#).

### **Boot Services Time**

The period of time between platform initialization and the call to [ExitBootServices\(\)](#). During this time, [UEFI Driver](#) and applications are loaded iteratively and the system boots from an ordered list of EFI OS loaders.

### **Boot Services**

The collection of interfaces and protocols that are present in the boot environment. The services minimally provide an OS loader with access to platform capabilities required to complete OS boot. Services are also available to drivers and applications that need access to platform capability. Boot services are terminated once the operating system takes control of the platform.

### **BPB**

See [BIOS Parameter Block \(BPB\)](#).

### **BTT**

Block Translation Table: A software mechanism for adding single block write atomicity to any Block Mode ranges or byte-addressable Persistent Memory ranges.

### **Callback**

Target function which augments the Forms Processor's ability to evaluate or process configuration settings. Callbacks are not available when the Forms Processor is operating in a Disconnected state.

### **CIM**

See [Common Information Model \(CIM\)](#).

### **Cluster**

A collection of disk sectors. Clusters are the basic storage units for disk files. See [File Allocation Table \(FAT\)](#).

### **COFF**

Common Object File Format, a standard file format for binary images.

### Coherency Domain

- (1) The global set of resources that is visible to at least one processor in a platform.
- (2) The address resources of a system as seen by a processor. It consists of both system memory and I/O space.

### Common Information Model (CIM)

An object-oriented schema defined by the [DMTF](#). CIM is an information model that provides a common way to describe and share management information enterprise-wide.

### Console I/O Protocol

A protocol that is used during [Boot Services](#) to handle input and output of text-based information intended for the system administrator. It has two parts, a [Simple Input Protocol](#) that is used to obtain input from the [ConsoleIn](#) device and a [Simple Text Output Protocol](#) that is used to control text-based output devices. The [Console I/O Protocol](#) is also known as the EFI Console I/O Protocol.

### ConsoleIn

The device handle that corresponds to the device used for user input in the boot services environment. Typically the system keyboard.

### ConsoleOut

The device handle that corresponds to the device used to display messages to the user from the boot services environment. Typically a display screen.

### DBCS

Double Byte Character Set.

### Desktop Management Interface (DMI)

A platform management information framework, built by the [DMTF](#) and designed to provide manageability for desktop and server computing platforms by providing an interface that is:

- (1) independent of any specific desktop operating system, network operating system, network protocol, management protocol, processor, or hardware platform;
- (2) easy for vendors to implement; and
- (3) easily mapped to higher-level protocols.

### Desktop Management Task Force (DMTF)

The DMTF is a standards organization comprised of companies from all areas of the computer industry. Its purpose is to create the standards and infrastructure for cost-effective management of PC systems.

### Device Handle

A handle points to a list of one or more protocols that can respond to requests for services for a given device referred to by the handle.

### **Device I/O Protocol**

A protocol that is used during boot services to access memory and I/O. Also called the EFI Device I/O Protocol.

### **Device Path Instance**

When an environment variable represents multiple devices, it is possible for a device path to contain multiple device paths. An example of this would be the [ConsoleOut](#) environment variable that consists of both a VGA console and a serial output console. This environment variable would describe a console output stream that would send output to both devices and therefore has a Device Path that consists of two complete device paths. Each of these paths is a device path instance.

### **Device Path Node**

A variable-length generic data structure that is used to build a device path. Nodes are distinguished by type, subtype, length, and path-specific data. See [Device Path](#).

### **Device Path Protocol**

A protocol that is used during boot services to provide the information needed to construct and manage Device Paths. Also called the EFI Device Path Protocol.

### **Device Path**

A variable-length binary data structure that is composed of variable-length generic device path nodes and is used to define the programmatic path to a logical or physical device. There are six major types of device paths: [Hardware Device Path](#), [ACPI Device Path](#), [Messaging Device Path](#), [Media Device Path](#), [BIOS Boot Specification Device Path](#), and [End of Hardware Device Path](#).

### **DHCP**

See [Dynamic Host Configuration Protocol \(DHCP\)](#).

### **Disconnected**

The state when a Forms Processor is manipulating a form set without being connected to the Target's pre-OS environment. For example, after booting an OS, a Forms Processor cannot execute call-backs or read the configuration settings. For example, when running a Forms Browser while on a remote machine that is not connected to the Target. In these cases, the Forms Processor has limited knowledge of the Target's current configuration settings and limited or no ability to use call-backs.

### **Disk I/O Protocol**

A protocol that is used during boot services to abstract Block I/O devices to allow non-block-sized I/O operations. Also called the EFI Disk I/O Protocol.

**DMI**

See [DBCS](#).

**DMTF**

See [Desktop Management Task Force \(DMTF\)](#).

**DNS**

Domain Name System. A protocol used manipulating and translating hostname and IP address

**DTLS**

Datagram Transport Layer Security. A protocol to provide communication privacy above UDP.

**Dynamic Host Configuration Protocol (DHCP)**

A protocol that is used to get information from a configuration server. DHCP is defined by the [Desktop Management Task Force \(DMTF\)](#), not [EFI](#).

**EAP**

Extensible Authentication Protocol. An authentication framework which supports multiple authentication methods

**EBC Image**

Executable EBC image following the PE32 file format.

**EBC**

See [EFI Byte Code \(EBC\)](#).

**EFI**

Extensible Firmware Interface. An interface between the operating system (OS) and the platform firmware.

**EFI Byte Code (EBC)**

The binary encoding of instructions as output by the EBC C compiler and linker. The [EBC Image](#) is executed by the interpreter.

**EFI File**

A container consisting of a number of blocks that holds an image or a data file within a file system that complies with this specification.

**EFI Hard Disk**

A hard disk that supports the new EFI partitioning scheme ([GUID Partition](#)).

**EFI-compliant**

Refers to a platform that complies with this specification.

**EFI-conformant**

See [EFI-compliant](#).

## End of Hardware Device Path

A Device Path which, depending on the subtype, is used to indicate the end of the Device Path instance or Device Path structure.

## Enhanced Mode (EM)

The 64-bit architecture extension that makes up part of the Intel® Itanium® architecture.

## Event Services

The set of functions used to manage events. Includes [EFI\\_BOOT\\_SERVICES.CheckEvent\(\)](#), [EFI\\_BOOT\\_SERVICES.CreateEvent\(\)](#), [EFI\\_BOOT\\_SERVICES.CloseEvent\(\)](#), [EFI\\_BOOT\\_SERVICES.SignalEvent\(\)](#), and [EFI\\_BOOT\\_SERVICES.WaitForEvent\(\)](#).

## Event

An EFI data structure that describes an “event”—for example, the expiration of a timer.

## Event Services

The set of functions used to manage events. Includes [EFI\\_BOOT\\_SERVICES.CheckEvent\(\)](#), [EFI\\_BOOT\\_SERVICES.CreateEvent\(\)](#), [EFI\\_BOOT\\_SERVICES.CloseEvent\(\)](#), [EFI\\_BOOT\\_SERVICES.SignalEvent\(\)](#), and [EFI\\_BOOT\\_SERVICES.WaitForEvent\(\)](#).

## FAT File System

The file system on which the [EFI File](#) system is based. See [File Allocation Table \(FAT\)](#) and [GUID Partition Table \(GPT\)](#).

## FAT

See [File Allocation Table \(FAT\)](#).

## File Allocation Table (FAT)

A table that is used to identify the clusters that make up a disk file. File allocation tables come in three flavors: FAT12, which uses 12 bits for cluster numbers; FAT16, which uses 16 bits; and FAT32, which allots 32 bits but only uses 28 (the other 4 bits are reserved for future use).

## File Handle Protocol

A component of the [File System Protocol](#). It provides access to a file or directory. Also called the EFI File Handle Protocol.

## File System Protocol

A protocol that is used during boot services to obtain file-based access to a device. It has two parts, a [Simple File System Protocol](#) that provides a minimal interface for file-type access to a device, and a [File Handle Protocol](#) that provides access to a file or directory.

## Firmware

Any software that is included in read-only memory (ROM).

## Font

A graphical representation corresponding to a character set, in this case Unicode. The following are the same Latin letter in three fonts using the same size (14):

A  
A  
A

## Font glyph

The individual elements of a font corresponding to single characters are called *font glyphs* or simply *glyphs*. The first character in each of the above three lines is a *glyph* for the letter "A" in three different fonts.

## Form

Logical grouping of questions with a unique identifier.

## Form Set

An HII database package describing a group of forms, including one parent form and zero or more child forms.

## Forms Browser

A Forms Processor capable of displaying the user-interface information a display and interacting with a user.

## Forms Processor

An application capable of reading and processing the forms data within a forms set.

## Globally Unique Identifier (GUID)

A 128-bit value used to differentiate services and structures in the boot services environment. The format of a **GUID** is defined in Appendix A. See [Protocol](#).

## Glyph

The individual elements of a font corresponding to single characters. May also be called *font keyboard layout glyphs*. Also see *font glyph* above.

**GPT:** See [GUID Partition Table \(GPT\)](#).

## GPT disk layout:

The data layout on a disk consisting of a protective MBR in LBA 0, a GPT Header in LBA 1, and additional GPT structures and partitions in the remaining LBAs. See chapter 5.

## GPTHeader

The header in a [GUID Partition Table \(GPT\)](#). Among other things, it contains the number of GPT Partition Entries and the first and last LBAs that can be used for the entries.

### **GPT Partition Entry**

A data structure that characterizes a Partition in the GPT disk layout. Among other things, it specifies the starting and ending LBA of the partition.

### **GUID Partition Table (GPT)**

A data structure that describes one or more partitions. It consists of a [GPTHeader](#) and, typically, at least one [GPTPartition Entry](#). There are two GUID partition tables: the Primary Partition Table (located in LBA 1 of the disk) and a Backup Partition Table (located in the last LBA of the disk). The Backup Partition Table is a copy of the Primary Partition Table.

### **GPTPartition Entry**

A data structure that characterizes a [GUID Partition](#). Among other things, it specifies the starting and ending LBA of the partition.

### **GUID Partition**

A contiguous group of sectors on an [EFI Hard Disk](#).

### **Handle**

See [Device Handle](#).

### **Hardware Device Path**

A Device Path that defines how a hardware device is attached to the resource domain of a system (the resource domain is simply the shared memory, memory mapped I/O, and I/O space of the system).

### **HII**

Human Interface Infrastructure.

### **HII Database**

The centralized repository for HII-related information, organized as package lists.

### **HTML**

Hypertext Markup Language. A particular implementation of SGML focused on hypertext applications. HTML is a fairly simple language that enables the description of pages (generally Internet pages) that include links to other pages and other data types (such as graphics). When applied to a larger world, HTML has many shortcomings, including localization (q.v.) and formatting issues. The HTML *form* concept is of particular interest to this application.

### **HTTP**

Hypertext transfer protocol. HTTP functions as request-response protocol in the client-server computing rule.

### **IA-32**

See [Intel® Architecture-32 \(IA-32\)](#).

## IFR

Internal Form Representation. Used to represent forms in EFI so that it can be interpreted as is or expanded easily into XHTML.

## Image Handle

A handle for a loaded image; image handles support the loaded image protocol.

## Image Handoff State

The information handed off to a loaded image as it begins execution; it consists of the image's handle and a pointer to the image's system table.

## Image Header

The initial set of bytes in a loaded image. They define the image's encoding.

## Image Services

The set of functions used to manage EFI images. Includes [EFI\\_BOOT\\_SERVICES.LoadImage\(\)](#), [EFI\\_BOOT\\_SERVICES.StartImage\(\)](#), [EFI\\_BOOT\\_SERVICES.UnloadImage\(\)](#), [EFI\\_BOOT\\_SERVICES.Exit\(\)](#), [EFI\\_BOOT\\_SERVICES.ExitBootServices\(\)](#), and [EFI\\_IMAGE\\_ENTRY\\_POINT](#).

## Image

(1) An executable file stored in a file system that complies with this specification. Images may be drivers, applications or OS loaders. Also called an EFI Image.

(2) Executable binary file containing [EBC](#) and data. Output by the EBC linker.

## IME

Input Method Editor. A program or subprogram that is used to map keystrokes to logographic characters. For example, IMEs are used (possibly with user intervention) to map the Kana (Hirigana or Katakana) characters on Japanese keyboards to Kanji.

## Intel® Architecture-32 (IA-32)

The 32-bit and 16-bit architecture described in the *Intel Architecture Software Developer's Manual*. IA-32 is the architecture of the Intel® P6 family of processors, which includes the Intel® Pentium® Pro, Pentium II, Pentium III, and Pentium 4 processors.

## Intel® Itanium® Architecture

The Intel architecture that has 64-bit instruction capabilities, new performance-enhancing features, and support for the IA-32 instruction set. This architecture is described in the *Itanium™ Architecture Software Developer's Manual*.

## internationalization

In this context, is the process of making a system usable across languages and cultures by using universally understood symbols. Internationalization is



difficult due to the differences in cultures and the difficulty of creating obvious symbols; for example, why does a red octagon mean "Stop"?

### **Interpreter**

The software implementation that decodes [EBC](#) binary instructions and executes them on a VM. Also called EBC interpreter.

### **Keyboard layout**

The physical representation of a user's keyboard. The usage of this is in conjunction to a structure that equates the physical key(s) and the associated action it represents. For instance, key C1 is equated to the letter *a* and its Unicode value in the typical U.K. keyboard is a non-shifted value of 0x0061.

### **LAN On Motherboard (LOM)**

This is a network device that is built onto the motherboard (or baseboard) of the machine.

### **LBA:**

See Logical Block Address (LBA).

### **Legacy Platform**

A platform which, in the interests of providing backward-compatibility, retains obsolete technology.

### **LFN**

See [Long File Names \(LFN\)](#).

### **Little Endian**

A memory architecture in which the low-order byte of a multibyte datum is at the lowest address, while the high-order byte is at the highest address. See [Big Endian](#).

### **Load File Protocol**

A protocol that is used during boot services to find and load other modules of code.

### **Loaded Image Protocol**

A protocol that is used during boot services to obtain information about a loaded image. Also called the EFI Loaded Image Protocol.

### **Loaded Image**

A file containing executable code. When started, a loaded image is given its image handle and can use it to obtain relevant image data.

### **Localization**

The process of focusing a system in so that it works using the symbols of a language/culture. To a major extent the following design is influenced by the requirements of localization.

### **Logical Block Address (LBA):**

The address of a logical block on a disk. The first LBA on a disk is LBA 0.

### **Logographic**

A character set that uses characters to represent words or parts of words rather than syllables or sounds. Kanji is logographic but Kana characters are not.

### **LOM**

See [LAN On Motherboard \(LOM\)](#).

### **Long File Names (LFN)**

Refers to an extension to the [FAT File System](#) that allows file names to be longer than the original standard (eight characters plus a three-character extension).

### **Machine Check Abort (MCA)**

The system management and error correction facilities built into the Intel Itanium processors.

### **Master Boot Record (MBR)**

The data structure that resides on the LBA 0 of a hard disk and defines the partitions on the disk.

### **MBR**

See [Master Boot Record \(MBR\)](#).

### **MBR boot code:**

x86 code in the first LBA of a disk.

### **MBR disk layout:**

The data layout on a disk consisting of an MBR in LBA 0 and partitions described by the MBR in the remaining LBAs. See chapter 5 and Appendix NEW.

### **MBR Partition Record**

A data structure that characterizes a Partition in the MBR disk layout.

### **MCA**

See [Machine Check Abort \(MCA\)](#).

## Media Device Path

A Device Path that is used to describe the portion of a medium that is being abstracted by a boot service. For example, a Media Device Path could define which partition on a hard drive was being used.

## Memory Allocation Services

The set of functions used to allocate and free memory, and to retrieve the memory map. Includes [EFI\\_BOOT\\_SERVICES.AllocatePages\(\)](#), [EFI\\_BOOT\\_SERVICES.FreePages\(\)](#), [EFI\\_BOOT\\_SERVICES.AllocatePool\(\)](#), [EFI\\_BOOT\\_SERVICES.FreePool\(\)](#), and [EFI\\_BOOT\\_SERVICES.GetMemoryMap\(\)](#).

## Memory Map

A collection of structures that defines the layout and allocation of system memory during the boot process. Drivers and applications that run during the boot process prior to OS control may require memory. The boot services implementation is required to ensure that an appropriate representation of available and allocated memory is communicated to the OS as part of the hand-off of control.

## Memory Type

One of the memory types defined by UEFI for use by the firmware and UEFI applications. Among others, there are types for boot services code, boot services data, [Runtime Services](#) code, and runtime services data. Some of the types are used for one purpose before [EFI\\_BOOT\\_SERVICES.ExitBootServices\(\)](#) is called and another purpose after.

## Messaging Device Path

A Device Path that is used to describe the connection of devices outside the [Coherency Domain](#) of the system. This type of node can describe physical messaging information (e.g., a SCSI ID) or abstract information (e.g., networking protocol IP addresses).

## Miscellaneous Service

Various functions that are needed to support the [EFI](#) environment. Includes [EFI\\_BOOT\\_SERVICES.InstallConfigurationTable\(\)](#), [ResetSystem\(\)](#), [EFI\\_BOOT\\_SERVICES.Stall\(\)](#), [EFI\\_BOOT\\_SERVICES.SetWatchdogTimer\(\)](#), [EFI\\_BOOT\\_SERVICES.GetNextMonotonicCount\(\)](#), and [GetNextHighMonotonicCount\(\)](#).

## MTFTP

See [Multicast Trivial File Transfer Protocol \(MTFTP\)](#).

## Multicast Trivial File Transfer Protocol (MTFTP)

A **protocol** used to download a [Network Boot Program](#) to many clients simultaneously from a [TFTP](#) server.

### Name Space or Namespace

A namespace defines a contiguously-addressed range of Non-Volatile Memory conceptually similar to a SCSI Logical Unit (LUN) or a NVM Express namespace.

In general, a collection of device paths; in an EFI Device Path.

### Native Code

Low level instructions that are native to the host processor. As such, the processor executes them directly with no overhead of interpretation. Contrast this with [EBC](#), which must be interpreted by native code to operate on a [VM](#).

### NBP

See [Network Bootstrap Program \(NBP\)](#) or [Network Boot Program](#).

### Network Boot Program

A remote boot image downloaded by a [PXE](#) client using the [Trivial File Transport Protocol \(TFTP\)](#) or the [Multicast Trivial File Transfer Protocol \(MTFTP\)](#). See [Network Bootstrap Program \(NBP\)](#).

### Network Bootstrap Program (NBP)

This is the first program that is downloaded into a machine that has selected a PXE capable device for remote boot services.

A typical NBP examines the machine it is running on to try to determine if the machine is capable of running the next layer (OS or application). If the machine is not capable of running the next layer, control is returned to the [EFI](#) boot manager and the next boot device is selected. If the machine is capable, the next layer is downloaded and control can then be passed to the downloaded program.

Though most NBPs are OS loaders, NBPs can be written to be standalone applications such as diagnostics, backup/restore, remote management agents, browsers, etc.

### Network Interface Card (NIC)

Technically, this is a network device that is inserted into a bus on the motherboard or in an expansion board. For the purposes of this document, the term NIC will be used in a generic sense, meaning any device that enables a network connection (including [LOMs](#) and network devices on external buses (USB, 1394, etc.)).

### NIC

See [Network Interface Card \(NIC\)](#).

**Non-spacing key**

Typically an accent key that does not advance the cursor and is used to create special characters similar to ÄËÊ. This function is provided only on certain keyboard layouts.

**NV**

Nonvolatile.

**Package**

III information with a unique type, such as strings, fonts, images or forms.

**Package List**

Group of packages identified by a GUID.

**Page Memory**

A set of contiguous pages. Page memory is allocated by [EFI\\_BOOT\\_SERVICES.AllocatePages\(\)](#) and returned by [EFI\\_BOOT\\_SERVICES.FreePages\(\)](#).

**Partition Discovery**

The process of scanning a block device to determine whether it contains a [Partition](#).

**Partition**

A contiguous set of LBAs on a disk, described by the MBR and/or GPT disk layouts.

**PC-AT**

Refers to a PC platform that uses the AT form factor for their motherboards.

**PCI Bus Driver**

Software that creates a handle for every [PCI Controller](#) on a [PCI Host Bus Controller](#) and installs both the [PCI I/O Protocol](#) and the [Device Path Protocol](#) onto that handle. It may optionally perform [PCI Enumeration](#) if resources have not already been allocated to all the PCI Controllers on a PCI Host Bus Controller. It also loads and starts any UEFI drivers found in any PCI Option ROMs discovered during PCI Enumeration. If a driver is found in a [PCI Option ROM](#), the [PCI Bus Driver](#) will also attach the Bus Specific Driver Override Protocol to the handle for the PCI Controller that is associated with the PCI Option ROM that the driver was loaded from.

**PCI Bus**

A collection of up to 32 physical [PCI Devices](#) that share the same physical PCI bus. All devices on a PCI Bus share the same [PCI Configuration Space](#).

**PCI Configuration Space**

The configuration channel defined by PCI to configure [PCI Devices](#) into the resource domain of the system. Each PCI device must produce a standard set of registers in the form of a PCI Configuration Header, and can optionally

produce device specific registers. The registers are addressed via Type 0 or Type 1 PCI Configuration Cycles as described by the *PCI Specification*. The PCI Configuration Space can be shared across multiple [PCI Buses](#). On most [PC-AT](#) architecture systems and typical Intel® chipsets, the PCI Configuration Space is accessed via I/O ports 0xCF8 and 0xCFC. Many other implementations are possible.

### PCI Controller

A hardware components that is discovered by a [PCI Bus Driver](#), and is managed by a [PCI Device Driver](#). [PCI Functions](#) and [PCI Controller](#) are used equivalently in this document.

### PCI Device Driver

Software that manages one or more PCI Controllers of a specific type. A driver will use the [PCI I/O Protocol](#) to produce a device I/O abstraction in the form of another protocol (i.e., Block I/O, Simple Network, Simple Input, Simple Text Output, Serial I/O, Load File).

### PCI Devices

A collection of up to 8 [PCI Functions](#) that share the same [PCI Configuration Space](#). A PCI Device is physically connected to a [PCI Buses](#).

### PCI Enumeration

The process of assigning resources to all the PCI Controllers on a given [PCI Host Bus Controller](#). This includes PCI Bus Number assignments, PCI Interrupt assignments, PCI I/O resource allocation, the PCI Memory resource allocation, the PCI Prefetchable Memory resource allocation, and miscellaneous PCI DMA settings.

### PCI Functions

A controller that provides some type of I/O services. It consumes some combination of PCI I/O, PCI Memory, and PCI Prefetchable Memory regions, and up to 256 bytes of the [PCI Configuration Space](#). The PCI Function is the basic unit of configuration for PCI.

### PCI Host Bus Controller

A chipset component that produces PCI I/O, PCI Memory, and PCI Prefetchable Memory regions in a single Coherency Domain. A PCI Host Bus Controller is composed of one or more [PCI Root Bridges](#).

### PCI I/O Protocol

A software interface that provides access to PCI Memory, PCI I/O, and PCI Configuration spaces for a PCI Controller. It also provides an abstraction for PCI Bus Master DMA.

### PCI Option ROM

A ROM device that is accessed through a PCI Controller, and is described in the PCI Controller's Configuration Header. It may contain one or more [PCI Device Drivers](#) that are used to manage the PCI Controller.

## PCI Root Bridge I/O Protocol

A software abstraction that provides access to the PCI I/O, PCI Memory, and PCI Prefetchable Memory regions in a single Coherency Domain.

## PCI Root Bridge

A chipset component(s) that produces a physical PCI Local Bus.

## PCI Segment

A collection of up to 256 [PCI Buses](#) that share the same [PCI Configuration Space](#). PCI Segment is defined in the ACPI Specification as the `_SEG` object. The `SAL_PCI_CONFIG_READ` and `SAL_PCI_CONFIG_WRITE` procedures defined in chapter 9 of the *SAL Specification* define how to access the PCI Configuration Space in a system that supports multiple PCI Segments. If a system only supports a single PCI Segment the PCI Segment number is defined to be zero. The existence of PCI Segments enables the construction of systems with greater than 256 PCI buses.

## Pool Memory

A set of contiguous bytes. A pool begins on, but need not end on, an “8-byte” boundary. Pool memory is allocated in pages—that is, firmware allocates enough contiguous pages to contain the number of bytes specified in the allocation request. Hence, a pool can be contained within a single page or extend across multiple pages. Pool memory is allocated by [EFI\\_BOOT\\_SERVICES.AllocatePool\(\)](#) and returned by [EFI\\_BOOT\\_SERVICES.FreePool\(\)](#).

## Preboot Execution Environment (PXE)

A means by which agents can be loaded remotely onto systems to perform management tasks in the absence of a running OS. To enable the interoperability of clients and downloaded bootstrap programs, the client preboot code must provide a set of services for use by a downloaded bootstrap. It also must ensure certain aspects of the client state at the point in time when the bootstrap begins executing.

The complete PXE specification covers three areas; the client, the network and the server.

### Client

- Makes network devices into bootable devices.
- Provides APIs for PXE protocol modules in **EFI** and for universal drivers in the OS.

### Network

- Uses existing technology: [DHCP](#), [TFTP](#), etc.
- Adds “vendor-specific” tags to DHCP to define PXE-specific operation within DHCP.
- Adds multicast TFTP for high bandwidth remote boot applications.

- Defines Bootserver discovery based on DHCP packet format.

### Server

- **Bootserver:** Responds to Bootserver discovery requests and serves up remote boot images.
- **proxyDHCP:** Used to ease the transition of PXE clients and servers into existing network infrastructure. proxyDHCP provides the additional [DHCP](#) information that is needed by PXE clients and Bootservers without making changes to existing DHCP servers.
- **MTFTP:** Adds multicast support to a [TFTP](#) server.
- **Plug-In Modules:** Example proxyDHCP and Bootservers provided in the [PXE](#) SDK (software development kit) have the ability to take plug-in modules (PIMs). These PIMs are used to change/enhance the capabilities of the proxyDHCP and Bootservers.

### Protocol Handler Services

The set of functions used to manipulate handles, protocols, and protocol interfaces. Includes [EFI\\_BOOT\\_SERVICES.InstallProtocolInterface\(\)](#), [EFI\\_BOOT\\_SERVICES.UninstallProtocolInterface\(\)](#), [EFI\\_BOOT\\_SERVICES.ReinstallProtocolInterface\(\)](#), [EFI\\_BOOT\\_SERVICES.HandleProtocol\(\)](#), [EFI\\_BOOT\\_SERVICES.RegisterProtocolNotify\(\)](#), [EFI\\_BOOT\\_SERVICES.LocateHandle\(\)](#), and [EFI\\_BOOT\\_SERVICES.LocateDevicePath\(\)](#).

### Protocol Handler

A function that responds to a call to a [HandleProtocol](#) request for a given handle. A protocol handler returns a protocol interface structure.

### Protocol Interface Structure

The set of data definitions and functions used to access a particular type of device. For example, BLOCK\_IO is a protocol that encompasses interfaces to read and write blocks from mass storage devices. See [Protocol](#).

### Protocol Revision Number

The revision number associated with a protocol. See [Protocol](#).

### Protocol

The information that defines how to access a certain type of device during boot services. A protocol consists of a [Globally Unique Identifier \(GUID\)](#), a protocol revision number, and a protocol interface structure. The interface structure contains data definitions and a set of functions for accessing the device. A device can have multiple protocols. Each protocol is accessible through the device's handle.

### PXE Base Code Protocol

A protocol that is used to control PXE-compatible devices. It may be used by the firmware's boot manager to support booting from remote locations. Also called the EFI PXE Base Code Protocol.



## PXE

See [Preboot Execution Environment \(PXE\)](#).

## Question

IFR which describes how a single configuration setting should be presented, stored, and validated.

## Read-Only Memory (ROM)

When used with reference to the [UNDI](#) specification, ROM refers to a nonvolatile memory storage device on a [NIC](#).

## Reset

The action which forces question values to be reset to their defaults.

## ROM

See [Question](#).

## Runtime Services Table

A table that contains the firmware entry points for accessing runtime services functions such as [Time Services](#) and [Virtual Memory Services](#). The table is accessed through a pointer in the [System Table](#).

## Runtime Services

Interfaces that provide access to underlying platform specific hardware that may be useful during OS runtime, such as timers. These services are available during the boot process but also persist after the OS loader terminates boot services.

## SAL

See [System Abstraction Layer \(SAL\)](#).

## scan code

A value representing the *location* of a key on a keyboard. Scan codes may also encode make (key press) and break (key release) and auto-repeat information.

## Serial Protocol

A Protocol that is used during boot services to abstract byte stream devices—that is, to communicate with character-based I/O devices.

## SGML

Standard Generalized Markup Language. A markup language for defining markup languages.

## shifted Unicode

Shifted Unicode represents the Unicode character code of a key when the shift modifier key is held down. For instance, key C1 is equated to the letter *a* and its Unicode character code in the typical U.K. keyboard is a non-shifted value of 0x0061. When the shift key is held down in conjunction with the

pressing of key C1, however, the value on the same keyboard often produces an *A*, which is a the Unicode character code 0x0041.

A [Protocol](#) that is used during boot services to abstract byte stream devices—that is, to communicate with character-based I/O devices.

### Simple File System Protocol

A component of the [File System Protocol](#). It provides a minimal interface for file-type access to a device.

### Simple Input Protocol

A **protocol** that is used to obtain input from the ConsoleIn device. It is one of two protocols that make up the [Console I/O Protocol](#).

### Simple Network Protocol

A protocol that is used to provide a packet-level interface to a network adapter. Also called the EFI Simple Network Protocol.

### Simple Text Output Protocol

A protocol that is used to control text-based output devices. It is one of two protocols that make up the [Console I/O Protocol](#).

### SKU

Stock keeping unit. An acronym commonly used to reference a “version” of a particular platform. An example might be “We have three different SKUs of this platform.”

### SMBIOS

See [System Management BIOS \(SMBIOS\)](#).

### SNIA

Storage Network Industry Association.(www.snia.org)

### SNIA Common RAID Disk Data Format

*Storage Network Industry Association Common RAID Disk Data Format Specification*, Revision 1.2, July 28, 2006. (www.snia.org)

### SSL

Secure Sockets Layer. A security protocol that provides communications privacy over the Internet. It is predecessor to TLS.

### StandardError

The device handle that corresponds to the device used to display error messages to the user from the boot services environment.

### Status Codes

Success, error, and warning codes returned by boot services and runtime services functions.

## string

A null-terminated array of 16-bit UCS-2 encoded Unicode characters. All strings in this specification are encoded using UCS-2 unless otherwise specified.

## Submit

The action which forces modified question values to be written back to storage.

## System Abstraction Layer (SAL)

Firmware that abstracts platform implementation differences, and provides the basic platform software interface to all higher level software.

## System Management BIOS (SMBIOS)

A table-based interface that is required by the *Wired for Management Baseline Specification*. It is used to relate platform-specific management information to the OS or to an OS-based management agent.

## System Table

Table that contains the standard input and output handles for a UEFI application, as well as pointers to the boot services and runtime services tables. It may also contain pointers to other standard tables such as the [ACPI](#), [SMBIOS](#), and [SAL](#) System tables. A loaded image receives a pointer to its system table when it begins execution. Also called the EFI System Table.

## Target

The system being configured.

## Task Priority Level (TPL)

The boot services environment exposes three task priority levels: "normal," "callback," and "notify."

## Task Priority Services

The set of functions used to manipulate task priority levels. Includes [EFI\\_BOOT\\_SERVICES.RaiseTPL\(\)](#) and [EFI\\_BOOT\\_SERVICES.RestoreTPL\(\)](#).

## TFTP

See [Trivial File Transport Protocol \(TFTP\)](#).

## Time Format

The format for expressing time in an [EFI-compliant](#) platform. For more information, see Appendix A.

## Time Services

The set of functions used to manage time. Includes [GetTime\(\)](#), [SetTime\(\)](#), [GetWakeupTime\(\)](#), and [SetWakeupTime\(\)](#).

### Timer Services

The set of functions used to manipulate timers. Contains a single function, [EFI\\_BOOT\\_SERVICES.SetTimer\(\)](#).

### TLS

Transport Layer Security. A protocol to provide privacy and data integrity between two communicating applications above TCP.

### TPL

See [Target](#).

### Trivial File Transport Protocol (TFTP)

A protocol used to download a [Network Boot Program](#) from a TFTP server.

### UEFI

Unified Extensible Firmware Interface. The interface between the operating system (OS) and the platform firmware defined by this specification.

### UEFI Application

Modular code that may be loaded in the boot services environment to accomplish platform specific tasks within that environment. Examples of possible applications might include diagnostics or disaster recovery tools shipped with a platform that run outside the OS environment. UEFI applications may be loaded in accordance with policy implemented by the platform firmware to accomplish a specific task. Control is then returned from the UEFI application to the platform firmware.

### UEFI Boot Service Driver

A UEFI driver that is loaded into boot services memory and stays resident until boot services terminate.

### UEFI Driver

A module of code typically inserted into the firmware via protocol interfaces. Drivers may provide device support during the boot process or they may provide platform services. It is important not to confuse UEFI drivers with OS drivers that load to provide device support once the OS takes control of the platform.

### UEFI OS Loader

A UEFI application that is the first piece of operating system code loaded by the firmware to initiate the OS boot process. This code is loaded at a fixed address and then executed. The OS takes control of the system prior to completing the OS boot process by calling the interface that terminates all boot services.

### UEFI Runtime Services Driver

A UEFI driver that is loaded into runtime services memory and stays resident during runtime.

## UNDI

See [Universal Network Device Interface \(UNDI\)](#).

## Unicode Collation Protocol

A protocol that is used during boot services to perform case-insensitive comparisons of strings.

## Unicode

An industry standard internationalized character set used for human readable message display.

## Universal Network Device Interface (UNDI)

UNDI is an architectural interface to [NICs](#). Traditionally NICs have had custom interfaces and custom drivers (each NIC had a driver for each OS on each platform architecture). Two variations of UNDI are defined in this specification: H/W UNDI and S/W UNDI. H/W UNDI is an architectural hardware interface to a NIC. S/W UNDI is a software implementation of the H/W UNDI.

## Universal Serial Bus (USB)

A bi-directional, isochronous, dynamically attachable serial interface for adding peripheral devices such as serial ports, parallel ports, and input devices on a single bus.

## URI

Uniform resource identifier. URI is a string of characters used to identify a name of a resource.

## USB Bus Driver

Software that enumerates and creates a handle for each newly attached USB Controller and installs both the [USB I/O Protocol](#) and the Device Path Protocol onto that handle, starts that device driver if applicable. For each newly detached USB Controller, the device driver is stopped, the USB I/O Protocol and the Device Path Protocol are uninstalled from the device handle, and the device handle is destroyed.

## USB Bus

A collection of up to 127 physical [USB Devices](#) that share the same physical USB bus. All devices on a USB Bus share the bandwidth of the USB Bus.

## USB Controller

A hardware component that is discovered by a [USB Bus Driver](#), and is managed by a [USB Device Driver](#). [USB Interface](#) and [USB Controller](#) are used equivalently in this document.

## USB Device Driver

Software that manages one or more [USB Controller](#) of a specific type. A driver will use the [USB I/O Protocol](#) to produce a device I/O abstraction in

the form of another protocol (i.e., Block I/O, Simple Network, Simple Input, Simple Text Output, Serial I/O, Load File).

### USB Device

A USB peripheral that is physically attached to the [USB Bus](#).

### USB Enumeration

A periodical process to search the [USB Bus](#) to detect if there have been any [USB Controller](#) attached or detached. If an attach event is detected, then the USB Controller's device address is assigned, and a child handle is created. If a detach event is detected, then the child handle is destroyed.

### USB Host Controller

Moves data between system memory and devices on the [USB Bus](#) by processing data structures and generating the USB transactions. For USB 1.1, there are currently two types of USB Host Controllers: UHCI and OHCI.

### USB Hub

A special [USB Device](#) through which more USB devices can be attached to the [USB Bus](#).

### USB I/O Protocol

A software interface that provides services to manage a [USB Controller](#), and services to move data between a USB Controller and system memory.

### USB Interface

The USB Interface is the basic unit of a physical [USB Device](#).

### USB

See [Universal Serial Bus \(USB\)](#).

### Variable Services

The set of functions used to manage variables. Includes [GetVariable\(\)](#), [SetVariable\(\)](#), and [GetNextVariableName\(\)](#).

### Virtual Memory Services

The set of functions used to manage virtual memory. Includes [SetVirtualAddressMap\(\)](#) and [ConvertPointer\(\)](#).

### VM

The Virtual Machine, a pseudo processor implementation consisting of registers which are manipulated by the interpreter when executing [EBC](#) instructions.

### Watchdog Time

An alarm timer that may be set to go off. This can be used to regain control in cases where a code path in the boot services environment fails to or is unable to return control by the expected path.

## WfM

See [Wired for Management \(WfM\)](#).

## Wired for Management (WfM)

Refers to the *Wired for Management Baseline Specification*. The Specification defines a baseline for system manageability issues; its intent is to help lower the cost of computer ownership.

## x64

Processors that are compatible with instruction sets and operation modes as exemplified by the AMD64 or Intel® Extended Memory 64 Technology (Intel® EM64T) architecture.

## XHTML

Extensible HTML. XHTML "will obey all of the grammar rules of XML (properly nested elements, quoted attributes, and so on), while conforming to the vocabulary of HTML (the elements and attributes that are available for use and their relationships to one another)." [[PXML, pg. 153](#)]. Although not completely defined, XHTML is basically the intersection of XML and HTML and *does* support forms.

## XML

Extensible Markup Language. A subset of SGML. Addresses many of the problems with HTML but does not currently (1.0) support forms in any specified way.





# Index

---

## Symbols

!PXE structure field definitions 2553

!PXE structures 2552

## Numerics

32/64-bit UNDI interface 2551

## A

ACPI 2763

ACPI \_ADR 383

ACPI \_ADR Device Path 339

ACPI Device Path, definition of 2765

ACPI name space 2533, 2538

ACPI Source Language 331

ACPI Terms 2538

ACPI, definition of 2765

ADD 1107

\_ADR, definition of 2765

Advanced Configuration and Power Interface specification 2763

Advanced Configuration and Power Interface specification See also related information

AllocateBuffer() 801, 850

AllocatePages() 184

AllocatePool() 193

alphabetic function lists 2687

AND 1108

ANSI 3.64 terminals, and SIMPLE\_TEXT\_OUTPUT 2531

Application, EFI 21, 22

ARP cache entries 1241

ARP Protocol

    Functions

        Add() 1740

        Configure() 1738

        Delete() 1744

        Find() 1742

        Flush() 1745

        Request() 1746, 1748

    GUID 1736

    Interface Structure 1736

ARP Service Binding Protocol

- GUID 1735
- Arp() 1266
- Arrow shapes 530
- ASHR 1109
- ASL See ACPI Source Language
- AsyncInterruptTransfer() 940
- AsyncIsochronousTransfer() 949
- Attribute bits, EFI PCI I/O Protocol 828
- Attribute bits, PCI Root Bridge I/O 780
- attributes
  - architecturally defined 92
- Attributes, SIMPLE\_TEXT\_OUTPUT 536
- Attributes() 855

## **B**

- Base Code (BC), definition of 2766
- Big Endian, definition of 2766
- BIOS code 10
- BIOS Parameter Block 593
- BIOS Parameter Block (BPB), definition of 2766
- BIOS, definition of 2766
- BIS\_ALG\_ID 1298
- BIS\_APPLICATION\_HANDLE 1287
- BIS\_CERT\_ID 1297
- Block Elements Code Chart 530
- Block I/O Protocol 655, 665
  - Functions
    - FlushBlocks() 665, 672
    - Readblocks() 661, 668
    - Reset() 660, 667
    - WriteBlocks() 663, 670
  - GUID 656, 666
  - Interface Structure 656, 666
  - Revision Number 656
- Block Size, definition of 2766
- Blt buffer 567
- Blt Operation Table 578, 583
- Blt() 576
- Boot Device, definition of 2766
- Boot Integrity Services Protocol 1283
  - Functions
    - Free() 1291
    - GetBootObjectAuthorizationCertificate() 1292

- GetBootObjectAuthorizationCheckFlag() 1293
- GetBootObjectAuthorizationUpdateToken() 1294
- GetSignatureInfo() 1295
- Initialize() 1286
- Shutdown() 1290
- UpdateBootObjectAuthorizationUpdateBootObjectAuthorization\_EFI\_BIS() 1300
- VerifyBootObject() 1308
- VerifyObjectWithCredential() 1316
- GUID 1283
- Interface Structure 1283
- boot manager 79
  - default media boot 81
- Boot Manager, definition of 2766
- boot mechanisms 100
- boot order list 79
- boot process
  - illustration of 19
  - overview 19
- boot sequence 79
- Boot Services 157, 267
  - global functions 157, 267
  - handle-based functions 157, 267
- boot services 11
- Boot Services Driver, definition of 2786
- Boot Services Table, definition of 2767
- Boot Services Table, EFI 103
- Boot Services Time, definition of 2767
- Boot Services, definition of 2767
- booting
  - future boot media 102
  - via a network device 102
  - via Load File Protocol 101
  - via Simple File Protocol 100
- booting from
  - CD-ROM and DVD-ROM 598
  - diskettes 597
  - hard drives 597
  - network devices 598
  - removable media 597
- BPB See BIOS Parameter Block
- BREAK 1110
- BulkTransfer() 937
- bus-specific driver override protocol 448

## C

- CalculateCrc32() 265
- CALL 1112
- Callback() 1281
- calling conventions 30
  - general 24
  - IA-32 27
- CDB 2557
- CheckEvent() 175
- \_CID 337
- ClearRootHubPortFeature () 958
- ClearScreen() 538
- Close() 607
- CloseEvent() 171
- CloseEventExCreateEventEx 167
- CloseProtocol() 221
- Cluster, definition of 2767
- CMP 1115
- CMPI 1117
- COFF, definition of 2767
- Coherency Domain, definition of 2768
- Common Information Model (CIM), definition of 2768
- compressed data
  - bit order 1058
  - block body 1062
  - block header 1060
  - format 1058, 1060
  - overall structure 1059
- Compression Algorithm Specification 1057
- compression source code 2639
- compressor design 1063
- Configuration() 809
- ConnectController() 226
- Console 2529
- Console I/O protocol 509
- ConsoleIn 509
- ConsoleIn, definition of 2768
- ConsoleOut 523
- ConsoleOut, definition of 2768
- ControlTransfer() 934
- conventions 15
  - data structure descriptions 15
  - function descriptions 15

- instruction descriptions 16
- procedure descriptions 15
- protocol descriptions 15
- pseudo-code conventions 16
- ConvertPointer() 305
- CopyMem() 260, 796, 844
- CreateEvent() 163
- CreateEventEx 158, 167, 172
- CreateThunk() 1158
- \_CRS, definition of 2765
- cursor movement 2633

## D

- Debug Image Info Table 1054
- Debug Support Protocol 1026
  - Functions
    - GetMaximumProcessorIndex() 1029
    - InvalidateInstructionCache() 1045
    - RegisterExceptionCallback() 1039
    - RegisterPeriodicCallback() 1030
  - GUID 1026
  - Interface Structure 1026
- Debugport device path 1051
- Debugport Protocol 1046
  - Functions
    - Poll() 1051
    - Read() 1050
    - Reset() 1048
    - Write() 1049
  - GUID 1046
  - Interface Structure 1047
- Decompress Protocol 1070
  - Functions
    - Decompress() 1074
    - GetInfo() 1072
  - GUID 1070
  - Interface Structure 1070
- Decompress() 1074
- decompression source code 2667
- decompressor design 1069
- Defined GUID Partition Entry
  - Attributes 139
  - Partition Type GUIDs 138

- Delete() 608
- design overview 11
- Desktop Management Interface (DMI), definition of 2768
- Desktop Management Task Force (DMTF), definition of 2768
- Device Handle, definition of 2768
- Device Path
  - for IDE disk 2535
  - for legacy floppy 2534
  - for secondary root PCI bus with PCI to PCI bridge 2536
- Device Path Generation, Rules 381
  - Hardware vs. Messaging Device Paths 383
  - Housekeeping 381
  - Media Device Path 383
  - Other 384
    - with ACPI \_ADR 383
    - with ACPI \_HID and \_UID 382
- Device Path Instance, definition of 2769
- Device Path Node, definition of 2769
- Device Path Protocol 331
  - GUID 332
  - Interface Structure 332
- device path protocol 332
- Device Path, ACPI 336
- Device Path, BIOS Boot Specification 384
- Device Path, definition of 2769
- Device Path, hardware
  - memory-mapped 335
  - PCCARD 335
  - PCI 334
  - vendor 335, 336
- Device Path, media 375
  - Boot Specification 380
  - CD-ROM Media 376
  - File Path Media 377
  - hard drive 375
  - Media Protocol 378
  - Vendor-Defined Media 377
- Device Path, messaging 339
  - 1394 342
  - ATAPI 340
  - FibreChannel 340
  - I2O 348
  - InfiniBand 352

- IPv4 348
- IPv6 350
- MAC Address 348
- SCSI 340
- UART 352
- UART flow control 354
- USB 343
- USB class 348
- Vendor-Defined 353
- Device Path, nodes
  - ACPI Device Path 332
  - BIOS Boot Specification Device Path 333
  - End of Hardware Device Path 333
  - End This Instance of a Device Path 333
  - generic 333
  - Hardware Device Path 332
  - Media Device Path 333
  - Messaging Device Path 332
- Device Path,overview 331
- device paths
  - EFI simple pointer 545
  - PS/2 mouse 546
  - serial mouse 548
  - USB mouse 549
- DHCP packet 1239
- Dhcp() 1248
- DHCP4 Option Data
  - Interface Structure 1762
- DHCP4 Packet Data
  - Interface Structure 1755, 1782
- DisconnectController() 231
- Discover() 1250
- Disk I/O Protocol 643
  - Functions
    - ReadDisk() 388, 389, 390, 391, 392, 413, 414, 416, 417, 633, 635, 637, 638, 640, 641, 645, 921, 922, 1377, 1378, 2411, 2412, 2420, 2421, 2423, 2424, 2425
    - WriteDisk() 646, 1368, 1369, 1373, 1375, 1376, 1379, 1382, 1383
  - GUID 384, 412, 415, 631, 644, 920, 1367, 1371, 1967, 2410, 2417
  - Interface Structure 385, 412, 415, 631, 644, 920, 1367, 1371, 1967, 2410, 2417, 2469
  - Revision Number 644
- DIV 1119
- DIVU 1120
- document

- attributes 8
- audience 10
- goals 8
- purpose 1
- driver binding protocol 419
- driver diagnostics protocol 451
- Driver Model Boot Services 197
- Driver Signing 1973
- DriverLoaded() 447
- Dynamic Host Configuration Protocol (DHCP), definition of 2770

## **E**

EBC Image, definition of 2770

EBC Instruction

- ADD 1107
- AND 1108
- ASHR 1109
- BREAK 1110
- CALL 1112
- CMP 1115
- CMPI 1117
- DIV 1119
- DIVU 1120
- EXTNDB 1121
- EXTNDD 1122
- EXTNDW 1123
- JMP 1124
- JMP8 1127
- LOADSP 1128
- MOD 1129
- MODU 1130
- MOV 1131
- MOVI 1133
- MOVIn 1135
- MOVn 1136
- MOVREL 1137
- MOVsn 1138
- MUL 1140
- MULU 1141
- NEG 1142
- NOT 1143
- OR 1144
- POP 1145



- POPn 1146
- PUSH 1147
- PUSHn 1148
- RET 1149
- SHL 1150
- SHR 1151
- STORESP 1152
- SUB 1153
- XOR 1154
- EBC instruction descriptions 16
- EBC instruction encoding 1104
- EBC instruction operands 1102
  - direct operands 1102
  - immediate operands 1103
  - indirect operands 1103
  - indirect with index operands 1103
- EBC Instruction Set 1106
- EBC instruction set 1106
- EBC instruction syntax 1104
- EBC Interpreter Protocol 1157
  - Functions
    - CreateThunk() 1158
    - GetVersion() 1162
    - RegisterICacheFlush() 1160
    - UnloadImage() 1159
  - GUID 1157
  - Interface Structure 1157
- EBC Tools 1162
- EBC tools
  - C coding convention 1162
  - debug support 1167
  - EBC C compiler 1162
  - EBC interface assembly instructions 1163
  - EBC linker 1166
  - EBC to EBC arguments calling convention 1164
  - EBC to native arguments calling convention 1163
  - function return values 1164
  - function returns 1164
  - image loader 1167
  - native to EBC arguments calling convention 1163
  - stack maintenance and argument passing 1163
  - thunking 1164
  - VM exception handling 1167

- EBC virtual machine 1097
  - architectural requirements 1155
  - runtime and software conventions 1155
- EFI Application 21, 22, 593
- EFI Application, definition of 2786
- EFI Boot Manager 594
- EFI Boot Services Table 103
- EFI Bus-Specific Driver Override Protocol
  - functions
    - GetDriver() 450
- EFI Byte Code (EBC) 1097
- EFI Byte Code (EBC), definition of 2770
- EFI Byte Code Virtual Machine 2
- EFI Component Name Protocol 816
  - functions
    - GetControllerName() 459
    - GetDriverName() 457
- EFI Debug Support Protocol 1026
- EFI debug support table 1053
- EFI Debugport Protocol 1046
- EFI debugport variable 1052
- EFI DHCPv4 Protocol
  - Functions
    - Build() 1769
    - GetModeData() 1752, 1778
    - Parse() 1774, 1803
    - Release() 1767, 1798, 1800
    - RenewRebind() 1765, 1793, 1796
    - Start() 1756, 1763, 1784, 1791
    - Stop() 1768, 1802
    - TransmitReceive() 1771
  - GUID 1750, 1776
  - Interface Structure 1750, 1776
- EFI DHCPv4 Service Binding Protocol
  - GUID 1749, 1775
- EFI Directory Structure 594
- EFI Driver 593
- EFI Driver Binding Protocol
  - functions
    - Start() 428
    - Stop() 437
    - Supported() 422
- EFI Driver Configuration Protocol

- functions
  - OptionsValid() 475
  - SetOptions() 473
- EFI Driver Diagnostics Protocol 816
- EFI Driver Diagnostics Protocol
  - functions
    - RunDiagnostics() 453
- EFI Driver Model 1
- EFI driver model 12
- EFI Driver, definition of 2786
- EFI File, definition of 2770
- EFI Hard Disk, definition of 2770
- EFI Image 20, 593
- EFI Image handoff state 32
  - IA-32 29
- EFI Image Header 20
  - PE32+ image format 20
- EFI Image, definition of 2774
- EFI IPv4 Configuration Protocol
  - Functions
    - GetData() 1617
    - Start() 1614
    - Stop() 1616
  - GUID 1612
  - Interface Structure 1612
- EFI IPv4 Protocol
  - Functions
    - Cancel() 1610, 1658
    - GetModeData() 1386, 1388, 1391, 1393, 1404, 1409, 1412, 1416, 1433, 1435, 1437, 1444, 1447, 1591, 1633, 1719, 1725, 1726, 1728, 1731, 1733
    - Groups() 1598, 1644
    - Open() 1596, 1642
    - Receive() 1608, 1656
    - Route() 1600, 1646
    - Transmit() 1602, 1650
  - GUID 1590, 1631
  - Interface Structure 1336, 1385, 1387, 1392, 1431, 1445, 1460, 1478, 1498, 1510, 1590, 1631, 1717, 1729, 1805, 1822
- EFI IPv4 Service Binding Protocol
  - GUID 1385, 1387, 1392, 1431, 1445, 1459, 1460, 1478, 1498, 1509, 1510, 1589, 1630, 1717, 1729, 1804, 1805, 1820, 1822
- EFI MTFTP4 Protocol
  - Functions

- WriteFile() 1932
- EFI MTFTPv4 Protocol
  - Functions
    - Configure() 1913, 1941
    - GetInfo() 1915
    - GetModeData () 1910
    - ParseOptions() 1924
    - ReadDirectory() 1934
    - ReadFile() 1926
  - Interface Structure 1909
- EFI MTFTPv4 Service Binding Protocol
  - GUID 1908
- EFI OS Loader 21, 593
- EFI OS loader, definition of 2786
- EFI partitioning scheme 131
- EFI Platform Driver Override Protocol
  - functions
    - DriverLoaded() 447
    - GetDriver() 443
    - GetDriverPath() 445
- EFI Runtime Services Table 103
- EFI Scan Codes, SIMPLE\_INPUT\_INTERFACE 510
- EFI Service Binding Protocol
  - Functions
    - CreateChild() 462
    - DestroyChild() 467
  - GUID 461
  - Interface Structure 461
- EFI Specification 1
  - Design Overview 11
  - Goals 8
  - Target Audience 10
- EFI System Table 103
- EFI system table location 1054
- EFI Tables
  - EFI\_BOOT\_SERVICES 108
  - EFI\_CONFIGURATION\_TABLE 115
  - EFI\_RUNTIME\_SERVICES 112
  - EFI\_SYSTEM\_TABLE 106
  - EFI\_TABLE\_HEADER 105
- EFI tables
  - EFI\_IMAGE\_ENTRY\_POINT 103
- EFI time 2527

## EFI UDPv4 Protocol

## Functions

Cancel() 1561, 1888, 1906  
 GetModeData() 1538, 1543, 1872, 1875, 1892, 1895  
 Groups() 1877, 1897  
 Poll() 1562, 1889, 1907  
 Receive() 1557, 1886, 1904  
 Route() 1545, 1878  
 Transmit() 1550, 1552, 1880, 1898

GUID 1536, 1870, 1891

Interface Structure 1536, 1870, 1891

## EFI USB Host Controller Protocol

## functions

AsyncInterruptTransfer() 940  
 AsyncIsochronousTransfer () 949  
 BulkTransfer() 937  
 ClearRootHubPortFeature () 958  
 ControlTransfer() 934  
 GetRootHubPortNumber () 926  
 GetRootHubPortStatus () 952  
 GetState() 930  
 IsochronousTransfer() 946  
 Reset() 928  
 SetRootHubPortFeature () 956  
 SetState() 932  
 SyncInterruptTransfer() 943

EFI, definition of 2770

EFI\_ALLOCATE\_TYPE 185

EFI\_ARP\_CONFIG\_DATA 1738

EFI\_ARP\_FIND\_DATA 1743

EFI\_ARP\_PROTOCOL 1736

EFI\_ARP\_SERVICE\_BINDING\_PROTOCOL 1735

EFI\_AUTHENTICATION\_INFO\_PROTOCOL 1967

EFI\_BIS\_PROTOCOL 1283

EFI\_BIS\_SIGNATURE\_INFO 1295

EFI\_BIS\_VERSION 1287

EFI\_BLOCK\_IO\_MEDIA 657

EFI\_BOOT\_SERVICES table 108

EFI\_BUS\_SPECIFIC\_DRIVER\_OVERRIDE\_PROTOCOL 448

EFI-compliant, definition of 2770

EFI\_COMPONENT\_NAME2\_PROTOCOL 455

EFI\_CONFIGURATION\_TABLE 115

EFI\_DECOMPRESS\_PROTOCOL 1070

EFI\_DEVICE\_PATH 332  
EFI\_DEVICE\_PATH protocol 332  
EFI\_DEVICE\_PATH\_UTILITIES\_PROTOCOL 384, 385, 386, 387, 388, 389, 390, 391, 392, 393, 412, 413, 414, 415, 416, 417  
EFI\_DHCP4\_CALLBACK 1758, 1786, 1794  
EFI\_DHCP4\_CONFIG\_DATA 1757, 1779, 1785, 1789  
EFI\_DHCP4\_EVENT 1759  
EFI\_DHCP4\_HEADER 1761, 1783, 1787  
EFI\_DHCP4\_LISTEN\_POINT 1772  
EFI\_DHCP4\_MODE\_DATA 1752, 1778, 1779, 1780, 1782  
EFI\_DHCP4\_PACKET 1755, 1782  
EFI\_DHCP4\_PACKET\_OPTION 1762  
EFI\_DHCP4\_PROTOCOL 1749, 1750, 1751, 1752, 1753, 1754, 1756, 1758, 1763, 1765, 1766, 1767, 1768, 1769, 1771, 1772, 1774, 1775, 1776, 1784, 1786, 1791, 1793, 1794, 1796, 1802, 1803  
EFI\_DHCP4\_SERVICE\_BINDING\_PROTOCOL 461, 1749, 1775  
EFI\_DHCP4\_STATE 1753, 1781, 1788  
EFI\_DHCP4\_TRANSMIT\_RECEIVE\_TOKEN 1771  
EFI\_DRIVER\_BINDING\_PROTOCOL 419  
EFI\_DRIVER\_DIAGNOSTICS\_PROTOCOL 451  
EFI\_DRIVER\_DIAGNOSTIC\_TYPE 454  
EFI\_EBC\_PROTOCOL 1157  
EFI\_EDID\_ACTIVE\_PROTOCOL 580  
EFI\_EDID\_DISCOVERED\_PROTOCOL 579  
EFI\_EVENT 163  
EFI\_FILE\_INFO 627  
    GUID 628  
EFI\_FILE\_SYSTEM\_INFO 629  
    GUID 629  
EFI\_FILE\_SYSTEM\_VOLUME\_LABEL 630  
    GUID 630  
EFI\_GRAPHICS\_OUTPUT\_PROTOCOL\_SET\_MODE 575  
EFI\_GUID 201  
EFI\_HANDLE 201  
EFI\_HASH\_PROTOCOL 2410, 2411, 2412, 2414, 2416, 2417, 2420, 2421, 2423, 2424, 2425, 2428  
EFI\_IMAGE\_ENTRY\_POINT 103, 251  
EFI\_INPUT\_KEY 523  
EFI\_INTERFACE\_TYPE 201  
EFI\_IP4\_COMPLETION\_TOKEN 1602, 1650, 1651, 1652, 1653, 1654  
EFI\_IP4\_CONFIG\_DATA 1593, 1635  
EFI\_IP4\_CONFIG\_PROTOCOL 1539, 1545, 1593, 1596, 1600, 1612, 1614, 1616, 1617, 1874, 1878, 1894  
EFI\_IP4\_FRAGMENT\_DATA 1605

EFI\_IP4\_HEADER 1604  
EFI\_IP4\_ICMP\_TYPE 1595, 1638  
EFI\_IP4\_IPCONFIG\_DATA 1618  
EFI\_IP4\_MODE\_DATA 1592, 1634  
EFI\_IP4\_OVERRIDE\_DATA 1606  
EFI\_IP4\_PROTOCOL 1387, 1392, 1431, 1538, 1589, 1590, 1591, 1596, 1598, 1600, 1602, 1608, 1610, 1611, 1618, 1631, 1632, 1633, 1642, 1644, 1646, 1648, 1650, 1656, 1658, 1659, 1730, 1872  
EFI\_IP4\_RECEIVE\_DATA 1603  
EFI\_IP4\_ROUTE\_TABLE 1595, 1637  
EFI\_IP4\_SERVICE\_BINDING\_PROTOCOL 372, 461, 1385, 1386, 1392, 1431, 1445, 1459, 1477, 1498, 1509, 1589, 1630, 1716, 1717, 1729, 1804, 1805, 1820, 1821  
EFI\_IP4\_TRANSMIT\_DATA 1605  
EFI\_ISCSI\_INITIATOR\_NAME\_PROTOCOL 920  
EFI\_LBA 657  
EFI\_LOADED\_IMAGE Protocol 327  
EFI\_LOCATE\_SEARCH\_TYPE 209  
EFI\_MANAGED\_NETWORK\_COMPLETION\_TOKEN 1351  
EFI\_MANAGED\_NETWORK\_CONFIG\_DATA 1343  
EFI\_MANAGED\_NETWORK\_FRAGMENT\_DATA 1355  
EFI\_MANAGED\_NETWORK\_PROTOCOL 1340  
EFI\_MANAGED\_NETWORK\_RECEIVE\_DATA 1353  
EFI\_MANAGED\_NETWORK\_SERVICE\_BINDING\_PROTOCOL 1339  
EFI\_MANAGED\_NETWORK\_TRANSMIT\_DATA 1354  
EFI\_MEMORY\_DESCRIPTOR 189  
EFI\_MEMORY\_TYPE 185  
EFI\_MTFTP4\_ACK8\_HEADER 1918, 1946  
EFI\_MTFTP4\_ACK\_HEADER 1917, 1945  
EFI\_MTFTP4\_DATA8\_HEADER 1918, 1946  
EFI\_MTFTP4\_DATA\_HEADER 1917, 1945  
EFI\_MTFTP4\_ERROR\_HEADER 1918, 1946  
EFI\_MTFTP4\_OACK\_HEADER 1917, 1945  
EFI\_MTFTP4\_PACKET 1917, 1945  
EFI\_MTFTP4\_PROTOCOL 1908, 1909, 1910, 1913, 1915, 1916, 1918, 1924, 1926, 1927, 1929, 1930, 1931, 1932, 1934, 1936, 1943, 1953, 1955, 1958, 1959, 1961, 1965  
EFI\_MTFTP4\_REQ\_HEADER 1917, 1945  
EFI\_NETWORK\_INTERFACE\_TYPE 1232  
EFI\_NETWORK\_STATISTICS 1218  
EFI\_OPEN\_PROTOCOL\_BY\_CHILD\_CONTROLLER 217  
EFI\_OPEN\_PROTOCOL\_BY\_DRIVER 217, 219  
EFI\_OPEN\_PROTOCOL\_BY\_HANDLE\_PROTOCOL 216, 218  
EFI\_OPEN\_PROTOCOL\_EXCLUSIVE 217, 220  
EFI\_OPEN\_PROTOCOL\_GET\_PROTOCOL 216, 219  
EFI\_OPEN\_PROTOCOL\_TEST\_PROTOCOL 216, 219

EFI\_OPTIONAL\_PTR 305  
EFI\_PARITY\_TYPE 558  
EFI\_PCI\_IO\_PROTOCOL\_ACCESS 828  
EFI\_PCI\_IO\_PROTOCOL\_ATTRIBUTE\_OPERATION 855  
EFI\_PCI\_IO\_PROTOCOL\_CONFIG 828  
EFI\_PCI\_IO\_PROTOCOL\_CONFIG\_ACCESS 828  
EFI\_PCI\_IO\_PROTOCOL\_IO\_MEM 827  
EFI\_PCI\_IO\_PROTOCOL\_POLL\_IO\_MEM 827  
EFI\_PCI\_IO\_PROTOCOL\_WIDTH 827  
EFI\_PCI\_ROOT\_BRIDGE\_IO\_PROTOCOL\_ACCESS 780  
EFI\_PCI\_ROOT\_BRIDGE\_IO\_PROTOCOL\_IO\_MEM 780  
EFI\_PCI\_ROOT\_BRIDGE\_IO\_PROTOCOL\_POLL\_IO\_MEM 779  
EFI\_PCI\_ROOT\_BRIDGE\_IO\_PROTOCOL\_WIDTH 779  
EFI\_PHYSICAL\_ADDRESS 185  
EFI\_PLATFORM\_DRIVER\_OVERRIDE\_PROTOCOL 441  
EFI\_PXE\_BASE\_CODE\_CALLBACK\_PROTOCOL 1280  
EFI\_PXE\_BASE\_CODE\_CALLBACK\_STATUS 1281  
EFI\_PXE\_BASE\_CODE\_FUNCTION 1282  
EFI\_PXE\_BASE\_CODE\_MODE 1234  
EFI\_PXE\_BASE\_CODE\_MTFTP\_INFO 1255  
EFI\_PXE\_BASE\_CODE\_PROTOCOL 1232  
EFI\_PXE\_BASE\_CODE\_TFTP\_OPCODE 1255  
EFI\_RESET\_TYPE 308  
EFI\_RUNTIME\_SERVICES table 112  
EFI\_SERVICE\_BINDING\_PROTOCOL 461  
EFI\_SIMPLE\_NETWORK\_MODE 1205  
EFI\_SIMPLE\_NETWORK\_PROTOCOL 1203  
EFI\_SIMPLE\_NETWORK\_STATE 1207  
EFI\_SIMPLE\_POINTER\_MODE 541  
EFI\_SIMPLE\_POINTER\_STATE 544  
EFI\_STATUS codes ranges 2542  
EFI\_STATUS Error Codes 2542  
EFI\_STATUS Success Codes 2542  
EFI\_STATUS warning codes 2544  
EFI\_STOP\_BITS\_TYPE 558  
EFI\_SYSTEM\_TABLE 106  
EFI\_TABLE\_HEADER 105  
EFI\_TAPE\_IO\_PROTOCOL 631  
EFI\_TCP4\_PROTOCOL 1535, 1536, 1537, 1538, 1543, 1545, 1547, 1550, 1552, 1557, 1559, 1561, 1562  
EFI\_TCP4\_SERVICE\_BINDING\_PROTOCOL 461, 1535  
EFI\_TIME 295  
EFI\_TIME\_CAPABILITIES 297



EFI\_UDP4\_COMPLETION\_TOKEN 1547, 1548, 1550, 1559, 1880, 1898  
 EFI\_UDP4\_CONFIG\_DATA 1541, 1542, 1873  
 EFI\_UDP4\_FRAGMENT\_DATA 1554, 1883, 1901  
 EFI\_UDP4\_PROTOCOL 1869, 1870, 1872, 1875, 1877, 1878, 1880, 1883, 1886, 1888, 1889, 1891  
 EFI\_UDP4\_RECEIVE\_DATA 1554, 1882, 1900  
 EFI\_UDP4\_SERVICE\_BINDING\_PROTOCOL 461, 1869  
 EFI\_UDP4\_SESSION\_DATA 1883, 1900  
 EFI\_UDP4\_TRANSMIT\_DATA 1555, 1884  
 EFI\_UNICODE\_COLLATION\_PROTOCOL 1081  
 EFI\_USB2\_HC\_PROTOCOL 923  
 EFI\_USB\_IO Protocol 963  
 EFI\_VIRTUAL\_ADDRESS 191  
 El Torito 593, 595, 596  
 EnableCursor() 540  
 End of Hardware Device Path, definition of 2771  
 Enhanced Mode (EM), definition of 2771  
 error codes 2542  
 Event Services 158
 

- function list 158
- functions
  - CheckEvent() 175
  - CloseEvent() 171
  - CreateEvent() 163
  - SignalEvent () 172
  - WaitForEvent() 173
- overview 158

 event, definition of 2771  
 Exit() 253  
 ExitBootServices() 255  
 Extensible Firmware Interface Specification 1  
 EXTNDB 1121  
 EXTNDD 1122  
 EXTNDW 1123

## F

FAT file system 592  
 FAT File System, definition of 2771  
 FAT variants 593  
 FatToStr() 1088  
 File Allocation Table (FAT), definition of 2771  
 file attribute bits, EFI\_FILE\_INFO 628  
 File Attributes, EFI\_FILE\_PROTOCOL 605

File Handle Protocol 601

Functions

- Close() 607
- Delete() 608
- EFI\_FILE\_SYSTEM\_INFO 629, 630
- EFI\_GENERIC\_FILE\_INFO 627
- Flush() 627
- GetInfo() 623
- GetPosition() 622
- Open() 604
- Read() 609
- SetInfo() 625
- SetPosition() 621
- Write() 611

Interface Structure 602

Revision Number 602

file names 593

file system format 592, 593

File System Protocol 598

Fill Header 2624

Firmware Interrupts level 159

firmware menu 19

Firmware, definition of 2771

Flush() 627, 804, 853

FlushBlocks() 665, 672

Free() 1291

FreeBuffer() 803, 852

FreePages() 187

FreePool() 194

## G

Geometric Shapes Code Chart 530

Get Config Info 2599

Get Init Info 2596

Get State 2585

Get Status 2621

GetAttributes() 805

GetBarAttributes() 858

GetBootObjectAuthorizationCertificate() 1292

GetBootObjectAuthorizationCheckFlag() 1293

GetBootObjectAuthorizationUpdateToken() 1294

GetControl() 564

control bits 564

GetControllerName() 459  
 GetDriver() 443, 450  
 GetDriverName() 457  
 GetDriverPath() 445  
 GetInfo() 623, 1072  
 GetLocation() 854  
 GetMaximumProcessorIndex() 1029  
 GetMemoryMap() 188  
 GetNextHighMonotonicCount() 309  
 GetNextMonotonicCount() 262  
 GetNextVariableName() 275  
 GetPosition() 622  
 GetRootHubPortNumber() 926  
 GetRootHubPortStatus() 952
 

- PortChangeStatus bit definition 953
- PortStatus bit definition 952

 GetSignatureInfo() 1295  
 GetState() 544, 930  
 GetStatus() 1224  
 GetTime() 295  
 GetVariable() 271  
 GetVersion() 1162  
 GetWakeupTime() 300  
 globally unique identifier, definition of 2772  
 glossary 2765  
 GPT See GUID Partition Table  
 GUID Partition Entry 137  
 GUID Partition Entry, definition of 2773  
 GUID Partition Table 595
 

- GPT 131, 132, 135, 136, 137, 592, 595, 596

 GUID Partition Table Header 135, 596  
 GUID Partition Table Header, definition of 2772  
 GUID Partition Table, definition of 2773  
 GUID Partition, definition of 2773  
 GUID, definition of 2772

## H

Handle, definition of 2773  
 HandleProtocol() 210  
 Hardware Device Path, definition of 2773  
 Hash
 

- Hash 2409

 Headless system 331

HID 337

HID, definition of 2765

Huffman code generation 1067

Huffman coding 2639

HYPERLINK "ch10.doc" 1 "SIMPLE\_TEXT\_OUTPUT"  
08d0c9ea79f9bace118c8200aa004ba90b0200000009000000030300000000000c000000000000  
046000009000000636831302e646f6300ffffadde000000000000000000000000000000000000  
01600000010000000030063006800310030002e0064006f00630013000000530049004d0050004  
c0045005f0054004500580054005f004f00550054005000550054000000SIMPLE\_TEXT\_OUTP  
UT implementation control sequences  
0013000000530049004d0050004c0045005f0054004500580054005f004f0055005400500055  
0054000000SIMPLE\_TEXT\_OUTPUT implementation control sequences 2532

## I

IA-32

EFI Image handoff state 29

ICMP error packet 1239

ICMP Message Types and Codes

Data Structure 1595, 1638

IDE disk device path 2536

Image Handle, definition of 2774

Image Handoff State, definition of 2774

Image Header, definition of 2774

Image Services

function list 244

functions

EFI\_IMAGE\_ENTRY\_POINT 251

Exit() 253

ExitBootServices() 255

LoadImage() 245

StartImage() 248

UnloadImage() 250

overview 242

Image, definition of 2774

images

loading 19

implementation requirements

general 71

required elements 71

Initialize 2602

Initialize() 1210, 1286

InstallConfigurationTable() 263

InstallMultipleProtocolInterfaces() 240

- InstallProtocolInterface() 200
- instruction summary
  - EFI byte code virtual machine 2683
- Intel Architecture-32 (IA-32), definition of 2774
- Intel® Itanium™ Architecture, definition of 2774
- interfaces
  - general categories 23
  - purpose 22
- Interpreter, definition of 2775
- Interrupt Enables 2608
- InterruptStatus interrupt bit mask settings 1224
- InvalidateInstructionCache() 1045
- Io.Read() 792, 840
- Io.Write() 792, 840
- IP filter operation 1262
- IP4 Protocol
  - Functions
    - Poll() 1611, 1659
- IPv4 Fragment Data
  - Data Structure 1605
- IPv4 Header
  - Data Structure 1604
- IPv4 IOCTL Data
  - Data Structure 1593, 1635
- IPv4 Mode Data
  - Data Structure 1592, 1634
- IPv4 Override Data
  - Data Structure 1606
- IPv4 Receive Data
  - Data Structure 1603
- IPv4 Route Table
  - Data Structure 1595, 1637
- IPv4 Transmit Data
  - Data Structure 1605
- ISO-9660 596
- IsochronousTransfer() 946
- Itanium architecture
  - EFI Image handoff state 32
  - firmware specifications 2764
  - platforms 2764
  - requirements, related to this specification 2764

## **J**

JMP 1124  
JMP8 1127

## **L**

LAN On Motherboard (LOM), definition of 2775  
LBA See Logical Block Address  
legacy floppy device path 2535  
legacy interfaces 9  
legacy Master Boot Record 125  
    and GPT Partitions 128  
    Partition Record 126  
legacy MBR 593  
legacy OS 10  
Legacy Platform, definition of 2775  
legacy systems, support of 14  
Little Endian, definition of 2775  
Load File Protocol 1244  
    Functions  
        LoadFile() 588  
        GUID 587  
        Interface Structure 587  
Loaded Image Protocol 327  
    functions  
        Unload() 329  
        GUID 327  
        Interface Structure 327  
        Revision Number 327  
Loaded Image, definition of 2775  
LoadFile() 588  
LoadImage() 245  
LOADSP 1128  
LocateDevicePath() 212  
LocateHandle() 208  
LocateHandleBuffer() 236  
LocateProtocol() 239  
long file names 593  
Long File Names (LFN), definition of 2776  
LZ77 coding 2639

## **M**

Machine Check Abort (MCA), definition of 2776

## Managed Network Protocol

## Functions

Cancel() 1359  
 Configure() 1345  
 GetModeData() 1342  
 Groups() 1349  
 McastIpToMac() 1347  
 Poll() 1360  
 Receive() 1357  
 Transmit() 1351

GUID 1340

Interface Structure 1340

## Managed Network Service Binding Protocol

GUID 1339

Map() 798, 847

Master Boot Record 592

Master Boot Record (MBR), definition of 2776

MAX\_MCAST\_FILTER\_CNT 1207

MBR See Master Boot Record

MCast IP To MAC 2617

MCastIPtoMAC() 1221

Media Device Path, definition of 2777

media formats 597

Mem.Read() 790, 838

Mem.Write() 790, 838

## Memory Allocation Services

function list 180

functions

AllocatePages() 184  
 AllocatePool() 193  
 FreePages() 187  
 FreePool() 194  
 GetMemoryMap() 188

overview 180

Memory Attribute Definitions 190

memory map 181

Memory Map, definition of 2777

Memory Type, definition of 2777

memory type, usage

after [HYPERLINK](#) 1 "ExitBootServices"  
 08d0c9ea79f9bace118c8200aa004ba90b020000000800000011000000450078006900  
 740042006f006f007400530065007200760069006300650073000000ExitBootService  
 s() 181

before                    [HYPERLINK](#)                    1                    "ExitBootServices"  
08d0c9ea79f9bace118c8200aa004ba90b020000000800000011000000450078006900  
740042006f006f007400530065007200760069006300650073000000ExitBootService  
s() 181

Messaging Device Path, definition of 2777

MetaMatch() 1084

migration requirements 14

- EFI support on a legacy platform 14
- legacy OS support 14

migration, from legacy systems 14

Miscellaneous Boot Services

- overview 256

Miscellaneous Runtime Services

- overview 306

Miscellaneous Services

- function list 256, 306
- functions
  - CalculateCrc32() 265
  - CopyMem() 260
  - GetNextHighMonotonicCount() 309
  - GetNextMonotonicCount() 262
  - InstallConfigurationTable() 263
  - ResetSystem() 292, 307, 311, 318
  - SetMem() 261
  - SetWatchdogTimer() 257
  - Stall() 259

MOD 1129

MODU 1130

MOV 1131

MOVI 1133

MOVIn 1135

MOVn 1136

MOVREL 1137

MOVsn 1138

Mtftp() 1254

MTFTP4 Packet Definitions 1917, 1945

MUL 1140

Multicast Trivial File Transfer Protocol (MTFTP), definition of 2777

MULU 1141

**N**

Name Space

- EFI device path 2539



- Name space 331
- Name Space, definition of 2778
- Native Code, definition of 2778
- natural indexing 1100
- NEG 1142
- Network Boot Program, definition of 2778
- Network Bootstrap Program (NBP), definition of 2778
- Network Interface Card (NIC), definition of 2778
- Network Interface Identifier Protocol 1229
  - GUID 1230
  - Interface Structure 1230
  - Revision Number 1230
- nonvolatile storage 876
- NOT 1143
- NvData 2619
- NvData() 1222
- NVRAM variables 79

## O

- opcode summary
  - EFI byte code virtual machine 2683
- Open Modes, EFI\_FILE\_PROTOCOL 605
- Open() 604
- OpenProtocol() 214
- OpenProtocolInformation() 224
- OpenVolume() 600
- operating system loader, definition of 2786
- Option ROM 9
- option ROM 14, 1097
  - EBC 1098
  - legacy 1098
  - relocatable image 1098
  - size restrictions 1098
- option ROM formats 1169
- OptionsValid() 475
- OR 1144
- OS loader, definition of 2786
- OS Loader, EFI 21
- OS network stacks 2550
- OutputString() 528
- overview of design 11

## P

- Page Memory, definition of 2779
- partition discovery 595
- Partition Discovery, definition of 2779
- partitioning scheme, EFI 131
- PCANSI terminals, and SIMPLE\_TEXT\_OUTPUT 2531
- PCI bus driver responsibilities 867
- PCI Bus Driver, definition of 2779
- PCI bus drivers 817
- PCI Bus, definition of 2779
- PCI Configuration Space, definition of 2779
- PCI Controller, definition of 2780
- PCI device driver responsibilities 870
- PCI Device Driver, definition of 2780
- PCI device drivers 822
- PCI device paths 862
- PCI Device, definition of 2780
- PCI driver initialization 815
- PCI driver model 814
- PCI Enumeration, definition of 2780
- PCI Function, definition of 2780
- PCI Host Bus Controller, definition of 2780
- PCI hot-plug events 876
- PCI I/O Protocol 824
  - Functions
    - AllocateBuffer() 850
    - Attributes() 855
    - CopyMem() 844
    - Flush() 853
    - FreeBuffer() 852
    - GetBarAttributes() 858
    - GetLocation() 854
    - Io.Read() 840
    - Io.Write() 840
    - Map() 847
    - Mem.Read() 838
    - Mem.Write() 838
    - Pci.Read() 842
    - Pci.Write() 842
    - PollIo() 836
    - PollMem() 834
    - SetBarAttributes() 861
    - Unmap() 849

- GUID 825
  - Interface Structure 825
- PCI Option ROM, definition of 2780
- PCI option ROMs 864
- PCI root bridge device paths 811
- PCI Root Bridge I/O Protocol 777
  - Functions
    - AllocateBuffer() 801
    - Configuration() 809
    - CopyMem() 796
    - Flush() 804
    - FreeBuffer() 803
    - GetAttributes() 805
    - Io.Read() 792
    - Io.Write() 792
    - Map() 798
    - Mem.Read() 790
    - Mem.Write() 790
    - Pci.Read() 794
    - Pci.Write() 794
    - PollIo() 788
    - PollMem() 786
    - SetAttributes() 807
    - Unmap() 800
  - GUID 481, 777
  - Interface Structure 777
- PCI root bridge I/O support 771
- PCI Root Bridge, definition of 2781
- PCI Segment, definition of 2781
- Pci.Read() 794, 842
- Pci.Write() 794, 842
- PE32+ image format 20
- platform driver override protocol 441
- plug and play option ROMs
  - and boot services 23
- pointer movement 2633
- Poll() 1051
- PollIo() 788, 836
- PollMem() 786, 834
- Pool Memory, definition of 2781
- POP 1145
- POPn 1146
- Preboot Execution Environment (PXE), definition of 2781

prerequisite specifications 2763

Protocol

11.7Graphics Output Protocol 339

23.4PXE Base Code Callback 1236, 1246, 1279

ARP 3, 7, 461, 462, 463, 464, 465, 467, 468, 469, 470, 1233, 1234, 1235, 1238, 1241, 1242, 1266, 1267, 1268, 1269, 1282, 1545, 1600, 1735, 1736, 1737, 1738, 1739, 1740, 1741, 1742, 1743, 1744, 1745, 1746, 1747, 1748, 1878

ARP Service Binding 1735

Block I/O 655, 665

Boot Integrity Services 1283

Boot Integrity Services (BIS) 1235, 1282

Console I/O 5, 202, 509

Debug Support 1026

Debugport 1046

Decompress 1070

Device Path 331

Disk I/O 643

EBC Interpreter 1157

EFI DHCPv4 Service Binding 1749, 1754, 1756, 1775

EFI IPv4 3, 7, 1385, 1386, 1430, 1445, 1459, 1477, 1539, 1588, 1589, 1590, 1591, 1592, 1593, 1594, 1595, 1596, 1597, 1598, 1600, 1601, 1602, 1603, 1604, 1608, 1611, 1612, 1614, 1615, 1616, 1617, 1618, 1629, 1630, 1631, 1633, 1634, 1635, 1636, 1639, 1642, 1643, 1644, 1646, 1650, 1651, 1652, 1656, 1657, 1659, 1729, 1749, 1751, 1869, 1872, 1873, 1874, 1894, 1909

EFI MTFTPv4 3, 7, 1702, 1704, 1705, 1707, 1708, 1711, 1712, 1715, 1716, 1849, 1852, 1864, 1907, 1908, 1909, 1910, 1911, 1913, 1914, 1918, 1923, 1926, 1928, 1930, 1931, 1932, 1933, 1935, 1936, 1941, 1951, 1955, 1957, 1959, 1960, 1961, 1962, 1964, 1965

EFI MTFTPv4 Service Binding 1907

EFI Service Binding 460, 1339, 1735

EFI TCPv4 3, 7, 1535, 1536, 1537, 1538, 1539, 1543, 1546, 1547, 1549, 1551, 1555, 1557, 1558, 1560

EFI TCPv4 Service Binding 1535

EFI UDPv4 3, 7, 1869, 1870, 1872, 1873, 1874, 1875, 1876, 1877, 1878, 1879, 1880, 1881, 1882, 1883, 1884, 1886, 1907, 1909, 1936

File Handle 601

File System 598

Load File 1244

Loaded Image 327

Managed Network 3, 7, 1339, 1737

Managed Network Service Binding 3, 7, 1339

Network Interface Identifier 1229, 1231, 1243

PCI I/O 824

PCI Root Bridge I/O 777

- PXE Base Code 1232
- PXE Base Code Callback 1280
- Serial I/O 555
- Simple File System 598
- Simple Input 509, 520
- Simple Network 1203, 1216, 1220, 1221, 1229, 1232, 1244, 1340
- Simple Pointer 540
- Unicode Collation 1081
- Protocol Handler Services
  - function list 195
  - functions 194
    - CloseProtocol() 221
    - ConnectController() 226
    - DisconnectController() 231
    - HandleProtocol() 210
    - InstallMultipleProtocolInterfaces() 240
    - InstallProtocolInterface() 200
    - LocateDevicePath () 212
    - LocateHandle() 208
    - LocateHandleBuffer() 236
    - LocateProtocol() 239
    - OpenProtocol() 214
    - OpenProtocolInformation() 224
    - ProtocolsPerHandle() 234
    - RegisterProtocolNotify() 206
    - ReinstallProtocolInterface() 204
    - UninstallMutipleProtocolInterfaces() 242
    - UninstallProtocolInterface() 202
  - overview 194
- Protocol Handler, definition of 2782
- Protocol Interface, definition of 2782
- Protocol Revision Number, definition of 2782
- Protocol, definition of 2782
- protocols 52
  - code illustrating 53
  - construction of 53
  - EFI\_BUS\_SPECIFIC\_DRIVER\_OVERRIDE\_PROTOCOL 448
  - EFI\_DEVICE\_PATH 332
  - EFI\_DRIVER\_BINDING\_PROTOCOL 419
  - EFI\_DRIVER\_DIAGNOSTICS\_PROTOCOL 451
  - EFI\_PLATFORM\_DRIVER\_OVERRIDE\_PROTOCOL 441
  - EFI\_USB2\_HC\_PROTOCOL 923
  - EFI\_USB\_IO Protocol 963

- list of 54
- UGA protocols 566
- ProtocolsPerHandle() 234
- PUSH 1147
- PUSHn 1148
- PXE Base Code Callback Protocol 1280
  - Functions
    - Callback() 1281
  - GUID 1280
  - Interface Structure 1280
  - Revision Number 1280
- PXE Base Code Protocol 1232
  - Functions
    - Arp() 1266
    - Dhcp() 1248
    - Discover() 1250
    - Mtftp() 1254
    - SetIpFilter() 1264
    - SetPackets() 1272
    - SetParameters() 1268
    - SetStationIp() 1270
    - Start() 1245
    - Stop() 1247
    - UdpRead() 1260
    - UdpWrite() 1258
  - GUID 1233
  - Interface Structure 1233
  - Revision Number 1233
- PXE boot server bootstrap types 1251
- PXE tag definitions for EFI 1243

## Q

- QueryCapsuleCapsule() 318
- QueryMode() 533

## R

- Read() 609, 1050
- Read(), SERIAL\_IO 566
- ReadBlocks() 661, 668
- ReadDisk() 645
- ReadKeyStroke() 523
- Read-Only Memory (ROM), definition of 2783
- Receive 2629

- Receive Filters 2610
- Receive() 1228
- ReceiveFilters() 1213
- ReceiveFilterSetting bit mask values 1207
- RegisterExceptionCallback() 1039
- RegisterICacheFlush() 1160
- RegisterPeriodicCallback() 1030
- RegisterProtocolNotify() 206
- ReinstallProtocolInterface() 204
- Reset, PXE 2605
- Reset, UNDI 2605
- Reset(), Debugport Protocol 1048
- Reset(), EFI\_BLOCK\_IO 660, 667
- Reset(), EFI\_SIMPLE\_POINTER 543
- Reset(), SERIAL\_IO 559
- Reset(), Simple Network Protocol 1211
- Reset(), SIMPLE\_INPUT 522
- Reset(), SIMPLE\_TEXT\_OUTPUT 527
- Reset(), USB Host Controller 928
- ResetSystem() 292, 307, 311, 318
- RestoreTPL() 180
- RET 1149
- RunDiagnostics() 453
- Runtime Services 157, 267
  - Miscellaneous Runtime Services 306
  - Time Services 294
  - Variable Services 270
  - Virtual Memory Services 302
- runtime services 11, 23
- Runtime Services Driver, definition of 2786
- Runtime Services Table, definition of 2783
- Runtime Services Table, EFI 103
- Runtime Services, definition of 2783

## S

- SAL, definition of 2783
- SAS Boot 354, 357
- SCSI Pass Thru device paths 895
- SCSI Pass Thru Protocol
  - using 2635
- Secondary Root PCI Bus with PCI to PCI Bridge Device Path 2538
- Security
  - Driver Signing 1973

Hash 2409, 2410, 2411, 2412, 2413, 2414, 2417, 2420, 2421, 2423, 2424, 2425, 2426, 2428  
Serial I/O Protocol 555  
    Functions  
        GetControl() 564  
        Read() 566  
        Reset() 559  
        SetAttributes() 560  
        SetControl() 562  
        Write() 565  
    GUID 556  
    Interface Structure 556  
    Revision Number 556  
SERIAL\_IO\_MODE 557  
services 22  
SetAttribute() 535  
SetAttributes() 560, 807  
SetBarAttributes() 861  
SetControl() 562  
    control bits 562  
SetCursorPosition() 539  
SetInfo() 625  
SetIpFilter() 1264  
SetMem() 261  
SetMode() 534, 575, 582  
SetOptions() 473  
SetPackets() 1272  
SetParameters() 1268  
SetPosition() 621  
SetRootHubPortFeature () 956  
SetState() 932  
SetStationIp() 1270  
SetTime() 299  
SetTimer() 176  
SetVariable() 277  
SetVirtualAddressMap() 303  
SetWakeupTime() 301  
SetWatchdogTimer() 257  
SHL 1150  
SHR 1151  
Shutdown 2607  
Shutdown() 1212, 1290  
SignalEvent() 172  
Simple File System Protocol 598



- functions
  - OpenVolume() 600
  - GUID 599
  - Interface Structure 599
  - Revision Number 599
- Simple Input Protocol 509, 520
  - Functions
    - ReadKeyStroke() 523
    - Reset() 522
  - GUID 521
  - Interface Structure 521
  - Scan Codes for 510
- Simple Network Protocol 1203, 1232, 1244
  - Functions
    - GetStatus() 1224
    - Initialize() 1210
    - MCastIPtoMAC() 1221
    - NVData() 1222
    - Receive() 1228
    - ReceiveFilters() 1213
    - Reset() 1211
    - Shutdown() 1212
    - Start() 1208
    - StationAddress() 1216
    - Statistics() 1217
    - Stop() 1209
    - Transmit() 1226
  - GUID 1203
  - Interface Structure 1203
  - Revision Number 1203
- Simple Pointer Protocol 540, 2633
  - Functions
    - GetState() 544
    - Reset() 543
  - GUID 541
  - Protocol Interface Structure 541
- Simple Text Output Protocol
  - Functions
    - ClearScreen() 538
    - EnableCursor() 540
    - OutputString() 528
    - Querymode() 533
    - Reset() 527

- SetAttribute() 535
- SetCursorPosition() 539
- Setmode() 534
- TestString() 532
- GUID 524
  - Interface Structure 524
- SIMPLE\_INPUT protocol, implementation 2529
- SIMPLE\_TEXT\_OUTPUT protocol, implementation 2529
- SIMPLE\_TEXT\_OUTPUT\_MODE 525
- SMBIOS, definition of 2784
  - specifications, other 2763
  - specifications, prerequisite 2763
- Stall() 259
- StandardError 523
- StandardError, definition of 2784
- Start 2587
- Start() 428, 1208
- Start(), PXE Base Code Protocol 1245
- StartImage() 248
- Station Address 2612
- StationAddress() 1216
- Statistics 2614
- Statistics() 1217
- Status Codes, definition of 2784
- Stop 2595
- Stop() 437, 1209
- Stop(), PXE Base Code Protocol 1247
- STORESP 1152
- StriColl() 1083
- StrLwr() 1086
- StrToFat() 1089
- StrUpr() 1087
- SUB 1153
- success codes 2542
- Supported() 422
- SyncInterruptTransfer() 943
- System Abstraction Layer (SAL), definition of 2785
- System Management BIOS (SMBIOS), definition of 2785
- System Partition 592, 594
  - system partition 11
- System Table, definition of 2785
- System Table, EFI 103

**T**

- table-based interfaces 11
- Task Priority Level (TPL), definition of 2785
- task priority levels
  - general 158
  - restrictions 159
  - usage 159
- Task Priority Services 158
  - function list 158
  - functions
    - RestoreTPL() 180
  - overview 158
- terminology, definitions 2765
- TestString() 532
- TFTP error packet 1239
- Time Format, definition of 2785
- Time Services
  - function list 294
  - functions
    - GetTime() 295
    - GetWakeupTime() 300
    - SetTime() 299
    - SetWakeupTime() 301
  - overview 294
- Timer Services 158
  - function list 158
  - functions
    - SetTimer() 176
  - overview 158
- TPL restrictions 159
- TPL See task priority levels
- TPL\_APPLICATION level 159
- TPL\_HIGH\_LEVEL 159
- TPL\_NOTIFY level 159
- Transmit 2626
- Transmit() 1226
- Trivial File Transport Protocol (TFTP), definition of 2786

**U**

- UDP port filter operation 1262
- UDP4 Service Binding Protocol
  - GUID 1535, 1869, 1890
- UdpRead() 1260

- UdpWrite() 1258
- UGA Draw Protocol
  - Functions
    - Blt() 576
    - SetMode() 575, 582
  - GUID 568
  - protocol interface structure 568
- UGA protocols 566
- \_UID 337
- \_UID, definition of 2765
- UNDI C definitions 2559
- UNDI CDB 2557
- UNDI CDB field definitions 2558
- UNDI command descriptor block 2557
- UNDI command format 2556
- UNDI commands 2582
  - Fill Header 2624
  - Get Config Info 2599
  - Get Init Info 2596
  - Get State 2585
  - Get Status 2621
  - Initialize 2602
  - Interrupt Enables 2608
  - issuing 2556
  - linking & queuing 2584
  - MCast IP To MAC 2617
  - NvData 2619
  - Receive 2629
  - Receive Filters 2610
  - Reset 2605
  - Shutdown 2607
  - Start 2587
  - Station Address 2612
  - Statistics 2614
  - Stop 2595
  - Transmit 2626
- UNDI Specification
  - Definitions 2546
  - driver types 2551
  - Referenced Specifications 2548
- UNDI Specification, 32/64-Bit 2545
- Unicode Collation Protocol 1081
  - Functions

- FatToStr() 1088
- MetaMatch() 1084
- StriColl() 1083
- StrLwr() 1086
- StrToFat() 1089
- StrUpr() 1087
- GUID 1081
  - Interface Structure 1081
- Unicode control characters, supported 510
- UNICODE DRAWING CHARACTERS 529
- Unicode, definition of 2787
- UninstallMultipleProtocolInterfaces() 242
- UninstallProtocolInterface() 202
- Universal Graphics Adapter protocols 566
- Universal Network Device Interface (UNDI), definition of 2787
- Universal Serial Bus (USB), definition of 2787
- Unload() 329
- UnloadImage() 250, 1159
- Unmap() 800, 849
- Update Capsule 310
- UpdateBootObjectAuthorization() 1300
  - Manifest Syntax 1301
- UpdateCapsule() 311
- USB Bus Driver 960
  - Bus Enumeration 961
  - Driver Binding Protocol 960
  - Entry Point 960
  - Hot-Plug Event 960
- USB Bus Driver, definition of 2787
- USB Bus, definition of 2787
- USB Controller, definition of 2787
- USB Device Driver 961
  - Driver Binding Protocol 962
  - Entry Point 962
- USB Device Driver, definition of 2787
- USB Device, definition of 2788
- USB Driver Model 959
- USB Enumeration, definition of 2788
- USB Host Controller Protocol 923
  - GUID 924
  - Interface Structure 924
- USB host controller protocol 923
- USB Host Controller, definition of 2788

- USB hub port change status bitmap 955
- USB hub port status bitmap 954
- USB Hub, definition of 2788
- USB I/O Protocol
  - functions
    - UsbAsyncInterruptTransfer () 970
    - UsbAsyncIsochronousTransfer () 979
    - UsbBulkTransfer () 968
    - UsbControlTransfer() 965
    - UsbGetConfigDescriptor () 983
    - UsbGetDeviceDescriptor () 981
    - UsbGetEndpointDescriptor() 987
    - UsbGetInterfaceDescriptor () 985
    - UsbGetStringDescriptor() 989
    - UsbGetSupportedLanguages() 990
    - UsbIsochronousTransfer () 977
    - UsbPortReset() 991
    - UsbSyncInterruptTransfer () 975
- USB I/O protocol 963
  - GUID 963
  - Interface Structure 963
- USB Interface, definition of 2788
- USB port feature 957
- USB transfer result error codes 966
- UsbAsyncInterruptTransfer() 970
- UsbAsyncIsochronousTransfer () 979
- UsbBulkTransfer() 968
- UsbControlTransfer() 965
- UsbGetConfigDescriptor() 983
- UsbGetDeviceDescriptor () 981
- UsbGetEndpointDescriptor() 987
- UsbGetInterfaceDescriptor() 985
- UsbGetStringDescriptor() 989
- UsbGetSupportedLanguages() 990
- UsbIsochronousTransfer() 977
- UsbPortReset() 991
- UsbSyncInterruptTransfer() 975

## V

- Variable Attributes 272
- Variable Services
  - function list 270
  - functions

- GetNextVariableName() 275
- GetVariable() 271
- SetVariable() 277
- overview 270
- variables
  - global 92
  - non-volatile 92
- VerifyBootObject() 1308
  - Manifest Syntax 1308
- VerifyObjectWithCredential() 1316
  - Manifest Syntax 1317
- virtual machine 1097
  - registers 1099
- Virtual Memory Services
  - function list 302
  - functions
    - ConvertPointer() 305
    - SetVirtualAddressMap () 303
  - overview 302
- VM, definition of 2788

## W

- WaitForEvent() 173
- warning codes 2544
- Watchdog timer, definition of 2788
- WIN\_CERTIFICATE 1977, 1978, 1979, 1980
- Wired for Management (WfM), definition of 2789
- Write() 611, 1049
- Write(), SERIAL\_IO 565
- WriteBlocks() 663, 670
- WriteDisk() 646

## X

- x64 33
- XOR 1154