



For FAQs and more information, please visit:

www.eufylife.com



Cleaning

Owner's Manual

RoboVac

Table of Contents

02 Important Safety Instructions

10 About Your RoboVac

What's In the Box

RoboVac Anatomy

LED Indication

14 Using Your RoboVac

Important Tips Before Use

Preparation

Charge Your RoboVac

Use Your RoboVac with the EufyHome App

Start / Stop Cleaning

Select a Cleaning Mode

Use Your RoboVac with Amazon Alexa /
the Google Assistant

24 Cleaning and Maintenance

Clean the Dust Collector and Filter

Clean the Rolling Brush

Clean the Side Brushes

Replace the Side Brushes

Clean the Sensors and Charging Pins

Clean the Swivel Wheel

30 Troubleshooting

34 Specifications

35 Customer Service

Thank you for purchasing RoboVac. Read all instructions before using this product, and keep it properly for future reference.

Important Safety Instructions

To reduce the risk of injury or damage, read these safety instructions carefully and keep them at hand when setting up, using, and maintaining this device.



WARNING SYMBOLS USED

This is the safety alert symbol. This symbol alerts you to potential hazards that could result in property damage and/or serious bodily harm or death.

- This device can be used by children aged from 8 years and above and persons with reduced physical, sensory or mental capabilities or lack of experience and knowledge if they have been given supervision or instruction concerning use of this device in a safe way and understand the hazards involved.
- Children should be supervised to ensure they do not play with this device.
- Cleaning and maintenance shall not be performed by children without adult supervision.
- This device is only to be used with the power supply unit provided.
- The plug must be removed from the socket-outlet before cleaning or maintaining this device. This device contains the battery that is only replaceable by skilled persons.
- This device must be disconnected from the supply mains when removing the battery.
- For the purposes of recharging the battery, only use the detachable power supply unit provided with this device.
- The battery must be removed from this device before this device is disposed of. To remove the battery from this device, first remove the screws on the bottom, then remove the main PCB and unscrew the battery cover using a screwdriver. Remove the battery by disconnecting the quick connector.
- The used battery should be placed in a sealed plastic bag and disposed of safely according to local environmental regulations.
- The external flexible cable or cord of the power supply unit cannot be replaced; if the cord is damaged, the

power supply unit shall be disposed of.

- This device is for indoor use only. Do not use outdoors or on wet surfaces.
- This device is not a toy. Do not sit or stand on this device. Small children and pets should be supervised when this device is operating.
- Store and operate this device in room temperature environments only.
- Clean with a cloth dampened with water only.
- Do not use this device to pick up anything that is burning or smoking.
- Do not use this device to pick up spills of bleach, paint, chemicals, or anything wet.
- Before using this device, pick up objects like clothing and loose paper. Lift up cords for blinds or curtains, and move power cords and fragile objects out of the way. If this device passes over a power cord and drags it, an object could be pulled off a table or shelf.
- If the room to be cleaned has a balcony, a physical barrier should be used to prevent access to the balcony and to ensure safe operation.
- Do not place anything on top of this device.
- Be aware that this device moves around on its own. Take care when walking in the area where this device is operating to avoid stepping on it.
- Do not operate this device in areas with exposed electrical outlets on the floor.
- Do not expose the electronics of this device, its battery, or the integrated Charging Base. There are no user-serviceable parts inside.
- Do not use this device on an unfinished, unsealed, waxed or rough floor. It may result in damage to the floor and this device. Use only on hard floor surfaces or low-pile carpet.
- This device has been designed to be used on floors without scratching them. We still recommend that you test this device on a small area of the room to be cleaned to ensure no scratches are made before cleaning the whole room. Use only attachments recommended or described in this manual.
- Use only attachments recommended or described in this manual.

- Do not handle plug or appliance with wet hands.
- Do not use without dust bag and/or filters in place.
- Do not use a battery pack or appliance that is damaged or modified. Damaged or modified batteries may exhibit unpredictable behavior resulting in fire, explosion or risk of injury.
- Do not expose a battery pack or appliance to fire or excessive temperature. Exposure to fire or temperature above 130°C may cause explosion.
- Do not modify or attempt to repair the appliance or the battery pack (as applicable) except as indicated in the instructions for use and care.
- Follow all charging instructions and do not charge the battery pack or appliance outside of the temperature range specified in the instructions. Charging improperly or at temperatures outside of the specified range may damage the battery and increase the risk of fire.

Notice



This symbol on the device or its packaging indicates:

Do not dispose of electrical appliances as unsorted municipal waste; use separate collection facilities. Contact your local authority for information regarding the collection systems available. If electrical appliances are disposed of in landfills or dumps, hazardous substances can leak into the groundwater and get into the food chain, damaging your health and well-being. When replacing old appliances with new ones, the retailer is legally obliged to take back your old appliance for disposal at least free of charge.

FCC Statement

This device complies with Part 15 of the FCC Rules. Operation is subject to the following two conditions: (1) This device may not cause harmful interference, and (2) this device must accept any interference received, including interference that may cause undesired operation.

Warning: Changes or modifications not expressly approved by the party responsible for compliance could void the user's authority to operate the equipment.

Note: This equipment has been tested and found to comply with the limits for a Class B digital device, pursuant to Part 15 of the FCC Rules. These limits are designed to provide reasonable protection against harmful interference in a residential installation.

This equipment generates, uses, and can radiate radio frequency energy and, if not installed and used in accordance with the instructions, may cause harmful interference to radio communications. However, there is no guarantee that interference will not occur in a particular installation. If this equipment does cause harmful interference to radio or television reception, which can be determined by turning the equipment off and on, the user is encouraged to try to correct the interference by one or more of the following measures: (1) Reorient or relocate the receiving antenna. (2) Increase the separation between the equipment and receiver. (3) Connect the equipment into an outlet on a circuit different from that to which the receiver is connected. (4) Consult the dealer or an experienced radio / TV technician for help.

FCC Radiation Exposure Statement

This equipment complies with FCC radiation exposure limits set forth for an uncontrolled environment. This equipment should be installed and operated with minimum distance 20 cm between the radiator & your body.

IC Statement

This device complies with Industry Canada licence-exempt RSS standard(s). Operation is subject to the following two conditions: (1) this device may not cause interference, and (2) this device must accept any interference, including interference that may cause undesired operation of the device.

Declaration of Conformity

This product complies with the radio interference requirements of the European Community. Hereby, Anker Innovations Limited declares that the radio equipment type T2117/T2118/T2120/T2123/T2128/T2130 is in compliance with Directive 2014/53/EU. The full text of the EU declaration of conformity is available at the following internet address: <https://www.eufylife.com/>.

Maximum output power: 14 dBm

Frequency band: 2.4G band (2.4000GHz - 2.4835GHz)

Contains FCC ID: 2ANDL-TYWE1S Contains IC: 23243-TYWE1S

Trademark Notice

- Amazon, Echo, Alexa and all related logos are trademarks of Amazon.com, Inc. or its affiliates.
- Apple and the Apple logo are trademarks of Apple Inc., registered in the U.S. and other countries. App Store is a service mark of Apple Inc., registered in the U.S. and other countries.
- Google Play and the Google Play logo are trademarks of Google Inc.
- Google Home is a trademark of Google Inc.

Consignes de Sécurité

Pour réduire le risque de blessures ou de dommages, lisez attentivement ces consignes de sécurité et gardez-les en main lors de la mise en place, de l'utilisation et de l'entretien de cet appareil.



SYMBOLES D'AVERTISSEMENT UTILISÉS

Voici le symbole d'alerte de sécurité. Ce symbole vous avertit des dangers potentiels pouvant entraîner des dommages matériels et/ou des lésions corporelles graves ou la mort.

- Cet appareil peut être utilisé par des enfants âgés de 8 ans et plus, ainsi que des personnes présentant des capacités physiques, sensorielles ou mentales réduites, ou un manque d'expérience et de connaissances, si celles-ci sont sous surveillance ou ont reçu les instructions d'utilisation de cet appareil et comprennent les risques encourus, et l'utilisent dans un endroit sûr.
- Les enfants doivent être surveillés afin de s'assurer qu'ils ne jouent pas avec cet appareil.
- Le nettoyage et l'entretien ne doivent pas être effectués par des enfants sans la supervision des adultes.
- Cet appareil doit uniquement être utilisé avec le bloc d'alimentation fourni.
- La fiche doit être débranchée de la prise de courant avant de nettoyer ou d'entretenir cet appareil.

- Cet appareil contient une batterie qui ne peut être remplacée que par des personnes qualifiées.
- Cet appareil doit être débranché du secteur lorsque vous retirez la batterie.
- Pour recharger la batterie, utilisez uniquement le cordon amovible du bloc d'alimentation fourni avec cet appareil.
- La batterie doit être retirée de cet appareil avant de le mettre au rebut. Pour retirer la batterie à partir de cet appareil, retirez d'abord les vis de la partie inférieure, puis retirez le circuit principal et dévissez le couvercle de la batterie à l'aide d'un tournevis. Retirez la batterie en débranchant le connecteur rapide.
- La batterie usagée doit être placée dans un sac en plastique hermétique et éliminée en toute sécurité, conformément aux réglementations environnementales locales.
- Le câble flexible externe ou le cordon du bloc d'alimentation ne peut pas être remplacé ; si le cordon est endommagé, l'unité d'alimentation doit être éliminée.
- Cet appareil est destiné exclusivement à une utilisation en intérieur. Ne pas utiliser à l'extérieur ou sur des surfaces humides.
- Cet appareil n'est pas un jouet. Ne pas se tenir debout ou assis sur cet appareil. Les jeunes enfants et les animaux de compagnie doivent être surveillés lors du fonctionnement de cet appareil.
- Entrez et utilisez cet appareil dans des environnements à température ambiante.
- Nettoyez avec un chiffon imbibé d'eau uniquement.
- Ne pas utiliser cet appareil pour ramasser tout élément en train de brûler ou fumant.
- Ne pas utiliser cet appareil pour ramasser des déversements d'eau de javel, de peinture, de produits chimiques ou quoi que ce soit de mouillé.
- Avant d'utiliser cet appareil, ramassez les objets tels que les vêtements et les feuilles de papier. Mettez en hauteur les cordons de stores ou de rideaux au sol et déplacez les objets fragiles et les cordons d'alimentation hors du passage de l'appareil. Si cet appareil passe au-dessus d'un cordon d'alimentation et le traîne avec lui, un objet peut tomber d'une table ou d'une étagère.
- Si la pièce à nettoyer possède un balcon, une barrière

physique doit être utilisée pour empêcher l'accès au balcon et garantir un fonctionnement sécurisé.

- Ne rien placer sur le dessus de cet appareil.
- Gardez à l'esprit que cet appareil se déplace par ses propres moyens. Faites attention en marchant dans la zone où cet appareil fonctionne, afin d'éviter de marcher dessus.
- Ne pas utiliser cet appareil dans des zones avec prises électriques exposées sur le plancher.
- Ne pas exposer l'électronique de cet appareil, de sa batterie ou de la base de recharge intégrée. L'appareil ne contient aucune pièce réparable par l'utilisateur.
- Ne pas utiliser cet appareil sur un sol inachevé, non vitrifié, ciré ou rugueux. Cela peut entraîner des dommages sur le sol et cet appareil. Utilisez-le uniquement sur des surfaces dures ou des moquettes à poils ras.
- Cet appareil a été conçu pour être utilisé sur des planchers sans le rayer. Nous vous recommandons de toujours tester le périphérique sur une petite zone de la pièce à nettoyer, avant de nettoyer la salle entière, pour s'assurer qu'aucune rayure n'apparaisse.
- Utilisez uniquement les accessoires recommandés ou décrits dans ce manuel.
- Ne manipulez pas la fiche ou l'appareil avec les mains mouillées.
- Ne pas utiliser sans le sac à poussière et/ou les filtres en place.
- N'utilisez pas de batterie ou d'appareil endommagé ou modifié. Les batteries endommagées ou modifiées peuvent présenter un comportement imprévisible risquant d'entraîner un incendie, une explosion ou une blessure.
- N'exposez pas la batterie ou l'appareil au feu ou à des températures excessives. L'exposition au feu ou à une température supérieure à 130°C peut provoquer une explosion.
- Ne modifiez pas et n'essayez pas de réparer l'appareil ou la batterie (si applicable), sauf si cela est indiqué dans les instructions d'utilisation et d'entretien.
- Suivez toutes les instructions de chargement et ne chargez pas la batterie ou l'appareil en dehors de la plage de température spécifiée dans les instructions. Une charge incorrecte ou à des températures inférieures à la plage

spécifiée peut endommager la batterie et augmenter le risque d'incendie.

Avertissement



Ce symbole présent sur le produit ou la boîte signifie que le produit ne doit pas être jeté avec les déchets ménagers, mais doit être déposé dans un centre de collecte approprié pour recyclage. Une mise au rebut et un recyclage adéquats permettent de protéger les ressources naturelles, la santé humaine et l'environnement. Pour plus d'informations sur l'élimination et le recyclage de ce produit, contactez votre mairie, votre service de ramassage des ordures ou le magasin où vous avez acheté ce produit.

Déclaration d'Industrie Canada

Le présent appareil est conforme aux CNR d'Industrie Canada applicables aux appareils radio exempts de licence. L'exploitation est autorisée aux deux conditions suivantes : (1) l'appareil ne doit pas produire de brouillage, et (2) l'utilisateur de l'appareil doit accepter tout brouillage radioélectrique subi, même si le brouillage est susceptible d'en compromettre le fonctionnement.

Notes sur les marques déposées

- Amazon, Echo, Alexa et tous les logos connexes sont des marques déposées d'Amazon.com, Inc. ou de ses sociétés affiliées.
- Apple et le logo Apple sont des marques commerciales d'Apple Inc., enregistrées aux États-Unis et dans d'autres pays. App Store est une marque de service d'Apple Inc., enregistrée aux États-Unis et dans d'autres pays.
- Google Play et le logo Google Play sont des marques déposées de Google Inc.
- Google Home est une marque déposée de Google Inc.

About Your RoboVac

What's In the Box

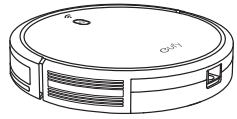

RoboVac

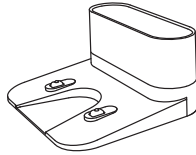

Charging Base

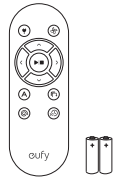

Remote Control
(AAA Battery x2)

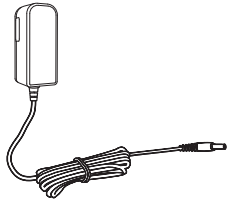

Power Adapter

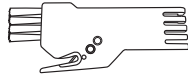

Cleaning Tool

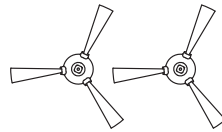

Side Brushes (x4)

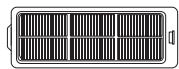

Additional Filter

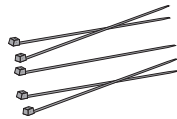

Cable Ties (x5)

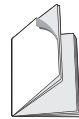

Owner's Manual &
Other Documents

RoboVac Anatomy

A. Top & Side

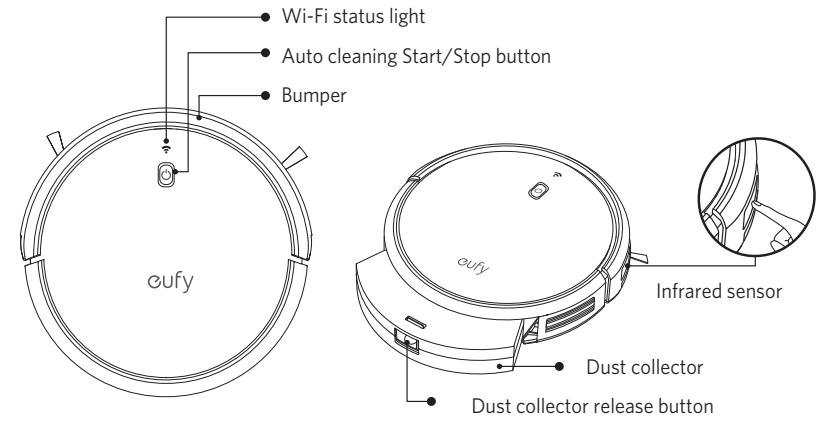

B. Bottom

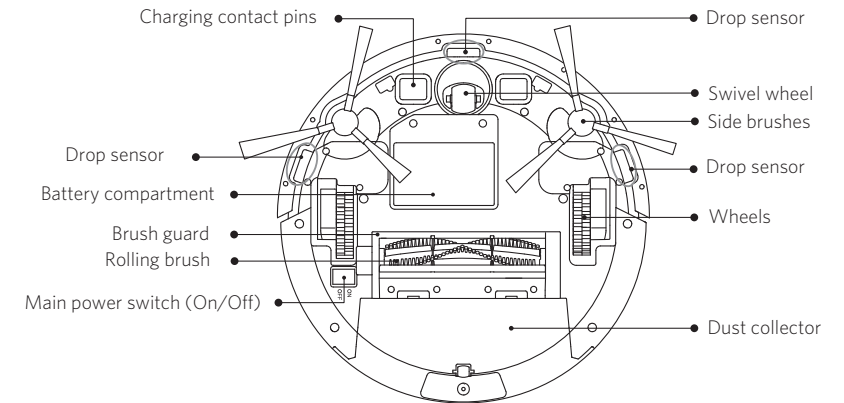

C. Dust Collector

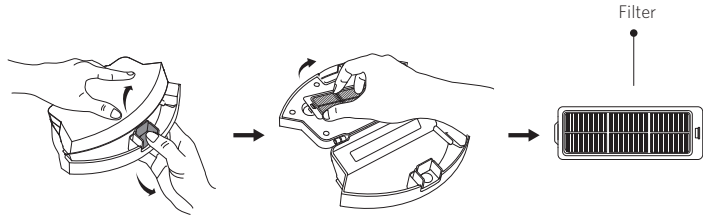

D. Suction Inlet

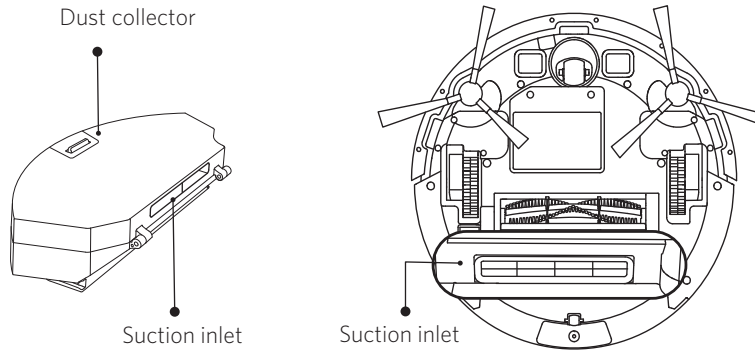

E. Charging Base

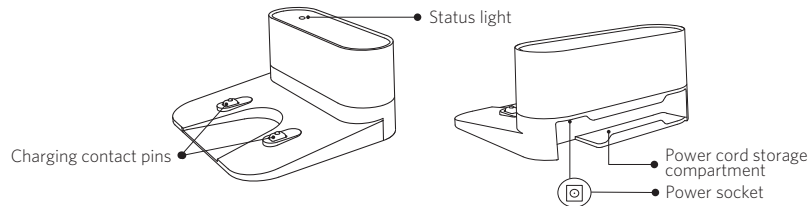

Remote Control

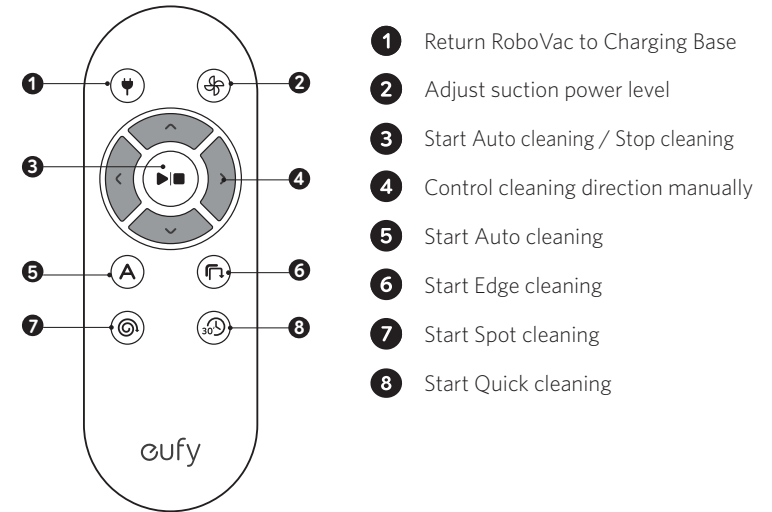

Install 2 AAA batteries before using the remote control for the first time. Make sure the positive and negative ends are facing the correct polarity direction as marked in the battery compartment.

LED Indication

You can see the status of RoboVac from the LED indicators.

⏻ (Power Status Light)	Status
Breathing orange	Charging
Solid blue	Standby / Cleaning / Fully charged
Solid orange	Low power and returning to Charging Base
Off	<ul style="list-style-type: none"> RoboVac is off. To conserve power, the light automatically turns off when RoboVac is not docked to the Charging Base and has been inactive for 10 minutes.
Flashing / Solid red + Beeping	RoboVac has an error. Refer to the " Troubleshooting>Error Tone " section in this manual for solutions.

(Wi-Fi Status Light)	Status
Slowly flashing blue	Waiting for connection
Rapidly flashing blue	Connecting with your wireless router
Solid blue	Connected to your wireless router

Using Your RoboVac

Important Tips Before Use

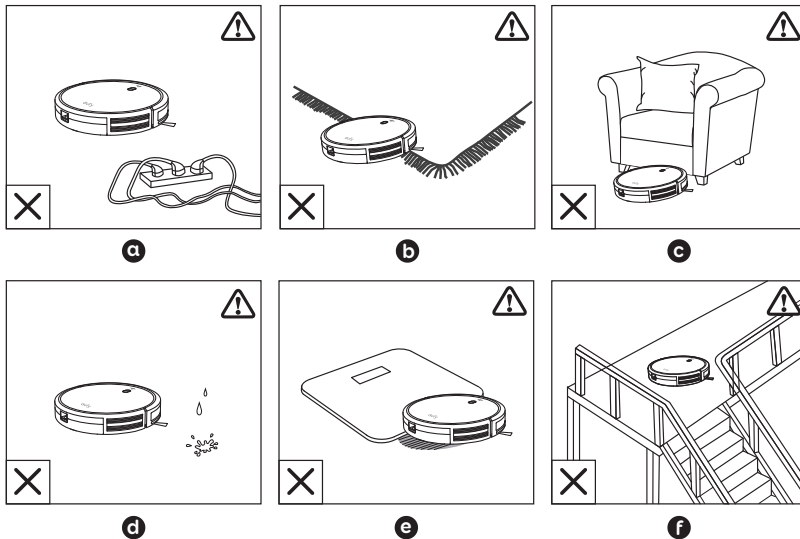

- a** Remove power cords and small objects from the floor that may entangle RoboVac. You can use the supplied cable ties to organize your wires and power cords.
- b** Fold tasseled edges of area rugs underneath to prevent tangling RoboVac. Avoid cleaning very dark-colored high-pile rugs or rugs thicker than 1.02 in/26 mm as they may cause RoboVac to malfunction.
- c** Keep RoboVac away from spaces lower than 2.87 in/73 mm to prevent RoboVac from getting stuck. If necessary, place a physical barrier to block off the problem areas.
- d** Keep RoboVac away from wet areas.
- e** RoboVac may climb on top of objects less than 0.63 in/16 mm in height. Remove these objects if possible.

- f** Anti-drop sensors can prevent RoboVac from tumbling down stairs and steep drops in most cases. They may **work less effectively** if dirty or used on carpeted/reflective/very dark-colored floors. It is recommended to place physical barriers to block off areas where RoboVac may fall.



Place physical barriers in front of fireplaces and areas that may cause damage to RoboVac if entered.

Preparation

- 1** Install the side brushes before use.

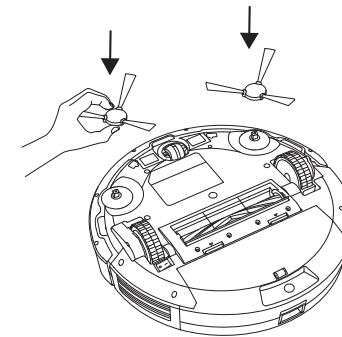

- 2** Turn on the main power switch on the bottom of RoboVac.

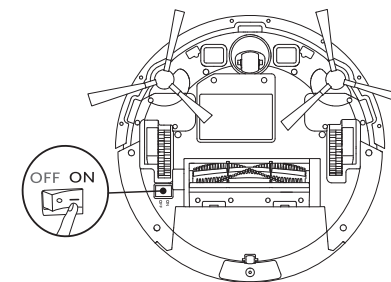

Remove the sticker next to the power switch, and the foam blocks beside the bumper before use.

3 Place the Charging Base on a level surface and against a wall.

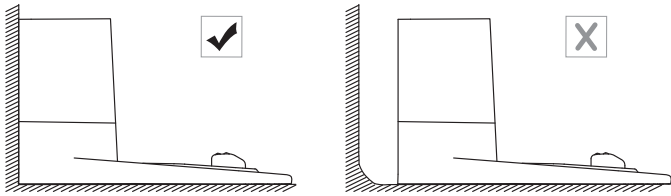

4 Remove objects within 3 ft/1 m of the left and right side and within 6 ft/2 m of the front of the Charging Base. If you cannot remove the objects, check whether RoboVac can return to the Charging Base normally; if not, contact eufy customer service for help.

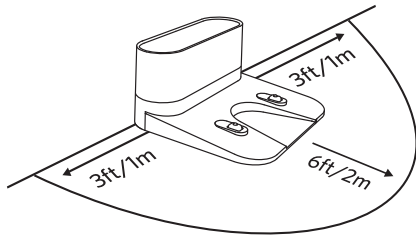

5 Connect the round connector of the adapter into the power socket on the Charging Base and the other end into a wall outlet.

- When the Charging Base connects to AC power, the LED indicator on the Charging Base is SOLID WHITE.

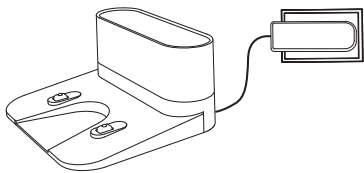



- Install the Charging Base in a location that RoboVac can easily access. It is recommended to place the Charging Base against a wall, and on a hard-level surface rather than on rugs or carpets.
- Always keep the Charging Base plugged in, otherwise RoboVac will not automatically return to it.

Charge Your RoboVac

- RoboVac has a pre-installed rechargeable battery that has to be fully charged before use.
- RoboVac returns to the Charging Base at the end of a cleaning cycle or when its battery is running low.

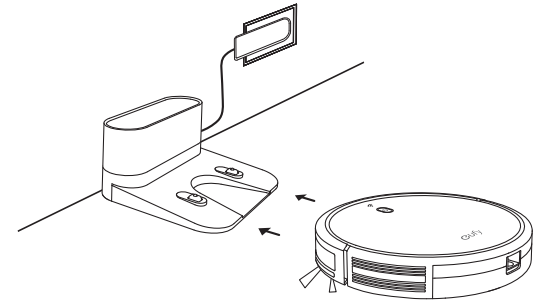
Method 1: Attach RoboVac to the Charging Base by aligning its charging pins with the charging pins on the base.



Method 2: Press  on the remote control to return RoboVac to the Charging Base.

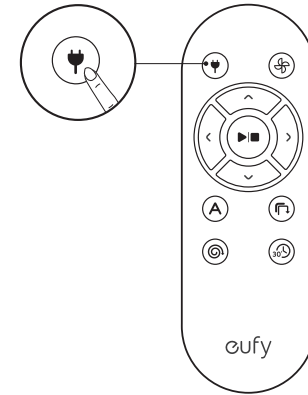

 Turn off the main power switch if RoboVac will not be used for a long period of time. To preserve the battery's lifespan, recharge at least once every 6 months.

Use Your RoboVac with the EufyHome App

To enjoy all available features, it is recommended to control your RoboVac via the EufyHome app.

Before you start, make sure that:

- Your smartphone or tablet is connected to a Wi-Fi network.
- Your smartphone or tablet is running iOS 8.0 (or above) or Android 4.4 (or above).
- The 2.4GHz band wireless signal is enabled on your wireless router.
- The Wi-Fi status light on RoboVac is slowly flashing blue.
- RoboVac is attached to the Charging Base to ensure it has enough power during setup.

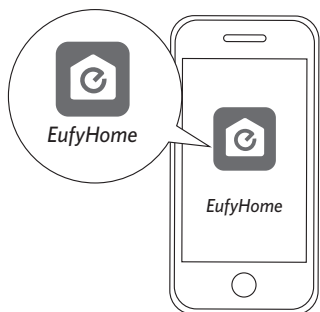

1. Download the EufyHome app from the App Store (iOS devices) or Google Play (Android devices).
2. Open the app and create a user account.
3. Tap the "+" icon to add RoboVac to your EufyHome account.
4. Follow the instructions in the app to set up the Wi-Fi connection.
 - After connecting successfully, you can control RoboVac via the app.
 - With the app, you can select a cleaning mode, set the time, schedule a cleaning, view the system status, receive notifications and access additional features.

Wi-Fi Status Light

	Slowly flashing blue	Waiting for connection
	Rapidly flashing blue	Connecting with your wireless router
	Solid blue	Connected to your wireless router

- If you have any problems during the Wi-Fi setup process, refer to the **"Troubleshooting > Wi-Fi connection"** section in this Manual.
- If RoboVac gets stuck in any space, tap **Find My Robot** in the app to find the machine. This function is available in the app only.

Restore Factory Settings

Press and hold on RoboVac for 10 seconds to restore factory settings if necessary.

- You will hear a beep when the settings have been reset and the Wi-Fi status light will slowly flash blue. Now you can follow the Wi-Fi instructions in the EufyHome app to set up the Wi-Fi connection.

Schedule Cleaning

With the EufyHome app, you can schedule RoboVac to start cleaning at a particular time.

- You can set the time and customize the cleaning schedules from Sunday to Saturday on the EufyHome app. This function is available in the app only.

Start / Stop Cleaning

- Make sure the main power switch on the bottom of RoboVac is turned on before use.
- You can also start or stop cleaning via the EufyHome app.

- 1 Press on RoboVac or / on the remote control to start cleaning in Auto Mode.

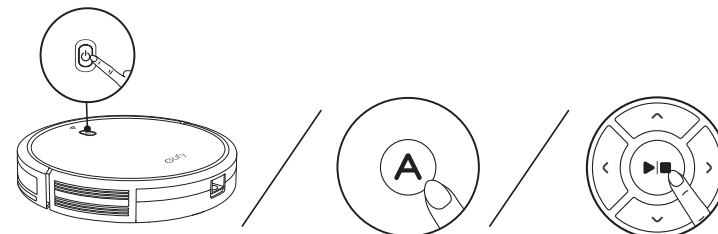

- 2 Press on RoboVac or on the remote control to stop cleaning.

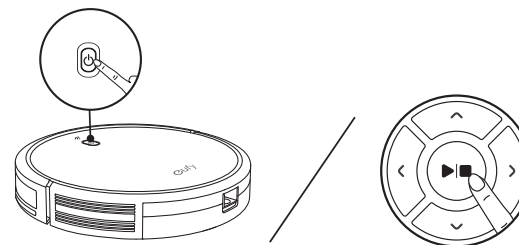

Select a Cleaning Mode

- You can also select a cleaning mode via the EufyHome app.

1. Auto cleaning

RoboVac optimizes its cleaning path by selecting different cleaning modes automatically until cleaning is complete. This is the most commonly used cleaning mode.

Press on RoboVac or / on the remote control to start cleaning in Auto Mode.

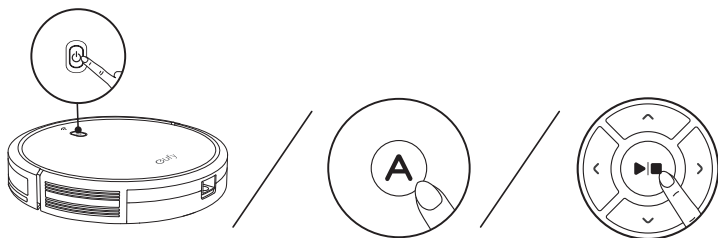

- RoboVac will return to the Charging Base automatically when the battery level becomes low or when RoboVac finishes cleaning.
- By default, RoboVac starts in Auto cleaning mode when it is turned on.

BoostIQ™ Feature

When the BoostIQ™ feature is enabled, RoboVac will automatically increase the suction power if it detects stronger power is needed to ensure the best clean. BoostIQ™ is ideal for cleaning thicker carpets and hard-to-sweep messes, which will reduce the total cleaning time, but increase the noise level. If the vacuuming noise caused by BoostIQ™ disturbs you, you can disable this feature. This feature only works in Auto and Quick cleaning modes.

In Auto or Quick cleaning mode, press  on the remote control repeatedly to adjust the suction power level.

- The corresponding icon is displayed on the remote control.

Suction Power Level	Beeps
Standard power (Default)	●
BoostIQ™ (Automatically switches between Standard and Enhanced power)	●●
Maximum power	●●●

- When RoboVac starts cleaning in Auto or Quick mode the next time, it will clean according to the suction power level you previously selected.

2. Spot cleaning

RoboVac intensively cleans a specific area in a spiral pattern, useful if there is a concentrated area of dust or debris. In Spot mode, RoboVac will stop cleaning after 2 minutes.

Press  on the remote control to start cleaning in Spot Mode.

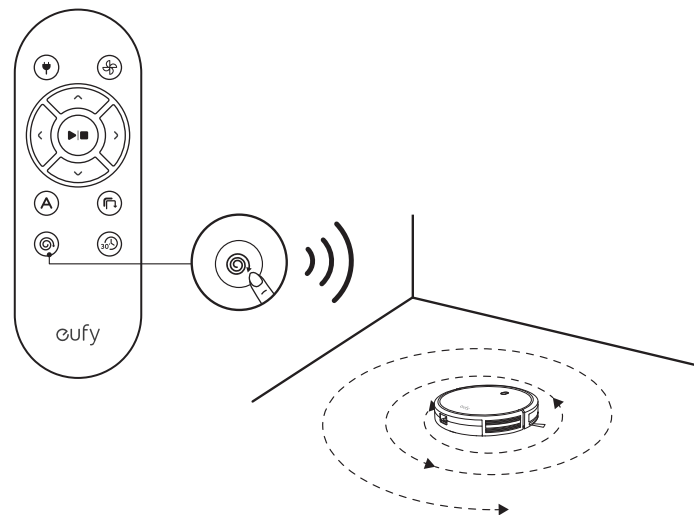

3. Edge cleaning

RoboVac reduces its speed when it detects a wall and then follows the wall to ensure the edge is cleaned thoroughly. In Edge mode, RoboVac will clean for 20 minutes and return to the Charging Base.

Press  on the remote control to start cleaning in Edge Mode.

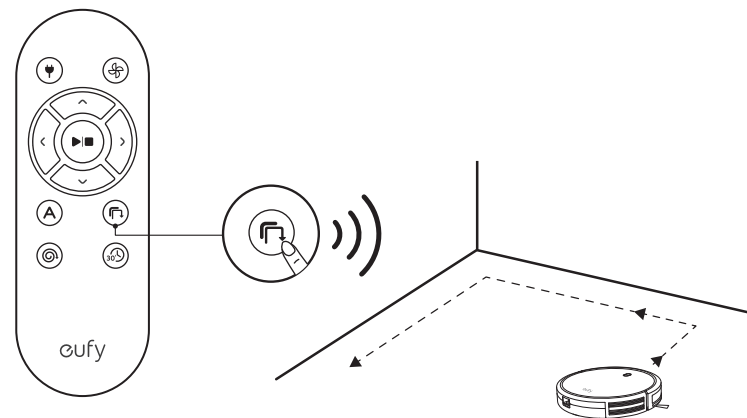

4. Quick cleaning

RoboVac will automatically stop cleaning after 30 minutes and return to the Charging Base in this mode. If any small room or area needs to be cleaned, it is recommended to select this mode to save time and power.

Press  on the remote control to start quick cleaning mode.

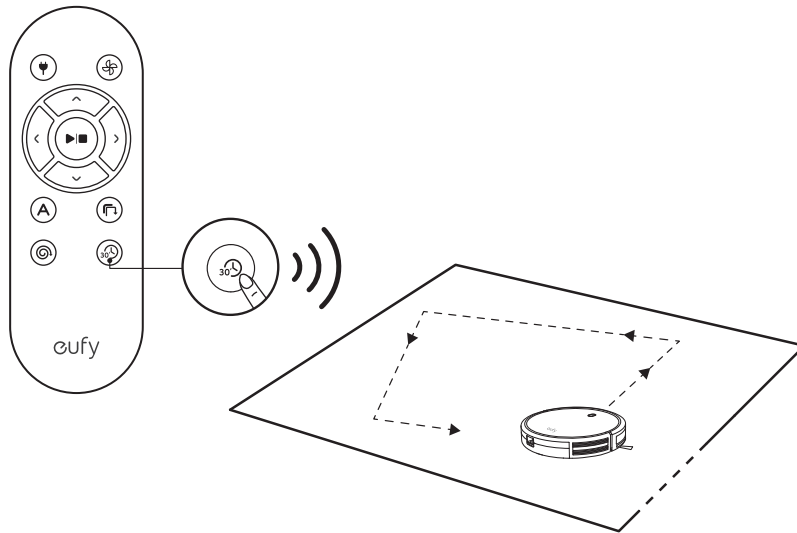

5. Manual cleaning

You can direct RoboVac to clean a particular area by using the directional buttons on the remote control.

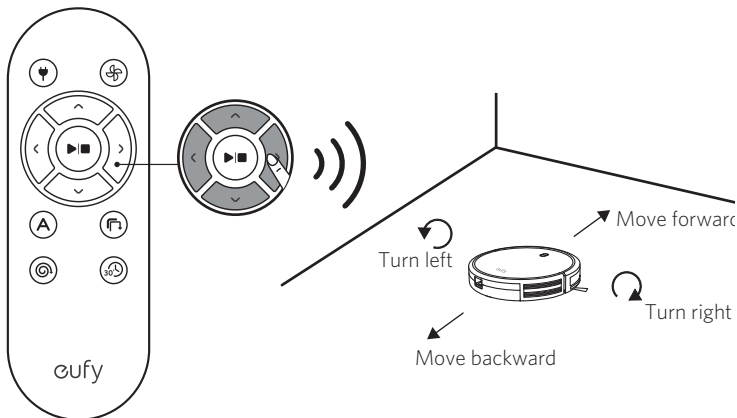

Use Your RoboVac with Amazon Alexa / the Google Assistant



Currently this feature only supports English, German, French, and Spanish. You could check regularly if more languages are supported at <https://www.eufylife.com/support/>.

Amazon Alexa or the Google Assistant is a smart voice control device that enables you to control RoboVac with your voice.

Before you start, make sure that:

- RoboVac is attached to the Charging Base to ensure there is enough power.
- RoboVac is connected with the EufyHome app.
- You have an Amazon Alexa-enabled device (i.e. Amazon Echo, Echo Dot and Amazon Tap, Echo Show, Echo Spot) or a device enabled with the Google Assistant (i.e. Google Home, Google Home Mini). These devices are sold separately.
- The Amazon Alexa app or Google Home app is already installed on your smart device, and you have created an account.

To control RoboVac with Amazon Alexa or the Google Assistant

- 1 Open the EufyHome app and find **"Smart integrations"** in the top left.
- 2 Follow the on-screen instructions to complete the setup.



For more information about how RoboVac works with Amazon Alexa / the Google Assistant, visit <https://www.eufylife.com/support/> for details.

Cleaning and Maintenance

For optimal performance, follow the instructions below to clean and maintain RoboVac regularly. The cleaning/replacement frequency will depend on your usage habits of RoboVac.

Recommended cleaning/replacement frequency

RoboVac Part	Cleaning Frequency	Replacement Frequency
Dust Collector	After each use	-
Filter	Once every week (Twice a week if you have a pet)	Every 6 months or after every 50 rounds of cleaning
Rolling Brush	Once every week	Every 6-12 months
Side Brushes	Once every month	Every 3-6 months (or when visibly worn)
Brush Guard	Once every month	Every 3-6 months (or when the silicone rubber strip on the brush guard becomes visibly worn)
Sensors	Once every month	-
Charging Pins	Once every month	-
Swivel Wheel	Once every month	-

Clean the Dust Collector and Filter

- 1 Press the dust collector release button to pull the dust collector out.

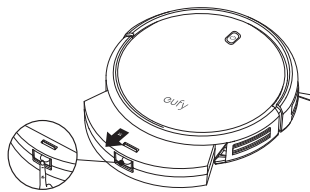

- 2 Open and empty the dust collector.

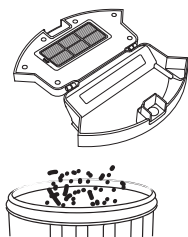

- 3 Take out the filter.

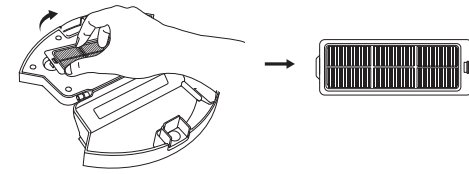

- 4 Rinse the filter thoroughly with water.

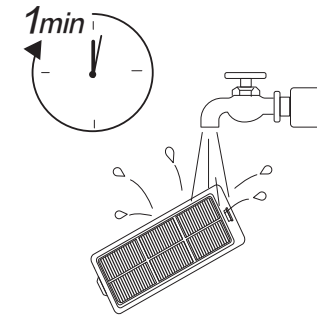

 Do not use a brush, hot water, or any detergent to clean the filter.

- 5 Air-dry the filter completely before next use. You may change to use the other filter if the original one is not completely dry.

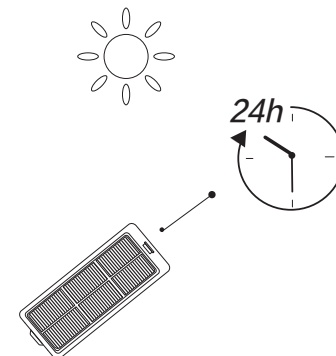

- Put the filter back into the dust collector.

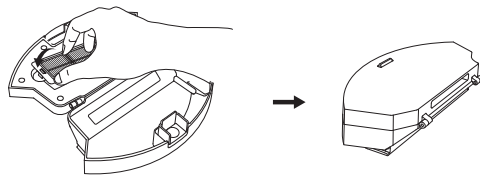

- Push the dust collector back into the main unit.

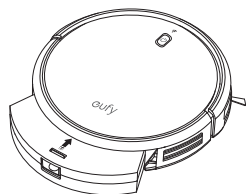

Clean the Rolling Brush

- Pull on the release tabs to unlock the brush guard as shown.
- Lift the rolling brush to remove.
- Clean the rolling brush with the provided cleaning tool or a vacuum cleaner.
- Reinstall the rolling brush by inserting the fixed protruding end first and then clicking into place.
- Press down to snap the brush guard into place.

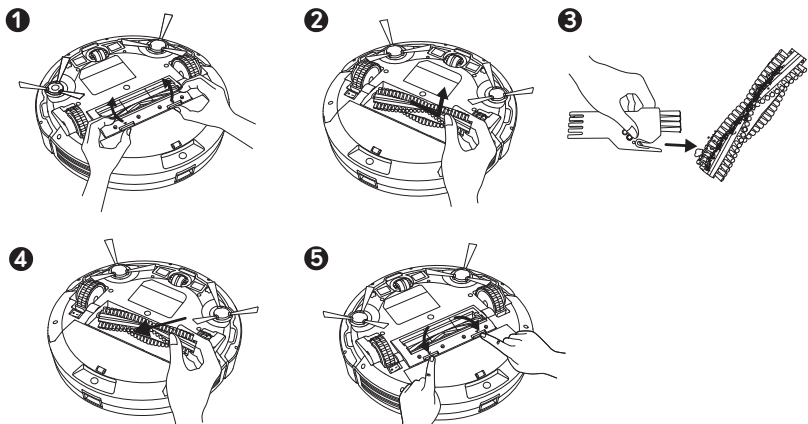

Clean the Side Brushes

Foreign substances, such as hair, can easily get tangled in the side brushes, and dirt may adhere to them. Be sure to clean them regularly.

- Remove the side brushes.

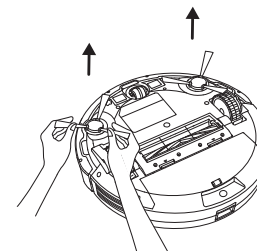

- Carefully unwind and pull off any hair or string that is wrapped between the main unit and the side brushes.
- Use a cloth dampened with warm water to remove dust from the brushes or to gently reshape them.

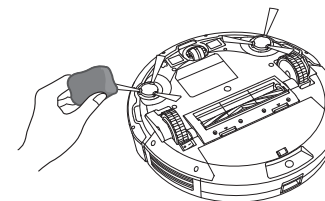

- Only use the side brushes when they are completely dry.
- To protect your wooden or carpeted floor, our side brushes are made of soft materials and may become curled after used for some time, but it will not affect the cleaning effect.

Replace the Side Brushes

The side brushes may become bent or damaged after being used for a period of time. Follow the instructions below to replace them.

- Pull off the old side brushes and snap the new ones into place.

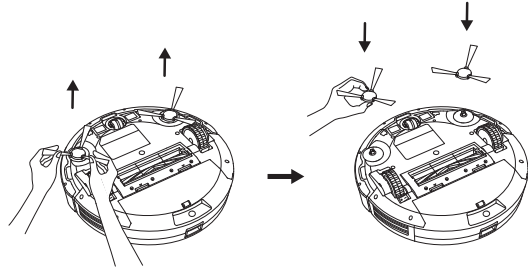

Clean the Sensors and Charging Pins

To maintain the best performance, clean the drop sensors and charging pins regularly.

- Dust off the drop sensors and charging contact pins using a dry cloth or cleaning brush.

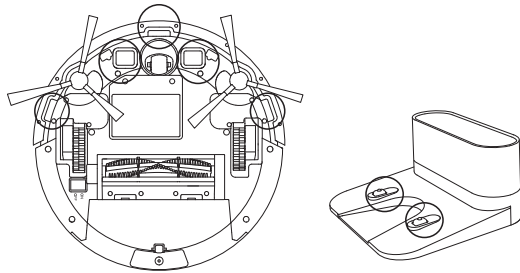

Clean the Swivel Wheel

Hair or dust particles can easily get entangled in the swivel wheel. Be sure to clean the swivel wheel periodically and as needed.

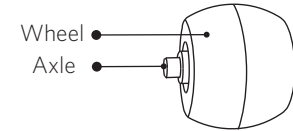

- 1 Pull out the swivel wheel.

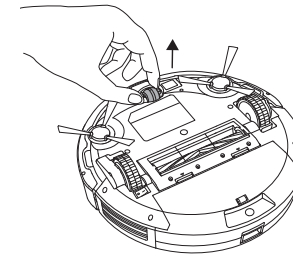

- 2 Clean any hair or debris wrapped around the wheel or entangled inside the wheel cavity.
- 3 Reinstall the wheel and push in until it clicks into place.



Do not clean the swivel wheel with water.

Troubleshooting

Problems	Solutions
RoboVac cannot be activated.	<ul style="list-style-type: none"> • Make sure the main power switch is in the ON position. • Make sure the battery is fully charged. • Replace the batteries (2 AAA) in the remote control. • Make sure the remote control is within range (16 ft/5 m) of RoboVac. • If you still have trouble, turn off the main power switch and then turn it back on.
The remote control does not work.	<ul style="list-style-type: none"> • Replace the batteries in the remote control. • Make sure RoboVac is turned on and fully charged.
RoboVac stops working suddenly.	<ul style="list-style-type: none"> • Check if RoboVac is trapped or stuck on an obstacle. • Check if the battery level is too low. • If you still have trouble, turn off the main power switch, wait for 2 seconds, and then turn it back on.
You cannot schedule cleanings.	<ul style="list-style-type: none"> • Make sure the main power switch on the bottom of RoboVac is turned on. • You can set the time of day and scheduled cleaning time via the EufyHome app. • Make sure the scheduled time has been set correctly. • Check if RoboVac's power is too low to start cleaning. • Cleaning schedules are erased when RoboVac is powered off. If RoboVac is powered on without Internet access, cleaning schedules will not synchronize and must be reset via the app.
Suction power is weak.	<ul style="list-style-type: none"> • Check if any obstructions are blocking the suction inlet. • Empty the dust collector. • Check if the filter is wet due to water or other liquid on the floor. Air-dry the filter completely before use.
RoboVac cannot be charged.	<ul style="list-style-type: none"> • Check if the indicator on the Charging Base lights up. If not, contact the eufy service center to repair or replace the Charging Base. • Dust off the charging contact pins with a dry cloth. • Check if you can hear a beep when RoboVac is docked onto the Charging Base. If not, contact the eufy service center to repair or replace the Charging Base.
RoboVac cannot return to the Charging Base.	<ul style="list-style-type: none"> • Remove objects within 3 ft/1 m to the left and right side and within 6 ft/2 m of the front of the Charging Base. • When RoboVac is in the vicinity of the Charging Base, it will return more quickly. However, if the Charging Base is located far away, RoboVac will need more time to return. Please be patient as it works its way back. • Clean the charging contact pins.

Problems	Solutions
The rolling brush does not rotate.	<ul style="list-style-type: none"> • Clean the rolling brush. • Check if the rolling brush and brush guard have been installed properly.
RoboVac's movements or travel path are abnormal.	<ul style="list-style-type: none"> • Clean the sensors carefully with a dry cloth. • Restart RoboVac by turning the power switch off and on.
RoboVac's cleaning time becomes shorter or is less than 100 minutes.	<ul style="list-style-type: none"> • Make sure RoboVac is fully charged (indicated by a solid blue LED light) before cleaning. • The cleaning time will be affected by the suction mode and floors/carpets to be cleaned: <ul style="list-style-type: none"> • Standard suction mode (on hardwood floors): approx. 100 minutes of cleaning • BoostIQ™ mode (on carpeting): approx. 60 minutes of cleaning • Max suction mode (on medium-pile carpets): approx. 40 minutes of cleaning • If your cleaning time is much less than the time mentioned above, contact eufy customer service for help.
RoboVac cannot connect to a Wi-Fi network.	<ul style="list-style-type: none"> • Make sure you entered the Wi-Fi password correctly. • Make sure your RoboVac, router, and mobile phone are close enough to ensure a strong signal strength. • Make sure your Wi-Fi router supports the 2.4GHz and 802.11b/g/n bands; the 5GHz band is not supported. For details, refer to the "Troubleshooting > Wi-Fi connection" section in this manual.
You cannot control RoboVac with Amazon Alexa.	<ul style="list-style-type: none"> • Check if there are any Internet connection problems. • Check whether you have installed the Amazon Alexa app onto your smart device and enabled "EufyHome - RoboVac" Skill in the Amazon Alexa app. For details, refer to the "Smart Integrations" page in the EufyHome App. • Make sure you have an EufyHome account and have connected to RoboVac. • Make sure you are using correct Alexa voice-commands.
You cannot control RoboVac with the Google Assistant.	<ul style="list-style-type: none"> • Check if there are any Internet connection problems. • Check if you have installed the Google Home app onto your smart device and initiated the "EufyHome" action in the Google Home app. For details, refer to the "Smart Integrations" page in the EufyHome App. • Check if you are using the proper commands when talking to the Google Assistant. When making your request, first say the wake words "Ok Google". • Repeat your question. Speak clearly to the Google Assistant.

Error Tones

When RoboVac is in trouble, it will emit a series of short or long beeps and the red indicator on RoboVac will be solid or flashing.

Flashing red indicator light

Error Tone	Cause	Solution
One beep	<ul style="list-style-type: none"> RoboVac is stuck and one of the wheels is not making contact with the floor (hanging in mid-air). RoboVac may be in an extremely large room and the bumper is not registering obstacles. 	Restart cleaning in a new location.
Two beeps	RoboVac's bumper is stuck.	Tap RoboVac's bumper several times to dislodge any debris that may be trapped underneath.
Three beeps	<p>RoboVac can get stuck in the following scenarios:</p> <ul style="list-style-type: none"> When RoboVac does not have enough power to reverse when on the edge of a staircase that is covered by a rug. When RoboVac tries to reverse due to exposure to strong sunshine, but cannot reverse due to physical barriers in the way. When RoboVac reverses due to exposure to strong sunshine, but continues to be exposed to strong sunshine after reversing for 3 seconds. 	<ul style="list-style-type: none"> Restart cleaning in a new location. Use a physical barrier to block off the problem area.
Four beeps	RoboVac's power level is too low.	Manually charge RoboVac for at least 5 hours.

Solid red indicator light

Error Tone	Cause	Solution
One beep	RoboVac's left/right wheel is stuck.	Turn off RoboVac and remove any hair or debris from the left/right wheel.
Two beeps	RoboVac's side brush is stuck.	Turn off RoboVac and remove any hair or debris from the side brush.
Three beeps	RoboVac's suction fan is stuck.	<ul style="list-style-type: none"> Turn off RoboVac, then remove and empty the dust collector. Make sure the suction inlet is not blocked by any hair or debris.
Four beeps	RoboVac's rolling brush is stuck.	Turn off RoboVac and remove any hair or debris from the rolling brush.

Wi-Fi Connection

Before Wi-Fi setup, make sure RoboVac and your Wi-Fi network meet the following requirements.

Wi-Fi Setup Requirements

- RoboVac:
 - RoboVac is fully charged and the main power switch on the bottom of RoboVac is turned on.
 - Wi-Fi status light slowly flashes blue.
- Wi-Fi Network:
 - Use the correct password for your network.
 - Do not use a VPN (Virtual Private Network) or Proxy Server.
 - Your Wi-Fi router supports 802.11b/g/n and IPv4 protocol.
 - You are using a 2.4GHz router or a dual-band router that is configured to support a 2.4GHz frequency band. RoboVac does not support 5GHz frequency band.
 - If RoboVac cannot connect to the Wi-Fi network and you are using a 2.4/5GHz mixed network, switch to a 2.4GHz network for Wi-Fi setup. You can switch back once your setup is complete.
 - When connecting to a hidden network, make sure you enter the correct network name, SSID (case sensitive), and connecting to a 2.4GHz wireless network.
 - When using a network extender/repeater, make sure the network name (SSID) and password are the same as your primary network.
 - The firewall and port settings of your Wi-Fi router allow RoboVac to connect with the Eufy servers.

Network Security Requirement

- WPA and WPA2 using TKIP, PSK, AES/CCMP encryption.



Wi-Fi Channels

- The FCC requires that all wireless devices in the United States operate on the 1-11 wireless spectrum channels.
- Some countries outside North America can use spectrum channels higher than channel 11. Refer to your local regulatory agency to determine which channels are accessible.
- A future software release will support access to channels above 11 for users outside North America. Until then, use channels 1-11.

If you cannot control RoboVac with your smartphone, try the solutions below to solve the problem. If the problem persists, contact the eufy service center for help.

Wi-Fi Status Light 	Cause	Solutions
Solid blue	RoboVac has connected to your router, but cannot access the Internet.	<ul style="list-style-type: none"> Check if your router is connected to the Internet. Check with your Internet provider to see if there is any Internet connection problem.
Rapidly flashing blue	RoboVac cannot connect to your wireless router.	<ul style="list-style-type: none"> Check if you have modified your network name and password. Reset Wi-Fi connection if necessary. Refer to the "Use Your RoboVac with the EufyHome App > Restore Factory Settings" section in this manual.
Slowly flashing blue	Wi-Fi connection is reset or has not been set up before.	<ul style="list-style-type: none"> Set up Wi-Fi connection with RoboVac. Refer to the "Use Your RoboVac with the EufyHome App" section in this manual. Reset Wi-Fi connection if necessary. Refer to the "Use Your RoboVac with the EufyHome App > Restore Factory Settings" section in this manual.
Off	<ul style="list-style-type: none"> RoboVac is turned off. RoboVac's power level is low. RoboVac is in Sleep mode. 	<ul style="list-style-type: none"> Charge RoboVac by attaching it to the Charging Base. Make sure the main power switch on the bottom of RoboVac is turned on.

Specifications

	Input	19 V  0.6 A
	Battery Voltage	DC 14.4 V
	Power Consumption	40 W
	Battery Type	DC 14.4 V Li-ion 2600 mAh
	Dust Collector Capacity	0.6 L
	Cleaning Time	Max. 100 mins
	Charging Time	300 - 360 mins

	Input	19 V  0.6 A
	Output	19 V  0.6 A

Customer Service

For FAQs and more information, please visit www.eufylife.com.

 Email: support@eufylife.com

 Live chat: www.eufylife.com

 Customer service hotline:

(US) +1 (800) 988 7973 Mon-Fri 9:00am - 5:00pm (PT)

(中国) +86 400 0550 036 周一至周五 9:00 - 17:30

(UK) +44 (0) 1604 936200 Mon-Fri 6:00 - 11:00 (GMT)

(日本) +81 03 4455 7823 月-金 9:00 - 17:00

(DE) +49 (0) 69 9579 7960 Mo-Fr 6:00 - 11:00

 @EufyOfficial  @EufyOfficial  @EufyOfficial  @EufyOfficial

Anker Innovations Limited
Room 1318-19, Hollywood Plaza, 610 Nathan Road, Mongkok, Kowloon, Hong Kong

