

THE VIRTUAL PRODUCTION FIELD GUIDE

VOLUME 1

By Noah Kadner
Presented by Epic Games

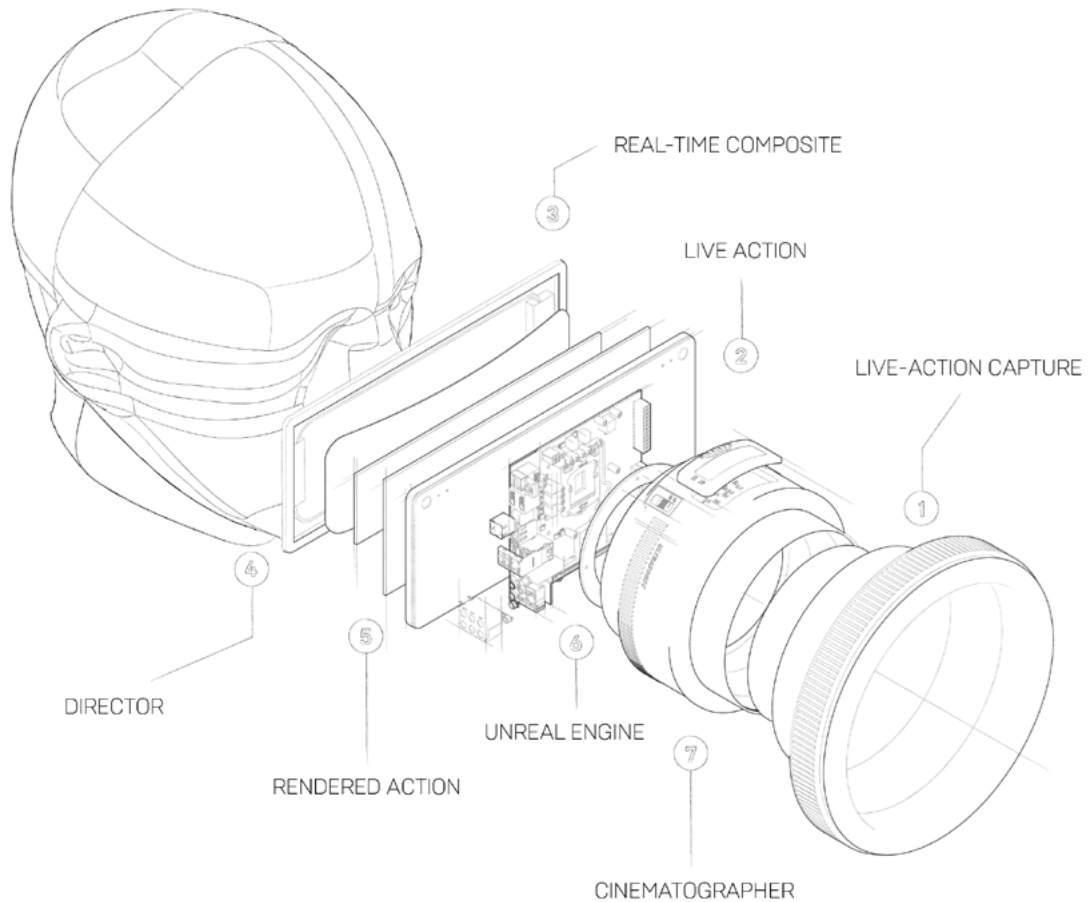

The Virtual Production Field Guide v1.3

Written by Noah Kadner

Executive Producer for Epic Games Miles Perkins

Editing Michele Bousquet, Jill Ramsay, Jodie Anderson, Jania Boyd

Layout Oliver Morgan, Jung Kwak, Kim Baskeyfield

Image Research Lewis Deans

Acknowledgments

We wish to thank all of the filmmakers we interviewed for this guide for sharing their time and wonderful insights about virtual production. We would also like to thank all of the team at Epic Games for providing additional details about virtual production and Unreal Engine including: Kim Libreri, Ryan Mayeda, Andy Blondin, Juan S. Gomez, John Jack, and Russell Paul. We would like to thank David Morin for his work chairing the Virtual Production Committee and providing guidance. We would also like to thank Jon Witmer, Managing Editor at American Cinematographer magazine. We would like to thank the geniuses over at Technicolor/MPC for additional background and virtual production definitions. We would like to thank Bree Blatchford and Paul Fleschner of Fox VFX Lab for providing additional information and illustrations. We would like to thank Rochelle Winters for lending us an objective pair of eyes. Finally, we would like to thank our families for their support and encouragement throughout this project.

Contents

Chapter 1: Introduction	01
Origins of the Real-Time Revolution	02
Who is This Guide For?	03
Definition of Virtual Production	03
The Problem and Its Solution	04
Chapter 2: Virtual Production in Detail	10
Virtual Production Types	11
Virtual Production Project Types	11
Chapter 3: Virtual Production in Action	20
Features and Benefits:	21
Virtual Production Key Features and Benefits	21
Virtual Production by Department	24
Producer	24
Producer Interview • Connie Kennedy	25
Producer Interview • Ryan Stafford	27
Director	31
Director Interview • Kenneth Branagh	32
Director Interview • Wes Ball	35
Director of Photography	38
Director of Photography Interview • Bill Pope, ASC	40
Director of Photography Interview • Haris Zambarloukos, BSC	43
Virtual Art Department	46
Virtual Art Department Interview • Ben Grossmann	47
Virtual Production Supervisor	50
Virtual Production Supervisor Interview • Kaya Jabar	51
Editor	54
Editor Interview • Dan Lebental, ACE	56
Performance Capture	59
Performance Capture Interview • Glenn Derry	60
Previs	63
Previs Interview • Felix Jorge	64
Action Designer / Stunt Coordinator	67
Action Designer / Stunt Coordinator Interview • Guy and Harrison Norris	68
Production Designer	71
Production Designer Interview • Alex McDowell	72
Virtual Imaging Technician/Grip	75
Grip Interview • Kim Heath	77
Visual Effects Supervisor	79
Visual Effects Supervisor Interview • Sam Nicholson, ASC	80
Chapter 4: Conclusion and the Future	84
What's Next for Virtual Production	85
Glossary	88
Additional Resources	93

CHAPTER 1

Introduction

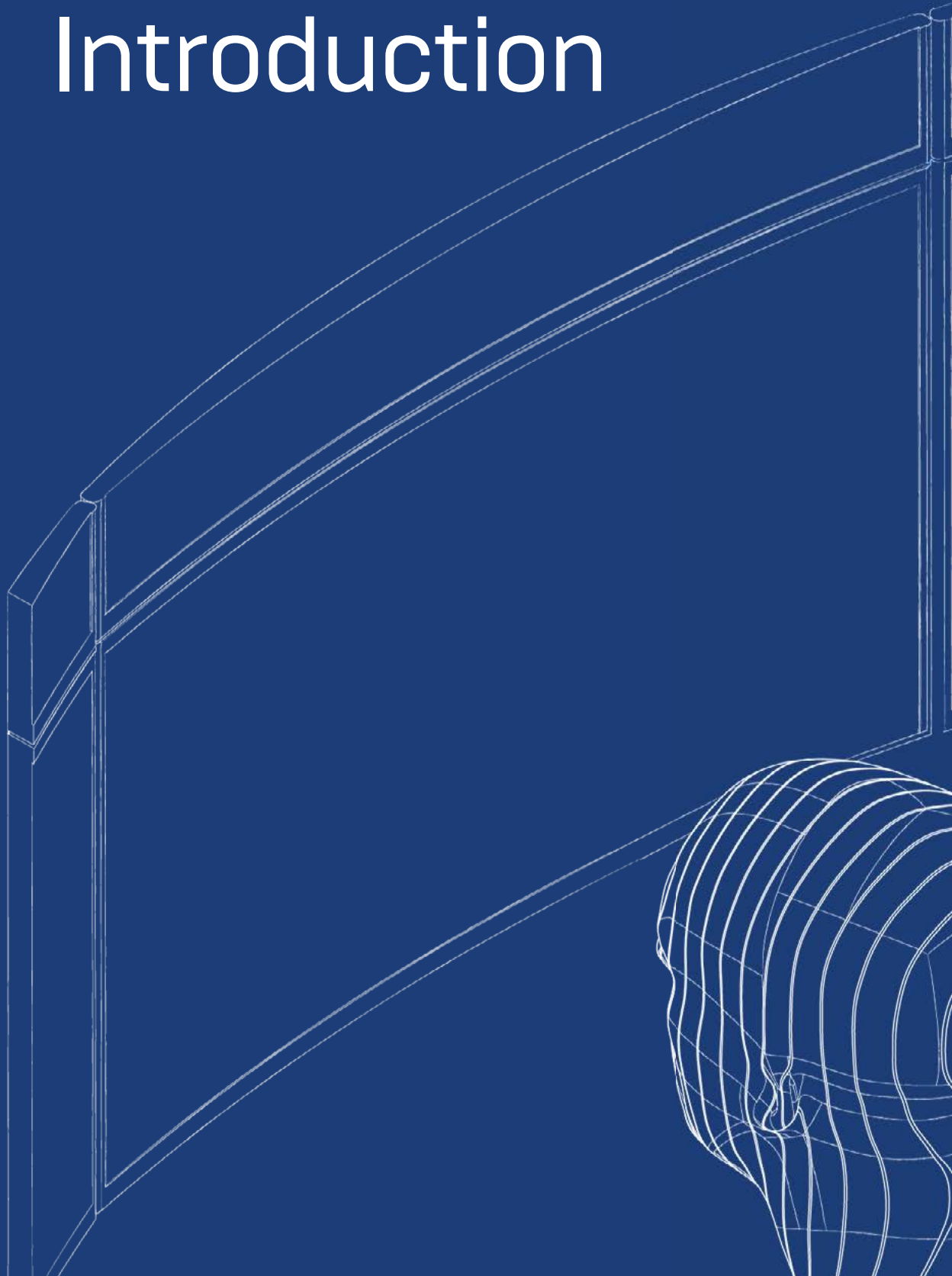



Origins of the Real-Time Revolution

Filmmakers such as George Lucas (*Star Wars: Episode I*), Steven Spielberg (*A.I.*), Peter Jackson (*Lord of the Rings*), Robert Zemeckis (*The Polar Express*) and James Cameron (*Avatar*) initially embraced virtual production enhanced by real-time rendering.

In 2009, members from the ASC, ADG, PGA, ICG, and VES formed the Virtual Production Committee.

The committee shared case studies about film and television projects leveraging virtual production and produced many of its initial definitions.

This field guide builds on the committee's work along with recent advances in real-time computer graphics, which are making virtual production even more accessible to filmmakers today.

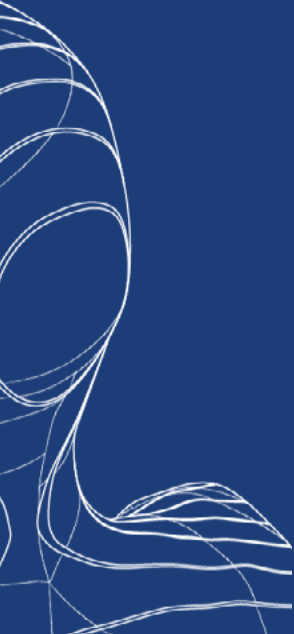



Every hour of pre-production is worth two hours of production.



ZACH ALEXANDER

Who is This Guide For?

We designed the Virtual Production Field Guide for anyone interested in or already producing projects using virtual production (VP) techniques. When we say *we*, we're talking about the team here at Epic Games, creators of Unreal Engine.

And *you* might be a cinematographer wanting to design and shoot real-time in-camera visual effects using LED wall technology. Or you may be a producer who wants to leverage real-time visualization techniques to maximize on-set efficiencies or as an alternative to a challenging location shoot. You could be a grip wishing to learn about using a dolly rig with optical encoders for filming virtual characters in a volume.

Or perhaps you're a director about to embark on a performance capture animated TV series. Or a stunt person learning how stuntvis can make your stunts even more amazing and safe. Maybe you're an indie filmmaker planning a feature and wanting to know how VP can help realize it on a modest budget. Or you could be a previs artist hoping to develop real-time assets for a virtual backlot business.

We have you all covered, and more.

In this guide, you'll learn how virtual production works, which projects have already used it, and how it can significantly enhance both the visual quality of a project and the level of collaboration and agency filmmakers have during production. You'll also find in-depth descriptions of different kinds of VP, and hear directly from the artists leveraging these techniques.

Game-changing technological advances over the years have altered and expanded the trajectory of filmmaking. These advances include sound for film, color negative stock, optical compositing, motion control, digital compositing, motion capture, virtual reality, and computer-generated imagery. We strongly feel virtual production is another game changer. We are very excited to share what we've learned about the rapidly evolving world of VP and we look forward to having you join the community.

With that said, let's get started.

Definition of Virtual Production

Virtual production is a broad term referring to a spectrum of computer-aided production and visualization filmmaking methods. To begin, here are a few notable definitions about virtual production. According to the team at Weta Digital, "Virtual production is where the physical and digital worlds meet." Moving Picture Company (MPC) adds to this definition with more technical detail, "VP combines virtual and augmented reality with CGI and game-engine technologies to enable production crews to see their scenes unfold as they are composed and captured on set."

A Filmmaker-Driven Workflow

We spoke to many different filmmakers and developers for this guide who had deeply insightful things to say about virtual production. Here are some of their quotes about the benefits of virtual production.

Epic Games' Juan Gomez defines it succinctly: "What you see is what you get." Zach Alexander, Founder and COO of Lux Machina, notes the practical benefits of virtual production previsualization techniques with his statement, "Every hour of pre-production is worth two hours of production."

Finally, virtual production studio Happy Mushroom's Founder Felix Jorge and Method Studios' Creative Director and Senior VFX Supervisor Kevin Baillie view the benefits in software development terms. "Virtual production is like making films using the agile method," observes Jorge. Baillie adds, "Virtual production is also like parallel processing. It removes the barriers between live production and visual effects, so that they can occur simultaneously instead of inline."

The Problem and Its Solution

Filmmaking is an ever-evolving artistic and technological pursuit. You need only compare silent films from the dawn of cinema with *Avatar* to see this progression clearly. Though vastly different in terms of subject matter and craft, the two extremes share a common aim of entertaining an audience with a good story. When we talk about virtual production and the benefits it offers to filmmaking, we're really talking about the next logical step in an ongoing evolution.

Most major films and TV series created today already leverage some form of virtual production. It might be previsualization, it might be techvis or postvis. We believe the potential for VP to enhance filmmaking extends far beyond these current uses.

The Problem with Traditional Production at Scale

Let's look at the challenges involved with more traditional filmmaking. Where are its pain points and how does virtual production address them? To begin with, many films today—certainly all modern blockbusters—are exceedingly complex productions featuring many moving parts on highly compressed schedules. The process is typically a linear affair, one that resembles an assembly line, encompassing development, pre-production, production, and post. Iteration is challenging and costly while development efforts are frequently siloed off from one another, with incompatible resources.



Virtual production is also like parallel processing. It removes the barriers between live production and visual effects, so that they can occur simultaneously instead of inline.



KEVIN BAILLIE

Iteration is the act of refining a process over successive attempts to arrive at a desired result. All too often, the iteration process in traditional production is wasted on finding a common starting point instead of refining an agreed-upon shared vision. Traditional production can be like learning how to play an instrument that you can't hear—you can't learn very fast when you hear the music two weeks after you hit the note. Compare that with a creative feedback loop in real time.

For filmmakers, this problem manifests itself as *uncertainty*. When a cinematographer has to take a best guess at the color of their lighting to match an unseen green screen element, or a director doesn't exactly know what the creature at the climax of her movie actually looks like, that's uncertainty. It's an overall process that feels disconnected and doesn't resolve itself until all shots become finalized. All the professional expertise brought to bear on production may not go fully leveraged in the process due to the level of visual disconnection. Finalizing occurs deep into post-production, when major iterative changes are at best highly costly and at worst impossible due to a release deadline.

When an editor is attempting to cut on action and timing for a sequence featuring in-progress visual effects, that's uncertainty. The arrival to a final version of a scene is often a long road involving replacement of temporary or missing shots, adding score, color correction, and so on. Achieving shot-to-shot continuity and fluidity is challenging with so many components in flux. All of these issues make it more difficult for the editor to arrive at the definitive version of a scene, and the result is often a film released with some degree of creative compromise.

Taking into account more traditional forms of previsualization, there is room for improvement. Previs has traditionally been created via animation software optimized for premium image quality at the cost of long render times. The process involves artists painstakingly creating versions of scenes with neither optimal image quality nor real-time malleability. As a result, the filmmakers can feel decoupled from what should be a hands-on and collaborative development process, and the true talents of department heads are not being fully leveraged.

Scale and scope of production can also be affected by traditional visual effects workflows. Although streaming and broadcast network series production values have been increasingly ambitious in recent years, they can't always match the complexity of major theatrical releases. This is due in part to cost but also to the realities of network release schedules, which only allow for a certain degree of spectacle to be created within the allotted time frame.

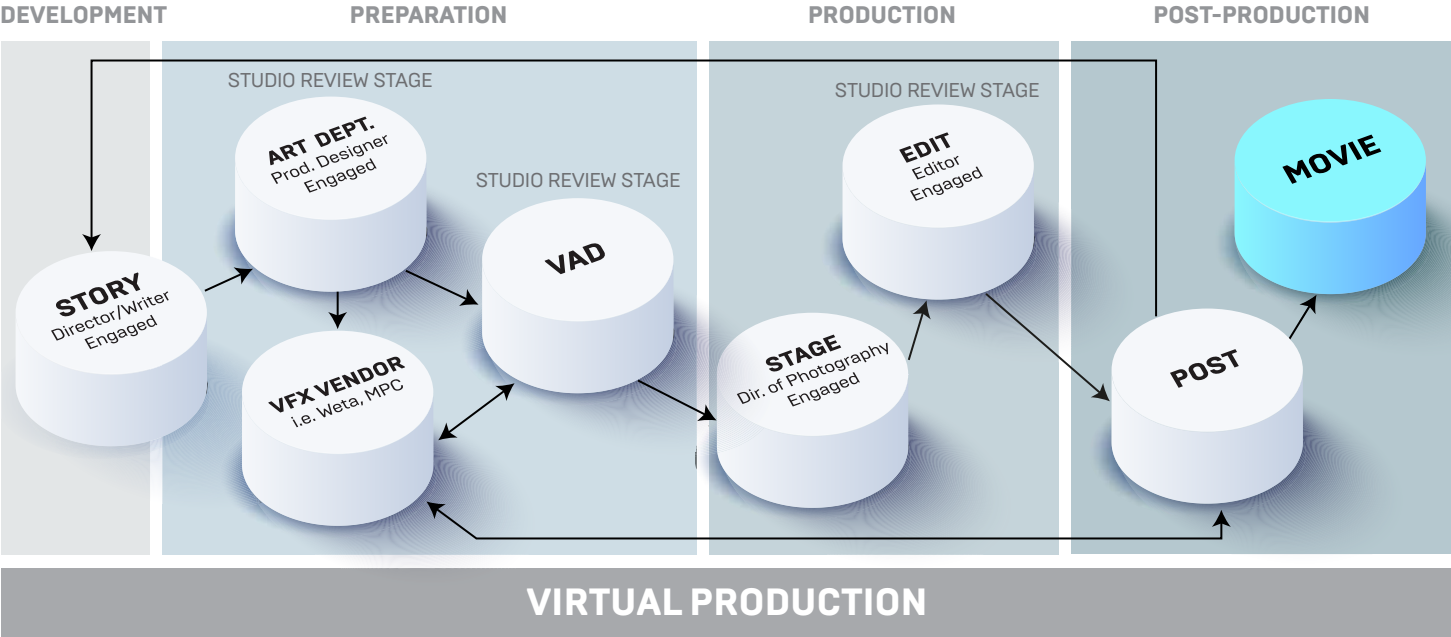
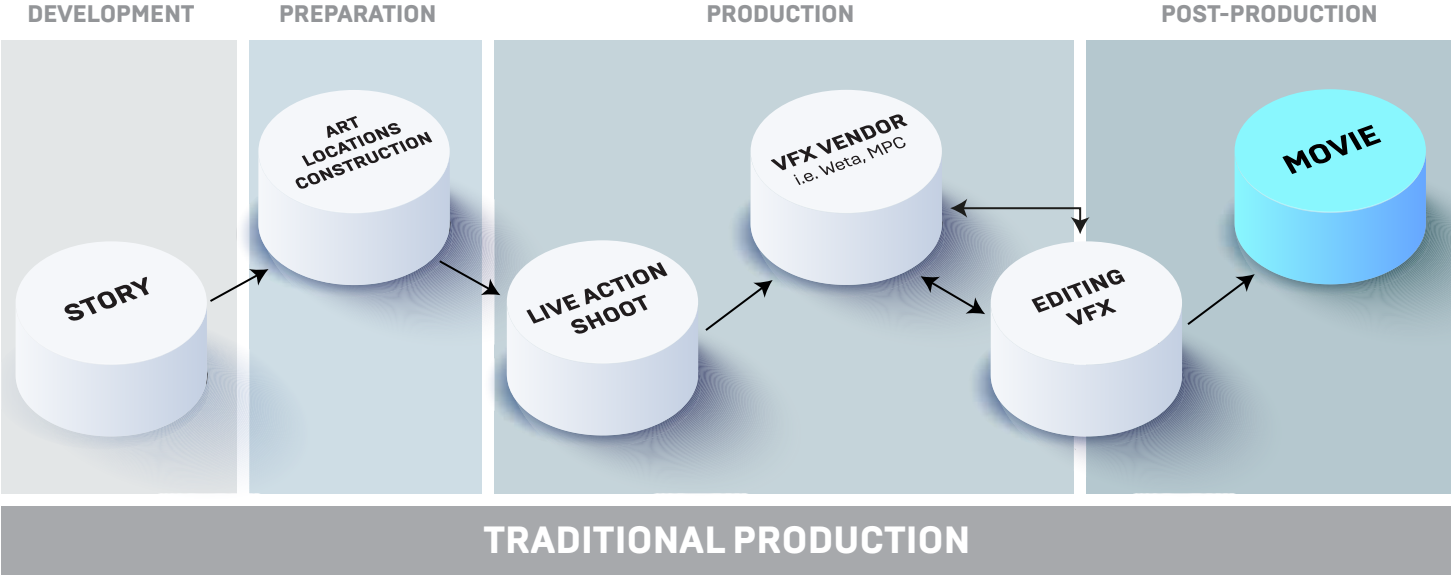

Traditional vs. Virtual Production for Film

Visual development by Fox VFX Lab

Virtual production:

- **Encourages a more iterative, nonlinear, and collaborative process.**
- **Empowers the filmmakers (including department heads) to collaboratively iterate on visual details in the moment.**
- **Means iteration begins much earlier in the production schedule.**
- **Can produce high-quality imagery from the outset.**
- **Makes assets cross-compatible and usable from previsualization through final outputs.**

How Virtual Production Solves the Problem

In contrast to traditional production techniques, virtual production encourages a more iterative, nonlinear, and collaborative process. It empowers the filmmakers (including department heads) to collaboratively iterate on visual details in the moment, not deferring all of these decisions to post. Iteration begins much earlier in the production schedule. With a real-time engine, high-quality imagery can be produced from the outset. Instead of different teams creating incompatible assets siloed off from one another, assets are cross-compatible and usable from previsualization through final outputs.

For filmmakers, the uncertainty of traditional pre-production and visual effects production are replaced with working imagery far closer to final pixel. And because this high-quality imagery is produced via a real-time engine, iteration and experimentation are simplified, cost-efficient, and agile. The process feels much more connected and collaborative. Pre-production and principal photography can be executed organically and holistically. Filmmakers and department heads are empowered to respond to discoveries of the moment. Creative decisions about shots and sequences can be resolved much earlier in production, when the entire team is present, and not left to the last minute of post-production when crews have long since disbanded.

When it comes to editorial, virtual production also alleviates uncertainty by providing provisional imagery much closer to its final appearance and helping to eliminate missing or in-progress shots. When shots that might have been previously photographed in front of a green screen are replaced with in-camera, LED wall visual effects, the editor has much more to work with. It becomes possible to edit shots and sequences featuring major visual effects the same way as traditional non-effects scenes. The editor edits during principal photography so the crew can immediately shoot pickups, or make adjustments while shooting, instead of finding out about the issues long after principal has wrapped. This has the potential to shave off days of unnecessary shooting. The result is much greater shot-to-shot continuity, fluidity, and agency over the scene. Definitive edits of scenes can be arrived at more quickly and collaboratively.

Creating previs imagery via a real-time engine unlocks additional benefits. Sequences can be quickly updated and output at very high levels of image quality. As a result, more members of the team can share the vision of the final content much earlier in production. Sets can be built to more exacting specifications with a closer match to the filmmakers' vision, stunts and special effects can be prepared in advance and executed with greater safety, and integration with visual effects can be accomplished in the most efficient and visually dynamic ways.



© 2019 Goodbye Kansas. All rights reserved.

The physics in a real-time engine play a key role in the process. Of course, it's possible to create more traditional previs via 3D animation software, but if it has any real-world physics, such animation has to be precalculated and can't be changed on the fly as it can with a real-time engine. Previsualization and visual effects teams can also collaborate directly, playing in the same sandbox with shared assets and a unified pipeline because real-time assets and final effects shots can leverage the same base model.

All of these efficiencies and increased image quality offer a trickle-down effect to more modest and tightly scheduled productions. By leveraging virtual production techniques with a real-time engine, network series, streaming productions, and indies can all achieve very high-quality imagery and epic scope. A real-time engine has the potential to eliminate many of the bottlenecks of budgeting, schedule, and development time that can prohibit smaller-scale productions from producing imagery on par with blockbusters.

CHAPTER 2

Virtual Production in Detail

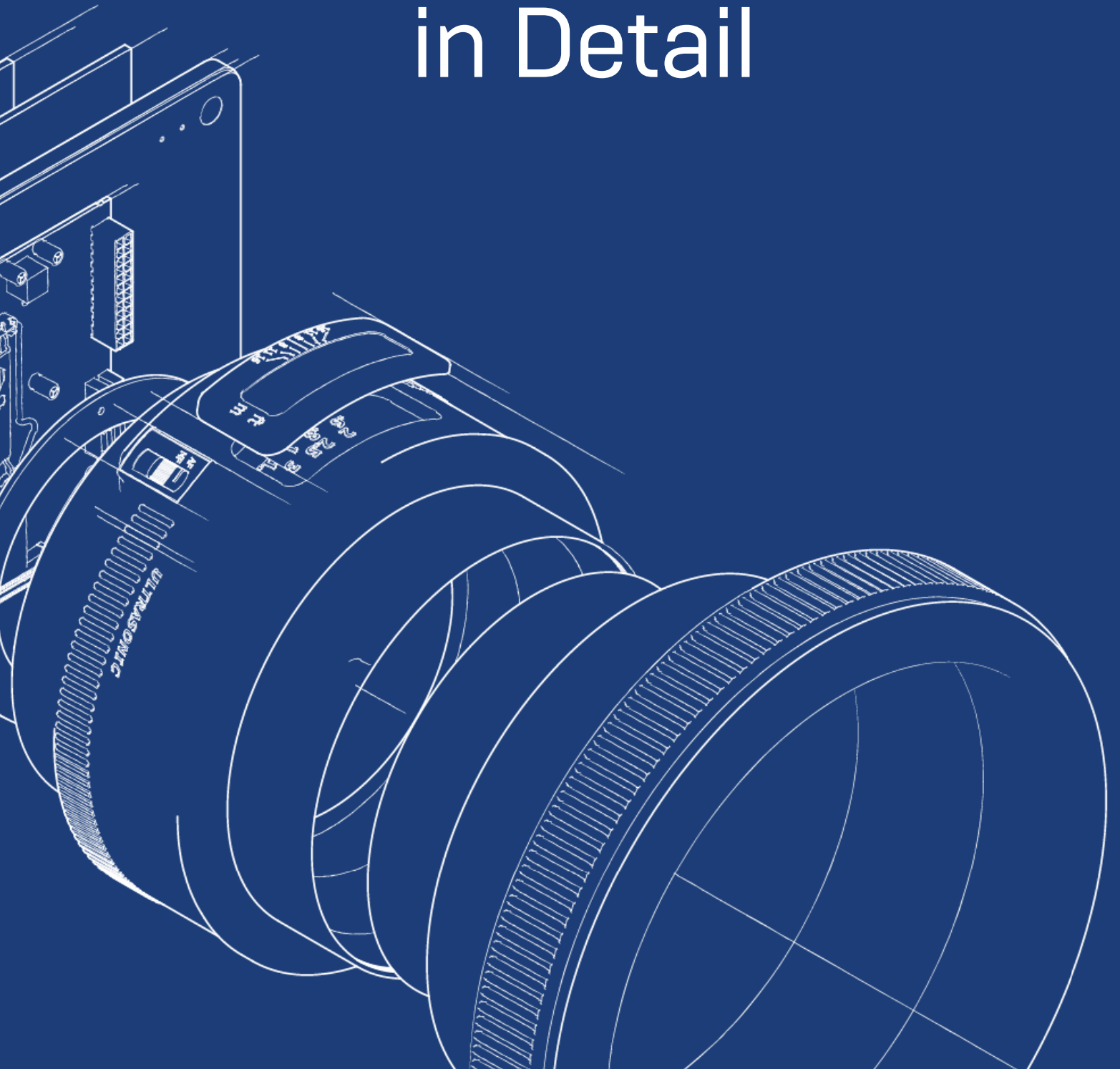

Virtual Production Types

We're surveying many different types of virtual production, all of them sharing the common denominator of a real-time engine such as Unreal. So, let's dive in and define the various methods of virtual production and also look at some historical examples of each. They include visualization, performance capture, hybrid virtual production, and in-camera virtual production. Knowing all of the types of virtual production will help you to fully appreciate the benefits and uses of each for a potential production.

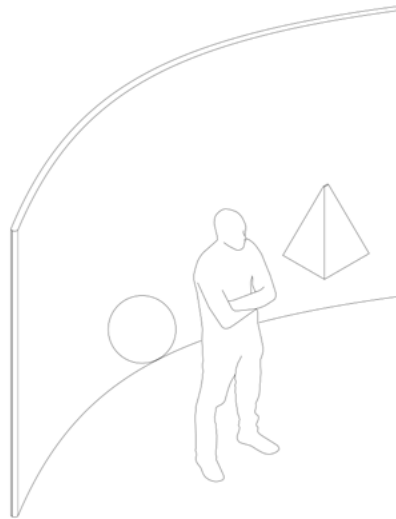

Visualization

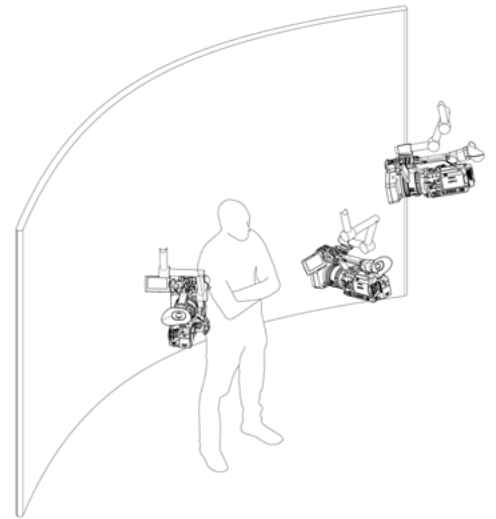

Performance Capture



Hybrid Green Screen Live

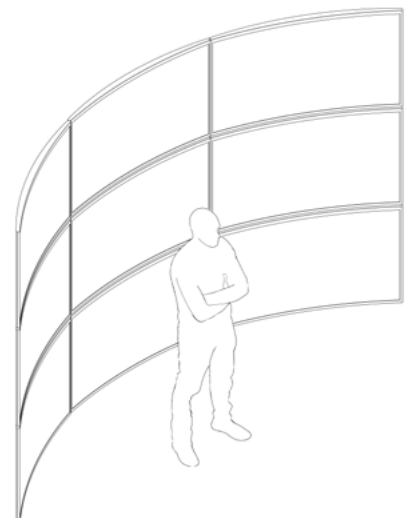

Full Live LED Wall

Visual development by Fox VFX Lab

Visualization

Visualization is probably the virtual production use case most filmmakers are most familiar with. We can define visualization as *prototype imagery created to convey the creative intent of a shot or sequence*. Visualization can take the form of pitchvis, previs, virtual scouting, techvis, stuntvis, and postvis. Let's take a closer look at each.

Pitchvis is imagery created to help an in-development project earn a greenlight from a studio or gain interest from would-be investors. Pitchvis might include specific signature sequences from the proposed project or an overall trailer to help convey the filmmakers' creative intent. Some examples of movies which were greenlit in part due to a trailer created as pitchvis include *Godzilla (2014)*, *Men in Black 3*, *World War Z*, *Jack the Giant Slayer*, and *Oz: The Great and Powerful*.

Previs is the most widely-recognized form of virtual production, as it's regularly presented in behind-the-scenes clips and in before/after visual effects presentations from popular movies. Previs can include music, sound effects, and dialogue designed to approximate the look and feel of final sequences. The advantage of previs is that it enables filmmakers to experiment with different staging and art direction options such as lighting, camera placement and movement, stage direction, and editing without incurring the higher costs of actual production.

Storyboards and animatics are both precursors to previs. From the earliest days of his career, George Lucas has been a major proponent of previsualization. He edited together clips from old World War II aerial dogfighting movies to convey his intentions to the visual effects artists on the original *Star Wars*. Later, Lucas' visual effects company Industrial Light & Magic (ILM) pioneered the use of 3D animation software to previs effects shots on *Jurassic Park*. Today, it's rare to find a major motion picture which doesn't deploy previs in some capacity.

Virtual scouting presents a completely digital version of a location or a proposed set which crew members can interact with. The interaction might take place in an HMD (head-mounted display) or simply on a computer screen. The VR version of virtual scouting can include repositionable props and virtual cameras with lenses which can be used to plan out shots, define set builds, and/or shoot entire sequences without building a single flat. It also enables filmmakers to focus on specific areas of importance and filter out areas of less importance to avoid creating assets that won't be used. To date, many films have involved virtual scouting as part of their pre-production process.

Techvis is the combination of virtual elements with real-world equipment for the process of planning shots as well as combining already captured footage with virtual assets. It is also the area where camera moves, camera placement, and lens choices can be validated, mitigating the risk of physically implausible virtual choices.

For example, on the first *Avengers*, techvis was used to help plot out animation for explosions captured partially on set and later greatly expanded via visual effects during post-production. The techvis helped determine the explosions' shape,

volume, and rate of expansion relative to the camera movement to help ensure that the visual effects added in post would integrate believably with the live-action footage. Techvis is generally more concerned with physics and specific camera data for use of the effects artists, and less so with visual fidelity or usage in an evolving edit.

Stuntvis is a type of techvis tailored specifically to the planning of stunt work. Stuntvis is usually guided by the stunt coordinator or action choreographer. It includes the development of scene blocking, choreography, stunt testing and rigging, set design, prop and weapon concepts and—in conjunction with the director of photography—camera placement and movement, together with lighting setup. By leveraging the real-world physics simulation available in real-time engines, stunt coordinators can directly translate digital results into the real world. “Stuntvis has multiple purposes,” says Chris Clements, a stuntvis artist whose credits include Netflix’s *Daredevil*, *The Punisher*, and *Pacific Rim Uprising*. “It’s used to sell the director and producers on the vision, to work out certain beats before a shoot to make sure they play correctly to camera and, most importantly, to act as a souped-up storyboard that can be referenced by multiple departments.”

Postvis involves the creation of imagery merging live-action elements with temporary visual effects, or the creation of new CG shots to provide placeholders for editorial. For example, Halon Entertainment provided postvis shots on *War for the Planet of the Apes* by adding temporary versions of CG apes as well as military vehicles and artillery into many live-action plates, along with fully CG shots for shots intended to be completely CG. Postvis provides the director and editor more visually developed scenes to guide their work, especially for sequences with partial sets and in which visual effects drive the story. It also functions as a visual communication tool for the director to communicate with the visual effects team.



Image courtesy of The Future Group

Postvis combines already captured live action with visual effects in progress to help guide post-production.

Performance Capture

Motion capture is the process of recording the movements of objects or actors and using that data to animate digital models. When it includes the actor's face and more subtle expressions, it's often referred to as performance capture. Body capture is accomplished by the actor wearing a suit covered in markers that are tracked by special cameras or a suit with built-in sensors. Facial capture involves using either depth-sensor cameras for markerless facial capture, or tracking markers drawn directly onto the performer's face.

Performance capture can be accomplished on a traditional set where virtual characters are intended to interact within real-world environments. Simulcam is a technique where a virtual camera is synchronized to the movements of a real camera in the physical world. Simulcam is often used to superimpose virtual characters over the live action in real time and aid in framing and timing for the crew.

Or if the film is entirely animated, the capture process occurs on a specially designed performance capture stage called a volume. A capture volume has the added advantage of decoupling the camera from the performance. That is, once the motion data has been captured from the actors, the scene can then be re-animated from any camera perspective desired.

Although the performance capture process is advanced and refined, it has its roots in 2D rotoscoping, where the actors are filmed in scenes and then animation is hand-traced to match their actions. Many animated Disney films used forms of rotoscoping and it was also used extensively in the animated films of Ralph Bakshi. Performance capture can take the form of facial capture and full-body animation.



Performance capture in progress for Robert Zemeckis' "Welcome to Marwen".



Image courtesy of Tencent and Epic Games, Inc.

Facial capture is performance capture concerned primarily with capturing the facial performance of the actor. This data is used to transfer their performance to another character either human or non-human. Although full-body animation often includes facial capture, sometimes facial capture alone is required or can be done separately from the body performance. Some recent examples include Tarkin from *Rogue One* and *The Curious Case of Benjamin Button*.

Full-body animation transfers the entire movement of an actor onto another character. This usually involves some form of retargeting or scaling, specifically if the animated character is of a markedly different body geometry compared to the actor. Some popular examples of full-body animation include *Avatar*, Gollum from *The Lord of the Rings*, the dolls in *Welcome to Marwen*, and the most recent *Planet of the Apes* series.

Hybrid Virtual Production

Hybrid virtual production is the use of camera tracking to composite green screen cinematography with CG elements. This is created either as a live preview for the director of photography and the camera operator, and completed in post-production, or is intended as final pixel in camera. This type of virtual production has been used for a while for live broadcast, especially in sports, but has also proliferated increasingly into feature and episodic production. The two primary modes of hybrid virtual production are real-time and post-produced.

Real-time hybrid virtual production on green screens first appeared in broadcast news weather reports, where the weather person is chroma keyed live over a map with the forecast. These results are typically of passable quality with a locked-down camera and never intended to approach feature-level quality. That said, the quality of solutions has improved greatly in recent years with the addition of faster GPUs and real-time engines. For example, the Zero Density system leverages Unreal Engine to produce live-to-air composites for a variety of news and entertainment shows. Users of Zero Density for real-time virtual production in studio broadcasts include FOX Sports, Canal +, RTL, TFI, and Sky News.

Post-produced hybrid virtual production uses camera tracking data to provide a live, in-camera composite image when shooting green screen. The live composite is typically at a proxy resolution and meant as a reference to block out the shot while capturing/filming the actors and props in front of the green screen. It is meant to help the director, director of photography, and camera operator gain a better spatial understanding of virtual elements such as CG characters and set extensions so that visual effects in post are better integrated. An advanced version of this approach was used to create *The Jungle Book*. This technique has also been popular in recent episodic TV series such as *Revenge*, *Pan Am*, *Once Upon a Time*, and *American Gods*.

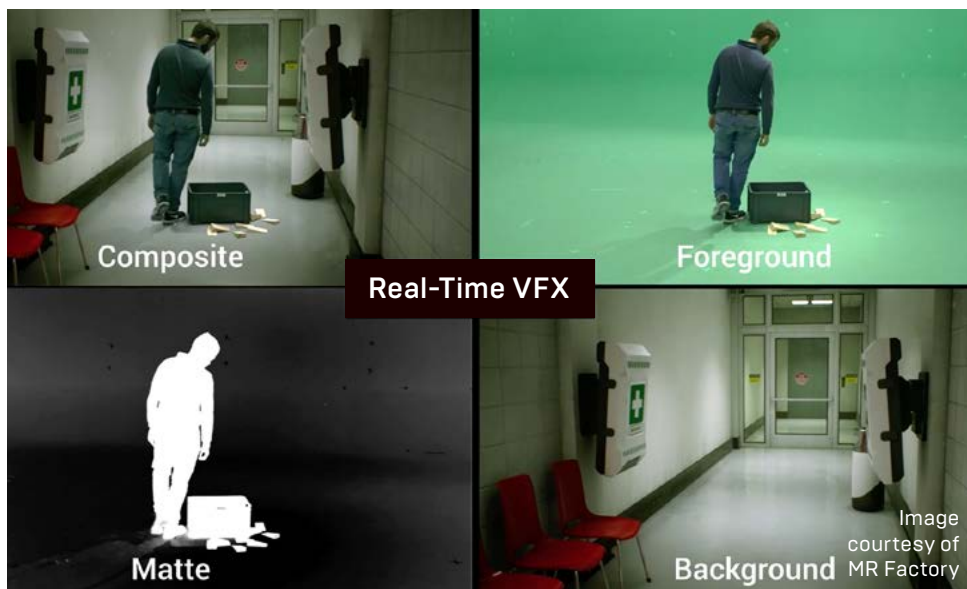

Post-produced hybrid green screen virtual production uses Simulcam and camera tracking to make live-action production more interactive.

Live LED Wall In-Camera Virtual Production

The use of image output from real-time engines to a live LED wall in combination with camera tracking to produce final-pixel imagery, completely in camera, represents the state of the art for virtual production. The benefits of live imagery projected behind the actors are massive. In some respects, it's also the culmination of all of the previous development work done in the sphere of virtual production.

Compared to green screen cinematography, there is no uncertainty for cast or crew. Everyone can see exactly what is in the shot as it unfolds in real time. The camera operator can frame as they would any real object and the actors can react not to a marker representing an imaginary image, but the actual final imagery live in front of them. All of the natural reflections and lighting from the screen provide important artistic cues and enhance the realism of the imagery, compared to the typical struggle to avoid contamination from the green screen's color spilling onto the subject as well as creating unwanted reflections.

To be clear, the concept of projecting live imagery behind the actors to photograph effects in camera is not new. Rear projection effects via film projectors date all the way back to the 1930s and were regularly used for vehicle driving shots, and to expand studio-bound productions. The drawback is simple—a fixed perspective that has to be carefully planned around to avoid a visual discontinuity between the perspective of the projected footage and that of the live-action camera. Introvision was a notable update to rear projection which allowed for more camera movement and greater interaction between the foreground and background, although it still did not solve the parallax issue because the footage being projected was still locked into a specific angle. Some notable films over the years which used film projector front or rear projection include *The Wizard of Oz*, *North by Northwest*, *2001: A Space Odyssey*, *The Fugitive*, and *Terminator 2: Judgment Day*.



Image courtesy of Epic Games

Live LED wall virtual production creates final-pixel imagery in camera.

A precursor to live LED projection via real-time engines is the projection of pre-rendered or live-action footage. This technique achieves a high level of image quality and immersion, with the only exception being that the perspective is fixed and does not shift in relation to the camera's movement. Thus, it is still limiting in terms of shot design and blocking, and is generally best suited to objects that are some distance from the foreground action in order to help minimize the lack of parallax. Some recent projects which have leveraged pre-rendered projection for in-camera effects include *Oblivion*, *Murder on the Orient Express*, *Solo: A Star Wars Story*, and *First Man*.

The quantum leap of using a real-time engine to create imagery for LED wall projection is that unlike rear-projecting pre-rendered footage, the imagery shifts in perspective, creating perfectly synchronized parallax to the camera. As a result, the imagery is so believable, it's difficult to tell where the live action ends and the screen takes over. There are a number of projects currently in production which we're not at liberty to name at the time of writing. But we're incredibly excited by their advances and can't wait for you to see the results for yourself.

Virtual Production Project Types

Now let's look at some specific examples of projects well suited to virtual production. We don't mean to imply by this assertion that virtual production is limited to certain project types. On the contrary, there isn't a script out there that couldn't conceivably take advantage of virtual production techniques. In fact, the most unlikely of films—if designed correctly—can take advantage of virtual production.

Fully Animated Virtual Productions

Virtual production in the form of performance capture has already massively changed the way many animated films are produced. To understand this, we should take a few steps back to consider the history of animation. In many of the early hand-animated films, animators used a variety of reference footage to achieve more lifelike animation.

Rotoscoping is the practice of tracing over frames of live-action footage to create realistic movement. The process was originally invented in 1915 by Max Fleischer, whose Fleischer Studios went on to apply the technique to animated characters such as Betty Boop, Popeye, and Superman.

Disney used a variation of this process by filming actors enacting scenes for reference and then using that to guide the movements in animation, though not traced precisely frame by frame. The technique enabled the animators to achieve an overall lifelike motion while not being rigidly tied to the live action footage. The Disney rotoscoping process was used on films like *Snow White and the Seven Dwarfs*, *Alice in Wonderland*, *The Little Mermaid*, and many others.

We mention rotoscoping in particular because performance capture is its virtual production equivalent, in which the motion of an actor's body and face

are accurately sampled for transfer to digital characters and environments. With performance capture, animated films gain much more realistic and lifelike animation, and do so far more rapidly and cost-effectively when compared to manual animation processes. Performance capture is often combined with virtual cameras, where the filmmakers create camera moves using real camera rigs or other virtual control devices as tracking devices to record the movement of the camera, which can then be replicated in the CG environment.

Some specific examples of fully animated films and series created via performance capture include: *The Polar Express*, *Beowulf*, *Tintin*, *Word Party*, *Zafari*, and *The Lion King*. Many companies specializing in CG animation, such as Pixar, Dreamworks, and Illumination, still feature characters animated through manual keyframe animation.



Image courtesy of The Future Group

A frame from a fully animated virtual production.

Live-Action Virtual Productions

Virtual production has been used to plan or directly enhance imagery in a variety of major motion pictures. Typically, virtual production is more common on visual-effects-driven movies, but can also include effects enhancements to more traditional or non-effects films.

Major visual effects films of the past decade have come to rely the most on virtual production, and that reliance is increasing steadily. Virtual production helps from the planning phase in the form of pitchvis and previs. It continues on for performance capture, stuntvis, techvis, and postvis. Some examples of major motion pictures heavily reliant on virtual production include Disney's Marvel movies, *Avatar*, *Star Wars*, *The Lord of the Rings*, *Jurassic World*, *Pirates of the Caribbean*, *Harry Potter*, *Transformers*, and many others.

Of course, we should broaden our perception to encompass projects that are not necessarily effects-driven but still rely heavily on virtual production. These are films that leverage virtual production to portray an impossible situation or setting with veracity. Some examples include *Rent*, *Jarhead*, *Life of Pi*, *Mad Max: Fury Road*, *Logan*, *Bohemian Rhapsody*, *Welcome to Marwen*, *Rocketman*, and more.

CHAPTER 3

Virtual Production in Action

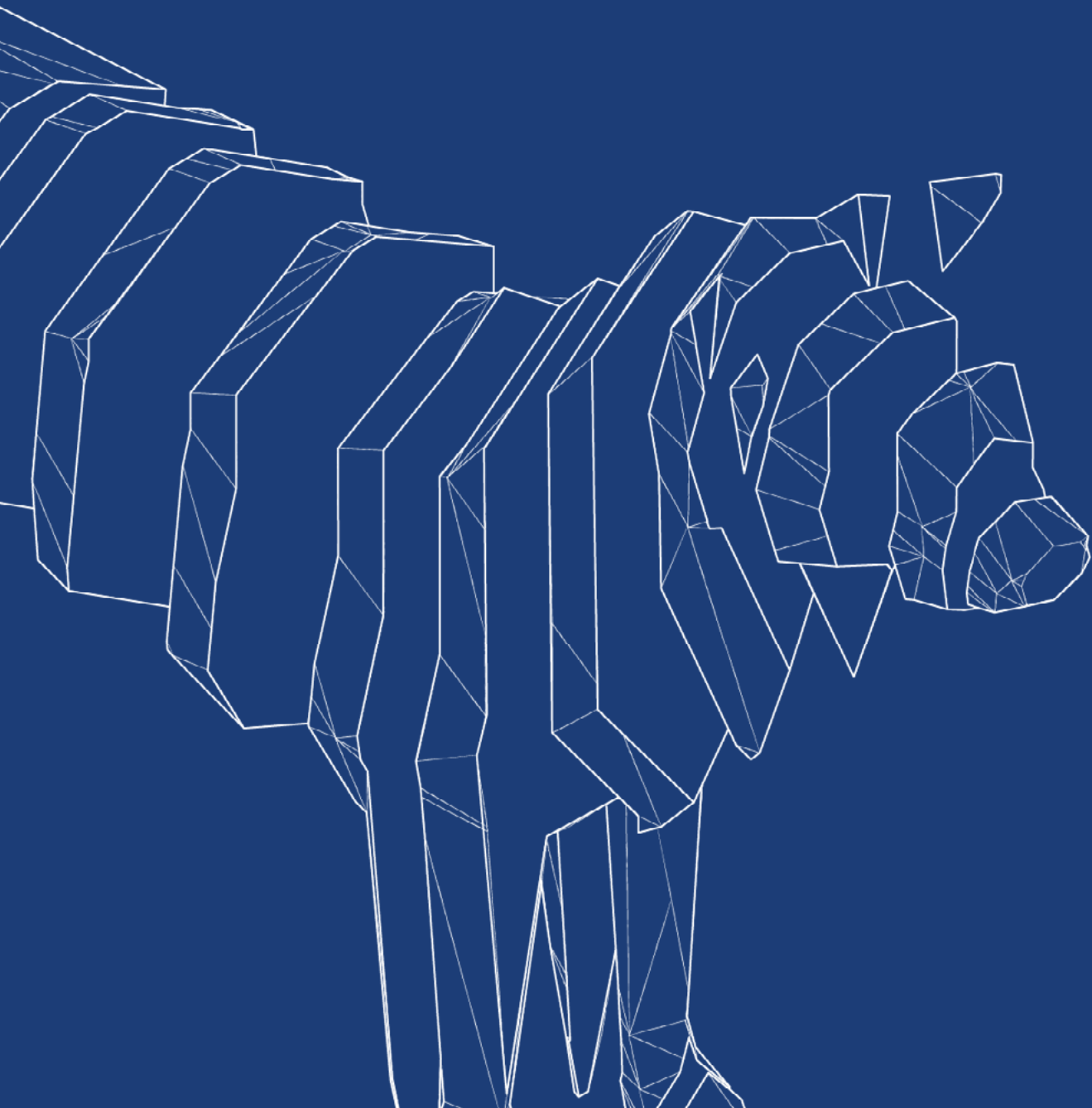

Features and Benefits:

- **Asset creation**
- **High-quality assets**
- **Real-time engine**
- **More malleable tools**
- **Remote/multi-user collaboration**
- **Real-time physics**
- **Distributed rendering**
- **Real-world camera movement**
- **Asset tracking and data management**
- **Avoiding budget creep**

Virtual Production Key Features and Benefits

Now that we've defined virtual production and where it's being used, let's take a quick look at the benefits a real-time engine offers filmmaking in general. Later, we'll go department by department with specific workflows and benefits.

One area in which VP offers great benefits is asset creation. The more effort put into creating an asset both in terms of visual fidelity and real-time efficiency, the more it can be used from previs to final pixel without having to recreate the desired object at additional cost and loss of time. **Level of detail (LOD) control** and decimation of assets is built directly into the engine to enable the same high-quality source asset to be decimated enough to work in real time at the desired frame rate, while still preserving the visual fidelity.

Also, because high-quality assets are part of the equation, additional business opportunities to create digital backlots and prop houses can benefit long-form productions through economies of scale and give rise to new service providers. These same production assets can be quickly adapted and delivered to ancillary pipelines to create screen-accurate promotional imagery, game assets, and toys. And this can be done without the need to rebuild the asset for each application, both saving time and avoiding the quality/consistency issues that can result from rebuilding.

A real-time engine offers more malleable tools and can be customized to fit the filmmaker because it's always in an active state of development. If you as a DP decide there's a particular set of framing lines you always want to see in the virtual scouting image, the engine can be easily customized for you. Or if you would like to see a certain kind of visual effect in your set, it can be added and re-used.

Remote/multi-user collaboration on a traditional movie set might typically consist of a remote video feed or screen share. A real-time engine, because of its roots in gaming, already has "multiplayer" remote collaboration and communication capabilities deeply integrated at its core. So it is possible, for example, to share remote virtual scouting sessions as well as allow participants to control and participate in performance capture sessions directly and collaboratively.

Real-time physics are another benefit which comes from a real-time engine's gaming origins. This means you can create stunts and check camera movement trajectories not just theoretically but with real-world physics simulation. You can also create animation for previs and final pixel with much more realistic physical effects, without having to invent them from scratch.

Distributed rendering is not a new concept to visual effects animation and may conjure up images of massive server rooms chugging away on frame-by-frame rendering. For real-time engines, distributed rendering can be leveraged in real time to increase both the performance of animations and their resolution. Having multiple instances of the engine in parallel and outputting in tandem to a video scaler means that live in-camera visual effects can go beyond 4K and even 8K image resolutions to deliver stunning image fidelity.



Image courtesy of Quixel

Real-world camera movement for enhanced realism can also be leveraged in virtual production. Because everything happens in real time, many other aspects previously relegated to post-production can be photographed live. Compositing can also be done live so that it can be assessed during production on set rather than deferred to later in the post-production schedule. Indeed, the embrace of virtual production can shift the entire crew's mindset from "fix it in post" to "fix it in pre" and "fix it in production."

Avoiding budget creep in post with increased levels of collaboration is an added benefit of virtual production. Because the imagery is created in a malleable real-time engine instead of being baked into more traditional modeling and animation pipelines, completed takes can continue to be refined and updated in post without losing excessive time or money.

Asset tracking and data management are always constant struggles with home-grown tools often created out of necessity to deal with the amount of assets and their versioning during a production. A real-time engine, due to its roots in programming and scripting, is designed from the ground up to precisely track and version all kinds of assets, turning a previously difficult challenge into a built-in feature. In short, all of the strengths that come "for free" as part of a real-time engine also have significant benefit and utility to movie productions.



Asset Creation/Decimation of Assets/Virtual Backlot



Malleable Tools/ Fit to Filmmaker

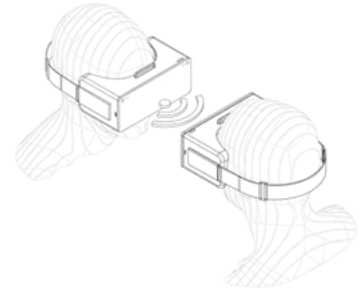

Remote/Multiuser Collaboration

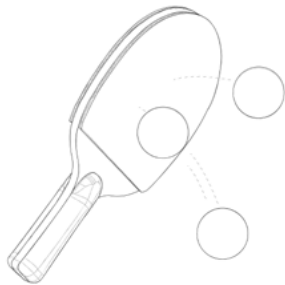

Real-Time Physics Engine

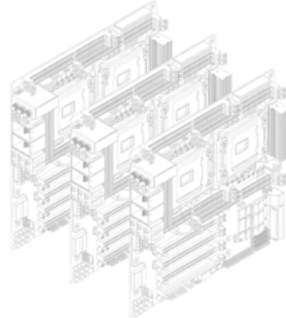

Distributed Renders: Scaler + Unreal



Capture Real-World Camera Movement

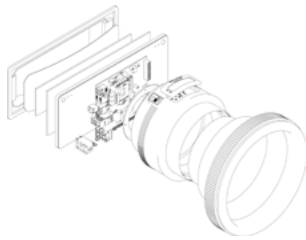

Real-Time Compositing

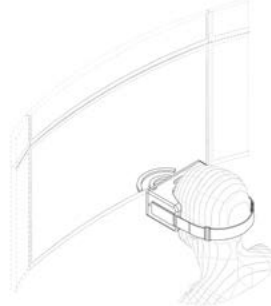

Live LED Walls

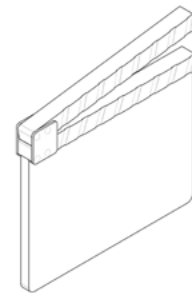

Live Production Mindset vs. "Fix it in Post"

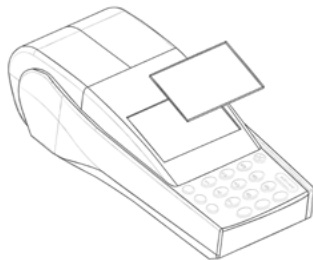

Avoid Budget Creep in Post

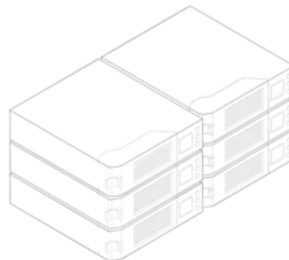

Asset Tracking/ Data Management

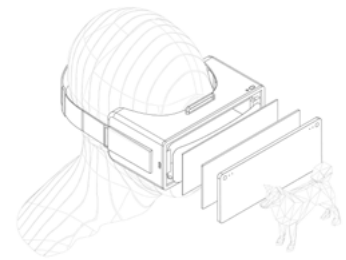

Assets to Games/Toys/ Products etc.

Virtual Production Workflow Features

Visual development by Fox VFX Lab

Virtual Production by Department

Now that we've defined virtual production, shared where it's being used, and understood its general benefits, let's look at how VP benefits key departments on a project. From the producer and the director of photography to the editor and the visual effects supervisor, and many departments in between, virtual production is highly impactful.

Producer

As a producer, you stand to gain tangible benefits from virtual production. Real-time engines enable image fidelity of such a high level that it's entirely possible to previsualize an entire film during preparation to the degree that it can be shown to test audiences without any caveats. This approach enables you to workshop concepts, explore a story's dramatic cohesion, and increase engagement with studios, all at a very affordable cost compared with actually shooting and post-producing a film..

You're already accustomed to working with more traditional forms of previs during project development. For example, you've likely worked with conceptual and storyboard artists to attempt to communicate a project's style and feel, above and beyond the script. You've also likely worked with previs animation to communicate complex action sequences during pre-production.

The advantages of a real-time game engine for a producer include higher-image fidelity and increased malleability. As an entire scene runs in real time, making changes to angles or actions is much easier than having to re-render frame by frame. You gain much more flexibility. Time is money, and virtual production, by its real-time nature, will save you both. The result is increased ability to refine concepts, so production time is spent realizing a well-conceived script rather than rewriting and developing during production when every moment is highly costly.

A live LED wall for complex visual effects scenes, in lieu of more traditional green screen, also provides a number of benefits to you as the producer. By creating an entire scene live on an LED screen, visible both through the camera and to the actors on set, your team entirely avoids "green-screen fatigue." This can occur when the cast and crew become inured to looking at the same flat-color screen for long periods and creatively disengage from the story. Instead, a live LED wall gives everyone clear visual context, keeping them as engaged as they would be on a location shoot.



Producer Interview • Connie Kennedy

Connie Kennedy is an executive producer at Profile Studios. Profile specializes in providing industry-leading performance capture and virtual production services for film, games, and episodic content. Kennedy's credits as a virtual production producer include *War of the Worlds*; *The Adventures of Tintin*; *Star Wars: The Force Awakens*; *Thor: Ragnarok*; *Welcome to Marwen*; and *Avengers: Endgame*.

Watching virtual production evolve over the years, what do you see as some of its chief benefits to a producer?

I think one of the most important things is that they're going to get a volume of work that they probably wouldn't get otherwise because they would have to wait too long, and it would just be prohibitively expensive. Most directors that we have that come in, they've got a very experienced visual effects team. They're surrounding themselves with people who have a technical level of experience that they can rely on and that they trust.

That collaboration is crucial. You have to have great people on both sides, then you need an art department or what we call a virtual art department (VAD) that understands the virtual production process, so that they can build accordingly. And that takes a very specific type of skill. There are increasing numbers of people in both VFX companies and production companies that are working in collaboration with people doing large visual effects movies, where they can work together collaboratively with both the virtual and physical production.

What's the learning curve for filmmakers new to virtual production?

I think there's a couple of things going on when somebody comes in and it's a new process to them. We don't want to throw them into a situation where they're just in the frying pan and they're trying to figure it out. We want to come in, and first of all, do a lot of listening as to what it is they're trying to do.

And then we're going to talk to them about methodology and how to get there. The challenge is to try to not get in the way of what they already know how to do, which is to get the best performance out of their actors, and we need to facilitate that.

As long as a director understands that's what you're trying to do, it allows them to remain in charge and focused on the things that matter most to them and not be distracted with trying to figure out something that may or may not enhance what they're doing. In other words, they don't want to feel like they're handing off the final product. They want to feel like they're still in control of that. And so the trick for us is to make sure that we are constantly serving them and their interests.

Looking to the future of virtual production, where do you see potential business opportunities?

LED video wall technology is really exciting for everyone. We're a company that stands outside of the big visual effects companies. Most virtual production is happening at places like ILM, MPC, or Weta. And there are a few of us that are trying to do as much as we can with very few people, as an independent group.

But we're never going to get away from working with these different companies and we have set ourselves up to be able to use systems where we can collaborate effectively with anyone we work with. So we don't have to change anything about what we're doing, they don't have to change anything about what they're doing, and we can integrate processes seamlessly.

I think the exciting thing is to be able to continue to work together where different companies are focused on different aspects of virtual production, then we can come together and do something that none of us can do on our own. And I think the continued fraternity between all of these different companies is really important to moving this forward. There's always competition but I find that there's also always been a lot of collaboration in the field of virtual production, and I don't see that changing. All of us are constantly sharing ideas and moving forward and benefiting from each other's research and development. And I think the exciting thing is that virtual production is embarking on being able to recreate reality. It's scary and it's exciting, all at the same time.



Producer Interview • Ryan Stafford

Ryan Stafford is an executive producer and visual effects producer. His credits include *Call of the Wild*, the *Planet of the Apes* trilogy, and *Avengers: Age of Ultron*.

What are your areas of responsibility as a producer?

I service two roles: my credit on the movies is executive producer, and my background is visual effects. I'm the visual effects producer and all the responsibility that therein lies. But I also have more overall responsibilities as well, including creative and areas that span far outside of visual effects.

How has virtual production evolved over the years?

Previously, previs and simple rendering via Giant software or doing a Maya render, for example, was informing your animation and camera work but little else. When you're using Unreal, it can also inform the lighting and art direction. You get more of a cinematographic perspective on your film and not just the mechanics, so you get to see how it works creatively.

For *Call of the Wild*, we previsualized the entire film before we shot it via Unreal and could show that previs version to a test audience. We added voice actors and music, and since Unreal Engine created a visual quality that people could relate to, we were able to show it and get real notes and story points before we went to camera.

Were the primary characters motion captured?

Our movie's a bit of an interesting puzzle because the main characters are fully CG dogs. They're supposed to act and behave like real dogs, and they're not talking, they're not anthropomorphic. It's like the best-trained dog you've ever seen. So anytime that the dog is alone in a scene, the environment is entirely CG. Anytime the dog is with humans, the humans were photographed on a real set, with various representations of where the dog would be so that we could add him in successfully later.

When we were doing capture in prep, we were capturing the humans, but since our humans were meant to be later photographed, that mocap data was purely for previs purposes only and was then thrown away. We have done motion capture for dogs, but since dogs are dogs, they only do certain things at certain times. It might take dozens of motion capture takes to build one piece of action.

Did you previs everything or only key sequences?

The studio certainly had an appetite to previs the whole thing. Once we started getting up and going, we realized that we weren't going to have an extended prep time that would allow for that. At that point, we had done about 40 minutes of the film, and they asked us to go ahead and finish the rest of it as previs. And we did. We ended up getting 15 bonus weeks of visual development and prep to allow us to finish that previs version of the movie.

How did the previs test audience go?

It was an audience of private friends and family mainly to validate some of our decisions and get some fresh-eyed feedback and the ability to see the entire movie put together. The screening gave us a lot of insight on how to proceed with the story and figure out a complex technical shoot. This became the game plan for what was approved by the studio and taken into production.

Do you see virtual production becoming more prevalent?

For the right film, it's a hugely successful way to go. I wouldn't do it for every drama or superhero movie that's so contingent upon action and camera work and discovery on the day, but for something that has such a substantial virtual component or a hybrid type of film, I think it's a critical way to go. Seeing that the filmmaker can get behind the process, I worked with directors that don't click with the traditional previs process because they find their moments on set looking through a camera and working with their actors.

For the human actor side of things, it was much more efficient. We could sit in a space, tape out our set and our major set pieces within that set and say, "OK, so you get up and go over there, and you sit down in that chair," and so forth. The director can work with mocap actors, stage a scene, and mocap the entire piece of action. Then we have this master animated select and can lay virtual cameras down. So there's a tremendous efficiency and consistency.

As it relates to camera work, you get a much more organic camera feeling. In previs or keyframe camera work of any kind, you get a very computerized, mechanical movement to it. On the other hand, if you have an actual operator handling the virtual camera, you get something that feels more traditional and truer to what a camera does. You can use all the same grip equipment that camera operators are used to—gear heads, fluid heads, cranes—and you can put all that into a mocap stage and get very organic camera work.

How involved was your cinematographer?

On *Call of the Wild*, Janusz Kamiński, ASC was our director of photography, and we could show him the previs and say, “This is the layout.” And then he would get into the set with the actors and, once we’d block out and everything, he would find what the best shot was at that moment. So the previs at that point functioned merely as a guide to say, “We need to get this minimum coverage.”

Within those setups, Janusz had full creative reign. Or he could say, “Hey, I got this idea. Even though the previs has a scene in these six shots, I want to do it in one gorgeous Steadicam shot.” And we were like, “Great, let’s do that,” and then we would block it out. Many of those shots surpassed what we had in the previs.

Was Janusz also involved in virtual lighting?

He set up the lighting since the lighting was driving all of our on-set work and lighting our actors. And then we would ask him, “Hey, if we were to do this, how would you set up the lights?” In certain circumstances, we had a live dog on set as a stand-in, and he’d throw up some quick lights and say, “Hey, this is how I’d light the dog.” So, when we’d shoot the shot in CG, we could match his lighting. Finally, many of our all-CG shots are using his guidance as heavy motivation for how we light.

What are the benefits of a real-time engine?

There is instant satisfaction, where you can make real-time lighting decisions, and you can see the immediate results of those without having to wait days for the render. Therefore, you’re saving a ton of energy on building real sets and having huge crews and vast amounts of equipment and so on, which allows the creative world to blossom.

How do you see virtual production evolving?

I easily see it becoming a point where you’re working at such a high level of quality that you could take it right off the stage and put it into the cut and into whatever your form of distribution is, Netflix or theaters or so on. I think that’s not that far, maybe 5 to 10 years away. Eventually, you’ll only be limited by the filmmakers’ imagination, and then you can see the results right then and there with the bonus of being able to tweak things after the fact.

Computing power is always a pain point. If your worlds are too heavy, if you have too many atmospherics, you have too much vegetation that’s blowing in the wind or any of these factors, the world gets weighted down so significantly that you can’t get it in as many frames as required for smooth playback. In order to get it up to a respectable frame rate, it takes a ton of computing power and a ton of decimating the world into a place where you can have some of the bells and whistles that make it great to look at, but losing a lot of other things to make it lightweight enough to have real-time playback.

Is there a level of workflow retraining required to leverage VP?

Rather than a crew retraining, I think it’s more of a studio retraining. Prep time is always compromised—once you get your heads of department in place, then you have your standard 20 weeks. But in VP where you want to be working with the correct assets and dealing with the parameters that the film will ultimately become, you want an extended prep period to the tune of an extra 20 weeks. In that additional 20 weeks, you’re working with a visual development department. So you have your script development and then an extended visual development department. Then you bring in all the rest of your department heads and take it to wherever it needs to go, whether you have real photographic components or you’re doing it all virtually.

Do you see yourself as a producer gravitating more to virtual production?

It comes down to the movie itself. If you have enough demand in CG sequences to make a virtual production pipeline cost-efficient, I would go that route. I've been dabbling on the fringe of this whole thing with the *Planet of the Apes* franchise. We weren't doing full virtual production, but we were using different components of it. And then again with *Call of the Wild*, and each one of these components makes some other decision easier and more palatable to the rest of the crew.

One of the things I always struggle with as a producer is getting the rest of the crew on board with what it is that we're aiming to achieve. The example being, when you have Harrison Ford on set, getting the camera operator to point the camera at an apple box versus Harrison Ford is quite a struggle. If the movie's correct for it, if there's a CG character or a massive CG world, I would push for virtual production. You'll get more of that same filmmaking language into your movies than you would going the traditional visual effects route.



Image courtesy of Halon and 20th Century Fox

Performance capture and postvis used together to visualize a shot in progress with actor Andy Serkis from "War for the Planet of the Apes".



We obviously have financial and time constraints sometimes, but for me, it's possible to be more varied, and the possibility of limitless creativity can exist where you can have the best of both worlds.



KENNETH BRANAGH

Director

As a director, you're responsible for guiding the many creative elements that make up a completed film. Your work is made exponentially easier by having a clear and common frame of reference to which all contributing crewmembers can refer throughout the project. Some additional benefits include:

Increased agency over the final image. When collaborative elements such as previs are easier to change and quick to render, you gain more creative input for pre-production. The closer you can get to a shared vision that everyone can see and refer to, the more likely the final project will reflect that vision.

A real-time engine enables a more iterative workflow via the reduced friction to create reference imagery. It also means creative alignment during a period when assets are less costly to create and modify, with increased ability to contribute for all department heads. Increased participation also means everyone can bring their entire experience and talent to bear without fear of budgetary constraints.

When using a live LED wall in place of a static green screen, you as a director gain additional benefits such as increased accuracy and control over framing and lighting. Instead of requesting your cinematographer to make an educated guess about virtual elements in the frame, you'll actually be able to frame them directly in the viewfinder, and the cinematographer can light scenes according to their training and expertise.

Your actors will know what they're looking at and be able to modulate their performances to match the action instead of suffering from green-screen fatigue and disorientation. You can toggle between angles, sets, and locations rapidly to make the most of your shooting day and spend less time waiting for resets.

By using specialized VP tools like Sequencer in Unreal Engine, you can also gain a deeper level of direct orchestration of elements. Repeatable visual cues can be as complex and varied as you wish. As a result, you can take bolder risks and create more varied sequences without fear of budget or logistics hampering the work.

Virtual production for the director comes down to the ability of your entire team to see with their own eyes precisely how the scene will look as you're creating it. The editor has all of the elements they need to make sure that the scene is working and any tweaks can be made immediately, which means fewer re-shoots. This ultimately can result in fewer, more efficient shoot days.

So you'll know when you have a scene on the day on the set, instead of having to wait days, weeks, or even months until a final version is ready. And by then, your sets have been struck and your actors and crew have moved on to another project. Instead of having to live with compromises, you'll be able to confidently complete production and use post as a time to finesse what you have versus needing to hastily rebuild it from scratch.



Director Interview • Kenneth Branagh

Sir Kenneth Branagh is an award-winning actor, director, producer, and screenwriter who trained at the Royal Academy of Dramatic Art in London. He received Oscar nominations for his acting and directing work on *Henry V*. His additional work as director includes *Much Ado About Nothing*, *Hamlet*, *Dead Again*, *Thor*, *Cinderella*, *Artemis Fowl*, and *Murder on the Orient Express*.

When dealing with scenes featuring virtual elements, how do you guide the actors' performances?

We try to think laterally and involve all our visual effects colleagues with the actors from an early stage. So for instance, there's a formidable creature that exists in *Artemis Fowl*. We determined with our visual effects colleagues and our prop-making colleagues, despite producing a creature that would essentially be computer-generated, we would create a 13.5' high, entirely three-dimensional model of him.

We shared this with the actors on set early on, and although the features may change, it gave a sense of scale, sense of bulk, and everything—something that might be useful in all sorts of other parts of the production process—and was inspirational for the characters who are interacting with this creature, for actors who would be part of the motion capture element of giving the internal performance. And those conversations were had between me and the actors, but also in this case, with Charley Henley, our visual effects supervisor, and the actors as well.

Charley and I worked together previously on *Cinderella*. It's a very harmonious way of trying to make sure that maximum information is had by the actors, if, as I believe it usually does, it's going to make a significant difference to the way they perform—in addition to maybe just realizing a 3D version of a massively important character, which is different from only seeing concept illustrations or whatever. We'll also definitely offer up the sharing of previsualization of sequences not to limit the actor, but to let them understand how to embody parts of that ultimate, fully-fleshed out sequence we'll have that they'll contribute to.

And also by the same token, again to use Charley as an example (I was at work with a number of visual effects supervisors), he would also be part of those kinds of conversations early enough to potentially include and fold back into the previs process the comments from actors who are now owning their characters from a different perspective. So the holistic and early involvement of key collaborators, is for me, an important factor in trying to just make an organic integration of performance and visual effects execution.

On *Murder on the Orient Express*, the imagery outside of the train car windows was created via LED screens. Did that have a positive effect on the actors in terms of their sense of immersion?

Massively and critically I would say. And it was a version of a process that was arrived at through extensive testing. So we went out onto real railway carriages and shot interior train scenes while moving against a real and live moving background. And we compared it with plate photography that we played on LED screens, and were confident that the photographic possibilities were equally creative in both ways. We also ran the numbers on the logistics in that case, carrying potentially our 12 movie stars to locations that depended on us having control over railroads. And frankly, with all the health and safety issues of every conceivable type, to be practically shooting on trains was very, very difficult in terms of our particular project.

And so those projection screens were critical because in the test process we absolutely understood that the quality was going to be more than acceptable—in fact, it was exceptional. But more importantly, it was that in combination with the hydraulic underwiring of the carriages so that they moved at that computer-programmable facsimile of the movement of rail carriages across certain parts of Europe at night on certain gauges of rail track.

The combination of that hydraulic movement underneath the train with the very brilliant, very specifically gathered plate photography that we used, meant that from the very first day that I got on to test it, not only did it seem entirely convincing, but when it was actually transported and immersed, there wasn't an actor who got onto that train who wasn't similarly galvanized. To the point where I remember going for a walk down the train to the next carriage to have a look out at the scenery and even I had to remind myself I wasn't looking at a real scenery, I was looking at projected images. But they were completely convincing and entirely transported the imaginations of the cast and the crew.

Does the use of previs affect your sense of agency over

the visual direction of the film?

My goal as a director is to guide tone; to offer up anchor scenes and shots that become part of the visual signature. I get less worked up about the authorship issue—these are very strongly collaborative enterprises, and frankly, I forget who had an idea. I am often pleased to remember that sometimes I have some of the ideas as well. But certainly my job is to direct and guide them, and to keep giving people an understanding of what the desired tone, feel, mood, atmosphere, and pace of storytelling is. That’s where the unification of the presentation comes from.

We’re doing that right now on *Death on the Nile*. Much of our shot preparation is based on a very specific understanding of exactly the dimensions of the boat and what an angle or a longer lens is going to do at any particular point on that boat; to understand it as a vocabulary of atmosphere, which is very key to summon up particularly when you’re trying to produce a mystery or a thriller. For previous movies, sometimes you offer up to a previs designer or visual effects supervisor a sense of atmosphere about the film and invite them to respond.

For example, on *Murder on the Orient Express*, it came to simply an understanding of the larger digital terrain that had been created, inspired by literal landscape around the Jungfrau and the Munich Sea and on its borders, the Matterhorn. Then it was possible to talk about wanting an aerial shot that combined as much dynamic difference in the scenery and topography and texture of the landscape as possible, without being able to say something like, “Stop the airplane just left of the Jungfrau.” That’s a situation where I would be asking for a spectacular offering to come back my way at whatever level, of a kind of grayscale level or whatever.

But we could talk so you could get a sense, you can knock back and forth the dynamics of the shot. Do you start low on the ground? Do you want to go sheerly up, something like the north face of the Eiger? Do you want to flip over the other side of that, or would you want something bigger and larger? There are all sorts of ways of talking about that; all of them are legitimate. They can be references to previous films, it can be found footage where you say,

“Something like that but please include this.” Or it can come straight from the imagination of a concept illustrator or an animatic designer, or a series of shared conversations. Or as we did with *Artemis Fowl*, you go into a virtual world designing shots. That took us through the underground world of Haven City where we had an enormous range of possibility in conveying a complete parallel universe, not dissimilar to the kind of challenge and the expansive possibility that we had on *Thor* when we were going into Asgard for the first time. So it becomes a sort of very stepped process where, from my point of view, all contributions are welcome.

As filmmaking technology continues to evolve, does knowing what’s possible inspire you to create projects that you might not have conceived of 10 years ago?

Yes. I think it’s an exciting time. Particularly, I enjoy the fact that my background comes from a very intensely lived connection with performance, but which now sits next to a much greater experience of really anything being possible. We obviously have financial and time constraints sometimes, but for me, it’s possible to be more varied, and the possibility of limitless creativity can exist where you can have the best of both worlds.

When you’re in the middle of directing a visual-effects intensive scene, how do you remain present and focused on the performance?

It’s in some way whatever you can, wherever it intersects, retain the human element. Retain a way of considering character and intention. Never let it be merely the brilliance of an extraordinary photographic spectacle. But always try to actually reassure yourself by locking the work that you do to story, to character, and, wherever you can, find the human element at the center of it.

By that I mean the motivational element, even if you’re dealing with completely inhuman characters. Still, they will have intentions. Still, they will have desires. Still, they will have needs. And try to find those to motivate and calibrate the action or the spectacle so that there’s always a necessity for it. You’ve got to find that necessity of storytelling imperative even in the midst of all the sound and fury.



Director Interview • Wes Ball

Wes Ball is a film director, visual effects artist, and graphic artist. He created a seven-minute short film called *A Work in Progress* which won a Bronze Medal from the Student Academy Awards in 2003. Ball is also known for directing the *Maze Runner* trilogy.

What's your comfort level as a director with real-time animation?

I got my start in visual effects and animation. My animated film school short got me out to Hollywood. After that, I started up a little visual effects company and that's how I made a living. I eventually made this little short called *Ruin*, which is entirely CG. That's what got me the *Maze Runner* job, and I started going back into live action and becoming a director.

But I never lost track of the visual effects and animation side. All I had to do was learn Unreal, and I found out pretty quickly that it is very cool. The future of filmmaking is there, especially on big blockbuster entertainment. I can be sitting in my pajamas at home directing my movie in the computer, editing, putting the camera where I think it needs to go, playing around with the lighting, playing around with textures, and so forth. It's fantastic.

How would you compare virtual production to more traditional filmmaking?

The last three *Maze Runner* movies I directed had some pretty heavy visual effects components to them. That process is, you talk about the shots and then you see your first iteration, which is a gray-shaded previs. And you go "Yeah, I think that's going to look pretty good." Then you start putting the textures and the lighting on it. The next render out of the box we might say, "Oh hey, it's getting closer. I think we're on the right track." Then a couple of weeks later it comes back to you and hopefully closer to the final form. Then you begin that period of trying to get that last 10% perfect.

With Unreal, I can take the first 80% of the work and compress it down into something very immediate. I can get the previs, the rough blocking, the rough textures, the rough placement, the lighting, all working quickly. And then I can spend most of my time with the artists trying to get that rest of the way there. It's rapid prototyping visual effects because your previs can look good and give you more information about what you're seeing.

Does that higher level of control give you a stronger sense of agency over directing?

It comes down to temperament and what you want. As a director, I have a background in visual effects, and I'm very comfortable and don't get frustrated with them. I can imagine some directors prefer the idea of not being involved in putting the paint strokes down with the brush directly. They'd rather describe what they're looking for and then let other artists do that.

How does your collaboration with a cinematographer differ in traditional production versus virtual production?

On *Maze Runner*, I didn't have this toolset where I could pick up a virtual camera and shoot a shot. In VP, I'm working with my cinematographer Gyula Pados, and we were building all of these virtual tools. You can change your lens, set your aperture, set your focus, make your set, and set your lighting. Then you look at the camera, and you can see your movie or at least an excellent approximation. They are very intuitive tools.

How does your development effort shift with virtual production compared to a more traditional visual effects finish?

It's a choice based on what your desired result is. If you're doing previs, you can throw some crude streaks down and at least say "Hey, it's something like this." That helps the crew to see the basic vibe you're trying to achieve. But the beauty of Unreal Engine is that simple work that you would put into Maya anyway, it's a matter of an hour or two to get it running in Unreal with real light on the model, and it can look great. So you're not just looking at the grey cube that you're used to seeing in previs.

We try to build our sets for real, but at the end of the day, we can't spend all of our time making every nut and bolt of an object. We start with concept art and then start building. Hopefully, in a modular system with a uniform language of doors and walls to quickly assemble a building or whatever your set is. You put the camera in there, bring in an actor to do some rehearsal with the mocap suit. Then boom, you see your movie with a sense of how you want to block and shoot scenes.

How does directing actors in mocap differ from a traditional scene?

That’s the hard part; it can be very unnatural. I’ve worked with Andy Serkis, who is like the godfather of performance capture. He says it’s a certain type of actor who’s open to this. I’ve talked to very famous actors who were just too intimidated by the concept of not seeing another actor in front of them with a costume, playing the character versus seeing this strange person in gray pajamas. They just couldn’t get around that.

I understand it, but there are actors more willing to pretend and be a little kid again. You’re out on a stage, and all you care about is interacting and creating a moment with your fellow actor. You have to trust that all these technical apparatus are going to capture everything you do.

Actors need help sometimes to visualize what the scene is, but ultimately it works when it’s about making a truthful emotional connection between characters. And you can decouple the camera side of it because you’re in this volume and the actors are doing their thing, and you’re just watching them like a play.

Sometimes you can get yourself in trouble because you’re not thinking through a camera, through a lens. So we all know that experience on set where the difference of an inch or two from an actor changes the blocking. You have to approach it as, “I think I can capture the camerawork for this scene a week from now. Or I need to put a camera up and look at it with the actors right now and make sure I’m getting it right.” The blocking, the exchanges—all that kind of stuff. It’s a unique and thrilling new way to make movies.

Have you conceived of new projects to take advantage of virtual production?

Not really, because I don’t think every movie wants to be made this way. It’s not like we couldn’t make these kinds of films already. What changes is the entry point into those projects. A movie that would have cost \$500 million to do ten years ago can now be done for \$150 million. These tools make it so much easier and more efficient; that’s where the real power is. We were already at a place where if you could imagine something and you had the money and time, you could create it. Virtual production enables the rapid prototyping and realization of those ideas.

What advice would you give another director for their first virtual production?

It’s just like when you pick up a new camera, lens, light, crane, or Steadicam. You don’t just show up on the day, open up the toy, and start playing with it. You need to get your hands on it and figure it out first. For anyone coming into virtual production who isn’t familiar with these tools, they’re going to be okay because they’ve got a whole bunch of technicians to help them out.

Making movies can be very odd in general, and this is just another way to do it. If you’ve got the will and the desire to play with these new tools, you’re going to have a lot of fun. You’re also going to have a lot of frustrations like any moviemaking process, but I’ve had a lot more fun than frustration.

Where do you see virtual production evolving next?

What I love about building a production around Unreal Engine is you’ve already made a game. Or at least you could make one very easily with those assets. Now, a fan, an audience member can play in the same world that we created. It’s an opportunity to branch out to different entertainment experiences.



We were already at a place where if you could imagine something and you had the money and time, you could create it. Virtual production enables the rapid prototyping and realization of those ideas.



WES BALL

Director of Photography

As a director of photography, you're responsible for everything seen in the frame. But that becomes more of a challenge on a VFX intensive project, when so much of the frame is created long after principal photography wraps. The disorientation and frustration of shooting actors alone on a vast green screen is a familiar scenario in modern filmmaking. Virtual production can help increase the level of certainty you have over the final image.

VP can also provide you a greater level of collaboration with the art department, production designer, and visual effects team. The efforts of all of these teams have a major impact on the final image. Here are some examples of how these collaborations can work:

During pre-production, virtual production goes far beyond previs animations. The development of previs used to be siloed away from the rest of the development process, because the work required time-consuming frame-by-frame animation. Traditional previs is not as malleable or collaborative, and therefore not much different from working with a traditional storyboard artist in terms of direct interaction. With a real-time engine, previs including real-world physics can be manipulated directly by you working side-by-side with non-engineers.

A real-time location scout could involve your wearing a virtual reality headset (HMD or head-mounted display) and interacting directly with previs animation playing back. You would be able to manipulate elements of the virtual set directly via VR hand controllers, exactly how you'd be able to on a real set. You'd be able to plan shots out using virtual cameras all within the real-time engine. In short, you'd be able to more directly influence look development, previs shot design, and framing, which ultimately leads directly into decisions made on set. Getting everyone aligned to the same vision becomes easier.

If a production involves performance capture, VP will take various forms. You'll work with actors wearing motion capture suits to serve as a reference for later digital characters. Simulcam will aid you by providing a real-time preview of the virtual characters synced to the motion capture actor and superimposed live over the output of the camera. This makes framing and timing a lot more straightforward.

If the production involves a real-time LED wall, as a DP you'll find plenty of new options for control over the image. Turnaround becomes far less time-consuming because rather than having to physically move the crew, actors, set pieces, and so on, you can just rotate the background scenery on the screen and be able to reset for turnaround in moments instead of hours. This also means you can hold and control the time of day to any specific mood and color temperature you desire.

I believe the challenge for most cinematographers is having no idea what they're lighting for.

HARIS ZAMBARLOUKOS

Interactive visual effects lighting can be another major challenge; that is, synchronizing movie lights with visual effects on a green screen. When working with a traditional green screen, you often have to settle for an educated guess that the color, intensity, and quality of your lighting matches what will eventually be composited into the frame. A live LED wall can greatly rectify this issue by providing a visible effect you can light to. Furthermore, by connecting DMX/networked lighting controls into the real-time engine, movie lights can be combined with on-screen effects for automatic synchronization and infinite repeatability.

LED walls do present some photographic challenges as with any technology, which you'll want to take into consideration. Carefully coordinate with the team sourcing the LED panels to ensure a sufficient pixel pitch to avoid potential moiré issues. These can become more pronounced the closer the camera gets to the screen and the sharper the focus is on the screen versus the foreground. That said, moiré is easy to spot on the monitor during camera tests, so you'll know quickly if you have any issues with the sharpness of the LED panels chosen.

Light contamination of movie lights back onto the LED screen itself presents another possible challenge. As the LED wall is an emissive source, a strong key or spotlight hitting the screen can create a hotspot. Careful flagging and a comfortable distance kept between lighting equipment and the screen can mitigate this.

Virtual green screen placement also greatly simplifies shots in which post-production compositing is desired. Instead of having to handle a giant, unwieldy green-screen rag and then carefully light it, you can simply place areas of green precisely where they are needed directly on the LED wall via the engine. The effect is seamless and perfectly lit. You can even combine the effect with camera and actor tracking to create a halo effect where the green screen area precisely follows the actor outline and minimizes spill and contamination.

The color science and bit-depth of the on-screen image should also be accounted for. You'll want to confirm that the color balance and possible LUT applied to the screen complement the settings of your camera and supporting equipment. Also if you are using the LED wall to extend a foreground set, careful color balancing to achieve the smoothest blend is required. Movie lights also have their own colorimetry and intensity that need to be balanced for appropriate combination. To make this process easier, real-time engine footage can be processed through real-time grading systems before output to the LED wall to help ensure the most precise color matching between all the elements in the frame.

Successful virtual productions arm you with the tools to experiment with multiple photographic approaches in response to artistic motivations and new variables, enabling you to treat the virtual elements as simply another tool in the toolbox. VP teams are there to support the efforts of the live-action crew. They are eager to collaborate with you for the shared goal of creating great imagery in the service of storytelling.



Director of Photography Interview • Bill Pope, ASC

Bill Pope, ASC's credits as a cinematographer include *The Matrix* trilogy, *Spider-Man 2* and *3*, *The Jungle Book*, and *Alita: Battle Angel*. Over the course of his career, he's made movies with optical compositing and traditional visual effects, then moved through digital compositing and CGI visual effects and onto virtual production techniques. Pope also navigated the shift from film to digital cinematography.

Can you describe your experiences regarding the evolution of cinematography as it relates to virtual production?

On the early *Spider-Man* movies, we just used our imagination. For example: as Spider-Man swings from this building to that building and down that block—how fast is he moving? The camera movements were very imprecise and you just basically had to imagine the CG character in the frame. I shot all the Spider-Man parts of those two movies with VistaVision large-format film cameras. So if we changed our minds later and wanted somebody to go faster or to go further left or right than you imagined in the original shot, you'd have an area on the frame you could reposition.

These days, everything is much more sophisticated. The director and cinematographer are looking at what is basically a finished image on the monitor via virtual production. We had that for *The Jungle Book*, where a live-action Mowgli walks next to a virtual Baloo. Or you can see how big the dragon is in your frame on *Game of Thrones*. You're making your frames for those virtual characters and you can even see how they're going to be lit.

Do you feel technology has made it easier to achieve visual effects?

Everything is getting easier as people get used to working with the technology. The first couple of times you go out and you're in the field doing R&D. When things are brand new, you might take more creative chances that you don't take later. Accepted wisdom can be a detriment to innovation as well. Telling me that something can't be done, well you might as well throw a gauntlet on the ground or double dare me. I'm going to look really hard to find out whether that's really a rule or whether it's breakable for good reason.

How does a cinematographer approach an image differently from a VFX artist?

We're both using the natural world as inspiration. I went down to The Mill recently to talk to their animators about natural light and how to imitate it. We were in an auditorium and I said, "Let's go outside to the parking lot." So we all stood up and walked out to the parking lot to look at the light.

I then said, "How would you characterize this sunlight versus that shade and what do you think is lighting this shade? What do you think is lighting this part of this wall? What do you think is lighting the air? Is it pleasing or not pleasing?" I had them think like photographers in basic terms, but I think it was inspiring for them. They already had technical tools to do the job, but I pointed out to them that they already owned the best tools: their eyes.

Photography is a feeling, you're just providing the atmosphere for the drama to take place. Think how it should feel and move on it accordingly. What movies have made you feel certain ways? It was just a beginning conversation, but we basically do the same job.

How do you reconcile being the arbiter of the image when much of a frame is left to post?

On *The Jungle Book*, we tried to build as much as possible into the set. When the characters cross a river, we built a river on stage. We built jungles on two different stages and changed them out every night. They were all on rollers, and we'd bring a new jungle in overnight. The actor playing Mowgli was nine years old, so we'd have him for three or four shooting hours a day. The rest of the time we had to organize our jungle and were basically working on a real set with real grass and real trees.

Also, you remember I had already made the movie in a motion capture camera for months before. The movie had been shot and cut, so I could watch the whole thing before I ever stepped on the set to photograph the real actor. It's not guesswork, the visual effects team knows what's there. They've already generated the animals and some of the background that we saw on our monitors on stage. We always try to have as much reality and get everybody on the page as much as possible by the time you're on set.

How do you keep up to date with evolving technology?

You're always led by the needs of storytelling. That's what takes us places and the need to entertain and to wow people. You're always looking for something that they haven't seen before. These are the things that drive you and I have no idea where technology will go.

That said, I love it and anything new is exciting. If we had to do the same thing every day, over and over again, holy mackerel, that would be boring! Fortunately, that has never happened in our business. We went from hand-cranked cameras to motorized cameras, sync sound to color to widescreen to 3D—the list goes on and on and on. It whets the audience's appetite and keeps everybody else excited.

Walt Disney liked to have a stenographer at every meeting, and he recorded every meeting. So, you can listen to a group of animators sit around and talk about how to set up *Snow White* and how to do the characters and what their concerns are. So whenever something broke or was delayed on *The Jungle Book*, Jon would say, "Let's put on the Disney tapes." We would listen to it, and they would have the same problems that we had. Exactly. They would come up with the same solutions that we came up with. We were separated by miles of technology and time, and yet the storytelling is the same.

“

Telling me that something can't be done, well you might as well throw a gauntlet on the ground or double dare me. I'm going to look really hard to find out whether that's really a rule or whether it's breakable for good reason.

”

BILL POPE, ASC



Director of Photography Interview • Haris Zambarloukos, BSC

Haris Zambarloukos, BSC is a Greek Cypriot cinematographer. He earned an MFA from the American Film Institute and interned for Conrad Hall, ASC. His credits as director of photography include *Mamma Mia!*, *Thor*, *Cinderella*, *Murder on the Orient Express*, and *Artemis Fowl*.

You worked with LED projection screens on *Murder on the Orient Express*. What were the photographic challenges?

We started off by doing a test shoot on a period piece of track, on a period train. And we shot 65mm film on scenes looking out the window, and we simultaneously shot some digital footage of the view. And the next day, we shot 65mm in a railway yard with a small amount of LED screens with the projected materials, and we tried to replicate the same shots. So, we did an early test that we could actually do in a day to do a compare and contrast. That's how it all started.

The good thing is you actually know your lighting conditions for the scene in advance. Whereas if you do a green screen, you're guessing what they'll add later. We were shooting 65mm negative. You need to be shooting at T4, and the camera sees everything, so it really does have to hold up.

You've also done projects with pure green screen. How would you compare that to LED screens?

On *Thor* we used a lot of green screen and didn't use any back projection whatsoever, but we built a lot of sets. When you know what the environment is and you've done your previs, and you've done your scout, then you can treat it as such. I believe the challenge for most cinematographers is having no idea what they're lighting for.

So if you approach it from an informed view and a collaborative point of view knowing what you're dealing with early on, then it works. Going into it blindly, I think, and thinking that blue screen can save you, that can be a bit of a treacherous ground. There are other ways. Working with Jim Clay, as a production designer, he really loves his great scenic painters, and so did Dante Ferretti on *Cinderella*, for example. Both these production designers are great production designers with great scenic backing artists.

You want to do as much as you can in camera—you should always embrace the collaboration with visual effects. The more we can all get together and find a solution that gives us great dailies, and also allows the actors to know where they are and feel where they are, I think it's all positive.

When projecting pre-rendered footage, do you have to account for the lack of parallax?

Absolutely, and you also don't know how much things would be blurred or not blurred. I'd say that one of the most challenging things of mixing it all together, for me, was *Jack Ryan* because we had many things in camera, in real cars, and on locations. Then we mixed up locations, like Liverpool for Moscow, but we had real Moscow too. Then we had some incredibly impossible shots that you just couldn't do live on the road, like 360° moves all around the car that go into the car. Those were green screen and no matter what you did, the exterior of a car is a gigantic, reflective, curved mirror that always sees the camera, the screen, and the lighting.

It's such a challenge to get the green in the correct places behind the actors' hair, for example, and to keep the shot alive like that. You just use your judgment as to how much is blurred in the movement, how much of it is almost like sleight of hand.

With these complex projects, do you find previs useful?

Definitely. All kinds of planning are useful. It's no different to me than when I write something down as a note—I remember it. It certainly helps later in having a kind of blueprint to explain to your crew what you're trying to do.

Do you notice a difference in the actors' interaction when it's green screen versus a process shot where they can actually see the background?

Completely—it's night and day. For example, Judi Dench, when she was on the train, because we even had motion on it, she really felt like she was traveling. When you walked off the set, you actually had a bit of motion sickness, like stepping off an escalator. Interestingly, as we progressed through the shoot, and including some additional photography towards the end, we had very little of our stage left in our set.

We were just picking up little tiny pieces, and they were on green screen and only green screen. I remember Tom Hiddleston turned around to Ken and said, “You know, all those years practicing mime, now I know why.” And one of the things I noticed that Ken does as a director, which is fantastic, is the more green screen it gets, the more he wants to describe and talk to the actors about what’s happening inside, and where he wants them to go, and how they should interact with another actor. What he’s able to really master is a certain eloquence and descriptive English to get an actor to know where they are in a green screen environment.

When Ken starts rehearsing on an empty stage for us, there’s nothing. It’s a blank canvas, and we mark things out with masking tape, just “This is where everything is, and this is kind of the space.” You’ve got to imagine it, and slowly you build the set and it’s like a theater production. That kind of training and theater background are really useful.

As a cinematographer, do you feel more sense of authorship in live effects versus post-production?

Yes and no. I think of all of these as live VFX shots. It’s just, how do you accomplish them? Do you have more input as a cinematographer if it’s happened during prep and during shoot? Obviously, I’ve been fortunate to be involved with productions where the VFX supervisors are inclusive.

I’ve graded all my films, done all the post, they invite me even midway through to start doing some grading so that they know how their VFX will be affected by it. All of these things are based on a relationship, and I think for young cinematographers starting out, if you have a personality that says, “I’m here to help, to collaborate, and to be part of a team,” then people relish that and welcome that, and would rather have you be involved.

“

You want to do as much as you can in camera—you should always embrace the collaboration with visual effects.

”

HARIS ZAMBARLOUKOS, BSC

Virtual Art Department

The virtual art department (VAD) is another area that is part and parcel of virtual production. So we include it here to explore its relationship to other departments and understand how it can best support them. Think of the VAD as a transitional team bridging the work of a more traditional art department and a regular previs department via the advent of real-time animation.

The VAD's primary role is the development of real-time assets from initial look development to production-ready models and environments. The VAD also assures consistency and high quality across all real-time models. It acts as a liaison between creatives and artists to assure all stakeholder feedback gets fully incorporated into the assets.

The work of a traditional art department is generally focused in visual development and pre-production. The VAD is no different in terms of emphasis. The main difference is the VAD is often tasked with delivering complete camera-ready assets for production as opposed to handing off to set building or visual effects departments. With this in mind, the work of the VAD may be more involved and intensive compared to a more traditional workflow, but will ultimately handle a larger share of final imagery.



Image courtesy of Epic Games and 3Lateral

“

The better you make something look, the more seriously everybody takes it. There is a difference on the set when we're shooting virtual assets that look good. Everybody gets excited, and people take it more seriously and put more work into every single shot.

”

BEN GROSSMANN



Virtual Art Department Interview • Ben Grossmann

Ben Grossmann is an Oscar-winning and Emmy Award-winning visual effects supervisor, virtual production supervisor, and Co-Founder and CEO of Magnopus. He supervised JJ Abrams' *Star Trek Into Darkness*, for which he received a 2014 Oscar-nomination. Grossmann's credits also include Martin Scorsese's *Hugo*, for which he won the Oscar for Best Visual Effects in 2012, *Alice in Wonderland*, *Shutter Island*, *Sin City*, *The Day After Tomorrow*, *Master and Commander*, *The Lion King*, and more.

How do you see the role of the virtual art department in production?

I come from a place of “These tools kinda suck, we should fix them.” It comes from my years working with Martin Scorsese. He’s not interested in complicated BS. He wants it as simple, clear, and easy for him and the actors to understand as possible. If it gets too complicated, he looks at you over the rim of his glasses with a look that can turn your blood to ice. And you don’t like getting that look, so everything that you do has got to be simple and intuitive.

What I always disliked about virtual production was that you go in and there are cables and a bunch of people at computers. You don’t know who to talk to and even though you try to simplify it for creatives by saying, “Well, this is the person you always talk to,” it still looks like you’re getting uploaded into *The Matrix*.

When we got onto *The Lion King*, we had an opportunity not just to make an animated movie. We wanted to make a live-action movie with live-action filmmakers. We tried to eliminate all of the technology and the engineers from the creative process and put it in the hands of the traditional live-action filmmakers. Live-action filmmakers do things from instinct.

They don’t sit down and think in their head, “Okay. First I’m going to pan left, then I’m going to over-correct, and then I’m going to tilt up, then I’m going to catch that nice little lens flare, or whatever.” They don’t do that. You just put a shot in front of them and put their hands on the wheels. Then they feel from their stomach what the thing is that needs to tell the story instinctively. If they had to describe it to you over the phone, they couldn’t do it.

Forget post-production for a second, let’s build a world, let’s put the filmmakers in it, and let’s give them the tools that they know how to operate. And then because no filmmaker is an island, they always have a support team like dolly grips, gaffers, and so on. Let’s give those people the tools that they know how to use, and then let’s get out of the way.

How vital is pre-production for virtual production?

“Fixing it in prep” is no different in this model of virtual production than it is on a live-action film set. Which is to say the cinematographer doesn’t just show up on the day and there’s a standard set of lenses and cameras. The cinematographer’s already spent two months in prep testing out lens packages, and camera bodies, and shooting tests, and charts, and lighting packages, and this light versus that light. That’s going to become his brushes and his paints or her brushes and her paints that are going to make this canvas come to life. So that’s all prep and a normal part of any creative process.

Does the level of visual fidelity presented by the virtual art department make a difference in planning?

You have to cross a visual threshold for people to believe that something is real. If something looks like a cartoon, then you might treat it as a cartoon. The more real something looks, the more you treat it like it’s real. If you don’t fill up that bucket of believability to a certain point, then your brain engages at different levels, and it doesn’t look at something as critically.

We try to get our assets looking as real as possible because then people start to look at it like it’s more final. When something looks like its previs, the mind shuts off and says, “This is gonna get replaced with something else later, so why should I invest time in it?” So the better you make something look, the more seriously everybody takes it. There is a difference on the set when we’re shooting virtual assets that look good. Everybody gets excited, and people take it more seriously and put more work into every single shot.

What is the benefit of human camera operators for virtual cinematography?

Instead of you directing the movie through post-production, we wanted you to be able to carry your instinct into the digital world. Because in the physical world, your reactive instinct works. In the digital world, it doesn't; it's just a blank canvas. So we need to carry your instinct in, not only the imperfections but the raw instinctual creativity.

There's a symmetry in the creative process when a group of people gets together on a live-action movie set. The magic gets created by all of them interacting with each other at that moment in time. If they all never meet each other and work apart from each other, then it wouldn't be the same thing. What if we got all of the creativity of the film in one room at one time—how amazing would that be? That's what we're trying to do with virtual production.

How do you see virtual production evolving in the next few years?

There are two things right away that are important; first and foremost is realism. Getting photorealism in real time is going to revolutionize filmmaking. It's going to take money currently put into making assets in post-production and move them into pre-production. We need improvements in ray tracing, anti-aliasing, and depth of field—all those things that make things look real.

Number two is AI. If you're trying to use virtual production as a tool to empower fewer people to do more amazing things, then let's start removing all of these unnecessary complications, and we can do that with AI. So you can walk into an empty room and say, "Give me a 1940s-era Western frontier town, and oh, let's make it winter." You got natural language processing converting it to an asset library, and you could talk your way through this as an individual.

I think it's first empowering filmmakers to do more with less so that you get better, more creative, more exciting stories from people who don't have the funding of a Spielberg or Scorsese or Favreau. Beyond that, let's start building worlds and putting the audience inside and see what happens. All of this virtual production is just the front door to that house, and once you're inside the house—all bets are off.

“

The magic gets created by all of them interacting with each other at that moment in time.

”

BEN GROSSMANN

Virtual Production Supervisor

The virtual production supervisor is logically an integral part of any project involving virtual production. We include the role to highlight its importance as well to help crew members from other areas to better understand what the responsibilities of a virtual production supervisor are.

The virtual production supervisor is a liaison between the more traditional areas of the production team and the real-time areas such as the virtual art department. They also oversee the creation, decimation, and reuse of real-time assets to enable them wherever possible to be shared with other departments and become the basis for final visual effects animation. This opens up a whole new area of opportunity to create virtual prop houses and backlots where assets created for a long-form series can be reused over entire seasons to greatly increase efficiency and cost savings.

Another area the virtual production supervisor helps oversee is the creation and management of virtual scouting. This includes the creation of the virtual scout locations themselves and the coordination of getting the key creatives together into the virtual space to complete the scout.

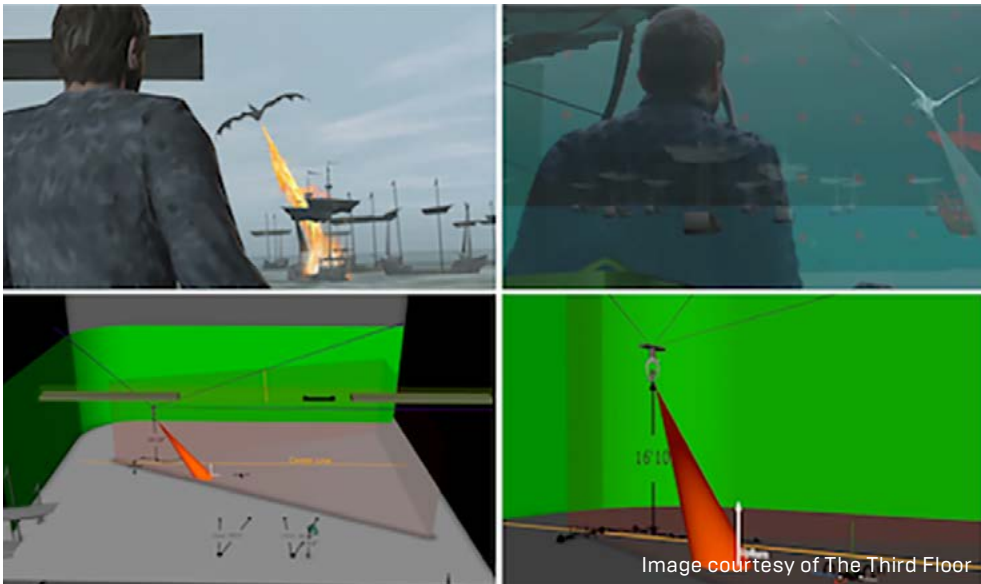

Previs and techvis created by The Third Floor with visual effects from Image Engine for "Game of Thrones".

“

We need to understand the problems the crew is trying to solve and make sure that the tech addresses those rather than pushing a technical idea and way of working that doesn't answer the original brief.

”

KAYA JABAR



Virtual Production Supervisor Interview • Kaya Jabar

Kaya Jabar has worked at The Third Floor for nearly three years. She worked as a virtual production supervisor on projects such as *Game of Thrones*, *Dumbo*, and *Allied*. Jabar loves being able to flesh out ideas and carry them over to realistic shooting scenarios, evaluating available equipment, and coming up with new configurations to achieve impossible shots.

Can you describe your work as a virtual production supervisor?

I started in games, then joined The Third Floor as a visualization artist, and later transitioned into virtual production three years ago. My first show was *Beauty and the Beast* where part of The Third Floor's work was doing programmed motion control and Simulcam using visualized files. We used MotionBuilder for rendering, and the live composite was mostly foreground characters. Next, I did *Allied* with Robert Zemeckis and Kevin Baillie.

In the last few years, I worked on The Third Floor's team, embedded with the production crew on *Game of Thrones*. I did previs in season seven. Then in season eight, I supervised motion control and virtual production, primarily running the main stages and prototyping production tools. Anything to do with mounting flame throwers on robot arms, driving motion control rigs, virtual scouting, custom LED eyelines, and fun stuff like that. I also used a bit of NCAM real-time camera tracking and composites on that show.

Now I'm back in the office focusing on our real-time pipeline and looking at how virtual production can be further leveraged. At The Third Floor, we're generally on productions quite early, building and animating previs assets to storyboard the action quickly. It's been pivotal on a few shows where you can have visualized content speedily, and use it to make decisions faster to achieve more impressive things on camera.

Which tools do you use?

We use Unreal in our current pipeline for real-time rendering, so we're leveraging that and building tools like our virtual scouting and virtual camera tools around it as we evolve the workflow. By leveraging Unreal, our goal is to be able to work with clients, directors, and cinematographers in ways that get them closer to a final pixel image, so they can make more informed decisions and be more involved in the process.

How does your work overlap with the visual effects pipeline?

It tends to flow both ways. For example, on *Game of Thrones*, we pre-animated a lot. So I was responsible for all the dragon-riding virtual production, which was incredibly complex. It was three pieces of motion control equipment all in sync and slaved to the final comp.

We would previs everything, get that approved quickly, and then send our scenes to the finals house. And then they'd send us exports back, so I could use those exports to do any NCAM work or motion control work I needed. It empowered us to pull quite a bit of animation work forward in production.

Do you think virtual production will increasingly deliver final-pixel imagery?

At least for OTT [over the top, streaming media] such as TV and lower-budget productions, we're heading that way. For the final season on *Game of Thrones*, we had six months' turnover between finishing filming and delivering six hours of content. For those kinds of shows where the production house isn't the VFX house as well, I think you can push previs assets further, due to the fact that you can cross-pollinate between final VFX houses to which you can give Alembic caches for all your work, and so on.

Much attention is being drawn to virtual production lately. I've been working in it for over four years, and other people have since *Avatar*, but it was never conceivable that you would get final pixel in camera. It was always a prototyping tool. With improving GPUs, especially the NVIDIA RTX cards and global illumination, I can see it being brought more on set.

How do you keep the virtual production department as efficient as possible?

By understanding the brief and having the virtual production supervisor involved early. On my most successful shows, I've been involved from the beginning and had somebody there who was auditioning the technology. You need to be able to look at it from the standpoint of, is this something that will take seven days to set up for one shot, or can we use iteratively without a team of 15 people?

I worked on *Dumbo* as well, and it was essential to look at all the different hardware and software providers and run them through their paces. A lot of it is making sure data flows into the effects pipeline. There's a lot of duplication of work which can be frustrating, where you've made all these decisions in one software package, and they don't flow over to the other software packages or the other supervisors.

How do you bring new crew members up to speed with virtual production?

We need to understand the problems the crew is trying to solve and make sure that the tech addresses those, rather than pushing a technical idea and way of working that doesn't answer the original brief. If somebody is looking for a quick way to storyboard in VR, then we should focus on that. Let's not put a virtual camera on them, or any of those other inputs, overwhelming them with tech.

I'm a big believer in flexibility and being able to tailor experience and UI design to address different approaches and working with different directing styles and preferences, and so forth. It's being able to understand what they're trying to do, so we can do it more quickly by not involving final animation.

What is The Third Floor doing to stay on the leading edge?

All our supervisors get deployed on the shows as boots on the ground. We not only talk to the creatives but also the technicians. I speak to every single motion control operator and every person who is prototyping solutions and approaches to understand the questions they're being asked. On *Thrones*, that collaboration and continuously innovating on everyone's ideas and input led to some very successful results, for example, for dragon-riding shots to use a [Spidercam](#) motion base and a [Libra](#) camera, which had never really been used in sync together.

We are often active across many other parts of a show, not just virtual production. A lot of our tools are bespoke per show, so we will create a specific rig that we know they are using or other components custom to the project. But we then also build up experience and knowledge with each project and find ways to generalize some of the tools and processes that can overall streamline the work.

Did virtual production help inspire the significant leap in visual effects scope for the final few seasons on *Thrones*?

Game of Thrones was this unique ecosystem of people who had worked together for so long that they'd gained each other's trust. Season six had about seven major dragon shots. Joining on season seven, my biggest

challenge was doing 80 major dragon shots with entirely new equipment. What worked there was the relationship The Third Floor had with the entire production: the executive producers, DPs, the directors, and all the key departments. The VFX producer trusted us to come up with new solutions.

They said, "This is impossibly ambitious, so let's all sit in a room and talk to all the heads of departments. Let's figure out what VFX can do, what virtual production can do, and what the final VFX vendors can provide for them to accomplish that." That type of relationship and collaboration happens, but for TV it's unique because you need to work with the same people again year after year. If you don't get along, usually you don't get asked back.

What do you think about the future of virtual production?

I'm quite excited about final pixel in camera, at least for environments and set extensions. More departments are working in real-time engines. I think it would be fantastic to walk onto a set and have every camera see the virtual sets as well as the built sets. We're showing the camera crew and the director what they're going to see, but we need to find a way to engage the actors more as well.

Has virtual production, including the work you've done, raised the scope on the small screen?

I genuinely hope, so because I think there is a lot of virtue in planning. What we achieved on *Game of Thrones* with the modest team that we had was purely because everybody was willing to pre-plan, make decisions, and stick to them. If you use visualization the way it's meant to be used, you can achieve absolute greatness in small scale.

There are so many ideas in the creative world, and I would like to be able to help directors and others who don't have a \$100 million budget. I'm looking forward to smaller movies getting the tools they need to achieve the vision which was previously reserved just for Hollywood blockbusters. It's exciting to democratize the process.

Editor

As an editor, you're accustomed to working with raw footage from production, so you're used to using your imagination with the script as your guide to determine to how everything will fit together. Your challenge increases on a VFX intensive project, where much of the frame—or even all of it on some shots—may be temporary imagery or missing entirely.

Virtual production techniques can be a big help by giving you a clearer idea of shots and sequences, empowering you to complete edits more efficiently, and providing greater feedback to the team even while the movie is still in production. Here are some examples of how VP can work for you:

Previsualization, techvis, and postvis often generate imagery that winds up in an edit, albeit temporarily. The image quality often varies greatly due to trade-offs in image fidelity versus render times. Real-time engine image quality has increased exponentially over the past few years to the point where it can often look as good as, or even identical to, the final imagery. This empowers you to have a greater sense of how the movie is working from shot to shot and sequence to sequence. You can then communicate any concerns about story, continuity, performance, and so on to the director and other crew members before production even begins. This leads to not only improved efficiencies in time and costs but also more satisfaction coming from a more direct collaboration with the production team.

Scenes featuring real-time LED walls will also be a major help to your work as an editor. Instead of receiving footage with actors in front of an otherwise blank green screen, you'll have completed shots. And because LED walls eliminate the per-frame cost of post-produced visual effects, you'll be able to work with effects-intensive shots just as you would non-effects footage. You'll have the entirety of each take from start to finish available to you versus just the portion with visual effects in progress. This affords you much greater fluidity to construct sequences without being locked into edits dictated by an already in-progress effects pipeline.

In the past, we just cut storyboards in and it's hard, even for a seasoned producer, to watch that and get the gist of how a movie is going to feel.

Once you get some basic previs cut in, then you start to get closer to what the idea is and to a point where you're ready to commit.

DAN LEBENTAL, ACE



All these great tools are for us to gain clarity.



DAN LEBENTAL, ACE

Finessing the final cut of a movie featuring previs placeholders for visual effects also often involves accepting creative compromises. Deciding to add more than a few frame trims on previously locked edits with completed or in-progress effects can add budget creep as well as delay the schedule while visual artists create new visual effects. Conversely, visualization created through real-time game engines can be more quickly changed to accommodate the edit, resulting in an improved creative process that doesn't come at the expense of lost budget or time.

The bottom line is that virtual production, due to its more malleable nature when compared to traditional post, gives you greater agency and collaborative potential as you edit. You'll be able to provide feedback based on previs that looks a lot closer to final imagery during development and production.

You'll be able to provide feedback during production on any creative, storytelling, blocking, or performance issues that might not fully reveal themselves until much further down the pipeline in traditional visual effects workflows. Knowledge is power, and for an editor, the closer a frame looks to its final form, the better. This also means you can further decouple story concerns from budgetary realities, because making changes is a lot more economical for virtual production shots than for more finalized visual effects.



Editor Interview • Dan Lebental, ACE

Dan Lebental, ACE is an editor and the owner of Splice Inc., a post-production facility in Hollywood. He began his career as a music video editor for such recording artists as NWA, MC Hammer, and Eminem. Lebental's feature credits as editor include *Iron Man*; *Iron Man 2*; *Thor: The Dark World*; *Ant-Man*; *Spider-Man: Homecoming*; *Ant-Man and the Wasp*; and *Spider-Man: Far From Home*.

How much of your work involves virtual production?

It's a pretty massive part of all the Marvel films. Somewhat independent of the writing, sequences are developed. You start previs on the notions of what kind of sequences are going to be in the movie. The animators are as much writing the scenes as anybody, at least what happens in them action-wise.

Then the script rewrites come and everyone comments. That gets done until we're satisfied and start shooting. Next, the backgrounds and live-action are shot, but it's all like starting again. We'll work with postvis and say, "No, okay, that works, but let's do this. And let's eliminate this, let's add this beat." Then we hone it to the point where we can show an early test audience.

From there, when we know what we want, it goes to the visual effects vendors. They're doing the same thing again but adding their creativity and story beats. They present shots to us, and we see whether they hit essential story points. It all circles around back into the editing room.

I just did *Spider-Man: Far From Home*, and we have a previs version of a scene where he's flying around. Now we want to get the mannerisms and the capabilities of a real actor, so we'll put him in a mocap suit and have him perform moves, and he'll riff on it. There's a lot of jazz improvisation going on.

How has your interaction with previs evolved over the years?

On *Zathura*, we had an early version of the same team that ultimately became The Third Floor. The whole notion was it was too expensive to go straight to visual effects vendors to try things. You're only going to do that if you're in a complete rush, and even doing that might be slower than just figuring out the nuts and bolts first.

On *Iron Man*, I remember one of the problems was how to make it feel like there's a human inside the suit. We shot a three-camera array on the front of the helmet but then realized that we also needed a POV. I remember working closely with the lead previs artist to develop what the HUD interface would be.

As we went on, we realized that previs could have multiple functions. We could previs scenes and later temp things

into the edit via postvis. Now it's so integral to the process that the teams can swell to 30 people. I remember having to fight to get a few artists to be able to present the cut that could tell the story. In the end, even though a lot of the previs work gets discarded, it's money well spent because having effects vendors do final shots that you throw away is much more expensive.

When you're working with previs/postvis imagery, what's the most important information in the shot?

That it tells the story—my first aim is to have a story that you understand or that I can show the assembly with enough pre and postvis. It's going to be long, but there's no misunderstanding. In the past, we just cut storyboards in and it's hard, even for a seasoned producer, to watch that and get the gist of how a movie is going to feel.

Once you get some basic previs cut in, then you start to get closer to what the idea is and to a point where you're ready to commit. You want to get as far down the road as you can without having to actually do the final effects. Everything has to serve the story. Sometimes, the effects folks, the effects supervisor, the director, or other stakeholders, might be running with something that's not in my field of view as a story element. So I'll sit back and wait to see what develops and then do my thing, which is, "Okay, how does this fit into the story?"

How do you arrive at the definitive cut of a scene containing provisional imagery?

It depends on the scene, but generally, if we know we're down to efficient storytelling and we can honestly say this is the ballpark of the number of shots we're going to need, then it can go. I've been on other shows where the rules are you can't do any final effects until the entire sequence is approved.

Marvel likes to go down the road of experimentation because they feel it's important to research and develop key shots. The movies are even greenlit through these great comic book/photoreal frames that the look development department creates because they're going to capture the imagination. We may start down the final path even before we've got it on certain key shots. If you research and develop how the monster will look or how the new suit will look for one key shot, once you're ready to figure out what all the other shots are, you've done the legwork.

What innovations in previs help you do your job as the editor?

I've been in the position in movies many years ago where you didn't know what you're going to get from visual effects until it was too late to change anything. Today, we have a much more precise notion of what that's going to be, and the previs does get better. The artists get quicker at producing it, but our ambitions also rise. You always want to try to do stuff that's new and groundbreaking.

Every one of these films is a race against time. At a certain point, money isn't the issue—it's that you can't get anything done unless you have enough lead time. All these great tools are for us to gain clarity.

It sounds like your role is increasing on the development side.

Yes, more and more we're involved in the planning of the movie. I have mixed feelings about that because you still need the objective eye, to say, "No matter what everyone's good intentions are, here's what we're seeing." Because it's very easy to get bogged down in minutiae and not realize what's there.

My old boss Jon Favreau is a pioneer in mocap movies like *The Lion King* that are shot quickly in a three-dimensional space. Then later he can put the camera wherever he wants. So, in his world, the editor's role has really changed because classically we were the objective eye of what's already been done.

I'm very much part of the development process, but at some point, I still have to stand in judgment of all the hard work and be ready to throw things out. We pour our heart and soul, and sweat bullets and some very amazing artists go to great lengths, and at a certain point, we might go, "You know what? Let's remove this whole theme from the movie."

That happened on *Iron Man* when I cut out an effects shot which was attached to a scene that was problematic in a part of the movie. And I remember showing Jon, and he started sweating. He said, "You're going to cut that? That's like the best effects shot in the movie." And I said, "Yeah, but look what happened to the story. It's just clean now." That's the evolving role of the editor: you're involved early but then have to switch hats and achieve detachment.

What advice would you give a fellow editor working with virtual production for the first time?

Depending on the situation, go visit the previs team. Have a dialogue with them because a lot of times there's a game of telephone where you're telling one person who tells another person, and so on. Finally, it gets to the artist and then they don't understand your notion. The more you can directly interface with the artists, the more they have to work with.

Then be open to their ideas. Whatever your idea is going in, they may come up with the stuff that the team is going to be proud of. Just because they're told to do something one way, if inspiration is there, let it roll. Let it come out. It's all still going to have to go through a massaging process to actually fit.

Movies are like IKEA furniture—you always have more parts in the end than you're supposed to. These artists are pros, and if you haven't worked with previs before, listen to them, defer to them. Then be ready to ask yourself the important story questions. When people don't quite understand what they're looking at and are scared of it, they don't react with the right open mind. So I always keep an open mind.



Now we can make a lot more mission-critical decisions earlier in the process because the aesthetics of the renders look a lot better.



GLENN DERRY

Performance Capture

Performance capture is another area that has always been a part of the virtual production workflow. We include it here not only to survey its evolution over the years, but also to look at how it can be best leveraged to interact with other elements of the workflow.

Performance capture is actor-driven visual effects. By connecting the body and facial movements of a human being to a digital asset, more believable characters and emotions can be created. This is not to say that there isn't a place for manually keyframed animation in visual effects, but nothing communicates the subtleties of a living character to an audience more realistically than a human performer.

Performance capture can take the form of reference photography on an otherwise live-action set or as a fully virtual capture volume to enable performers to act within a more fantastical setting. In either case, the direct use of real actors permits a greater degree of interaction between visual effects, camera, and director than would be possible with post-produced visual effects.



Image courtesy of The Third Floor

Addison Bath from The Third Floor speaks to actors in performance capture suits for a previs session.



Performance Capture Interview • Glenn Derry

Glenn Derry is Founder and Vice President of Visual Effects at Fox VFX Lab. Fox VFX Lab offers a variety of virtual production services with a focus on performance capture. Derry is known for his work as a virtual production supervisor on projects like *Avatar*, *Real Steel*, and *The Jungle Book*.

How has performance capture evolved since projects such as *The Polar Express*?

In those earlier eras, there was no real-time visualization during capture. You captured everything as a standalone piece, and then you did what they called the director layout. After the fact, you would assemble the animation sequences from the motion data captured. Today, we've got a combo platter where we're able to visualize in real time.

When we bring a cinematographer in, he can start lining up shots with another device called the hybrid camera. It's a tracked reference camera that he can hand-hold. I can immediately toggle between an Unreal overview or a camera view of that scene.

The earlier process was minimal in terms of aesthetics. We did everything we could in MotionBuilder, and we made it look as good as it could. Now we can make a lot more mission-critical decisions earlier in the process because the aesthetics of the renders are a lot better.

What are some additional uses for performance capture?

Sometimes we're working with a pitch piece, where the studio is deciding whether they want to make a movie at all. We use the capture stage to generate what the director has in mind tonally and how the project could feel. We could do either a short little pitch piece, or for something like *Call of the Wild*, we created 20 minutes and three key scenes from the film to show the studio we could make it work.

The second the movie gets greenlit, we flip over into pre-production. Now we're breaking down the full script and working with the art department to create concept art. Then we build the movie's world out around those concepts.

We have our team doing environmental builds based on sketches. Or in some cases, the concept artists themselves are in Unreal Engine doing the environments. Then our Virtual Art Department (VAD) cleans those up and optimizes them for real-time use.

Where do the artists do their modeling and texturing?

The artists model in Maya, Modo, 3ds Max, and other packages, as we're not particular about the application as long as the output is FBX. The look development, which is where the texturing happens, is all done within Unreal. We'll also have artists working in Substance Painter and it will auto-update in Unreal. We have to keep track of assets through the entire process, all the way through to the last visual effects vendor.

How do you handle the level-of-detail decimation so real-time assets can be reused for visual effects?

The same way we would work on AAA games. We begin with high-resolution detail and then use combinations of texture maps, normal maps, and bump maps. That allows us to get high texture detail without a huge polygon count. There are also some amazing LOD (level of detail) tools built into Unreal which enable us to take a high-resolution asset and derive something that looks pretty much identical unless you're right next to it, but runs at a much higher frame rate.

Do you find there's a learning curve for crew members more accustomed to traditional production?

We're the team productions come to when they need real-time on live-action sets. That's pretty much all we do. That said, it requires prep, and if you want it to look great, you have to make decisions. If you were going to shoot rear projection back in the 1940s or *Terminator 2* with large rear projection systems, you still had to have all that material pre-shot to make it work.

It's the same concept in real-time virtual production. If you want to see it look great in Unreal live on the day, you can't just show up and decide. You have to pre-build that world and figure out how it's going to integrate.

The visual effects team and the virtual production team have to be involved from day one. They can't just be brought in at the last minute. And that's a significant change for producers and productions in general. It's not that it's a hard nut to swallow, it's just a very different methodology.

How does the cinematographer collaborate with performance capture?

There are two schools of thought: one is to work live with the director of photography and camera operators and shoot your tangible part of the action that's going on, with the camera as an actor in the scene as much as any of the people are. You can choreograph it all out live if you've got the performers and the suits. The other version of it is treated more like a stage play. Then you come back and do all the camera coverage later. I've seen DPs like Bill Pope and Caleb Deschanel, working in tandem with their camera operators, who just picked this right up.

How is the experience for actors working in suits and a capture volume?

One of the harder problems we deal with is eye lines. How do we assist the actors so that they're immersed in this, and they don't just look around at a bunch of gray box material on a set? On any modern visual effects movie, you're going to be standing in front of a 50-foot tall blue screen at some point.

Performance capture, is in some ways, more actor-centric versus a traditional set because there aren't all the other distractions in a volume such as complex lighting and camera setup time. The director gets to focus in on the actors. The challenge is getting the actors to interact with something unseen. We'll project pieces of the set on the walls and use lasers for eye lines. The quality of the HMDs today is also excellent for showing the actors what they would be seeing.



The visual effects team and the virtual production team have to be involved from day one.



GLENN DERRY

How do you see performance capture tools evolving?

I think a lot of the stuff we're prototyping today will soon be available to consumers and home content creators, YouTubers, and the like. A lot of what Epic develops also gets released in the engine. Money won't be the driver in terms of being able to use the tools, it will be your creative vision.

My teenage son uses Unreal Engine to storyboard. He knows how to do fly-throughs and the little camera tools we built—he's all over it. As it becomes easier to create photorealistic visual effects in real time with a smaller team and at very high fidelity, the movie business will change dramatically.

Something that used to cost \$10 million to produce might be a million or less. It's not going to take away from artists; you still need them. But you won't necessarily need these behemoth post companies because you'll be able to do a lot more yourself. It's just like desktop video: what used to take hundreds of thousands of dollars' worth of Flame artists, you can now do yourself in After Effects.

Do you see new opportunities arising as a result of this democratization?

Yes, there are a lot of opportunities. High-quality, good-looking CG assets are still expensive to produce and expensive to make look great. There are already stock sites like TurboSquid and CGTrader where you can purchase beautiful assets economically.

But the final assembly and coalescing of environments and characters is where there's still a lot of need for talented people to do that effectively. I can see companies coming out of that necessity. We spend a lot of time talking about assets because it's the core of everything we do. You need to have a set to shoot on, you need compelling characters, which is why actors won't go away.

What's happening today isn't even the tip of the iceberg. There's going to be 50 more big technological breakthroughs along the way. There's tons of new content being created for Apple, Netflix, Amazon, Disney+, and other publishers. And they're all going to leverage virtual production.



The real-time engine has provided an iterative process that enables us to build what is necessary and nothing more. We're able to get better answers way faster than ever before.



FELIX JORGE

Previs

As a previs creator, you're already well acquainted with virtual production. Previs has been a part of the VP ecosystem since its inception. What's changing is previs' role and methodology in the overall scheme of production.

While you might have previously conceived of previs as focused on the pre-production phase of a project and less integral to production, that conception shifts with a real-time engine. Previs is also typically a hands-off collaboration. In a traditional pipeline, a previs artist receives creative notes and art direction, then goes off to create animation and present it back to creatives later for feedback.

In the real-time model, because the assets are malleable directly and rendering time is not a limiting factor, creatives can be much more directly and interactively involved in the process. This leads to higher levels of agency and creative satisfaction for all involved. This also means that instead of working with just a supervisor you might be more directly interacting with the director, editor, and cinematographer to design sequences and shots earlier in the project, often right in the room with you as you edit the previs sequence and watch the results together in real time.

Previs image quality has continued to increase in visual fidelity. This means a greater relationship between previs and final-pixel image quality. When the assets you develop as a previs artist are of sufficient quality, they may form the basis for final models in visual effects. The line between previs and final pixel will continue to blur.

The efficiency of modeling assets only once is evident to all involved. By spending the time early in the project to create models of a very high quality, post-production begins at the outset of a project. Instead of waiting until the final phase of post to deliver the higher-quality models, the production has those assets from the beginning. And the models can also be fed into ancillary areas such as marketing, games, toys, and more.



Image courtesy of The Third Floor Visualization



Previs Interview • Felix Jorge

Felix Jorge is Co-Founder and Creative Director at Happy Mushroom. He's worked on dozens of blockbusters and has roots in previs. Felix started working with real-time engines in 2013. He served as the virtual art department supervisor on *The Jungle Book* and managed a full development team on *Jurassic World VR*. Felix also has extensive experience working with real-time visual effects pipelines, creating story-driven content, and troubleshooting live-action production problems via techvis.

Can you describe your current virtual production workflow?

We're living inside of Unreal Engine. And so we do photoreal environments, and we interact with production designers, art directors, and directors inside of the engine. The fidelity that we're getting is changing everything.

I was a previs artist for eight years, and we used Maya and MotionBuilder. And part of me deciding to found Happy Mushroom was trying to use the engine in a way that you bring that pipeline into the engine and show it as a stronger way to do previs.

Do you see real-time engines transitioning from previs to production?

Everything we build asset-wise, we do it for the traditional visual effects pipeline and the real-time pipeline. So we build assets that live in both worlds because we were native visual effects artists. But then that same previs asset, if it's photogrammetric or if it's photoreal, goes straight into a visual effects pipeline.

Is it easier to adapt assets originally developed for post-production into real-time or the other way around?

It is a lot easier to start from the get-go, knowing which pipeline that you want. When we start on a job and we know that we're going to build these assets for a production, we make sure that our high-res maps are there. We also structure everything in a certain way.

We've also built tools to track every single element, so that the moment that it's time to deliver, we push the tool, or we push a button, and it'll collect all the higher-res assets and the real-time assets and send it to a post-production house. It's more manageable if you plan and you know that's the pipeline that you're trying to follow.

How do you optimize real-time assets?

We get the highest quality-real-time asset because we kick out the highest possible cache maps or 3D meshes. Those aren't touched, and those are the ones that you would use in a traditional visual effects pipeline. We always start with making an extremely high-res, high-fidelity asset that looks photoreal, and then we create the real-time asset from that.

How do you communicate the virtual production workflow to producers who are new to it?

Whenever we create environments, we do it in stages. We typically start with blocking, which comes from an art department, and since we live in a real-time ecosystem, before textures and photogrammetry we place cameras with people in headsets in the grayscale environment. This allows us to be informed by the director and the DP at the earliest stages. The real-time engine has provided an iterative process that enables us to build what is necessary and nothing more. We're able to get better answers way faster than ever before.

Because we have an ecosystem where five people can each jump into a VR headset, we're doing remote sessions over the Internet. We're not just making previs assets; we're making final assets that start at grayscale and progress to final quality assets that can carry through post-production. As a previs artist, I saw my work get thrown away all the time once it came time to do the final version. Now, we can do previs work that is more meaningful in the film.

What technological advancements helped enable final pixel in real time?

One big leap is lighting fidelity. We've been lighting in the engine for a long time, but this past year with the addition of light baking and the global illumination, we tested between V-Ray and Unreal. We have them posted on our [website](#). The quality of the bounce light that Unreal Engine is giving us is as good as a final render from V-Ray or RenderMan.

How about tech advancements on the hardware side?

We're using NVIDIA 1070s and 1080s. We also use a swarm server and we bring it with us wherever we go. We have a couple of Intel processors, and they're churning everything. The rendering has gotten a lot quicker and our video cards are tearing up entire scenes.

Do crew members take higher-quality previs more seriously?

As someone who started in previs and later got into finals, it used to be previs and finals didn't mix. And part of what's happening now is that because the fidelity of the engine has increased, the two areas are overlapping more. As soon as we started using Unreal for previs and improving the quality of our sets and improving the quality of our lighting, we got a lot more attention. People wanted to use the engine to get closer to their vision. They want to be able to inform a full production about their desired look and mood.

How does LED wall virtual production come into play?

It's going to change the way films are made entirely. We're doing a lot of tests with it. We're pushing the engine in a lot of different directions and testing the ray-tracing aspects of it. We can hit 90 frames per second on a pretty standard computer and have photoreal, production-ready environments on a decent scale.

I see it as a similar business model to mocap, where you can arrange a stage and get practically unlimited amounts of footage. It's a revolution for asset creation, set design, production designers, and DPs. If you're shooting in front of an LED screen into Unreal, you can modify your environment live on set. It feels like you're shooting a production with classic rear projection as they did in the '40s.

It can also cut the amount of time by more than half if you're on an episodic series. For the first season, you build most of your assets. On the second season, you're going into the stage to shoot whatever you want. The savings per minute is just insane.

How do you align the virtual screen with the live-action set for extensions?

We typically do photogrammetry of the area so that we have it exactly the size that it is. But on the day when you bring that 3D environment, we do a LIDAR scan, which gives immediate point data, and then we align it using the point data. It's virtually impossible to mess that one up once you do the LIDAR.

What are the limitations of the live-effects approach?

Big blockbuster shots that are coming out from outer space or long panning shots are not the best shots for this kind of technology. But part of the beauty is because you're making photoreal environments on Unreal, you can kick out those assets for visual effects. They can then rebuild your environment and create the shot within a traditional visual effects post-production pipeline. The difference with this new technology compared to old-school rear projection is it's tracked and the parallax is real. So there's a lot more subtlety and you're able to get a lot more in camera than you'd think.

How do you involve the creative team in previs?

Directors and DPs are our biggest fans because now we work with a production designer. He's able to create an environment at a much higher fidelity than it used to be in previs but in a fraction of the time. We do a photogrammetry capture of the space, and then we cut it up, and the first pass looks fantastic. The director can then come in and jump in a headset or literally just stand there and look at an environment that is not only a 2D image, but something that's representative of what might actually make it into the final product.

We find that directors are very attracted to that and want to direct and show their shots. They're placing cameras, and everyone can see what they're framing. It used to have to wait until the previs shot was rendered out, now everything's happening live. Everyone's more interested and engaged in working in the same live previs environment.

Part of what we're working on right now is building infrastructure, making sure that we're growing at a healthy rate. It's a technical field, so we're trying to build our engineering teams so that they could support the content team, which is super important, and maintain the speed at which we're moving. I'm pretty excited about where the engine and the technology are headed.



The benefits are that the creative individuals have much more say in what is happening. From a fiscal point of view, studios and producers and everybody associated can get much more definitive budgets.



GUY NORRIS

Action Designer / Stunt Coordinator

In your work as a stunt coordinator, virtual production represents a huge leap forward not only in the complexity of stunts you can achieve, but also the degree of experimentation available to you for developing concepts. Stuntvis is its own specialized form of previs where the stunt coordinator uses virtual production tools to simulate stunts using real-time animation and with real-world, accurate physics. Above all, you'll have a higher degree of safety through the extended ability to design, analyze, simulate, and present concepts for stunt work.

Scenes featuring real-time LED walls add another new dimension to your toolbox. You can create live stunt sequences that look incredible but are no more dangerous than walking in front of a movie screen. Careful integration between the foreground set and its extension into the LED wall can create highly believable sequences.

Performance capture is yet another area where you as stunt coordinator can highly benefit. If a project requires non-human characters to perform specific stunt sequences, you can use performance capture to apply the motion of stunt performers onto completely digital characters. This can also be combined with visual effects to create the appearance of non-stunt performers performing complex stunts.



Stuntvis prepared for "Mad Max: Fury Road" leverages real-time physics in Unreal Engine.



Another view of stuntvis prepared for "Mad Max: Fury Road".

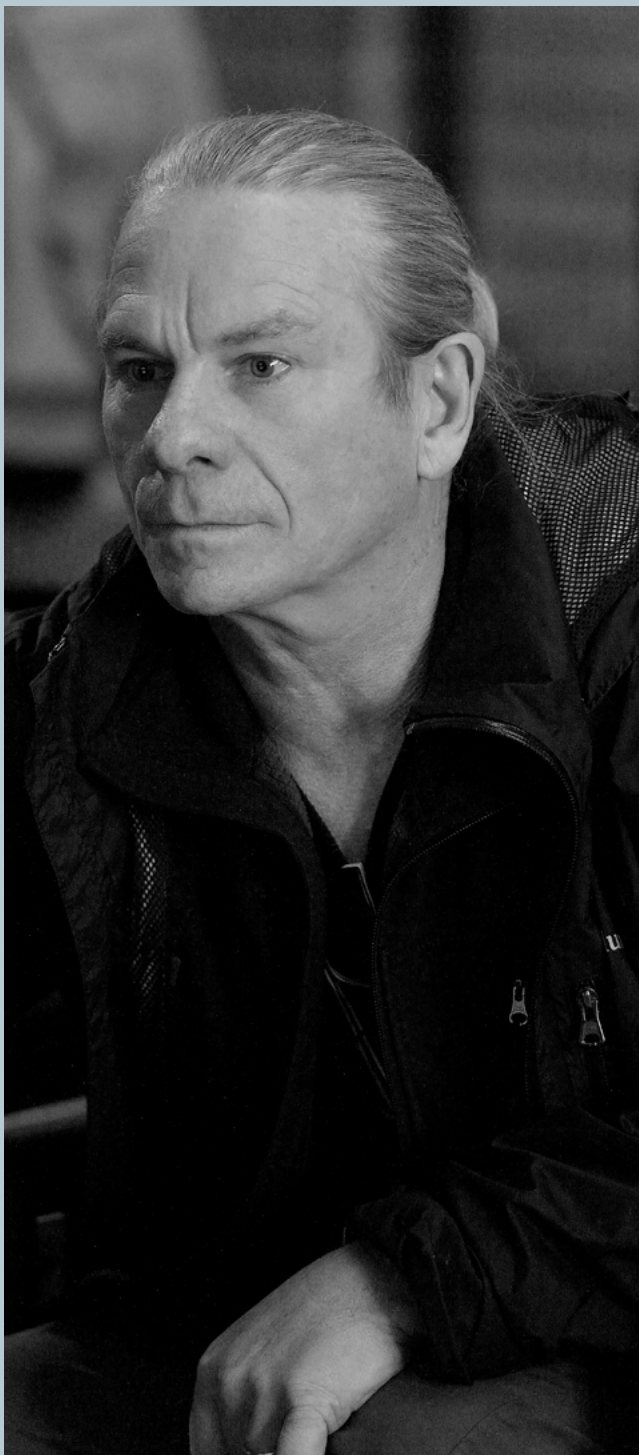

Action Designer / Stunt Coordinator Interview • Guy and Harrison Norris

Veteran Action Designer / Stunt Coordinator [Guy Norris](#) is best known for his work on *The Road Warrior*, *Stealth*, and *Mad Max: Fury Road*. He now regularly works with his son [Harrison Norris](#), whose credits also include *Mad Max: Fury Road*, together with *Suicide Squad*, *Ghost in the Shell*, and *Triple Frontier*.

Can you describe your work with stuntvis?

Harrison Norris: Whereas typical previs is a shot-by-shot tool for either a studio and budgetary comfort level or for VFX bidding and clarity, stuntvis is more of a full sandbox that all departments and creatives can actually have an input on. We capture all of our action for an entire sequence at a time. No matter where you want to place a virtual camera, rather than creating by shot and animating by shot, all the action exists in space no matter where we put the camera.

For example, on *Dark Phoenix*, we had entirely different variations of costumes and there was a lot of debate over which one would be used where. Because of the way that we work, it was incredibly easy just to switch out different costumes on these character models, run the exact same shots for the exact same sequence through an edit, and the creatives could watch multiple versions of the one action sequence with the characters wearing different costumes, and see them all in motion. They could decide which colors they liked in the environment they were in and make a decision before the costume was even finished.

What are some collaborative aspects of the process?

It's a creative sandbox where everyone can have input. With typical previs, it's quite isolated, and as it takes so long to turn around minor changes, there is not room for everybody to put their two cents in. The fact that we are able to do this so rapidly means everybody can freely contribute. Unreal allows us to have this action and this sequence exist in a digital space continuously, and then we can change any environmental or blocking aspect or lighting aspect around that. As it all renders in real time, it is incredibly beneficial and an incredible time saver.

How has the stunt industry evolved over the years?

Guy Norris: When I was doing the *The Road Warrior* in 1981, I was a 21-year-old and it was about how far you could jump, how far you were happy to fall, what was your fighting like, and so forth. There was just the physical skill set. We did not even have safety cables when we were doing transfers from the vehicles because there was no facility in those days to remove cables.

Fast-forward to *Fury Road* and we were able to take the physical capabilities of a human and just explore those to the absolute nth degree. So what people do not get to see

when they are watching the film is all of those sequences were elaborately rigged, so we would have rigs, trusses, safety cables. Everything was totally real, all the stunts were done in camera, but we had a fantastic safety system to back all that up.

How does performance capture impact stunt design?

My work is all about time and motion study. So whether it is cars, people, environments moving and colliding, it is really about the fidelity that we can achieve using the inertial capture suits, which is exactly the same as having human movement. That is the most important thing. So that when we can actually transfer that into our system, when you are seeing someone do a roll, you are seeing someone leap, or you are seeing someone on a pole, all those physics are entirely real because that is how we are capturing them, so we sort of get two bangs for our buck.

When we are rehearsing, we are doing all of what we would normally be doing on a film set; we're simply also wearing a capture suit so it allows us to take that information into a digital world, expand it there totally first, and then reproduce it back out again when we get a time to shoot it.

What are some other benefits of virtual production?

We are able to explore any ideas that we have in a digital world first, and we can share that with the director and the other crew members. We can try whatever we like because we are in the digital space. We can always do more than we could in the physical world.

Secondly, it becomes much cheaper because we are not rehearsing with 50 people for three months. We may go out there for several weeks and do capturing, but once we have captured the physical performances then we can vary those performances inside of our digital space. We can decide where we would like to put the cameras and design the whole sequence, and we are doing that once we have already got the capture. So from a cost point of view, it is much more effective.

From a creative point of view, it allows us much more exploration in the very beginning. From a safety point of view, it allows us to explore all the issues that we would have in a digital world, so we are aware of them and know what we have to look out for in the physical world.

How significant is adding a real-time engine into the process?

It is a total game changer for us because Unreal gives us the instant flexibility with our capture system of being able to change the action whenever we want to. So if the director suddenly decides, “Look, that looks great, but can I see what those ten cars with those guys look like on the other side of the tanker?”, we can do that.

If we are in a battle sequence and the director says, “Look, I love it, but what if we had 50 warriors instead of 20?” or, “Hey, what does it look like with 100 Indians coming over the hill?”, these are the things we can actually show the creatives instantaneously, whereas in the past, that would have all had to have been hand animation. It allows us to make those changes really rapidly, and it means a creative toolset is used to its full benefit.

How does VP influence your interaction with other departments?

The reception from the DPs has been extraordinary in the fact that they have been much more inclusive and collaborative. I think it is because we have been able to deliver to them a toolset that becomes very close to what they are working on in the actual day. When we were doing *Dark Phoenix* with Mauro Fiore, he could actually affect the lighting on our streetscapes. He was able to dim headlights in night sequences, he was able to turn up or down the intensities of the streetlamps that we had. So that gave him a good understanding in the digital world of what he would actually have to do on the set.

We can also involve our production designer as early as he would like. We can show very rapid changes from his design on colorscapes, palettes, of what he is trying to get across to the director, and the director can respond to that straightaway. We can show the wardrobe department what their wardrobe would look like. It goes then to the first ADs where we can actually help with their scheduling, based on being able to visualize what we are going to be shooting for a given day. They can then do breakdowns of numbers of personnel in that sequence, how many extras, when to do a particular shot, and so on. It becomes a tool that everyone gravitates toward because they understand that it helps them do their job better.

A really good example: in our recent project for Netflix, *Triple Frontier*, there were quite a few sequences inside of a helicopter where there is a lot of rapid movement and the action also involves a crash. And when we are actually able to show the actors via stuntvis a digital world of their performances, where they would be inside of that space, it was quite comforting for a lot of them to understand, “Okay, well, that is where I am, that is my space. I will work with that area. Oh, now I understand how much is involved. Now I can really understand what is happening to my character through it.”

What’s next for stuntvis?

When I first started, it was storyboards, then it became previs. I would love to see our system of real-time digital production become a standard in the industry. The benefits are that the creative individuals have much more say in what is happening. From a fiscal point of view, studios and producers and everybody associated can get much more definitive budgets.

When you are talking about films today at a high level, they can cost anywhere from \$250K to over a million dollars per shooting day. So if you have the ability to use any system that can save you multiple days during the course of filming, then that is something very useful. On *Triple Frontier*, because we were able to design the final beach chase so exactly, we saved them three main unit days, which was well over a million dollars. It does really tick both the creative box and the fiscal box. So in the future I would like stuntvis to be part of everybody’s filmmaking tools.

“

It’s a creative sandbox where everyone can have input.

”

HARRISON NORRIS



There needs to be a willingness to completely embed and be prepared to commit to a fully digital workflow with shared assets from the beginning to the end of the production, pre-production to post.



ALEX MCDOWELL

Production Designer

Production design is another area of movie creation that has been transformed by virtual production techniques in the form of provisional imagery. Advances in CAD design have already been happening for decades in set design and construction, making pure 2D drafting techniques increasingly rare in production design. The addition of real-time engine technology supercharges this approach and provides a variety of benefits for the production designer. Let's take a look at these benefits below:

Virtual scouting of set designs enables you as the production designer to view and share a highly realistic simulation of the planned set designs. You can view sight lines, determine if all desired camera angles will work, and make decisions on how much set to actually build. This empowers you to deliver precisely the set designs needed with much higher accuracy and cost efficiency while also enabling more experimentation during development.

You'll also enjoy a closer interaction with key collaborators such as the director of photography and director. With virtual production, the level of abstraction is much lower compared to reviewing traditional set design blueprints and architectural illustrations. The entire team can see the set in a form much closer to how it will look in real life and be able to provide feedback that doesn't have to wait until closer to production when changes are more difficult and more costly.

Production design is further transformed via virtual production with real-time LED wall technology to seamlessly blend foreground sets with digital set extensions. You'll be able to create more fantastical and elaborate set designs than ever before. This requires close coordination with the virtual art department in order to determine which portion of the foreground set should be built and where the virtual wall set should begin.

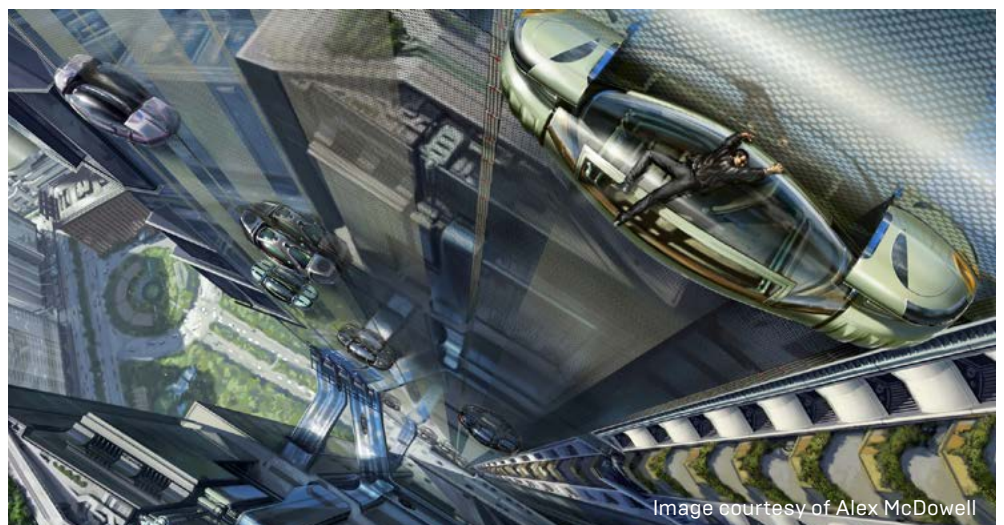



Production Designer Interview • Alex McDowell

Alex McDowell, RDI is a production designer and advocate for world building and immersive design. He's the director of the World Building Media Lab at the University of Southern California's School of Cinematic Arts. Alex's credits as a feature production designer include *The Crow*, *The Terminal*, *Minority Report*, *Watchmen*, and *Man of Steel*.

Can you talk about your career trajectory?

I've changed roles pretty dramatically, and I don't do pure movie production design anymore. I teach at USC, and I have an experience design studio which is cross-media/platform agnostic. We're doing a lot of world-building, which evolved out of my work in film and is very connected to virtual production.

We launched in features first but generally found that virtual production wasn't being fully exploited some years ago. There was enormous conservatism in the film industry around new methodologies and new technologies. Usually, my work is collapsing previs and postvis completely.

What was your initial experience with virtual production?

It began with *Minority Report*. The simple reason is that we started work without a screenplay. The movie didn't have a script for about 12 months, at least in a sense that they were ready to commit to it as a linear narrative. In many cases when there's not a script, the studio shuts the film down or keeps it in the writing phase, but Steven Spielberg was prepared to continue to fund an art department. With *Minority Report*, we had to build a world, and that meant defining all the holistic components that would make up the narrative before the narrative existed.

We never know exactly where the camera's going to point so we are always in previs mode, and we are preemptively imagining how the director, cinematographer, and the actors are going to control, behave, and use the space that we're either building or finding as locations. We were defining world-building as an entire methodology for preemptively designing the cinematic space as a full world of options. In the case of *Minority Report*, that was Washington, DC in 2050.

With a synopsis of about a page from Steven, we had to extrapolate the volumetric outcome of the architecture, the space, the journey, the choices, and all the way into technology. We developed the vehicles, all of the interfaces, how the environment moves. So, the full package. That was in previs, which evolved into what I would call "d-vis", which is design visualization.

I would make a solid definition between the idea of developing a global space in relation to the narrative intent.

It's working with a set of rules defined by a film workflow combined with a world that was 40 or 50 years in the future. The rules end up being interpreters for that world and how all of the pieces interconnect. We continued to do that on *Man of Steel*. We developed all of Krypton, and then a slice of the narrative was taken from Krypton.

Did earlier methods of pre-baked previs present issues for your workflow?

My challenge as a designer is that in many instances, the previs comes from when the director is in writing mode. A lot of assumptions are made based on the script, but when it gets cemented into digital space, decisions are being made that bear no relation to the reality of the production.

We've been presented with previs for a scene that would have cost millions of dollars to execute and only had thousands of dollars to make it real. So there's a big downside with previs unless it's informed by all of the moving parts. The most basic: how tall the walls need to be, but really what the possibilities are of moving a camera. Then really before that, a director making decisions based on what I would call a location, whether it's a set or it's an external location. Either way, the director's standing in the space and making a decision based on what's there. How the director thinks and works in a real environment is not generally what they were allowed to do in a previs environment because they didn't connect.

On the other hand, with *Minority Report*, there were sequences built by Steven Spielberg which were very specific to what Tom Cruise was doing and how he was connecting with a particular piece of the environment that he was engaged in. Our visualization of the vertical highway is almost frame by frame a match to the final film because Spielberg is working within components that were already built by us: the size of the car, the way it moved, and how he's moving his camera through that space.

One thing that came out of *Minority Report* was a very close relationship with post-production and visual effects. As time goes on with films like *The Jungle Book*, there's very little differentiation made between pre-production and post-production. Previs and postvis, if done intelligently, are the same thing. If all of the decisions you're making tie together and reflect the intent of the film as a whole, then you make no differentiation between the virtual and the physical, or any combination of the two.

Have real-time tools enhanced your workflow?

Yes, absolutely. My earliest experience with real-time was with Habib Zargarpour, who designed a virtual camera tool. Not the first, but the most effective that I'd ever worked with, where we were working together and moving sets into digital space. The immediate impact for me was the necessity for real-time where you're actually in a fluid, proactive, constantly evolving design space, interacting with the camera and presenting the director with the constraints and opportunities.

Then I got deeper into games and paying attention to game engines. I had a design company called 5D, and we worked in early development on *The Jungle Book* with Jon Favreau. We pitched the idea of virtual production in the sense of building it all in a game engine and creating all of the components in real time. Jon Favreau fully understood it, and they ultimately developed a fantastic system which became the default for smart studios.

Later, on *Man of Steel*, we set up parallel virtual environments for director Zack Snyder. He had a full system at home that matched the system we had in the art department. So we were taking him through sequences in VR and comparing notes in real time.

The capability is so advanced and sophisticated and has such promise, sort of pervasively, that it is still shocking to me how conservative producers are in committing to that at the front of pre-production. There's still a lot of thinking about this as post-production. There needs to be a willingness to completely embed and be prepared to commit to a fully digital workflow with shared assets from the beginning to the end of the production, pre-production to post.

The more this happens, the more you create efficiencies that are solved in pre-production. That means that what you shoot is predetermined as being more efficient and cost-effective to do in camera, and which shots are better suited to post. There's a fully holistic production capability that's sitting there.

We use real-time on every single tiny element that we do in my design studio. Our whole team understands it, whether they're architects, engineers, illustrators, developers, or graphic designers. It's become pervasively available.



Image courtesy of Alex McDowell

What's the most critical information provisional imagery can convey to a production designer?

The goal is taking the intent of the narrative, whether it's fully scripted or still a synopsis and combining it with the input of the director, producer, and writer. Then, as a designer, you extrapolate the components that are most important for the world to exist. For example, on *Man of Steel*, you're building the entirely fictional world of Krypton and its fundamental tools.

We start with illustrators, prop designers, and set designers all sketching out the possibilities of the components with lots of 3D. We're developing the logic of the world. We're taking the intent of creating Krypton, and we're running with it. We're using those visualization tools to demonstrate and pitch to the director how our design can satisfy his needs.

My process as a designer is not to take a script literally because the writer is not a designer. They're not thinking about the possibilities of the environment; they're thinking about the needs of the actors and the characters and the intent of the story. The writer is thinking about how the story engages an audience.

The script allows the director to start moving that story into a visual language, but there have been very few scripts that I've been involved with that define a world and the look. So we take the logic that the narrative requires and use our tools to develop that into a substantial environment which allows the director to inhabit that world.



So it's up to us to figure out—put down crane track and use a crane or an arm or a dolly and all the different tools that we have out there to make that shot happen.



KIM HEATH

Virtual Imaging Technician/Grip

As a grip on a traditional movie set, you have the responsibility of setting up camera rigs, controlling natural light, building lighting grids, and many other vital tasks. On a virtual production, your duties are similar, but the workflow will be different and often more free-form and evolving.

Here are some examples of tasks you might be called upon to perform:

On a performance capture or virtual camera (v-cam) production, that is, where the camera crew is operating reference cameras to capture animation within a real-time engine, you may be called upon to do many familiar tasks. For example, you might rig up a dolly on tracks within a motion capture volume. Instead of having to build a track around and over obstacles, you'll be more concerned with securing optical motion encoders into the gears of the dolly wheels.

There may be a scale factor between the physical crane or dolly track you build and its virtual equivalent. Let's say you wanted to make a 150-foot dolly move. In this case, you would work with the real-time artists to scale the real physical movement from a 10-foot stretch of track to drive a 150-foot virtual move. You can consult the operator to make sure the dolly is geared down enough to feel like a much longer move. And instead of using tape measures, gaffer's tape, and lasers to set dolly marks, you'll be able to set limits within the digital set and never miss a mark.

You might be asked to build a truss above the capture volume. Instead of lighting, the truss could be used to hang motion control trackers or witness cameras. You'll build special cranes, sliders, and handheld units that incorporate tracking sensors so they can be tracked in 3D for the real-time engine. Sometimes there may not even be a traditional camera, but a stand-in you'll rig onto the dolly, crane, or handheld with all the standard camera accessories and similar weight and feel for the operators. In other words, you're responsible for translating the look and feel of a more traditional production into the virtual production world.

You might find yourself in a virtual reality headset (HMD or head-mounted display) on a virtual scout with the director and the DP inside the real-time engine, seeing each other and the environment. You might physically move items in this virtual world with a hand controller. Your knowledge of the physical grip world will be invaluable in helping to ground the virtual set.

If the production involves a real-time LED wall, you might be tasked with helping set up the modular wall itself. This work can include fitting together individual 27" LED panels onto a support platform and then wiring them to each other and back to a video scaler. Sometimes a single flat LED wall is not enough to cover the desired action, so you might be asked to help to create an amalgam of multiple LED walls at different angles and curvatures.

When it comes to lighting, DPs often supplement the reflections and indirect lighting coming from the emissive LED wall with additional movie lights. So could find yourself hanging SkyPanels near LED walls and cabling them to sync up with the output of the real-time engine.

Although you'll be working in a single location, you may need to make video village more portable. The DP will be operating their shots more from this village than they would generally, since they will be seeing the real-time virtual action only on a viewfinder or monitor and not directly. You'll be responsible for rigging a collaborative space where the department heads can have the tools they need to collaborate in proximity.

The bottom line is all the familiar tools you currently use, like apple boxes, c-stands, and truss rigs, speed rail, still find a home on a virtual production set. They will just be used in new ways. Discovering these methods to enhance production is a collaborative effort.



Image courtesy of The Third Floor

Grip Interview • Kim Heath

Kim Heath is a veteran key rigging grip. His projects range from *City Slickers* and *Dances with Wolves* to *Apocalypto* and *Terminator: Dark Fate*. He also has experience working with virtual production on projects like *The Lion King*.

Can you describe your role on a traditional film production?

We grips do several tasks, but the main one is rigging for the cameras and doing all the dolly moves. We talk with the director of photography, and he'll say, "We want to start the camera lens up here and we want to end up over here." So it's up to us to figure out—put down crane track and use a crane or an arm or a dolly and all the different tools that we have out there to make that shot happen. We also rig the camera onto a car for stunts, like I just did for six weeks on *Terminator*.

The key grip is the head of the department. You have the best boy who is your right-hand, orders all the equipment, personnel, does time cards, and so on. Then you have the dolly grip who does all the camera moves with the camera operator. So it's kind of like a ballet between those two crew members.

The second main thing we work on is the lighting. The electricians come in with lights, plug them in, and focus them. Then we come in with flags and other setups. We put shadows on the background, soften the actor or actress, and generally do a lot of finessing with the art of the lighting.

On location, we also control the sun over the set, because the sun moves all day long. That includes placing construction cranes and big 50 × 80 overheads, for example, to take the sun off the set. We can then film all day without worrying about the shadows in the background moving. On stage, we're responsible for moving set walls.

How does your position change on a virtual production?

They initially hired me on *The Lion King* to rig the motion capture stage, which started as an empty warehouse with drywall and pipes. I came in and designed and built a truss rig. Magnopus gave me a plan of what they wanted.

I came up with the structural design—that's what us grips do as well. We come in and build those rock-n-roll trusses so the electricians can hang lights. We hung OptiTrack cameras and lighthouses for the VR HMDs. Then they asked me to stay on to be the key grip for the production.

It was all so new. We knew what we wanted to do, but we didn't quite know where to necessarily start when it came to integrating the real world with the virtual world because it had never been done before. We made a dolly out of speed rail, and we had about 20 feet of track with encoders.

We also had a jib on a crane. Even though that crane arm was only five feet long, we could scale its size to whatever we wanted to in the computer. The computer needed to know where the crane arm pivot and the rotation was. So we came up with a setup so that the gearing knew where and when we were padding the arm. A little encoder for the gearing was sending ones and zeros over to the computer.

We also built a much smaller slider with a gyro for crash camera shots. You want to be able to push the slider with your hand as if a real camera were on there. I designed and built that, and we did the same gearing with the encoder. So, we could be a real dolly while the DP Caleb Deschanel, ASC was using his wheels to operate a virtual camera on a tripod. Usually, the camera operator is on a dolly or on the crane and looking through the lens of the camera.

We placed little LED lights so that the OptiTrack cameras up in the truss could see our handheld camera rigs. Then the real-time engine, knowing where you were on the floor, does its thing. We were running around the stage with those rigs that I did and able to use the real Steadicam with the Steadicam gear and everything, but no camera on it. I just had these lead weights on there so it felt like you had a camera on there.

Describe your collaboration with the real-time engine crew.

Well in the beginning, you didn't know where you were in the virtual scene as you made real camera moves—if there was a tree behind you or right next to you, or a rock face right next to you, for example. Then I would move the crane back and you'd go into the wall of the animation. So, we had to come up with an overhead view of where you were in space that the crew could refer to. I need to see where we set up the crane and where we are.

It was a learning experience for the first three months of the movie, but it was also a lot of fun. I helped the real-time folks out. Things like telling them how it is in the real world on a traditional shoot and this is what we need to know in the virtual reality world.



Image courtesy of Epic Games



It's more real for the actors. Can you imagine sitting on a train set for a week on a green screen? Virtual production allows you to be there. Everybody feels like they're on a train, and that is an immeasurable help to the actors and the director.



SAM NICHOLSON, ASC

Visual Effects Supervisor

Any visual effects supervisor active within the last couple of decades is already well acquainted with the utility of virtual production as a planning and revision tool in the form of previs, techvis, and postvis. Your department is now on the precipice of a revolution on par with its progression from optical to digital compositing and the advent of CGI animation. Real-time live visual effects via LED walls and screens enable final-pixel visual effects to be achieved live on set instead of relegated to post-production.

Virtual production brings both new benefits and new challenges to the visual effects department. On one hand, you'll be able to deliver visual effects live on the day without compromises, ready to go into the edit without temporary placeholders. On the other hand, it also means that many of the creative and technical decisions that are normally deferred until much further downstream in the schedule will need to be settled earlier in the production.

Many of the key challenges of traditional green screen compositing go away with live virtual production. For example, green screen spill goes away because there is no green screen. In its place is the actual desired background which means you get desirable reflections instead of spill. Check out any of the space sequences in the film *First Man* to see how believable and natural the exterior reflections achieved through live LED projection look compared to more traditional post-production composites.

In order to take maximum advantage of virtual production, it's also helpful to conceive of the emphasis of work as inverted when compared to a more traditional visual effects workflow. Instead of the lion's share of the work happening after production and in the run-up to final delivery, virtual production for live visual effects presupposes the greatest visual development and finaling during pre-production and leading up to production.

You may also identify potential adjustments in the skill set of visual effects artists who comprise your team. Traditional modeling places the highest emphasis on visual fidelity with render times measured in up to hours per frame. Real-time virtual production shifts the priority to real-time performance, with frame render times expressed in fractions of a second, up to 60 frames per second and sometimes more. Assets need to be created with efficiencies in mind and optimized for real-time playback.

Visual fidelity is of course still the main goal, but as a corollary to real-time playback performance. You'll want to seek artists with experience modeling and optimizing assets for real-time. Their backgrounds might include game asset development as well as traditional visual effects work.

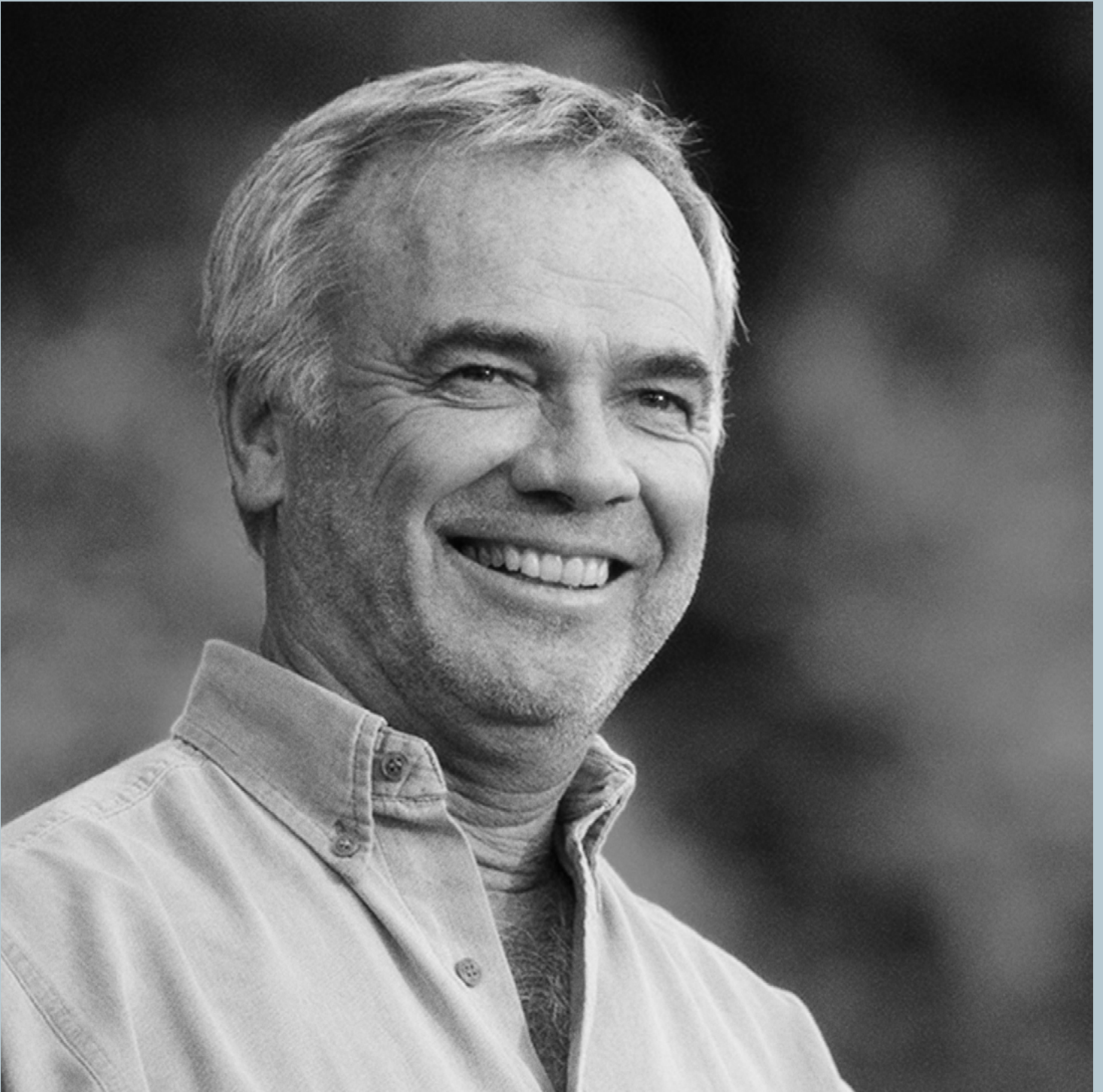

Visual Effects Supervisor Interview • Sam Nicholson, ASC

Sam Nicholson, ASC is a cinematographer and a visual effects supervisor. He's also the founder of the visual effects company Stargate Studios. Sam's credits include *The Running Man*, *Heroes*, *24*, *Pan Am*, and *The Walking Dead*.

What are the benefits of virtual production compared to traditional green screen cinematography?

Virtual production is a tool that opens up whole new areas and styles of filmmaking. Traditional visual effects have taken green screen and filmmaking out of real-time and into a serial pipeline, which is creatively damaging. I've shot green screen my whole life, so now I'm going after what would be a nightmare for green screen artists: hair, shallow depth of field, reflections, and interactive light.

Virtual production empowers the DP, the director, and the actors to collaborate much more directly. I can work with a director who's never seen this kind of system before and is not a DP. I could drop in and give him a camera and say, "If you see something you like, just shoot it because it's all right there, live". We get all this great-looking footage that is precisely what he wants because he can see things and adjust them live.

We also have two or three [DaVinci Resolve](#) systems in-line, so we have total control over foreground color and background and all the same tools that we have in traditional compositing. We are also tracking the lens in real time, so we have accurate focus. We can put the screens at infinity, which is really important. You have to be able to trick the eye so that the screen doesn't look like it's 10 or 15 feet away—it looks like it's very far away.

Describe your work with live LED compositing.

We've created what we're calling the [ThruView](#) process, which is real-time cinematography and compositing using LED screens and monitors. There's a massive difference compared to green screen because suddenly everybody can see it live. We're also directly synchronizing movie lights to the playback using [MadMapper](#).

We recently did a project in Beijing where we shot 50-60 setups a day in different real-time environments. These are little videos where they're putting two people into virtual locations photographically—they're on a cruise ship, in Venice on a water taxi, on a beach in Bora Bora. It was a lot of exteriors, interiors, every lighting setup you can think of. We never moved a light in two days—everything was automated and it worked great.

We also did a pilot for HBO called *Run*. We bid it at 350 green screen shots because the whole series is set on a train. We decided to do it live instead with 20 4K LED

monitors surrounding the train set. We synchronized everything with off-axis tracking, and it worked great. HBO was thrilled with the results, and they're going to series on the pilot now.

How do you integrate on-set lighting with virtual production?

We designed custom lights because I couldn't find any lights that would respond fast enough. So, we created lights with 126 DMX addresses per light, which gives us a high level of control. I actually started doing real-time lighting way back on *Star Trek: The Motion Picture*, with the V'Ger set and the engine room on the Enterprise.

How can a crew take maximum advantage of live LED production?

If you have a client that doesn't know what they want—where exactly is the talent driving in New York?—they don't know, so they just put a green screen up. You should make up your mind that it's going to be at Fifth and Madison or something like that. Then shoot the plates and make sure the plates are steady because you can't stabilize in real time. Everything has to be perfect going in, and the mantra of "fix it in prep" is real for virtual production.

Your models have to be perfect, and they have to be optimized for real-time playback if not high-speed playback. Your plates have to be stable and should have high dynamic range, so you can get what you need out of them. Your screens, cameras, and lights have to be synchronized.



Image courtesy of Stargate Studios

Live LED wall virtual production creates final-pixel imagery in camera.

You get all those things done in prep, and you've got a good chance of making it look good. Then it's a matter of, can your crew handle the challenge? This is more like theater than the more traditional "If it doesn't work today, we'll fix it tomorrow" approach. Virtual production is a high-pressure environment in real time.

Virtual production comes with a whole new set of considerations for visual effects people. Now they're part of principal photography and no longer part of post. It's going to separate those who are prepared and doing their homework up front from the people that want to get on set and figure it out later. If you haven't figured your game out, go with green screen. If you know exactly what you want and you want to get there fast and have a great-looking product, go with virtual production.

How would you compare the economics of virtual production to traditional visual effects?

We're currently matching green screen pricing, and guaranteeing at no additional cost any fixes that might come up. On the *Run* pilot, we estimated 350 shots. Here's what it's going to cost on green screen, and in virtual production, we will do it for the same price in camera. If anything needs fixing, if you shoot off a screen or get moiré, we will fix it for no cost. Out of 350 shots, we didn't have a single fix. We estimate the savings will grow a lot over an entire season's production.

How do editors interact with virtual production?

Half the problem is you have 25 people working on different shots in green screen. Once you've cut it all together and this artist didn't get his comp exactly like that one, and that element is out of sync with this one, and so on. Nine-tenths of green screen issues in editing are continuity, because you have many different people working on little tiny pieces and they don't know where theirs fit. With virtual production and live compositing, everything is all there.

The editors also get a lot more to work with because every single take is composited. So editors have full flexibility as if it were regular live-action footage. You're editing out more material by far than you're using, which is crazy in visual effects. If the editor wants to unlock the picture and change things, they can—and they never have to go back to visual effects.

How do actors respond to virtual production?

It's more real for the actors. Can you imagine sitting on a train set for a week on a green screen? Virtual production allows you to be there. Everybody feels like they're on a train, and that is an immeasurable help to the actors and the director.

The DP is also more involved; you can see it. The actors' eyelines are correct. The lighting is correct. When you go through a tunnel, the lights do what a tunnel does, and when you do pickups at line whatever inside the tunnel, the lights are exactly in sync. When you cut to a close-up with yellow lights from the wide shot, the same yellow light is on your face in the close-up. That type of synchronizing in green screen is very difficult because it's the continuity over the edit that we struggle with.

Is there a crossover point between live and traditional visual effects in terms of efficiency?

The big wides are always expensive, and they're wonderfully fun to do because you really get to exercise the visual effects engine. How many zombies can I put out on the horizon when the army comes over the hill, or whatever. But eventually, you get into what is 85% to 90% of the movie—the medium shots and close-ups in dialogue. That's where green screen can look the worst, when you get in close on hair detail, and you see the reflections in the actors' eyes are green.

Virtual production in real time gets better as you get closer. When you pop in for your close-ups and dialogue in camera, you're golden. In *Run*, when we did the big wide shots like running down the side of the train, it was not worth it to put a 70-foot LED screen outside to get reflections. That became a more traditional visual effects shot.

If you can do 85% of the shots in camera, now you have an 85% base for the visual effects artists to add onto. They're not inventing the look and the depth of field and the color and all that stuff. They're just adding the 15%—the icing on a cake that's already baked. They're not searching around for the core visual creative style. It's already laid in.

How do traditional visual effects artists make the transition to real-time?

The young people gravitate to it because they're always learning new stuff, while the old dogs will stick with their tools. But rather than do all our modeling in post, the same old dog modelers are doing beautiful work up front, and then a new team comes in and optimizes it for real-time playback. So you have a fantastic photoreal model that maybe takes two or three minutes per frame to render in post, and now you've got to optimize it to render in 1/50th of a second and retain the look.

Our Maya artists are all learning Unreal because when they convert the Maya models into Unreal, they have to test-run them until they're optimized for 120-frame playback. Our goal is 120 fps. We're at about 60 fps right now, but certain models can certainly play back at 120. It's photorealism, and we're guaranteeing about 60. The visual effects people suddenly become part of the entire production process. They have to understand that it's no longer good enough just to make a beautiful model.

It's a much better working environment for visual effects people because instead of this enormous pressure crash in post, you're brought in very early in the process and those modelers will be on from pre-production all the way through post. So, a year of modeling because you're going to model up front, you're going to model in the middle, and you're going to model at the end, instead of it all just crashing at the end and tons of overtime.

How do you envision virtual production's effect on the visual effects industry?

I love the concept of Galileo's telescope and how it increased human perception by a factor of 10 and led to the industrial revolution. The space telescope came along and increased our perception by another factor of 10. It led to the information revolution that we're currently in.

These factor-of-10 changes come along to movie technology as well. Film-to-digital was a disruptive factor of 10. What's happening now with real-time is another major disruptor. For most green screen work done worldwide, real-time is the logical next step. Virtual production has kept me personally engaged in this business. It's a whole new frontier and signifies a new era in visual effects.



Virtual production comes with a whole new set of considerations for visual effects people. Now they're part of principal photography and no longer part of post.



SAM NICHOLSON, ASC

CHAPTER 4

Conclusion and the Future

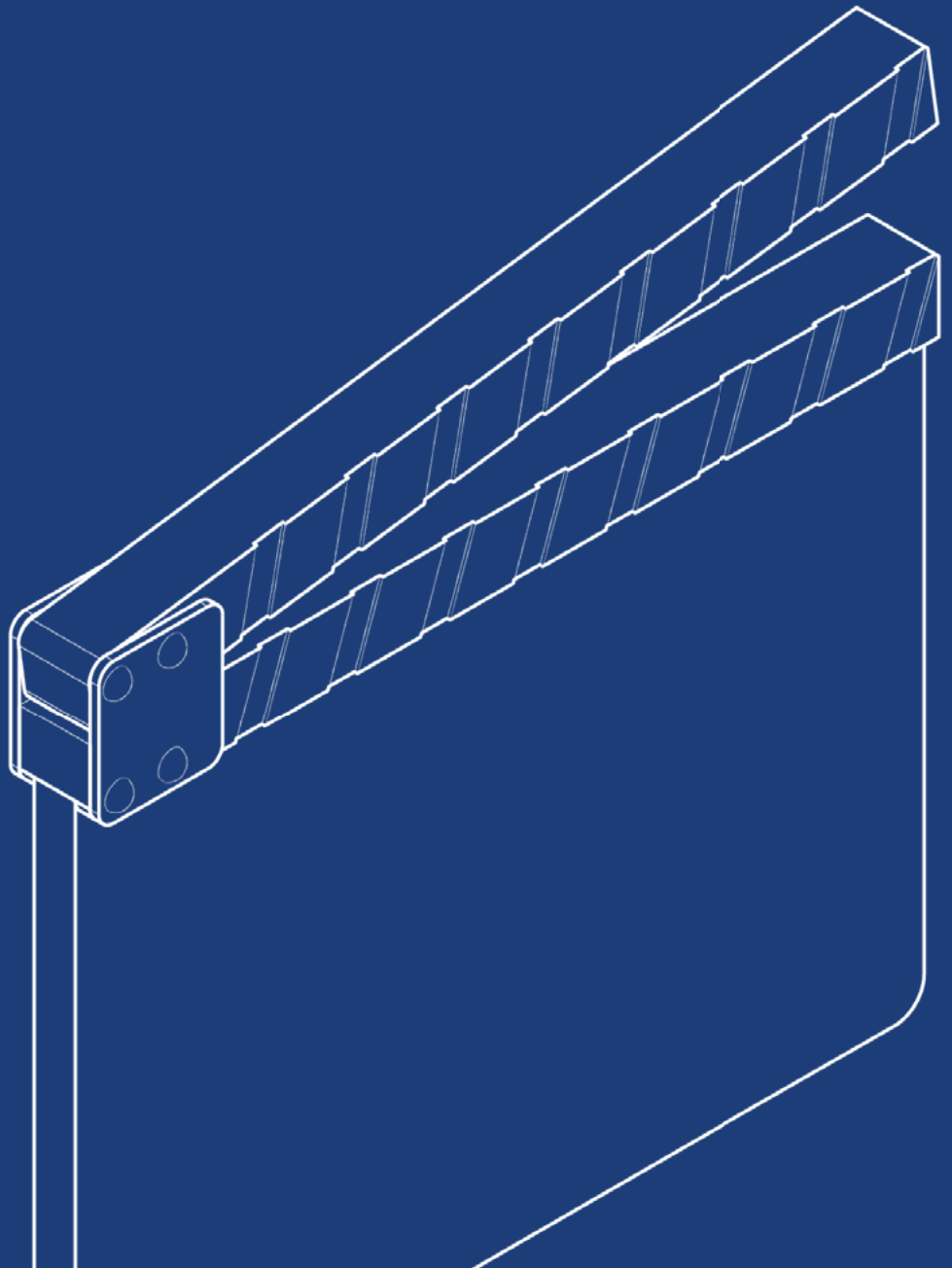



When the virtual and real worlds meet, anything is possible.



What's Next for Virtual Production

We hope you've enjoyed everything you've read in this guide so far. (Or if you've skipped here to the end, we hope you'll go back and re-read!) By now you should have a very detailed understanding of what virtual production is, where it's been put to good use, and what filmmakers think about using it. But we're not quite done yet—let's talk about what's next.

It's always a challenge to predict the future for technology and filmmaking. So instead, we'll just give you our hopes and educated guesses.

One likelihood for VP is that the computing hardware which makes it possible will continue to improve and evolve. Specifically, CPUs and GPUs will get more and more powerful with each new release. That means image fidelity will increase even more. And of course, Epic Games will continue to develop Unreal Engine to leverage new real-time technologies like ray tracing to further increase image quality.

Along with ongoing technological improvements, we also believe the growing adoption of virtual production will create more opportunity for everyone. All the traditional departments should investigate its potential and leverage the expertise of seasoned CGI artists. Visual effects vendors should look at how they can collaborate even more in the development phase.

Demand for specialists such as virtual asset designers and other key members of the virtual art department will increase. Another opportunity is VP asset repositories / virtual backlot services. The current 3D marketplaces such as TurboSquid, CGTrader, and Quixel are just the tip of the iceberg in terms of what future demand may bring.

Demand for virtual production services will also increase. It's not hard to look at the current cutting-edge companies offering VP services and envision entire industries cropping up alongside them. One need only look back to the onslaught of CG animation companies that appeared in the '90s at the dawn of CGI for visual effects to imagine the possibilities.

The increasing accessibility of virtual production tools and the quality of the images they can produce also means more voices creating more content. The limits will become imagination and raw talent and not final budget, as should be the case for any artistic endeavor. One need only look at applications like [CineTracer](#) and indie projects like [FRAGMENT](#) to see that tools we couldn't even imagine a few years ago are now available to the most modest of budgets.

The ease and malleability of real-time animation means that the process will trend toward filmmaker-driven imagery with less reliance on engineering. That means final imagery closer than ever to the creative vision with less friction along the way. When the virtual and real worlds meet, anything is possible. VP leads to a more collaborative workflow, where the many departments involved in a project can share assets and creative vision versus a more siloed-off, traditional workflow.

Whether you're an entrepreneur looking to leverage these potential business opportunities or a filmmaker wanting to use them creatively, virtual production should be in your toolbox. In reading this guide, we hope you've been inspired by the possibilities, and are now thinking of ways VP can enhance the work you're already doing or can lead you to new projects. We stand on the precipice of a game-changing technology, and could not be more excited to see what you'll create with it when you join our community.



Image courtesy of The Future Group

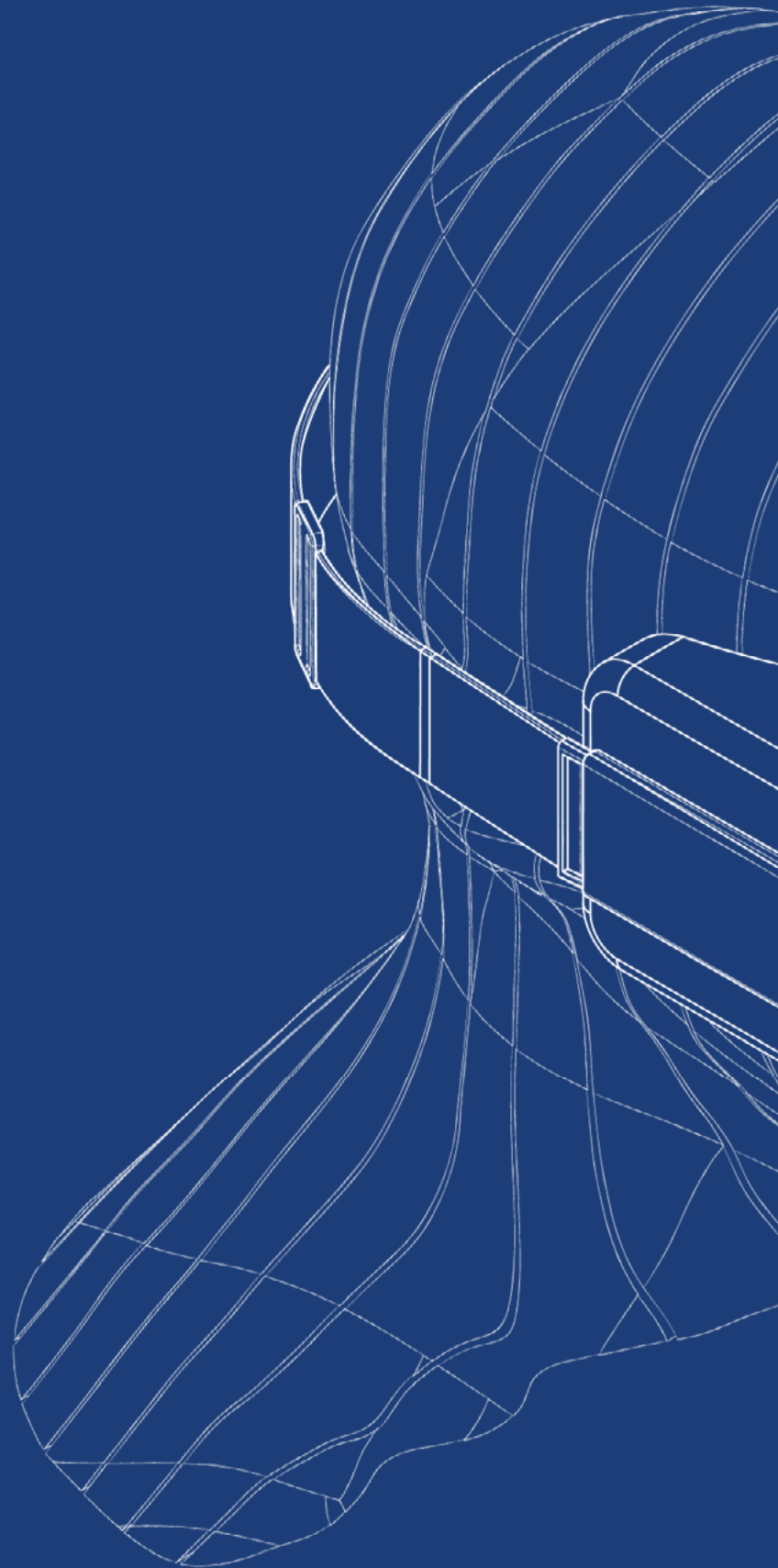

Glossary



Action design	A special form of previs, this uses 3D assets to plan and design live-action stunts. Also called stuntvis.
Aspect ratio	The ratio between the width and the height of an image or screen. Common film/tv production asset ratios are 1.85:1, 2.35:1, 16:9.
Atmospheric	Fog, smoke, fire, or other physically based visual effects rendered in real time.
Augmented reality (AR)	A technology that integrates CG elements into a physical environment.
Bit-depth	The number of binary digits used to store a value, such as a pixel's color. Higher bit-depths offer greater accuracy. An 8-bit image can display 256 color values for each of red, green, and blue, equaling ~16.7 million colors. A 16-bit image raises that number to ~4.3 trillion colors.
Blueprint	Script created from the Blueprint visual scripting language in UE4 which defines how an asset interacts.
Brain bar	The central nervous center of a virtual production, where real-time hardware and software are controlled.
Central processing unit (CPU)	A collection of millions of transistors that can be manipulated to perform a wide variety of calculations.
Cinematic	A pre-rendered, noninteractive sequence in an otherwise interactive experience. Also called cutscene.
Color science	The capability of a camera sensor to capture a portion of the color spectrum.
Cutscene	A pre-rendered, noninteractive sequence in an otherwise interactive experience.
Data capture	The capture of important details during principal photography such as photographic reference, lighting reference, LIDAR scans, camera metadata, etc.
Decimation	The reduction of detail to optimize an asset's real-time performance; a key difference between assets created for real-time versus post-production animation.
Depth of field	The range between the nearest and the furthest objects in focus in a camera.
Distributed rendering	Multiple instances of an engine processing the same scene in parallel to increase total resolution and quality.
Extended reality (XR)	An umbrella term for VR, AR, and MR, and all future realities such technology might bring.
Eyetracking	A component of facial capture in which the eye movements/gaze are recorded.
Field of view (FOV)	The extent of the observable world that is seen at any given moment by a person or camera.

Final pixel	Images of high enough quality to be the final output for film or TV. In a traditional linear pipeline, final pixel was only possible at the end of post-production. In virtual production, final pixel can sometimes be achieved in camera during shooting.
Foveated rendering	A graphics technique for VR headsets which increases performance by rendering at a higher resolution only where the viewer is directly looking.
Game engine	A software development environment designed for the creation of real-time interactive content, initially intended for video games but now used in many other applications.
Graphics processing unit (GPU)	A specialized type of microprocessor optimized to display graphics and do very specific computational tasks. Modern real-time engines rely heavily on GPUs for performance.
Haptics	Technology that recreates the sense of touch by applying forces, vibrations, or temperature changes to the user.
Head tracking	The method used by a head-mounted display to project the correct image by tracking a user's head movements via gyroscopes, sensors, cameras, etc.
Head-mounted display (HMD)	A device used to display CG content for VR, AR, or MR.
High dynamic range (HDR)	Reproduction of a greater dynamic range of luminosity than is possible with standard digital imaging techniques. HDR images retain detail in a fuller range of lights and darks than standard images.
Immersion	The sensation of feeling present in a digital environment.
Judder	Shaking or stuttering of images experienced inside a VR headset.
Latency	The delay between when a signal is sent and when it is received at its destination; experts consider under 10 milliseconds of latency to be critical for real-time camera operation.
Level of detail (LOD)	A lower-resolution representation of an object that can be used to improve performance when an asset is distant from the camera. Typically, several different levels of detail will be produced, each at a different resolution. LODs are produced from a high-resolution object through decimation.
Lookup table (LUT)	A mathematical modification table that translates between a raw camera image and a desired display appearance.
Map level	A map level in Unreal Engine is what filmmakers call a location or set.
Mixed reality (MR)	The process of anchoring virtual objects to the real world and allowing users to interact with them.
Motion capture (mocap)	The process of recording actions of human actors, and using that information to animate digital character models.

Motion match	A process that creates much higher realism in motion-captured animation by matching movements to desired poses.
Nit	A measurement of how much light a display screen sends to your eyes within a given area.
OpenColorIO (OCIO)	A system that enables color transforms and image display to be handled in a consistent manner across multiple graphics applications.
OSC	On-screen controls used for controlling real-time game engine attributes via tablets, etc. Can also refer to Open Sound Control, a protocol for audio communication.
Performance capture	An advanced form of motion capture that includes faces and/or fingers, and captures subtle expressions.
Photogrammetry	The automated construction of a 3D model from multiple 2D photographs.
Pitchvis	The visualization of a script or sequence prior to production, used to get investors and studios onboard by demonstrating a concept.
Postvis	The process of visualizing and designing the visual effects of a film after the live-action elements have been shot, for the purpose of creating provisional images, forming an edit, and test-screening the film before investing in final VFX.
Previsualization (previs)	The process in pre-production of visually mapping out scenes in a movie, commercial, or music video before principal photography.
Ray tracing	A rendering technique for generating an image by tracing the path of light as pixels in an image plane and simulating the effects of its encounters with virtual objects.
Real-time rendering	The translation of a scene into display pixels fast enough for instantaneous playback at real-time (live) speeds. In contrast, traditional offline rendering may take minutes or even hours to produce each frame, with 24 frames required to display a second's worth of animation.
Refresh rate	The frequency with which an electronic display is refreshed, usually expressed in hertz (Hz). Higher refresh rates can make motion appear smoother.
Retargeting	Application of motion capture data to a CG character with a different body geometry (shorter height, longer legs, etc.).
Smart stage	A stage purpose-built for virtual production including LED walls, tracking systems, and real-time capabilities.
Stuntvis	A special form of previs, this uses 3D assets to plan and design live-action stunts. Also called action design.
Simulcam	The combination of live camera imagery with virtual elements in real time.

Techvis	Using 3D assets to perform technical analysis on scenes: camera type, lenses, distances, set requirements, stunts, and any other information needed to physically shoot your story before you get on set.
Universal Scene Description (USD)	Pixar’s open-source scene interchange and assembly format, widely adopted in the film industry.
Virtual art department (VAD)	Produces all asset materials—such as characters, props, and sets—in low resolution for traditional previs, VFX post-production, and virtual production.
Virtual backlot	An asset repository for use with virtual productions.
Virtual camera (Vcam)	A camera in the game engine that can be driven using a device such as an iPad or traditional filmmaking equipment via encoders/trackers.
Virtual green-screen cards	Green screens created directly on LED walls for compositing.
Virtual lighting	Use of an LED screen to directly light a scene or act as interactive/reflective lighting.
Virtual location scout	The use of a real-time engine to depict either a location or a physical set on a display screen or via a shared VR session.
Virtual production (VP)	The cross section between physical and digital worlds. VP lets directors work on a physical stage but use real-time technology to view and interact with virtual environments and characters.
Virtual reality (VR)	An immersive experience using headsets to generate the realistic images, sounds, and other sensations that replicate a real environment or create an imaginary world.
Volume	The physical space in which performance capture is recorded.
Witness cameras	Cameras placed on set to provide alternate perspectives on a shoot. This provides a comprehensive understanding of the action within a scene.

Additional Resources

Here are some additional resources about the world of virtual production.

VP Resources from Epic Games

<https://www.unrealengine.com/en-US/programs/virtual-production>

<https://www.youtube.com/watch?v=bErPsq5kPzE>

Other VP Resources

<https://www.wetafx.co.nz/research-and-tech/technology/virtual-production/>

<http://vfxvoice.com/how-game-of-thrones-changed-tv-vfx-forever/>

<https://beforesandafters.com>

<https://www.visualeffectssociety.com>

<https://www.fxguide.com>

The **Virtual Production** Field Guide

Filmmakers such as George Lucas [*Star Wars: Episode I*], Steven Spielberg [*A.I.*], Peter Jackson [*Lord of the Rings*], Robert Zemeckis [*The Polar Express*] and James Cameron [*Avatar*] initially embraced virtual production enhanced by real-time rendering.

In 2009, members from the ASC, ADG, PGA, ICG, and VES formed the Virtual Production Committee.

The committee shared case studies about film and television projects leveraging virtual production and produced many of its initial definitions.

This field guide builds on the committee's work along with recent advances in real-time computer graphics, which are making virtual production even more accessible to filmmakers today.

