



Department for
Energy Security
& Net Zero

UK Low Carbon Hydrogen Standard

Greenhouse Gas Emissions Methodology
and Conditions of Standard Compliance

Version 3

December 2023



© Crown copyright 2023

This publication is licensed under the terms of the Open Government Licence v3.0 except where otherwise stated. To view this licence, visit nationalarchives.gov.uk/doc/open-government-licence/version/3 or write to the Information Policy Team, The National Archives, Kew, London TW9 4DU, or email: psi@nationalarchives.gsi.gov.uk.

Where we have identified any third-party copyright information you will need to obtain permission from the copyright holders concerned.

Any enquiries regarding this publication should be sent to us at: uklchs@energysecurity.gov.uk

Contents

Contents	3
Update Notice	6
1. Introduction	12
2. Terminology	13
3. Standard Compliance	28
Application of 'Standard Compliance'	28
Definition of 'Standard Compliance'	28
Non-Compliant Consignments	29
4. Eligible Hydrogen Production Pathways	31
Adding New Pathways to the scope of the Standard	31
5. GHG Emission Intensity Calculation Methodology	33
System Boundary	33
Global Warming Potential (GWP)	33
GHG Emission Intensity Calculation	34
Materiality	58
6. Biomass Requirements	61
Sustainability Criteria	61
Minimum Waste and Residue Requirement	62
Indirect Land Use Change (ILUC) emissions	62
7. Consignments and Monthly Averaging	63
Reporting Units	63
Generation of Discrete Consignments	63
Input-specific requirements for generating Discrete Consignments	65
Calculation of Discrete Consignment GHG Emission Intensity	67
Monthly Reporting and Weighted Average Consignments	70
8. Monitoring, Reporting and Verification (MRV) Framework	74
Before Facility operation	74
During Facility operation	75

9. Data types and quality _____	80
Data types _____	80
Data quality _____	82
10. Fugitive Hydrogen Emissions _____	83
Specific requirements for Hydrogen Production Facilities _____	83
Annex A: Eligible Hydrogen Production Pathways _____	88
Overview _____	88
Electrolysis _____	88
Fossil gas reforming with CCS _____	89
Biogenic gas reforming _____	91
Biomass gasification _____	91
Waste gasification _____	92
Gas splitting producing Solid Carbon _____	93
Annex B: Electricity Supply _____	96
Overview _____	96
Electricity supply configurations: Evidence requirements for calculating the GHG Emission Intensity of electricity Inputs _____	96
Cancellation of Renewable Energy Guarantees of Origin (REGOs) _____	107
Transmission and Distribution Losses for Specific Generators and Private Networks _____	109
Annex C: Stored Electricity Supply _____	112
Overview _____	112
Evidence required from each Electricity Storage System _____	112
Stored GHG Emission Intensity and Stored REGO Percentage tracking _____	116
Annex D: Fossil Gas Supply _____	124
Overview _____	124
Natural gas supply _____	124
Refinery Off-Gas supply _____	126
Other fossil gas supply _____	128
Annex E: Biogenic Inputs _____	129
Overview _____	129
Minimum Waste and Residue Requirement _____	129
Land-use change _____	130

Sustainability Criteria _____	138
Annex F: Biomethane Input Supply _____	145
Overview _____	145
Supply Requirements _____	145
Annex G: Non-Typical Data for Input Energy _____	147
Overview _____	147
System Boundary for energy generation _____	148
Generated energy GHG Emission Intensity calculation methodology _____	149
GHG Emission Intensity for energy generation _____	152
Annex H: Measured and Estimated Data _____	154
Overview _____	154
Data Collection and Monitoring Procedure (DCMP) for all Pathways _____	154
Background methodologies _____	155
Data type requirements _____	158
Metering requirements _____	159
Other Measurement Requirements _____	166
Estimated Data requirements _____	167

Update Notice

LCHS Version 3 (December 2023)

In previous versions of the UK Low Carbon Hydrogen Standard (LCHS), we signalled our intent to update the Standard at regular review points. This is to ensure that the documents remain fit for purpose and reflect our growing understanding of how new technologies work in practice, including how hydrogen production interacts with the broader energy system.

We published Version 2 of the LCHS in April 2023, and have developed Version 3 since, with significant input from industrial, technical and legal stakeholders. Compared to previous versions, Version 3 is focused on ensuring that the requirements set out in the Standard are clear, and can be effectively applied under the Hydrogen Production Business Model contract and other, future schemes. More consistent language is used in Version 3 for indicating requirements of the Standard, recommendations and permissible actions, and there has been restructuring and rationalisation of text for accuracy and conciseness.

This version of the LCHS is the version that is published for the purposes of The Hydrogen Production Revenue Support (Directions, Eligibility and Counterparty) Regulations 2023 and replaces any previous versions of the Standard for the purposes of the Regulations. This means that this version of the LCHS will be the one that is used for assessing eligibility under the Regulations.

Since Version 2, the following changes have occurred:

Chapter 1:

No significant changes.

Chapter 2:

Multiple new defined terms are added and capitalised to ensure there is consistent use of terminology throughout the Standard.

References included to any relevant Paragraphs.

Chapter 3:

Removed and replaced the Executive Summary in Version 2 of the LCHS, with this new Chapter summarising Standard Compliance and the Relevant Conditions.

Chapter 4:

In Version 2 of the LCHS, this Chapter was formerly Chapter 3.

The list of Eligible Hydrogen Production Pathways is updated, and the 'gas splitting producing Solid Carbon' Pathway is added.

Removal of the old Chapter 5 covering 'Normative References'

Chapter 5

In Version 2 of the LCHS, this Chapter was formerly Chapter 6.

Further details are added in the System Boundary section, specifying emissions that are included and excluded.

Global Warming Potential factors have moved to the Data Annex.

Inclusion of Solid Carbon Distribution and Solid Carbon Sequestration Emission Categories and modification of GHG Emission Intensity equation to include these two terms.

Clarification of Hydrogen Product (including impurities) as the denominator in the GHG Emission Intensity.

Section added on Material Classification.

Updated Step by Step approach for how to calculate Cumulative Allocation Factors.

References included for calculating the GHG Emission Intensity of energy Inputs.

Clarification of fuel combustion as a source of Process CO₂ emissions.

Guidance on the effect of varying CO₂ capture rates on the Hydrogen Product GHG Emission Intensity.

Materiality rules moved into this Chapter from the Consignments Chapter.

Chapter 6

In Version 2 of the LCHS, this Chapter was formerly Chapter 7.

Clarification of Biomass Requirements for biogenic Inputs, to cover Sustainability Criteria, the Minimum Waste and Residue Requirement and reporting on ILUC emissions.

Chapter 7

In Version 2 of the LCHS, this Chapter was formerly Chapter 8.

Removal of duplication of evidence requirements for various Inputs, instead referring to the Annexes.

Clarification on how to treat emissions from non-production periods and spreading these over those Discrete Consignments within the first 24 hours of restarted production (not over a calendar month), with examples.

Chapter 8

In Version 2 of the LCHS, this Chapter was formerly Chapter 11.

Clarification of Monitoring, Reporting and Verification requirements including a list of information to be recorded monthly and annually, that may be required to be reported under schemes that apply the Standard.

Chapter 9

In Version 2 of the LCHS, this Chapter was formerly Chapter 10.

Clarification of appropriate data sources for Activity Flow Data, GHG Emission Intensity and Hydrogen Product for before and during operation of the Facility.

Chapter 10

In Version 2 of the LCHS, this Chapter was formerly Chapter 9.

Clarification on the frequency for the updating of the risk reduction plan on fugitive hydrogen.

Introduction of a requirement to provide an annual report.

Annex A

New Annex, containing text previously distributed across several Annexes (process descriptions for Eligible Hydrogen Production Pathways).

Addition of gas splitting with Solid Carbon as a Pathway.

Updated descriptions and removed tables of illustrative emission sources from different Pathways to avoid repetition.

Annex B

Further clarification provided on the four electricity supply configurations including specific generators, Private Networks, GB/NI Grid and Electricity Curtailment Avoidance. There is a section on each of these configurations detailing updated evidence requirements.

Definition of Eligible PPAs provided including different types of Eligible PPAs. Clarification that an Eligible PPA is not required for a generation asset owned by the same entity as the owner of the Hydrogen Production Facility.

Updated consequences for consignment compliance or the GHG Emission Intensity of electricity volumes for failing to meet configuration evidence requirements.

Section on REGO cancellation requirements at the end of each REGO Year for each electricity supply configuration.

Methodology to calculate Transmission and Distribution Losses for specific generators and private network including a back-up value if these losses are not calculated.

Annex C

Added a definition of Electricity Storage System and how these relate to Annex B requirements when charging and discharging.

Included a list of recording requirements with a breakdown of evidence per month and year.

Set out the approach to track the Stored GHG Emission Intensity and Storage REGO Percentage of Electricity Storage Systems.

Methodologies provided to determine or evidence Self-Discharge Losses and Round Trip Efficiency.

Annex D

Clarification of three natural gas supply configurations, with contractual and evidence requirements given for each (or future work to be undertaken by DESNZ).

Refinery off gas (ROG) dedicated supply and contracting included, with details of an upfront classification of ROG as a Co-Product or Residue, and ongoing checks as to the appropriateness of a Residue classification and what thresholds may be set to disregard any counterfactual.

Annex E

Combining biogenic feedstock Inputs and biomass Sustainability Criteria, previously were two separate Annexes.

Expanded the scope of the Biomass Requirements to cover all biogenic feedstocks, all biogenic energy Inputs and all biogenic fuel Inputs to a Pathway.

Annex F

Evidence requirements included for the dedicated supply of biomethane.

Annex G

New annex, providing a methodology for how to calculate the GHG Emission Intensity of delivered electricity, heat and/or steam generation.

Clarification of system boundaries for emissions calculations, and treatment of combined heat and power generation.

Annex H

New annex, providing a list of requirements that shall be included in Data Collection and Monitoring Procedure.

Detailed methodologies provided to calculate mass flows and LHV of impure material streams from raw data.

Requirement for compositional analysis for a list of material flows, and a methodology provided to calculate Process CO₂ using a mass balance and carbon content of relevant Inputs and Outputs.

A breakdown of the minimum data requirements and data sources to be used for each type of Input and Output.

A breakdown of the required meters to be installed for each Pathway and a list of meters that may be required for each Emission Category.

Clarification of requirements in case of Measurement and Meter Failure. Methodology provided to determine gross electricity import in case of meter failure of the Electricity Storage System import electricity meter.

Methodology provided and evidence requirements listed to estimate sources of emissions that are not measured.

Methodology provided, including sampling requirements, to determine the biogenic and fossil components of a mixed feedstock.

Requirements included to measure the Activity Flow Data of solid Inputs and Outputs.

Data Annex

Updated GHG Emission Intensities for various sets of Typical Data and Default Data.

Separated out all Default Data into a separate section, given its use in only pre-operational Facilities.

Inclusion of eligible applications for the sequestration of Solid Carbon.

Inclusion of references to determine GB or NI Grid Electricity GHG Emission Intensity.

Inclusion of Typical Data for ILUC values of different feedstock groups and GHG Emission Intensity of crude oil production by country.

Inclusion of Typical Data for electricity generation GHG Emission Intensities.

Inclusion of Projected UK grid average electricity GHG Emission Intensity and Projected Transmission and Distribution Losses for pre-operational Facilities.

Inclusion of conservative Typical Data for Self-Discharge Losses and Round Trip Efficiencies for Electricity Storage Systems.

Inclusion of Typical Data for the GHG Emission Intensity of Input Materials, fuel production and supply, and fuel combustion CO₂ including the carbon content of the fuels.

Inclusion of GWPs, including for CO₂ Sequestration and Solid Carbon Sequestration Emission Categories.

Counterfactuals given for certain fossil Wastes/Residues.

Section added to provide references to unit conversion factors and Lower Heating Values.

Hydrogen Emission Calculators (HEC)

New versions (v4.7) of the HECs have been published to incorporate the latest Eligible Hydrogen Production Pathways, latest Data Annex values and the updated GHG Emission Intensity Calculation Methodology.

Fugitive Hydrogen Risk Reduction Plan and Annual Report Templates

Template provided for Hydrogen Production Facilities to complete an updated Risk Reduction Plan and an Annual Report, including a list of sources of fugitive hydrogen emissions to consider.

Summary Tables

A new tool that provides a breakdown and description of each Emission Source, Activity Flow Data collection, technical methodology for GHG emissions calculations and Typical Data for GHG Emission Intensity with references to relevant sections in the Standard.

Separate tables are provided for pre-operational and operational Hydrogen Production Facilities and for electrolysis and fossil gas reforming with CCS Pathways.

1. Introduction

- 1.1. To support the implementation of the UK Hydrogen Strategy¹, Energy Security Strategy², and Powering Up Britain³, the UK Low Carbon Hydrogen Standard ('the Standard') defines what constitutes 'low carbon hydrogen' up to the point of production. The intent of the Standard is to ensure UK hydrogen production contributes to our GHG emission reduction targets under the Climate Change Act.
- 1.2. As we look to grow the UK's nascent hydrogen economy, we must consider the range of methods that could be used to produce low carbon hydrogen. These could cover a wide variety of feedstocks, energy inputs and technology processes, all with different GHG Emission Intensities and broader sustainability impacts.
- 1.3. This document (including its Annexes) and the Data Annex set out the requirements of complying with the Standard. It aims to assist Hydrogen Production Facilities in their Final GHG Emission Intensity calculation, to assess Hydrogen Product against the GHG Emission Intensity Threshold, and to assess Hydrogen Production Facilities against the Conditions of Standard Compliance. The Data Annex provides data to support the required GHG emission calculations. This document (including its Annexes) and the Data Annex shall be used in their entirety for government schemes that apply the Standard.
- 1.4. This document (including its Annexes) and the Data Annex may be updated at regular review points, giving rise to a new version of the Standard. This will help to ensure they remain fit for purpose and reflect our growing understanding of how hydrogen production methods work in practice, including the interaction between hydrogen production and the broader energy system. Updates may also be made to the extent any part of this document (including its Annexes) or the Data Annex are no longer able to operate as intended.

¹ <https://www.gov.uk/government/publications/uk-hydrogen-strategy>

² <https://www.gov.uk/government/publications/british-energy-security-strategy>

³ <https://www.gov.uk/government/publications/powering-up-britain>

2. Terminology

- 2.1. Across the documents of the Standard, this document is commonly referred to as the Standard Document, and also contains the Annexes to the Standard. The separate document containing the data annex is referred to as the Data Annex.
- 2.2. Across the documents of the Standard, “shall” is to be read as a requirement of the Standard, “should” as a recommendation, and “may” as a permissible option.
- 2.3. Terms shall be defined as follows, for all of the documents of the Standard:

Activity Flow: The energy rate, mass rate or volumetric rate of an Input or Output.

Activity Flow Data: The rate of Input or Output from a Step, given in units of either energy, mass or volume per time.

Allocation Factor: The % of Upstream Emissions and Step Emissions assigned to the Product or Co-Product from a Step. This percentage is based on the LHV energy content of that specific Product or Co-Product, divided by the LHV energy contents of all Products and Co-Products from that Step. See ‘Energy Allocation’ definition.

Balancing Market: The electricity market operated by the Irish System Operator to balance demand and supply of electricity in real time.

Balancing Mechanism: The electricity market operated by the GB System Operator to balance demand and supply of electricity in real time.

Balancing Mechanism Units / Balancing Market Units (BMU): The units of trade within the Balancing Mechanism in Great Britain or Balancing Market in the island of Ireland. Each BMU accounts for a collection of plant and/or apparatus and is considered the smallest grouping that can be independently controlled.

Balancing and Settlement Code (BSC): A legal document which defines the rules and governance for the balancing mechanism and imbalance settlement processes of electricity in Great Britain.

Bid Offer Acceptance: An instruction issued by the electricity Transmission Network System Operator when they accept a bid and/or offer from a company that has acceded to the Balancing and Settlement Code (BSC) or Trading and Settlement Code (TSC). This includes a price and capacity that a company has committed to either consuming more electricity or generating less electricity.

Biomass Requirements: The requirement for a biogenic Input to meet the Sustainability Criteria, the Minimum Waste and Residue Requirement, and report on estimated indirect land-use change (ILUC) GHG emissions.

Buffer Storage: Is temporary storage of hydrogen at the Hydrogen Production Facility, prior to any hydrogen compression and purification, used solely for operational purposes such as balancing out production system fluctuations.

Carnot Efficiency: The maximum theoretical efficiency that a heat engine may have operating between two given temperatures. It is used in the energy allocation methodology when heat or steam is a Co-Product, to convert MJ_{LHV} energy values into MJ_{LHV} useful energy values for steam or heat. Refer to Equation 8 and Paragraph 5.15 for further details.

CO₂ Capture and Network Entry: An Emission Category including emissions associated with purification, compression, temporary storage and transport of CO₂, up to and including entry into a CO₂ T&S Network. Refer to Paragraphs 5.45-5.48 for further details.

CO₂ Capture and Sequestration (CCS): The equipment or infrastructure for capturing CO₂ from a process stream in the Hydrogen Production Facility, any purification and compression of the CO₂, any transport including via a CO₂ T&S Network before injection into geological storage.

CO₂ Emission Intensity: The carbon dioxide emissions produced per unit of energy or mass for a given Activity Flow. For Activity Flows containing energy, this is given in grams of carbon dioxide per megajoule (using Lower Heating Values), i.e. gCO₂/MJ_{LHV}. For Activity Flows not containing energy, it is expressed in grams of carbon dioxide per kilogram, i.e. gCO₂/kg.

CO₂ T&S Network: A 'transport and storage network' as defined by Chapter 1(9) of the Energy Act 2023⁴.

CO₂ T&S Network Operator: A company licensed to provide transport and storage services for the CO₂ T&S Network.

CO₂ T&S Network Delivery Point: The connection point at which carbon dioxide is delivered into the CO₂ T&S Network.

CO₂ Sequestration: An Emission category that credits the sequestration of CO₂ in underground geological storage using a CO₂ T&S Network, as further detailed in Paragraphs 5.49-5.53.

Compression and Purification: An Emission Category including emissions for the theoretical compression and purification of the Hydrogen Product to meet the minimum pressure and purity under the Standard, as further detailed in Paragraphs 5.61-5.65.

⁴ <https://www.legislation.gov.uk/ukpga/2023/52/contents/enacted>

Conditions for Standard Compliance: A list of requirements set out in Paragraph 3.4 that need to be satisfied in order for a Hydrogen Production Facility to have the ability to generate Hydrogen Product compliant with the Standard.

Consignment: A Discrete Consignment (see definition below) or a Weighted Average Consignment (see definition below), as the context requires.

Co-Products: The Electricity, Useful Heat or materials (which are not Wastes or Residues, as defined in Chapter 2) that are produced at the same time as a main Product from a Step.

Cumulative Allocation Factor: The percentage of GHG emissions from a Step that will be assigned to the Hydrogen Product, based on multiplying the Allocation Factor for the final production Step with the Allocation Factors from those Steps in the supply chain between the final production Step and the Step of interest, multiplied by the Allocation Factor from the Step of interest (but excluding the Allocation Factors from any Steps that occur before the Step of interest in the supply chain).

Cumulative Non-Production Emissions: The total GHG emissions that are generated during consecutive Reporting Units where there is no Hydrogen Product generated.

Data Annex: The document titled as Data Annex: Data for calculating Greenhouse Gas Emissions under the UK Low Carbon Hydrogen Standard.

Data Collection and Monitoring Procedure (DCMP): The agreement between the Hydrogen Production Facility and the Delivery Partner for the establishment of suitable procedures to evidence compliance with the Standard, including for the measurement and sampling of Input and Output flows. Further details are given in Chapter 8 and Annex H.

Default Data: The conservative data provided in the Data Annex by DESNZ for use by pre-operational Hydrogen Production Facilities only, where Projected Data, and/or Typical Data and Non-Typical Data is unavailable for any Emission Sources within the Feedstock Supply, Energy Supply and/or Input Material Emission Categories.

Delivery Partner: A government-appointed organisation to help deliver a government scheme, who is responsible for assessing compliance by Hydrogen Production Facilities with the Standard.

Discrete Consignment: An amount of Hydrogen Product which shares the same Environmental Characteristics (including GHG Emission Intensity) within a Reporting Unit. Discrete Consignments are determined by the feedstock(s) for Pathways with a feedstock, or by the energy Input(s) for Pathways without a feedstock. Refer to Paragraphs 7.3-7.9.

Distribution Loss: The percentage of electricity input into a Distribution Network or Private Network that is lost before the point of consumption by the Hydrogen Production Facility. This is expressed as a percentage slightly above 0%, and is calculated after any Transmission Losses that may have occurred before the Distribution Network or Private Network.

Distribution Loss Adjustment Factor: The percentage of electricity input into a NI Distribution Network or NI Private Network that is lost before the point of consumption by the Hydrogen Production Facility. This is expressed as a decimal slightly above 0, and is calculated after any Transmission Loss Adjustment Factor that may have occurred before the Distribution Network or Private Network.

Distribution Network Operator (DNO): An entity that operates an onshore electricity Distribution Network, holding a distribution licence in Great Britain.

Distribution Network (For electricity): The onshore electricity supply infrastructure connecting GB's and NI's electricity Transmission Network to lower voltage users. For gas, the UK's natural gas supply infrastructure connecting the gas Transmission Network to lower pressure users.

Distribution System Operator (DSO): An entity that operates an onshore electricity Distribution Network, holding a distribution licence in Northern Ireland.

Downstream T&D Losses: The T&D Losses between the Electricity Storage System and the Hydrogen Production Facility.

Electricity Curtailment Avoidance: The electricity consumed from the Transmission or Distribution Network which would have otherwise led to electricity curtailment, as evidenced by a Bid Offer Acceptance. Further details given in Annex B.

Electricity Grid: An interconnected network to deliver electricity which includes both the high-voltage electricity Transmission Network that connects major electricity generators with local electricity Distribution Networks, and the electricity Distribution Networks that connect the electricity Transmission Network to lower voltage consumers.

Electricity Storage System: A rechargeable asset that uses an electrical Input to fill up or "charge" for the purpose of energy storage, and then converts this energy storage to an electrical Output to drain or "discharge" energy storage. Uninterruptable power supply and capacitors within the Hydrogen Production Facility are excluded from this definition.

Electricity Supply: A sub-category within Energy Supply that accounts for the emissions associated with the consumption of Input electricity by the Hydrogen Production Facility. Refer to Paragraphs 5.28-5.29.

Eligible Hydrogen Production Pathway: A Hydrogen Production Pathway listed in Chapter 4.2.

Eligible PPA: A contractual arrangement for the sale, purchase and transfer of title for electricity that meets all the evidence requirements for the relevant source of that electricity as set out in Table 3 within Annex B, but not including any Excluded PPA.

Emission Category: A grouping of GHG emissions from similar Inputs or Outputs, used for reporting a breakdown of the Hydrogen Product GHG Emission Intensity. These groupings are organised into Feedstock Supply, Energy Supply, Input Materials, Process CO₂, Fugitive non-CO₂, CO₂ Capture and Network Entry, CO₂ Sequestration, Solid Carbon Distribution, Solid Carbon Sequestration, theoretical Compression and Purification, and Fossil Waste/Residue Counterfactual emissions, as relevant. See Chapter 5 for more details.

Emission Source: Any individual Input or Output that has an associated GHG Emission Intensity or GWP. Emissions from multiple sources of the same Input are to be considered together within one Emission Source, as are multiple sources of the same Output.

Energy Allocation: A GHG accounting approach which assigns Upstream and Step Emissions to the Products and Co-Products from that Step, according to their proportion of the Step's total useful Output energy as measured on a Lower Heating Value basis. Refer to Paragraph 5.14 for more details.

Energy Supply: An Emission Category consisting of emissions from Electricity Supply, Steam Supply, Heat Supply and Fuel Supply detailed in Paragraphs 5.25-5.33.

Environmental Characteristics: The characteristics of a Discrete Consignment defined in Paragraphs 7.4 and 7.5.

Estimated Data: The Activity Flow Data for an operational Hydrogen Production Facility which is not Measured Data.

Excluded PPA: A contractual arrangement for the sale, purchase and transfer of title in electricity generated from:

- (a) any generator that uses hydrogen as a fuel source to generate electricity; or
- (b) any generator with CO₂ Capture and Sequestration that uses fossil natural gas as a fuel source to generate electricity.

Facility: Same as a Hydrogen Production Facility.

Feedstock Gas: This includes natural gas, Refinery Off Gas (ROG), biomethane, waste industrial gases, and other fossil, renewable or biogenic gases.

Feedstock Supply: An Emission Category comprising emissions from feedstock extraction, cultivation, collection, harvesting, pre-processing, storage and transportation Steps detailed in Paragraph 5.20-5.24.

Final GHG Emission Intensity: The calculated GHG Emission Intensity for a Discrete Consignment after any addition of extra emissions from Reporting Units where there is no Hydrogen Product generated. Refer to the methodology to calculate Final GHG Emission Intensity from Raw GHG Emission Intensity given in Paragraphs 7.24-7.27.

Forest Criteria: A minimum set of requirements for forest biomass to meet, including consideration of certain protected areas, harvesting, soil, biodiversity, regeneration and carbon stock accounting. Refer to Annex E.42-E.44 for more details.

Fossil Waste/Residue Counterfactual: An Emission Category that comprises the additional emissions incurred from diversion of a fossil Waste/Residue feedstock from its prior use and accompanying reduction in fossil CO₂ detailed in Paragraphs 5.66-5.71.

Fuel Mix Disclosure: The requirement on all electricity suppliers in Great Britain to disclose to their customers the mix of fuels used to generate the electricity supplied annually, under the Electricity (Fuel Mix Disclosure) Regulations 2005 (SI 2005 No. 391). Suppliers must evidence their renewable electricity procurement via submitting REGOs to Ofgem. There are equivalent requirements for suppliers licenced in Northern Ireland

Fuel Supply: A sub-category within Energy Supply that comprises the emissions associated with the consumption of Input fuels by the Hydrogen Production Facility. Refer to Paragraphs 5.32-5.33 for details.

Fugitive Hydrogen Emissions Annual Report: The estimated fugitive hydrogen emissions in the past year and actions taken to mitigate these, as defined in Paragraph 10.10.

Fugitive Hydrogen Emissions Risk Reduction Plan: A plan demonstrating how the Hydrogen Production Facility will be operated, and fugitive hydrogen emissions will be monitored and mitigated to ensure that fugitive hydrogen emissions are kept as low as reasonably practical.

Fugitive non-CO₂: An Emission Category that comprises the emissions of Greenhouse Gases other than CO₂ that are released from the Hydrogen Production Facility. Refer to Paragraphs 5.39-5.44 for further details.

Gate Closure: A point one hour prior to the start of a settlement period, by which BSC parties must have submitted information to the System Operator regarding their planned production or consumption in the settlement period.

GHG Emission Intensity Threshold: The maximum GHG Emission Intensity for a Consignment. The final GHG Emission Intensity to be compliant with the Standard maximum 20.0 gCO₂e/MJ_{LHV} Hydrogen Product, as given in Paragraph 3.3.

GHG Emission Intensity: The Greenhouse Gas emissions produced per unit of energy or mass for a given Activity Flow. For Activity Flows containing energy, this is expressed in units of carbon dioxide equivalents (using GWPs) per megajoule (using Lower Heating Values), i.e. gCO₂e/MJ_{LHV}. For Activity Flows not containing energy, it is expressed in units of carbon dioxide equivalents per kilogram, i.e. gCO₂e/kg.

GHG Emission Intensity Calculation Methodology: The methodology used to calculate the total GHG emissions from each Emission Source. Refer to Chapter 5 for details.

Global Warming Potential (GWP): The amount of carbon dioxide (CO₂) for any Greenhouse Gas that would cause an equivalent amount of global warming as the selected GHG over a given time period. This measures the radiative forcing from the emission of one mass unit of a given GHG in the present-day atmosphere integrated over a chosen time horizon, relative to the emissions of one mass unit of carbon dioxide. The units are given as grams of carbon dioxide equivalent per gram (gCO₂e/g).

Greenhouse Gas (GHG): The gases in the atmosphere, both naturally occurring and generated from human activity, that cause global warming by trapping heat in the Earth's atmosphere, land and oceans. Those gases in scope are carbon dioxide (CO₂), methane (CH₄), nitrous oxide (N₂O), nitrogen trifluoride (NF₃), perfluorocarbons (PFCs), hydrofluorocarbons (HFCs) and sulphur hexafluoride (SF₆), as listed in the Data Annex DA.4.

Gross Meter: A meter that records Activity Flow Data in one direction only, without subtracting any flows that occur in the opposite direction.

Heat Supply: A sub-category within Energy Supply that comprises the emissions associated with consumption of Input heat by the Hydrogen Production Facility, refer to Paragraph 5.31 for details.

Higher Heating Value: A measure of the energy content of a substance, also known as the Gross Calorific Value, that includes the latent heat of vaporisation of any moisture in the substance and arising from combustion of hydrogen atoms in the substance.

Hydrogen Emissions Calculator (HEC): A tool published by DESNZ alongside the Low Carbon Hydrogen Standard for pre-operational Hydrogen Production Facilities to use to calculate whether their future hydrogen production is likely to comply with the GHG Emission Intensity requirements of the Standard. Refer to Paragraph 8.6.

Hydrogen Product: The Output from the Hydrogen Production Facility, containing hydrogen and any impurities, as measured by the hydrogen meter.

Hydrogen Production Facility: A plant that is producing hydrogen, including all ancillary equipment and infrastructure within the scope of the System Boundary (for example, CO₂ capture plant, compression, on-site Hydrogen Storage). Unless otherwise stated, this plant is assumed to be operational.

Hydrogen Production Pathway: A combination of physical supply chain Steps, starting with the feedstock, and finishing with the Hydrogen Production Facility. Paragraphs 5.1 – 5.3 define where the System Boundary starts for the feedstock.

Hydrogen Storage: The hydrogen storage at the Hydrogen Production Facility that occurs after compression and purification of the Hydrogen Product, excluding Buffer Storage.

Ideal Capacity: The maximum volume of electricity in kWh_e that can be discharged after losses from an Electricity Storage System at 100% State of Health, when fully charged and without any further charging. This may be smaller than the maximum energy storage within the system.

Immaterial Emission Source: An Emission Source that contributes GHG emissions that are below the Materiality Threshold.

Input Materials: An Emission Category that comprises the emissions from feedstock extraction, cultivation, collection, harvesting, pre-processing, storage and transportation Steps, further detailed in Paragraphs 5.34-5.36.

Input: A material or energy flow that enters a Step.

Land Criteria: A minimum set of requirements for certain biomass feedstocks to meet, to ensure preservation of biodiversity and carbon stocks. Refer to Annex E Paragraphs E.33-E.34 for details.

Line Loss Factor: The volume of electricity that is required to be input into a GB Distribution Network or GB Private Network to supply a Hydrogen Production Facility, divided by the volume of electricity that is consumed by a Hydrogen Production Facility. This is expressed as a value slightly above 1.00.

Lower Heating Value (LHV): A measure of the energy content of a substance, also known as the Net Calorific Value. Specifically, it is the amount of heat released in the combustion of a specified quantity of the substance. For the purposes of Consignment sizes and Step efficiencies, this LHV measure only takes into account the moisture content of the substance, whereas the latent heat of vaporisation of any moisture in the substance is also subtracted in the LHV measure for Co-Product Energy Allocation calculations.

Materiality Threshold: A maximum threshold of 0.2 gCO_{2e}/MJ_{LHV} Hydrogen Product for an Immaterial Emission Source, provided the sum of all Immaterial Emissions Sources is also below 1.0 gCO_{2e}/MJ_{LHV} Hydrogen Product. Further details are given in Paragraphs 5.72-5.80.

Material Emission Source: An Emission Source that contributes GHG emissions that are above the Materiality Threshold.

Materiality: An estimation and identification of an Emission Source as either a Material Emission Source that needs to be included within the GHG Emission Intensity Calculation Methodology, or as an Immaterial Emission Source that does not need to be included.

Measured Data: Any Activity Flow Data for a Hydrogen Production Facility that is metered, weighed, sampled or analysed using compositional analysis.

Measurement and Meter Failure: This occurs when the Hydrogen Production Facility fails to record or report measured or metered data when required. Refer to Annex H.39 for further details.

Minimum Waste and Residue Requirement: A minimum proportion of 50% (by LHV energy content) of the biohydrogen produced in a calendar month that shall be derived from Inputs classified as biogenic Wastes or biogenic Residues.

Monitoring, Reporting and Verification (MRV): the process of metering, measuring and recording the data required for compliance with the Standard; compiling and reporting this information; and this reported data being subject to review and verification.

Net Meter: A meter that records Activity Flow in a particular direction, but subtracting any flows that occur in the opposite direction.

Non-Typical Data: A GHG Emission Intensity value for an Input or Output, that is not sourced from the Data Annex.

Output: A material or energy flow that leaves a Step.

Partial Scope 3 Emissions: A Pathway's indirect GHG emissions other than those covered in Scope 1 and Scope 2, and which include upstream supply chain emissions until the System Boundary, but not including any downstream emissions from Hydrogen Product distribution and use.

Pathway: An Eligible Hydrogen Production Pathway.

Primary BMU: The units used under the Balancing and Settlement Code to account for all electricity that flows on or off the combined Transmission Network and Distribution Networks in Great Britain. A Primary BMU is the smallest grouping of generation and/or demand equipment that can be independently metered for settlement, and all electricity generation and demand equipment in GB must be captured in a Primary BMU.

Private Network: A local Electricity Grid in GB or NI connecting electricity generators and consumers, operated by an organisation other than a DNO, DSO or electricity Transmission Network System Operator, that supplies electricity to a Hydrogen Production Facility. This local Electricity Grid may or may not connect to the wider national Electricity Grid.

Process CO₂: An Emission Category that comprises the amount of CO₂ generated within the Hydrogen Production Facility. Further details are given in Paragraphs 5.37-5.38.

Product: A material, electricity or Useful Heat Output that is the primary aim of a Step in the Pathway; or alternatively, a material that has been intentionally modified or contaminated in an attempt to classify it as a Residue or Waste.

Projected Data: The data projected by pre-operational Hydrogen Production Facilities based on the design and expected performance of the Hydrogen Production Facility.

Raw GHG Emission Intensity: The GHG Emission Intensity for a Discrete Consignment before any addition of extra emissions from periods without hydrogen production. Refer to Paragraph 5.7 for details.

Refinery Off Gases (ROG): A variable mixture of methane, hydrogen, and other light hydrocarbons plus impurities that arise directly from refinery conversion unit operations.

Regional GHG Emission Intensity: A dataset for the GB Electricity Grid GHG Emission Intensity broken down by area, measuring the gCO₂ emissions per kilowatt hour of electricity consumed.

REGO Percentage: The percentage of the electricity consumed that arises from REGO registered electricity generators.

REGO Year: 1st April to 31st March.

Renewable Electricity Guarantee of Origin (REGO): The certification scheme which provides transparency to consumers regarding the proportion of electricity that suppliers source from renewable electricity generators, as part of their Fuel Mix Disclosure obligations. One REGO certificate is issued per megawatt hour (MWh) of eligible renewable output to generators of renewable electricity.

Renewable Electricity: Is electricity generated by a renewable non-fossil energy source, for example, wind, solar, hydropower, tidal, wave, hydrothermal, aerothermal, geothermal and biogenic feedstocks.

Renewables and CHP Register: A web-based system used by Ofgem to manage several schemes administered on behalf of government, including the REGO scheme.

Reporting Unit: A 30-minute period of time used to calculate and report GHG emissions under the Standard. The first Reporting Unit in each day starts at 00:00 UTC, so there are always exactly 48 Reporting Units each day.

Residue: A substance that is not the end product sought directly from the Step in the Pathway; the production of which is not a primary aim of the Step; and which has a low economic value in relation to the Products or Co-Products from the Step.

Residues from Agriculture, Aquaculture, Fisheries or Forestry: Are residues that are directly generated by agriculture, aquaculture, fisheries or forestry. These do not include Residues from related industries or processing.

Round Trip Efficiency: The average percentage of electricity input into an Electricity Storage System that can be discharged from the Electricity System Storage, after taking into account all internal losses. Refer to Annex C Paragraphs C.13-C.14 for further details.

Scope 1 Emissions⁵: A Hydrogen Production Facility's direct GHG emissions.

Scope 2 Emissions: The GHG emissions associated with the generation of electricity, heat, steam and cooling outside of the Hydrogen Production Facility that are consumed by the Hydrogen Production Facility.

Secondary BMU: The units used under the Balancing and Settlement Code to account for all electricity that flows on or off the combined Transmission Network and Distribution Networks in Great Britain. Secondary BMUs can only be registered by Virtual Lead Parties.

Self Discharge Loss: The ongoing losses of energy inherent to an Electricity Storage System including when the Electricity Storage System is not in use. Refer to Annex C.11 for further information.

Settlement Period: A period of 30 minutes beginning on the hour or the half-hour, over which the Balancing Mechanism or Balancing Market operates to correct any imbalances between generation and consumption on the Electricity Grid.

⁵ https://ghgprotocol.org/sites/default/files/Standards_supporting/FAQ.pdf

Single Line Diagram: A symbolic representation of the electrical system, using lines that represent all three phases, indicating any generators (including standby generators), meters, interconnectors, and grid connection points, providing voltages and maximum currents on each line.

Soil Carbon Criteria: A minimum set of requirements for agricultural Residues/Wastes to demonstrate monitoring or management plans are in place to address the impacts on soil quality and soil carbon from the harvesting of the biomass. Refer to Annex E.39-41 for further details.

Solid Carbon: Is elemental carbon (plus impurities) in a solid state. Solid Carbon can exist in different structural forms e.g. carbon black, graphite, graphene.

Solid Carbon Distribution: An Emission Category that comprises the emissions from any transport, storage and further processing of Solid Carbon from the Hydrogen Production Facility, further detailed in Paragraphs 5.54-5.56.

Solid Carbon Permissible End Uses: A list of uses for Solid Carbon given in the Data Annex DA.54.

Solid Carbon Sequestration: An Emission Category further detailed in Paragraphs 5.57-5.60, that comprises the use of Solid Carbon in those permitted end uses given in the Data Annex Paragraph DA.54.

Standard: The UK Low Carbon Hydrogen Standard, as set out in this document (including its Annexes) and the Data Annex.

Standard Compliance: This includes adherence to the GHG Emission Intensity Threshold and all the Conditions for Standard Compliance. Refer to Paragraphs 3.3.

Standard Document: This document (including its Annexes).

State of Charge (SoC): A measurement of the volume of electricity available in an Electricity Storage System compared with its nominal capacity, expressed as a percentage.

State of Health (SoH): The State of Health is a measurement of the capacity of an Electricity Storage System compared with its peak capacity, expressed as a percentage.

Steam Supply: A sub-category within Energy Supply that comprises the emissions associated with the consumption of Input steam by the Hydrogen Production Facility. See Paragraph 5.30.

Step: Any physical stage in the Pathway from feedstock through to the Hydrogen Production Facility. Steps include (where relevant) feedstock production, any intermediate pre-processing, feedstock storage and transport, as well as the Hydrogen Production Facility generating hydrogen (the final Step in the Pathway).

Step Emissions: The GHG emissions associated with each physical stage in the Pathway.

Stored GHG Emission Intensity Tracker: The dataset maintained by the operator of the Electricity Storage System, that updates the Stored GHG Emission Intensity every Reporting Unit.

Stored GHG Emission Intensity: The GHG Emission Intensity of the electricity stored within an Electricity Storage System.

Stored REGO Percentage Tracker: The dataset maintained by the operator of the Electricity Storage System, that updates the Stored REGO Percentage every Reporting Unit.

Stored REGO Percentage: The percentage of the electricity stored within an Electricity Storage System that arises from REGO registered electricity generators.

Sustainability Criteria: The Land Criteria, Soil Carbon Criteria and Forest Criteria.

System Boundary: The Steps which should be included in the Hydrogen Product GHG Emission Intensity Calculation Methodology, and at what point an Input or Output to the Pathway is included within the GHG Emission Intensity Calculation Methodology. Refer to Paragraphs 5.1-5.3 for further details.

System Operator: An organisation responsible for the Transmission or Distribution of electricity to the Hydrogen Production Facility.

Temporal Correlation: A requirement for a specific generator to evidence they are generating at least as much electricity during each Reporting Unit as is being claimed to be consumed by the Hydrogen Production Facility (or Electricity Storage System if applicable), factoring in any Transmission and Distribution losses.

Trading and Settlement Code (TSC): A legal document which defines the rules and governance for the balancing mechanism and imbalance settlement processes of electricity in the island of Ireland.

Transfer of Title: The contractual process that transfers ownership of electricity volumes from the electricity generator or supplier to the Hydrogen Production Facility.

Transmission Loss: The percentage of electricity input into a Transmission Network that is lost before the point of consumption by the Hydrogen Production Facility (if connected to the Transmission Network) or lost before the start of a lower voltage network (if the Hydrogen Production Facility is connected to a Distribution Network or Private Network). This is expressed as a percentage slightly above 0%, and is calculated excluding any Distribution Losses that may occur in the Distribution Network or Private Network.

Transmission Loss Adjustment Factor: The volume of electricity lost on the NI Transmission Network between the point of metered electricity generation and the Hydrogen Production Facility (excluding any losses on the NI Distribution Network), divided by the volume of metered electricity generation. This is expressed as a decimal slightly above 0.

Transmission Loss Factor: The volume of electricity lost on the GB Transmission Network between the point of metered electricity generation and the Hydrogen Production Facility (excluding any losses on the GB Distribution Network), divided by the volume of metered electricity generation. This is expressed as a decimal slightly above 0.

Transmission and Distribution Losses (T&D Losses): The percentage of the generated electricity lost between the point of metered electricity generation and the point of metered electricity consumption (either Hydrogen Production Facility or Electricity Storage System, as appropriate).

Transmission Network (for electricity): The long-distance electricity supply infrastructure in GB and in NI, operating at voltages significantly above the electricity Distribution Network. For gas, the long-distance gas transport infrastructure in the UK, operating at pressures significantly above the gas Distribution Network.

Typical Data: The GHG Emission Intensity values given in the Data Annex that shall be used in the GHG Emission Intensity Calculation Methodology for those Inputs and Outputs listed in the Data Annex.

UK Gas Network: This includes both the long-distance high-pressure natural gas Transmission Network infrastructure and natural gas Distribution Network in the UK.

Upstream Emissions: The cumulative GHG emissions from all the Steps within the System Boundary preceding the current Step being evaluated. For example, if the Step being evaluated were the Hydrogen Production Facility, the Upstream Emissions would comprise the whole of the supply chain for the feedstock.

Upstream T&D Losses: The T&D Losses between the electricity generation asset and the Electricity Storage System.

Useful Heat: The heat generated to satisfy an economically justifiable demand for heat.

Useful Steam: The steam generated to satisfy an economically justifiable demand for heat.

Valorise: The export of a material from a Step to customers or use of that material for onsite operations. For hydrogen, this excludes fugitive hydrogen emissions and any hydrogen production that is disposed of at the Hydrogen Production Facility, but includes hydrogen sold or sent to onsite Hydrogen Storage.

Virtual Lead Party: An independent agent that controls (potentially on behalf of a third party) power generation and/or electricity demands from a range of assets for the purposes of selling electricity balancing services to the Electricity System Operator.

Waste: Any substance or object which the holder discards or intends or is required to discard. This definition excludes substances that have been intentionally modified or contaminated for the purpose of transforming it into a Waste.

Weighted Average Consignment: An optional aggregation of Discrete Consignments of Hydrogen Product at the end of a calendar month that is assigned the weighted average Final GHG Emission Intensity of its constituent Discrete Consignments. Refer to Paragraphs 7.31-7.38 for further information.

3. Standard Compliance

Application of ‘Standard Compliance’

- 3.1. The concept of Standard Compliance (or ‘complying with the Standard’) shall be applied to Consignments, rather than a Hydrogen Production Facility. Compliance with the Standard means that the Consignment can be considered ‘low carbon hydrogen’.
- 3.2. Before a Hydrogen Production Facility has started producing Consignments, claims of Standard Compliance cannot be made. Until hydrogen production begins, only claims of *likely* Standard Compliance may be made (for example, for the purposes of demonstrating eligibility for government subsidy schemes). The Standard Document has been designed to substantiate claims of Standard Compliance, but clarifications are periodically included for the determination of *likely* Standard Compliance, ahead of a Facility’s first hydrogen production.

Definition of ‘Standard Compliance’

- 3.3. For a Consignment to be considered compliant with the Standard, the Consignment shall:
 - Have a Final GHG Emission Intensity that is less than or equal to the GHG Emission Intensity Threshold of 20 grams of carbon dioxide equivalent per megajoule of Hydrogen Product, using Lower Heating Values (20.0 gCO₂e/MJ_{LHV} Hydrogen Product); and
 - Be produced by a Hydrogen Production Facility which satisfies all of the Conditions of Standard Compliance.
- 3.4. The Conditions of Standard Compliance are that the Hydrogen Production Facility shall:
 - Employ an Eligible Hydrogen Production Pathway (see Chapter 4) for the production of hydrogen;
 - For any Solid Carbon Outputs, meet the requirements of Paragraph 5.57 regarding Solid Carbon Permissible End Use, transfer of liability and accounting.
 - Follow the GHG Emission Intensity Calculation Methodology using Lower Heating Values and the System Boundary applicable to the Pathway Inputs, accounting for each of the Emission Categories in Chapter 5.
 - Apply Global Warming Potential values for GHG emissions in all relevant calculations (further details are provided in Paragraph DA.4 of the Data Annex).

- Calculate the magnitude of each Emission Source in accordance with the Materiality requirements detailed in Paragraphs 5.72-5.80, and account for any Material Emission Sources.
 - Meet the Biomass Requirements in Chapter 6 (Sustainability Criteria, Minimum Waste and Residue Requirement and ILUC emission reporting) if a biogenic feedstock is used or a biogenic energy Input is used for a Pathway without a feedstock.
 - Meet the evidence requirements of Annex B (and/or Annex C) for the relevant electricity supply configuration, for a Pathway without a feedstock.
 - Every month, report the Final GHG Emission Intensity and Environmental Characteristics for the Hydrogen Product in every Discrete Consignment, creating at least one Discrete Consignment for every Reporting Unit (30 minutes) where there is Hydrogen Product generated (see Chapter 7);
 - Every month, report the Raw GHG Emission Intensities of each Discrete Consignment, split by Emission Category (see Chapter 7);
 - Set out before operations, and annually review and update during operations, a Fugitive Hydrogen Emissions Risk Reduction Plan (refer to Chapter 10 for details).
 - Every year during operations, provide a Fugitive Hydrogen Emissions Annual Report (refer to Chapter 10 for details).
 - Procure and cancel sufficient Renewable Energy Guarantees of Origin (REGOs) certificates each year in accordance with Annex B (and Annex C if relevant) to cover the proportion of REGO registered electricity generated for use in hydrogen production.
 - Have a Data Collection and Monitoring Procedure (DCMP) in place with the Delivery Partner.
- 3.5. The Standard also sets evidence requirements specific to certain Inputs and Outputs of a Hydrogen Production Facility, which are detailed in this document and its associated Annexes. Some of these requirements may not strictly need to be satisfied to achieve Standard Compliance, but may be necessary to evidence that one or many of the above requirements are adequately met.

Non-Compliant Consignments

- 3.6. Failure of a Consignment to meet the GHG Emission Intensity Threshold or any one of the Conditions of Standard Compliance shall result in the Consignment being declared non-compliant with the Standard.
- 3.7. A Discrete Consignment which does not meet the GHG Emission Intensity Threshold but does satisfy all the Conditions of Standard Compliance may be considered within

a Weighted Average Consignment (Refer to Chapter 7 for details). Any Discrete Consignment which does not meet all of the Conditions of Standard Compliance shall not be included within a Weighted Average Consignment.

4. Eligible Hydrogen Production Pathways

- 4.1. There are numerous Pathways to produce hydrogen from various primary energy sources. The Standard Document (including its Annexes) and the Data Annex have been designed to be applied to UK-based Hydrogen Production Facilities and Eligible Hydrogen Production Pathways only.
- 4.2. The following Eligible Hydrogen Production Pathways are currently considered within scope of the Standard, and therefore eligible to comply (further details are given in Annex A):
- Electrolysis
 - Fossil gas reforming with CCS
 - Biogenic gas reforming
 - Biomass gasification
 - Waste gasification
 - Gas splitting producing Solid Carbon
- 4.3. Each of the listed Eligible Hydrogen Production Pathways has the potential to produce hydrogen which complies with the Standard. Inclusion on this list does not, however, guarantee the hydrogen produced will comply with the Standard – Hydrogen Production Facilities will need to be designed and operate in an appropriate way to ensure the Standard Compliance is achieved in practice and on an ongoing basis.

Adding New Pathways to the scope of the Standard

- 4.4. Other Pathways may also be able to meet the requirements of the Standard. Before these Pathways can be said to produce hydrogen which complies with the Standard, they need to be included in the list of Eligible Hydrogen Production Pathways above.
- 4.5. Stakeholders wishing to have a new Pathway (or new use of Solid Carbon) added to this list are invited to submit the following evidence via uklchs@energysecurity.gov.uk to the Department for Energy Security & Net Zero (DESNZ):

-
- The expected GHG Emission Intensity of Hydrogen Product generated from this Pathway, under a range of different scenarios with reasonable assumptions. This should use the Standard's GHG Emission Intensity Calculation Methodology as closely as practicably possible, highlighting where a new or different approach is adopted.
 - The ability for any biogenic Inputs to meet the Biomass Requirements set out in the Standard, highlighting any risks of non-compliance.
 - The strategic case for including the Pathway (or Solid Carbon use) in the Standard, highlighting its ability to make a direct contribution to GHG emission reduction targets under the Climate Change Act. This should consider:
 - The ability for the Pathway to be further decarbonised over time (for example, scope for future innovation).
 - The opportunities and risks it poses to wider decarbonisation efforts (for example, the impact of the Pathway on the wider energy system, the storage potential or emission impact of Outputs from the Pathway).
 - If applicable, the proposed use of Solid Carbon, including its form, purity, any manufactured product it is incorporated into, the use and lifetime of this product and its end-of-life fate, plus any losses of Solid Carbon.
 - Other relevant environmental impacts (for example, resource impacts, water, particulate emissions and other pollutants, fit with resource or waste policies).
- 4.6. DESNZ will scrutinise the evidence provided and aim to respond within 30 working days of the submission. This initial response will set out the next steps before a decision can be confirmed, which will vary according to the complexity of the information that needs to be considered. Further or amended evidence submissions or modelling may be requested. The initial response will not provide a final decision but will provide a likely timescale over which a decision can be expected, provided that the next steps are followed.
- 4.7. The decision will be communicated with a justification to the party which has submitted evidence. If a decision is made to include the Pathway as an Eligible Hydrogen Production Pathway, DESNZ may develop further detail or new requirements for the Pathway in an updated version of this document and relevant annexes, as appropriate. The decision will only come into effect once updated documents are released with the new Pathway being listed in Paragraph 4.2. This process of updating the Standard to include a new Eligible Hydrogen Production Pathway may take place independently of wider updates to the Standard. Similarly, the process of updating the Solid Carbon Permissible End Uses in the Data Annex may also take place independently of wider updates to the Standard.

5. GHG Emission Intensity Calculation Methodology

System Boundary

- 5.1. The GHG Emission Intensity Calculation Methodology shall follow a 'point of production' System Boundary. This only covers Scope 1 Emissions, Scope 2 Emissions and Partial Scope 3 Emissions of the Hydrogen Production Facility, as set out in the Emission Categories in Equation 1. It excludes any emissions related to the distribution or use of Hydrogen Product and excludes any emissions prior to the collection of a Waste or Residue feedstock.
- 5.2. The GHG emissions from the construction, manufacturing, and decommissioning of capital goods (such as production equipment, any upstream pre-processing equipment, vehicles, storage assets), business travel, employee commuting, and upstream leased assets are not within scope of the Standard.
- 5.3. GHG emissions associated with hydrogen processes after the Hydrogen Production Facility gate (for example, off-site Hydrogen Storage, off-site liquefaction, off-site hydrogenation into a hydrogen carrier) are not within scope of the Standard. However, if processes are located onsite at the Hydrogen Production Facility and Inputs or Outputs to these processes are not separately metered (or measured) from the Hydrogen Production Facility, the GHG emissions associated with operating these processes shall be accounted for within the Standard. For example, the GHG emissions associated with operating any Buffer Storage or any onsite Hydrogen Storage after purification and compression, where the Hydrogen Production Facility does not separately meter the electricity Input to these processes, are considered within scope and shall be accounted for.

Global Warming Potential (GWP)

- 5.4. All GHGs shall be converted into a common metric of grams of carbon dioxide equivalent within the GHG Emission Intensity Calculation Methodology. To do so, emission of each Greenhouse Gas measured in grams shall be multiplied by the relevant GWP value (gCO₂e/g) taken from Table 1 of the Data Annex. The GWP values may also include distinct accounting of emissions of fossil CO₂ and biogenic CO₂.

GHG Emission Intensity Calculation

- 5.5. This section breaks down the Emission Categories that shall be accounted for and reported under the Standard by all Hydrogen Production Facilities. It provides detail on the emissions included within each category, and how these shall be accounted for, as applicable to the Hydrogen Production Facility in question.
- 5.6. GHG emissions for any Input or Output shall be calculated using the Activity Flow Data multiplied by the corresponding GHG Emission Intensity (or GWP) for that Input or Output, subject to any unit conversions. Refer to the measuring and metering methodology outlined in Annex H to calculate Activity Flow Data.
- 5.7. Following the System Boundary, Hydrogen Production Facilities shall apply the following Equation 1 for the purpose of calculating the total GHG emissions to be assigned to a Discrete Consignment (see further details in Chapter 7):

Equation 1

$$E_{Total} = E_{Feedstock\ Supply} + E_{Energy\ Supply} + E_{Input\ Materials} + E_{Process\ CO_2} + E_{Fugitive\ non-CO_2} + E_{CO_2\ Capture\ and\ Network\ Entry} - E_{CO_2\ Sequestration} + E_{Solid\ C\ Distribution} - E_{Solid\ C\ Sequestration} + E_{Compression\ and\ Purification} + E_{Fossil\ Waste/Residue\ Counterfactual}$$

Where E_{Total} = the total GHG emissions in gCO₂e over the Reporting Unit for the Discrete Consignment, and each term on the right-hand side of Equation 1 represents an Emission Category within the scope of the Standard. Hydrogen Production Facilities shall apply the following **Error! Reference source not found.** Equation 2 for the purpose of calculating the Raw GHG Emission Intensity of the Discrete Consignment:

Equation 2

$$\text{Equation } EI_{raw} = E_{Total} / P$$

Where P = the total quantity of Hydrogen Product, in MJ_{LHV}, produced over the Reporting Unit for the Discrete Consignment, and EI_{raw} is the Raw GHG Emission Intensity per unit of Hydrogen Product, in gCO₂e/MJ_{LHV}. EI_{raw} shall be reported to the nearest 0.1 gCO₂e/MJ_{LHV}.

- 5.8. For any calculation relating to P or Step efficiencies (MJ_{Step main Output}/MJ_{Step main Input}, used to calculate the emission contribution of upstream supply chain Steps), these metrics shall use Lower Heating Values (LHV) calculated with Equation 3:

Equation 3

$$MJ_{LHV} = kg_{as\ received} \times LHV\ MJ/kg_{dry} \times (1 - \% \text{ moisture content}_{as\ received})$$

Dry material is at 0% moisture content, and the % moisture content shall be the kg of water present in 1 kg of as received material. If not required to be measured as in

Annex H.9-H.10, references for LHV values in MJ/kg_{dry} may be used from the Data Annex Paragraph DA.87. Note this formula differs from the LHV definition used for Co-Product Energy Allocation in Paragraph 5.14.

- 5.9. The whole of the Hydrogen Product shall be considered under the Standard, including any impurities, and not just the pure hydrogen component. Hydrogen Production Facilities shall calculate the energy within the Hydrogen Product using Equation 4:

Equation 4

$$\text{Hydrogen Product } MJ_{LHV} = \text{Mass of Hydrogen Product } kg \times \text{Hydrogen Product LHV } MJ/kg$$

The LHV of the Hydrogen Product shall include the impact of any impurities using Equation 5:

Equation 5

$$\begin{aligned} \text{Hydrogen Product LHV } MJ/kg \\ = \sum (\text{LHV of each pure species } MJ/kg \times \text{Mass \% of each species in Hydrogen Product}) \end{aligned}$$

Material classification

- 5.10. Pathways typically take in and/or result in various Waste materials, Residue materials, Products and Co-Products. DESNZ shall decide the appropriate Product, Co-Product, Residue or Waste classification for an Input feedstock to a Step or Output material from a Step in the Pathway. In making this decision, consideration shall be given to:

- The definitions of Product, Co-Product, Residue and Waste in Chapter 2.
- Existing classifications in other relevant UK policy.
- The Waste hierarchy⁶.
- The current and expected use of the material.
- The economic value of the material in relation to the Products and Co-Products from the process in which it is generated, on both a £/tonne basis and a £/month basis.
- Any other quality or composition requirements.

- 5.11. Hydrogen Production Facilities may need to submit monthly evidence to the Delivery Partner that these definitions and requirements are met on an ongoing basis. Failure to follow the material classification decision shall result in the Hydrogen Production

⁶ <https://www.gov.uk/government/publications/guidance-on-applying-the-waste-hierarchy>

Facility having to recalculate their GHG Emission Intensity using the correct material classification, and the Hydrogen Product being non-compliant with the Standard until the corrections are made.

LHV Energy Allocation Method of GHG emissions between Products & Co-Products

- 5.12. The total emissions allocated to Outputs of any Step in a Pathway shall be split only between the Products and Co-Products of that Step. By contrast, Waste or Residue Outputs from any Step in a Pathway shall have no emissions allocated to them. Similarly, Residue and Waste feedstocks start from nil GHG emissions at the point of collection at the beginning of their supply chain.
- 5.13. The classification of an Output material can, therefore, have a significant impact on the Hydrogen Product GHG Emission Intensity, as Co-Product materials shall be allocated some of the emissions from the Step and previous Steps, reducing the emissions burden on the final Hydrogen Product.
- 5.14. The following LHV Energy Allocation Method allocates emissions to Co-Products from a Step in the Pathway using Equation 6.

Equation 6

$$\text{Allocation Factor for (Co-)Product}_j = \frac{\text{MJ}_{LHV} \text{ energy of (Co-)Product}_j}{\text{MJ}_{LHV} \text{ of Hydrogen Product} + \sum \text{MJ}_{LHV} \text{ of all Co-Products}}$$

The MJ_{LHV} energy content of Co-Products and Products in both the numerator and denominator of Equation 6 shall be determined based on Equation 7:

Equation 7

$$\begin{aligned} \text{(Co-)Product MJ}_{LHV} &= \text{MAX}\{0, \text{(Co-)Product LHV MJ/kg}_{dry} \\ &\times (1 - \% \text{ moisture content} - 2.441 \times \% \text{ moisture content})\} \times \text{(Co-)Product kg}_{as \text{ received}} \end{aligned}$$

Dry is at 0% moisture content, and the % moisture content is the kg of water present in 1 kg of as received Product or Co-Product. Equation 7 removes the latent heat of vaporisation of water at 25°C, expressed as 2.441 MJ_{LHV}/kg. Additionally, Equation 7, uses zero as a lower bound to stop very wet Products or Co-Products having a negative energy content. Note that Equation 7 is different from Equation 3 used for Step efficiencies and *P* in Paragraph 5.8.

-
- 5.15. Hydrogen Production Facilities with heat or steam Co-Products are expected to apply the Carnot Efficiency for those heat or steam Co-Products so that only the useful energy content is included Equation 6 (in both the allocation numerator for that Co-Product and in the allocation denominator for the sum of all Products and Co-Products). The useful part of the heat or steam Co-Product is found by multiplying its energy content with the Carnot Efficiency, C_h , calculated with Equation 8:

Equation 8

$$C_h = \frac{(T_h - T_0)}{T_h}$$

T_h = Temperature, measured in absolute temperature (Kelvin), of the Useful Heat or Useful Steam at the point of delivery, taken as an average temperature within the month.

T_0 = Temperature of surroundings, set at 273.15 Kelvin (equal to 0°C).

- 5.16. Pathways produce hydrogen as the main Output but may not valorise other Outputs such as heat or oxygen – these other Outputs may then be classified as Wastes or Residues, not Co-Products. Should other Outputs be classified as Co-Products, GHG emissions shall be allocated to these Co-Products using the LHV Energy Allocation Method above. This LHV Energy Allocation Method shall be applied even in cases where valorised Co-Products have no LHV energy content under Equation 7 (e.g. oxygen), which leads to no GHG emissions being allocated to these Co-Products.

Example: An illustration of how 1,000 kgCO₂e of emissions might be allocated to Hydrogen Product and various other Outputs from a theoretical process is presented below in Table 1.

Table 1: Illustrative example for allocating 1,000 kgCO₂e of GHG emissions

Output	Output Quantity	LHV dry (MJ/kg)	Useful Output MJ _{LHV}	Allocation (% of useful output)	Emissions allocated (kgCO ₂ e)	Emissions (gCO ₂ e/MJ _{LHV} useful output)
Hydrogen Product (dry)	834 kg	119.9	100,000	72.8%	728	7.3
Co-Product electricity	10,000 MJ _e	NA	10,000	7.3%	73	7.3
Co-Product steam at 200°C	10,000 MJ _{LHV}	NA	4,227	3.1%	31	7.3
Co-Product oxygen	100 kg	0	0	0%	0	0
Co-Product methane (dry)	400 kg	50	20,000	14.6%	146	7.3
Co-Product solid at 50% moisture	400 kg	18	3,112	2.3%	23	7.3
Co-Product sludge at 90% moisture	100 kg	18	0	0%	0	0
Waste solid (dry)	100 kg	5	500	0%	0	0

5.17. A Pathway from feedstock to Hydrogen Product can have multiple Steps, with each Step potentially generating Products and Co-Products. If so, the Allocation Factor for each Step shall be calculated individually, using the above LHV Energy Allocation Method. Taking each Step in turn:

- The Allocation Factor for the hydrogen production Step, $AF_{production}$, is calculated in Equation 9 as the MJ_{LHV} of Hydrogen Product divided by the MJ_{LHV} sum of all Products and Co-Products from the Hydrogen Production Facility.

Equation 9

$$AF_{production} = \frac{MJ_{LHV} \text{ of Hydrogen Product}}{MJ_{LHV} \text{ of Hydrogen Product} + \sum MJ_{LHV} \text{ of all Co-Products}}$$

- The Allocation Factor for the hydrogen production Step, $AF_{production}$, is applied to the Energy Supply, Input Materials, Process CO₂ emissions, Fugitive non-CO₂ emissions, CO₂ Capture and Network Entry, CO₂ Sequestration, Solid Carbon Distribution and Solid Carbon Sequestration Emission Categories. No Allocation Factor is applied to the Compression and Purification category as all upstream and Step Emissions are accounted for in this category.
- Each upstream Step in the supply chain will have one intermediate Product or Co-Product that will ultimately end up as Hydrogen Product, and any other Products or Co-Products from that upstream Step will not form hydrogen, but instead exit the System Boundary, taking some emissions with them. The Allocation Factor for an upstream Step in the supply chain, AF_i , shall be calculated with
- Equation 10 as the MJ_{LHV} of intermediate Product or Co-Product of interest to the Pathway, divided by the sum of the MJ_{LHV} of all Products and Co-Products from that Step.

Equation 10

$$AF_i = \frac{MJ_{LHV} \text{ of intermediate (Co-)Product of interest}}{MJ_{LHV} \text{ of Hydrogen Product} + \sum MJ_{LHV} \text{ of all Co-Products}}$$

- 5.18. A Cumulative Allocation Factor for the whole Pathway from feedstock to Hydrogen Product, $CAF_{Pathway}$, can then be calculated using Equation 11 by multiplying all of the intermediate Product and Co-Product Allocation Factors and the final $AF_{production}$ Allocation Factor together. This $CAF_{Pathway}$ value is used in Equation 11:

Equation 11

$$CAF_{pathway} = AF_{Production} \times \prod_{n=Starting \text{ Step}}^{Step \text{ before Production}} AF_n$$

- 5.19. Cumulative Allocation Factors can also be generated for each Step in the supply chain, $CAF_{Step i}$ using Equation 12, starting with the Hydrogen Production Facility and multiplying Allocation Factors back up the supply chain for the feedstock, until reaching and including the Allocation Factor from the Step of interest (Step i in Equation 12) – but not earlier Steps further upstream. These Cumulative Allocation Factors for each Step are applied to the GHG emissions generated in that Step, before the Feedstock Supply GHG emissions are totalled across all the Steps upstream of the Hydrogen Production Facility.

Equation 12

$$CAF_{Step\ i} = AF_{Production} \times \prod_{n=Step\ i}^{Step\ before\ Production} AF_n$$

Example: A Pathway with upstream Waste pre-processing has the illustrative hydrogen production Step given in Table 1 above, so the Hydrogen Production Facility Step Allocation Factor ($AF_{Production}$) is therefore 72.8%.

350,000 MJ_{LHV} of raw Waste is collected, transported, and then in the upstream pre-processing Step, is converted into 270,000 MJ_{LHV} of processed Waste, 30,000 MJ_e of Co-Product electricity and 50,000 MJ_{LHV} of Waste heat. The processed Waste is the intermediate product of interest to the Pathway, and the Allocation Factor for this Step (AF_i) is $270,000 / (270,000 + 30,000) = 90\%$. The processed Waste is then transported to the Hydrogen Production Facility.

The following Cumulative Allocation Factors then apply to each Step:

$$CAF_{Hydrogen\ Production\ Step} = AF_{Production} = 72.8\%$$

$$CAF_{processed\ Waste\ transport\ Step} = 72.8\%$$

$$CAF_{Waste\ pre-processing\ Step} = 72.8\% \times 90\% = 65.5\%$$

$$CAF_{raw\ Waste\ transport\ Step} = 72.8\% \times 90\% = 65.5\%$$

$$CAF_{raw\ Waste\ collection\ Step} = 72.8\% \times 90\% = 65.5\%$$

The Cumulative Allocation Factor for the whole Pathway from feedstock to Hydrogen Product ($CAF_{Pathway}$) is $72.8\% \times 90\% = 65.5\%$.

E_{Total} would therefore be calculated as:

65.5% of any Fossil Waste/Residue Counterfactual emissions

65.5% of the raw Waste collection, raw Waste transport and pre-processing emissions (part of Feedstock Supply)

72.8% of the processed Waste transport emissions (also part of Feedstock Supply)

72.8% of the hydrogen production Step emissions for all the remaining Emission Categories (excluding the Compression and Purification Emission Category).

100% of any Compression and Purification emissions.

Feedstock Supply

5.20. Feedstock Supply emissions ($E_{Feedstock\ Supply}$) shall be calculated for each Reporting Unit with Equation 13:

Equation 13

$$E_{Feedstock\ Supply} = \sum_{\text{Feedstock Supply Step } i} (E_{Feedstock\ Supply\ emissions,i} \times CAF_i)$$

Where $E_{Feedstock\ Supply\ emissions}$ are the GHG emissions during the Reporting Unit arising from feedstock extraction, cultivation, harvesting, collection, pre-processing, storage and transport Steps calculated in gCO₂e (using Activity Flow Data multiplied by associated GHG Emission Intensities or GWPs) for the particular feedstock in scope of the Discrete Consignment. CAF_i is the Cumulative Allocation Factor for each individual supply chain Step.⁷

5.21. The GHG emissions in this Emission Category will vary according to the feedstock used, due to the different Steps present in each Pathway:

- Fossil gas feedstocks: including GHG emissions from exploration, extraction, flaring/venting, pre-processing, compression, storage and transport, plus any liquefaction and regasification. Facilities shall calculate these emissions on the basis of the requirements set out in Annex D.
- Biomass feedstocks: including GHG emissions from cultivation, harvesting, pre-processing, storage and transport, as well as biomethane production and transport where relevant. Emissions associated with direct land-use change shall be included in Feedstock Supply (using e_l from Annex E.11-E.25 multiplied by the MJ_{LHV} of each crop cultivated). Indirect land use change emissions shall be excluded but reported separately as per Annex E.26-E.30. Impacts related to avoided biogenic emissions (for example, avoided landfill methane emissions) shall not be included.
- Waste and Residue feedstocks (with fossil and/or biogenic content): are assigned nil emissions up to the point of collection, so only including GHG emissions from collection, pre-processing, storage and transport until arrival at the Hydrogen Production Facility. Fossil Waste/Residue feedstocks shall follow the requirements of Annex D, and biogenic Waste/Residue feedstocks shall follow the requirements of Annex E (as well as Annex F if the Pathway involves biomethane feedstock).

⁷ The index i is used to denote Steps within the feedstock supply chain, and each Step may contain a number of different Emission Sources. The index j in other Emission Category formulae is used to denote different Emission Sources at the Hydrogen Production Facility. The index k is used to denote GHG emissions or credits relating to captured CO₂ or Solid Carbon that are downstream of the Hydrogen Production Facility. This choice of index notation has no impact on the results.

Additional feedstocks may be considered on a case-by-case basis by DESNZ. Emissions for these feedstocks shall be fully accounted for, where possible following the same methodology for Feedstock Supply emissions as given above.

- 5.22. If a Hydrogen Production Facility uses a certain Input (for example, natural gas) both as the feedstock and as a fuel, these Inputs shall be combined and considered only as a feedstock, and the related emissions reported under this Feedstock Supply category.
- 5.23. Any feedstock arriving at the Hydrogen Production Facility with a negative GHG Emission Intensity (for example, due to upstream pre-processing with CCS or direct land use change benefits from biomass cultivation) shall be recorded as having a nil GHG Emission Intensity within this Emission Category. Similarly, any negative GHG Emission Intensity energy or materials used in the upstream production and supply of feedstocks shall also be reported as having a nil GHG Emission Intensity when calculating the Feedstock Supply category emissions. This approach ensures separate accounting of GHG removals and consistency with other UK policy, but will remain under review as policy on GHG removals develops.
- 5.24. Electrolysis Pathways shall not account for any emissions within the Feedstock Supply category – Input electricity is considered within the Energy Supply Emission Category, and Input water is considered within the Input Materials Emission Category. If an electrolysis Facility is supplied with electricity, heat or steam generated from fossil or biogenic Inputs, the emissions from the Steps set out in Paragraph 5.19-20 shall be accounted for within the Energy Supply Emission Category, and not within this Feedstock Supply category.

Energy Supply

- 5.25. Energy Supply ($E_{Energy\ Supply}$) emissions in gCO₂e during the Reporting Unit are broken down into four sub-categories: Electricity Supply, Steam Supply, Heat Supply and Fuel Supply, with further details given below.

Equation 14

$$E_{energy\ supply} = E_{electricity\ supply} + E_{steam\ supply} + E_{heat\ supply} + E_{fuel\ supply}$$

- 5.26. $AF_{production}$ (as defined in Equation 9, and used in below Equation 15) is the Allocation Factor for the hydrogen production Step.
- 5.27. Any input energy source with a negative GHG Emission Intensity (for example, biofuel produced with CCS) shall be recorded as having a nil GHG Emission Intensity under the Standard.

Electricity Supply

5.28. Electricity Supply emissions ($E_{electricity\ supply}$) shall be calculated for each Reporting Unit using Equation 15:

Equation 15

$$E_{electricity\ supply} = \sum_{Electricity\ source\ j} E_{electricity\ supply\ emissions,j} \times AF_{production}$$

Where $E_{electricity\ supply\ emissions}$ are the GHG emissions during the Reporting Unit associated with supply of electricity within the scope of the Discrete Consignment to the Hydrogen Production Facility calculated in gCO₂e (using Activity Flow Data multiplied by associated GHG Emission Intensities). Full details on the methodology, reporting requirements and evidence required to calculate Input electricity GHG Emission Intensities are included in Annex G and in Annex B.

5.29. Electricity supplies and their associated GHG Emission Intensities shall be assessed in accordance with the four configurations listed below, with further details and evidence requirements for each of these configurations given in Annex B:

- **Electricity sourced from a specific generator in GB or NI**, via an eligible PPA (or equivalent where the generator and Hydrogen Production Facility are owned by the same legal entity). The electricity generation GHG Emission Intensity from Table 4 of the Data Annex shall be used, or if a generator is not listed in Table 4 of the Data Annex, the methodology in Annex G shall be applied. Transmission and Distribution (T&D) losses between a generator and the Facility shall be accounted for, as per Annex B;
- **Electricity sourced from a Private Network in GB or NI and not linked to a specific generator, excluding grid import to the Private Network**. The electricity generation GHG Emission Intensities from Table 4 of the Data Annex shall be used to calculate a Private Network weighted average generation GHG Emission Intensity, or if Private Network generators are not listed in Table 4 of the Data Annex, the methodology in Annex G shall be applied. T&D losses between Private Network generators and the Facility shall be accounted for, as per Annex B;
- **Electricity sourced from the GB or NI Electricity Grid and not linked to a specific generator**. The delivered GHG Emission Intensity from the Data Annex Paragraphs DA.25-DA.28 shall be used;
- **Electricity Curtailment Avoidance**. The delivered GHG Emission Intensity from the Data Annex Paragraphs DA.29-DA.32 shall be used.

Steam Supply

5.30. Steam Supply emissions ($E_{steam\ supply}$) shall be calculated for each Reporting Unit using Equation 16:

Equation 16

$$E_{steam\ supply} = \sum_{\text{Steam source } j} E_{steam\ supply\ emissions,j} \times AF_{production}$$

Where $E_{steam\ supply\ emissions}$ are the GHG emissions during the Reporting Unit associated with supply of steam to the Hydrogen Production Facility, calculated in gCO₂e (using Activity Flow Data multiplied by associated GHG Emission Intensities). This covers all cases where steam is not generated onsite and not accounted for within other Emission Categories. The steam supply GHG Emission Intensity in gCO₂e/MJ_{LHV steam} shall be calculated using the methodology given in Paragraph G.12 of Annex G, accounting for any losses between generation and the Facility.

Heat Supply

5.31. Heat Supply emissions ($E_{heat\ supply}$) shall be calculated for each Reporting Unit using Equation 17:

Equation 17

$$E_{heat\ supply} = \sum_{\text{Heat source } j} E_{heat\ supply\ emissions,j} \times AF_{production}$$

Where $E_{heat\ supply\ emissions}$ are the GHG emissions during the Reporting Unit associated with supply of heat (not as steam) to the Hydrogen Production Facility, calculated in gCO₂e (using Activity Flow Data multiplied by associated GHG Emission Intensities). This covers all cases where heat is not generated onsite and not accounted for within other Emission Categories. The heat supply GHG Emission Intensity in gCO₂e/MJ_{LHV heat} shall be calculated using the methodology given in Paragraph G.12 of Annex G, accounting for any losses between generation and the Facility.

Fuel Supply

5.32. Fuel Supply emissions ($E_{fuel\ supply}$) shall be calculated for each Reporting Unit using Equation 18:

Equation 18

$$E_{fuel\ supply} = \sum_{\text{Fuel source } j} E_{fuel\ supply\ emissions,j} \times AF_{production}$$

Where $E_{fuel\ supply\ emissions}$ are the GHG emissions during the Reporting Unit associated with the production and supply of any Input fuels to the Hydrogen Production Facility, calculated in gCO₂e (using Activity Flow Data multiplied by associated GHG Emission Intensities). Note that emissions arising from the combustion/use of fuels onsite shall be considered under the Process CO₂ and/or the Fugitive non-CO₂ Emission Categories below, and not in this Emission Category. If the fuel used is the same as the Pathway feedstock, then the sourcing and supply emissions related to that fuel shall all be accounted for under the Feedstock Supply Emission Category, and not included in this Fuel Supply category. These fuels include (but are not limited to) coal, oil, diesel, natural gas, biomethane, biomass and wastes, and exclude any Input Materials.

5.33. If the Input fuel is listed in Table 9 of the Data Annex, the corresponding GHG Emission Intensity in Table 9 of the Data Annex shall be used. If a value is not available in Table 9 of the Data Annex for the Input fuel, then:

- For biofuels, the GHG methodology set out in the latest version of the Renewable Transport Fuel Obligation (RTFO)⁸ shall be followed, but excluding the following terms: emissions savings from soil carbon accumulation via improved agricultural management, degraded land bonuses, manure bonuses, CO₂ capture and replacement, vehicle refuelling and fuel in use.
- For fossil fuels, nuclear-derived fuels or renewable fuels of non-biological origin, Facilities shall follow the GHG Emission Intensity Calculation Methodology under the Standard but as applied to the fuel of interest instead of hydrogen production. Emissions for storage and transport of the fuel shall then be added onto the calculated fuel production GHG Emission Intensity, to derive a fuel production & supply GHG Emission Intensity (that excludes combustion/use at the Hydrogen Production Facility).

Input Materials

5.34. Input Materials emissions ($E_{Input\ Materials}$) shall be calculated for each Reporting Unit using Equation 19:

Equation 19

$$E_{Input\ materials} = \sum_{Input\ material\ j} E_{Input\ material\ emissions,j} \times AF_{production}$$

$E_{Input\ Materials\ emissions}$ refers to GHG emissions associated with the production and supply of Input Materials to the Hydrogen Production Facility calculated in gCO₂e

⁸ Department for Transport, Renewable Transport Fuel Obligation (RTFO): Compliance, reporting and verification: <https://www.gov.uk/government/publications/renewable-transport-fuel-obligation-rtfo-compliance-reporting-and-verification>

(using Activity Flow Data multiplied by associated GHG Emission Intensities). $AF_{production}$ is the Allocation Factor for the hydrogen production Step. GHG emissions arising from the conversion/use of Input Materials onsite shall be considered under the Process CO₂ and/or the Fugitive non-CO₂ Emission Categories below, and not in this Emission Category. The purpose of Input Materials is not to provide energy to the process, so could include, for example, water, oxygen, salts, catalysts, solvents, and acids. Only materials generated offsite and brought across the System Boundary into the Hydrogen Production Facility shall be accounted for within this Emission Category – other flows that cross the System Boundary to generate any materials onsite shall be accounted for within their corresponding Emission Categories.

- 5.35. If the Input Material is listed in Table 10 of the Data Annex, the corresponding GHG Emission Intensity in Table 10 of the Data Annex shall be used. If a value is not available in Table 10 of the Data Annex, the Facility shall reference alternative reputable sources with a justification for their applicability, such as UK government conversion factors or peer reviewed academic literature for the proposed GHG Emission Intensity of these Input Materials.
- 5.36. To ensure separate accounting of Greenhouse Gas removals, any Input Material with a negative GHG Emission Intensity (for example, a biogenic material produced with CCS) shall be recorded as having a nil GHG Emission Intensity under the Standard.

Process CO₂ emissions

- 5.37. Process CO₂ emissions ($E_{Process\ CO_2}$) shall be calculated for each Reporting Unit using Equation 20:

Equation 20

$$E_{Process\ CO_2} = \sum_{CO_2\ source\ j} E_{Process\ CO_2\ emissions,j} \times AF_{production}$$

Where $E_{Process\ CO_2\ emissions}$ is the amount of fossil-derived carbon dioxide generated within Hydrogen Production Facility, due to conversion/use of fossil feedstocks, fossil fuels and fossil Input Materials, calculated in gCO₂ (using Activity Flow Data multiplied by associated combustion CO₂ Emission Intensities). This Emission Category may account for any fossil CO₂ generated and biogenic CO₂ generated separately, using the GWP values in Table 1 of the Data Annex. All values are given prior to any CO₂ capture, which is considered separately in other Emission Categories. $AF_{production}$ is the Allocation Factor for the hydrogen production Step.

- 5.38. The Hydrogen Production Facility shall use the methodology provided in Annex H Paragraphs H.11-H.12 to account for Process CO₂ emissions arising from the

conversion of fossil Inputs. For fossil feedstocks, carbon contents shall be calculated following Annex H Paragraph H.13. For the conversion of fuels onsite, the Hydrogen Production Facility shall use the carbon contents set out Table 11 of the Data Annex, if the fuel is listed. If carbon contents are not provided in Table 11 of the Data Annex for a given fuel, and/or there is conversion of Input Materials involving fossil carbon, the Facility shall reference alternative reputable sources with a justification for their applicability, such as UK government conversion factors or peer reviewed academic literature.

Fugitive non-CO₂

- 5.39. Fugitive non-CO₂ GHG emissions ($E_{Fugitive\ non-CO_2}$) shall be calculated for each Reporting Unit using Equation 21:

Equation 21

$$E_{Fugitive\ non-CO_2} = \sum_{Fugitive\ source\ j} E_{Fugitive\ non-CO_2\ emissions,j} \times AF_{production}$$

Where $E_{Fugitive\ non-CO_2\ emissions}$ are the operational emissions of greenhouses gases other than CO₂, released as fugitive emissions from the Hydrogen Production Facility, calculated in gCO₂e (using Activity Flow Data multiplied by associated GWPs). The GWP values given in Table 1 of the Data Annex shall be applied. $AF_{production}$ is the Allocation Factor for the hydrogen production Step.

- 5.40. This Emission Category includes all operational losses such as leakages and accidental losses, as well as other losses due to poor management of Facility operations, venting or incomplete flaring of Waste streams. For example, pass-through of unconverted methane, onsite boiler N₂O emissions, release of hydrofluorocarbons (HFCs) used in industrial refrigeration and/or cooling systems, and leakage of sulphur hexafluoride (SF₆) used in electrical switchgear.
- 5.41. These fugitive emissions shall be calculated and evidenced by Hydrogen Production Facilities through measured or estimated leakage rates applying the approach given in Annex H Paragraph H.50.
- 5.42. The Environmental Permitting Regulations 2016 (England and Wales), the Pollution Prevention and Control (Industrial Emissions) Regulations NI 2013, and the Pollution Prevention and Control (Scotland) Regulations 2012 require the use of best available techniques in design, operation and maintenance which would include preventing or minimising fugitive emissions. Therefore, Hydrogen Production Facilities should already be recording their levels of fugitive emissions and looking to reduce these through their facilities.
- 5.43. For most Hydrogen Production Facilities, fuels or feedstocks are provided by a third party, so any fugitive non-CO₂ emissions associated with the collection, pre-

processing and transport of these fuels or feedstocks will likely already be covered by either the Energy Supply or Feedstock Supply Emission Categories, depending on the Pathway.

- 5.44. Evidence shows that hydrogen behaves as an indirect Greenhouse Gas and, therefore, reducing the amount of hydrogen vented into the atmosphere from the Hydrogen Production Facility (including during onsite Hydrogen Storage) is important. While hydrogen fugitive emissions are not currently required to be accounted for within the GHG Emission Intensity Calculation Methodology, Hydrogen Production Facilities shall minimise and separately report on these fugitive hydrogen emissions, as set out in Chapter 10.

CO₂ Capture and Network Entry

- 5.45. Emissions for CO₂ capture and entry into the CO₂ T&S Network (*E_{CO₂ Capture and Network Entry}*) shall be calculated for each Reporting Unit using Equation 22:

Equation 22

$$E_{CO_2 \text{ Capture and Network Entry}} = \sum_{\text{Source } j} E_{CO_2 \text{ Capture and Network Entry},j} \times AF_{\text{production}}$$

Where *E_{CO₂ Capture and Network Entry emissions}* includes GHG emissions impacts from CO₂ capture at the Hydrogen Production Facility, any CO₂ purification, compression, temporary storage and transport, up to and including the CO₂ T&S Network Delivery Point, calculated in gCO₂e. This Emission Category excludes those emissions already accounted within Energy Supply, Input Materials, Process CO₂ emissions or Fugitive non-CO₂ Emission Categories. *AF_{production}* is the Allocation Factor for the hydrogen production Step.

- 5.46. If the CO₂ capture equipment is not part of the Hydrogen Production Facility (e.g. the CO₂ capture equipment is owned and operated by an adjacent third party with separate meters etc), the emissions related to CO₂ capture shall be accounted for in this Emission Category. Note that any emissions incurred in operating the CO₂ capture equipment (e.g. input electricity, heat, chemicals) shall still be accounted for even if the captured CO₂ is vented or lost to atmosphere.
- 5.47. Transport of CO₂ prior to the CO₂ T&S Network Delivery Point could include transport modes such as trucks or trains and therefore may involve emissions from the supply and combustion of transport fuels that are not already accounted for within the Energy Supply Emission Category. Similarly, compressors for inputting CO₂ into temporary storage or into the CO₂ T&S Network may also involve use of fuels or electricity that are not already accounted for elsewhere and need to be included within this Emission Category.

- 5.48. Any fugitive CO₂ emissions arising from the capture, temporary storage, compression and transport of CO₂ prior to entering the CO₂ T&S Network shall be accounted for by a reduction in CO₂ Sequestration Emission Category, and shall not be accounted for in this Emission Category.

CO₂ Sequestration

- 5.49. The emissions credit resulting from CO₂ Sequestration ($E_{CO_2 \text{ Sequestration}}$) shall be calculated for each Reporting Unit using Equation 23:

Equation 23

$$E_{CO_2 \text{ Sequestration}} = \sum_{\text{Network } j} E_{CO_2 \text{ Sequestration emissions},j} \times AF_{\text{production}}$$

Where $E_{CO_2 \text{ Sequestration emissions}}$ are CO₂ emissions captured and permanently sequestered in underground geological storage, calculated in gCO₂. $AF_{\text{production}}$ is the Allocation Factor for the Hydrogen production step. For CO₂ to be claimed under this Emission Category, the following conditions shall be met:

- CO₂ shall be captured, injected into a CO₂ T&S Network and stored permanently in underground geological storage. CO₂ capture and utilisation or replacement (through a displacement or change in fossil fuel use that avoids emissions) do not meet this condition.
 - Evidence must be provided by the Hydrogen Production Facility of a connection to the CO₂ T&S Network, operated by a licensed CO₂ T&S Network Operator. This could include a connection agreement between the Hydrogen Production Facility and the CO₂ T&S Network Operator.
 - The responsibility for the CO₂ shall be transferred to a CO₂ T&S Network Operator, at the CO₂ T&S Network Delivery Point. Any CO₂ leakage or venting after the responsibility has been transferred (e.g. from geological stores) is not accounted for under the Standard.
 - Any credit accounted for under this Emission Category shall not be credited or claimed elsewhere (for example, as a carbon credit in other policies or voluntary markets). If credited elsewhere, the CO₂ Sequestration benefit can no longer be included within the GHG Emission Intensity Calculation Methodology.
 - Any credit accounted for under this Emission Category shall be directly related to processes within the System Boundary. Carbon offsets (or similar) from other processes cannot be claimed under the Standard.
- 5.50. For the application of GWP values to this Emission Category, Hydrogen Production Facilities shall refer to the Data Annex Paragraph DA.50.

- 5.51. All GHG emissions associated with transporting and injecting the CO₂ into the CO₂ T&S Network shall be accounted for across the earlier CO₂ Capture and Network Entry Emission Category.
- 5.52. For some Pathways, a reduction in this CO₂ Sequestration Emission Category could produce non-compliant hydrogen that has a GHG Emission Intensity significantly above the GHG Emission Intensity Threshold. Example reasons include:
- A Hydrogen Production Facility’s CO₂ capture equipment stops working or CO₂ capture rates are reduced (resulting in full or partial venting of CO₂ onsite); or
 - There is a CO₂ T&S Network outage and the Hydrogen Production Facility cannot inject captured CO₂ into the Network (and instead has to vent); or
 - There are leaks or fugitive CO₂ emissions occurring prior to injection into the Network.

In all these cases, the additional resulting CO₂ emissions shall be accounted for as a reduction in the CO₂ Sequestration Emission Category, not as additional GHG emissions under a different Emission Category.

- 5.53. For some Pathways, the CO₂ Sequestration credit may be large enough to result in the GHG Emission Intensity for the Hydrogen Product becoming negative. Negative GHG Emission Intensity hydrogen is permitted under the Standard provided this has resulted from Emission Category formulae that use a minus sign (currently E_{CO_2} Sequestration, $E_{Solid\ C\ Sequestration}$, $E_{fossil\ counterfactual\ CO_2\ emitted}$ terms), rather than resulting from negative GHG Emission Intensity Inputs.

Solid Carbon Distribution

- 5.54. The emissions resulting from Solid Carbon distribution ($E_{Solid\ C\ Distribution}$) shall be calculated for each Reporting Unit using Equation 24:

Equation 24

$$E_{Solid\ C\ Distribution} = \sum_{Source\ j} E_{Solid\ C\ Distribution\ emissions,j} \times AF_{production}$$

Where $E_{Solid\ C\ Distribution\ emissions}$ are the GHG emissions associated with the distribution of Solid Carbon from the Hydrogen Production Facility to a Solid Carbon Permissible End Use calculated in gCO₂e. This Emission Category excludes those emissions already accounted within Energy Supply, Input Materials, Process CO₂ emissions or Fugitive non-CO₂ Emissions Categories. $AF_{production}$ is the Allocation Factor for the hydrogen production Step.

- 5.55. Distribution of Solid Carbon to a Solid Carbon Permissible End Use (see the Data Annex Paragraph DA.54) may involve collection, transport, storage, purification and/or densification of the Solid Carbon, and therefore involve accounting for the GHG emissions from the supply and use of electricity and transport fuels that are not included within another Emissions Category.
- 5.56. Any losses of Solid Carbon (e.g. spillages, erosion, fires) during the distribution of Solid Carbon prior to sequestration shall be accounted for by a reduction in the Solid Carbon Sequestration Emission Category, and shall not be accounted for in this Emission Category.

Solid Carbon Sequestration

- 5.57. The emissions credit resulting from Solid Carbon sequestration ($E_{Solid\ C\ Sequestration}$) shall be calculated for each Reporting Unit using Equation 25:

Equation 25

$$E_{Solid\ C\ Sequestration} = \sum_{Permissible\ use\ j} E_{Solid\ C\ Sequestration\ emissions,j} \times AF_{production}$$

Where $E_{Solid\ C\ Sequestration\ emissions}$ are the equivalent CO₂ emissions captured and sequestered via those permitted Solid Carbon uses given in the Data Annex Paragraph DA.54, calculated in gCO₂e. $AF_{production}$ is the Allocation Factor for the Hydrogen Production Facility. For Solid Carbon to be claimed under this Emission Category, the following conditions are required to be met:

- Evidence from a third party shall be provided that the Solid Carbon generated by the Hydrogen Production Facility is being used in one of the Solid Carbon Permissible End Uses set out in the Data Annex Paragraph DA.54.
- The responsibility for the Solid Carbon shall be transferred to a third party that operates a Solid Carbon Permissible End Use. Any losses of Solid Carbon once the responsibility has been transferred to this party are outside of the scope of the Standard.
- Any emissions accounted for under this Emission Category shall not be credited or claimed elsewhere (for example, as a carbon credit in other policies or voluntary markets). If credited elsewhere, any emissions sequestration benefit can no longer be included in the overall emissions calculation for the purposes of the Standard.
- Any emissions accounted for under this Emission Category shall be directly related to processes within the System Boundary. Carbon offsets (or similar) from other processes cannot be claimed under the Standard.

-
- 5.58. If the conditions above are met, Solid Carbon being claimed under this Emission Category shall use the values given in the Data Annex Paragraph DA.55.
- 5.59. Sequestration of Solid Carbon is assumed to remain within the Standard's System Boundary, and so Solid Carbon shall not be classified as a Co-Product of the Hydrogen Production Facility. Therefore, Solid Carbon will not be part of the $AF_{production}$ calculations, and will not be allocated a share of the Hydrogen Production Facility's emissions.
- 5.60. For some Pathways using biogenic feedstocks, the Solid Carbon Sequestration credit may be large enough to result in the overall GHG Emission Intensity for the Hydrogen Product becoming negative. This is permitted under the Standard provided this has resulted from Emission Category formulae that use a minus sign (currently $E_{CO_2 \text{ Sequestration}}$, $E_{Solid \text{ C Sequestration}}$, $E_{fossil \text{ counterfactual } CO_2 \text{ emitted}}$ terms), rather than resulting from negative GHG Emission Intensity Inputs.

Compression and Purification

- 5.61. The pressure and purity of the Hydrogen Product is normally influenced by offtaker and/or end use requirements. Hydrogen Production Facilities shall account for the energy used (e.g. any electricity for compression) to reach their stated Output pressure and purity within the Energy Supply Emission Category above.
- 5.62. Any fugitive CO₂ produced during Compression and Purification (e.g. from tail gases) shall already be accounted for within the Process CO₂ Emission Category above. Any other GHG emissions released shall already be accounted for within the Fugitive non-CO₂ Emission Category above, and any CO₂ captured and sequestered shall already be accounted for within the CO₂ Sequestration Emission Category above.
- 5.63. However, the Standard sets a theoretical minimum pressure level of 3MPa and a theoretical minimum purity of 99.9% by volume. There is therefore a requirement to calculate the GHG emissions from theoretical Compression and Purification of the Hydrogen Product only in two specific cases:
- Hydrogen Production Facilities outputting Hydrogen Product below the theoretical minimum 3MPa pressure and/or below the theoretical minimum 99.9% purity by volume. In these cases, Facilities shall account for the additional emissions associated with theoretical compression and/or theoretical purification to reach the theoretical minimum pressure and purity within the Standard. The data and methodology required for these theoretical calculations are provided in the Data Annex Paragraphs DA.56-DA.65.
 - Pre-operational Hydrogen Production Facilities using Default Data for the Energy Supply Emission Category (instead of Projected Activity Flow Data), but that are planning to output Hydrogen Product above the theoretical

minimum of 3MPa pressure and/or above the theoretical minimum of 99.9% purity by volume. The Default Data only accounts for compression to 3MPa and purification to 99.9% purity by volume, so the calculation methodology in the Data Annex Paragraphs DA.56-DA.65 shall be used, starting from 3MPa and 99.9% purity by volume, to calculate the additional GHG emissions to reach the planned pressure and purity Output.

- 5.64. If one of these two cases apply, theoretical compression and purification emissions ($E_{Compression\ and\ Purification}$) shall be calculated for each Reporting Unit using Equation 26.

Equation 26

$$E_{Compression\ and\ Purification} = P \times (EI_{Compression} + EI_{Purification})$$

Where $E_{Compression\ and\ Purification}$ are the GHG emissions from theoretical compression and purification, calculated in gCO₂e. P = the total quantity of Hydrogen Product, in MJ_{LHV}, produced over the Reporting Unit for the Discrete Consignment (see Equation 2), and $EI_{Compression}$ and $EI_{Purification}$ are defined in the Data Annex Paragraphs DA.56-DA.65 and given in gCO₂e/MJ_{LHV}.

- 5.65. This Emission Category shall always be non-negative, given the GHG Emission Intensity of any Input energy source cannot be reported as negative under the Standard. If neither of the specific cases from Paragraph 5.63 apply, $EI_{Compression\ and\ Purification}$ is taken as nil.
- 5.66. This Emission Category shall always be non-negative, given the GHG Emission Intensity of any Input energy source cannot be reported as negative under the Standard.

Fossil Waste/Residue Counterfactual

- 5.67. Utilising fossil Waste/Residue feedstock for hydrogen production diverts this feedstock away from its existing counterfactual use/fate (for example, incineration to generate electricity or heat). The utility that is no longer generated in the counterfactual is now required to be provided from another source (for example, UK grid electricity or natural gas from the UK gas grid). Under the Standard, these additional GHG emissions shall be attributed to the Pathway. However, diversion of the feedstock also results in the counterfactual no longer releasing fossil feedstock CO₂ emissions to atmosphere – CO₂ emission savings which shall also be attributed to the Pathway. This Emission Category therefore considers the impact of these changes in GHG emissions, as illustrated in Figure 1.

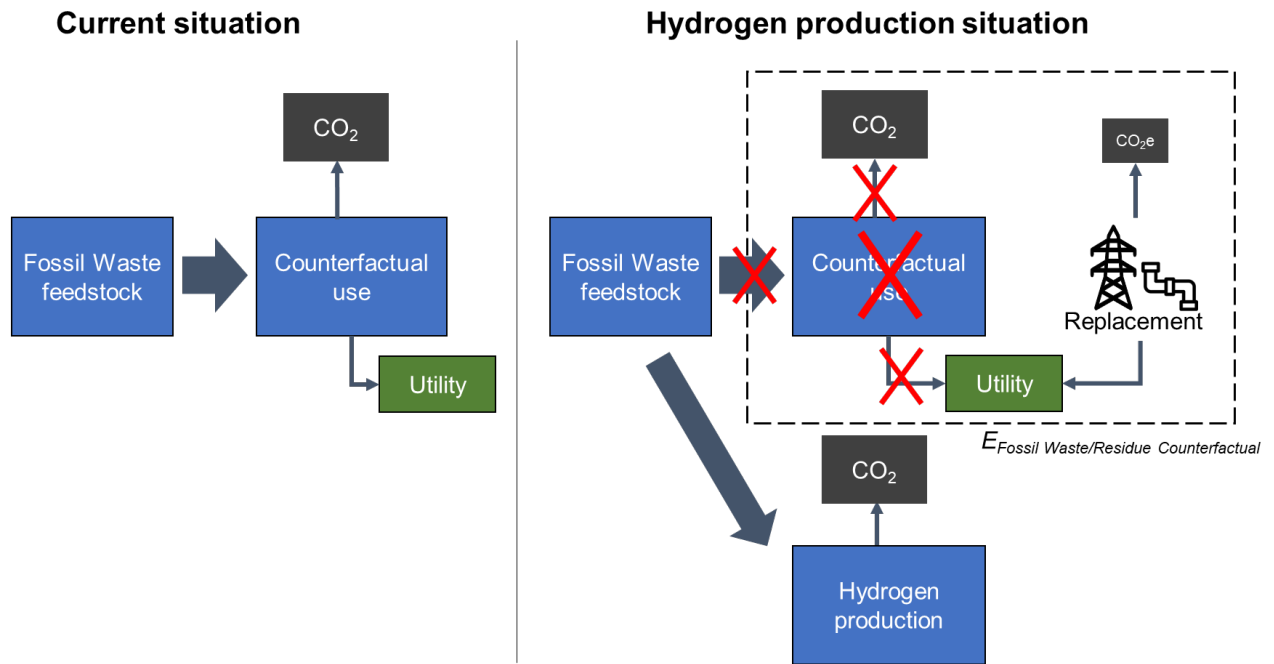

Figure 1: Illustration of the emissions changes from a fossil Waste feedstock being diverted from a counterfactual use

5.68. Counterfactual emissions shall only apply to Waste fossil feedstocks and Residue fossil feedstocks being used under the Standard. For Waste/Residue feedstocks with a mix of biogenic and fossil fractions, such as refuse derived fuel (RDF) feedstocks, the counterfactual is only applied to the fossil fraction of the Waste/Residue feedstock and not to the biogenic fraction. No counterfactual emissions shall be applied to biomass feedstocks or to fossil feedstocks that are not Wastes/Residues. Counterfactual emissions (in gCO₂e) shall be calculated using Equation 27 and Equation 28 below:

Equation 27

$$E_{Fossil\ Waste/Residue\ Counterfactual} = (E_{displaced\ utility} - E_{fossil\ counterfactual\ CO_2\ emitted}) \times CAF_{Pathway}$$

Equation 28

$$E_{displaced\ utility} = MJ_{feedstock} \times Eff_{counterfactual} \times CI_{energy}$$

Where:

$E_{Fossil\ Waste/Residue\ Counterfactual}$ is the GHG Emissions (in gCO₂e) from replacing the displaced utility that was generated by the counterfactual use, less the Waste/Residue fossil feedstock CO₂ emissions released to atmosphere in the counterfactual use;

$E_{displaced\ utility}$ is the GHG Emissions (in gCO₂e) arising from replacement of the displaced utility when a Waste/Residue fossil feedstock is diverted to hydrogen production;

$E_{fossil\ counterfactual\ CO_2\ emitted}$ is the Waste/Residue fossil feedstock CO₂ emissions that would be released to the atmosphere in the counterfactual (in gCO₂e). Note this excludes other non-CO₂ emissions, and excludes other sources of fossil CO₂ generated in the counterfactual that are not from the Waste/Residue fossil feedstock carbon itself;

$Eff_{counterfactual}$ is the LHV efficiency of converting Waste/Residue fossil feedstock into electricity, Useful Heat, Useful Steam and/or other energy vectors in the counterfactual use (in MJ_{LHV} energy/MJ_{LHV} feedstock);

CI_{energy} is the GHG Emission Intensity of the displaced energy in the counterfactual (in gCO₂e/MJ_{LHV} energy);

CAF_{chain} is the Cumulative Allocation Factor for the whole Pathway from Waste/Residue fossil feedstock to hydrogen (see Paragraphs 5.18-5.19);

$MJ_{feedstock}$ is the total amount of Waste/Residue fossil feedstock diverted to hydrogen production from the counterfactual use (in MJ_{LHV}, using the LHV formula on Paragraph 5.8).

- 5.69. If the Hydrogen Production Facility sequesters fossil CO₂ from the feedstock that would have otherwise been released to the atmosphere in the counterfactual, this can lead to emission savings compared to the counterfactual, but this sequestered CO₂ will be accounted for separately within the CO₂ Sequestration Emission Category, and has no impact on $E_{displaced\ utility}$ or $E_{fossil\ counterfactual\ CO_2\ emitted}$.
- 5.70. In all cases the CO₂ generated from the Waste/Residue fossil feedstock during hydrogen production, along with other onsite sources of fossil CO₂ (e.g. from the combustion of natural gas or diesel fuels), shall still be accounted for within the Process CO₂ Emission Category.
- 5.71. Certain fossil Waste/Residue feedstocks already have a defined counterfactual which shall be used. These are given in the Data Annex Paragraphs DA.66-DA.72. For other Waste/Residue fossil feedstocks not listed in the Data Annex, the Hydrogen Production Facility shall provide evidence regarding:
- The form and composition of the feedstock, the ability to store and transport the feedstock, the number of producers of the feedstock, and the market for trade of the feedstock;

-
- The current and expected uses of the feedstock, and the utility that would be displaced (both for the specific feedstock tonnages proposed for hydrogen production and the wider use of the feedstock across the UK);
 - The energy sources that are most likely to replace this displaced utility (both for the specific feedstock tonnages proposed for hydrogen production and the wider use of the feedstock across the UK).

DESNZ will review this evidence and determine an appropriate counterfactual, and if necessary may update the Data Annex to provide more details of the new counterfactual. DESNZ will also determine if a counterfactual applies to all Hydrogen Production Facilities using the feedstock, or if a counterfactual only applies to one particular Hydrogen Production Facility.

- 5.72. DESNZ will continually monitor the appropriateness of the counterfactuals provided in the Data Annex Paragraphs DA.66-DA.72, including alignment with other relevant policy and the opportunities or risks that may be posed to system-wide environmental and decarbonisation efforts. If necessary, DESNZ will update the counterfactuals or counterfactual methodology at a future review point.

Example (noting that this purely illustrative example does not indicate the appropriate counterfactual to be used):

100 MJ_{LHV} of the fossil fraction of RDF is used in a gasification Facility, to produce 50 MJ_{LHV} of hydrogen.

The counterfactual in this example is an unabated energy from waste power plant that has 22% net electrical efficiency, that would have released 9,300 gCO₂ to atmosphere from combustion of the 100 MJ_{LHV} of fossil Waste feedstock.

In this example, grid average electricity is assumed to replace this missing generation with a GHG Emission Intensity of 35 gCO₂e/MJ_e, the Cumulative Allocation Factor for the whole Pathway is 65.5%, with a Hydrogen Production Facility Allocation Factor of 72.8% and pre-processing Step Allocation Factor of 90% (that is, Co-Products are generated both during the pre-processing Step and at the Hydrogen Production Facility). It is assumed for this example that the pre-processed Waste feedstock retains 85% of the original Waste feedstock carbon.

$E_{Fossil\ Waste/Residue\ Counterfactual}$ would then be = $(100 \times 22\% \times 35 - 9,300) \times 65.5\% = (770 - 9,300) \times 65.5\% = -5,587$ gCO₂e. The contribution of $E_{Fossil\ Waste/Residue\ Counterfactual}$ to the Final GHG Emission Intensity would then be $-5,587 \div 50 = -111.7$ gCO₂e/MJ_{LHV}.

However, the Hydrogen Production Facility Process CO₂ emissions will be likely be approaching $9,300 \times 85\% = 7,905$ gCO₂ due to fossil CO₂ generated from conversion of the pre-processed Waste feedstock, prior to any CO₂ capture and emissions allocation to Co-Products at the Facility. $E_{Process\ CO_2}$ would then be = $7,905 \times 72.8\% = 5,755$ gCO₂e. The contribution of $E_{Process\ CO_2}$ to the Final GHG Emission Intensity would then be $5,755 \div 50 = +115.1$ gCO₂e/MJ_{LHV}. $E_{Feedstock\ Supply}$ would also have emissions to account for from the release of 15% of the feedstock fossil carbon in pre-processing.

The net result for the fossil fraction of RDF in this example where both the hydrogen production and fossil Waste feedstock counterfactual are unabated is, therefore, strongly influenced by the efficiency of the counterfactual and the displaced GHG Emission Intensity.

Example: (noting that this purely illustrative example does not indicate the appropriate counterfactual to be used):

100 MJ_{LHV} of fossil plastic is used in a gasification Hydrogen Production Facility to produce 55 MJ_{LHV} of hydrogen.

The counterfactual in this example is an unabated furnace for cement kiln heating that would have released 10,300 gCO₂ to atmosphere from combustion of the 100 MJ_{LHV} of fossil Waste feedstock.

Grid natural gas is assumed to replace this missing heating fuel in this example, with a GHG Emission Intensity of 8.8 gCO₂e/MJ_{LHV} for supply and 55.6 gCO₂e/MJ_{LHV} for combustion.

For simplicity in this example, there is no difference assumed between furnace heating efficiencies when using natural gas or Waste plastic, and there are no Co-Products or pre-processing in the Pathway.

$E_{Fossil\ Waste/Residue\ Counterfactual}$ would then be $= (100 \times (8.7 + 56.7) - 10,300) \times 100\% = (6,540 - 10,300) = -3,760 \text{ gCO}_2\text{e}$. The contribution of $E_{Fossil\ Waste/Residue\ Counterfactual}$ to the Final GHG Emission Intensity would then be $-3,760 \div 55 = -68.4 \text{ gCO}_2\text{e/MJ}_{LHV}$.

$E_{Process\ CO_2}$ would likely be $= 10,300 \times 100\% = 10,300 \text{ gCO}_2\text{e}$. The contribution of $E_{Process\ CO_2}$ to the Final GHG Emission Intensity would then be $10,300 \div 55 = +187.3 \text{ gCO}_2\text{e/MJ}_{LHV}$.

The net result for the fossil plastic used in this example is that the hydrogen will not be compliant with the Standard, due to the high emissions of the displaced heating in this example counterfactual, unless significant CCS were implemented by the Hydrogen Production Facility.

Materiality

- 5.73. In any Pathway, there will be a number of minor Emission Sources which can be costly to measure, report and verify while their impact on the overall GHG Emission Intensity of the hydrogen is insignificant. Life-cycle analyses typically define a 'Materiality' level below which Emission Sources may be categorised as Immaterial Emission Sources and therefore excluded from the GHG Emission Intensity Calculation Methodology. These Materiality limits are set to ensure confidence in the overall reported GHG Emission Intensities, whilst also avoiding unnecessary administrative burdens of reporting and evidencing Immaterial Emission Sources.
- 5.74. The Materiality Threshold for an Emission Source is 1% of the GHG Emission Intensity Threshold, so a value of $0.2 \text{ gCO}_2\text{e/MJ}_{LHV}$ Hydrogen Product. Furthermore, no more than a total of 5% of the GHG Emission Intensity Threshold (so a value of $1.0 \text{ gCO}_2\text{e/MJ}_{LHV}$) shall be excluded as being Immaterial Emission Sources.
- 5.75. Therefore, if a single Emission Source contributes $<0.2 \text{ gCO}_2\text{e/MJ}_{LHV}$ Hydrogen Product and in total all the Immaterial Emission Sources contribute $<1.0 \text{ gCO}_2\text{e/MJ}_{LHV}$ Hydrogen Product, the single Emission Source in question may be considered as an Immaterial Emission Source and may be excluded from the GHG Emission Intensity Calculation Methodology. Where an individual Emission Source is $<0.2 \text{ gCO}_2\text{e/MJ}_{LHV}$ Hydrogen Product but deeming it to be an Immaterial Emission Source would lead to a total of $>1.0 \text{ gCO}_2\text{e/MJ}_{LHV}$ Hydrogen Product being considered as Immaterial Emission Sources, this specific Emission Source shall be considered as a Material Emission Source and included in the GHG Emission Intensity Calculation Methodology.

-
- 5.76. Immaterial Emission Sources shall need to be agreed with the Delivery Partner, based on the Hydrogen Production Facility's initial calculations. Once a Hydrogen Production Facility has first begun operations, Materiality shall be assessed for each calendar month at the end of that month. For each Emission Source, the Facility shall assess Materiality using the sum of the GHG emissions from the Emission Source during that month divided by the month's total generation of Hydrogen Product and shall confirm the status of each Emission Source with respect to the Materiality Threshold. Changes between months in the usage rate of Inputs, or the use of new Inputs, may lead to some Emission Sources that were reported in previous months as Immaterial Emission Sources becoming Material Emission Sources (or vice versa).
- 5.77. Emissions from similar Input sources shall be considered together to avoid Hydrogen Production Facilities making multiple claims of Immaterial Emission Sources, which if aggregated would result in Material Emission Sources (above the Materiality Threshold).

Example: If five different grades of fossil diesel are used, each of which are individually Immaterial Emission Sources, the Hydrogen Production Facility shall aggregate these similar Inputs to assess whether the total fossil diesel usage is an Material Emission Source or an Immaterial Emission Source.

Example 2: A Hydrogen Production Facility could set up dozens of PPAs with bio-electricity generators, each only contributing 0.1 gCO₂e/MJ_{LHV} hydrogen, but the Hydrogen Production Facility shall aggregate these similar Inputs to determine the Materiality of all the bio-electricity Inputs.

- 5.78. Electricity Inputs shall be considered together within groups of similar generation types for the purposes of assessing Materiality: for example, wind/solar, nuclear, bio-electricity, energy from waste, grid average, Electricity Storage System.
- 5.79. All emissions credits (that is, Emission Categories or parts of Emission Categories that are subtracted from the GHG Emission Intensities calculations, such as E_{CO_2} Sequestration, $E_{fossil\ counterfactual\ CO_2\ emitted}$, any GHG savings from direct land use change) shall be deemed as a Material Emission Source, regardless of their magnitude.
- 5.80. Designation of an Emission Source as an Immaterial Emission Source in GHG emission terms shall not impact on or negate other compliance, evidence or technical requirements of the Standard.

Example: Wind electricity (with a nil GHG Emission Intensity) or biomass-derived electricity with CCS (that has negative GHG Emission Intensity but is declared as having nil GHG Emission Intensity under the Standard) will still need to meet the evidence requirements of Annex B and meet any relevant Biomass Requirements in Annex E, respectively.

5.81. The Materiality assessment shall be included within the scope of any third-party audits to check that Emission Sources have been appropriately excluded. More scrutiny should be paid to those Emission Sources likely to be closer to the Materiality Threshold.

Examples of potentially Immaterial and Material Emission Sources:

For electrolysis Pathways, typical Hydrogen Production Facilities might expect that Emission Sources such as mains water input, minor chemicals such as acids and alkalis used in water treatment, along with nitrogen supplied for purging, to each be Immaterial Emission Sources (<0.2 gCO₂e/MJ_{LHV} hydrogen), but this will vary by Facility and needs to be confirmed each month in ongoing reporting. Inputs such as diesel used for back-up generators may well be Material Emission Sources in a given calendar month.

For natural gas reforming Pathways, typical Hydrogen Production Facilities might expect that Emission Sources such as mains water input and minor chemicals to each be Immaterial Emission Sources, but this will also vary by Hydrogen Production Facility and needs to be confirmed each month. Inputs such as amine solution make-up used for CO₂ capture, oxygen deliveries (if not generated onsite) and grid electricity Inputs may be Material Emission Sources, as might outputs such as fugitive emissions of methane. It is expected that natural gas supply and Process CO₂ emissions will always be Material Emission Sources for natural gas reforming Pathways.

6. Biomass Requirements

- 6.1. Hydrogen derived from biogenic Inputs shall satisfy the Standard's Biomass Requirements, as part of demonstrating compliance with the Standard (see 'Standard Compliance' in Chapter 3). These Biomass Requirements encompass the Sustainability Criteria, the Minimum Waste and Residue Requirement, and the reporting of indirect land use change emissions. These requirements apply to Hydrogen Production Facilities that use biogenic feedstocks or biogenic energy Inputs (electricity, heat, steam and fuels).
- 6.2. The Biomass Requirements currently do not apply to the use of biochemical Inputs (biogenic Inputs that are not used for energy purposes in the Hydrogen Production Facility). These Biomass Requirements also currently do not apply to the use of non-feedstock biogenic Inputs within the Pathway's feedstock supply chain prior to the Hydrogen Production Facility (e.g. biodiesel used in trucks transporting feedstock, biomass heating fuels used in feedstock pre-processing plants). It is still recommended to satisfy the Biomass Requirements in these cases where possible, as these positions will be kept under review by DESNZ as biomass sustainability policy develops.

Sustainability Criteria

- 6.3. The Sustainability Criteria consist of the Land Criteria, Soil Carbon Criteria and Forest Criteria, closely following the approach set out in the Renewable Transport Fuel Obligation (RTFO). Which of these criteria apply depend on the classification and source of the biogenic Input – see Table 7 within Annex E for further details:
 - Unless indicated in the bullets below, biogenic Inputs shall be required to satisfy the Land Criteria. These prohibit the sourcing of the biogenic Input from land that has or previously had a certain status, to preserve biodiversity and carbon stocks.
 - Biogenic Inputs that are Residues or Wastes from agriculture shall also meet the Soil Carbon Criteria. These ensure that monitoring or management plans are in place to address the impacts on soil quality and soil carbon of harvesting the biogenic Input concerned.
 - Biogenic Inputs from forestry (including Wastes and Residues) shall be required to meet the Forest Criteria, instead of the Land Criteria. The Forest Criteria ensure that monitoring and management plans are in place to address potential negative impacts (related to biodiversity, carbon stocks, soil quality etc.) of harvesting the biogenic Input concerned.

-
- Biogenic Inputs that are Wastes or Residues that are not from agriculture, aquaculture, fisheries or forestry do not need to meet any of the Sustainability Criteria.

6.4. Further details of these Sustainability Criteria and the requirements for demonstrating compliance with them are provided in Annex E.30-E.52.

Minimum Waste and Residue Requirement

6.5. Any biogenic Inputs used in the Pathway shall satisfy the Standard's Minimum Waste and Residue Requirement, as set out in Annex E.7-E.10.

Indirect Land Use Change (ILUC) emissions

6.6. Emissions associated with direct land-use change shall be accounted for within the Feedstock Supply Emission Category (see Paragraph 5.21 and Annex E.11-E.25). In contrast, indirect land use change emissions shall be excluded from these calculations, but shall be estimated and reported separately. Further guidance on emissions related to land-use change is provided in Annex E.26-E.29.

7. Consignments and Monthly Averaging

Reporting Units

- 7.1. The GHG Emission Intensity of the Hydrogen Product from a Hydrogen Production Facility will in most cases vary over time, given changes in the performance of the Facility and its various Inputs and outputs, as accounted for under the GHG Emission Intensity Calculation Methodology in Chapter 5.
- 7.2. The Standard, therefore, sets a common Reporting Unit of 30 minutes to measure and report the GHG Emission Intensity of the Hydrogen Product when a Hydrogen Production Facility is operational.

Generation of Discrete Consignments

- 7.3. The Hydrogen Product made within a Reporting Unit shall be divided into separate amounts (on a MJ_{LHV} energy basis as per Paragraph 5.9), where within each separate amount all the Hydrogen Product shares the same Environmental Characteristics. Each amount of Hydrogen Product shall be defined as a Discrete Consignment. Note that Discrete Consignments are not amounts of feedstock or energy Inputs. Any Reporting Unit without generation of Hydrogen Product does not form a Discrete Consignment.
- 7.4. For Pathways with a feedstock, a Discrete Consignment shall have the following identical Environmental Characteristics:
 - feedstock
 - feedstock form (solid, liquid, gas)
 - feedstock country of origin
 - feedstock classification (Waste, Residue, Co-Product or Product)
 - feedstock type (biogenic, fossil, nuclear, renewable fuel of non-biological origin)
 - where relevant, the counterfactual use for any fossil Waste/Residue feedstocks
 - where relevant, compliance of biogenic feedstocks with the Biomass Requirements (see Annex E)
 - Steps within the Hydrogen Production Pathway
 - Final GHG Emission Intensity of the Hydrogen Product.

-
- 7.5. For Pathways without a feedstock (for example, electrolysis Pathways), a Discrete Consignment shall have the following identical Environmental Characteristics:
- energy Input form (electricity, heat, steam)
 - type of energy generation technology
 - energy Input country of origin, and for any initial biogenic sources generating biogenic energy Inputs, their country of origin
 - where relevant, electricity Input type (specific generator (biogenic, fossil, nuclear, renewable energy of non-biological origin, Electricity Storage System), Private Network not linked to a specific generator, grid import not linked to a specific generator, Electricity Curtailment Avoidance)
 - where relevant, heat or steam Input type (biogenic, fossil, nuclear, renewable energy of non-biological origin)
 - where relevant, the counterfactual use for any fossil Waste/Residue materials used in energy generation
 - where relevant, for biogenic energy Inputs, compliance of the original biogenic material with the Biomass Requirements (see Annex E)
 - Steps within the Hydrogen Production Pathway
 - Final GHG Emission Intensity of the Hydrogen Product
- 7.6. Hydrogen Production Facilities may use multiple feedstocks or multiple energy Inputs with different associated Environmental Characteristics. Facilities may also use mixed feedstocks that have component fractions with different associated Environmental Characteristics. Hydrogen Product generated during a Reporting Unit, where not all the Hydrogen Product shares the same identical set of Environmental Characteristics across the Reporting Unit (due to the presence of multiple feedstocks, feedstock component fractions or mixed energy Inputs), shall be split into separate Discrete Consignments. Every Reporting Unit that has Hydrogen Product generated will have at least one Discrete Consignment.
- 7.7. All Discrete Consignments shall be reported and assessed separately for compliance or non-compliance with the Standard (before being subject to weighted averaging, which is covered later in Paragraphs 7.28-7.35).
- 7.8. If there is at least one feedstock for the Pathway, any imported electricity, heat or steam may be treated as single Inputs (each with one GHG Emission Intensity respectively) for a given Reporting Unit, and the imported electricity, heat or steam does not have to be split into their original sources with different Environmental Characteristics. In other words, where there is at least one feedstock for the Pathway, the generation of Discrete Consignments shall be driven by the differences in feedstocks alone.

- 7.9. Where there is no feedstock for the Pathway (e.g. electrolysis), and there are multiple sources for the imported electricity, heat or steam, differences in these energy sources shall result in the generation of separate Discrete Consignments.

An indicative example of how different Discrete Consignments are generated for a two hour and thirty minute period of hydrogen production is shown below in where each amount on the top row is indicatively 1 MJ_{LHV} of hydrogen:

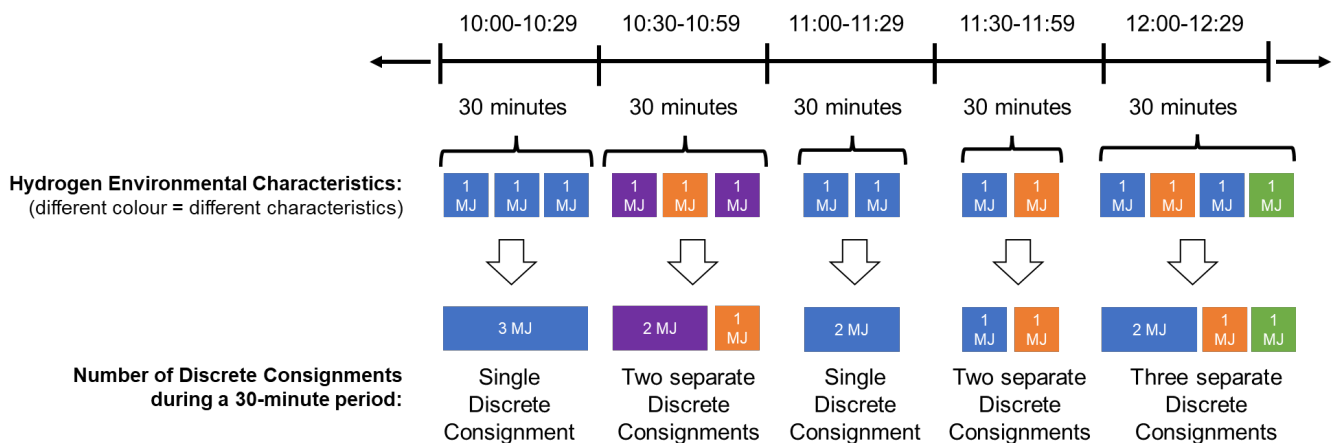

Figure 2: Illustrative diagram for generation of Discrete Consignments

Input-specific requirements for generating Discrete Consignments

Pathways without a feedstock

- 7.10. For Pathways without a feedstock, such as electrolysis, the use of electricity during a Reporting Unit that is sourced from the Electricity Grid and not linked to a specific generator shall not be split into its component parts (such as gas, coal, nuclear, wind, solar etc). Similarly, the consumption of electricity discharged from an Electricity Storage System during a Reporting Unit shall not be split into the component parts used to charge the Electricity Storage System.
- 7.11. For a Pathway without a feedstock using energy generated from mixed Waste (with fossil and biogenic components), both fossil and biogenic Discrete Consignments shall be generated – the Hydrogen Production Facility cannot choose to generate only one Discrete Consignment. The use of a mixed Waste to generate energy as an Input to a Pathway with a feedstock shall require both fossil and biogenic components of the mixed Waste to be accounted for within the GHG Emission Intensity of the Input electricity.

- 7.12. For Pathways without a feedstock, electricity consumed from each Electricity Storage System shall form its own Discrete Consignment (with its own GHG Emission Intensity) separate from other electricity source Discrete Consignments. Electricity consumed from multiple generation assets via a single Eligible PPA shall be separated into electricity Input types as per Paragraph 7.5 (each Discrete Consignment sharing the same electricity delivered GHG Emission Intensity)

Example: For a Reporting Unit, 10 MWh_{LHV} of electrolytic hydrogen is produced using 20% UK grid average electricity, 10% electricity from an Electricity Storage System (pumped hydro storage), 30% electricity from an Electricity Storage System (battery) and 40% via an eligible PPA with a wind farm. This example would result in four Discrete Consignments during that Reporting Unit, as given the absence of a feedstock for this Pathway, the Discrete Consignments are determined by the energy Inputs:

2 MWh_{LHV} of Hydrogen Product based on the grid average electricity GHG Emission Intensity
1 MWh_{LHV} of Hydrogen Product based on the Electricity Storage System (pumped hydro storage) discharged electricity GHG Emission Intensity, factoring in T&D losses between the pumped hydro storage and the electrolyser.

3 MWh_{LHV} of Hydrogen Product based on the Electricity Storage System (battery) discharged electricity GHG Emission Intensity, factoring in T&D losses between the pumped hydro storage and the electrolyser.

4 MWh_{LHV} of Hydrogen Product based on the wind farm electricity GHG Emission Intensity (nil), with any T&D losses between the wind farm and the electrolyser therefore being irrelevant to the delivered electricity GHG Emission Intensity.

Pathways with a feedstock

- 7.13. For Pathways with a feedstock, electricity from Electricity Storage Systems shall not form their own Discrete Consignments, although electricity from Electricity Storage Systems will impact the resulting hydrogen GHG Emission Intensity. In these cases, Discrete Consignments are defined based on the feedstock.
- 7.14. The use of natural gas sourced from the UK Gas Network is considered as one Input during a Reporting Unit and shall not be split into its component parts (for example, UK production, piped imports, imported liquified natural gas, biomethane etc).
- 7.15. For fossil gas Inputs, where a mix of different sources of the same type of fossil gas (for example, fossil natural gas sourced from the UK Gas Network and via a direct connection to a North Sea field) are used within a Reporting Unit, these shall be separated into individual Discrete Consignments.

Example: For a Reporting Unit, 250 MWh_{LHV} of H₂ is produced in an autothermal reforming with CCS Hydrogen Production Facility in England using 40% gas from the UK Gas Network, 20% Refinery Off Gas, 10% biomethane via direct connection to an anaerobic digester using half sustainable maize and half manure, and 30% directly imported Norwegian natural gas (% shares based on LHV energy contents), whilst also using 20 MWh_e of UK grid average electricity and 5 MWh_e of wind power. This example would produce five Discrete Consignments, determined by the feedstocks, and not by the Input electricity.

100 MWh_{LHV} of Hydrogen Product based on the UK Gas Network GHG Emission Intensity.

50 MWh_{LHV} of Hydrogen Product based on Refinery Off Gas calculations.

12.5 MWh_{LHV} of Hydrogen Product based on the maize biomethane calculations.

12.5 MWh_{LHV} of Hydrogen Product based on the manure biomethane calculations.

75 MWh_{LHV} of Hydrogen Product based on the imported Norwegian natural gas calculations.

Note that in all these Discrete Consignments, the Input electricity GHG Emission Intensity is calculated using 80% GB Electricity Grid and 20% wind power.

- 7.16. Where a mixed Waste feedstock has a biogenic and a fossil component (for example, municipal solid waste), this shall be considered as two distinct feedstocks resulting in two Discrete Consignments, split in line with the biogenic and fossil fractions on a LHV energy basis (see Annex H.45 – H.49).

Example: For a Reporting Unit, 10 MWh_{LHV} of hydrogen is produced by gasification using mixed Waste with a composition of 55% biogenic and 45% fossil Waste content by LHV energy. This would produce two Discrete Consignments, based on the feedstock components.

5.5 MWh of Hydrogen Product based on biogenic Waste calculations.

4.5 MWh of Hydrogen Product based on fossil Waste calculations, including the Fossil Waste/Residue Counterfactual Emissions Category

Calculation of Discrete Consignment GHG Emission Intensity

Emissions included in Discrete Consignments

- 7.17. The emissions attributed to a Discrete Consignment shall follow the emission categories set out in the GHG Emission Intensity Calculation Methodology.
- 7.18. Emissions for each Discrete Consignment shall be calculated based on the use of Inputs and release/capture of Outputs within each Reporting Unit, irrespective of whether these emissions relate to hydrogen production processes during that Reporting Unit, or to the operation of Hydrogen Storage or pre/post-production

ancillary processes (e.g. onsite feedstock pre-processing, Buffer Storage, hydrogen purification).

- 7.19. For Inputs that arrive onsite via a permanent connection, emissions shall be accounted for based on the amount of Input that flows across the System Boundary within each Reporting Unit.
- 7.20. For Inputs that arrive onsite as batches (and are therefore likely stored onsite prior to use, e.g. a truck load of a particular chemical or diesel), emissions shall be accounted for based on the consumption of these Inputs within the Hydrogen Production Facility for each Reporting Unit. All of the emissions associated with the delivery itself (such as from the delivery vehicle) shall be spread over the consumption of the input, and not be accounted for within the Reporting Unit when the delivery arrives onsite.
- 7.21. Emissions for Outputs (for example, Fugitive non-CO₂ emissions) shall be accounted for within the Reporting Unit in which they occur.
- 7.22. Similarly, any LHV Energy Allocation of emissions to Co-products shall be based on the Reporting Unit in which the Hydrogen Product and Co-products are generated.
- 7.23. Discrete Consignment emissions shall not be based on tracking individual units of Hydrogen Product between Reporting Units. For example, emissions linked to running on-site Hydrogen Storage are accounted for by any Hydrogen Product generated within that Reporting Unit, rather than being assigned to the Discrete Consignments that have already been generated and stored within the Hydrogen Storage.

GHG Emission Intensity calculations for each Discrete Consignment

- 7.24. The Raw GHG Emission Intensity calculated (using Equation 2) for each Discrete Consignment shall be calculated as gCO₂e/MJ_{LHV} Hydrogen Product, based on the GHG emissions generated within the Reporting Unit and the Hydrogen Product (including impurities) produced within the same Reporting Unit. Note that the calculation shall not use gCO₂e/MJ_{LHV} *pure* hydrogen, nor shall it use gCO₂e/MJ_{LHV} hydrogen *sold* or gCO₂e/MJ_{LHV} hydrogen *stored*.
- 7.25. If there are any Reporting Unit(s) where no Hydrogen Product is generated, but there are still GHG emissions being generated (for example, due to energy consumption during hot standby or maintenance periods), then these Cumulative Non-Production Emissions shall be spread across the first 24 hours of Hydrogen Product once hydrogen production restarts, using the following method:
- The GHG emissions occurring across a consecutive sequence of Reporting Units without generation of Hydrogen Product shall be added together to form the Cumulative Non-Production Emissions (in gCO₂e). Even if there is only a

single Reporting Unit without generation of Hydrogen Product, the GHG emissions occurring within this Reporting Unit will form the Cumulative Non-Production Emissions.

- As soon as hydrogen production restarts (that is, there is a Reporting Unit in which Hydrogen Product is generated), the Cumulative Non-Production Emissions shall be divided by the total Hydrogen Product (in MJ_{LHV}) produced within the 24 hour period from the beginning of the Reporting Unit in which hydrogen production restarted.
- The resulting average extra gCO₂e/MJ_{LHV} Hydrogen Product value shall then be added onto the Raw GHG Emission Intensities for every Discrete Consignment within the 24 hour period from the beginning of the Reporting Unit in which hydrogen production restarted, to achieve the Final GHG Emission Intensity result (gCO₂e/MJ_{LHV} Hydrogen Product) for these Discrete Consignments. This is set out in Equation 29. Note these extra emissions shall be assigned to every Discrete Consignment of Hydrogen Product within the 24 hour period, and not necessarily assigned to every Reporting Unit within the 24 hour period.

Equation 29

$$\begin{aligned}
 & \textit{Final GHG Emission Intensity}_{DC} \\
 &= \textit{Raw GHG Emission Intensity}_{DC} \\
 &+ \frac{\sum_{RU\ stop+1}^{RU\ restart-1} \textit{GHG emissions}}{\sum_{RU\ restart}^{RU\ restart+47} \textit{Hydrogen Product}}
 \end{aligned}$$

Where:

- RU = Reporting Unit
- DC = Discrete Consignment

- 7.26. Passing midnight at the end of a calendar month has no impact on these GHG Emission Intensity calculations. Any Cumulative Non-Production Emissions shall continue to accumulate and be rolled over until the next Reporting Unit with Hydrogen Product generated, even if this several months later.
- 7.27. It is possible that hydrogen production might restart, stop shortly after (with new Cumulative Non-Production Emissions then occurring), then restart again within 24 hours of the first restart. If this situation arises, the above principles for calculating Final GHG Emission Intensities shall still apply, and some of the Raw GHG Emission Intensities will have two sets of Cumulative Non-Production Emissions added to them (a further fraction shall be added to Equation 29 for the relevant Discrete Consignments). If there are even more frequent restarts and Cumulative Non-Production Emissions occurring during these short intermediate non-production

periods, the same principles shall still apply (further fractions shall be added to Equation 29 for the relevant Discrete Consignments).

Figure 3: Illustrative GHG emissions and Final GHG Emission Intensities with the reallocation of the Cumulative Non-Production Emissions (red) shows an indicative example adding the Cumulative Non-Production Emissions resulting from a spell of no hydrogen production (red boxes) to the Raw GHG Emission Intensities for each Discrete Consignment in the 24 hours following the restart of hydrogen production.

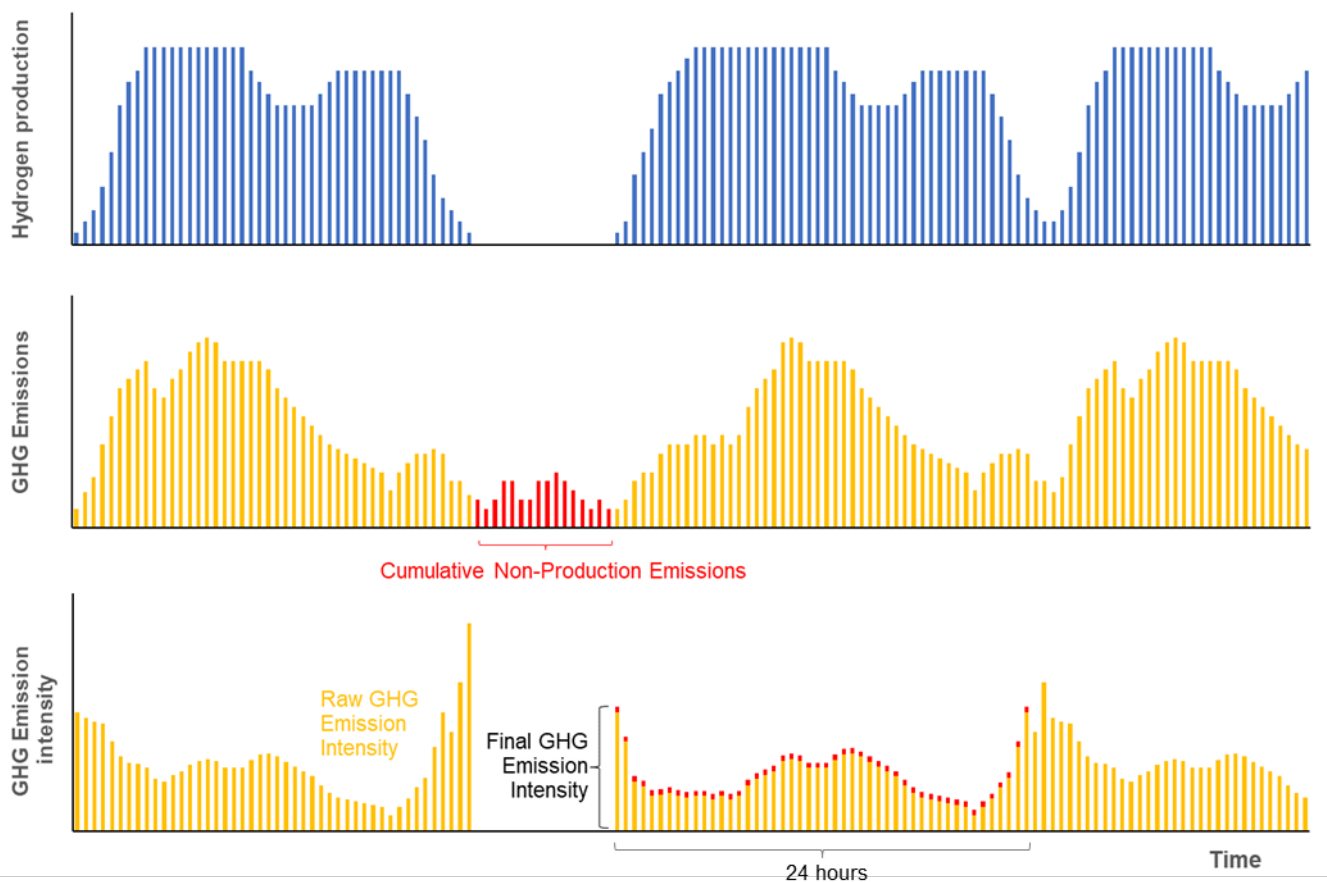

Figure 3: Illustrative GHG emissions and Final GHG Emission Intensities with the reallocation of the Cumulative Non-Production Emissions (red)

Monthly Reporting and Weighted Average Consignments

- 7.28. Each Discrete Consignment during a calendar month, along with its Raw and Final GHG Emission Intensities and other Environmental Characteristics as set out in Paragraphs 7.4-7.5, shall be reported separately at the end of the calendar month. This reporting includes any Discrete Consignments that fail to meet the GHG Emission Intensity Threshold or are generated when a Hydrogen Production Facility is not meeting the Conditions of Standard Compliance.

-
- 7.29. At the end of each calendar month, for any Discrete Consignments in that calendar month meeting the Conditions of Standard Compliance and having a non-negative Final GHG Emission Intensity, the Hydrogen Production Facility has the option to calculate and report Weighted Average Consignments based on a selected aggregation of these Discrete Consignments. Any Weighted Average Consignment shall report a Final GHG Emission Intensity that is the weighted average of its constituent Discrete Consignments, based on the MJ_{LHV} energy contents of the selected Discrete Consignments (note this is not a simple arithmetic average of the Final GHG Emission Intensity values).
- 7.30. Discrete Consignments with negative Final GHG Emission Intensities⁹ shall not be included in a Weighted Average Consignment and shall be reported separately.
- 7.31. There is no requirement for the individual Discrete Consignments included within or excluded from a Weighted Average Consignment to be compliant with the GHG Emission Intensity Threshold. There is also no requirement that any Weighted Average Consignment itself is compliant with the GHG Emission Intensity Threshold¹⁰.
- 7.32. If the Final GHG Emission Intensity of a Weighted Average Consignment is less than or equal to the GHG Emission Intensity Threshold, then **all** Discrete Consignments included within that Weighted Average Consignment may be claimed as complying with the Standard. Alternatively, if the Final GHG Emission Intensity of a Weighted Average Consignment is above the GHG Emission Intensity Threshold, then **none** of the Discrete Consignments included within that Weighted Average shall be claimed as complying with the Standard.
- 7.33. The Discrete Consignments selected for a monthly Weighted Average Consignment do not have to be from the same or consecutive Reporting Units, nor do they have to share the same Environmental Characteristics. However, only Discrete Consignments that are generated when the Hydrogen Production Facility meets the Conditions of Standard Compliance may be included within a Weighted Average Consignment.
- 7.34. The Hydrogen Production Facility may choose to report as many Weighted Average Consignments within each calendar month as they desire. However, each Discrete Consignment can only be included within one Weighted Average Consignment (no double counting of Discrete Consignments). Only Discrete Consignments produced

⁹ A negative GHG Emission Intensity does not imply necessary or sufficient evidence has been provided to meet UK Government requirements for a 'greenhouse gas removal', or 'permanence' of storage for biogenic CO₂/Solid Carbon, or monitoring/reporting/verification of the same. Separate UK policies are being developed in these areas.

¹⁰ However, note that Discrete Consignments or a Weighted Average Consignment need to be compliant with the Standard to qualify for support from the policies which apply the Standard.

in the calendar month can be included in Weighted Average Consignments for that month.

- 7.35. Any relevant Weighted Average Consignments shall be reported every calendar month. It shall be indicated which Discrete Consignments have been included within each Weighted Average Consignment.

Example: Figure 4 provides an illustrative example of Discrete Consignments produced over a month, ordered by increasing Final GHG Emission Intensity. The width of the column represents the MJ_{LHV} of Hydrogen Product while the height of the columns represents the Final GHG Emission Intensity of each Discrete Consignment.

Discrete Consignments that are coloured in green and yellow have a Final GHG Emission Intensity below the GHG Emission Intensity Threshold. Discrete Consignments that are coloured in orange and red have a Final GHG Emission Intensity above the GHG Emission Intensity Threshold.

If all the orange Discrete Consignments are combined with all the yellow Discrete Consignments, this will result in a Weighted Average Consignment with a weighted average GHG Emission Intensity of 19.6 gCO_{2e}/MJ_{LHV} (shown as a purple line) that is still below the GHG Emission Intensity Threshold.

As a result of the Weighted Average Consignment, the amount of Hydrogen Product that now meets the GHG Emission Intensity Threshold will increase and include green, yellow and orange Discrete Consignments. The red Discrete Consignments are not included in this Weighted Average Consignment as they would cause the Weighted Average Consignment to exceed the GHG Emission Intensity Threshold.

The red Discrete Consignments could either be reported separately or reported as a second Weighted Average Consignment, however the GHG Emission Intensity Threshold will be exceeded in both cases.

The green Discrete Consignments are reported separately and are not to be included in any Weighted Average Consignment, as these Discrete Consignments have negative Final GHG Emission Intensities.

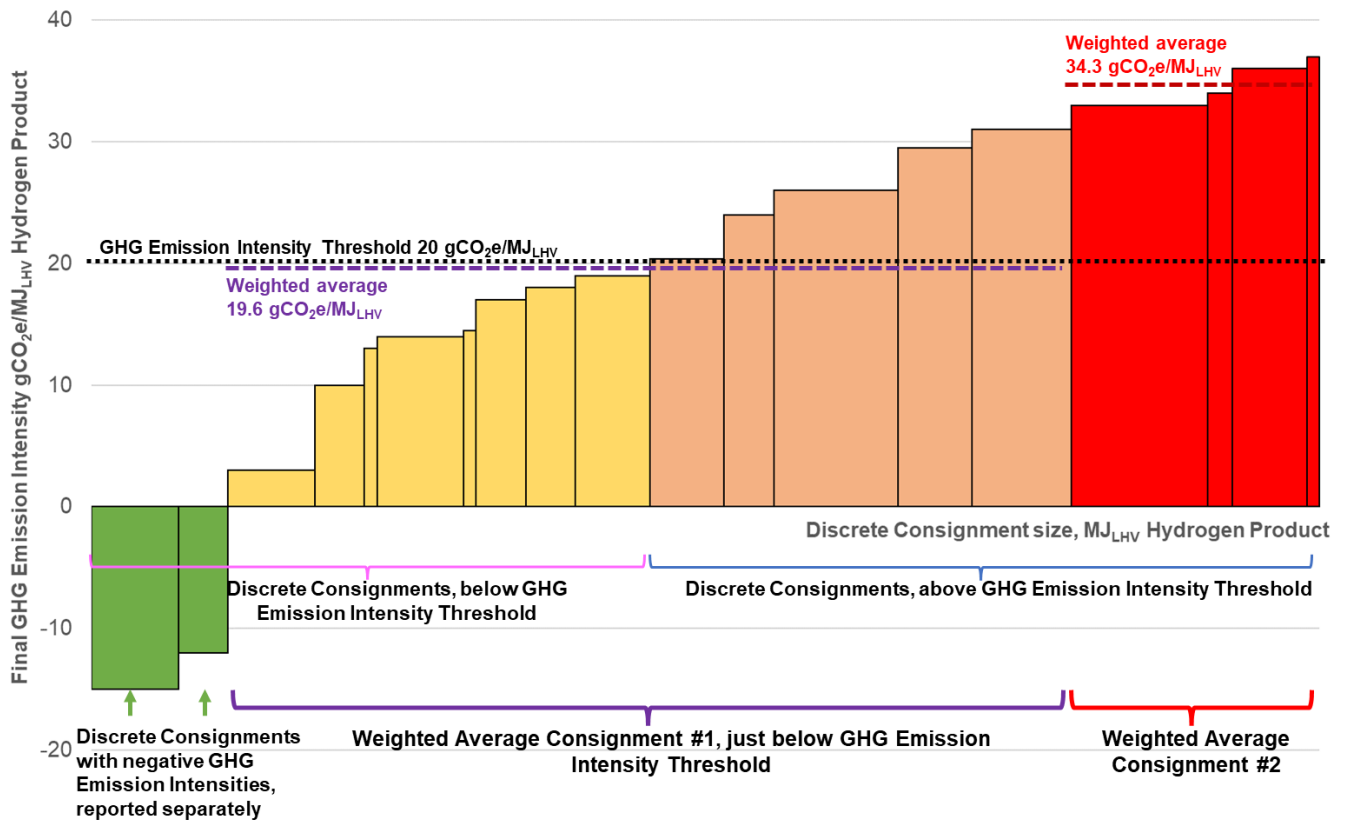

Figure 4: Illustrative example of optional monthly weighted averaging

8. Monitoring, Reporting and Verification (MRV) Framework

- 8.1. Data and supporting evidence will need to be provided to substantiate whether Consignments are compliant with the Standard. This chapter provides a monitoring, reporting and verification (MRV) framework, to set minimum requirements for metering, measurement, data provision, reporting, audit and other verification, for the purposes of calculating the GHG Emission Intensity of the Hydrogen Product and determining compliance with the Standard. This Chapter should be read in conjunction with the requirements in Chapter 9 and Annex H, including those relating to the Data Collection and Monitoring Procedure (DCMP).
- 8.2. Individual schemes applying the Standard may specify additional or more detailed MRV requirements that shall be complied with by the relevant Hydrogen Production Facilities, both before and during Facility operation.
- 8.3. Schemes which apply the Standard may require different types of information to be submitted at multiple points, including at application, during study/construction stages, at build completion, and on an ongoing basis once hydrogen production begins. This chapter sets minimum requirements for Facilities providing emissions projections against the Standard before hydrogen production has begun, and separately for Facilities reporting against the Standard once hydrogen production is underway.

Before Facility operation

- 8.4. Proof that a prospective Hydrogen Production Facility is capable of meeting the Standard is often required as an eligibility criterion for schemes which apply the Standard, such as the Hydrogen Production Business Model (HPBM).
- 8.5. Prospective Hydrogen Production Facilities are likely to be required to demonstrate through calculation and supporting evidence, to the satisfaction of the scheme applying the Standard, that Hydrogen Product generated by their Facility will likely be able to comply with the GHG Emission Intensity Threshold and the Conditions of Standard Compliance.
- 8.6. Prospective Hydrogen Production Facilities are likely to be required to use the 'Hydrogen Emissions Calculator' (HEC)¹¹, a comprehensive tool which implements the Standard GHG Emission Intensity Calculation Methodology. For Eligible Hydrogen Production Pathways, the HEC assesses the likely average Hydrogen

¹¹ Available [online](#)

Product GHG Emission Intensity and likely Standard Compliance over the course of a future year of projected Facility operations.

- 8.7. If a Hydrogen Production Facility intends to use an Input for which the material classification is unclear, evidence shall be submitted to DESNZ following the guidance under Paragraph 5.10.
- 8.8. More detail on the required or optional data choices at this stage is provided in Chapter 9. It is understood that before Facility operation, there may be gaps in prospective Facility data. Supporting Typical Data and Default Data is provided in the Data Annex to assist with filling these gaps. Regardless of the data used, Pre-operational Hydrogen Production Facilities shall clearly reference the assumptions and supporting evidence behind any data (or other claims) used and should be prepared to provide further evidence if requested.
- 8.9. Note that a HEC submission demonstrating a compliant GHG emissions result is not proof that a prospective Hydrogen Production Facility is capable of complying with the Standard, nor eligible for any schemes which apply the Standard. HEC submissions and supporting evidence will be subject to verification within the schemes applying the Standard. Only once a completed version of the HEC¹² and all accompanying evidence have been subject to detailed review for validity and consistency, will the relevant scheme applying the Standard be able to state whether a prospective Facility is likely to be capable of complying with the Standard.
- 8.10. Before the start of commercial operations, the Hydrogen Production Facility shall formulate and agree a Data Collection and Monitoring Procedure with the Delivery Partner. See Annex H for details.

During Facility operation

- 8.11. Once a Facility has begun commercial operation, Hydrogen Production Facilities shall calculate the GHG Emission Intensity of their Hydrogen Product on a Discrete Consignment basis, as described in Chapter 7. Hydrogen Production Facilities receiving support from or enrolled in schemes applying the Standard shall measure, calculate, report, verify and be subject to audit on compliance with the Standard on a Discrete Consignment basis, following the requirements of their latest DCMP, and according to the agreed terms of the relevant scheme applying the Standard.

Monitoring

- 8.12. Hydrogen Production Facilities shall monitor, record, calculate and hold available (for any reporting or auditing activities) all data and supporting evidence demonstrating

¹² Note that this may be one or multiple files, as in some cases, multiple HEC files are needed to represent multiple consignments. More information can be found in the HEC file.

compliance with the requirements of the Standard, including the following data (where applicable):

On a monthly basis:

- Assessment of Emission Sources during the month against the Materiality Threshold, and confirmation that all Material Emission Sources in the month have been accounted for in the GHG Emission Intensity calculations, or that there is compelling evidence that a given Material Emission Source has been impossible to quantify.
- The Environmental Characteristics of each Discrete Consignment (as per Paragraph 7.4 or 7.5, depending on the Pathway), including Final GHG Emission Intensity.
- For Inputs with a mix of biogenic and fossil contents, the LHV energy share of the biogenic and fossil fractions.
- The references for the Input or Output GHG Emission Intensity values – either identifying the Typical Data used from the Data Annex, or where not available, evidencing the calculations and sources underpinning any Non-Typical GHG Emission Intensities with justification for their use.
- For Input energy sources, any fuel used and generation LHV efficiency (where relevant), along with the name, location and capacity of the installation where the energy was generated, and losses in delivery (e.g. Transmission and Distribution or thermal losses).
- For all electricity Inputs, evidence that such electricity Inputs comply with the requirements of Annex B and where relevant, Annex C.
- Evidence of the calculations and sources underpinning any estimated fugitive non-CO₂ emissions from the Hydrogen Production Facility, with justification for their use.
- Evidence that CO₂ claimed as a CO₂ Sequestration credit has been captured from the Hydrogen Production Facility and injected into a CO₂ T&S Network, as demonstrated by a connection agreement and transfer of responsibility for the CO₂.
- Evidence any Solid Carbon claimed as a Solid Carbon Sequestration credit will be used in a Solid Carbon Permissible End Use as per the Data Annex Paragraph DA.54, along with the form of the Solid Carbon.
- Allocation factors used for each Co-Product within the Pathway and Cumulative Allocation Factors. LHV efficiencies of each Step within the Pathway.
- Metering and measurement data: Activity Flow Data for all relevant Feedstocks, Energy Supply and Input Materials; and for all relevant Outputs. Further requirements for metering and measuring Activity Flows is set out in Annex H. In the case of Measurement and Meter Failure, the Hydrogen Production Facility

shall record the time of failure and contact the Delivery Partner to agree on an approach.

- Invoices recording the quantities of Inputs and Outputs during the month, and mass balance evidence where required to derive Estimated Data (see Annex H).
- For all biogenic feedstocks and biogenic energy Inputs, evidence that the Sustainability Criteria (Land Criteria, Soil Carbon Criteria and/or Forest Criteria) and the Minimum Waste and Residue Requirement are met (see Annex E).
- The GWP dataset used in the GHG Emission Intensity calculations.
- Raw GHG Emission Intensities for each Discrete Consignment, with a breakdown by Emission Category.
- Identification of which Discrete Consignments produced in the month comply or do not comply with the Standard, including compliance (or not) with each of the Conditions of Standard Compliance.
- Calculations for the determination of Weighted Average Consignments, clearly identifying which Discrete Consignments are included in each Weighted Average Consignment, the Final GHG Emission Intensity of each Weighted Average Consignment, and which Weighted Average Consignments (and their constituent Discrete Consignments) comply or do not comply with the Standard.
- For all biogenic feedstocks and biogenic energy Inputs, estimated indirect land-use change (ILUC) GHG emissions (given in gCO_{2e}/MJ_{LHV} Hydrogen Product), reported separately to the Final GHG Emission Intensities for all the Discrete Consignments. Evidence to include the original biomass material used, supply chain efficiency and ILUC factor applied.
- Any other Data Collection and Monitoring Procedure data, as agreed with the Delivery Partner.

On an annual basis:

- The total number of REGO certificates that have been procured and cancelled, in accordance with Annex B requirements, to cover the volume of REGO registered electricity that has been sourced for hydrogen production during each REGO Year.
- An updated Fugitive Hydrogen Emissions Risk Reduction Plan (see Chapter 10).
- The Fugitive Hydrogen Emissions Annual Report (see Chapter 10).
- Annual statement of last year's total electricity consumption across a Private Network, if relevant.
- For any Electricity Storage System, the percentage State of Health, Ideal Capacity, Self Discharge Loss and Round Trip Efficiency.

-
- Any other Data Collection and Monitoring Procedure data as agreed with the Delivery Partner.

On an ongoing basis, to be updated only if changes occur:

- The Eligible Hydrogen Production Pathway and hydrogen production technology utilised.
- For Input heat and/or steam from outside the System Boundary, a diagram showing the pipework connecting the energy generation asset and the Hydrogen Production Facility.
- Any other Data Collection and Monitoring Procedure data as agreed with the Delivery Partner.

8.13. The following list shows example data/documents that may be required as supporting evidence to back up the lists above:

- The main equipment list for hydrogen production;
- Process flow diagrams, piping & instrumentation diagrams;
- Business licenses, permits or planning permissions;
- Supply agreements for feedstock, fuel, energy and Input Materials;
- Signed statements from third parties evidencing GHG Emission Intensities;
- Mass and energy balances;
- Metering system diagram, Single Line Diagram;
- The list of Steps in the Pathway, including locations of feedstocks, storage, transport and pre-processing, prior to the Facility;
- Operations date, production capacity and utilisation information.

Reporting

8.14. Schemes applying the Standard may require a range of information to be reported for the purposes of evidencing compliance with the Standard. Relevant periods for reporting may also vary. Hydrogen Production Facilities shall refer to the Delivery Partner regarding the list of monthly, annual, continual and/or one-off reporting requirements that apply for a particular scheme.

8.15. Hydrogen Production Facilities shall provide data for any Material Emission Sources, even if data is uncertain. However, if there is compelling evidence provided that an individual Emission Source is impossible to quantify for a particular Step, despite it being likely to be a Material Emission Source, the Delivery Partner may agree that this Emission Source can be excluded and reported as a data exclusion. Agreed data exclusions shall be reported at a frequency set by the Delivery Partner, with evidence for the omission.

Verification

- 8.16. Hydrogen Production Facilities shall ensure that all relevant data and supporting evidence is recorded and reported fully and accurately, to the best of their knowledge, and as required by the relevant scheme applying the Standard. Where data is sourced from a third-party, the Hydrogen Production Facilities should ensure that due and careful enquiries are made to verify the data quality, and reference the data sources used.
- 8.17. All data and other information submitted for the purpose of the Standard shall be subject to comprehensive verification processes on a frequency set by the Delivery Partner, and should include verification by an independent third party and more frequent, risk-based verification of important data sources. Schemes applying the Standard may choose to implement spot check audits (including site visits), especially if there is a perceived inconsistency with any reporting.
- 8.18. In cases where data and supporting evidence for a Discrete Consignment is required to be included but is missing or is deemed to be of insufficient quality, the Discrete Consignment shall be considered not compliant with the Standard – unless the Delivery Partner agrees alternative data can be provided or an exclusion applied.

9. Data types and quality

9.1. A Hydrogen Production Facility will need to refer to a variety of data sources to support GHG Emission Intensity calculations and to determine Standard Compliance. This chapter introduces the types of data and principles of data use that shall apply to all supporting data. Note that data values provided by DESNZ for use within the Standard are mostly given in the Data Annex and are not provided in this Chapter.

Data types

9.2. Three categories of data underpin the GHG Emission Intensity calculations for each Discrete Consignment, following Equation 1 in Chapter 5:

- Activity Flow Data for every relevant Emission Source;
- GHG Emission Intensities (and/or GWPs) for every relevant Emission Source;
- The total quantity of Hydrogen Product, P (see Equation 2).

9.3. Hydrogen Production Facilities reporting against the Standard shall use accurate and high-quality data. Table 2 sets out the different types of data which shall be sourced, either before or during the operation of a Hydrogen Production Facility:

Table 2: Appropriate data sources before and during operations

	Activity Flow Data	GHG Emission Intensity	Hydrogen Product
Before Facility operation	Projected Data shall be used.	Typical Data shall be used for the relevant future year (see Data Annex). Where Typical Data is not available, representative Non-Typical Data shall be sought for the relevant future year.	Projected Data shall be used.
	Where Projected Data and/or both Typical Data and Non-Typical Data are not available within the Feedstock Supply, Energy Supply and/or Input Materials Emission Categories, Default Data (see Data Annex Paragraphs DA.73-DA.85) for the respective Emission Category may be used instead.		

During Facility operation	Measured Data shall be used in the cases specified in Annex H. In all other cases, reasonable Estimated Data shall be used and supported with evidence.	Typical Data shall be used for the relevant time period (see Data Annex). Where Typical Data is not available, representative Non-Typical Data shall be sought for the relevant time period.	Measured Data shall be used, as detailed in Annex H.
---------------------------	---	--	--

- 9.4. Default Data values are provided in the Data Annex Paragraphs DA.73-DA.85, on an Emission Category basis in line with Equation 1 (see Chapter 5) and are only available for certain Pathways and certain Emission Categories. They are based on central estimates from Pathway modelling, and generally multiplied by a factor of 1.4 to provide conservative values. A pre-operational Hydrogen Production Facility which does not have Default Data available for their Pathway or Emission Category shall use Projected Data and Typical Data or Non-Typical Data. For a given Emission Category for a pre-operational Hydrogen Production Facility, either only the Default Data value shall be used, or Projected Data combined with Typical Data or Non-Typical Data. Default Data shall not be used once a Hydrogen Production Facility is operational.
- 9.5. Typical Data values are provided in the Data Annex and shall be used if these Inputs or Outputs are used within the Hydrogen Production Pathway. Where Typical Data values are not available in the Data Annex for the Pathway in question, representative Non-Typical Data values shall be used, and if a methodology for deriving a GHG Emission Intensity for a particular Input or Output is given in the Standard, this methodology shall be used. If such a methodology for Non-Typical Data is not specified in the Standard, the Facility shall reference a reputable source, or calculate its own value, with a justification and appropriate supporting evidence for its applicability and aiming to be as consistent as possible with the overall GHG Emission Intensity Calculation Methodology.
- 9.6. Measured Data values shall be determined following the requirements of Annex H and any scheme applying the Standard. In the absence of Measured Data, Estimated Data shall be used, as specified in Annex H.
- 9.7. Where the Standard requires theoretical calculations for hydrogen Compression and Purification, Hydrogen Production Facilities shall use Data Annex Paragraphs DA.56-DA.65.

Data quality

- 9.8. Irrespective of data type, any underlying calculations, evidence and assumptions behind the data value, and the justification for its use, shall be held available by the Hydrogen Production Facility, in order for any MRV requirements in Chapter 8 to be met.
- 9.9. The Hydrogen Production Facility should record the following quality aspects when providing data:
- Time-related coverage: age of data and the minimum length of time over which data shall be collected.
 - Geographical coverage: geographical area from which data for unit processes shall be collected.
 - Technology coverage: specific technology or technology mix.
 - Precision: measure of the variability of each data value expressed (for example, variance).
 - Completeness: percentage of total flow that is measured or estimated.
 - Representativeness: qualitative assessment of the degree to which the data set reflects the true activity of interest (that is, geographical coverage, time period and technology coverage).
 - Consistency: qualitative assessment of whether or not the methodology used is applied uniformly to the various components of the analysis.
 - Reproducibility: qualitative assessment of the extent to which information about the methodology and data values would allow an independent practitioner to reproduce the reported results.
 - Sources of the data.
 - Uncertainty of the information.
- 9.10. Assessments of data quality, undertaken by a Hydrogen Production Facility, independent third party auditor, Delivery Partner, or any other party applying MRV against the Standard, shall be informed by the aspects listed above.

10. Fugitive Hydrogen Emissions

- 10.1. Hydrogen itself does not trap infrared radiation and so is not a direct Greenhouse Gas (GHG). However, if released to atmosphere – for instance through fugitive emissions – hydrogen would change the chemistry of the atmosphere and could prolong the lifetime of other direct GHGs, particularly methane. This, in turn, would increase the warming effect of methane in the atmosphere. This and other ‘indirect’ effects mean emissions of hydrogen have an impact on climate change.
- 10.2. DESNZ commissioned work from the University of Cambridge to understand the climate impact of hydrogen emissions using modern climate models¹³. This has reinforced the finding that hydrogen is an indirect Greenhouse Gas. We also commissioned work to better understand where fugitive emissions stem from in the hydrogen production technology¹⁴.
- 10.3. Work is still ongoing to narrow uncertainties for both the Global Warming Potential (GWP) impact and leakage rates from hydrogen production, but a hydrogen GWP may be included within the GHG Emission Intensity calculation under the Standard in the future. Ahead of this, Hydrogen Production Facilities should apply best available techniques set out by the UK Government and its agencies.

Specific requirements for Hydrogen Production Facilities

Fugitive Hydrogen Emissions Risk Reduction Plan

- 10.4. Prior to operations commencing, Hydrogen Production Facilities shall complete a Fugitive Hydrogen Emissions Risk Reduction Plan containing the sections outlined below and meeting the requirements entailed therein. Failure to complete this Fugitive Hydrogen Emissions Risk Reduction Plan will prevent compliance with the Standard.

Section 1: Demonstrate how fugitive hydrogen emissions at the Hydrogen Production Facility will be minimised

- 10.5. A plan shall be provided demonstrating how the Hydrogen Production Facility will be designed and operated to ensure that expected fugitive hydrogen emissions are kept as low as reasonably practical. As a minimum, the plan shall consider each fugitive hydrogen source detailed in Paragraph 10.13 that is relevant to the Hydrogen Production Facility. All assumptions shall be stated.

¹³ <https://www.gov.uk/government/publications/atmospheric-implications-of-increased-hydrogen-use>

¹⁴ <https://www.gov.uk/government/publications/fugitive-hydrogen-emissions-in-a-future-hydrogen-economy>

-
- 10.6. Paragraphs 10.14-15 below outline some possible actions that may be taken to minimise fugitive hydrogen emissions.

Section 2: Provide estimates of expected rates of fugitive hydrogen emissions by the Facility

- 10.7. Hydrogen Production Facilities shall provide the expected future fugitive hydrogen emissions in kg pure H₂/year, assuming the mitigation plan in Paragraph 10.4 is followed. The estimate shall include a breakdown of different fugitive hydrogen sources considered, and as a minimum shall show consideration of each source described in Paragraph 10.13 that is relevant to the Hydrogen Production Facility. All assumptions shall be stated, and justification shall be provided where any fugitive hydrogen sources are considered negligible.

Section 3: Prepare a monitoring methodology for fugitive hydrogen emissions.

- 10.8. A methodology for measuring and monitoring overall fugitive hydrogen emissions from the Hydrogen Production Facility in operation shall be provided. The methodology shall account for each fugitive hydrogen emission source described in Paragraph 10.13 that is relevant to the Hydrogen Production Facility. Fugitive hydrogen sources that have been identified as not measurable do not need to be monitored.
- 10.9. The Hydrogen Production Facility may use their discretion in determining the monitoring methodology, provided they are able to account for all potential measurable fugitive hydrogen streams. Approaches may include direct monitoring of hydrogen streams (for example in vent ducts) or mass balance approaches to track overall flows of hydrogen.

Fugitive Hydrogen Emissions Annual Report and Annual Review

- 10.10. Once operational, a Hydrogen Production Facility shall provide a Fugitive Hydrogen Emissions Annual Report each year which sets out an estimate of the fugitive hydrogen emissions that have occurred in the past year, in kg pure H₂. The estimate shall include a breakdown of different fugitive hydrogen sources considered, and as a minimum shall consider each source described in Paragraph 10.13 that is relevant to the Hydrogen Production Facility. All assumptions shall be stated, and justification shall be provided where any fugitive hydrogen sources are considered negligible. The report shall include any actions taken in the past year to mitigate fugitive hydrogen emissions.
- 10.11. The Fugitive Hydrogen Emissions Risk Reduction Plan in Paragraphs 10.4-10.9 shall be reviewed and updated annually and shall report on any progress made to minimise emissions. The Fugitive Hydrogen Emissions Risk Reduction Plan shall be updated to address:

-
- Any progress that has been made to minimise fugitive hydrogen emissions set out in Paragraph 10.5, including any updates implemented to reflect evolving best practices;
 - An updated estimate of expected future annual fugitive hydrogen emissions as per Paragraph 10.7;
 - Any changes made to the monitoring methodology in Paragraphs 10.8-10.9.

10.12. Failure to provide a Fugitive Hydrogen Emissions Annual Report or an annual update to the Fugitive Hydrogen Emissions Risk Reduction Plan will result in non-compliance with the Standard for all Discrete Consignments produced after an agreed deadline with the Delivery Partner for the submission of such documents. Non-compliance due to this reporting failure can only be reversed if the required documents are subsequently provided.

Guidance: Fugitive hydrogen sources at a Hydrogen Production Facility

10.13. The following processes have been identified as being potentially significant sources of fugitive hydrogen at a Hydrogen Production Facility and shall be considered by a Hydrogen Production Facility when considering how to minimise fugitive hydrogen emissions. The list is not exhaustive and further significant sources may exist.

Process venting

- Cold vents are likely to be the most significant source of fugitive hydrogen emissions at a Hydrogen Production Facility.
- 'Routine' hydrogen vents may arise because of hydrogen purification or separation Steps, where some residual hydrogen remains in a Waste stream. Possible occurrences include:
 - Where a purging flow of hydrogen is used to regenerate separation adsorbents;
 - Hydrogen cross-over into the oxygen stream (electrolysis only) or pass through into tail gases during purification;
 - Hydrogen may also be vented during Hydrogen Production Facility start-up and shut-down when equipment is purged. The significance of this will depend on the frequency of Hydrogen Production Facility start-ups and shut-downs.

Compressors

- Hydrogen compressors are likely to be a source of fugitive hydrogen emissions and shall be considered when they are included on site at the Hydrogen Production Facility. Fugitive emissions may arise due to:

-
- Permeation through seals;
 - Compressor venting for maintenance (likely to be negligible, depending on frequency).

On-site Storage

- Above-ground stationary hydrogen storage is likely to be a significant source of fugitive hydrogen emissions and shall be considered when this is included on site at the Hydrogen Production Facility.
 - Compressed hydrogen cylinders are susceptible to leakage. The significance will depend on the storage pressure, cylinder material, cylinder size and valve type;
 - Liquid hydrogen storage may result in fugitive emissions arising from hydrogen boil-off.

Flares (Negligible)

- Incomplete combustion in any flares may result in some residual hydrogen being released to the atmosphere. This is expected to be negligible provided flares are well designed and maintained.

Leakage through pipework and joints (Negligible)

- Hydrogen leakage through joints, valves etc. are expected to be negligible provided that best practice is followed, including using welded joints wherever possible and ensuring that equipment is maintained in good condition.

Guidance: Minimising fugitive hydrogen emissions

10.14. As a priority, Hydrogen Production Facilities should minimise all cold venting of hydrogen. This may be achieved by:

- Ensuring that hydrogen is fully separated from any vented streams (for example, water vapour or oxygen);
- Finding alternative uses for the hydrogen within the Hydrogen Production Facility and recirculating it;
- Directing Waste streams to flare rather than cold vent.
- It is especially important that “routine” vents are minimised. Occasional vents may be permissible, for example if they are deemed to be necessary for safety.

10.15. Hydrogen leakage throughout the Hydrogen Production Facility should be minimised by ensuring best practice is followed, including:

-
- Using welded joints wherever possible;
 - Ensuring use of suitable materials and valves, in particular for high pressure equipment;
 - Fully leak-testing the Hydrogen Production Facility during commissioning.

Annex A: Eligible Hydrogen Production Pathways

Overview

- A. 1. Paragraph 4.2 sets out the Eligible Hydrogen Production Pathways under the Standard. This Annex provides more detail on these Pathways, which informs how specific Hydrogen Production Facilities are categorised under the Standard.

Electrolysis

- A. 2. A typical water electrolysis cell consists of an anode and a cathode separated by a membrane immersed in an electrolyte (a conductive solution). When the electrodes are connected to a direct current power supply, electricity causes the water to split into oxygen at the anode, with ions flowing through the electrolyte, and hydrogen forming at the cathode. Each electrolyser system consists of a stack of electrolysis units, a gas purifier and dryer, compression, and an apparatus for heat removal.
- A. 3. There are currently three main electrolyser technologies, distinguished by the electrolyte (and associated operating temperatures): alkaline (ALK) electrolysers, polymer electrolyte membrane (PEM) electrolysers and solid oxide (SOEC) electrolysers.
- A. 4. Hydrogen and oxygen gas products are purified, dried, and cooled prior to storage and/or delivery to market, subject to required product specifications. The oxygen gas should be safely vented to the atmosphere or recovered and utilised.
- A. 5. For illustrative purposes, simplified flow diagrams are shown in Figure 5 for low temperature electrolysis and Figure 6 for high-temperature electrolysis using nuclear generated electricity and heat. These provide information on the primary Inputs used and the resulting primary Outputs. Note that Inputs and Outputs may vary (for example, oxygen may be utilised, electricity used for deionisation may vary, water input sources may vary and not all electrolysers may require chemical inputs for water deionisation).

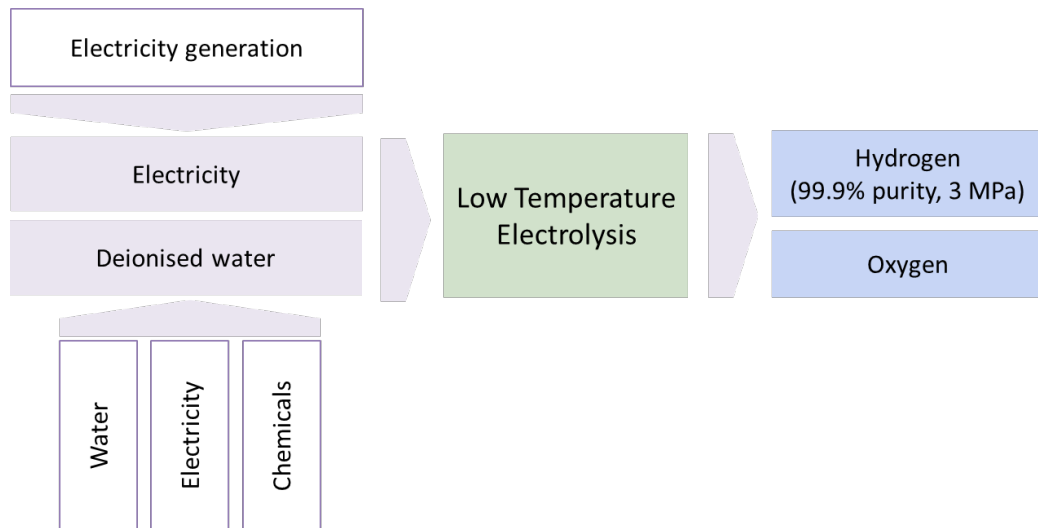

Figure 5: Illustrative process flow diagram for low temperature electrolysis

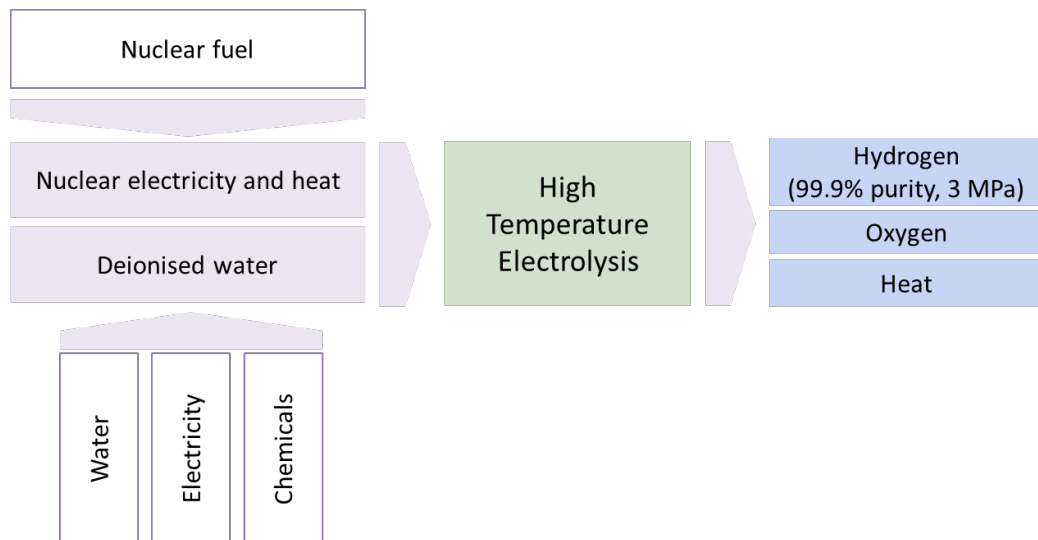

Figure 6: Illustrative process flow diagram for high-temperature electrolysis with nuclear electricity and heat

Fossil gas reforming with CCS

- A. 6. There are currently three main technologies considered within this Pathway – steam methane reformation (SMR), auto thermal reformation (ATR) and partial oxidation (POX), that use fossil gases such as natural gas as their feedstock. A simplified main block flow diagram for these three illustrative technologies is shown in Figure 7. Note that Inputs and Outputs may vary – for example, different electricity sources. The Steps associated with the original Input feedstock have been simplified, and will depend on the feedstock and its material classification.

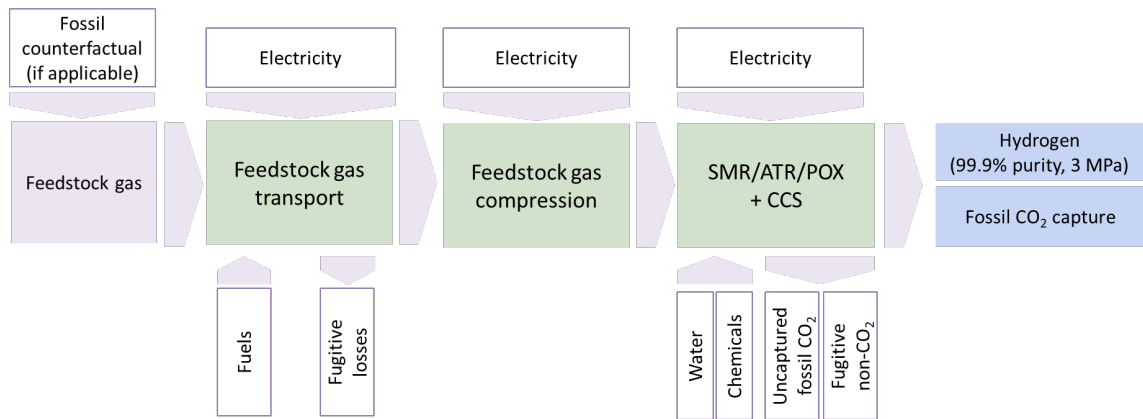

Figure 7: Illustrative process flow diagram for fossil gas reforming with CCS

SMR with CCS process description

- A. 7. A steam methane reformer (SMR) is a commercially mature production process in which a heat source provides high-temperature heat and steam for the endothermic reforming reaction to take place. This process produces hydrogen and CO₂ from the Input fossil Feedstock Gas using a catalyst. External heat sources may be required, but oxygen is not an input. CO₂ will be generated from different parts of the process at varying concentrations, and will require capture, drying and compression.

ATR with CCS process description

- A. 8. In autothermal reforming (ATR), some of the Input fossil Feedstock Gas is first partially combusted by oxygen to produce heat to drive the reforming process. Contrary to SMR, the autothermal reactor does not require any heat from an external furnace (although other minor external heating operations may still be required, such as pre-heaters). The only major CO₂ source is within the hydrogen stream, and this CO₂ can be separated out at high capture rates, dried and compressed. Oxygen is separated in an air separation unit (ASU), typically using cryogenic methods.

POX with CCS process description

- A. 9. In partial oxidation (POX), all the Input fossil Feedstock Gas is first partially oxidised by oxygen to produce hydrogen and carbon monoxide, prior to a water gas shift reaction to generate hydrogen and CO₂, with CO₂ capture, drying and compression then occurring. As with ATR, POX typically requires oxygen for the partial oxidation step, generated in an ASU.

Biogenic gas reforming

- A. 10. These Pathways uses the same technologies as the fossil gas reforming with CCS Pathway, but the Feedstock Gas is biogenic instead. The use of CCS may or may not be necessary to meet the GHG Emission Intensity Threshold.
- A. 11. Biomethane is the main input biogenic gas considered here. The production of biomethane, or another input biogenic gas, occurs prior to reforming and forms part of the Pathway. This may involve biogenic feedstock cultivation, harvesting/collection, pre-treatment, transport, bio-digestion (such as anaerobic digestion) and biogenic gas pre-treatment (such as upgrading to biomethane).
- A. 12. A simplified flow diagram is shown in Figure 8 below for an illustrative biogenic gas reforming pathway. This provides information on the primary Inputs used and the resulting primary Outputs. Note that Inputs and Outputs may vary – for example, different feedstocks and/or a different biogenic gas may be used, and CCS may not be used.

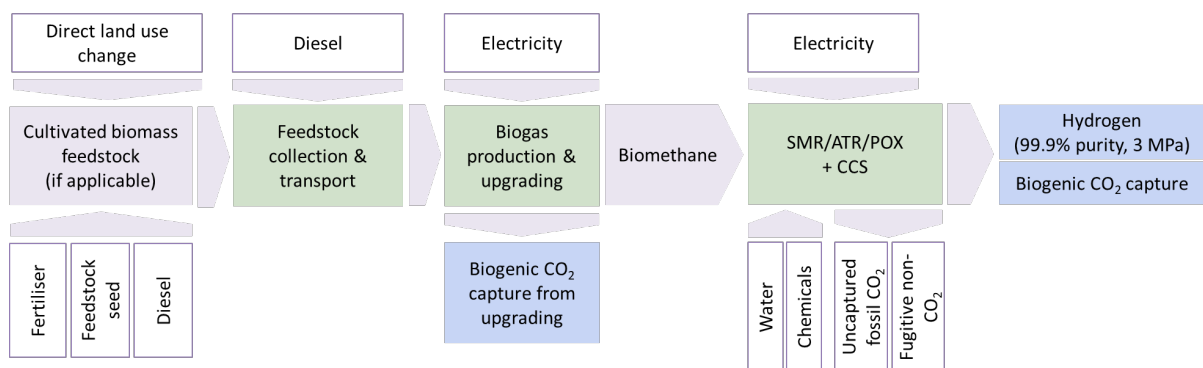

Figure 8: Illustrative process flow diagram for biomethane reforming with CCS

Biomass gasification

- A. 13. Biomass gasification broadly refers to technologies which use heat and the presence of limited or no oxygen to break down biomass feedstocks into syngas (a mixture of hydrogen, carbon monoxide and other hydrocarbons). It may involve feedstock pre-treatment, gasification, some combustion of feedstocks or side streams for process heating or reforming of side streams, followed by a high-temperature water gas shift reaction to convert syngas into hydrogen and CO₂.
- A. 14. CCS may or may not be integrated into this Pathway. Similar CCS technologies to the CCS technologies used in fossil gas reforming Pathways are likely to be used for this Pathway. Depending on the Facility scale and gasification process, CO₂ may be captured by different methods such as chemical solvents, physical solvents and pressure swing adsorption.

- A. 15. A simplified flow diagram is shown in Figure 9 below for an illustrative biomass gasification Pathway. Note that Inputs and Outputs may vary – for example, there may be variation in feedstocks and the exact gasification technology used, and CCS may not be used.

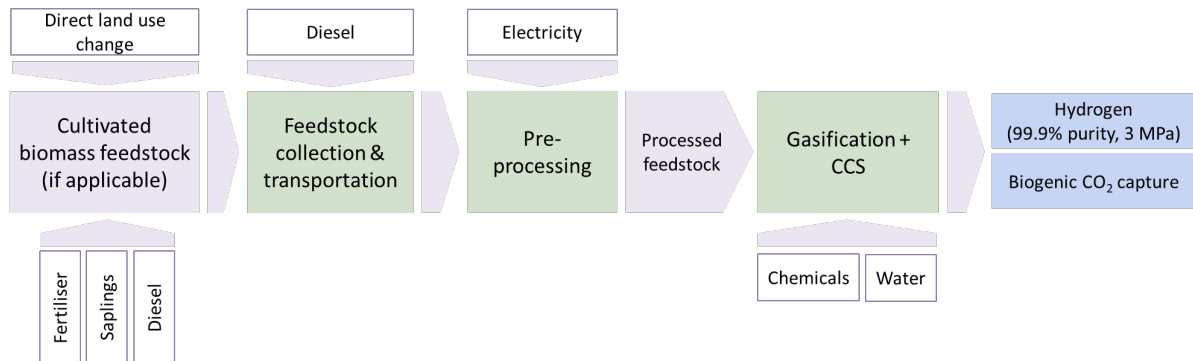

Figure 9: Illustrative process flow diagram for biomass gasification with CCS

Waste gasification

- A. 16. This Pathway broadly uses the same technologies as the biomass gasification Pathway. However, the input feedstock is classified as a Waste, and may be biogenic, fossil or mixed.
- A. 17. A simplified flow diagram is shown in Figure 10 below for an illustrative mixed waste gasification Pathway. Note that Inputs and Outputs may vary – for example, there may be variation in feedstocks and/or exact gasification technology used, and CCS may not be used.

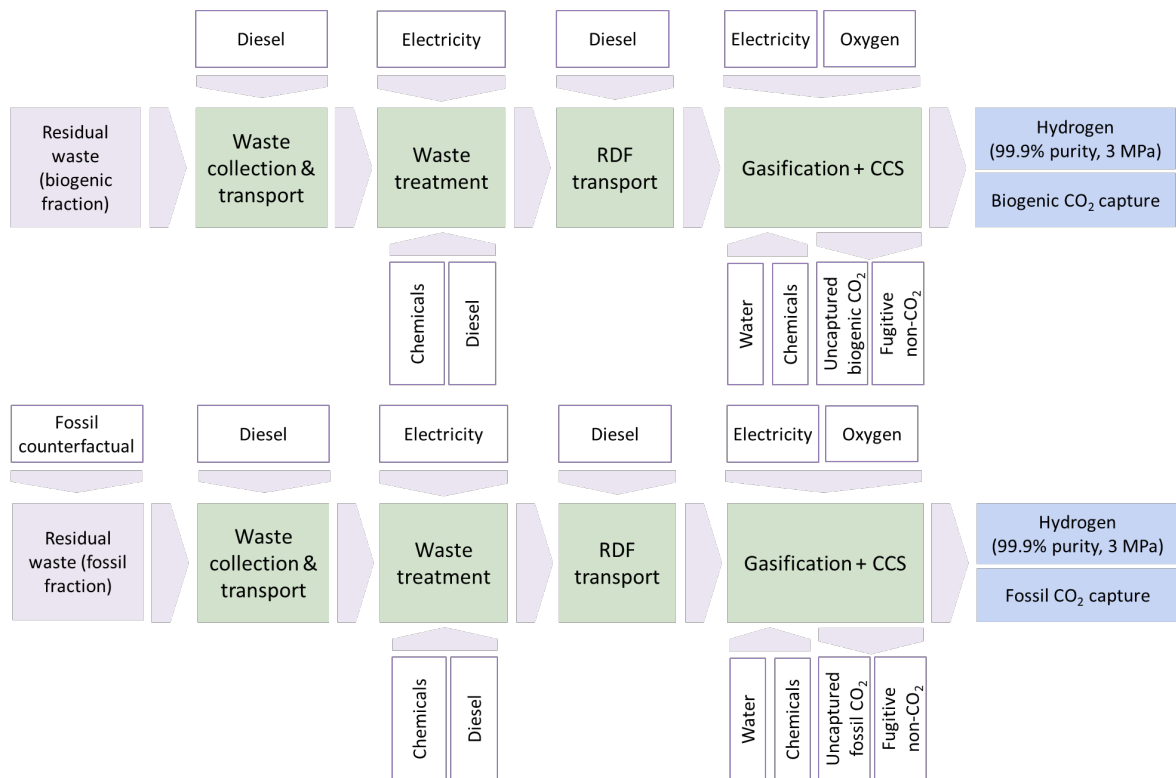

Figure 10: Illustrative process flow diagrams for mixed waste gasification with CCS (top row biogenic fraction, bottom row fossil fraction)

Gas splitting producing Solid Carbon

- A. 18. These Pathways include novel technologies, such as thermal pyrolysis, catalytic pyrolysis, plasma pyrolysis or plasma splitting, to split Feedstock Gases into primarily hydrogen and Solid Carbon.
- A. 19. The main feedstocks currently proposed are fossil natural gas, biomethane, and various other gaseous industrial Wastes or Residues. Liquid feedstocks are also permitted if they are converted to a gas or plasma during the process.
- A. 20. Depending on the technology and process conditions, the Solid Carbon produced from gas splitting can potentially take several forms, including powdered carbon black, graphite or graphene. Eligible uses of Solid Carbon are given in the Data Annex Paragraph DA.54.
- A. 21. If fossil fuels are combusted to provide onsite heating (as can occur for thermal pyrolysis and catalytic pyrolysis), there may be a CO₂ Sequestration credit if CO₂ capture is used (in addition to any Solid Carbon Sequestration credit).
- A. 22. A simplified flow diagram for an illustrative gas splitting Pathway is shown in Figure 11. Note that Inputs and Outputs may vary – for example, gas transport and compression may not be required, depending on relative locations and technology

requirements. The Steps associated with the original Input feedstock have been simplified, and will depend on the feedstock and its material classification.

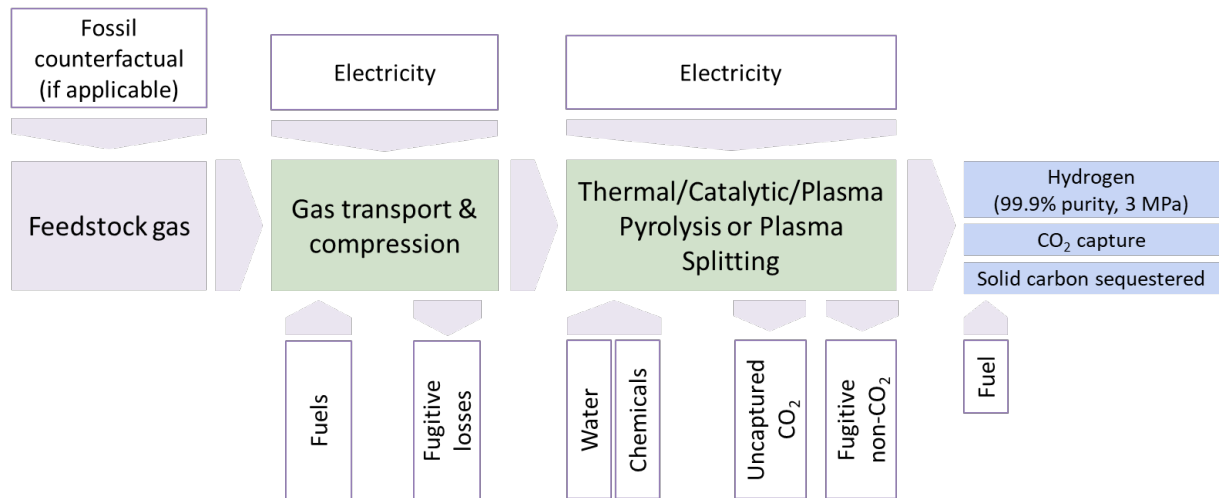

Figure 11: Illustrative process flow diagram for gas splitting with Solid Carbon

Thermal pyrolysis process description

- A. 23. Thermal pyrolysis uses an external heat source (either electrical resistive heating or combustion of a significant side stream of the Input feedstock) to provide very high temperatures inside, typically, a moving bed or molten metal reactor in the absence of any air. The temperature is sufficient to split the methane and other gaseous hydrocarbons into their component atoms of hydrogen and carbon. The Solid Carbon either precipitates out or floats on the liquid metal and is collected, and the gaseous hydrogen stream is purified.

Catalytic pyrolysis process description

- A. 24. Catalytic pyrolysis uses an external heat source (either electrical resistive heating or combustion of a significant side stream of the input feedstock) to provide high temperatures inside the reactor in the absence of any air. A metal-based catalyst is typically used to assist in splitting the methane and other gaseous hydrocarbons into their component atoms of hydrogen and carbon. The carbon precipitates out and is collected, and the gaseous hydrogen stream is purified.

Plasma pyrolysis process description

- A. 25. Plasma pyrolysis uses an Input electricity source to drive plasma torches that operate at localised high to very high temperatures, in the absence of any air. The plasma generated is responsible for transferring heat into the feedstock, splitting the methane and other gaseous hydrocarbons into their component atoms of hydrogen and carbon. Catalysts may also be used to lower reaction temperatures. The Solid

Carbon precipitates out and is collected, and the gaseous hydrogen stream is purified.

Plasma splitting process description

- A. 26. Plasma splitting uses an Input electricity source to drive plasma torches or generate microwaves to create localised extremely high temperatures, in the absence of any air. A strong electrical current or microwaves act directly on the feedstock to generate a plasma, splitting the methane and other gaseous hydrocarbons into their component ions of hydrogen and carbon. Upon cooling of the plasma, the carbon precipitates out and is collected, and the gaseous hydrogen stream is purified. Typically, no catalyst is used, and residual heat is generated as a result of the process rather than being required as an Input (as in the pyrolysis options above).

Annex B: Electricity Supply

Overview

- B. 1. Electricity consumption by Hydrogen Production Facilities is likely to be a significant contributor to the GHG emissions of the hydrogen produced. Hydrogen Production Facilities shall evidence the GHG emissions associated with all electricity Inputs used in hydrogen production. Hydrogen Production Facilities shall comply with the evidence requirements set out in this Annex, and where relevant, the evidence requirements for electricity transited via an Electricity Storage System as set out in Annex C.
- B. 2. This Annex defines the permissible electricity supply configurations; the GHG Emission Intensities associated with Input electricity for each Reporting Unit; how to account for any Transmission and Distribution Losses in the volume and GHG Emission Intensity of the electricity sourced; requirements to cancel Renewable Energy Guarantees of Origin (if relevant); and the supporting information for wider reporting requirements that shall be provided by the Hydrogen Production Facility to demonstrate compliance with the Standard.

Electricity supply configurations: Evidence requirements for calculating the GHG Emission Intensity of electricity Inputs

- B. 3. Electricity supply configurations shall be assessed in accordance with the four configurations listed below, as set out in the Paragraph 5.29. Hydrogen Production Facilities may source electricity from any combination of these four electricity supply configurations in a Reporting Unit.
 - Electricity sourced from a specific generator in GB or NI via an Eligible PPA (or equivalent where the generator and Hydrogen Production Facility are owned by the same legal entity).
 - Electricity sourced from a Private Network in GB or NI and not linked to a specific generator, excluding grid import to the Private Network.
 - Electricity sourced from the GB or NI Electricity Grid and not linked to a specific generator.
 - Electricity Curtailment Avoidance.
- B. 4. The Hydrogen Production Facility's metered electricity consumption shall be broken down into the percentage volumes of electricity that are stated to come from each of

these configurations in each Reporting Unit (an example is given in Paragraph 7.12). These percentages are used in below.

- B. 5. To determine the GHG Emission Intensity of electricity Inputs to the Hydrogen refer to Table 3, Table 4, Table 5 and Table 6 below. A Hydrogen Production Facility shall comply with the evidence requirements applicable to one of the electricity supply configurations, as detailed in Paragraph 5.29, Table 3, Table 4, Table 5 and Table 6 respectively below.
- B. 6. For those Pathways without a feedstock, where the Input electricity generates a Discrete Consignment, failure to meet the evidence requirements of the chosen supply configuration for which the GHG Emission Intensity is being claimed (Table 3 or Table 4) shall result in that Discrete Consignment being non-compliant with the Standard.
- B. 7. For those Pathways with a feedstock, where the Input electricity does not generate a Discrete Consignment, failure to meet the evidence requirements of the chosen supply configuration for which the GHG Emission Intensity is being claimed (Table 3 or Table 4) shall result in that volume of electricity being assigned a GHG Emission Intensity of unabated oil-fired generation from Table 4 of the Data Annex, factoring in 10% T&D losses.
- B. 8. For specific generators or generators on a Private Network generating biogenic electricity, the Biomass Requirements in Annex E shall be met for the original biogenic material used for electricity generation. Failure to meet any relevant Biomass Requirements shall result in the non-compliance with the Standard or GHG emission penalty consequences as set out in Annex E. These Annex E consequences take precedence over those given above in Paragraph B.5-B.6 if there are cases where both the Biomass Requirements and Table 3 requirements are not met.
- B. 9. If the evidence requirements are not met for a particular electricity supply configuration, a Facility may choose to claim the GHG Emission Intensity of another supply configuration, provided the relevant evidence requirements of that supply configuration are met.

Electricity sourced from a specific generator via an Eligible PPA (or equivalent)

- B. 10. Electricity sourced from a specific generator may be claimed at the delivered GHG Emission Intensity from that specific generation asset per Reporting Unit, if the evidence requirements set out in Table 3 are satisfied (via an Eligible PPA or equivalent).
- B. 11. Any import of electricity from the wider grid into a specific generation asset during a Reporting Unit shall be considered separately to the electricity generated by the specific asset (and not part of the specific generator GHG Emission Intensity for that

Reporting Unit), and shall follow the evidence requirements given in Paragraph B.21 and Table 5 below. Within each Reporting Unit, the percentage of grid import compared with the specific asset generation electricity volumes shall be calculated using Equation 30 (maximum value of 100%, minimum of 0%).

Equation 30

$$\% \text{ of Grid import} = \frac{\text{Grid import to specific generator MWh}}{\text{Specific generator output MWh}}$$

- B. 12. Any import of electricity into a specific generation asset from a Private Network during a Reporting Unit shall be considered separately to the electricity generated by the specific asset (and not part of the specific generator GHG Emission Intensity for that Reporting Unit), and shall follow the evidence requirements given in Paragraph B.15-B.19 below. Within each Reporting Unit, the percentage of grid import compared with the specific asset generation electricity volumes shall be calculated using Equation 31 (maximum value of 100%, minimum of 0%):

Equation 31

$$\% \text{ of Private Network import} = \frac{\text{Private Network import to specific generator MWh}}{\text{Specific generator output MWh}}$$

Table 3: Evidence requirements for electricity sourced from a specific generator

Criteria	Evidence Required
Eligible PPA between the specific generator and the Hydrogen Production Facility	<p>A contract entered into with the Hydrogen Production Facility for the supply, physical delivery and Transfer of Title in electricity to the Hydrogen Production Facility from a specific generator, signed ahead of Gate Closure. This contract shall either be with:</p> <ul style="list-style-type: none"> • A generator of electricity (including any Electricity Storage System). • A licensed electricity supplier and a generator(s) of electricity (including any Electricity Storage System(s)). • A licensed electricity supplier, who supplies this electricity via associated arrangements with specific generators (or Electricity Storage Systems). <p>The Eligible PPA shall contain terms that:</p> <ul style="list-style-type: none"> • Provide for the physical supply of electricity to the Hydrogen Production Facility (and where relevant Electricity Storage System) either directly, via a Private Network, or via the Electricity Distribution

	<p>Network or Electricity Transmission Network, including Transmission and Distribution Losses from Paragraph B.31-B.34.</p> <ul style="list-style-type: none"> • Enable the Hydrogen Production Facility to evidence the relevant electricity supply pursuant to generator metered data, and invoices or statements, as well as the GHG Emission Intensity of the electricity volumes supplied and (where relevant) compliance with Biomass Requirements. • Enable the Hydrogen Production Facility to evidence the existence of the above terms in any associated arrangements with generators. <p>An Eligible PPA shall not be an Excluded PPA (see Chapter 2). A Hydrogen Production Facility located in GB shall only enter into an Eligible PPA with a generator located in GB (or an Eligible PPA with a supplier who has associated arrangements with generators in GB). Similarly, a Hydrogen Production Facility located in NI shall only enter into an Eligible PPA with a generator located in NI (or an Eligible PPA with a supplier who has associated arrangements with generators in NI). This is due to the complexity in evidencing temporal correlation and physical delivery of electricity where electricity flows through interconnectors. This may be reviewed in the future.</p>
Transaction evidence	<p>The Hydrogen Production Facility shall provide electricity supply and/or settlement invoices or statements broken down per Reporting Unit, showing a match between metered generation data and invoiced supply volumes per Reporting Unit.</p> <p>The Hydrogen Production Facility shall provide electricity supply and/or settlement invoices or statements broken down per Reporting Unit, showing at least a match to the Hydrogen Production Facility electricity consumption, including Transmission and Distribution Losses from Paragraph B.31-B.34, using the following equation:</p> $\sum_i \{Specific\ generator_i\ supply\ invoices\ MWh \times (1 - \% T\&D\ loss_i)\} \geq \sum_{RU\ j} \{Facility\ metered\ consumption_j\ MWh \times \% electricity\ consumed\ from\ specific\ generators_j\}$
Temporal Correlation Between	<p>Single generator: Where a Hydrogen Production Facility enters into a single contract directly (or via a supplier) with a generator or Electricity Storage System, 30 minute metering data is required to show that the contracted and delivered volumes of metered electricity generated exceeds</p>

<p>Generation and Consumption</p>	<p>or matches the Hydrogen Production Facility’s metered electricity consumption, per Reporting Unit.</p> <p>Multiple generators: Where a Hydrogen Production Facility enters into multiple contracts directly (or via suppliers) with generators or Electricity Storage Systems, 30 minute metering data is required from each generator, to show that the sum of the contracted and delivered volumes of metered electricity generation exceeds or matches the Hydrogen Production Facility’s metered electricity consumption, per Reporting Unit.</p> <p>Supplier with multiple associated generators: Where a Hydrogen Production Facility enters into a contract with a supplier who supplies this electricity via associated arrangements with specific generators or Electricity Storage Systems, 30 minute metering data is required from each generator, to show the sum of the contracted and delivered volumes of metered electricity generation exceeds or matches the Hydrogen Production Facility’s metered electricity consumption, per Reporting Unit.</p> <p>In each case above, any Transmission and Distribution Losses from Paragraph B.31-B.34 shall be included in the temporal correlation calculations, using the following equation:</p> $\sum_i \{Specific\ generator_i\ metered\ generation\ MWh \times (1 - \% T\&D\ loss_i)\} \geq Facility\ metered\ consumption\ MWh \times \% electricity\ consumed\ from\ specific\ generators$
<p>Exemption from Eligible PPA where specific generator and Hydrogen Production Facility are owned by the same legal entity</p>	<p>For a generation asset that is owned by the same legal entity as the owner of the Hydrogen Production Facility, (including, in the event where the generation asset is located on-site), an Eligible PPA is not required, but equivalent evidence shall be provided.</p> <p>In this case, metering data shall be provided to prove physical delivery and Temporal Correlation of electricity from the specific generator (as per the requirements in the row above), along with any internal transaction evidence such as invoices, statements, or internal transaction logs, as well as the GHG Emission Intensity of the electricity volumes supplied and (where relevant) compliance with Biomass Requirements. Evidence shall be provided the same legal entity (not a parent or subsidiary company) owns both the Hydrogen Production Facility and the specific generator.</p>
<p>Other</p>	<p>Provision of the generation asset name, generation type, location, installed capacity.</p>

	If requested, provision of a Single Line Diagram for any Hydrogen Production Facility, evidencing sufficient line capacity for the volumes of Eligible PPA electricity that are sourced.
--	--

- B. 13. If the evidence requirements of Table 3 are met, the electricity generation GHG Emission Intensity from Table 4 of the Data Annex shall be used, or if a generator is not listed, the methodology in Annex G shall be applied. The minimum GHG Emission Intensity of any generator shall be zero. Any Transmission and Distribution Losses between the specific generation asset and the Hydrogen Production Facility are accounted for in the GHG Emission Intensity as set out in this Annex, using Equation 32. T&D losses are calculated as per Annex B.31-B.34.

Equation 32

$$\text{Delivered electricity GHG Emission Intensity} = \frac{\text{Generated electricity GHG Emission Intensity}}{(1 - T\&D Losses)}$$

- B. 14. Electricity sourced from multiple specific generators shall be claimed at the delivered GHG Emission Intensity from each specific generation asset per Reporting Unit (with a minimum GHG Emission Intensity of zero), if the evidence requirements set out in Table 31 are satisfied. Paragraph 7.6 sets out the requirements for any grouping of electricity sources by type for the formation of Discrete Consignments.

Electricity sourced from a Private Network and not linked to a specific generator, excluding grid import to the Private Network

- B. 15. Electricity sourced from several generation assets on a Private Network can be claimed at the weighted average GHG Emission Intensity of the Private Network generators per Reporting Unit, if the evidence requirements set out in Table 4 are satisfied.
- B. 16. Any arrangement seeking to claim the GHG Emission Intensity of a specific generator on a Private Network shall meet the requirements of Paragraphs B.10-B.13. If electricity from a specific generator is claimed by a Hydrogen Production Facility, this volume of electricity shall be excluded from the Private Network weighted average GHG Emission Intensity for that Reporting Unit.
- B. 17. Any import of electricity into the Private Network from the wider grid shall be considered separately to the Private Network generation sources (and not part of the Private Network weighted average GHG Emission Intensity calculation), and shall follow the evidence requirements given in Paragraph B.19 or Paragraphs B.20-B.21. Within each Reporting Unit, the percentage of electricity volumes of grid import compared with Private Network generation shall be assumed to apply to all electricity

consumers on the Private Network within that Reporting Unit, including the Hydrogen Production Facility, using Equation 33.

Equation 33

$$\% \text{ of Grid import} = \frac{\text{Grid import MWh}}{\text{Private Network generation MWh} + \text{Grid import MWh}}$$

Table 4: Evidence requirements for electricity sourced from a Private Network and not linked to a specific generator

Criteria	Evidence Required
Electricity supply contractual arrangements	<p>A contract entered into between the Hydrogen Production Facility and a Private Network operator is required evidencing the physical delivery and Transfer of Title of electricity to the Hydrogen Production Facility from the Private Network to which the Hydrogen Production Facility is connected.</p> <p>The contract shall contain terms that provide for the physical supply of electricity, along with provision of metering data and transaction evidence such as invoices and statements broken down per Reporting Unit.</p>
Transaction evidence	<p>For all volumes of electricity consumed by the Hydrogen Production Facility claimed at the delivered weighted average GHG Emission Intensity of the Private Network, there shall be electricity supply transaction evidence provided such as invoices or statements that match or exceed the volumes of electricity consumed by the Hydrogen Production Facility per Reporting Unit. Transmission and Distribution Losses from Paragraph B.33-B.34 shall be accounted for using the following Equation.</p> $\sum \text{Private Network supply invoices MWh} \times (1 - \% \text{ Private Network T\&D losses}) \geq \text{Facility metered consumption MWh} \times \% \text{ electricity consumed from Private Network}$
Temporal Correlation Between Generation and Consumption	<p>Metering data is required from each generator on the Private Network, to show the sum of the metered data of the electricity generators on the Private Network exceeds or matches the Hydrogen Production Facility's metered data for electricity consumed from the Private Network, per Reporting Unit.</p>

	<p>Metering data is also required for any grid import onto the Private Network, to determine the share of grid imported electricity that is consumed by the Hydrogen Production Facility, as per Equation 33.</p> <p>Transmission and Distribution Losses from Paragraph B.33-B.34 shall be accounted for using the following Equation.</p> $\sum \text{Private Network metered generation MWh} \times (1 - \% \text{ Private Network T\&D losses}) \geq \text{Facility metered consumption MWh} \times \% \text{ electricity consumed from Private Network}$
Other	<p>Provision of the generator asset names, generation types, locations, installed capacities within the Private Network.</p> <p>If requested, a Single Line Diagram for the Private Network, including showing the connections to the Hydrogen Production Facility, evidencing sufficient line capacity for the volumes of Private Network generated electricity claimed.</p>

- B. 18. If the evidence requirements of Table 4 are met, the GHG Emission Intensity of each electricity generation source on the Private Network shall be determined using the GHG Emission Intensities from Table 4 of the Data Annex, or if a generator is not listed, the methodology in Annex G shall be applied. For certain electricity generators on a Private Network, there are requirements that shall apply instead:
- For a generator on a Private Network that uses hydrogen as a fuel source to generate electricity, then unabated fossil natural gas (combined upstream and combustion values from Data Annex Table 9 and Table 11) shall be used as the GHG Emission Intensity for the hydrogen consumed by the generation asset, before the rest of the methodology in Annex G is applied.
 - For a generator on a Private Network that uses fossil natural gas with CCS to generate electricity, then the GHG Emission Intensity of this generation shall ignore any credit for captured CO₂.
- B. 19. The minimum GHG Emission Intensity of any generator shall be zero. Metering data is then required to show the electricity generated from each generation asset on the Private Network, and evidence of the exclusion of any electricity volumes that are subject to an Eligible PPA (or equivalent), to evidence the weighted average Private Network electricity generation GHG Emission Intensity calculation.

- B. 20. Any Transmission and Distribution Losses between the Private Network generators and the Hydrogen Production Facility shall be accounted for in the delivered GHG Emission Intensity using Equation 34. The Private Network T&D losses are calculated as per Annex B.31-B.34.

Equation 34

$$\text{Delivered electricity GHG Emission Intensity} = \frac{\text{Weighted average GHG Emission Intensity of Private Network generation}}{(1 - \% \text{ Private Network T\&D Losses})}$$

Electricity sourced from the Electricity Grid and not linked to a specific generator

- B. 21. Electricity sourced from grid import not linked to any specific generator may be claimed at the GHG Emission Intensity of the applicable GB or NI Electricity Grid average per Reporting Unit (see the Data Annex Paragraphs DA.25-28 for evidence sources) depending on the location of the Hydrogen Production Facility, if the evidence requirements set out in Table 5 are satisfied.

Table 5: Evidence requirements for electricity sourced from grid import and not linked to a specific generator

Criteria	Evidence Needed
Electricity supply contractual arrangements	<p>Contract entered into between a licenced supplier and the Hydrogen Production Facility.</p> <p>The contract shall contain terms that provide for transaction evidence such as invoices and statements.</p>
Transaction evidence	<p>For all volumes consumed by the Hydrogen Production Facility claimed at the GHG Emission Intensity of the applicable GB or NI Electricity Grid average, the Hydrogen Production Facility shall provide electricity supply transaction evidence such as invoices or statements that match the consumption meter data each Reporting Unit.</p> $\sum \text{Grid import supply invoices MWh} \geq \text{Facility metered consumption MWh} \times \% \text{ electricity consumed from Grid import}$

Metering	The Hydrogen Production Facility shall provide their metered electricity consumption data per Reporting Unit, and the % that is stated to be sourced from grid import.
Other	If requested, provision of a Single Line Diagram for the Hydrogen Production Facility's grid connection, evidencing sufficient line capacity for the volumes of grid import electricity claimed. Where this grid connection is part of or via a Private Network, details of any generators (generator asset names, generation types, locations, installed capacities) on the Private Network.

Electricity Curtailment Avoidance

- B. 22. Electricity consumption by a Hydrogen Production Facility may reduce the need for electricity generators elsewhere on the Electricity Grid to curtail their Output.
- B. 23. Electricity may be determined as Electricity Curtailment Avoidance for the Reporting Unit and claimed either at the Regional GHG Emission Intensity figure (if such data is available), or at the GB or NI Electricity Grid GHG Emission Intensity, based on the Hydrogen Production Facility's location, if the evidence requirements set out in Table 6 are satisfied.

Table 6: Requirements to evidence Electricity Curtailment Avoidance

Criteria	Evidence Needed
Proof of electricity consumed via a Bid Offer Acceptance in the Balancing Mechanism / Balancing Market	<p>Hydrogen Production Facility registered in a Primary Balancing Mechanism Unit (BMU) in GB:</p> <ul style="list-style-type: none"> Metered electricity consumption data for the corresponding period of the Bid Offer Acceptance recorded by the Hydrogen Production Facility's electricity meter. Bid Offer Acceptances issued by the GB System Operator. <p>Hydrogen Production Facility registered in a Secondary Balancing Mechanism Unit (i.e. by a Virtual Lead Party) in GB:</p> <ul style="list-style-type: none"> Metered electricity consumption data for the corresponding period of the Bid Offer Acceptance recorded by Settlement Meter registered by the Virtual Lead Party in its Secondary BMU.

	<ul style="list-style-type: none"> • Bid Offer Acceptances issued by the GB System Operator in respect of the Secondary BMU that the Facility is registered in. <p>Hydrogen Production Facility registered in a Balancing Market Unit (BMU) in NI:</p> <ul style="list-style-type: none"> • Metered electricity consumption data for the corresponding period of the Bid Offer Acceptance recorded by the Hydrogen Production Facility's electricity meter. • Bid Offer Acceptances issued by the Irish System Operator. <p>For each case above, the following transaction evidence shall be provided in each Reporting Unit:</p> $\sum Bid\ Offer\ Acceptances\ MWh \geq Facility\ metered\ consumption\ MWh \times \% \text{ electricity consumed from Curtailment Avoidance}$
Other	<p>If a regional GHG Emission Intensity is being used for Bid Offer Acceptance volumes, evidence for the location of the BMU in which the Hydrogen Production Facility is located, and therefore which Distribution Network Operator licenced area applies.</p> <p>If a GB or NI Electricity Grid GHG Emission Intensity is being claimed for the Bid Offer Acceptance volumes, evidence of the location of the Hydrogen Production Facility.</p> <p>If requested, provision of a Single Line Diagram for the Hydrogen Production Facility's grid connection, evidencing sufficient line capacity for the volumes of Electricity Curtailment Avoidance claimed.</p>

B. 24. The Regional GHG Emission Intensity shall be determined using the GHG Emission Intensity for the Distribution Network Operator licenced area corresponding to the location of the Hydrogen Production Facility. Northern Ireland shall be treated as a region for the purpose of determining Regional GHG Emission Intensity, and the NI grid average GHG Emission Intensity shall be used. The Data Annex Paragraphs DA.29-DA.32 provide the relevant data sources that shall be used to determine the Regional GHG Emission Intensity.

Cancellation of Renewable Energy Guarantees of Origin (REGOs)

- B. 25. For each REGO Year, Hydrogen Production Facilities shall procure and cancel REGOs in accordance with the requirements set out below to cover their REGO registered electricity use for hydrogen production. It is important that REGOs shall be cancelled to ensure there is no double counting via Fuel Mix Disclosure of the low carbon attributes of the electricity supplied to Hydrogen Production Facilities by any other electricity system user. REGO cancellation shall be an annual reporting requirement to align with the auditing requirements of the primary use of REGOs by licensed electricity suppliers for Fuel Mix Disclosure¹⁵, however we would encourage Hydrogen Production Facilities to cancel REGOs more frequently.
- B. 26. Hydrogen Production Facilities shall cancel at least the same number of REGOs as the volume of REGO registered electricity generated that is used in hydrogen production during the REGO Year, which includes any relevant Transmission and Distribution losses. The total number of REGOs to cancel shall be rounded up at the end of the REGO Year to a whole integer number. There is no requirement for 'bundling'¹⁶ of REGOs with any purchase of electricity.
- B. 27. The amount of REGOs that shall be cancelled will depend on the electricity input source used by the Hydrogen Production Facility:
- For any electricity input being claimed at the GHG Emission Intensity of a specific generation asset registered within the REGO scheme, the number of REGOs to be cancelled are calculated using the generator REGO Percentage from the Data Annex Paragraph DA.24 and Equation 35 for each Reporting Unit, before summing over all the Reporting Units within the REGO Year.

Equation 35

REGOs to be cancelled per Reporting Unit

$$\begin{aligned} &\geq \text{Facility metered consumption MWh} \\ &\times \text{Share of electricity consumption from the specific generator} \\ &\times \text{Specific generator \% share of REGO registered generation} \div (1 \\ &\quad - \% \text{ T\&D losses}) \end{aligned}$$

- Where the Hydrogen Production Facility wishes to claim their electricity is supplied from an Electricity Storage System via an Eligible PPA (or

¹⁵ The Fuel Mix Disclosure period currently runs 1st April to 31st March, with a requirement for REGOs to be registered, traded and/or cancelled by noon 1st July following the generation disclosure period, at which point all REGOs on the register are redeemed by Ofgem.

¹⁶ REGO 'bundling' refers to an optional contractual arrangement whereby alongside the sale of electricity volumes from a specific generator, the corresponding REGOs for this volume of electricity are issued and transferred to the purchaser of this electricity (i.e. both REGOs and electricity are purchased from the same generation asset).

equivalent), the REGO cancellation requirements are given in Annex C.27-C.31.

- Where the Hydrogen Production Facility wishes to claim their electricity is supplied from a specific generator via an Eligible PPA (or equivalent), but the generation asset is not eligible to be registered within the REGO scheme (e.g. a nuclear power plant), REGO cancellation is not required for this generator.
- For electricity consumed by the Hydrogen Production Facility from a Private Network and not linked to a specific generator, the number of REGOs to be cancelled are calculated for each Reporting Unit following the same approach as in Equation 35 (but with 'specific generator' substituted by 'Private Network generators'). Any Electricity Grid imports via the Private Network, or Private Network generator electricity volumes subject to an Eligible PPA (or equivalent) are to be treated separately.
- For grid import electricity consumed by the Hydrogen Production Facility from the Transmission Network or Distribution Network and not linked to a specific generator, the REGO cancellation requirement is calculated based on the grid import electricity consumed multiplied by the REGO Percentage given in the Data Annex Paragraph DA.27.
- For Electricity Curtailment Avoidance, the REGO cancellation requirement is calculated based on the Electricity Curtailment Avoidance electricity consumed multiplied by the REGO Percentage given in the Data Annex Paragraph DA.33.

B. 28. Hydrogen Production Facilities shall create accounts within the Ofgem administered 'Renewables and CHP Register' to become account holders. These account applications will be verified by Ofgem, with evidence provided that the Hydrogen Production Facility is an approved account holder at the time of REGO registration and cancellation.

B. 29. On an annual basis, by a deadline set by the Delivery Partner, the Hydrogen Production Facility shall provide evidence from the 'Renewables and CHP Register' that appropriate volumes of REGOs have been procured and cancelled. Once cancelled, REGOs shall not be traded or used for any other purpose.

B. 30. If a Hydrogen Production Facility fails to provide evidence they have cancelled the required number of REGOs by the deadline, then:

- For those Pathways without a feedstock, where the Input electricity generates a Discrete Consignment, the volumes of REGO registered electricity for which REGOs have failed to be cancelled will result in the corresponding number of Discrete Consignments being non-compliant with the Standard (using the Hydrogen Production Facility efficiency from electricity to Hydrogen Product).

The Facility may choose which Discrete Consignments from the year are deemed to have correctly cancelled REGOs and which have not, provided the annual total shortfall in REGOs is correct.

- For those Pathways with a feedstock, where the Input electricity does not generate a Discrete Consignment, the volumes of REGO registered electricity for which a REGO has failed to be cancelled will result in recalculation of the GHG Emission Intensity of all Discrete Consignments that used this electricity. This recalculation shall use unabated oil-fired generation from Table 4 of the Data Annex, factoring in 10% T&D losses. This may result in multiple Discrete Consignments and/or Weighted Average Consignments across the year exceeding the GHG Emission Intensity Threshold.

Transmission and Distribution Losses for Specific Generators and Private Networks

- B. 31. This section sets out how Transmission and Distribution (T&D) Losses are to be calculated. T&D Losses impact the volume of generation to be evidenced by a specific generator or by a Private Network not linked to a specific generator, the GHG Emission Intensity of delivered electricity from these sources, and number of REGOs to be cancelled.
- B. 32. Electricity sourced from GB or NI Electricity Grid or Electricity Curtailment Avoidance, in both cases not linked to a specific generator, already have T&D losses included in their GHG Emission Intensity values, so no further instructions are required.
- B. 33. The T&D Losses on a Private Network shall be calculated as a weighted average of specific generators on the Private Network.
- B. 34. Where evidence and a calculation of T&D Losses is not provided, Hydrogen Production Facilities shall use a value of 10%.

Example: A Hydrogen Production Facility in GB sourcing electricity from a nuclear electricity generator fails to provide Transmission and Distribution losses for a Reporting Unit.

- The GHG Emission Intensity of nuclear electricity generation = 3.9 gCO_{2e}/MJ_e

The correct delivered GHG Emission Intensity to apply in case of failure to report T&D losses is then $3.9 / (1 - 10\%) = 4.3$ gCO_{2e}/MJ_e.

Electricity sourced from specific generators that are connected to the GB / NI Electricity Grid via an Eligible PPA (or Equivalent)

- B. 35. Figure 12 below shows the metering arrangements for a grid-connected specific generator where meters 1 and 2 represent the generator asset and Hydrogen Production Facility electricity meters respectively. These meters shall record the volume of electricity generated and consumed, respectively.

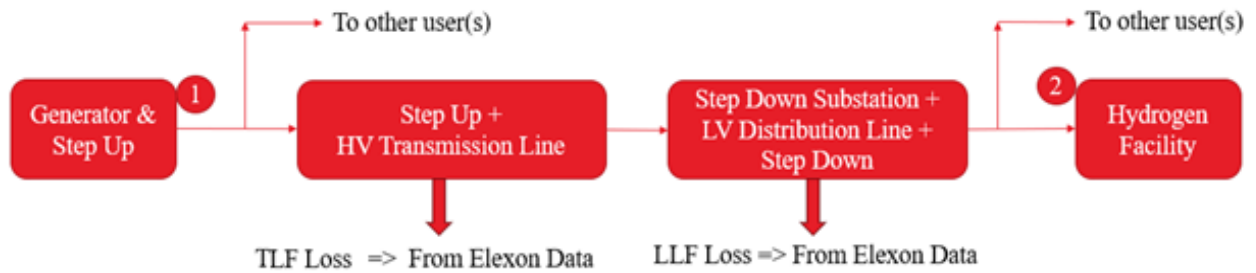

Figure 12: Losses and meters for a Hydrogen Production Facility consuming electricity from a grid-connected specific generator

- B. 36. The T&D Loss Factor for Hydrogen Production Facilities consuming electricity from specific generators through the GB Electricity Grid shall be calculated using Equation 36. Transmission Loss Factors (TLF) for Transmission Losses and Line Loss Factors (LLFs) for Distribution Losses in accordance with Equation 36. Further data sourcing details are provided in the Data Annex Paragraph DA.37.

Equation 36

$$GB\ T\&D\ Loss\ Factor = 1 - ((1 - TLF) \times (2 - LLF))$$

- B. 37. The T&D Loss Factor for Hydrogen Production Facilities consuming electricity from specific generators through the NI Electricity Grid shall be calculated using Transmission Loss Adjustment Factors (TLAFs) for Transmission Losses and Distribution Loss Adjustment Factors (DLAFs) for distribution losses in Equation 37. Further data sourcing details are provided in the Data Annex Paragraph DA.38.

Equation 37

$$NI\ T\&D\ Loss\ Factor = 1 - ((1 - TLAF) \times (1 - DLAF))$$

Example: An Electrolytic Hydrogen Production Facility in Great Britain consumed 18,000 MJ_e of electricity in Reporting Unit where the TLF of 0.03 and LLF of 1.05.

- Transmission and Distribution Losses = $1 - ((1 - 0.03) * (1 - (1.05 - 1))) = 0.0785$
- The minimum volume of generated electricity required = $18,000 / (1 - 0.075) = 19,533\ MJ_e$

Electricity sourced from a specific generator via a Private Network

- B. 38. For a Hydrogen Production Facility that sources electricity from a specific generator via a Private Network, the Hydrogen Production Facility shall calculate and report T&D losses for that specific generator and support these calculations with evidence, for example, network wire resistivity, network wire length and any equipment losses.

Electricity sourced from a Private Network and not linked to a specific generator

- B. 39. Where a Hydrogen Production Facility uses electricity sourced from a Private Network and not linked to a specific generator, where the Private Network only supplies the Hydrogen Production Facility and does not supply other users, the T&D Losses shall be determined using Equation 38. T&D Losses shall be determined by adding metered volumes of electricity generated for all generators on a Private Network and subtracting the volume of electricity consumed by the Hydrogen Production Facility.

Equation 38

$$T\&D\ Loss\ Factor = \frac{\sum Generation\ Meters - Hydrogen\ Production\ Facility\ Meter}{\sum Generation\ Meters}$$

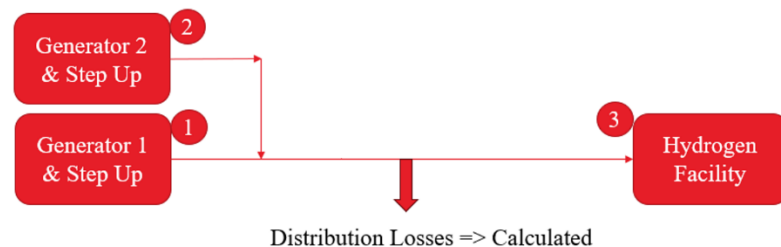

Figure 13: Meters for a specific generator or from several generators on a Private Network connecting only to the Hydrogen Production Facility

- B. 40. For electricity sourced from Private Network and not linked to a specific generator if this Private Network supplies several users including the Hydrogen Production Facility, then the sum of last year's metered generation across the Private Network and an annual statement evidencing last year's total electricity consumption across the Private Network shall be provided. The T&D Losses are then determined using Equation 39.

Equation 39

$$T\&D\ Loss\ Factor = \frac{\sum Generation\ Meters - Total\ Private\ Network\ Electricity\ Consumption}{\sum Generation\ Meters}$$

Annex C: Stored Electricity Supply

Overview

- C.1. Hydrogen Production Facilities may consume electricity that has been stored within an Electricity Storage System located in the UK. For Pathways without a feedstock, this transited electricity via an Electricity Storage System will form its own Discrete Consignment when generating hydrogen (see Chapter 7).
- C.2. An Electricity Storage System is a rechargeable technology, and any non-rechargeable technologies are not within scope of the Standard. Electricity Storage Systems may store the electricity in different energy forms between charging and discharging. Other systems that do not input/output electricity, for example, thermal energy stores that input/output heat, are out of scope. The requirements set out in this Annex shall not apply to backup power systems including UPS (uninterruptable power supply) and capacitors within the Hydrogen Production Facility, as any electricity used for these units fall under the Energy Supply Emission Category (Chapter 5.25-5.33).
- C.3. An Electricity Storage System being charged shall follow the same Annex B rules as a Hydrogen Production Facility. When charging, Electricity Storage Systems may consume electricity from any combination of the four permitted electricity supply configurations in Annex B.3.
- C.4. A Hydrogen Production Facility sourcing electricity from an Electricity Storage System shall follow the same rules as for a specific generator of electricity via an Eligible PPA Annex B.10-B.14 (or equivalent). A Hydrogen Production Facility may consume electricity from multiple Electricity Storage Systems.
- C.5. This Annex details the methodology to calculate the Stored GHG Emission Intensity and Stored REGO Percentage for the electricity that is stored within and discharged by the Electricity Storage System every Reporting Unit including evidence requirements. Electricity Storage Systems shall be permitted to charge and/or discharge as frequently as desired within each Reporting Unit without any restrictions. The 'charge first' assumption set out in Paragraphs Annex C.20-C.21 below is used for accounting purposes only and is not a restriction on real-world Electricity Storage System operations.

Evidence required from each Electricity Storage System

- C.6. In addition to the Electricity Storage System fulfilling the evidence requirements given in Annex B.10-B.14 for a specific generator (or alternatively Annex B Paragraphs B.15 -B.20 if the Electricity Storage System is part of a Private Network),

a Hydrogen Production Facility consuming discharged electricity from an Electricity Storage System shall also provide the following evidence each month:

- The Stored GHG Emission Intensity (see Annex C.15-C.21) and Stored REGO Percentage (see Annex C.22-C.26), for each Reporting Unit.
- The percentage SoC (State of Charge, given as kWh_e stored/kWh_e stored at full charge) of the Electricity Storage System at the end of each Reporting Unit.
- The percentage mix of electricity sources used to charge the Electricity Storage System for each Reporting Unit.
- The GHG Emission Intensity and REGO Percentage (see the Data Annex Paragraphs DA.21-DA.24) for the electricity sources used to charge the Electricity Storage System, per Reporting Unit, accounting for any Upstream T&D Losses between the electricity sources and the Electricity Storage System (see Annex B Paragraphs B.31-B.40 but with the role of the Hydrogen Production Facility replaced by the Electricity Storage System).
- The Electricity Storage System itself meets the full requirements of Annex B Table 3, Table 4, Table 5 and/or Table 6 for the respective electricity supplies used to charge the Electricity Storage System in each Reporting Unit, whereby the references to 'Hydrogen Production Facility' (or equivalent) shall instead apply to 'Electricity Storage System'. This includes accounting for any Transmission and Distribution losses between the electricity sources and the Electricity Storage System in any contracted volumes, invoices and metering data for Temporal Correlation.

C.7. The following Electricity Storage System specifications and data shall be recorded annually:

- The type of Electricity Storage System, including the battery chemistry if the Electricity Storage System is an electrochemical battery;
- The percentage SoH (State of Health) or equivalent;
- The Ideal Capacity;
- The Self Discharge Loss (see Paragraphs C.11-C.12 for more details);
- The Round Trip Efficiency (see Paragraphs C.13-C.14 for more details).

C.8. If the mix of electricity sources used to charge an Electricity Storage System cannot be evidenced for a Reporting Unit, the highest GHG Emission Intensity value among the relevant electricity sources used for charging shall be used for the entire amount of electricity used to charge in that Reporting Unit.

-
- C.9. If the mix of input electricity sources used to charge an Electricity Storage System cannot be evidenced for a Reporting Unit, the highest of the REGO Percentages of the relevant electricity sources (given in the Data Annex Paragraphs DA.24, DA.27 and DA.33) shall be used for the entire amount of electricity used to charge in that Reporting Unit.

Self Discharge Loss evidence

- C.10. Self Discharge Losses can occur due to various mechanisms, for example, internal chemical reactions, heat dissipation, storage material leakage. The rate of Self Discharge Loss varies significantly between storage technologies but is also influenced by the SoC and environmental conditions.
- C.11. The Self Discharge Loss value (% loss per 30 minutes) for a particular Electricity Storage System shall be evidenced by the provision of either:
- The contractual performance guarantees from the Electricity Storage System equipment manufacturer or technology provider, provided these guarantees state the maximum permissible Self Discharge Loss value over a given time period, and the guarantees cover all applicable components and loads within the Electricity Storage System; or
 - System monitoring data over a period of at least one year of Electricity Storage System operations, showing the long-term background average rate of loss of SoC once charging, discharging and RTE losses are backed out of these SoC calculations, or alternatively, the weighted average rate of loss of SoC calculated from all periods in which no charging or discharging occurs.
- C.12. If this Self Discharge Loss evidence is not provided, then for those Electricity Storage System technologies listed in Table 6 of the Data Annex, conservative 30-minute Self Discharge Loss values from Table 6 of the Data Annex shall be used instead. If the Self Discharge Loss evidence is not provided and the Electricity Storage System technology is not listed in Table 6 of the Data Annex, a 10% Self Discharge Loss per 30 minutes shall be assumed.

Round Trip Efficiency evidence

- C.13. The Round Trip Efficiency value (%) for a particular Electricity Storage System shall be evidenced by the provision of one of:
- The contractual performance guarantees from the Electricity Storage System equipment manufacturer or technology provider, provided these guarantees state (or chart) the minimum permissible Round Trip Efficiency value for the given year of operations, and the guarantees cover all applicable components and loads within the Electricity Storage System; or

- Verified RTE data from the GB/NI Electricity Grid System Operator during any initial grid connection or annual capacity market mandatory testing procedures. If the Electricity Storage System is located in GB and participates in the Balancing Mechanism, the most recent verified RTE test value shall be provided if choosing to rely on Electricity Grid System Operator verified data; or
- Electricity Storage System import and export electricity meter data over a period of at least one month of Electricity Storage System operations, along with the SoC, Ideal Capacity and SoH data from this period. The RTE is then calculated using Equation 40, Equation 41 and Equation 42.

Equation 40

$$\text{Change in storage} = \text{Ideal Capacity} \times \text{SoH} \times (\text{SoC}_{\text{final}} - \text{SoC}_{\text{initial}})$$

Equation 41

$$\text{Losses} = \text{Gross Import} - \text{Gross Export} - \text{Change in storage}$$

Equation 42

$$\text{Round Trip Efficiency} = 1 - \frac{\text{Losses}}{\text{Gross Import}}$$

Where:

- Gross Import (kWh_e) = total gross charging of the Electricity Storage System occurring during the Reporting Unit.
- Gross Export (kWh_e) = total gross discharging of the Electricity Storage System occurring during the Reporting Unit.
- Other terms are as defined in Chapter 2 and elsewhere in this Annex C.

C.14. If an Electricity Storage System does not evidence their own RTE value, then for those Electricity Storage System technologies listed in Table 7 of the Data Annex, RTE values from Table 7 of the Data Annex shall be used instead. If RTE evidence is not provided and the Electricity Storage System technology is an electrochemical battery not listed in Table 7 of the Data Annex, the lead-acid battery value in the Data Annex may be used. If RTE evidence is not provided and the Electricity Storage System technology is not an electrochemical battery and is not listed in Table 7 of the Data Annex, any hydrogen produced from electricity discharged by this Electricity Storage System shall not be compliant with the Standard.

Example: An onsite battery with an Ideal Capacity of 100 kWh (being able to discharge 100 kWh without charging) starts with a SoH of 95% and SoC_{initial} of 90% ($100 * 95% * 90% = 85.5$ kWh starting position). As evidenced by Electricity Storage System import and export electricity meters, a gross total of 6,000 kWh of electricity is imported and 5,000 kWh of electricity is exported over a month.

- SOC_{final} = 60% at the end of the testing period, so new stored electricity = $100 * 95% * 60% = 57.0$ kWh.
- Change in storage = $57.0 - 85.5 = -28.5$ kWh.
- Losses = Gross units imported – Gross units exported – Change in storage = $6,000 - 5,000 - (-28.5) = 1,028.5$ kWh.

$$RTE = 1 - \text{Losses} / \text{Gross import} = 1 - 1,028.5 / 6,000 = 1 - 17.1\% = 82.9\%.$$

Stored GHG Emission Intensity and Stored REGO Percentage tracking

Stored GHG Emission Intensity tracking

- C.15. The required methodology to track the Stored GHG Emission Intensity of the electricity stored within an Electricity Storage System is a ‘charge first’ accounting methodology. Within a Reporting Unit, regardless of the sequencing of charging/discharging events, their frequency or duration, it is assumed for accounting purposes that all the charging events occur at the start of the Reporting Unit, and all the discharge events occur at the end of the Reporting Unit.
- C.16. Embodied emissions from the manufacture, construction and decommissioning of Electricity Storage Systems are not included within the scope of the Standard.
- C.17. Equation 43 shall be used for updating the Stored GHG Emission Intensity (EI) over a Reporting Unit and
- C.18. Equation 44 shall be used to derive the discharged electricity GHG Emission Intensity during the same Reporting Unit.

Equation 43

Final Stored EI

$$= \frac{(\text{Initial Stored} \times \text{Initial Stored EI}) + (\text{Import Flow} \times \text{Import EI}) + (\text{Other Flow} \times \text{Other EI})}{(\text{Initial Stored} + \text{Import Flow} \times RTE) \times (1 - \text{Self Discharge Loss})}$$

Equation 44

$$\text{Discharged EI} = \text{Final Stored EI}$$

The required information for Equation 43 and Equation 44 is set out below:

- Initial Stored (kWh_e) = Electricity available within the Electricity Storage System at the start of a Reporting Unit, which is equal to the electricity available at the end of the previous Reporting Unit. This is calculated as a product of the SoC, SoH and Ideal Capacity.
- Initial Stored EI (gCO_{2e}/kWh_e) = GHG Emission Intensity of the electricity available within the Electricity Storage System at the start of a Reporting Unit, which is equal to the GHG Emission Intensity of the electricity available at the end of the previous Reporting Unit.
- Import Flow (kWh_e) = total gross charging of the Electricity Storage System occurring during the Reporting Unit.
- Import EI (gCO_{2e}/kWh_e) = GHG Emission Intensity of the electricity used to charge the Electricity Storage System during the Reporting Unit, including the impact of any Upstream T&D Losses using Equation 45. See Annex G Paragraphs G.6-G.12 for the electricity generation GHG Emission Intensity ($EI_{elec\ generation}$) to be applied or calculated.

Equation 45

$$\text{Import EI} = \frac{EI_{elec\ generation}}{1 - \% \text{ Upstream T\&D Losses}}$$

- Other Flow (MJ_{LHV} or kg) = non-electricity Inputs/Outputs required for or resulting from operating the Electricity Storage System during the Reporting Unit, such as fuels, chemicals, or CO₂ and other GHGs emitted.
- Other EI (gCO_{2e}/MJ_{LHV} or gCO_{2e}/kg, to match the units of the Other Flow) = GHG Emission Intensity of the Other Flow used to operate the Electricity Storage System during the Reporting Unit. See Tables 9, 10 and 11 of the Data Annex for GHG Emission Intensities to be applied, including any combustion factors, or Annex G.6 for the GHG methodology to calculate a delivered heat/steam GHG Emission Intensity).
- RTE (%) = Round Trip Efficiency of the Electricity Storage System, from Electricity Storage System import electricity meter to Electricity Storage System export electricity meter. These include (but are not limited to) step-up and step-down transformers, rectifiers, inverters, DCDC conversion, charging

and discharging energy losses (factoring in Coulombic losses and voltage losses) and any heating or cooling duty requirements. See Paragraph C.13-C.14 for more details.

- Self Discharge Loss (%) = expressed as the average percentage of available stored electricity lost by self discharging over a Reporting Unit. See Paragraph C.10-C.12 for more details.
- Discharged EI (gCO_{2e}/kWh_e) = GHG Emission Intensity of electricity discharged from the Electricity Storage System during the Reporting Unit.
- Final EI (gCO_{2e}/kWh_e) = GHG Emission Intensity of the electricity available within the Electricity Storage System at the end of the Reporting Unit, which is equal to the GHG Emission Intensity of the electricity available within the Electricity Storage System at the immediate start of the subsequent Reporting Unit.

C.19. The Discharged EI is before accounting for any Downstream T&D Losses that may apply between the Electricity Storage System and the Hydrogen Production Facility, in order to derive a Delivered GHG Emission Intensity at the Facility, as per Equation 46:

Equation 46

$$Delivered\ EI = \frac{Discharged\ EI}{1 - \% \text{ Downstream T\&D Losses}}$$

C.20. An illustration of the 'charge first' accounting approach is given below in Figure 14. This shows how charging (with an Import EI in red) leads to recalculation of the Final EI (in orange) as a weighted average of the red charged electricity and yellow stored electricity, prior to discharge being assumed.

C.21. In the 'charge first' accounting approach, all charging Inputs in a Reporting Unit shall be combined into a single Input with a single weighted average GHG Emission Intensity (Import EI). All discharges in a Reporting Unit shall be output with the Discharge EI.

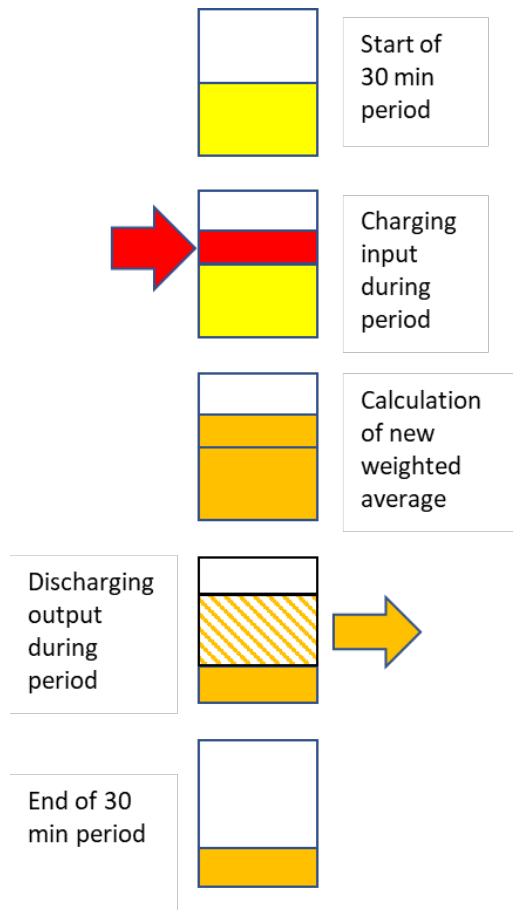

Figure 14: “Charge first” accounting for Stored GHG Emission Intensity tracking

Stored REGO Percentage tracking

- C.22. The weighted average Stored REGO Percentage of the electricity stored within the Electricity Storage System shall be the volume of REGO registered electricity stored divided by the total electricity stored. This will change whenever there is electricity input to charge the Electricity Storage System. The same ‘charge first’ accounting methodology is used as above for the Stored GHG Emission Intensity tracker.
- C.23. Any electricity discharged from the Electricity Storage System shall be assumed to have the same REGO Percentage as the weighted average Stored REGO Percentage of the electricity within the Electricity Storage System at the end of the Reporting Unit. The discharge of electricity does not change the weighted average Stored REGO Percentage of the electricity that remains stored.
- C.24. Equation 47 shall be used for updating the Stored REGO Percentage (RP) over a Reporting Unit and Equation 48 shall be used to derive the discharged electricity RP during that Reporting Unit:

Equation 47

$$Final\ RP = \frac{(Initial\ Stored \times Initial\ RP) + (Imported\ Flow \times RTE \times Imported\ RP)}{(Initial\ Stored + Import\ Flow \times RTE)}$$

Equation 48

$$Discharged\ RP = Final\ RP$$

C.25. The required information for Equation 47 and Equation 48 is set out below:

- Initial Stored (kWh_e) = Electricity available within the Electricity Storage System at the start of the Reporting Unit, which is equal to the electricity available at the end of the previous Reporting Unit
- Initial RP (%) = REGO Percentage of the electricity available within the Electricity Storage System at the start of the Reporting Unit, which is equal to the REGO Percentage of the electricity available at the end of the previous Reporting Unit.
- Import Flow (kWh_e) = total gross charging of the Electricity Storage System occurring during the Reporting Unit.
- Imported RP (%) = REGO Percentage of the electricity used to charge the Electricity Storage System during the Reporting Unit. See the Data Annex Paragraphs DA.24, DA.27 and DA.33 for values to be applied, according to the input electricity source.
- RTE (%) = Round Trip Efficiency of the Electricity Storage System, from Electricity Storage System import electricity meter to Electricity Storage System export electricity meter. See Paragraphs C.13-C.14 for more details.
- Final RP (%) = REGO Percentage of the electricity available within the Electricity Storage System at the end of the Reporting Unit, which is equal to the REGO Percentage of the electricity available within the Electricity Storage System at the immediate start of the subsequent Reporting Unit.
- Discharged RP (%) = REGO Percentage of the electricity discharged from the Electricity Storage System during the Reporting Unit.

C.26. Note the Stored REGO Percentage tracker is constrained to a value between 0% and 100% (inclusive), and does not directly impact the Stored GHG Emission Intensity tracker.

Cancellation of REGOs

C.27. As set out in Annex B Paragraphs B.25-B.30, at the end of each REGO Year, a Hydrogen Production Facility shall calculate how much REGO registered electricity it

has consumed during the REGO Year, and shall provide evidence that they have cancelled at least the same number of REGOs (1 REGO certificate for 1 MWh of REGO derived electricity).

- C.28. The number of REGOs that shall be cancelled by a Hydrogen Production Facility when using electricity discharged from an Electricity Storage System shall be calculated for each Reporting Unit using Equation 49. This uses the discharged REGO Percentage and the volume of electricity discharged from the Electricity Storage System that is consumed by the Hydrogen Production Facility, factoring in losses within the Electricity Storage System (refer to RTE in Paragraph C.13-C.14) and any Upstream T&D Losses and Downstream T&D Losses (refer to Annex B Paragraphs B.31-B.34). Where electricity generation to charge the Electricity Storage System has been sourced from multiple generators, a weighted average for the upstream T&D loss factor shall be used in Equation 49.

Equation 49

REGOs to cancel

$$\geq \frac{\text{Discharged RP} \times \text{Stored Electricity consumed (MWh)}}{\text{RTE} \times (1 - \text{Upstream T\&D Losses}) \times (1 - \text{Downstream T\&D Losses})}$$

- C.29. This calculation is carried out for each Reporting Unit within the REGO Year, and summed across all the Reporting Units within the REGO Year to derive an annual REGO cancellation requirement for Electricity Storage System electricity consumed by the Hydrogen Production Facility. The total number of REGOs to cancel shall be rounded up at the end of the REGO Year to a whole integer number.
- C.30. Self Discharge Losses are assumed not to change the REGO Percentage of the electricity within the Electricity Storage System, so are not accounted for in the calculation of the REGO cancellation requirement.
- C.31. Note that there is no requirement on the Electricity Storage System itself to cancel REGOs, and there is no generation of REGOs by the Electricity Storage System when discharging. Also note that not all REGO registered electricity generation has a GHG Emission Intensity of 0gCO_{2e}/kWh_e.

Example: For one Reporting Unit, 10 MWh of electrolytic hydrogen is produced using 30% electricity from a directly connected Electricity Storage System via a Private Network in Wales, 60% via direct connection to a REGO registered wind farm, and 10% grid imported electricity. The Electricity Storage System in this example has just been charged up from empty using 70% REGO registered solar PV from Scotland (with 10% upstream T&D losses) and 30% GB grid average electricity in the previous 30 minutes, and is assumed to have a RTE of 80% with no downstream T&D losses. Self Discharge Losses are ignored in this example. GB grid average electricity during the current and previous Reporting Unit is assumed to be

160gCO₂e/kWh_e. This set-up would result in three Discrete Consignments during the Reporting Unit, as electrolytic Consignments are determined by the energy inputs:

- 1 MWh of hydrogen based on the GB grid average electricity GHG Emission Intensity (160 gCO₂e/kWh_e), and the grid average REGO Percentage (0%).
- 3 MWh of hydrogen based on the Stored GHG Emission Intensity ((70%*0/(1-10%)+30%*160)/80% = 60 gCO₂e/kWh_e delivered) and Stored REGO Percentage (70%)
- 6 MWh of hydrogen based on a wind electricity GHG Emission Intensity (0 gCO₂e/kWh_e) and 100% REGO Percentage.

Assuming a 55.56% electrolyser LHV efficiency, converting kWh to MJ, and ignoring other minor input emissions in this example, this electrolyser would generate the following Discrete Consignment GHG Emission Intensities and REGO cancellation requirements:

- 1 MWh of hydrogen at a GHG Emission Intensity of $160/3.6/55.56\% = 80 \text{ gCO}_2\text{e/MJ}_{\text{LHV H}_2}$, plus cancellation of $1/55.56\%*0\% = 0$ REGOs.
- 3 MWh of hydrogen at a GHG Emission Intensity of $60/3.6/55.56\% = 30 \text{ gCO}_2\text{e/MJ}_{\text{LHV H}_2}$, plus cancellation of $3/55.56\%*70\%/(80\%*(1-10\%)*(1-0\%)) = 5.25$ REGOs.
- 6 MWh of hydrogen at a GHG Emission Intensity of $0/3.6/55.56\% = 0 \text{ gCO}_2\text{e/MJ}_{\text{LHV H}_2}$, plus cancellation of $6/55.56\%*100\% = 10.8$ REGOs.

If taking a weighted average of Discrete Consignments from only this Reporting Unit at the end of the month, the Hydrogen Production Facility would report a weighted average GHG Emission Intensity of $(1*80+3*30+6*0)/10 = 17.0 \text{ gCO}_2\text{e/MJ}_{\text{LHV H}_2}$, below the GHG Emission Intensity Threshold.

For this Reporting Unit, the Hydrogen Production Facility shall cancel a total of 16.05 REGOs (rounding up only occurs at the end of the REGO Year after summing all REGO cancellation requirements across all Reporting Units within the REGO Year). If the Facility were to fail to provide evidence of cancelled REGOs at the end of the REGO year, then 70% of the 3 MWh Electricity Storage System derived Discrete Consignment + 100% of the 6 MWh wind derived Discrete Consignment = 8.1 MWh in total of the hydrogen from this Reporting Unit would be deemed non-compliant with the Standard.

Tracker (re)starting positions

- C.32. Newly installed Electricity Storage Systems that start discharging electricity to a Hydrogen Production Facility are assumed to begin their Stored GHG Emission

Intensity tracker at 0gCO₂e/kWh_e and begin their Stored REGO Percentage tracker at 0% for the stored electricity.

- C.33. If a Hydrogen Production Facility starts consuming discharged electricity from an existing Electricity Storage System, and this Electricity Storage System has not discharged to any Hydrogen Production Facility previously, then this Electricity Storage System is also allowed to begin their Stored GHG Emission Intensity tracker at 0gCO₂e/kWh_e and Stored REGO Percentage tracker at 0%. However, once these trackers are established for an Electricity Storage System, they shall continue to be updated every Reporting Unit, so that if a Hydrogen Production Facility stops then later restarts consuming from the Electricity Storage System, the trackers are still accurate.
- C.34. Similarly, if a Hydrogen Production Facility starts consuming electricity from an Electricity Storage System, and the trackers for that Electricity Storage System are already live, then these live tracker values shall be used by the Hydrogen Production Facility, and are not assumed to start at zero. Electricity Storage Systems that discharge to multiple Hydrogen Production Facilities shall therefore provide the same Stored GHG Emission Intensity and Stored REGO Percentage values for any Reporting Unit to each of these Hydrogen Production Facilities.
- C.35. An Electricity Storage System shall only stop tracking its Stored GHG Emission Intensity and Stored REGO Percentage when the Electricity Storage System is decommissioned. An Electricity Storage System undergoing maintenance or refurbishment shall continue to update its trackers during these periods.
- C.36. Failure to continue to update the trackers during periods with no discharge to any Hydrogen Production Facility shall result in the Electricity Storage System restarting its trackers using a Stored GHG Emission Intensity of unabated oil-fired generation from Table 4 of the Data Annex (factoring in 10% T&D losses) and a Stored REGO Percentage of 100% upon discharge to a Hydrogen Production Facility resuming.
- C.37. Failure to continue to update the trackers during Reporting Units with discharge to a Hydrogen Production Facility shall result in the Paragraph C.6 requirements not being met, and therefore the consequences set out in Annex B.7-B.8 shall apply to the electricity delivered from the Electricity Storage System during these Reporting Units.

Annex D: Fossil Gas Supply

Overview

- D. 1. Fossil gas – as a feedstock or fuel – is a likely input to several Hydrogen Production Facilities. Any Hydrogen Production Facility using input fossil gas shall follow the requirements set out in this Annex, as relevant to the input fossil gas in question, in helping to determine the appropriate GHG Emission Intensity associated with the Input fossil gas for the Hydrogen Production Facility. Similarly, energy generation assets that consume fossil gas and supply energy to the Hydrogen Production Facility shall follow the requirements set out in this Annex.

Natural gas supply

- D. 2. Natural gas supply configurations shall be assessed in accordance with the three configurations listed below. Hydrogen Production Facilities may source natural gas from any combination of these three natural gas supply configurations in a Reporting Unit.
- Natural gas sourced from the UK Gas Network (either Transmission or Distribution Network), and not linked to a specific source.
 - Natural gas sourced from the UK Gas Network (either Transmission or Distribution Network) and linked to a specific source.
 - Natural gas not sourced from the UK Gas Network.

Natural gas from the UK Gas Network not linked to a specific source

- D. 3. Hydrogen Production Facilities receiving natural gas that has only transited via the UK gas Transmission Network (and not the UK gas Distribution Network) shall use the UK Gas Transmission Network value provided in Table 9 of the Data Annex to account for emissions associated with this natural gas supply. A contract with a licenced supplier for physical delivery of natural gas shall be evidenced, with invoices or statements to match the Facility's gas consumption meter data each month.
- D. 4. Hydrogen Production Facilities receiving natural gas that has transited via the UK Gas Distribution Network shall use the UK Gas Distribution Network value provided in Table 9 of the Data Annex that is the most appropriate to the pressure at which the Facility withdraws gas from the Distribution Network. A contract with a licenced supplier for physical delivery of natural gas shall be evidenced, with invoices or statements to match the Facility's gas consumption meter data each month.

Natural gas from the UK Gas Network linked to a specific source

- D. 5. Natural gas sourced from a specific gas field, where this gas has transited via the UK Gas Network, cannot currently be claimed at the delivered GHG Emission Intensity per Reporting Unit specific to this upstream source. This is due to a lack of an established GHG Emission Intensity accounting methodology and evidence framework within the fossil gas supply industry.
- D. 6. DESNZ will investigate the potential for an evidence framework to allow linkage to specific gas sources in a future version of the Standard. This may include contractual evidence detailing the specific sources and the delivered GHG Emission Intensity.

Natural gas not from the UK Gas Network

- D. 7. Where Hydrogen Production Facilities are receiving natural gas that has not transited via the UK Gas Network (for example through direct pipeline connection with a UK gas field, or direct use of imported liquefied natural gas via ship), they may claim the delivered GHG Emission Intensity for the production and supply of natural gas from this specific source, if the following evidence is provided:
- A supply contract signed with the Hydrogen Production Facility ahead of the physical delivery of natural gas;
 - Invoicing evidence to match the Facility's gas consumption meter data each month;
 - The location of the natural gas production;
 - The planned route and modes of delivery and storage between the point of natural gas production and the Hydrogen Production Facility;
 - The Projected, Estimated or Measured Data specific to the supply chain, along with any Typical or Non Typical Data used.
- D. 8. Hydrogen Production Facilities providing their own data shall account for all GHG emissions associated with natural gas exploration, drilling, extraction, flaring, venting, processing, compression, any liquefaction and regasification, and transport from the extraction point to the Hydrogen Production Facility. These emissions can be incurred anywhere globally and are not restricted to only the UK. This includes the use of electricity, heat/steam, fuels, chemicals, and other Input Materials to the natural gas supply chain, along with losses and fugitive CO₂, methane and other GHG emissions.
- D. 9. Further details for undertaking the extraction and processing emission calculations can be found in Section 9 and Annex F of the Atmospheric Emissions Calculations

document¹⁷.

- D. 10. Where facilities within the supply chain produce multiple Products and/or Co-Products, for example, crude oil and natural gas, an LHV Energy Allocation Method (as described in Chapter 5, Paragraphs 5.12 – 5.19) shall be used to allocate GHG emissions between the Products and Co-Products.

Refinery Off-Gas supply

- D. 11. Some Hydrogen Production Facilities may choose to use Refinery Off-Gases (ROG) as a fuel and/or feedstock (see Chapter 2 for a definition), or to generate Input energy. In UK refineries, ROG is typically combusted on-site to provide heat (and in some cases power) for the refinery. Globally, ROG is also commonly known as refinery fuel gas or refinery still gas.
- D. 12. Any ROG sourced shall be supplied to the Hydrogen Production Facility by dedicated transport mode and shall not be mixed with fossil natural gas or other feedstocks during transport. A contract with a refinery for physical delivery of ROG shall be evidenced, with invoices or statements to match the Facility's ROG consumption meter data each month.
- D. 13. Before the commencement of commercial operations, an upfront assessment of the material classification of ROG shall be carried out by DESNZ on a Facility-by-Facility basis, using current and historical evidence provided from the Hydrogen Production Facility and the refinery supplying the ROG. This will follow Paragraphs 5.10-5.11.
- If ROG is classified as a Residue following Paragraphs 5.10-5.11, the GHG emissions up to the point of collection of the ROG at the refinery shall be taken as zero. The ROG shall also be assigned Fossil Waste/Residue Counterfactual emissions from its replacement with an alternative source, as specified in the Data Annex Paragraphs DA.70 – DA.71.
 - If ROG is classified as a Co-Product following Paragraphs 5.10-5.11, the System Boundary extends back to the production of crude oil as the original feedstock at the start of the supply chain. The LHV Energy Allocation Method given in Chapter 5 shall be used to partition the crude oil supply emissions and refinery processing emissions, by apportioning these GHG emissions between the ROG and other refinery Co-Products. The GHG Emission Intensity of the crude oil shall be either based on field-level data (which shall be evidenced by contracted supplies and supply chain calculations) or Table 3 of the Data Annex for the country of production. Where the refinery uses multiple crude oil inputs, a weighted average mix of these crude oils based on

¹⁷ <https://www.gov.uk/guidance/oil-and-gas-eems-database>

their LHV energy content shall be used to calculate the overall Feedstock Supply emissions.

- D. 14. In the case that Paragraph D.13 leads to classification of a ROG feedstock as a Residue, there are additional checks which shall be applied on an ongoing basis during operations, that ensure any Residue classification and any counterfactual remains appropriate for this ROG source. If Hydrogen Product can be evidenced as the counterfactual fuel used at the refinery and any checks required in Paragraph D.15 are met, this diverted Residue ROG may, as agreed with the Delivery Partner, disregard the Fossil Waste/Residue Counterfactual given in the Data Annex Paragraph DA.71.
- D. 15. The Delivery Partner shall confirm how these ongoing checks shall be implemented and their frequency, including agreeing any relevant Facility or refinery thresholds, in addition to any material classification evidencing requirements from Paragraphs 5.10-5.11. These checks may require the Facility to provide metering data, composition data, diagrams, contracts, invoices or other evidence as to:
- Whether ROG production and/or consumption increases or stays unchanged as a result of hydrogen production.
 - Whether the refinery continues to separate out valuable hydrocarbon products from the ROG streams (e.g. three-carbon chain molecules and above).
 - Whether any fuels or other feedstocks are added to the ROG prior to hydrogen production.
 - How much extra fuel use occurs at the refinery as a result of ROG being diverted for hydrogen production.
 - How much Hydrogen Product displaces previous uses of the ROG within the refinery, or is otherwise sold externally.
 - Any other use, quality or production requirements set by the Delivery Partner.

If agreed Facility or refinery thresholds are not met, the quantity of ROG which does not meet a threshold may be re-classified as a Co-Product of the refinery or may have a different Fossil Waste/Residue Counterfactual applied, as specified by the Delivery Partner.

- D. 16. Regardless of whether ROG is classified as a Residue or Co-Product, the Hydrogen Production Facility shall account for any emissions arising from ROG clean-up/processing, compression, and transport to the Hydrogen Production Facility within Feedstock Supply.

Other fossil gas supply

- D. 17. Hydrogen Production Facilities may choose to use other fossil gas feedstocks from other fossil fuel production processes. The same principles as for ROG will apply, with the material classification to be determined on a Facility-by-Facility basis by DESNZ. Any Waste/Residue classification shall result in the fossil material being assigned Fossil Waste/Residue Counterfactual emissions, or alternatively, a Co-Product classification which will require use of LHV Energy Allocation Method to partition the Upstream and Step emissions. A contract with a supplier for physical delivery of the gas shall be evidenced, with invoices or statements to match the Facility's gas consumption meter data each month.

Annex E: Biogenic Inputs

- E. 1. Biogenic Inputs (including biogenic Products, Co-Products, Wastes and Residues) are derived from biomass. Biomass is defined as any material of biological origin that has been recently (in geological terms) produced by living organisms consuming atmospheric carbon sources, naturally occurring carbon sources or other biogenic material.
- E. 2. Biogenic Inputs may include conventional food and feed crops (e.g. cereals, sugars, vegetable oils), food and agricultural waste, perennial energy crops (e.g. miscanthus grass) and short rotation coppice (e.g. willow, poplar), short rotation forestry (e.g. birch), agricultural residues (e.g. straw), forest residues and residues from processing, and marine-based and novel feedstocks (e.g. microalgae). Note that this list is not exhaustive – for any biogenic Inputs which are not listed above, the definition of biomass (provided in Paragraph E.1) shall be taken as a guide to whether the Input in question, or a component of it, is biogenic.

Overview

- E. 3. The Biomass Requirements given for biogenic Inputs in this Annex are applicable to all biogenic feedstocks and biogenic fuel Inputs used within a Hydrogen Production Facility, as well as to all biogenic Inputs used to generate energy that is consumed by a Hydrogen Production Facility (e.g. sourcing of biomass-derived electricity via the Electricity Grid).
- E. 4. Biogenic Inputs shall meet certain Sustainability Criteria, the Minimum Waste and Residue Requirement, and report on indirect land-use change (ILUC) emissions, the details of which are outlined later in this Annex. The Sustainability Criteria closely follow those set out in the Renewable Transport Fuel Obligation (RTFO).
- E. 5. Where the biogenic Input concerned is converted to biomethane and then stored or transported prior to being used in hydrogen production, the biomethane requirements set out in Annex F shall be followed.
- E. 6. Hydrogen Production Facilities using biogenic feedstocks shall account for emissions related to direct land-use change within the Feedstock Supply Emission Category, as set out in Chapter 5. These direct land-use change emissions shall follow the methodology and approach set out in this Annex.

Minimum Waste and Residue Requirement

- E. 7. For a Hydrogen Production Facility using biogenic feedstock, at least 50% of the biogenic hydrogen produced (by LHV energy content) shall be derived from biogenic

Waste or Residue feedstocks (as defined in Chapter 2). For a Hydrogen Production Facility using biogenic fuel (where this biogenic fuel use does not generate a separate Discrete Consignment), at least 50% of the biogenic fuel (by LHV energy content) shall be derived from biogenic Wastes or Residues. For Hydrogen Production Facilities that source input energy (e.g. electricity, heat, steam) from specific bioenergy generation plants, at least 50% of the bioenergy generation shall be derived from biogenic Wastes or Residues.

- E. 8. For a Hydrogen Production Facility using biogenic feedstock, or Pathways without a feedstock that source Input energy from a specific bioenergy generator, the Hydrogen Production Facility shall meet the Minimum Waste and Residue Requirement on the basis of a weighted average across all Discrete Consignments of biogenic hydrogen produced in a calendar month (independent of which Discrete Consignments are chosen to be included in a Weighted Average Consignment for that month). If the Hydrogen Production Facility cannot comply with the Minimum Waste and Residue Requirement, those Discrete Consignments produced that fall short of the Minimum Waste and Residue Requirement shall not be compliant with the Standard.
- E. 9. Where the use of biogenic fuels or bioenergy sourced from a specific generators do not generate Discrete Consignments (e.g. the Pathway's Discrete Consignments are determined by the feedstocks), the Hydrogen Production Facility shall meet the Minimum Waste and Residue Requirement on the basis of a weighted average across all biogenic fuel or bioenergy Inputs consumed by the Hydrogen Production Facility in a calendar month. If the Hydrogen Production Facility cannot comply with the Minimum Waste and Residue Requirement, the GHG Emission Intensity of the proportion of the biogenic Inputs that fall short of the Minimum Waste and Residue Requirement shall be calculated on the basis that the biomass material that generated this proportion of the Input is fossil heavy fuel oil (see Tables 9 and 11 of the Data Annex, and applying any electricity, heat or steam efficiencies as per Annex G). Any biogenic CO₂ generated at the Facility from this proportion of the Input shall also be considered as fossil CO₂.
- E. 10. Hydrogen Production Facilities shall provide evidence of commercial arrangements for each Input (e.g. invoices with suppliers of Wastes and/or Residues), and sampling data according to the agreed DCMP (refer to Annex H).

Land-use change

Direct land-use change

- E. 11. Land-use change can occur due to the cultivation of biogenic Input for hydrogen production. Direct land-use change describes the land-use change which occurs within the land used to create the Input. Most commonly, it refers to previously

uncultivated land (for example, forest, peatland, grassland) being converted for agricultural use.

- E. 12. Annualised emissions from carbon stock changes caused by direct land-use change¹⁸ shall be calculated by dividing total emissions equally over 20 years. These emissions shall be calculated with Equation 50¹⁹:

Equation 50

$$e_I = (CS_R - CS_A) \times 3.664 \times \left(\frac{1}{20}\right) \times \left(\frac{1}{P}\right)$$

Where:

- e_I = the annualised GHG emissions from carbon stock change due to land-use change (in gCO₂e/MJ_{LHV} crop). ‘Cropland’²⁰ and ‘perennial cropland’²¹ shall be regarded as one land use
- CS_R = the carbon stock associated with the reference land use in hectares (that is, the land use in January 2008 or 20 years before the Input was obtained, whichever was later) (in gC/ha)
- CS_A = the carbon stock associated with the actual land use in hectares (in gC/ha). In cases where the carbon stock accumulates over more than one year, the value attributed to CS_A shall be the estimated stock per unit area after 20 years or when the crop reaches maturity, whichever was earlier
- P = the productivity of the crop (in MJ_{LHV} crop/ha/year)

Calculation of carbon stock for land-use change emissions (CS_R and CS_A)

- E. 13. Equation 50 shall be used for reporting emissions relating to direct land-use change. The key part of the land-use change calculation is an estimation of the change in carbon stocks. This is based on the difference between the carbon stock from the latest available data (which should be, at most, within three years of the reporting month) and the carbon stock in January 2008 (or 20 years before the Input was obtained, whichever is the later date).
- E. 14. Carbon stock shall be calculated using Equation 51.

¹⁸ Emissions related to indirect land-use change are covered in the next section. The impact of land-use change is not applicable to hydrogen derived from Wastes and non-agricultural Residues.

¹⁹ The quotient obtained by dividing the molecular weight of CO₂ (44.010 g/mol) by the molecular weight of carbon (12.011 g/mol) is equal to 3.664.

²⁰ Cropland as defined by IPCC.

²¹ Perennial crops are defined as multi-annual crops, the stem of which is usually not annually harvested such as short rotation coppice and oil palm.

Equation 51

$$CS_i = SOC + C_{VEG}$$

Where:

- CS_i is the carbon stock of the land
- SOC is the soil organic carbon (in gC/ha)
- C_{VEG} is the above and below-ground vegetation carbon stock (in gC/ha)
- Carbon stock estimates are based on a number of key parameters which shall be determined by the Hydrogen Production Facility:
 - previous land use
 - climate and in some cases ecological zone
 - soil type
 - soil management (for both previous and new land use)
 - soil input (for both previous and new land use)

E. 15. Definitions of the different land use categories for determining previous land use (and their associated carbon stock values) are provided below:

- Cropland – non-protected: this category includes cropped land (including rice fields and set-aside), and agroforestry systems where the vegetation structure falls below the thresholds used for the forest categories²². The cropland is not in a nature-protected area.
- Cropland – protected – no interference with nature protection purpose: same as above, but the cropland is in a nature protection area and the production of the raw material did not interfere with the nature protection purpose.
- Cropland - protected/protection status unknown: this category of cropland shall be used where:
 - the cropland had protected status but evidence could not be provided that there was no interference with the nature protection purpose; or
 - the protection status could not be determined.

²² Note that perennial crop plantations are classed as cropland under this Standard.

-
- Grassland (and other wooded land not classified as forest): this category includes rangelands and pasture land that are not considered cropland, but which have an agricultural use. It also includes grasslands without an agricultural use but excludes highly biodiverse grassland and cropland lying temporarily fallow for less than 5 years. It additionally includes systems with woody vegetation and other non-grass vegetation such as herbs and brushes that fall below the threshold values used in the forest land categories including both those with and without an agricultural use. It includes extensively managed rangelands as well as intensively managed (for example, with fertilisation, irrigation, species changes) continuous pasture and hay land.
 - Highly biodiverse grassland: this is defined as any grassland spanning more than one hectare which is included as a 'priority grass and habitat'²³ under the UK Biodiversity Action Plan²⁴. For grasslands located outside of the UK, definitions of highly biodiverse grassland according to the relevant competent authority in that country may be used. This category cannot be reported for natural grassland that is highly biodiverse. It shall only be reported for non-natural highly biodiverse grasslands that would cease to be grassland in the absence of human intervention, where evidence is provided that harvesting of the raw material is necessary to preserve its grassland status.
 - Highly biodiverse forest: highly biodiverse forest and other wooded land which is species-rich and not degraded²⁵.
 - Forest greater than 30% canopy cover: continuously forested areas, namely land spanning more than one hectare with trees higher than five metres and a canopy cover of more than 30%, or trees able to reach those thresholds in situ.
 - Forest 10 to 30% canopy cover: land spanning more than one hectare with trees higher than five metres and a canopy cover of between 10% and 30%, or trees able to reach those thresholds in situ.
 - Wetland: land that is covered with or saturated by water permanently or for a significant part of the year.
 - Undrained peatland: this is peatland that was not completely drained in January 2008 (or 20 years before the Input was obtained, whichever is the

²³ <https://jncc.gov.uk/our-work/uk-bap-priority-habitats/#list-of-uk-bap-priority-habitats>

²⁴ Further guidance on what constitutes a priority grassland habitat is also available in Annex 2 of the JNCC Guidelines for the Selection of Biological Sites of Special Scientific Interest (SSSIs) <https://hub.jncc.gov.uk/assets/cf50f420-1b38-4253-89f8-1cb7ba010f27>

²⁵ More specific guidance on how to determine if land is highly biodiverse forest will be provided as soon as it is available.

later date). This includes peatland that was not drained at all and peatland that was partially drained.

- Settlement: includes all developed land, including transportation infrastructure and human settlements of any size, unless they are already included under other categories. Examples of settlements include land along streets, in residential (rural and urban) and commercial lawns, in public and private gardens, in golf courses and athletic fields, and in parks, provided such land is functionally or administratively associated with particular cities, villages or other settlement types and is not accounted for in another land use category²⁶.

- E. 16. Hydrogen Production Facilities shall determine the exact location of the land-use change. Soil management (whether full-till, reduced-till or no-till) and soil inputs (low, medium, high-with manure, and high-without manure) are factors that also need to be determined and included in the calculations.
- E. 17. In most cases, it is possible to use the information above to find values within the references given in the Data Annex Paragraphs DA.12-DA.14. However, under certain conditions, actual carbon stock measurements or other calculation methodologies will need to be undertaken, for example, if the soil is a histosol or if no value exists in the reference given in the Data Annex. In the absence of specified carbon stock, the carbon stock shall be measured for any settlement or degraded land converted for hydrogen production.

Soil organic carbon - mineral soils

- E. 18. Hydrogen Production Facilities may use several methods to determine soil organic carbon (SOC), including measurements²⁷. When measurements are not used, the method used shall take into account climate, soil type, land cover, land management and inputs.
- E. 19. As a default method, Equation 52 shall be used:

Equation 52

$$SOC = SOC_{ST} \times F_{LU} \times F_{MG} \times F_I$$

Where:

- SOC_{ST} is the standard soil organic carbon in the 0 - 30 cm topsoil layer (in gC/ha)

²⁶ This definition is taken from the 2006 IPCC Guidelines for National GHG inventories (Vol 4).

²⁷ Soil organic carbon levels can traditionally be measured using mass loss on ignition or wet oxidation. However, newer techniques are being developed, which can either be carried out in the field or remotely (near-infrared reflectance spectrometry, remote hyperspectral sensing).

- F_{LU} is the land use factor reflecting the difference in soil organic carbon associated with the type of land use compared to the standard soil organic carbon (no unit)
- F_{MG} is the land use factor reflecting the difference in soil organic carbon associated with the principle management practice compared to the standard soil organic carbon (no unit)
- F_I is the land use factor reflecting the difference in soil organic carbon associated with different levels of carbon input to soil compared to the standard soil organic carbon (no unit)
- SOC_{ST} can be looked up in the reference given in the Data Annex Paragraph DA.14, depending on climate region and soil type. The climate region can be determined from the climate region data layers within the reference given in the Data Annex Paragraph DA.12. The soil type can be determined by following the flow diagram in Figure 15 or following the soil type data layers within in the reference given in the Data Annex Paragraph DA.12.
- F_{LU} , F_{MG} and F_I can be looked up within the reference given in the Data Annex Paragraph DA.14, depending on climate region, land use, land management and input.

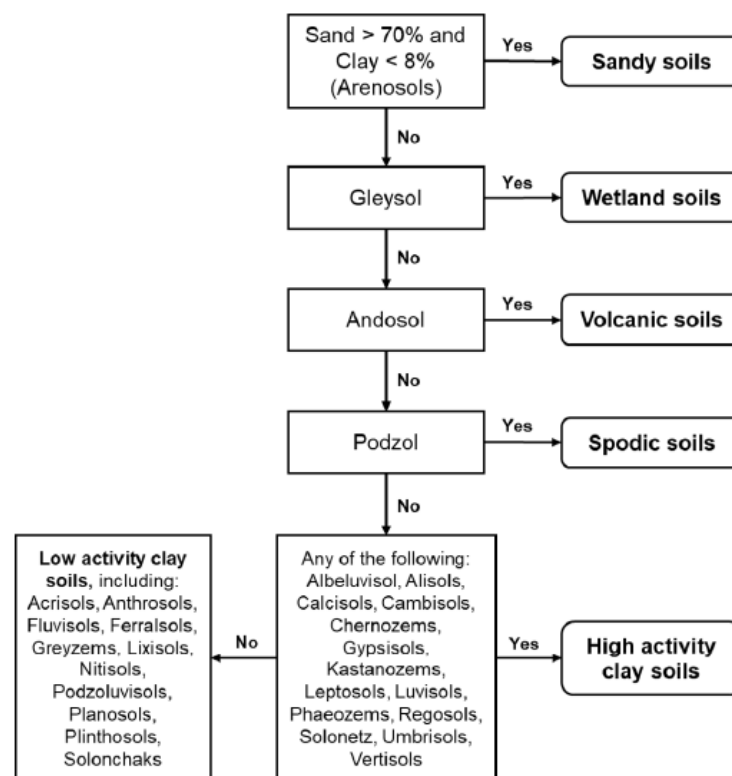

Figure 15: Flow diagram for classifying soil type

Soil organic carbon - organic soils (histosols)

- E. 20. No default method is available for determining the SOC value of organic soils. However, the method used by the Hydrogen Production Facility shall take into account the entire depth of the organic soil layer as well as climate, land cover, land management and input. Such methods may include measurements.
- E. 21. Where carbon stock is affected by soil drainage, losses of carbon following drainage shall be taken into account by appropriate methods, potentially based on annual losses of carbon following drainage.

Above and below-ground vegetation carbon stock (C_{VEG})

- E. 22. For some vegetation types, C_{VEG} can be directly read from the reference given in Data Annex Paragraph DA.14. Relevant ecological zones can be determined from maps produced within the reference given in Data Annex Paragraph DA.13.
- E. 23. If a value is not available in the references provided, vegetation carbon stock shall be calculated, taking into account both above and below-ground carbon stock in living stock (C_{BM} in gC/ha) and above and below-ground carbon stock in dead organic matter (C_{DOM} in gC/ha), noting Data Annex Paragraph DA.15.
- E. 24. Above and below-ground carbon stock in living stock shall be calculated using Equation 53 or Equation 54:

Equation 53

$$C_{BM} = (B_{AGB} \times CF_B) + (B_{BGB} \times CF_B)$$

Or

Equation 54

$$C_{BM} = (B_{AGB} \times CF_B) \times (1 + R)$$

Where:

- B_{AGB} is the weight of above-ground living biomass (in kg dry matter/ha) which shall be taken to be the average weight of the above-ground living biomass during the production cycle for cropland, perennial crops and forest plantations.
- B_{BGB} is the weight of below-ground living biomass (in kg dry matter/ha) which shall be taken to be the average weight of the below-ground living biomass during the production cycle for cropland, perennial crops and forest plantations.

- CF_B is the carbon fraction of dry matter in living biomass (in kgC/kg dry matter), refer to the Data Annex Paragraph DA.16.
- R is the ratio of below-ground carbon stock in living biomass to above-ground carbon stock in living biomass which can be read in the reference given in the Data Annex Paragraph DA.14.

E. 25. Above and below-ground carbon stock in dead organic matter shall be calculated with Equation 55.

Equation 55

$$C_{DOM} = (DOM_{DW} \times CF_{DW}) + (DOM_{LI} \times CF_{LI})$$

Where:

- DOM_{DW} is the weight of the deadwood pool (in kg dry matter/ha)
- CF_{DW} is the carbon fraction of dry matter in the deadwood pool (in kgC/kg dry matter), refer to the Data Annex Paragraph DA.16.
- DOM_{LI} is the weight of litter (in kg dry matter/ha)
- CF_{LI} is the carbon fraction of dry matter in the litter (in kgC/kg dry matter), refer to the Data Annex Paragraph DA.16.

Indirect land-use change

- E. 26. Indirect land-use change (ILUC) is the global knock-on effect of the expansion of agricultural land use resulting from the cultivation of biogenic Inputs for hydrogen production, due to Input market pricing impacts. GHG emissions associated with ILUC vary depending on the situation but can be significant to a point which greatly reduces (or even nullifies) the GHG emission benefits generally associated with low carbon hydrogen production and use. There is ongoing work to improve our understanding of ILUC emissions, the outcomes of which will inform any future changes to the Standard.
- E. 27. The requirements outlined in this Annex help to mitigate the risk of high emissions associated with ILUC. In particular, the Land Criteria (see below for more detail) and Minimum Waste and Residue Requirement help to limit the role that high-risk ILUC Inputs can play in hydrogen production.
- E. 28. Estimated ILUC emissions in gCO_{2e}/MJ_{LHV} Hydrogen Product shall be reported for all biogenic feedstocks and for all biogenic energy Inputs (electricity, heat, steam, fuels) to a Hydrogen Production Facility. This reporting shall be accompanied by the ILUC factors applied (from Table 2 of the Data Annex) and the conversion factors from MJ_{LHV} of cultivated biomass to MJ_{LHV} of Hydrogen Product that apply to the

Pathway (there may be multiple conversion factors if there is ILUC associated with the biomass feedstock and ILUC also associated with e.g. biofuel heating Inputs). These calculations are entirely separate to the GHG Emission Intensity Calculation Methodology and do not form part of the Final GHG Emission Intensities. A report of nil ILUC emissions shall be submitted if there are no ILUC emissions associated with the biogenic feedstocks or biogenic energy Inputs to a Hydrogen Production Facility.

E. 29. The consequences of failing to report on estimated ILUC emissions are set out below:

- Where a biogenic feedstock generates a Discrete Consignment of Hydrogen Product (refer to Paragraph 7.4): Should the Facility not report on estimated ILUC emissions for the biogenic feedstock, the resulting Discrete Consignment shall not be compliant with the Standard.
- For a Pathway without a feedstock, where a biogenic energy Input to a Facility generates a Discrete Consignment of Hydrogen Product (refer to Paragraph 7.5): Should the Facility not report on estimated ILUC emissions for the biomass material that generated this biogenic energy Input, the resulting Discrete Consignment shall not be compliant with the Standard.
- For a Pathway with a feedstock, where a non-feedstock biogenic energy Input (electricity, heat, steam) to a Facility does not generate a separate Discrete Consignment of Hydrogen Product: Should the Facility not report on estimated ILUC emissions for the biomass material that generated this biogenic energy Input, the GHG Emission Intensity of the Input shall be calculated on the basis that the biomass material is fossil heavy fuel oil (combining the upstream and combustion data from Tables 9 and 11 of the Data Annex, and applying the electricity, heat or steam efficiencies as per Annex G).
- For a Pathway with a feedstock, where a non-feedstock biogenic fuel Input to a Facility does not generate a separate Discrete Consignment of Hydrogen Product: Should the Facility not report on estimated ILUC emissions for the biomass material that generated this biogenic fuel Input, the GHG Emission Intensity of the Input shall use the production and supply GHG Emission Intensity of fossil heavy fuel oil (refer to Table 9 of the Data Annex), and any biogenic CO₂ generated at the Facility from the use of the Input shall also be considered as fossil CO₂ in calculating the Process CO₂ emissions (refer to Table 1 of the Data Annex).

Sustainability Criteria

E. 30. Certain biogenic Inputs shall comply with relevant Sustainability Criteria to be compliant with the Standard, to mitigate against other negative environmental and

social outcomes. Table 7 below lists the relevant Sustainability Criteria (Land Criteria, Forest Criteria and/or Solid Carbon Criteria) that different types of biogenic Inputs shall meet, following the precedent set out in the RTFO.

Table 7: Relevant Sustainability Criteria that types of biogenic Input shall meet

Inputs	Land Criteria	Forest Criteria	Soil Carbon Criteria
Forest biomass, including Residues from Forestry or Wastes from forestry		✓	
Residues, including processing Residues, which are not Residues from Agriculture, Aquaculture, Fisheries or Forestry			
Wastes, which are not Wastes from Agriculture, Aquaculture, Fisheries or Forestry			
Residues or Wastes from Agriculture	✓		✓
Any biogenic Input not falling within entries listed above	✓		

- E. 31. It is strongly recommended that Hydrogen Production Facilities using biogenic Inputs²⁸ meet the Land, Forest and Soil Carbon Criteria by reporting through a voluntary scheme that has been recognised as demonstrating compliance with the relevant criteria, as this means that no further evidence is required. Demonstrating compliance is covered in more detail in the sections below.
- E. 32. The consequences of failing to evidence compliance with these Sustainability Criteria are set out below:
- Where a biogenic feedstock generates a Discrete Consignment of Hydrogen Product (refer to Paragraph 7.4). Should this biogenic feedstock not satisfy all

²⁸ A Hydrogen Production Facility may handle the original biogenic Input, or a product derived from it (e.g. biogas, biomethane, bio-electricity). Either way, it is the original biogenic material, prior to any engineered conversion, that is subject to the Sustainability Criteria laid out in the Standard.

the relevant Sustainability Criteria, the resulting Discrete Consignment shall not be compliant with the Standard.

- For a Pathway without a feedstock, where a biogenic energy Input to a Facility generates a Discrete Consignment of Hydrogen Product (refer to Paragraph 7.5): Should the biomass material that generated this biogenic energy Input not satisfy all the relevant Sustainability Criteria, the resulting Discrete Consignment shall not be compliant with the Standard.
- For a Pathway with a feedstock, where a non-feedstock biogenic energy Input (electricity, heat, steam) to a Facility does not generate a separate Discrete Consignment of Hydrogen Product: Should the biomass material that generated this biogenic energy Input not satisfy all the relevant Sustainability Criteria, the GHG Emission Intensity of the Input shall be calculated on the basis that the biomass material is fossil heavy fuel oil (combining the upstream and combustion data from Tables 9 and 11 of the Data Annex, and applying the electricity, heat or steam efficiencies as per Annex G).
- For a Pathway with a feedstock, where a non-feedstock biogenic fuel Input to a Facility does not generate a separate Discrete Consignment of Hydrogen Product: Should the biomass material that generated this biogenic fuel Input not satisfy all the relevant Sustainability Criteria, the GHG Emission Intensity of the Input shall use the production and supply GHG Emission Intensity of fossil heavy fuel oil (refer to Table 9 of the Data Annex), and any biogenic CO₂ generated at the Facility from the use of the Input shall also be considered as fossil CO₂ in calculating the Process CO₂ emissions (see Table 1 of the Data Annex).

Land Criteria

- E. 33. The Land Criteria ensure that relevant biogenic Inputs are sourced in a way that preserves biodiversity and carbon stocks. To achieve this, biogenic Inputs for hydrogen production shall not be sourced from land that has or previously had a certain status (high biodiversity or carbon stock). In some cases, it is permitted to source material from land of a certain status if specific criteria are met.
- E. 34. The Land Criteria are made up of two sub-criteria, one which covers biodiversity and the other carbon stocks and peatlands.

Biodiversity criteria

- E. 35. To satisfy the biodiversity criteria, hydrogen shall not be produced using raw material obtained from land with high biodiversity value in or after January 2008. The prohibited land categories are:

-
- Primary forest or other wooded land of native species where there is no clearly visible indication of human activity and ecological processes are not significantly disturbed.
 - Highly biodiverse forest or other wooded land which is species-rich and not degraded except in cases where the land is designated for nature protection purposes and the production of relevant Input is a necessary management action that did not interfere with the purposes for which the land concerned was designated for nature protection purposes.
 - Land designated for nature protection purposes, including those designated for the protection of rare, threatened, or endangered ecosystems or species, unless production of the relevant Input can be shown not to have interfered with those nature protection purposes.
 - Natural highly biodiverse grassland²⁹ spanning more than one hectare.
 - Non-natural highly biodiverse grassland spanning more than one hectare, unless harvesting of the raw material is necessary to preserve its status as highly biodiverse grassland.

E. 36. For the exemptions permitted in the land categories above, evidence shall be provided that the exemption is valid.

Carbon stocks and peatlands criteria

- E. 37. Hydrogen shall not be made using raw material if the sourcing of such biomass would cause adverse effects on land carbon stocks or to peatlands. To satisfy the carbon stocks and peatlands criteria, the following need to be satisfied:
- Hydrogen shall not be made from raw material obtained from land which had the following land status at any time in January 2008 and no longer has that status:
 - Wetlands, defined as land that is covered with or saturated by water permanently or for a significant part of the year.
 - Continuously forested areas spanning more than one hectare with trees higher than five metres and a canopy cover of more than 30%, or trees able to reach those thresholds in situ.
 - Where raw material is sourced from land which at any time in January 2008 was a forested area spanning more than one hectare with trees higher than five metres and a canopy cover of between 10% and 30%, or trees able to

²⁹ Natural grassland is grassland that would remain as grassland and that maintains its natural species composition, ecological characteristics and processes in the absence of human intervention.

reach those thresholds in situ, and the land no longer has that status, Hydrogen Production Facilities shall take into account emissions due to direct land-use change.

- E. 38. Hydrogen shall not be made from raw material obtained from land which was peatland at any time in January 2008, unless it can be demonstrated that the cultivation and harvesting of that raw material did not involve drainage of previously undrained soil.

Soil Carbon Criteria

- E. 39. The Soil Carbon Criteria apply specifically to hydrogen made from Wastes and Residues derived from agriculture and is in addition to the Land Criteria.
- E. 40. To meet the Soil Carbon Criteria, Hydrogen Production Facilities shall demonstrate that monitoring or management plans are in place to address the impacts on soil quality and soil carbon of the harvesting of the biogenic Input concerned.
- E. 41. To comply with the Soil Carbon Criteria, Hydrogen Production Facilities shall demonstrate that appropriate monitoring or management practices are either:
- Required by law in the country of origin of the Input, and that their implementation is monitored and enforced;
 - In place at the farms from which the material was sourced.

Forest Criteria

- E. 42. The Forest Criteria apply to hydrogen made from forest biomass, including Wastes and Residues from forestry. Such biogenic Inputs do not have to meet the Land Criteria.
- E. 43. Where hydrogen is derived from forest biomass Inputs, it shall be demonstrated that the Inputs meet the following criteria:
- The material has not been harvested from wetlands, peatlands or protected land areas unless the land is designated for nature protection purposes and the production of the relevant Input did not interfere with the purposes for which the land concerned was designated for nature protection purposes;
 - The material has been legally harvested;
 - The material has been harvested in such a way that negative impacts on soil quality and forest biodiversity are minimised, and which maintains or improves the long-term production capacity of the forest from which it was harvested;

-
- Areas that have been harvested are subject to forest regeneration³⁰;
 - Changes in carbon stock associated with forest biomass harvest are accounted for in submissions related to the country's commitment to reduce or limit Greenhouse Gas emissions through the Paris Agreement, or the material has been harvested in such a way that carbon stock and sink levels in the forest are maintained or increased over the long term.

E. 44. To comply with the Forest Criteria, it shall be demonstrated that appropriate monitoring or management practices, which ensure the criteria described in Paragraph E.43 are satisfied, are either:

- Required by law in the country of origin of the Input, and that their implementation is monitored and enforced;
- In place at the forest sourcing area³¹ from which the material is sourced.

Demonstrating compliance with the Sustainability Criteria

- E. 45. Hydrogen Production Facilities shall provide evidence of compliance with the relevant Sustainability Criteria by using one (or more) existing voluntary schemes. Voluntary schemes that may be used to provide evidence of compliance with the Sustainability Criteria are listed in the Data Annex Paragraph DA.86.
- E. 46. Voluntary schemes are recognised for a specific scope. For example, they might be recognised as providing evidence for one or more of the Land Criteria, Forest Criteria, or Soil Carbon Criteria. Where a voluntary scheme does not provide evidence for all of the Land, Forest and/or Soil Carbon Criteria, then Facilities shall demonstrate compliance with those criteria through another voluntary scheme or by following the compliance routes outlined below.
- E. 47. The chain of custody rules of a voluntary scheme shall be complied with for a Hydrogen Production Facility to claim that the biogenic Input in question complies. A Hydrogen Production Facility shall either be certified under the voluntary scheme or, where it is not certified, check with the voluntary scheme before a claim is made.
- E. 48. Hydrogen Production Facilities utilising voluntary schemes must have evidence that the biogenic Input in question complies with such a voluntary scheme. It is not sufficient to purchase from an economic operator that has been certified against a voluntary scheme unless the biogenic Input supplied by that entity is accompanied by evidence of meeting the scheme, for example, a proof of sustainability. This is

³⁰ "Forest regeneration" means the re-establishment of a forest stand by natural or artificial means following the removal of the previous stand by felling or as a result of natural causes, including fire or storm.

³¹ "Sourcing area" means the geographically defined area from which the forest biomass is sourced, from which reliable and independent information is available and where conditions are sufficiently homogeneous to evaluate the risk of the sustainability and legality characteristics of the forest biomass.

because being certified under a voluntary scheme does not require that entity to only supply sustainable biogenic Inputs.

- E. 49. A certificate issued under the listed voluntary schemes is the only acceptable form of evidence. Additional evidence is not generally required to substantiate the sustainability information included on the certificate. However, the claim of compliance with the scheme and the certificate must be legitimate, the recognised version of the scheme must be used, and the quantity of Input shall be recorded accurately.
- E. 50. The Delivery Partner shall have the right to request more information where necessary, to ensure that the specific requirements of the Standard have been met.

Alternative options for demonstrating compliance with the Sustainability Criteria

- E. 51. If a voluntary scheme is not available (for example, for a particular biogenic Input or region), then Hydrogen Production Facilities shall conduct independent third-party audits to evidence compliance with the Sustainability Criteria.
- E. 52. To evidence compliance, a third-party audit shall capture the same evidence as a listed voluntary scheme. A list of potential evidence sources that may be used as part of a third-party audit report (for example, on historic land use) can be found in the guidance for the RTFO³², which shares the same Land, Forest, and Soil Carbon Criteria.

³² <https://www.gov.uk/government/publications/renewable-transport-fuel-obligation-rtfo-compliance-reporting-and-verification>

Annex F: Biomethane Input Supply

Overview

- F.1. Any Hydrogen Production Facility using biomethane shall follow the requirements set out in this Annex. Any biomethane sourced shall be supplied by dedicated transport mode and shall not be mixed with fossil natural gas.

Supply Requirements

- F.2. National and international sourcing of biomethane and its storage, movement by dedicated pipeline, or movement by any other means of dedicated transport as part of a supply chain, prior to being utilised in a Hydrogen Production Facility, is permissible.
- F.3. However, biomethane shall not be claimed as an Input to the Hydrogen Production Facility if mixed with fossil natural gas at any point prior to the Hydrogen Production Facility (e.g. mixed within the UK Gas Network). DESNZ will continue to work across government to consider relevant methodologies for tracking the chain of custody for biomethane when mixed with fossil natural gas.
- F.4. If biomethane is used as an Input to a Hydrogen Production Facility (either as a feedstock within Feedstock Supply, or as a fuel within Fuel Supply, as per the Emission Categories in Chapter 5), the Hydrogen Production Facility shall as a minimum provide the following evidence:
- The commercial arrangements for the physical supply of biomethane, e.g. invoices.
 - The location of biomethane production.
 - The route and modes of delivery of biomethane from the point of production to the Facility, including any storage or other intermediate Steps between generation and the Facility.
 - The feedstocks used for biomethane production and their country of origin.
 - Evidence that all the relevant Biomass Requirements set out in Annex E are met.
- F.5. For a Hydrogen Production Facility with on-site biomethane production within the System Boundary, information on the whole site configuration and metering arrangements is likely to be sufficient to fulfil the first three evidence requirements above.

-
- F.6. If information provided by the Hydrogen Production Facility is deemed to be insufficient by the Delivery Partner, or if any stage of the biomethane supply chain involves mixing with fossil natural gas, the Input shall be treated as wholly fossil natural gas, with any resulting CO₂ emissions considered as fossil CO₂ rather than biogenic CO₂.
- F.7. Renewable guarantees of origin, commercial green gas certificates and other book and claim systems³³ are not sufficient in and of themselves to evidence biomethane use under the Standard, since they do not prove that the biomethane has been physically supplied to the Hydrogen Production Facility.

³³ Book and claim systems are systems where certificates of sustainability are sold/traded separately from the physical commodity.

Annex G: Non-Typical Data for Input Energy

Overview

- G. 1. This Annex is used for calculating the GHG Emission Intensity of Input electricity, heat and/or steam when Typical Data is not available (in Table 4 of the Data Annex). This calculation first relies on assessing the GHG Emission Intensity of the generated energy, which is set out in the sections below.
- G. 2. Any losses between the point of energy generation and the point of use within the Hydrogen Production Facility shall be accounted for in the Energy Supply Emission Category in Chapter 5, by deriving a delivered energy GHG Emission Intensity using Equation 56:

Equation 56

$$EI_{delivered\ energy} = \frac{EI_{generated\ energy}}{(1 - \% \text{ losses})}$$

Where:

- $EI_{delivered\ energy}$ = The GHG Emission Intensity of the delivered energy, in gCO₂e/MJ delivered.
 - $EI_{generated\ energy}$ = The GHG Emission Intensity of the generated energy, in gCO₂e/MJ generated.
 - Losses = Electricity Transmission and Distribution Losses as covered in Annex B, or thermal losses during transport of any heat/steam estimated and evidenced by the Hydrogen Production Facility.
- G. 3. Energy generation assets should not assume a GHG Emission Intensity calculated for a different purpose or under a different UK policy can be used directly within the Standard, as the System Boundaries, GWPs or GHG emissions included may be different. The Standard does not include certain bonuses or credits used in other UK policies, such as emissions savings from soil carbon accumulation via improved agricultural management, degraded land bonuses, manure bonuses, CO₂ capture and replacement, or credits for excess electricity from co-generation.

System Boundary for energy generation

G. 4. When calculating the GHG Emission Intensity of Input electricity, heat and/or steam under the second option in Paragraph 5.33, the System Boundary shall start at different places depending on the classification of the original material that generates the Input energy (see Chapters 2 and Paragraphs 5.10-5.11 for relevant definitions and the classification approach):

- **Waste or Residue materials** shall start the generated energy GHG Emission Intensity calculations at the point of collection of the Waste or Residue feedstock, with nil GHG emissions associated with the feedstock up to the point of collection. The calculations therefore include collection, any pre-processing, storage and transport, up to and including the relevant energy generation asset.
- **Biomass materials that are not Wastes/Residues** shall start the generated energy GHG Emission Intensity calculations from the point of cultivation of the biomass. The calculations therefore include land preparation (including any direct land-use change, but excluding indirect land-use change), sowing of seeds/planting, application of fertilisers, pesticides, harvesting, collection, any pre-processing, storage and transport, up to and including the relevant energy generation asset.
- **Fossil materials that are not Wastes/Residues** shall start the generated energy GHG Emission Intensity calculations at the point of exploration. The calculations therefore include drilling/mining, development, extraction/production including any venting and flaring, maintenance and workovers, any purification/pre-processing, including any compression, liquefaction, storage and transport, up to and including the relevant energy generation asset.
- **Nuclear fuel** shall start the generated energy GHG Emission Intensity calculations at the point of exploration. The calculations therefore include uranium ore mining, uranium processing and enrichment, nuclear fuel rod production, storage and transport, up to and including the relevant energy generation asset.
- **Renewable energy generation** plants that do not consume a material, for example wind and solar farms, shall start the generated energy GHG Emission Intensity calculations at the energy generation facility. Geothermal plants shall account for any increase in GHG emissions if energy generation operations increase previously naturally occurring vented emissions.

- **Electricity Storage Systems** discharging electricity shall use the Stored GHG Emission Intensity from Annex C as the generated energy GHG Emission Intensity.
- **Hydrogen or hydrogen-derived fuels** used to generate energy (as an Input to a Hydrogen Production Facility) shall start the generated energy GHG Emission Intensity calculations at the same point as given within the Standard, i.e. based on the original feedstock/energy input used to generate the hydrogen. This GHG assessment shall also include any efficiency losses and emissions incurred during conversion to hydrogen-derived fuels, transport (nationally or internationally) and storage, and any re-conversion back to hydrogen, up to and including the relevant energy generation asset.

G. 5. Where CO₂ is captured by one of the processes within the scope of the generated energy GHG Emission Intensity calculations, including if CO₂ is captured from the energy generation asset, the emissions associated with energy input and fugitive emissions up to the CO₂ T&S Network Delivery Point shall be included – for example, purification, trucking, compression, leaks. Any emissions after the CO₂ T&S Network Delivery Point shall not be included.

Generated energy GHG Emission Intensity calculation methodology

- G. 6. Hydrogen Production Facilities should use the Typical Data GHG Emission Intensities for any Inputs to the energy generation asset already given within the Data Annex (such as fuels and materials in Table 9 and Table 10 of the Data Annex respectively). If the required values for Inputs to the energy generation asset are not provided in the Data Annex, the Facility shall reference alternative reputable sources with a justification for their applicability, such as UK government conversion factors or peer reviewed academic literature for these generation Inputs.
- G. 7. The total GHG emissions ($e_{energy\ generation}$) arising from generation of electricity, heat and/or steam, given in gCO₂e, shall be calculated using Equation 57.

Equation 57

$$e_{energy\ generation} = e_{ec} + e_l + e_{td} + e_p - e_{ccs}$$

Where:

- e_{ec} : the total GHG emissions, given in gCO₂e, from extraction of raw materials for the generation Inputs. This term includes extraction or cultivation processes, collection of raw materials, waste, leakages and fugitive emissions during extraction, cultivation or collection, and the production, supply and use

of chemicals, materials or energy Inputs in extraction, cultivation and collection. This term excludes the capture of CO₂ in the production of raw materials, and certified reductions of GHG emissions from venting or flaring at oil production sites (anywhere in the world).

- e_l : the total Greenhouse Gas emissions, given in gCO₂e, from carbon stock changes caused by direct land-use change relating to the production of the energy generation Inputs (refer to Annex E for full guidance and the required calculations). This parameter does not apply to Waste or Residue feedstocks used in energy generation, as these supply chains only start at the point of feedstock collection and is also unlikely to apply to most fossil fuel or nuclear supply chains. Emissions arising from the construction of the energy generation asset itself are out of scope.
- e_{td} : the total Greenhouse Gas emissions, given in gCO₂e, from transport and distribution of the generation Input or prior raw or intermediate materials. This includes transport and storage of raw and semi-finished materials (excluding extraction/collection emissions covered under e_{ec}), distribution and storage of finished feedstocks. This term excludes transmission and distribution of the generated electricity/heat/steam.
- e_p : the total Greenhouse Gas emissions, given in gCO₂e, from processing the energy generation Input into the energy vector of interest (electricity, heat and/or steam), including any intermediate pre-processing. This term includes emissions from the production and supply of chemicals, materials and any other energy Inputs used in energy generation (but not the main energy generation Input which is covered in e_{ec} , e_l , e_{td} above); processing the energy generation Input itself (e.g. fossil CO₂ released); any compression and transport of captured CO₂ prior to CO₂ T&S Network Delivery Point that is not already reflected in the energy generation efficiency; wastes, leakages and fugitive non-CO₂ emissions.
- e_{ccs} : the CO₂ saving from CO₂ Capture and Sequestration (CCS), given in gCO₂e. This credit shall be limited to the CO₂ emissions avoided through the capture and sequestration of emitted CO₂ directly related to those processes given in Paragraph G.3 above. This parameter excludes any savings already included under e_p . The CO₂ credit shall be claimed if the conditions of Paragraph 5.49 are met, substituting the energy generation asset for the Hydrogen Production Facility within Paragraph 5.49.

Example: For cultivated biomass, chipped then gasified before biomethane is fed to a steam boiler, the following inputs might be considered:

e_{ec} Diesel, electricity, seeds, fertilisers, chemicals used in planting, cultivation, harvesting and collection of perennial energy crops.

e_l Direct land use change from perennial energy crops planted on arable farmland.

e_{td} Diesel and electricity used in transport and storage of stems, transport and storage of biomass chips.

e_p Water, flue gas scrubbing chemicals at the steam boiler, along with diesel used in biomass chipping, and start-up heating fuels, electricity and chemicals used in biomass gasification to biomethane.

e_{ccs} CO₂ captured and sequestered from the biomass gasification to biomethane asset.

Example: For uranium ore to nuclear fuel rods to electricity generation, the following inputs might be considered:

e_{ec} Diesel and electricity used in the extraction of uranium ore.

e_{td} Diesel and electricity used in transport and storage of uranium ore, transport and storage of enriched uranium, and transport and storage of uranium fuel rods.

e_p Water, chemicals in power generation, along with electricity, water and chemicals used in uranium enrichment and nuclear fuel rod production.

Example: For fossil natural gas to combined heat and electricity generation, the following inputs might be considered:

e_{ec} Natural gas, electricity and diesel used in exploration, drilling and extraction.

e_{td} Electricity and natural gas used in transport and storage of raw natural gas, and transport and storage of processed natural gas.

e_p Water, flue gas scrubbing and CO₂ capture chemicals in power generation, along with electricity, water and chemicals used in natural gas processing.

e_{ccs} CO₂ captured and sequestered from the combined heat & electricity generation asset – noting that this credit would be excluded if part of a Private Network.

- G. 8. If Co-Products are generated at the same time as the main intermediate products of interest from upstream pre-processing (for example, exported electricity is a Co-Product from a biomass pellet plant, or natural gas liquids are a Co-Product from natural gas processing), then the LHV Energy Allocation Method shall be used to apportion GHG emissions up to that point in the supply chain between the Products and Co-Products from the pre-processing, based on their LHV energy contents. These allocation rules and the derivation of Allocation Factors are detailed in Paragraphs 5.12-5.19.

GHG Emission Intensity for energy generation

G. 9. Once the total GHG emissions have been determined for the generated energy ($e_{energy\ generation}$), the GHG Emission Intensity of the generated electricity/heat/steam shall be calculated using Equation 58, Equation 59 or Equation 60 as appropriate.

G. 10. For electricity generation only:

Equation 58

$$EI_{elec\ generation} = \frac{e_{energy\ generation}}{P_{el}}$$

Where:

- $EI_{elec\ generation}$ = The GHG Emission Intensity of the generated electricity, in gCO₂e/MJ_e generated.
- $e_{energy\ generation}$ = The GHG emissions arising from the generation of electricity within the calendar month, in gCO₂e (using Equation 62).
- P_{el} = The (net) electrical output, defined as the electricity exported from the electricity generation asset in MJ_e within the calendar month.

G. 11. For heat or steam generation only:

Equation 59

$$EI_{heat\ generation} = \frac{e_{energy\ generation}}{P_h}$$

Where:

- $EI_{heat\ generation}$ = The GHG Emission Intensity of the generated heat or steam, in gCO₂e/MJ_{th} of Useful Heat generated.
- $e_{energy\ generation}$ = The GHG emissions arising from the generation of heat or steam within the calendar month, in gCO₂e (using Equation 62).
- P_h = The Useful Heat contained within the heat or steam export from the energy generation asset in MJ_{th} within the calendar month.

G. 12. For combined electricity, heat and/or steam generation:

Equation 60

$$EI_{elec\ generation} = \frac{e_{energy\ generation}}{P_{el} + C_h \times P_h}$$

Equation 61

$$EI_{heat\ generation} = \frac{e_{energy\ generation} \times C_h}{P_{el} + C_h \times P_h}$$

Where:

- $e_{energy\ generation}$ = The GHG emissions arising from the generation of electricity, heat and/or steam within the month, in gCO₂e (using Equation 62).
- C_h = The Carnot Efficiency, that is, the fraction of useful energy in the Heat or Steam Product or Co-Product, as defined in Equation 8 in the Standard Document.

Annex H: Measured and Estimated Data

Overview

- H. 1. This Annex sets out the requirements for taking measurements of or estimating Activity Flow Data used to calculate GHG Emission Intensities (for Hydrogen Product and determining any Non-Typical Data), and to determine Standard Compliance during Hydrogen Production Facility operation. Schemes applying the Standard may have additional measurement and/or data requirements which apply to a Hydrogen Production Facility in their relevant contractual arrangements.
- H. 2. For all Hydrogen Production Facilities, the following requirements shall be met:
- Unless otherwise stated, Measured Data and Estimated Data shall be recorded per Reporting Unit, to calculate the GHG Emission Intensity for each Discrete Consignment.
 - The Hydrogen Production Facility shall carry out a measurement uncertainty assessment of the relevant meters (see Table 9) and other measurement equipment. The Facility shall undertake this once per year as a minimum and following any change in measurement equipment, including meter types.

Data Collection and Monitoring Procedure (DCMP) for all Pathways

- H. 3. A Hydrogen Production Facility shall have a DCMP in place and agreed with the Delivery Partner as part of the Monitoring, Reporting and Verification (MRV) Framework (as per Chapter 8). The DCMP may be updated from time to time by agreement between the Hydrogen Production Facility and the Delivery Partner. The DCMP shall as a minimum include suitable procedures for the following:
- Measuring or otherwise estimating the quantity of Inputs and Outputs in each Reporting Unit.
 - Classifying Inputs and Outputs and reviewing each classification, covering the frequency of review.
 - Determining the composition of any Inputs and Outputs, covering the frequency, sampling techniques and methodologies used.
 - Calculating the LHV energy content of any Inputs and Outputs, covering the frequency, sampling techniques and methodologies used.

- Generating multiple Discrete Consignments from mixed Inputs, including any biogenic and fossil components, covering the frequency, sampling techniques and methodologies used.

Background methodologies

Method to calculate mass flow

- H. 4. The mass flow of an Input and Output material (including metered Feedstock Gas, hydrogen, CO₂, fuel supply via permanent connection, steam, water and oxygen) shall be calculated using Equation 62:

Equation 62

$$\text{Mass flow (kg)} = \text{Mean mass flowrate} \left(\frac{\text{kg}}{\text{s}} \right) \times \text{Time period (s)}$$

- H. 5. If a volumetric flowrate meter is used, the conversion of volumetric flowrate to mass flow shall be calculated using Equation 63:

Equation 63

$$\begin{aligned} \text{Mass flow (kg)} \\ = \text{Mean volumetric flowrate} \left(\frac{\text{m}^3}{\text{s}} \right) \times \text{Density} \left(\frac{\text{kg}}{\text{m}^3} \right) \times \text{Time period (s)} \end{aligned}$$

- H. 6. If volumetric flowrate meter is used for a gas phase Input or Output, the Hydrogen Production Facility shall determine the gas density in units of kg/m³, which depends on the gas temperature and pressure. To determine gas density, the Hydrogen Production Facility shall either use a densitometer or shall use an appropriate equation of state, for example, Peng Robinson or Soave-Redlich-Kwong (SRK). The Hydrogen Production Facility shall provide evidence to the Delivery Partner as to which equation of state is used, and why this is appropriate, which depends on the nature of the gas species.
- H. 7. Compositional analysis shall be used with metered flowrates using Equation 64 to calculate the quantity of pure CO₂ injected into the CO₂ T&S Network using the mass fraction of CO₂ (refer to Paragraph H.9) within the CO₂-rich Output material stream.

Equation 64

$$\begin{aligned} \text{Pure CO}_2 \text{ flow (kg)} \\ = \text{CO}_2\text{-rich stream mass flowrate} \left(\frac{\text{kg}}{\text{s}} \right) \\ \times \text{Mass fraction of CO}_2 \left(\frac{\text{kg}_{\text{CO}_2}}{\text{kg}} \right) \times \text{Time period (s)} \end{aligned}$$

- H. 8. Compositional analysis can also be used with weighed flow rates to calculate the quantity of pure Solid Carbon produced using the mass fraction of Solid Carbon (refer to Paragraph H.13) in the Solid Carbon Output using Equation 65:

Equation 65

$$\begin{aligned} & \text{Pure Solid Carbon flow}(kg) \\ &= \text{Solid carbon Output mass flowrate} \left(\frac{kg}{s} \right) \\ & \times \text{Mass fraction of Solid Carbon Output} \left(\frac{kg_c}{kg} \right) \times \text{Time period} (s) \end{aligned}$$

Method to calculate LHV of impure material streams

- H. 9. Compositional analysis equipment, such as gas chromatography, samplers and online sensors, shall measure the composition of different species in feedstocks, Input fuels via a permanent connection, captured CO₂, Co-Products and Hydrogen Product streams, by mass fraction (kg/kg) or mole fraction (mol/mol). The frequency of this composition analysis shall be agreed with the Delivery Partner, depending on the variability of the stream measured. Mass fraction results shall be provided for every species present. If composition values are measured in terms of mole fraction (mol/mol), these values shall first be converted to mass fractions using Equation 66.

Equation 66

$$\begin{aligned} & \text{Mass fraction of a species} \left(\frac{kg}{kg} \right) \\ &= \frac{\text{Mole fraction of a species} \left(\frac{mol}{mol} \right) \times \text{Species molar mass} \left(\frac{g}{mol} \right)}{\sum_i \left(\text{Mole fraction of species}_i \left(\frac{mol}{mol} \right) \times \text{Species molar mass}_i \left(\frac{g}{mol} \right) \right)} \end{aligned}$$

- H. 10. Hydrogen Production Facilities that measure the composition data of an Input or Output (as per Table 8) shall derive the LHV of the material using Equation 67:

Equation 67

$$\begin{aligned} & \text{LHV of material stream} \left(\frac{MJ}{kg} \right) \\ &= \sum \left(\text{Mass fraction of species} \left(\frac{kg}{kg} \right) \times \text{LHV of pure species} \left(\frac{MJ}{kg} \right) \right) \end{aligned}$$

For any Inputs or Outputs where composition data is not measured, Hydrogen Production Facilities shall refer to the Data Annex Paragraph DA.87.

Method to calculate Process CO₂ emissions

- H. 11. Process CO₂ emissions ($E_{Process\ CO_2}$) shall be calculated using a mass balance approach for the Inputs and Outputs to the Hydrogen Production Facility, following Equation 68. This sums the carbon contents of all the fossil Inputs, then subtracts the total carbon content of all the fossil Outputs that are not CO₂ (e.g. fossil Solid Carbon, fossil Co-Products, Fugitive non-CO₂ emissions, other liquid or solid fossil Wastes/Residues). The net amount of fossil carbon is assumed to be generated as fossil CO₂, prior to any CO₂ capture.
- H. 12. If there are both biogenic and fossil Inputs to the Hydrogen Production Facility, it is assumed that the proportion of Input carbon atoms from fossil Inputs compared to the total Input carbon atoms also applies to all Outputs from the Hydrogen Production Facility, in which case, Equation 68 only includes the fossil proportion of the Outputs. Similarly, if there is an Input that is a mix of biogenic and fossil components, Equation 68 only includes the fossil share of the Input.

Equation 68

$$\begin{aligned}
 E_{Process\ CO_2}(g_{CO_2}) &= 3664 \left(\frac{g_{CO_2}}{kg_C} \right) \\
 &\times \left\{ \sum_{Fossil\ Inputs} \left(Carbon\ content\ of\ Input \left(\frac{kg_C}{kg} \right) \times Mass\ flow\ of\ Input\ (kg) \right) \right. \\
 &\quad \left. - \sum_{Fossil\ Outputs,\ excluding\ CO_2} \left(Carbon\ content\ of\ Output \left(\frac{kg_C}{kg} \right) \times Mass\ flow\ of\ Output\ (kg) \right) \right\}
 \end{aligned}$$

- H. 13. The carbon content (kg_C/kg) of an Input or Output is the fractional mass of all carbon atoms in the Input or Output divided by the mass of the Input or Output, as given in Equation 69:

Equation 69

$$\begin{aligned}
 Carbon\ content \left(\frac{kg_C}{kg} \right) &= \sum_{all\ species} \left(\frac{Mass\ Fraction\ of\ each\ species \times 12.011 \left(\frac{kg_C}{kmol} \right) \times Carbon\ atoms\ per\ species}{Molecular\ mass\ of\ each\ species \left(\frac{g}{mol} \right)} \right)
 \end{aligned}$$

Data type requirements

- H. 14. Table 8 provides a breakdown by data types that Hydrogen Production Facilities shall use as a minimum for each Input and Output material. A Hydrogen Production Facility may provide Measured Data instead of Estimated Data, or calculate the GHG Emission Intensity of an Input material using methodologies in the Standard instead of literature data, or may provide compositional analysis data instead of literature data. Table 8 matches the list of Inputs and Outputs from Paragraph H.9 that require compositional analysis.

Table 8: Minimum data type requirements for each Input and Output material

Input and Output Type	Activity Flow Data: Mass Flow	GHG Emission Intensity	Activity Flow Data: Composition
Feedstock	Measured Data (metered or weighed)	Typical Data or if unavailable, Non-Typical Data (literature)	Measured Data (compositional analysis of flow)
Fuels via a permanent connection	Measured Data (metered or weighed)	Typical Data or if unavailable, Non-Typical Data (literature)	Typical Data or if unavailable, Non-Typical Data (literature)
Fuels without a permanent connection	Estimated Data (invoices and mass balance)	Typical Data or if unavailable, Non-Typical Data (literature)	Typical Data or if unavailable, Non-Typical Data (literature)
Input Materials used continuously	Measured Data (metered) for water and oxygen. Otherwise, Estimated Data (invoices and mass balance).	Typical Data or if unavailable, Non-Typical Data (literature)	Estimated Data (literature)
Input Materials not used continuously	Estimated Data (invoices)	Typical Data or if unavailable, Non-Typical Data (literature)	Estimated Data (literature)

Co-Product gas with a permanent connection	Measured Data (metered)	N/A	Measured Data (compositional analysis of flow)
Co-Product gas without a permanent connection	Estimated Data (mass balance)	N/A	Measured Data (compositional analysis of samples)
Co-Product liquid with a permanent connection	Measured Data (metered or weighed)	N/A	Measured Data (compositional analysis of flow)
Co-Product liquid without a permanent connection	Estimated Data (mass balance)	N/A	Measured Data (compositional analysis of samples)
Co-Product solid	Measured Data (weighed)	N/A	Measured Data (compositional analysis of samples)
Wastes and Residues	Estimated Data (mass balance)	N/A	Estimated Data (literature)

Metering requirements

Meter locations for each Eligible Hydrogen Production Pathway

- H. 15. Hydrogen Production Facilities shall meter each connection of Inputs and Outputs indicated with a tick (✓) in Table 9 for the relevant Pathway (or shall source equivalent metering data for any Electricity Storage System not at the Hydrogen Production Facility). Failure to install a meter for these Inputs and Outputs shall result in non-compliance with the Standard, due to insufficient quality of evidence. If a given Input or Output is never used or produced by a Hydrogen Production Facility, a meter is not required to be installed. Further details regarding these meters are given in the sections below.

Table 9: Required meters for each Pathway

Meter	Electrolysis	Fossil / biogenic gas reforming (with CCS)	Gas splitting producing Solid Carbon	Biomass / waste gasification
Hydrogen	✓	✓	✓	✓
Electricity	✓	✓	✓	✓
Electricity Storage System – import & export	✓	✓	✓	✓
Water	✓ if imported	✓ if imported	✓ if imported	✓ if imported
Feedstock Gas		✓	✓	✓ if gaseous feedstock
CO ₂ T&S Network Delivery Point		✓		✓
Oxygen		✓ if imported		✓ if imported
Heat and steam	✓ if imported or exported	✓ if imported or exported	✓ if imported or exported	✓ if imported or exported
Fuel	✓ if permanent connection	✓ if permanent connection	✓ if permanent connection	✓ if permanent connection
Co-Product		✓ if permanent connection	✓ if permanent connection	✓ if permanent connection

H. 16. For reference, Table 10 shows how the meters referenced for each Pathway align within the Emission Categories within the Standard’s GHG Emission Intensity Calculation Methodology, and the appropriate references within the Standard Document. Note Table 10 only lists meters and does not consider other measurement approaches (such as estimated data) for other Inputs and Outputs contributing to these Emissions Categories.

Table 10: Meter identification for Emission Categories

Emission Category	Meter type	Reference
E _{Feedstock Supply}	Feedstock Gas meter	Paragraphs 5.20-5.24
E _{Energy Supply}	Electricity meter, Electricity Storage System meters, heat meter, steam meter, fuel meter (for supply via permanent connection)	Paragraphs 5.25-5.33
E _{Input Materials}	Water meter, oxygen meter	Paragraphs 5.34-5.36
E _{Process CO₂}	Feedstock Gas meter, fuel meter (for supply via permanent connection)	Paragraphs 5.37-5.38
E _{Fugitive non-CO₂}	No meter	Paragraphs 5.39-5.44
E _{CO₂ Capture and Network Entry}	Electricity meter, Electricity Storage System meters, heat meter, steam meter, fuel meter (for supply via permanent connection)	Paragraphs 5.45-5.48
E _{CO₂ Sequestration}	CO ₂ T&S Network Delivery Point meter	Paragraphs 5.49-5.53
E _{Solid C Distribution}	No meter	Paragraphs 5.54-5.56
E _{Solid C Sequestration}	No meter	Paragraphs 5.57-5.60
E _{Compression and Purification}	Electricity meters, heat meter, steam meter, fuel meter (for supply via permanent connection)	Paragraphs 5.61-5.66
E _{Fossil Waste/Residue Counterfactual}	Feedstock Gas meter	Paragraphs 5.67-5.72
All Emission Categories, due to LHV energy allocation	Co-Product meter	Paragraphs 5.12-5.19

Hydrogen meters

- H. 17. A hydrogen meter shall be used immediately after onsite hydrogen compression and purification but before any onsite Hydrogen Storage, to account for the quantity of Hydrogen Product generated. If the hydrogen meter measures volumetric flows of Hydrogen Product, it shall also measure the temperature (°C) and pressure (kPa) of the material stream. The method to calculate mass flow and LHV of Hydrogen Product is explained in Paragraphs H.4-H.8.

Electricity meters

- H. 18. All Hydrogen Production Facilities shall install electricity meters on each electricity import connection, each electricity export connection, as well as the electricity charge and discharge connection from any onsite Electricity Storage System. These electricity meters shall account for all electricity flow.
- H. 19. The electricity meters shall account for the gross number of kilowatt hours per Reporting Unit that are consumed by the Hydrogen Production Facility or exported by the Hydrogen Production Facility.
- H. 20. Hydrogen Production Facilities shall use only Gross Meters. Net Meters shall not be used.

Electricity Storage System meters

- H. 21. Electricity Storage Systems shall follow the requirements for electricity meters given in Paragraphs H.18-H.20.
- H. 22. Figure 16 shows the location of meters required for all Hydrogen Production Facilities producing hydrogen using electricity from an Electricity Storage System. Meters 1 & 2 could be the same electricity meter depending on the locations of the generation asset and Electricity Storage System, and sources of electricity used to charge the Electricity Storage System. Meters 3 & 4 could be the same electricity meter depending on the locations of the Electricity Storage System and Hydrogen Production Facility, and Input sources of electricity used in Hydrogen Production Facility.



Figure 16: Schematic of the location of electricity meters for a Pathway using an Electricity Storage System.

-
- Meter (1) is the generation asset export electricity meter.
 - Meter (2) is the Electricity Storage System import electricity meter.
 - Meter (3) is the Electricity Storage System export electricity meter.
 - Meter (4) is the Hydrogen Production Facility import electricity meter.

Water meter

- H. 23. A water meter shall be used if water is sourced from outside the site boundary for use by the Hydrogen Production Facility. The method to calculate mass flow is explained in Paragraphs H.4-H.8.
- H. 24. The meter measuring water flow shall measure the mass or volumetric flowrate of imported water. Note that if a volumetric flowrate meter is used, the density of water can be assumed to remain a constant 997 kg/m³ irrespective of water temperature or pressure.

Feedstock Gas meter

- H. 25. A meter shall be installed on all connections that import Feedstock Gas to the Hydrogen Production Facility.
- H. 26. Feedstock Gas meters shall measure the mass or volumetric flowrate of the feedstock. If the Feedstock Gas meter measures volumetric flows of Feedstock Gas, it shall also measure the temperature (°C) and pressure (kPa) of the material stream. The method to calculate mass flow is explained in Paragraphs H.4-H.8.
- H. 27. The Feedstock Gas composition shall be analysed at a frequency set out in the DCMP to determine carbon content using the methodology set out in Paragraph H.13, and shall be used to calculate the LHV energy flow of Feedstock Gas as set out in Paragraph H.9-H.10.

CO₂ T&S Network Delivery Point meter

- H. 28. An CO₂ meter is required for Pathways in which CO₂ is captured by the Hydrogen Production Facility and sent for geological sequestration. This meter is to be located at the point of entry into a CO₂ T&S Network, where the liability for the CO₂ is transferred. The method to calculate mass flow is explained in Paragraphs H.4-H.8.
- H. 29. The CO₂ T&S Network Delivery Point meter shall measure the mass or volumetric flowrate of CO₂-rich gas. If the CO₂ meter measures volumetric flows of CO₂, it shall also measure the temperature (°C) and pressure (kPa) of the material stream. The method to calculate mass flow is explained in Paragraphs H.4-H.8.

-
- H. 30. Compositional analysis equipment shall measure the composition of different species within the CO₂-rich stream, including impurities, by mass fraction (kg/kg) at the CO₂ T&S Network Delivery Point. The mass fraction of CO₂ and the CO₂ T&S Network Delivery Point flowrate meter shall be used to calculate the quantity of pure CO₂ sent for sequestration as per Equation 64. The methodology to calculate the mass fractions of the CO₂-rich stream is provided in Paragraphs H.4-H.8.

Oxygen meter

- H. 31. An oxygen meter is only required if oxygen is sourced from outside the Hydrogen Production Facility and transported onsite. This includes where the oxygen production occurs in an adjacent facility that does not form part of the Hydrogen Production Facility. The method to calculate mass flow is explained in Paragraphs H.4-H.8 and relevant GHG Emission Intensities are found in Table 10 of the Data Annex.
- H. 32. The oxygen meter shall measure the mass or volumetric flowrate of oxygen gas. If the oxygen meter measures volumetric flows of oxygen, it shall also measure the temperature (°C) and pressure (kPa) of the material stream. The method to calculate mass flow is explained in Paragraphs H.4-H.8.

Heat and steam meter

- H. 33. The heat and steam meters shall account for heat and steam imported or exported by the Hydrogen Production Facility. If heat is transferred using steam, any heat and steam may be accounted using the same steam meter. If heat is transferred using a different heat transfer medium than steam, the flowrate of the heat transfer medium shall be metered separately to the steam meter. GHG Emission Intensities for imported steam and heat are to be calculated in line with Paragraphs 5.30-5.31.
- H. 34. The heat and steam meters shall measure the mass or volumetric flowrate of steam (or other heat transfer medium). If the steam meter measures volumetric flows of steam (or other heat transfer medium), it shall also measure the temperature (°C) and pressure (kPa) of the material stream. The method to calculate mass flow is explained in Paragraphs H.4-H.8. The mass flowrate of steam or heat transfer medium shall be converted to an equivalent energy flow using a specific enthalpy of steam at the metered temperature and pressure.

Fuel meter (via permanent connection)

- H. 35. If a non-feedstock fuel is imported onsite using a permanent pipeline connection, a fuel meter is required for each type of fuel. Relevant GHG Emission Intensities for imported fuel supply are found in Table 9 of the Data Annex.
- H. 36. The fuel meter shall measure the mass or volumetric flowrate of fuel. If the fuel meter measures volumetric flows of fuel, it shall also measure the temperature (°C)

and pressure (kPa) of the material stream. The method to calculate mass flow is explained in Paragraphs H.4-H.8. The mass flowrate of fuel shall be converted to an LHV energy flow using the methodology in Paragraphs H.9-H.10.

Other Co-Product meter

- H. 37. For any Co-Product exported via a permanent connection from the Hydrogen Production Facility, that has a non-zero LHV energy content and which is not covered by meters considered in the Paragraphs H.15-H.36, a meter shall be installed at the point of export from the Hydrogen Production Facility. A meter is not required for Wastes or Residues.
- H. 38. The meter shall measure the mass or volumetric flowrate of the Co-Product. The method to calculate the LHV energy content of the Co-Product is explained in Paragraphs H.9-H.10.

Measurement and Meter Failure

- H. 39. In the case of Measurement and Meter Failure for an Input or Output listed in Table 10 for the Pathway, the Hydrogen Production Facility shall record the time of failure. The affected Discrete Consignments shall be deemed non-compliant with the Standard, unless the Delivery Partner determines in its discretion that such Discrete Consignments can be treated as valid and agrees an alternative approach to determine the Discrete Consignment GHG Emissions Intensity. This may take into account the Materiality of the Input or Output for which there has been a Measurement and Meter Failure, including if the monthly Materiality assessment is typically based on the metered data.

Meter Failure of Electricity Storage System import electricity meter

- H. 40. If the Electricity Storage System import electricity meter fails, estimated data may be used to update the Stored GHG Emission Intensity tracker of the Electricity Storage System. In this case, Hydrogen Production Facilities may use the Electricity Storage System export electricity meter, a known RTE, change in 30-minute SoC, SoH, ideal capacity supported by performance guarantees to estimate the Activity Flow Data (volume of electricity) into the Electricity Storage System using Equation 70:

Equation 70

$$Gross\ Import = \frac{Gross\ Export - (Ideal\ Capacity \times SoH \times (SoC_{final} - SoC_{initial}))}{RTE}$$

- H. 41. Where there is missing data for two or more variables including Electricity Storage System import electricity meter, Electricity Storage System export electricity meter, RTE, change in 30-minute SoC, SoH or ideal capacity, it is not possible to estimate the Activity Flow Data (volume of electricity) into the Electricity Storage System. In

this case, Hydrogen Production Facilities shall resort to the guidance for Measurement and Meter Failure in Paragraph H.39.

- H. 42. In the case of failure of the Electricity Storage System import electricity meter, the highest value between the GHG Emission Intensities among relevant specific generators used for charging and the 30-minute relevant grid average GHG Emission Intensity (GB or NI, depending on the Hydrogen Production Facility location) shall be used for Import EI (Annex C Paragraph C.9).

Other Measurement Requirements

Calculating the biogenic and fossil components of mixed feedstocks

- H. 43. Hydrogen Production Facilities shall determine the number of Discrete Consignments within each Reporting Unit, and determine if there is any mixing of Inputs at the Facility or in the supply chain, including use of mixed biogenic and fossil Inputs. Hydrogen Production Facilities shall implement a system to track the individual biogenic and fossil Discrete Consignments and the associated sustainability information.
- H. 44. Samples taken must be in sufficient quantities for analysis and be representative of the feedstocks used. Standards are available which outline recognised good practice for extracting samples and forming composites for biomass and Waste feedstocks. A sample of these standards can be found in Appendix 12 of the Renewables Obligation: Fuel Measurement and Sampling Guidance³⁴. The frequency of sampling is to be agreed with the Delivery Partner on a case-by-case basis depending on the variability of the inputs.
- H. 45. Hydrogen Production Facilities using biomass feedstocks or inputs shall evidence the mass and Lower Heating Value (LHV) energy content of each feedstock entering the plant over the month. If a feedstock is a mix of fossil and biogenic components, Hydrogen Production Facilities shall evidence the mass and LHV energy contents of the fossil and biogenic components, as these will be considered as two separate feedstocks, each generating a Discrete Consignment.
- H. 46. The biogenic proportion of a mixed feedstock can be calculated using Equation 71 and Equation 72:

Equation 71

$$\text{Biogenic proportion} = \frac{MJ_{LHV} \text{ of biogenic component}}{MJ_{LHV} \text{ of total feedstock}}$$

³⁴ <https://www.ofgem.gov.uk/publications/renewables-obligation-fuel-measurement-and-sampling-guidance>

Equation 72

$$\begin{aligned} MJ_{LHV} \text{ of component} \\ &= \text{kg of component as received} \times LHV_{dry} \\ &\times (1 - \% \text{ moisture content of component}) \end{aligned}$$

- H. 47. Hydrogen Production Facilities shall measure the dry LHV of the components with reference to Paragraphs H.9 and H.10. The frequency of this feedstock sampling and verified testing will have to be agreed with the Delivery Partner on a case-by-case basis, depending on the variability of the feedstock.

Measuring solid Inputs and Outputs

- H. 48. Where a solid Input or Output is a Material Emission Source, or is a Feedstock or Co-Product of the Hydrogen Production Facility, Hydrogen Production Facilities shall record the Activity Flow Data for the amount of solid Input and Output using weighing equipment. The frequency of measuring and reporting weights shall be agreed with the Delivery Partner as part of the DCMP.
- H. 49. Analysis equipment, such as sampling or sensors shall measure the composition of different species within any solid Input and Output, including impurities, by mass fraction (kg/kg). The methodology to calculate mass fractions within a solid is provided in Paragraph H.4-H.8, with specific guidance for Solid Carbon given in Paragraph H.8.

Estimated Data requirements

- H. 50. For a Hydrogen Production Facility, the Activity Flow Data for Emission Sources that are neither metered nor sampled, shall be estimated through invoiced or contractual data from the relevant supplier or using a mass balance. Where relevant, equipment manufacturer performance guarantees or third party verified testing may also be used as Estimated Data. These Emission Sources may include:
- Chemicals and materials: Invoices shall be submitted to record the mass flow of chemicals (such as salts, solvents, acids) and a mass balance for any continuous use.
 - Fuels without a permanent connection: Hydrogen Production Facilities shall provide estimated data for the amount of fuels used, supported with invoices and mass balance for any continuous use.
 - Catalyst: Invoices shall be provided to report the mass of each purchased catalyst.

-
- Leakage losses including venting of non-CO₂ GHG species (Paragraph 10.13) shall be estimated using a mass balance and mass composition to determine the flowrate of each Input and Output stream (such as changes in stock levels). The difference between the mass of each non-CO₂ GHG species in the Input and Output material streams are Fugitive non-CO₂ emissions that shall be converted to gCO₂e by multiplying with relevant GWPs (Table 1 of the Data Annex).
 - Using a mass balance and assuming complete combustion of flare material Input, the mass of N₂O and any other non-CO₂ GHG species produced shall be calculated and convert to gCO₂e by multiplying with relevant GWPs (Table 1 of the Data Annex).
- H. 51. For Input materials that are used continuously within the process but do not arrive via a permanent connection, invoices and Measured Data or Estimated Data (in this case, mass balance) shall be submitted. GHG Emissions resulting from the continuous use of these Input materials shall be accounted per unit of Hydrogen Product based on the estimated or measured Activity Flow Data.
- H. 52. For Input materials that are not used continuously within the process and arrives in batches, invoices shall be used to estimate GHG emissions. The Hydrogen Production Facility shall allocate GHG emissions from the invoiced quantity of Input material equally across all Hydrogen Product generated in the month in which the Input material arrives onsite. The Hydrogen Production Facility may allocate these GHG emissions to certain Discrete Consignments in the same month if the Hydrogen Production Facility provides operational evidence that the Input material was consumed during these Discrete Consignments.
- H. 53. The method of measurement or estimation shall be recorded and justified for every Discrete Consignment and shall be checked against the available evidence (for example, invoices, contracts), as discussed in Chapter 8.

Example: if a 100,000 MJ_{LHV} batch of diesel is purchased in January and not used continuously by the Hydrogen Production Facility, the GHG emissions of diesel use are allocated equally across all Hydrogen Product generated in the same month. The GHG Emission Intensity for the production, supply and combustion of diesel is 17.5 + 74.4 = 91.9 gCO_{2e}/MJ_{LHV} of diesel using data from Tables 9 and 11 in the Data Annex. The values provided below are illustrative.

GHG emissions from diesel use = 100,000 MJ_{LHV} * 91.9 gCO_{2e}/MJ_{LHV} = 9,190,000 gCO_{2e}.

In January, Hydrogen Product generated in a month = 25,920,000 MJ_{LHV}.

GHG emissions from diesel per unit of Hydrogen Product = 9,190,000 ÷ 25,920,000 = 0.35 gCO_{2e}/MJ_{LHV} Hydrogen Product.

Example: The Hydrogen Production Facility in the example above provides evidence that all the diesel purchased is consumed within a 1-day period equating to 864,000 MJ_{LHV} of Hydrogen Product. In this case, the Hydrogen Production Facility may allocate the GHG Emissions from diesel consumption:

GHG emissions from diesel use = 100,000 MJ_{LHV} * 91.9 gCO_{2e}/MJ_{LHV} = 9,190,000 gCO_{2e}.

In the 1 day, Hydrogen Product generated = 864,000 MJ_{LHV}.

GHG emissions from diesel per unit of Hydrogen Product during only that 1 day period = 9,190,000 ÷ 864,000 = 10.6 gCO_{2e}/MJ_{LHV} Hydrogen Product.

If you need a version of this document in a more accessible format, please email uklchs@energysecurity.gov.uk. Please tell us what format you need. It will help us if you say what assistive technology you use.