

Pierce Declaration

EXHIBIT 44

U 7293220



THE UNITED STATES OF AMERICA

TO ALL TO WHOM THESE PRESENTS SHALL COME:

**UNITED STATES DEPARTMENT OF COMMERCE
United States Patent and Trademark Office**

April 26, 2011

**THIS IS TO CERTIFY THAT ANNEXED HERETO IS A TRUE COPY FROM
THE RECORDS OF THIS OFFICE OF:**

**U.S. PATENT: 7,844,915
ISSUE DATE: November 30, 2010**

**By Authority of the
Under Secretary of Commerce for Intellectual Property
and Director of the United States Patent and Trademark Office**

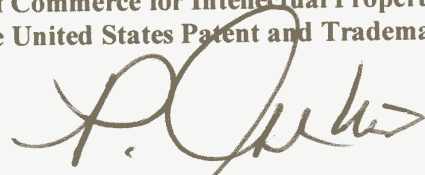

**P. SWAIN
Certifying Officer**

JOINT TRIAL EXHIBIT NO. 1044

United States District Court
Northern District of California
No. 11-CV-01846-LHK (PSG)

Apple Inc. v. Samsung Elecs.

Date Admitted: _____ By: _____



(12) **United States Patent**
Platzer et al.

(10) **Patent No.:** US 7,844,915 B2
(45) **Date of Patent:** Nov. 30, 2010

(54) **APPLICATION PROGRAMMING INTERFACES FOR SCROLLING OPERATIONS**

7,009,626 B2 3/2006 Anwar
7,088,374 B2 8/2006 David et al.
7,117,453 B2 10/2006 Drucker et al.
7,173,623 B2 2/2007 Calkins et al.
7,337,412 B2 2/2008 Guido et al.
7,346,850 B2 3/2008 Swartz et al.

(75) **Inventors:** Andrew Platzer, Santa Clara, CA (US);
Scott Herz, Santa Clara, CA (US)

(73) **Assignee:** Apple Inc., Cupertino, CA (US)

(*) **Notice:** Subject to any disclaimer, the term of this patent is extended or adjusted under 35 U.S.C. 154(b) by 583 days.

(Continued)

FOREIGN PATENT DOCUMENTS

(21) **Appl. No.:** 11/620,717

EP 1517228 3/2005

(22) **Filed:** Jan. 7, 2007

(65) **Prior Publication Data**
US 2008/0168384 A1 Jul. 10, 2008

(Continued)

OTHER PUBLICATIONS

(51) **Int. Cl.**
G06F 3/00 (2006.01)
G06F 3/033 (2006.01)
G06F 3/041 (2006.01)
G06F 3/048 (2006.01)

Toshiyuki Masui et al; "Elastic Graphical Interfaces for Precise Data Manipulation", 1995; ACM; pp. 143-144.*

(Continued)

(52) **U.S. Cl.** 715/781; 715/784; 715/800;
345/173

Primary Examiner—Xiomara L. Bautista
(74) *Attorney, Agent, or Firm*—Blakely, Sokoloff, Taylor & Zafman LLP

(58) **Field of Classification Search** 715/764,
715/765, 784, 786, 788, 800, 864, 866, 973,
715/974; 345/156, 157, 169, 173
See application file for complete search history.

(57) **ABSTRACT**

(56) **References Cited**

U.S. PATENT DOCUMENTS

5,534,893 A 7/1996 Hansen et al.
5,903,902 A 5/1999 Orr et al.
6,028,602 A 2/2000 Weidenfeller et al.
6,486,896 B1 11/2002 Ubillos
6,677,965 B1 * 1/2004 Ullmann et al. 715/786
6,741,996 B1 5/2004 Brechner et al.
6,839,721 B2 1/2005 Schwols
6,903,927 B2 6/2005 Anlauff
6,957,392 B2 10/2005 Simister et al.
6,958,749 B1 * 10/2005 Matsushita et al. 345/175

At least certain embodiments of the present disclosure include an environment with user interface software interacting with a software application. A method for operating through an application programming interface (API) in this environment includes transferring a set bounce call. The method further includes setting at least one of maximum and minimum bounce values. The set bounce call causes a bounce of a scrolled region in an opposite direction of a scroll based on a region past an edge of the scrolled region being visible in a display region at the end of the scroll.

21 Claims, 37 Drawing Sheets

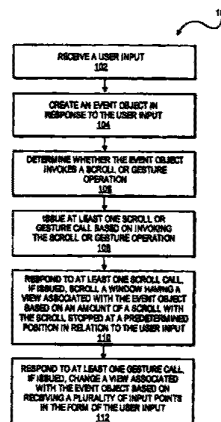

US 7,844,915 B2

Page 2

U.S. PATENT DOCUMENTS

7,561,159	B2	7/2009	Abel et al.	
7,576,732	B2 *	8/2009	Lii	345/173
2001/0045949	A1	11/2001	Chithambaram et al.	
2002/0194589	A1	12/2002	Cristofalo et al.	
2003/0095096	A1	5/2003	Robbin et al.	
2003/0122787	A1	7/2003	Zimmerman et al.	
2003/0132959	A1	7/2003	Simister et al.	
2003/0160832	A1	8/2003	Ridgley et al.	
2003/0174149	A1	9/2003	Fujisaki et al.	
2004/0021676	A1	2/2004	Chen et al.	
2004/0021698	A1	2/2004	Baldwin et al.	
2004/0100479	A1	5/2004	Nakano et al.	
2004/0215643	A1	10/2004	Brechner et al.	
2004/0222992	A1	11/2004	Calkins et al.	
2004/0224638	A1	11/2004	Fadell et al.	
2005/0057524	A1 *	3/2005	Hill et al.	345/173
2005/0088443	A1	4/2005	Blanco et al.	
2005/0193015	A1	9/2005	Logston et al.	
2006/0038796	A1 *	2/2006	Hinckley et al.	345/173
2006/0190833	A1	8/2006	SanGiovanni et al.	
2006/0236263	A1 *	10/2006	Bathiche et al.	715/786
2007/0055967	A1	3/2007	Poff et al.	
2007/0075965	A1	4/2007	Huppi et al.	
2007/0174257	A1	7/2007	Howard	
2007/0185876	A1	8/2007	Mendis et al.	
2007/0252821	A1 *	11/2007	Hollemans et al.	345/173
2007/0288856	A1	12/2007	Butlin et al.	
2008/0005703	A1 *	1/2008	Radivojevic et al.	715/863
2008/0016096	A1	1/2008	Wilding et al.	
2008/0034029	A1	2/2008	Fang et al.	
2008/0048978	A1 *	2/2008	Trent et al.	345/157
2008/0168395	A1 *	7/2008	Ording et al.	715/833
2008/0231610	A1 *	9/2008	Hotelling et al.	345/173
2009/0259969	A1 *	10/2009	Pallakoff	715/808

FOREIGN PATENT DOCUMENTS

GB	2 319 591 A	5/1998
GB	2319591 A *	5/1998

WO	WO-2006/067711	6/2006
WO	WO 2008/085848 A1 *	7/2008
WO	WO 2008/085877 A1 *	7/2008
WO	WO-2008085848	7/2008
WO	WO-2008085877	7/2008

OTHER PUBLICATIONS

Office Action, U.S. Appl. No. 11/620,723, mailed Apr. 1, 2009, 8 pages.
 Office Action, U.S. Appl. No. 11/620,709, mailed Apr. 1, 2009, 8 pages.
 Office Action, U.S. Appl. No. 11/620,720, mailed Jun. 23, 2009, 17 pages.
 Office Action, U.S. Appl. No. 11/620,720, mailed Dec. 23, 2008, 18 pages.
 PCT International Search Report and Written Opinion for PCT International Appln. No. US2008/000058, mailed Jul. 31, 2008 (10 pages).
 PCT International Search Report and Written Opinion for PCT International Appln. No. US2008/000089, mailed Apr. 6, 2008 (14 pages).
 PCT International Search Report and Written Opinion for PCT International Appln. No. PCT/US2008/000103, mailed Jun. 3, 2008 (15 pages).
 PCT International Search Report and Written Opinion for PCT International Appln. No. PCT/US2008/000069, mailed May 2, 2008 (16 pages).
 PCT International Search Report and Written Opinion for PCT International Appln. No. PCT/US2008/000060, mailed Apr. 22, 2008 (12 pages).
 Office Action, U.S. Appl. No. 11/620,723, mailed Jun. 8, 2010, 7 pages.
 Office Action, U.S. Appl. No. 11/620,709, mailed Jun. 9, 2010, 7 pages.
 Final Office Action, U.S. Appl. No. 11/620,709 mailed Nov. 13, 2009, 8 pages.
 Final Office Action, U.S. Appl. No. 11/620,723, mailed Nov. 17, 2009., 10 pages.
 Office Action, U.S. Appl. No. 11/620,720 mailed Nov. 18, 2009, 17 pages.

* cited by examiner

U.S. Patent

Nov. 30, 2010

Sheet 1 of 37

US 7,844,915 B2

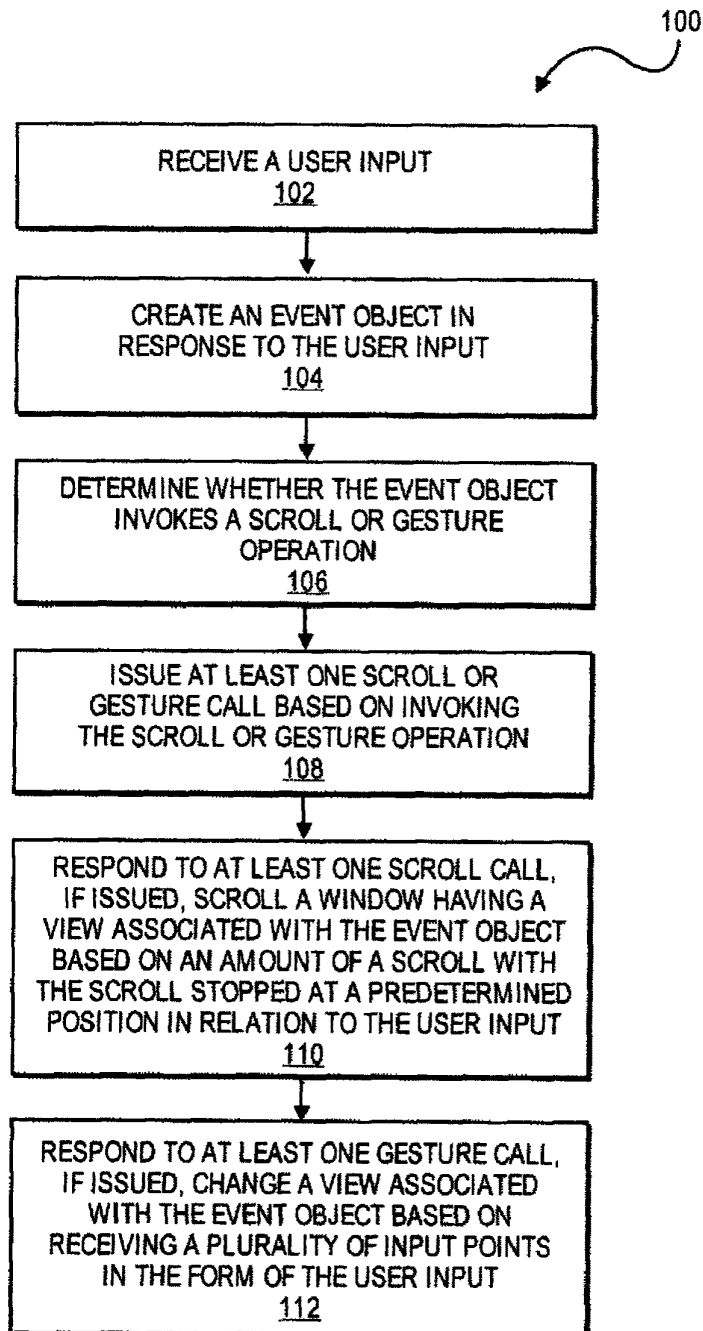

FIG. 1

U.S. Patent

Nov. 30, 2010

Sheet 2 of 37

US 7,844,915 B2

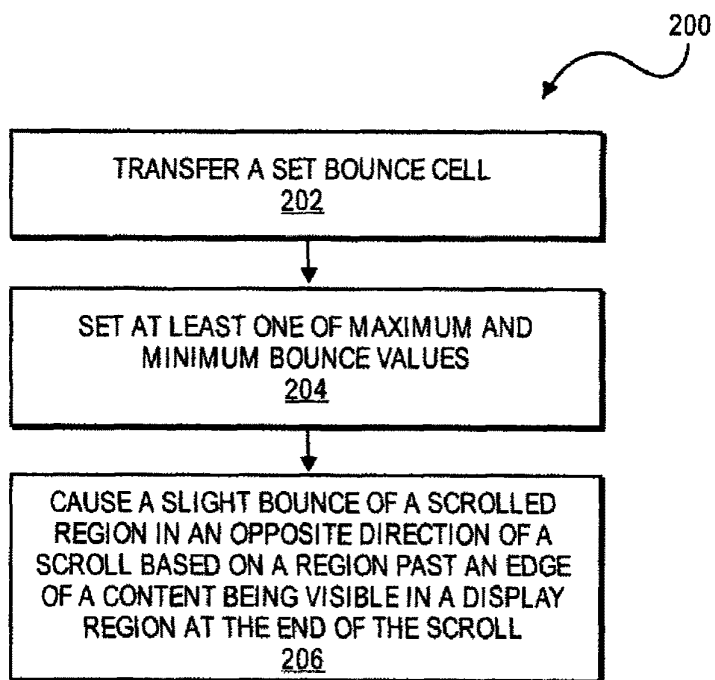

FIG. 2

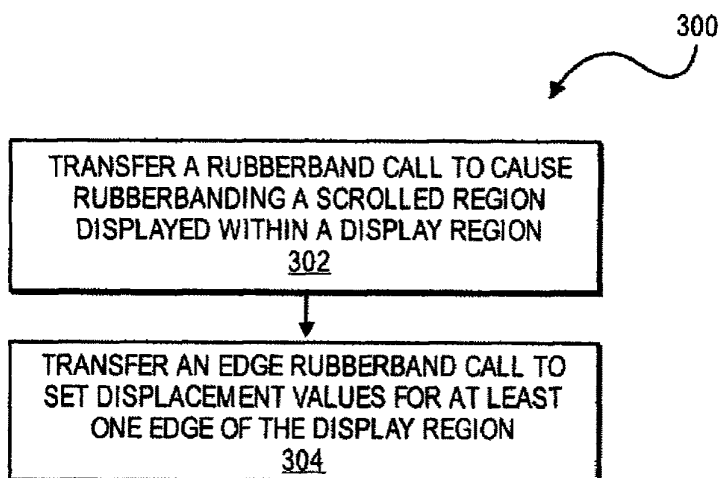

FIG. 3

U.S. Patent

Nov. 30, 2010

Sheet 3 of 37

US 7,844,915 B2

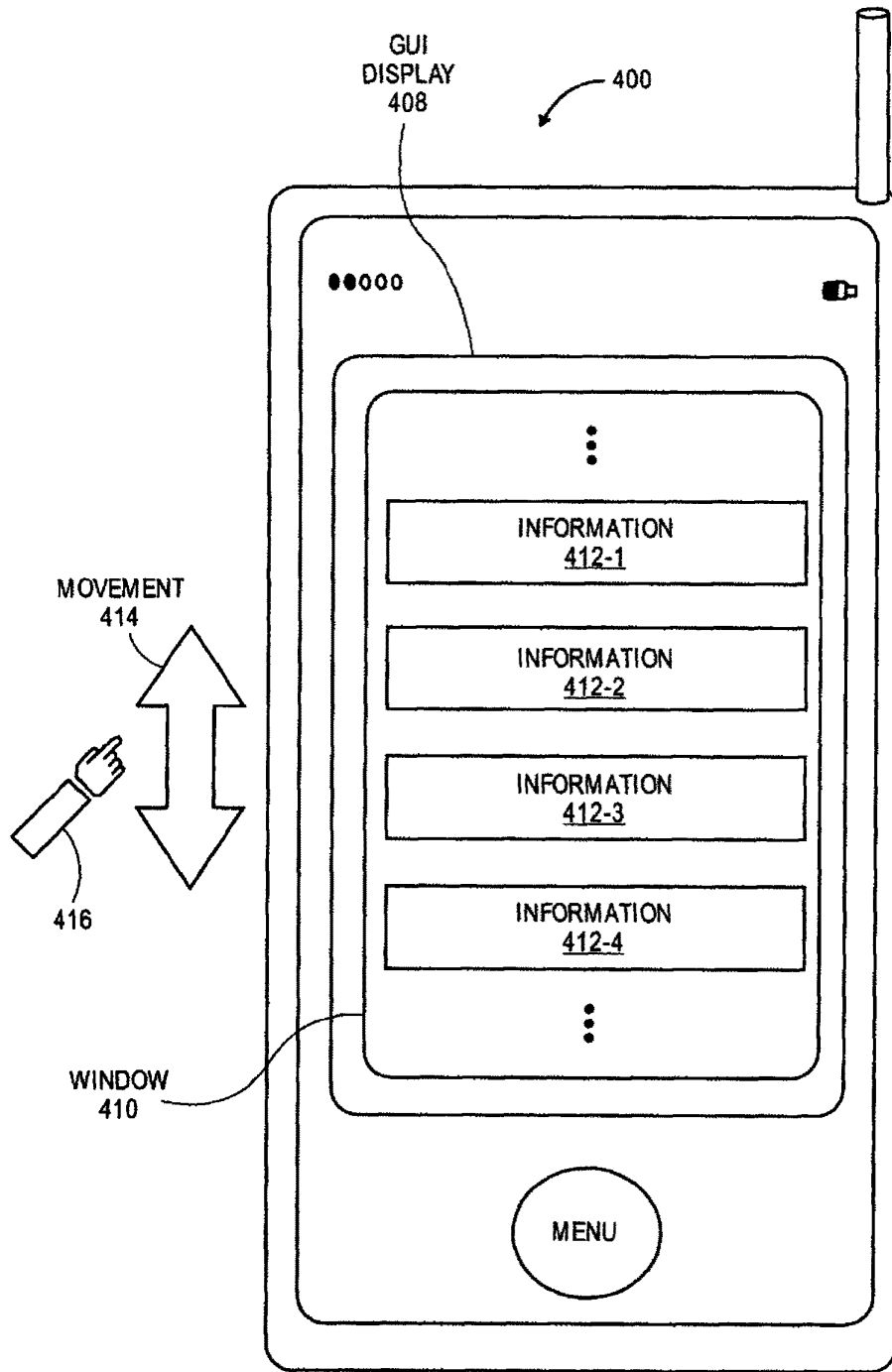

FIG. 4

U.S. Patent

Nov. 30, 2010

Sheet 4 of 37

US 7,844,915 B2

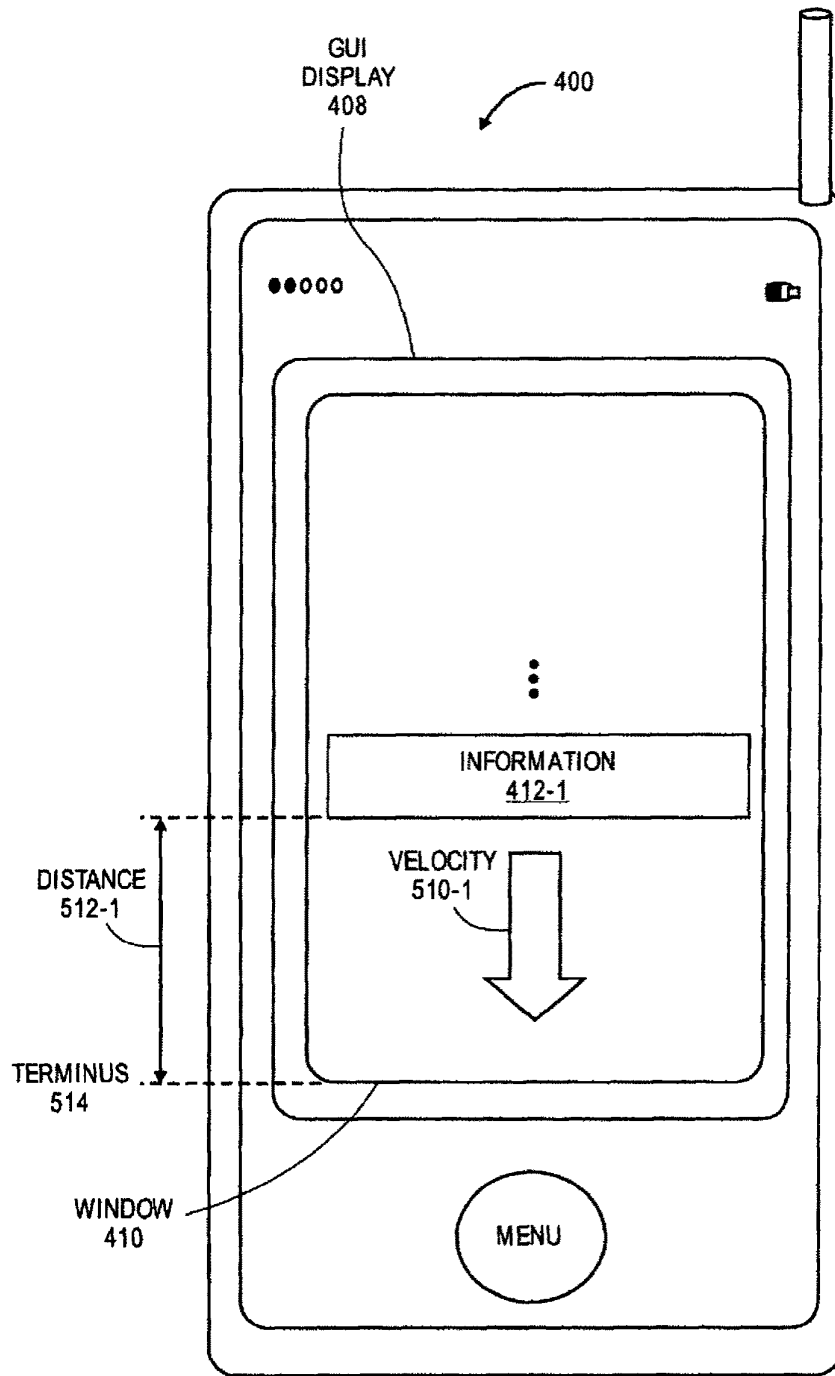

FIG. 5A

U.S. Patent

Nov. 30, 2010

Sheet 5 of 37

US 7,844,915 B2

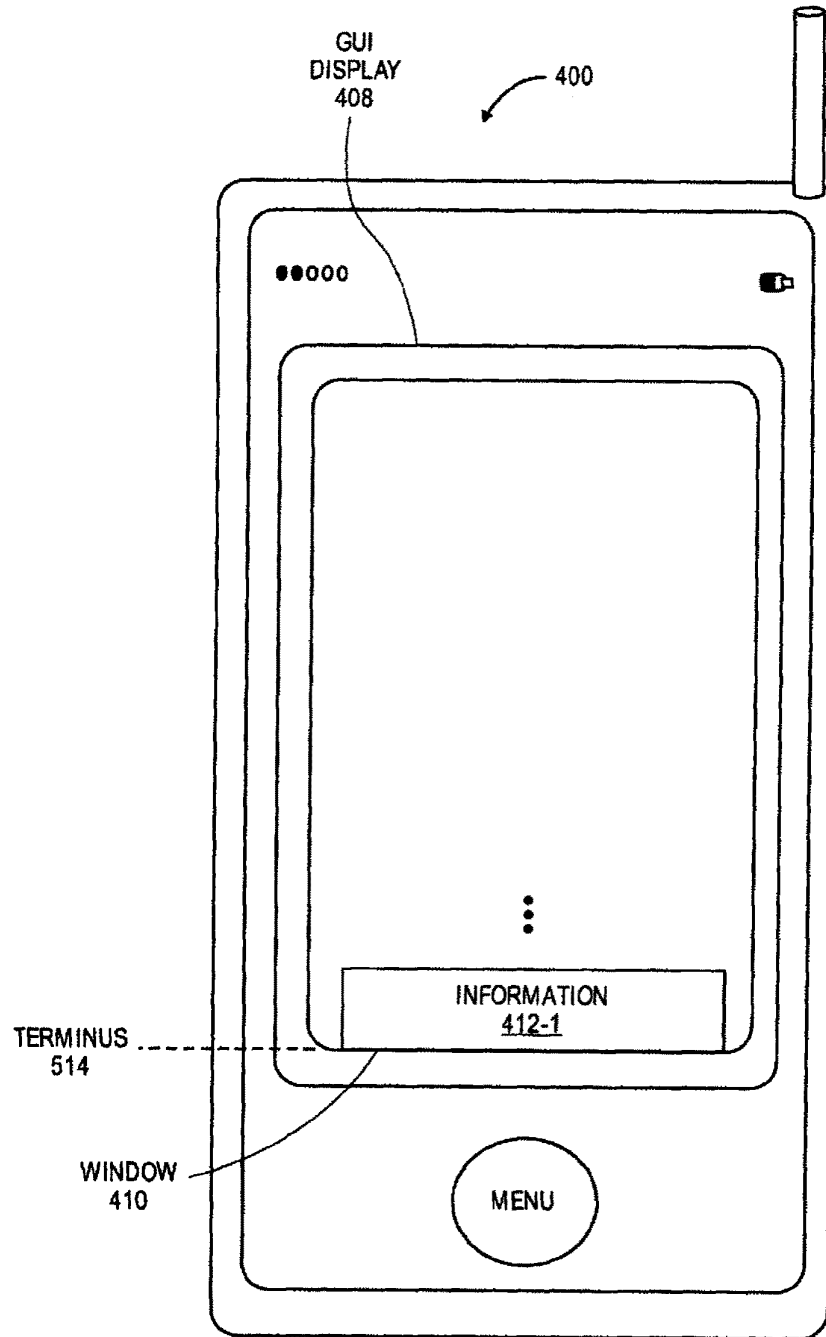

FIG. 5B

U.S. Patent

Nov. 30, 2010

Sheet 6 of 37

US 7,844,915 B2

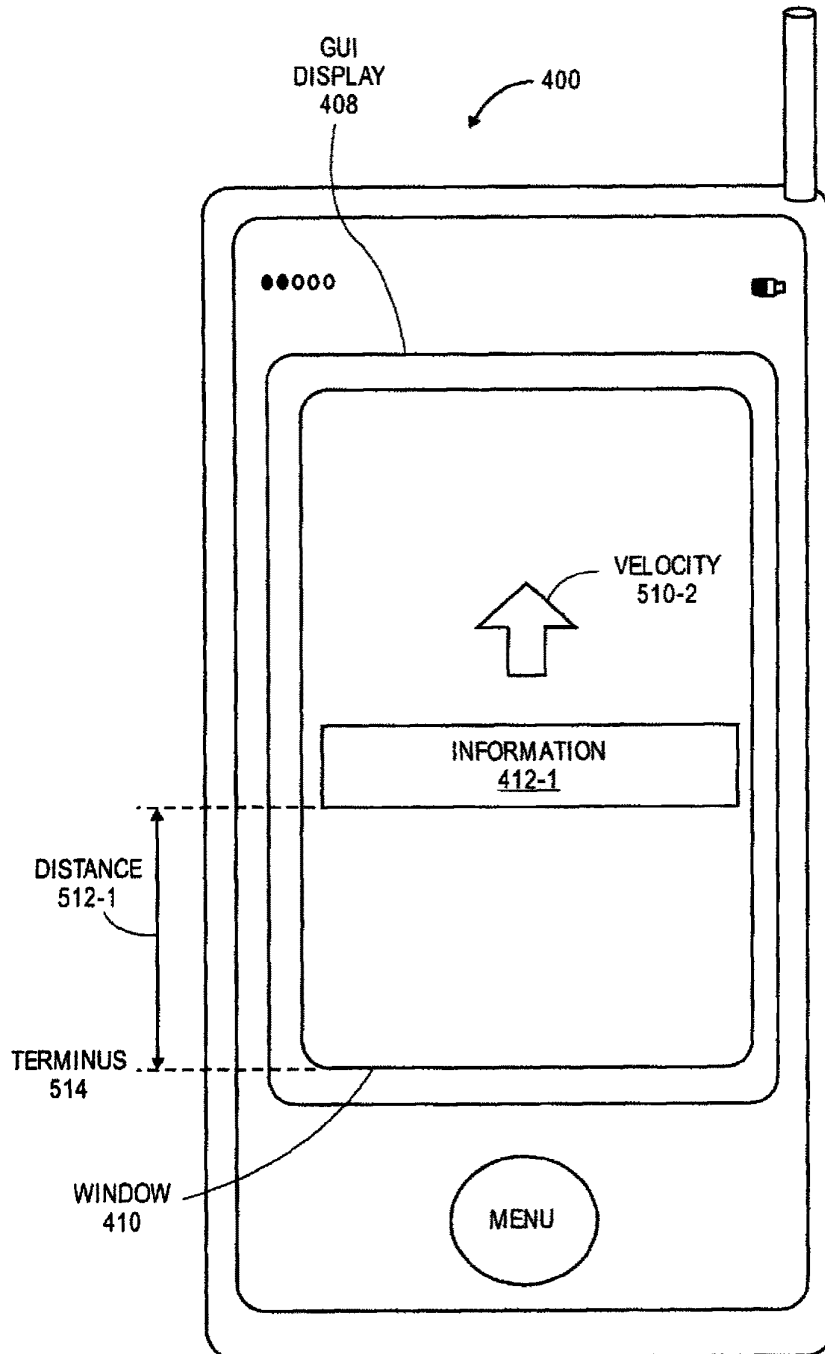

FIG. 5C

U.S. Patent

Nov. 30, 2010

Sheet 7 of 37

US 7,844,915 B2

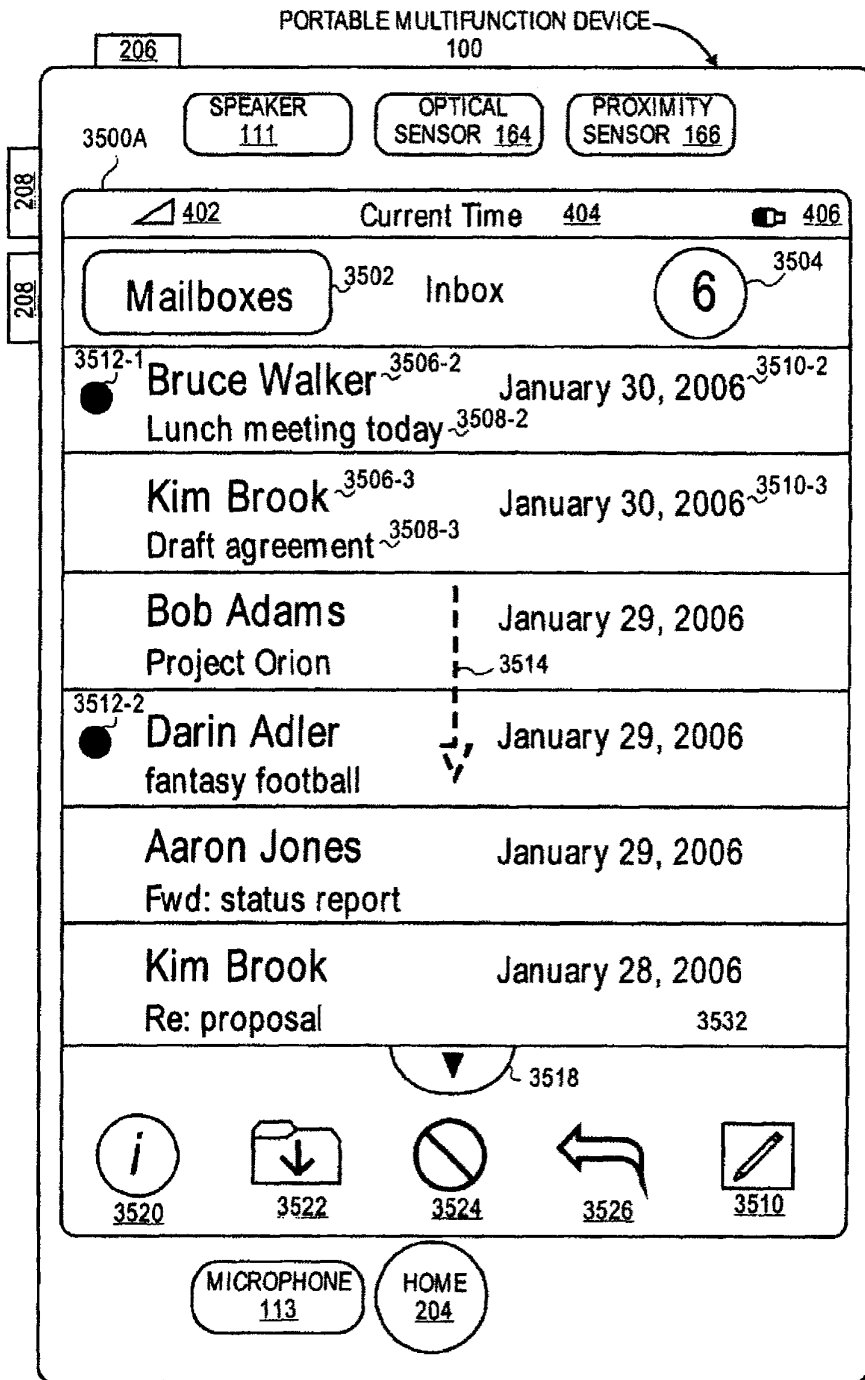

FIG. 6A

U.S. Patent

Nov. 30, 2010

Sheet 8 of 37

US 7,844,915 B2

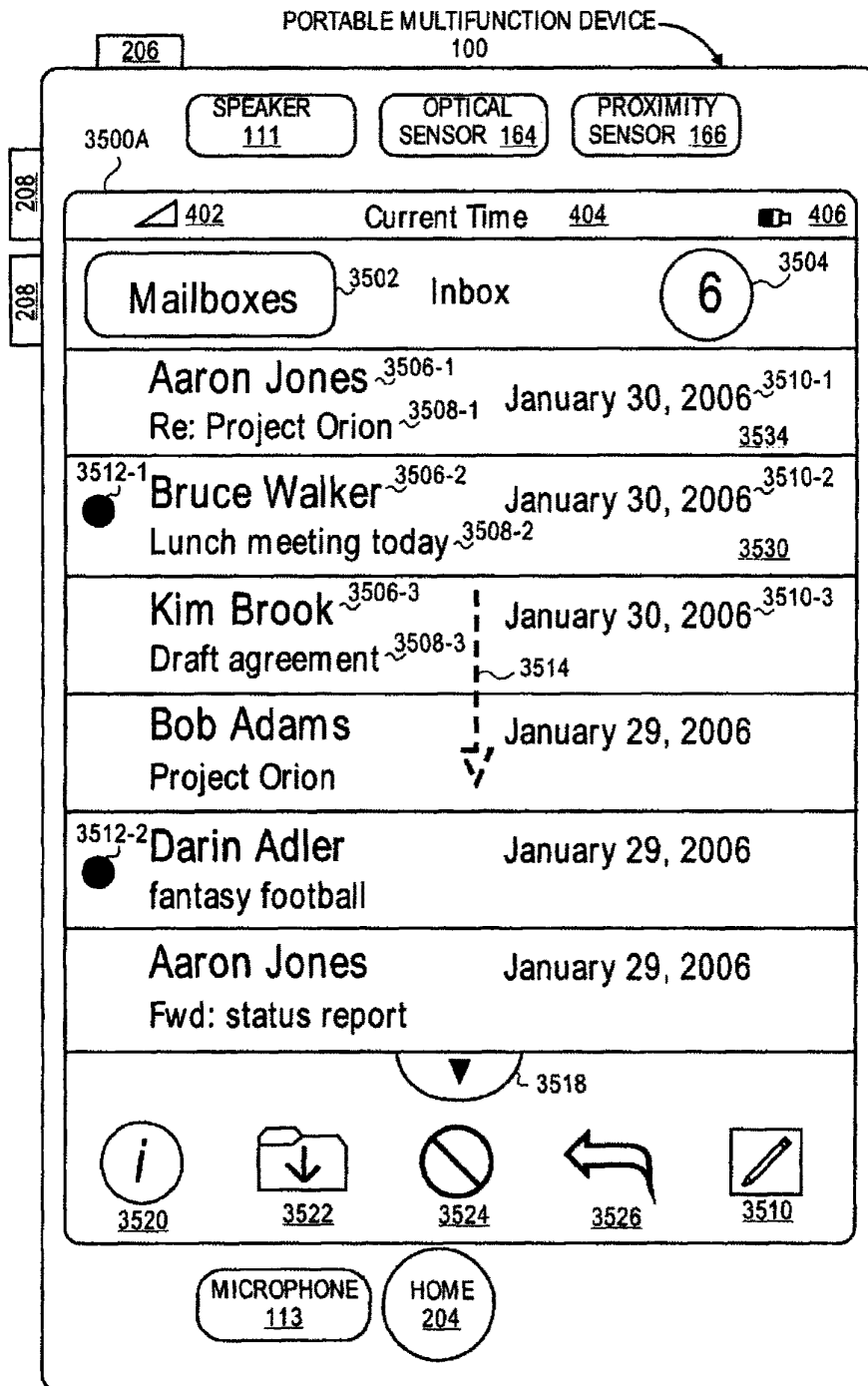

FIG. 6B

U.S. Patent

Nov. 30, 2010

Sheet 9 of 37

US 7,844,915 B2

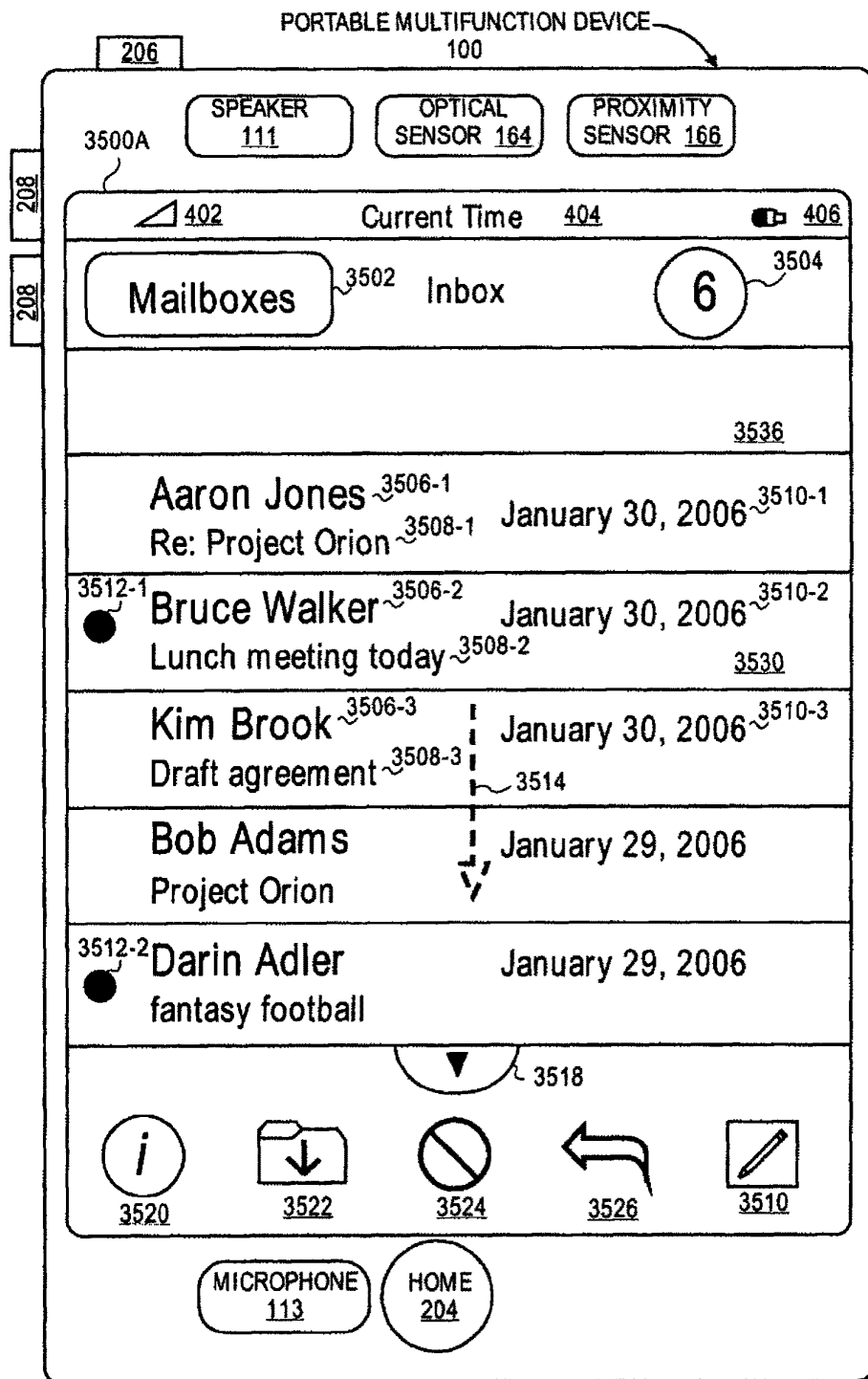

FIG. 6C

U.S. Patent

Nov. 30, 2010

Sheet 10 of 37

US 7,844,915 B2

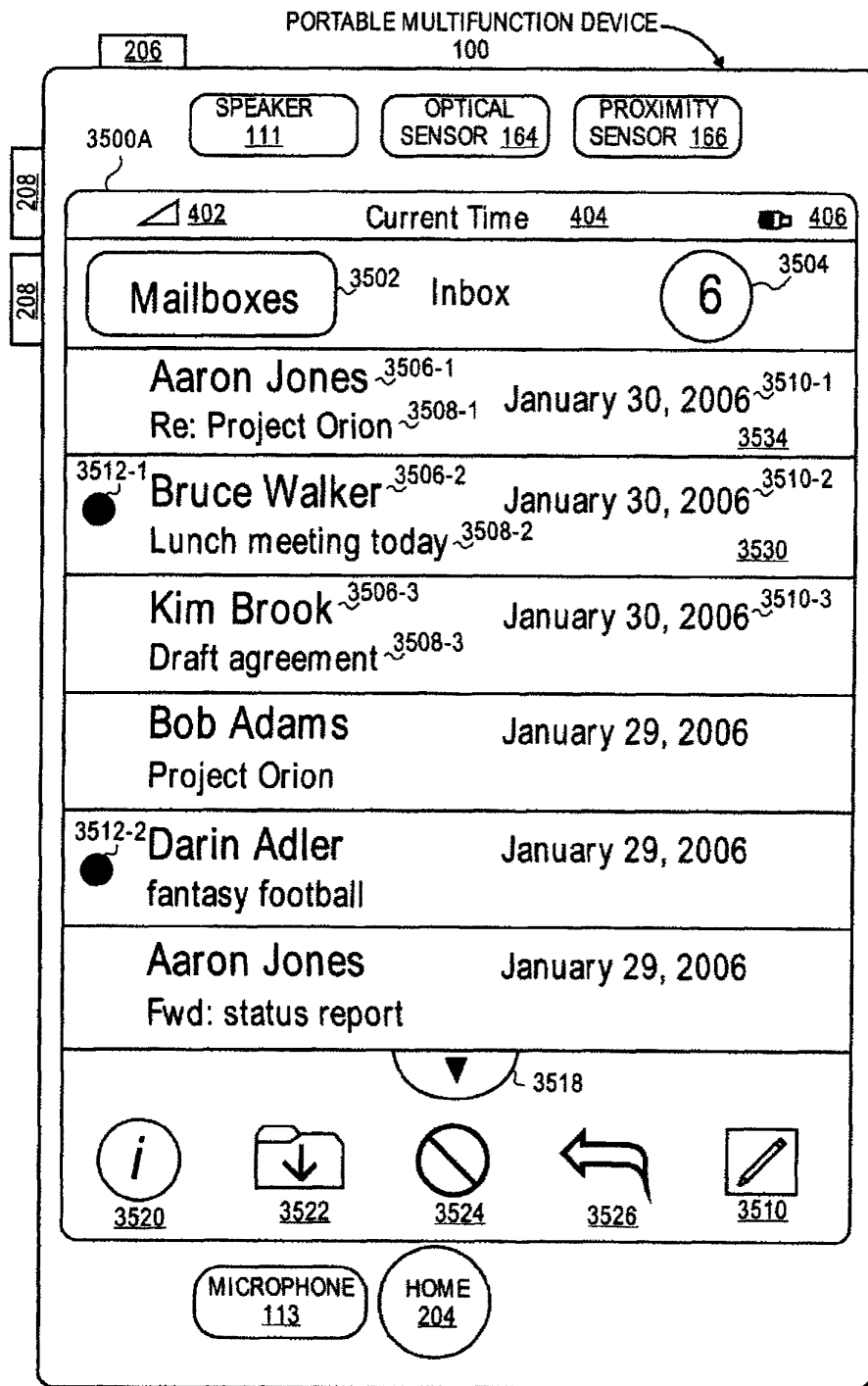

FIG. 6D

U.S. Patent

Nov. 30, 2010

Sheet 11 of 37

US 7,844,915 B2

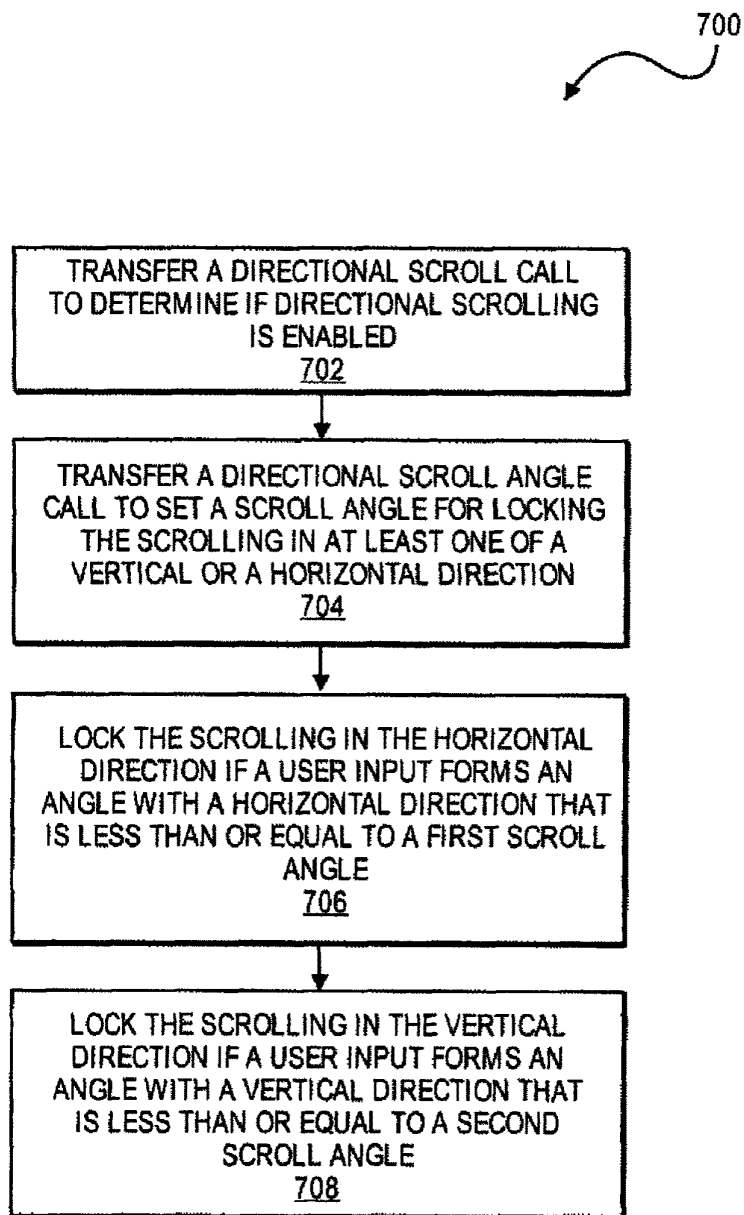

FIG. 7

U.S. Patent

Nov. 30, 2010

Sheet 12 of 37

US 7,844,915 B2

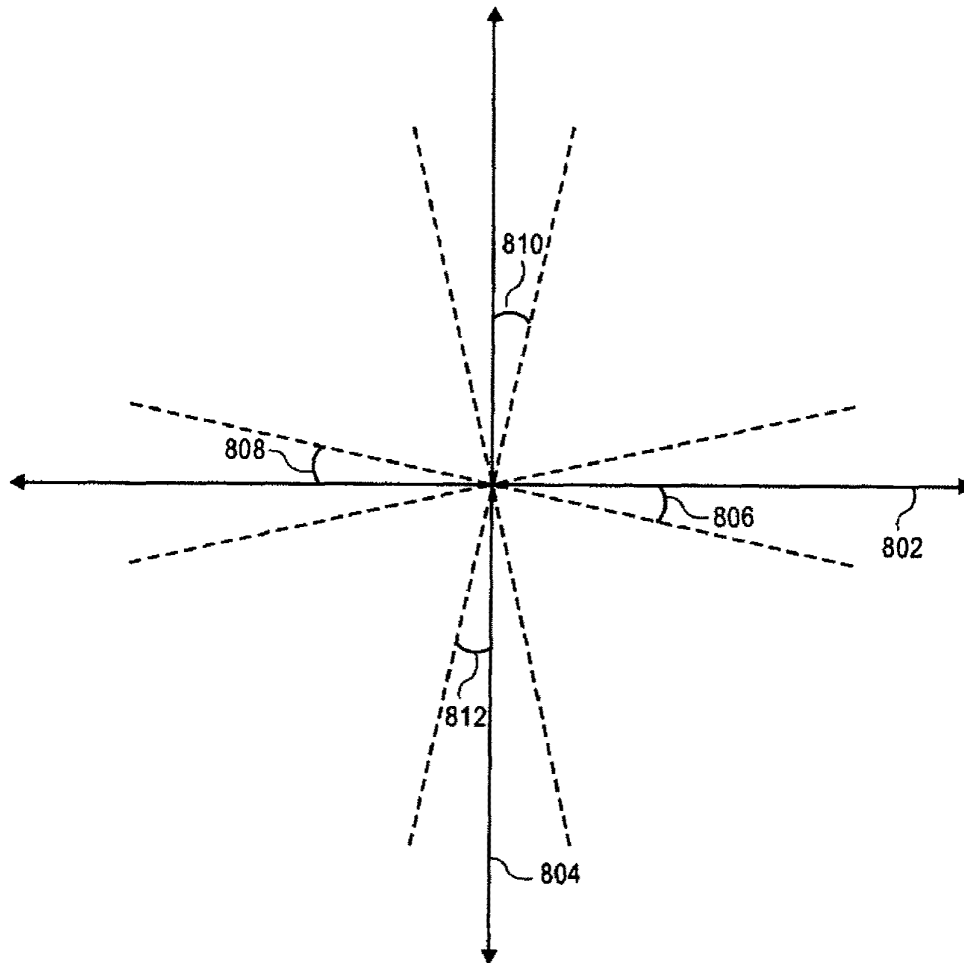

FIG. 8

U.S. Patent

Nov. 30, 2010

Sheet 13 of 37

US 7,844,915 B2

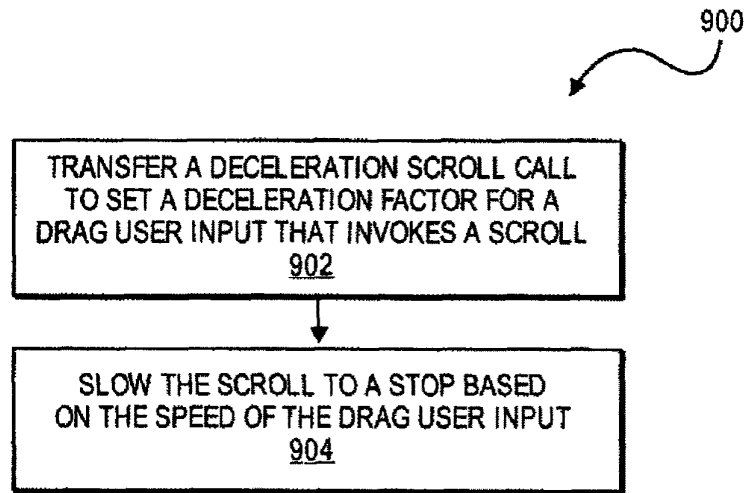

FIG. 9

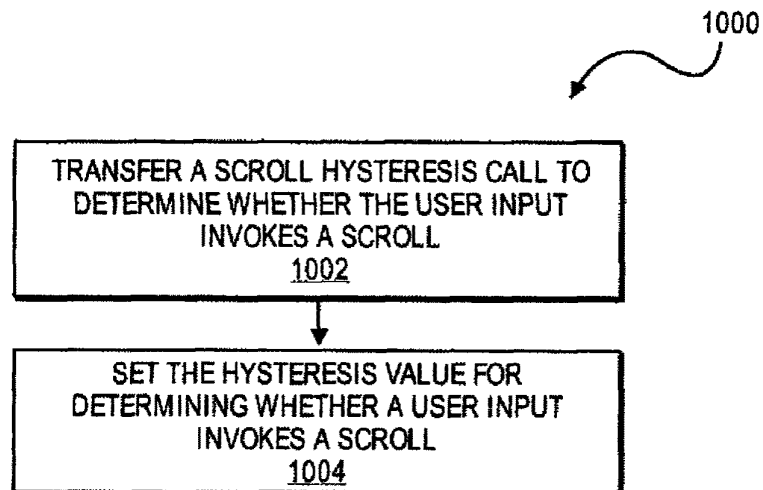

FIG. 10

U.S. Patent

Nov. 30, 2010

Sheet 14 of 37

US 7,844,915 B2

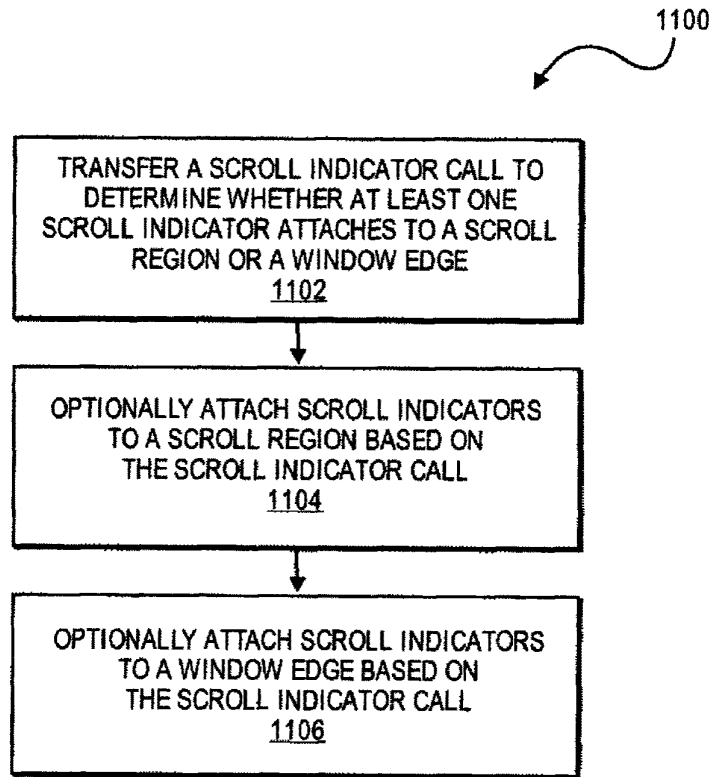

FIG. 11

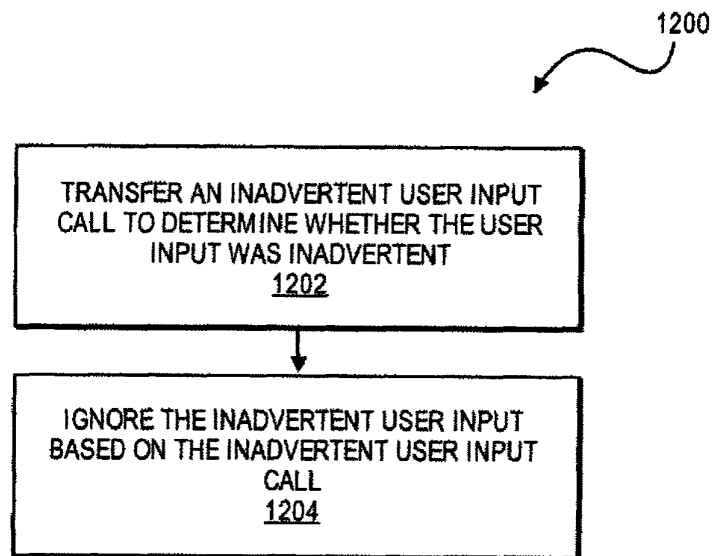

FIG. 12

U.S. Patent

Nov. 30, 2010

Sheet 15 of 37

US 7,844,915 B2

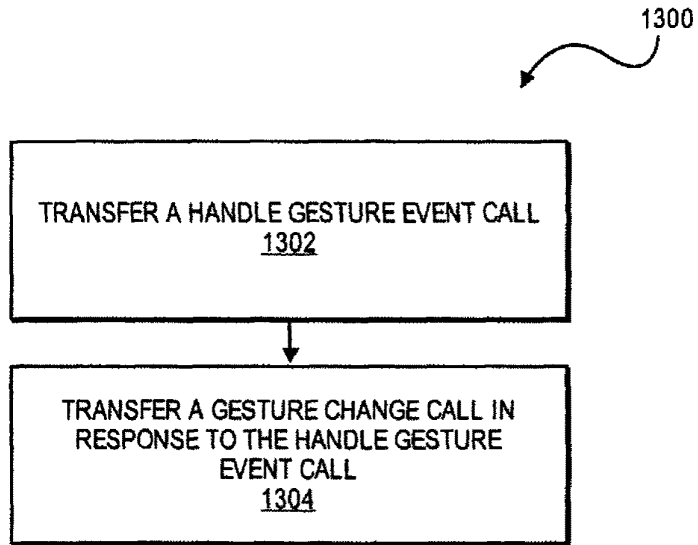

FIG. 13

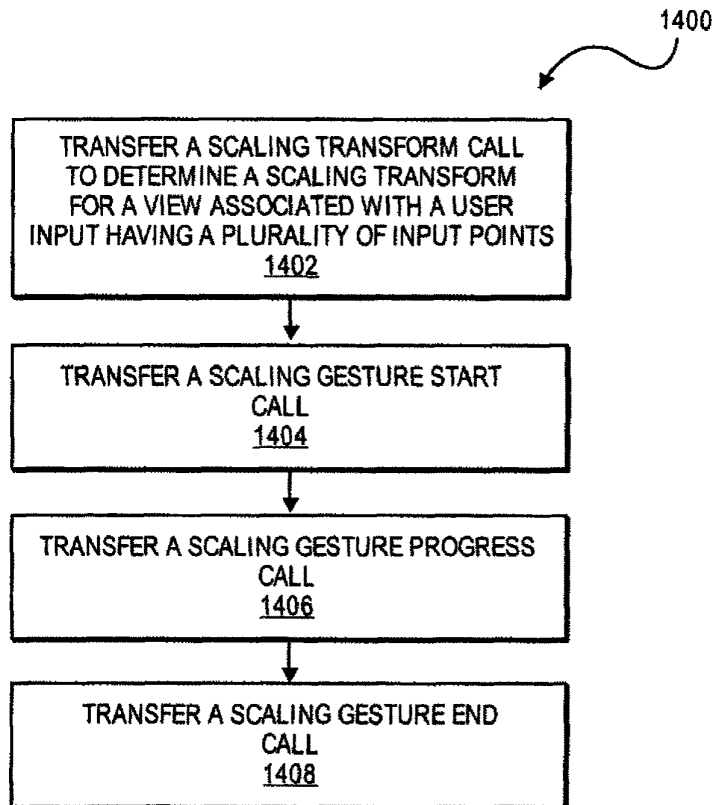

FIG. 14

U.S. Patent

Nov. 30, 2010

Sheet 16 of 37

US 7,844,915 B2

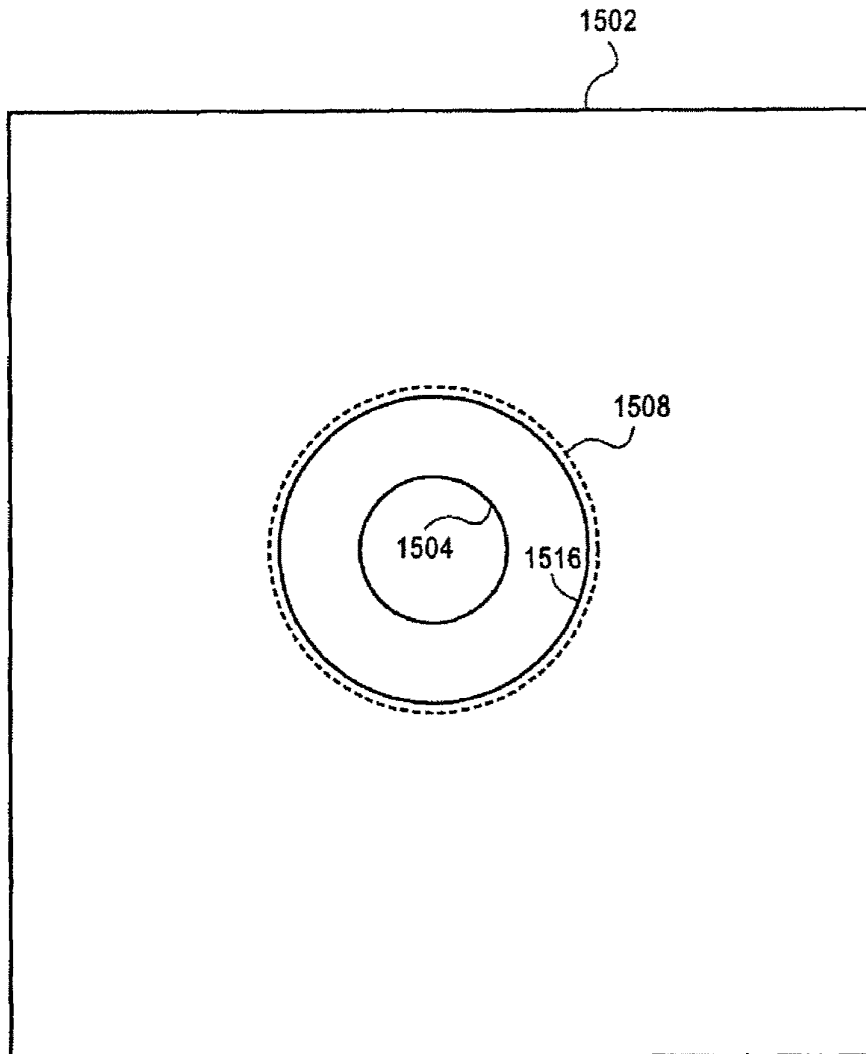
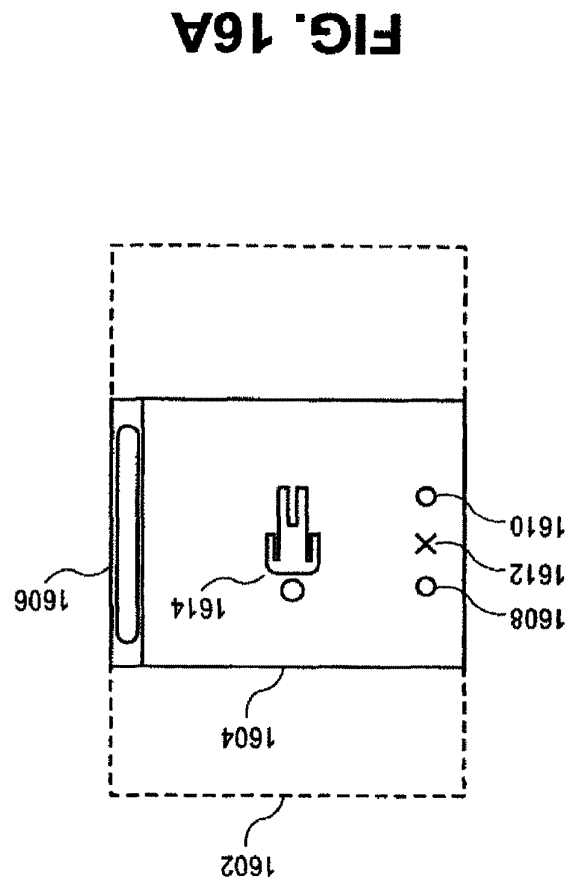
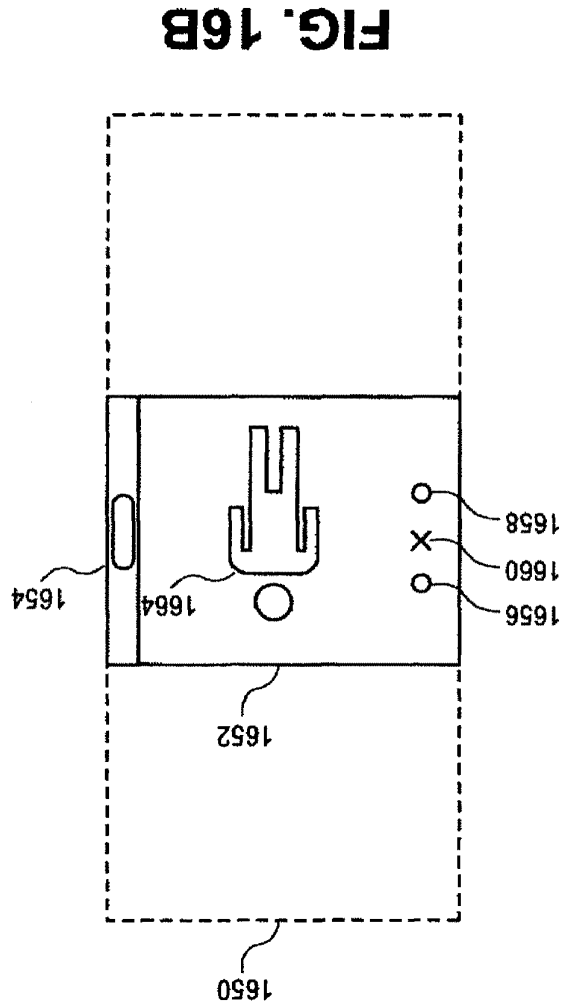

FIG. 15



U.S. Patent

Nov. 30, 2010

Sheet 18 of 37

US 7,844,915 B2

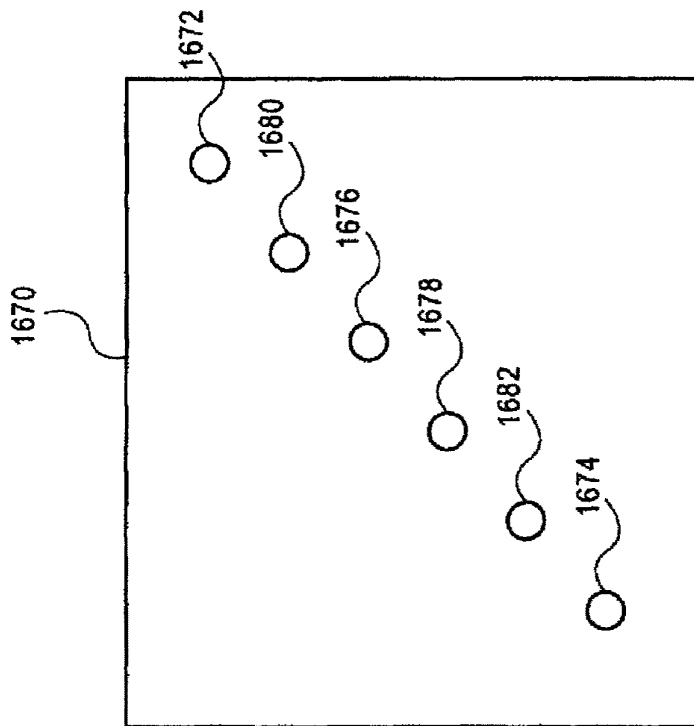

FIG. 16C

U.S. Patent

Nov. 30, 2010

Sheet 19 of 37

US 7,844,915 B2

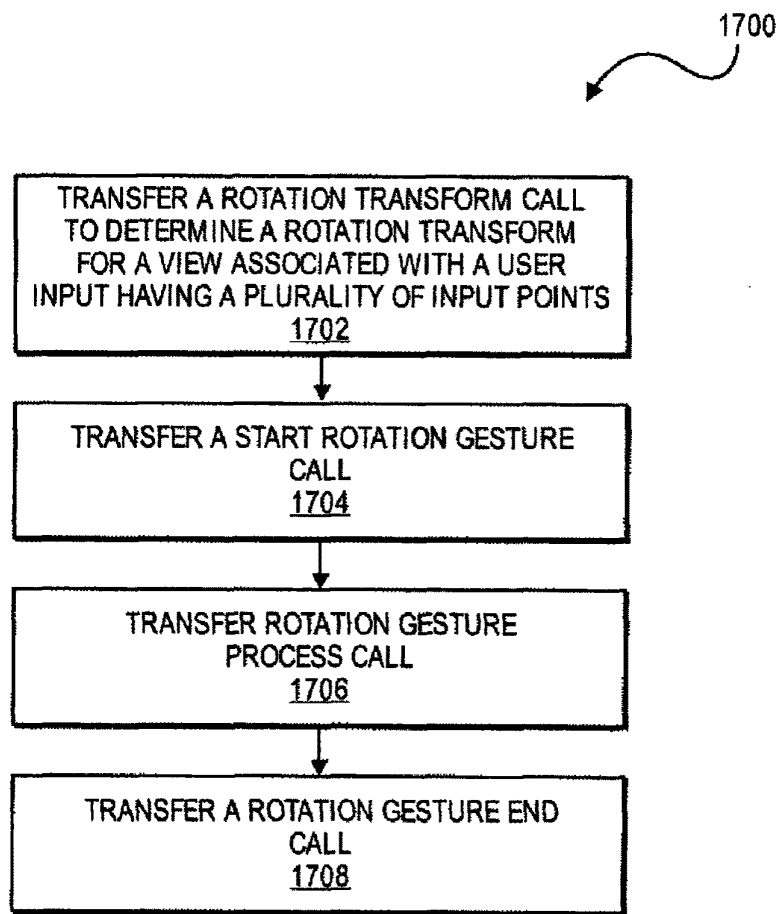

FIG. 17

U.S. Patent

Nov. 30, 2010

Sheet 20 of 37

US 7,844,915 B2

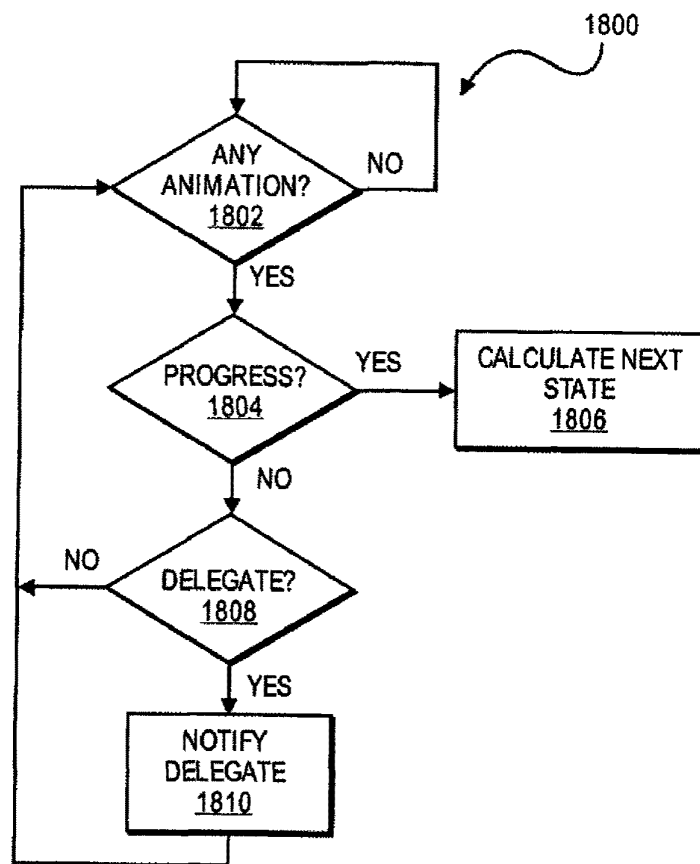

FIG. 18

U.S. Patent

Nov. 30, 2010

Sheet 21 of 37

US 7,844,915 B2

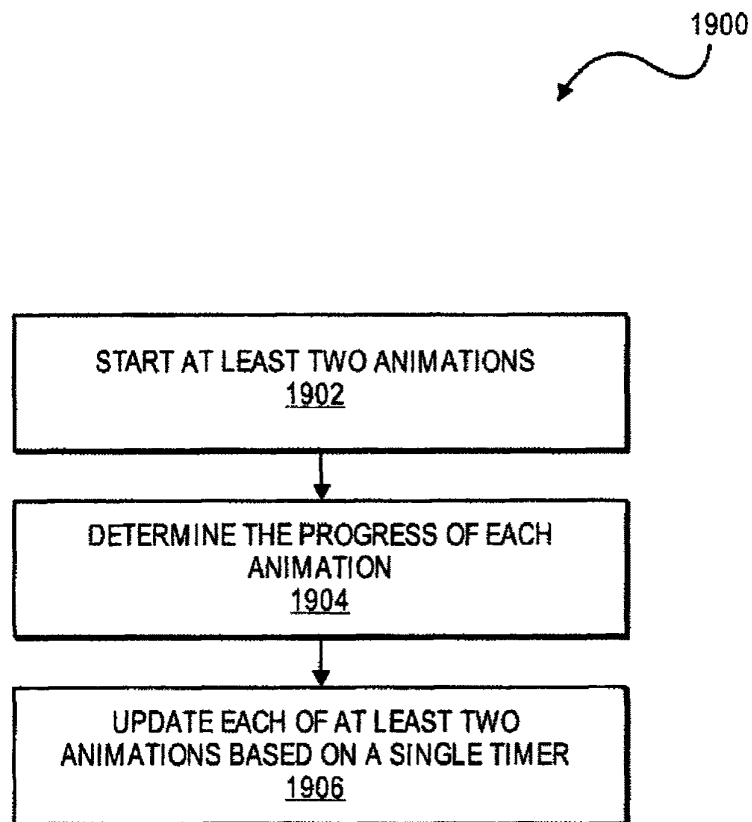

FIG. 19

U.S. Patent

Nov. 30, 2010

Sheet 22 of 37

US 7,844,915 B2

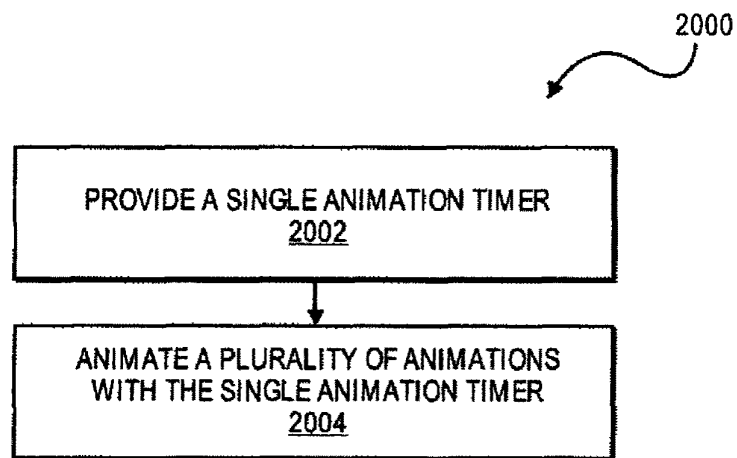

FIG. 20

U.S. Patent

Nov. 30, 2010

Sheet 23 of 37

US 7,844,915 B2

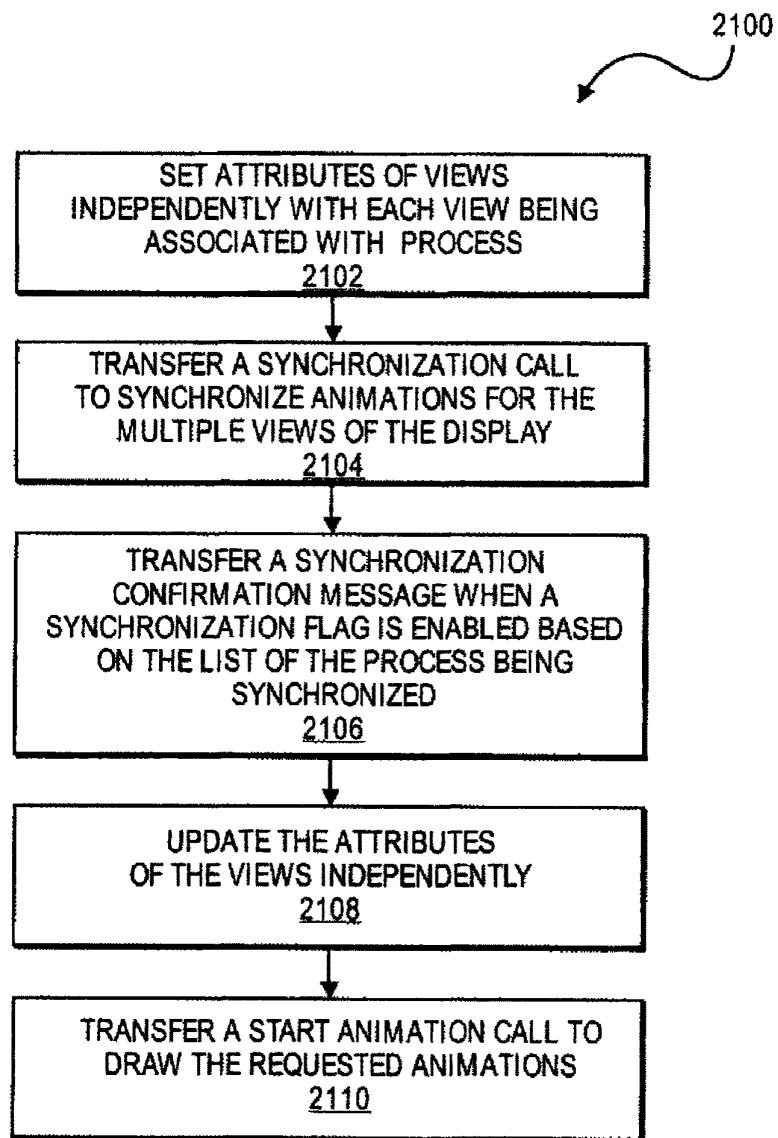

FIG. 21

U.S. Patent

Nov. 30, 2010

Sheet 24 of 37

US 7,844,915 B2

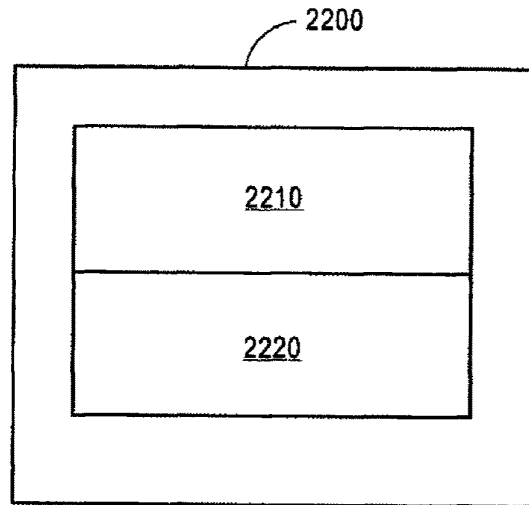

FIG. 22A

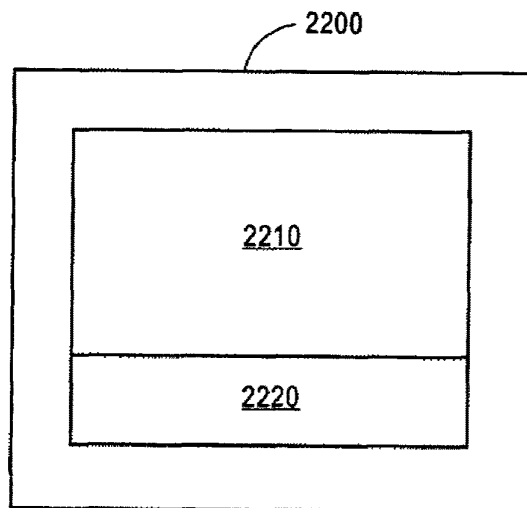

FIG. 22B

U.S. Patent

Nov. 30, 2010

Sheet 25 of 37

US 7,844,915 B2

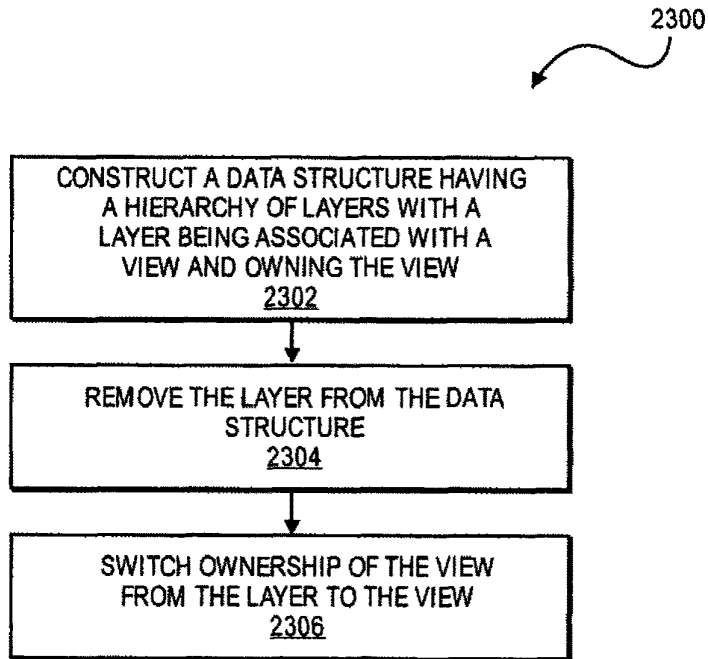

FIG. 23

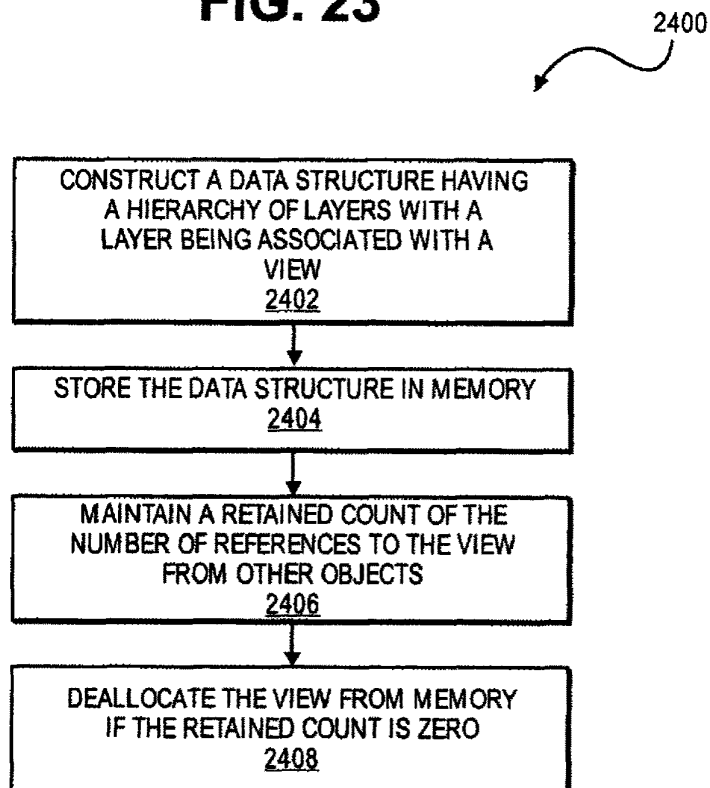

FIG. 24

U.S. Patent

Nov. 30, 2010

Sheet 26 of 37

US 7,844,915 B2

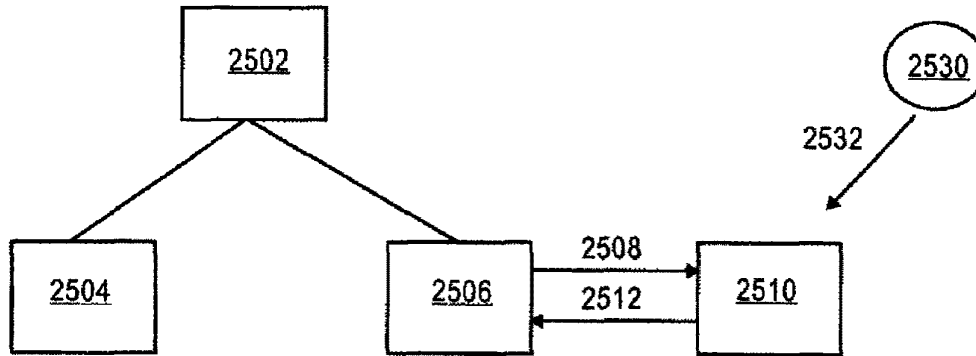

FIG. 25A

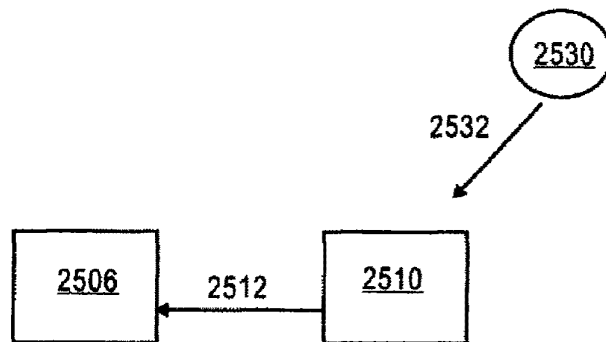

FIG. 25B

U.S. Patent

Nov. 30, 2010

Sheet 27 of 37

US 7,844,915 B2

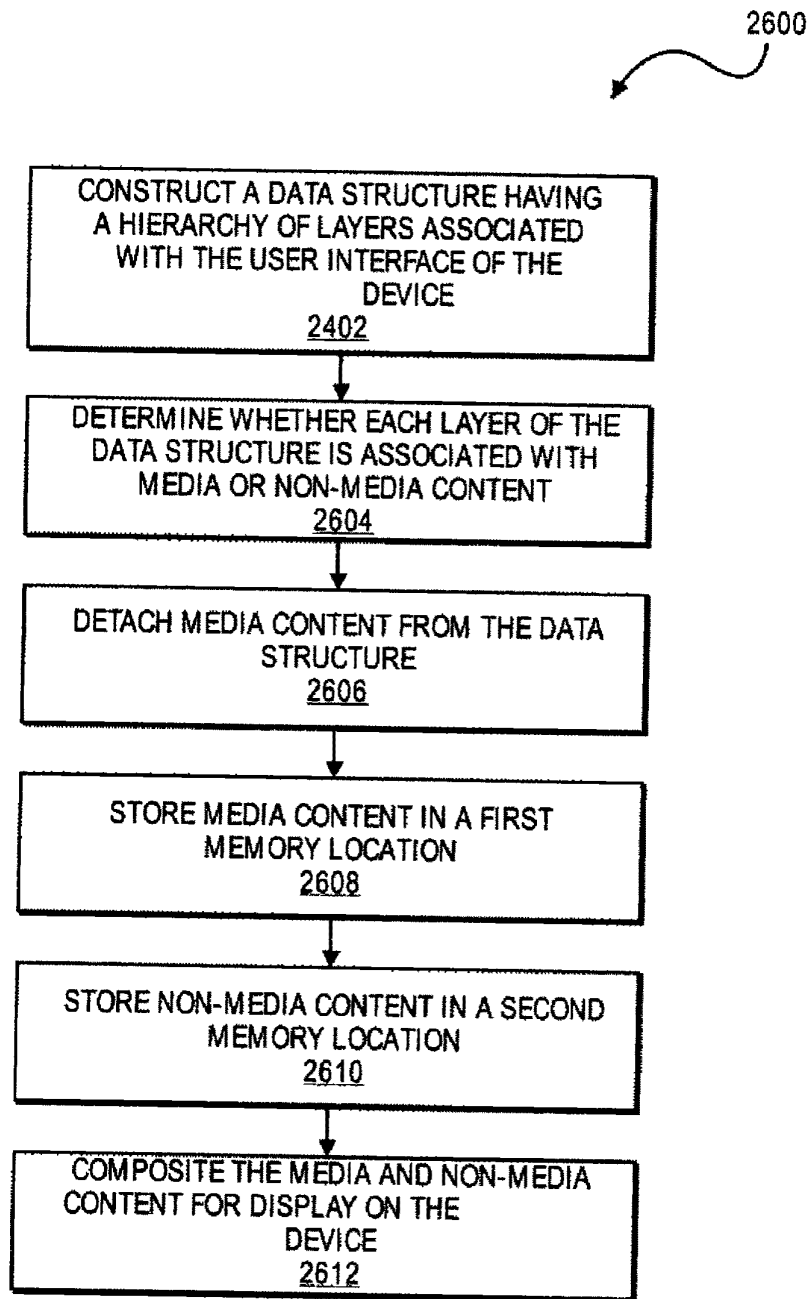

FIG. 26

U.S. Patent

Nov. 30, 2010

Sheet 28 of 37

US 7,844,915 B2

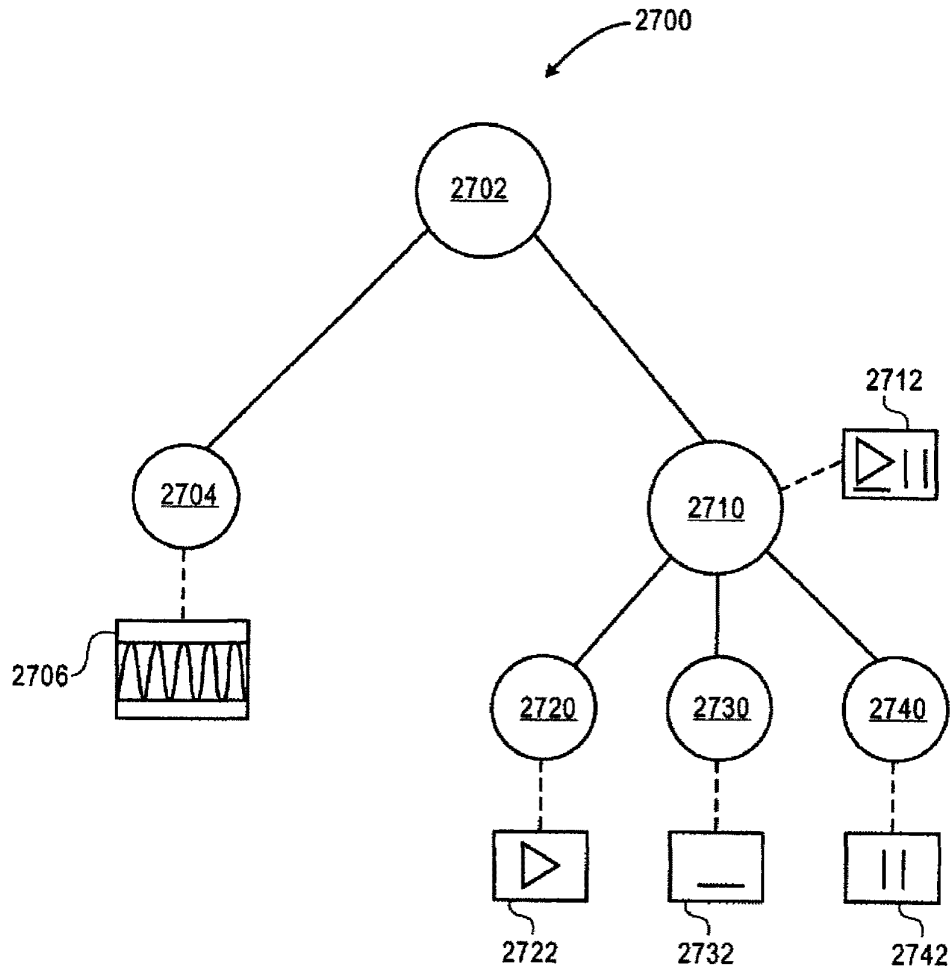

FIG. 27

U.S. Patent

Nov. 30, 2010

Sheet 29 of 37

US 7,844,915 B2

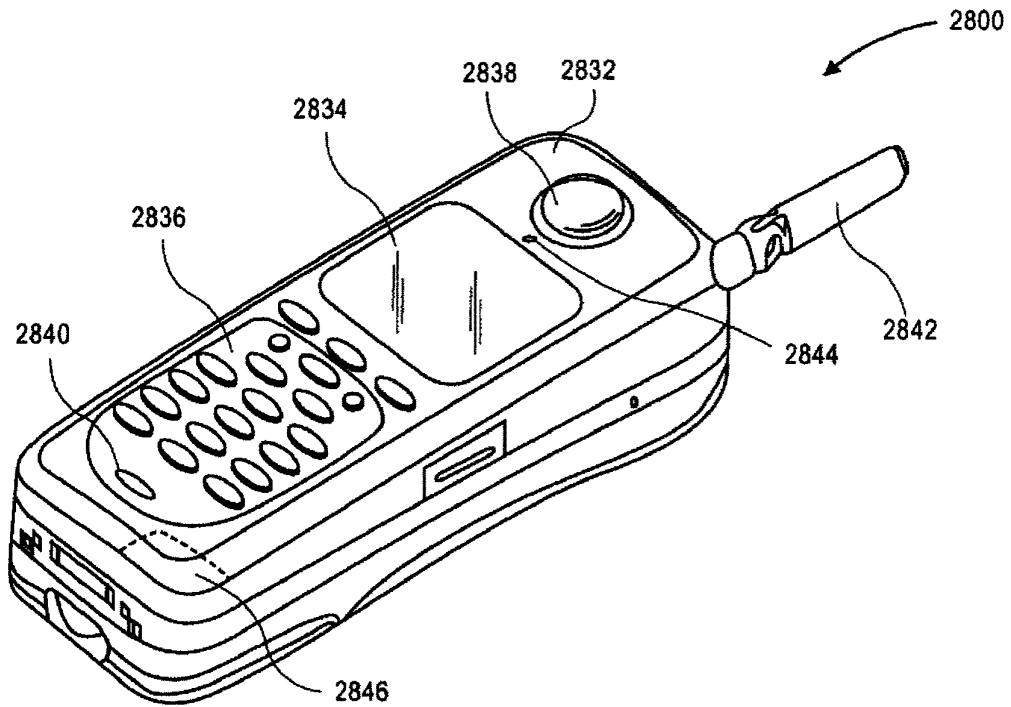

FIG. 28

U.S. Patent

Nov. 30, 2010

Sheet 30 of 37

US 7,844,915 B2

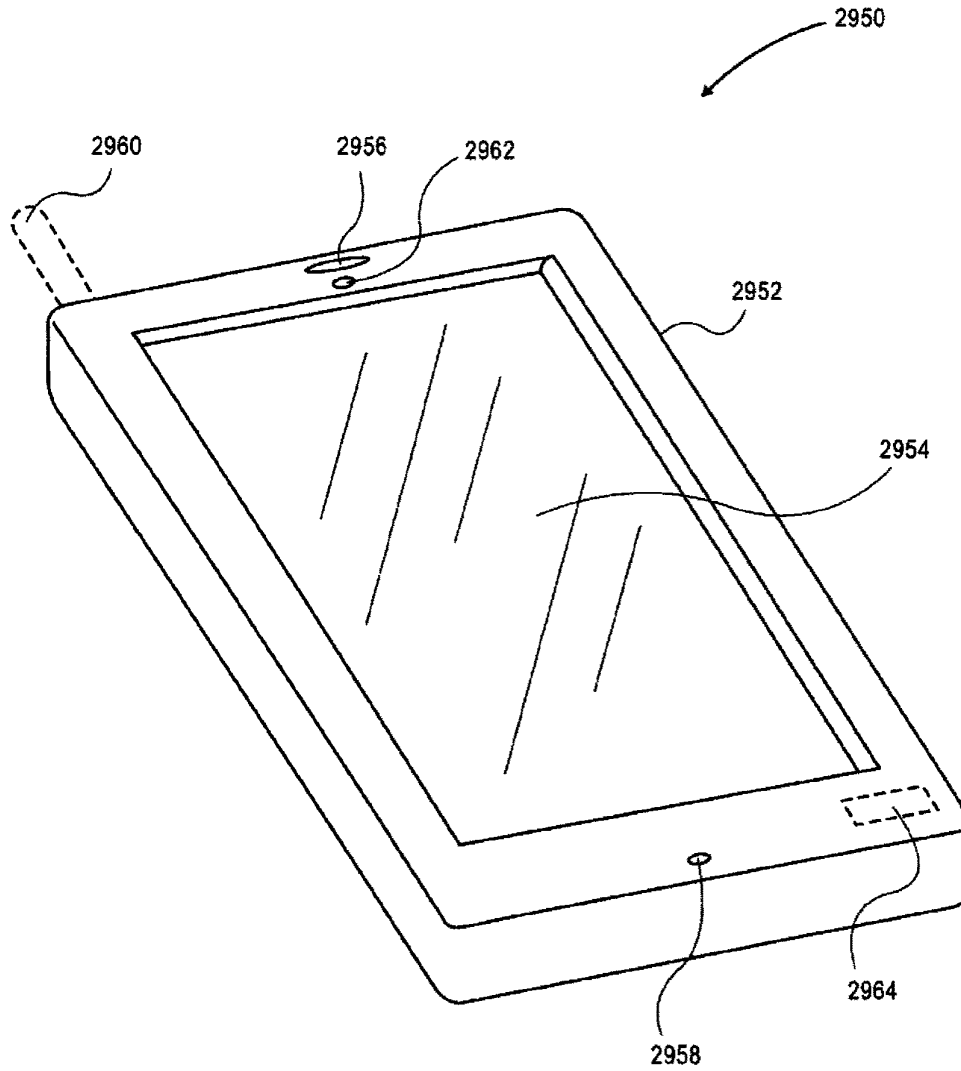

FIG. 29

U.S. Patent

Nov. 30, 2010

Sheet 31 of 37

US 7,844,915 B2

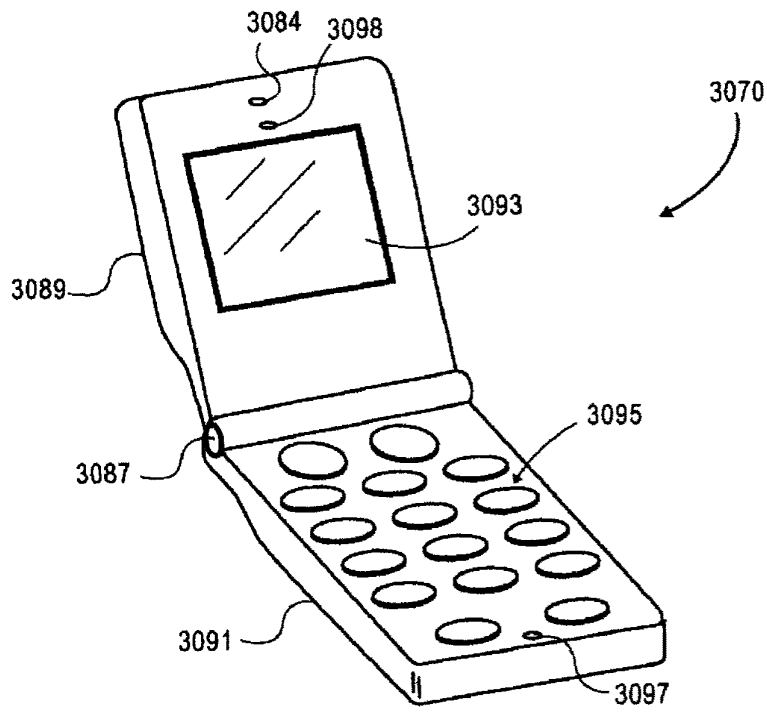

FIG. 30A

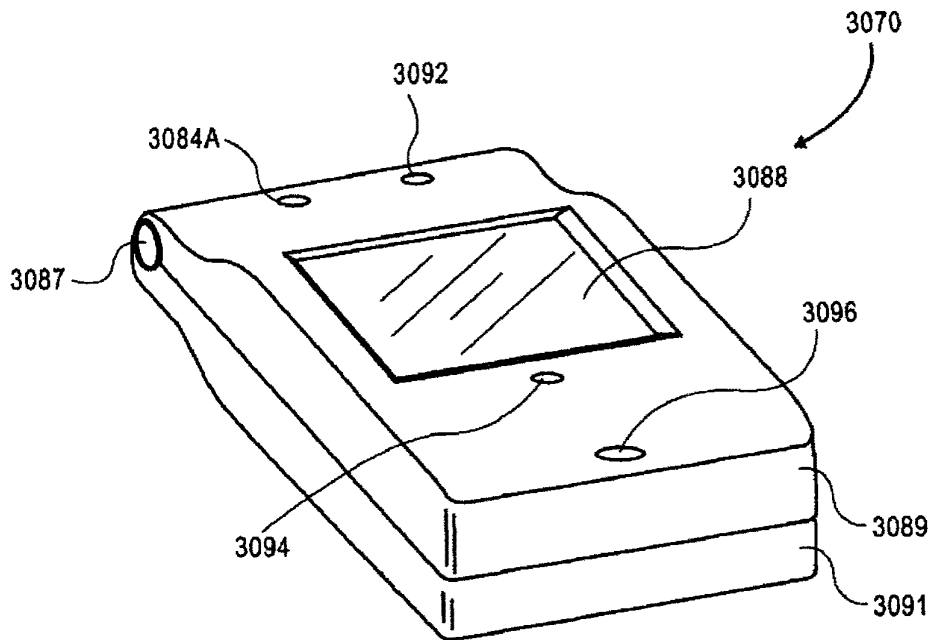

FIG. 30B

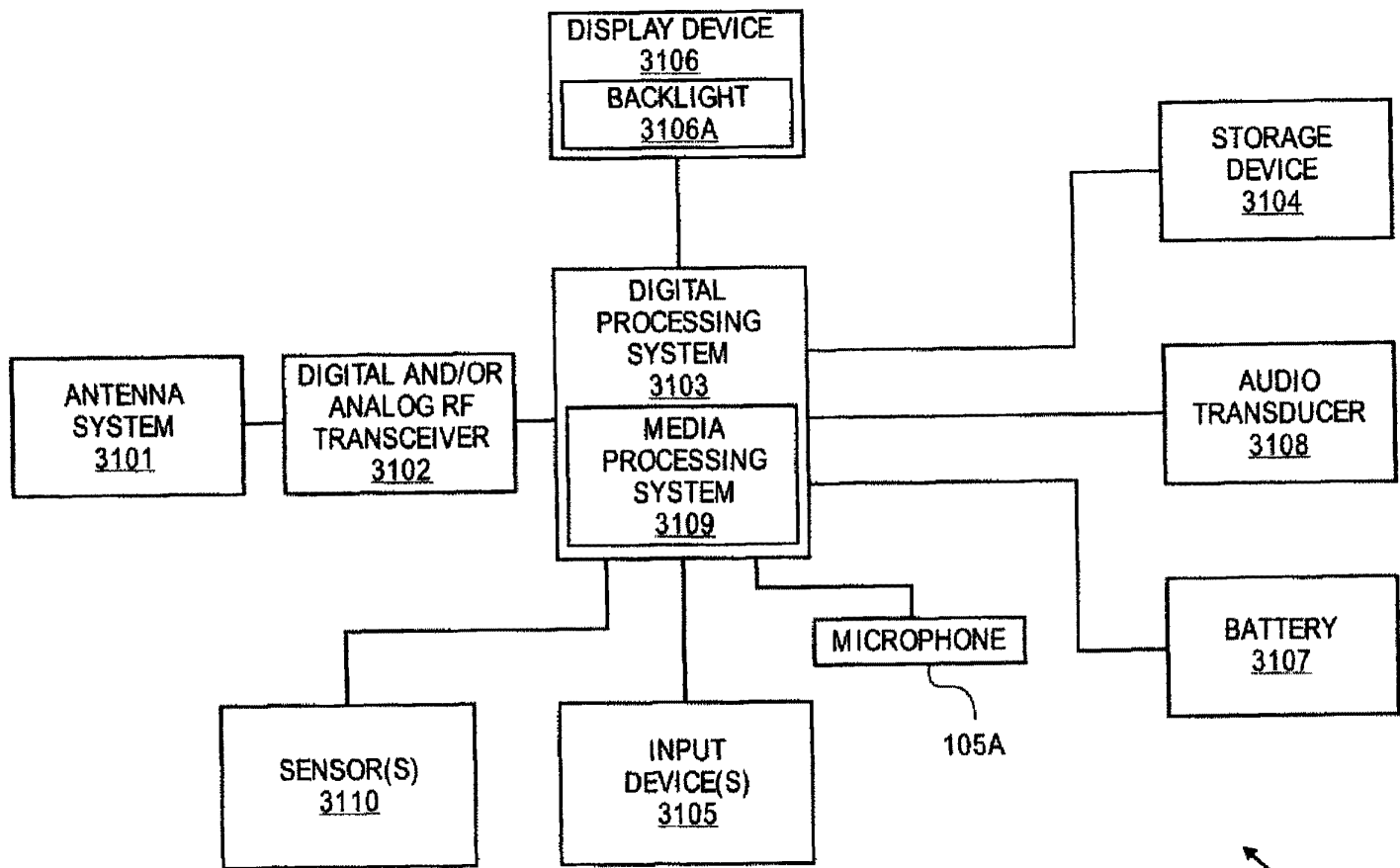

FIG. 31

U.S. Patent Nov. 30, 2010 Sheet 32 of 37 US 7,844,915 B2

Copy provided by USPTO from the PIRS Image Database on 04/25/2011

U.S. Patent

Nov. 30, 2010

Sheet 33 of 37

US 7,844,915 B2

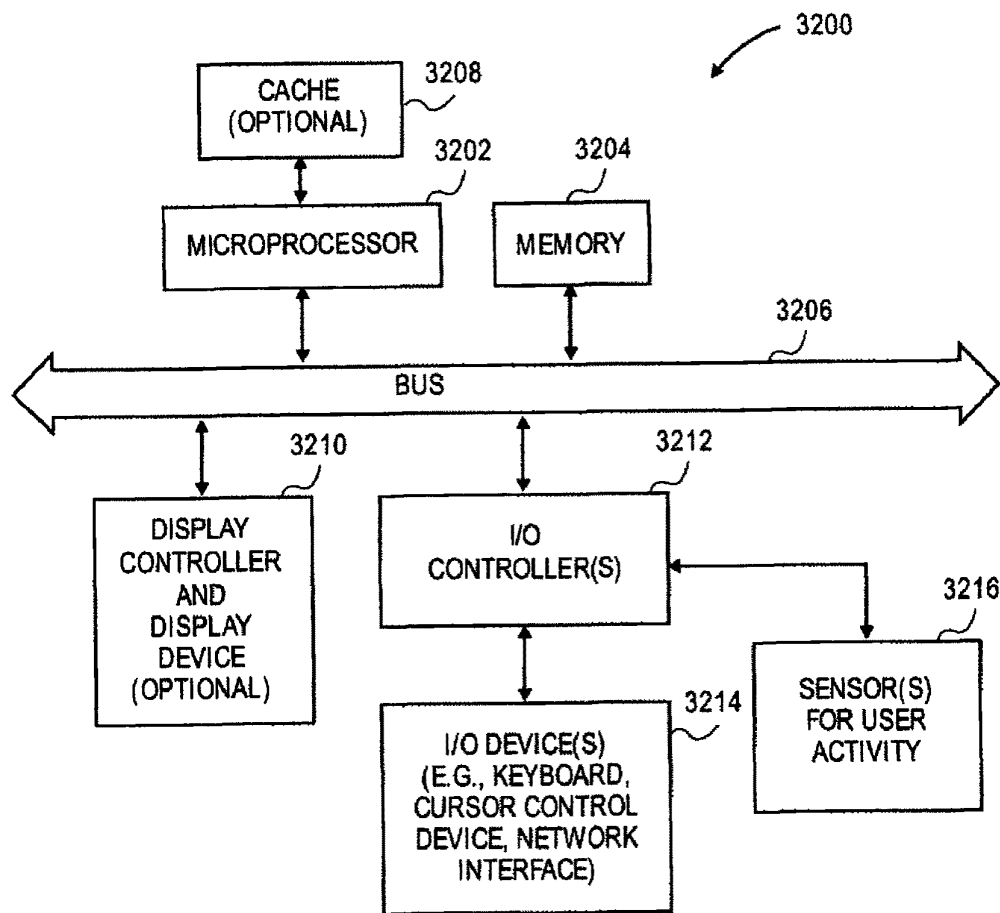

FIG. 32

U.S. Patent

Nov. 30, 2010

Sheet 34 of 37

US 7,844,915 B2

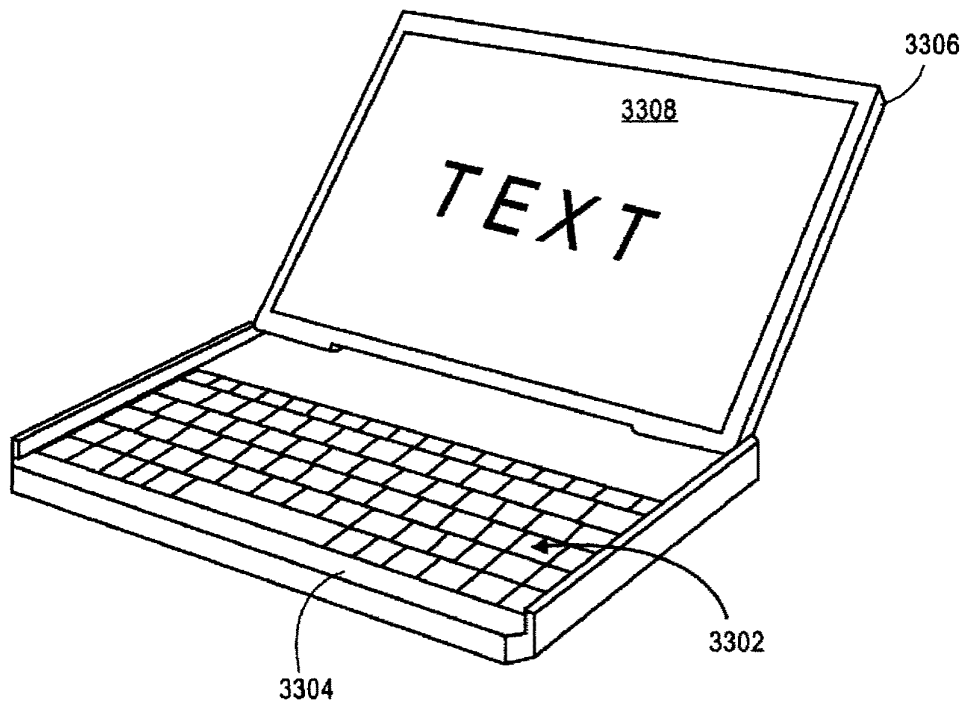

FIG. 33A

U.S. Patent

Nov. 30, 2010

Sheet 35 of 37

US 7,844,915 B2

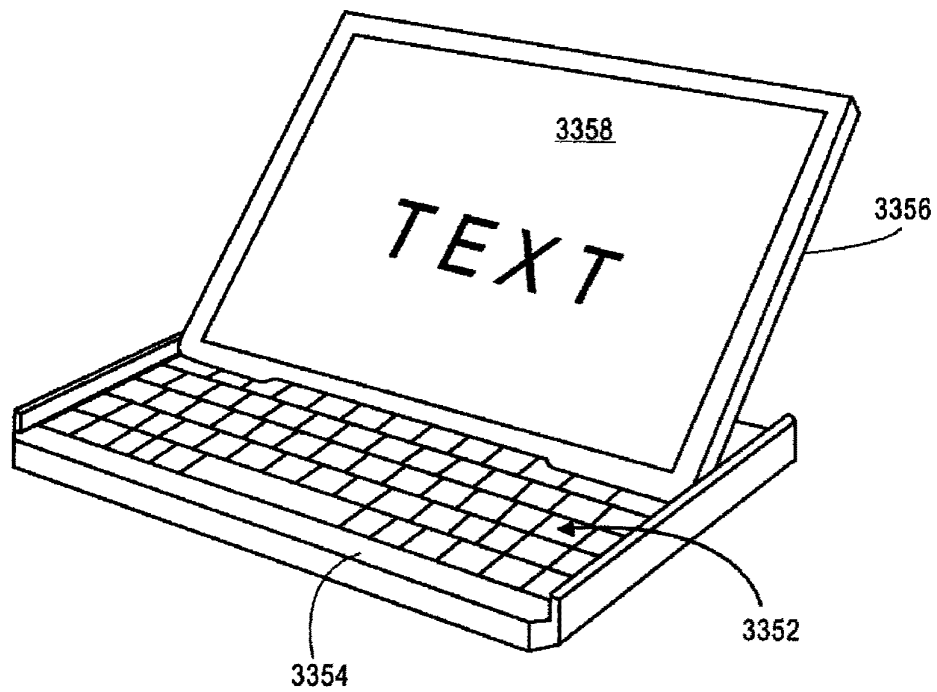

FIG. 33B

U.S. Patent

Nov. 30, 2010

Sheet 36 of 37

US 7,844,915 B2

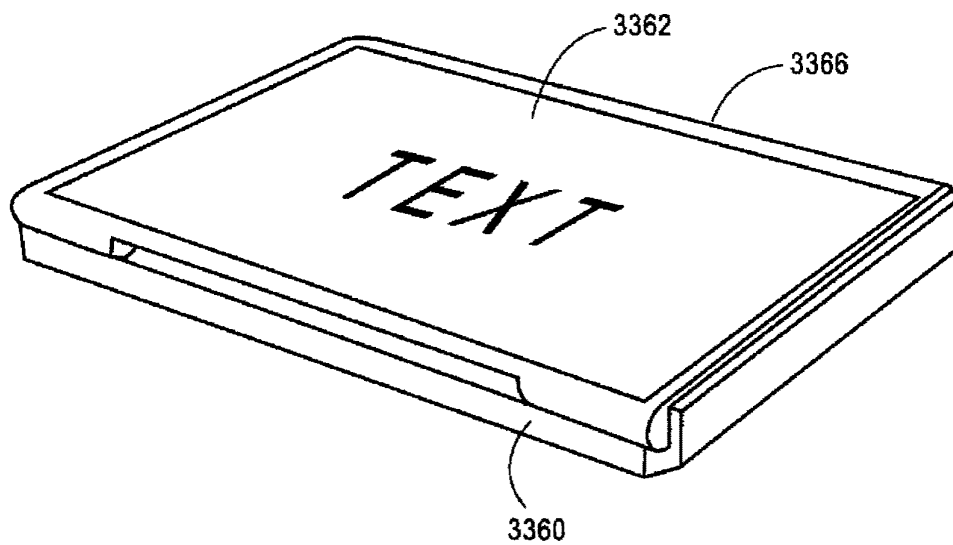

FIG. 33C

U.S. Patent

Nov. 30, 2010

Sheet 37 of 37

US 7,844,915 B2

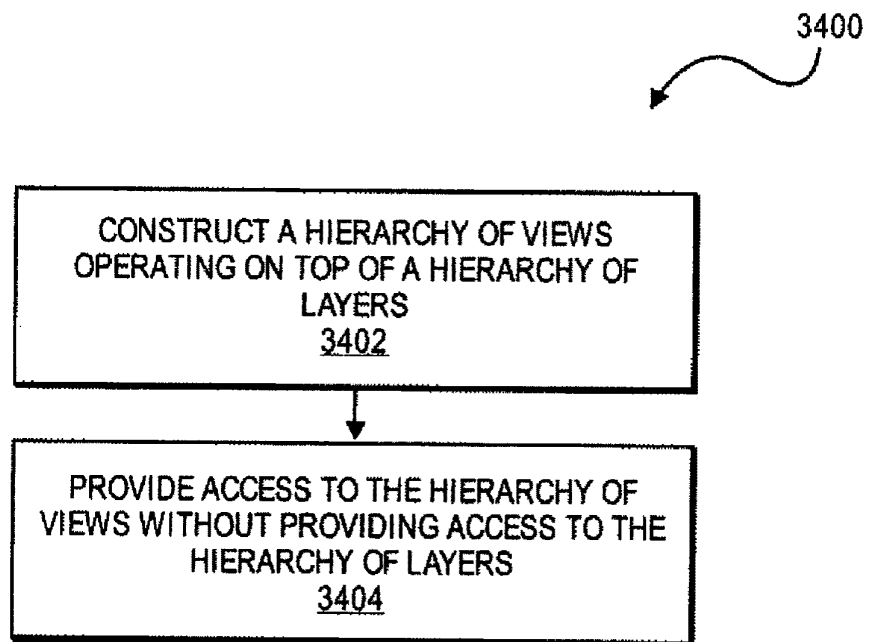

FIG. 34

US 7,844,915 B2

1

**APPLICATION PROGRAMMING
INTERFACES FOR SCROLLING
OPERATIONS**

FIELD OF THE DISCLOSURE

This disclosure relates to application programming interfaces that provide scrolling operations.

COMPUTER PROGRAM LISTING

A portion of the disclosure of this patent document contains material which is subject to copyright protection. The copyright owner has no objection to facsimile reproduction by anyone of the patent document or the patent disclosure, as it appears in the Patent & Trademark Office patent file or records, but otherwise reserves all copyright rights whatsoever.

Applicant has submitted herewith Computer Program Listings which are included as Appendix A, attached.

BACKGROUND OF THE DISCLOSURE

An API is a source code interface that a computer system or program library provides in order to support requests for services from a software application. An API is specified in terms of a programming language that can be interpretative or compiled when an application is built, rather than an explicit low level description of how data is laid out in memory. The software that provides the functionality described by an API is said to be an implementation of the API.

Various devices such as electronic devices, computing systems, portable devices, and handheld devices have software applications. The API interfaces between the software applications and user interface software to provide a user of the device with certain features and operations. A user may desire certain operations such as scrolling, selecting, gesturing, and animating operations for a display of the device.

Scrolling is the act of sliding a directional (e.g., horizontal or vertical) presentation of content, such as text, drawings, or images, across a screen or display window. In a typical graphical user interface, scrolling is done with the help of a scrollbar or using keyboard shortcuts often the arrow keys. Gesturing is a type of user input with two or more input points. Animating operations include changing content within a given time period.

The various types of devices may have a limited display size, user interface, software, API interface and/or processing capability which limits the ease of use of the devices. User interfaces of devices implement APIs in order to provide requested functionality and features. These user interfaces can have difficulty interpreting the various types of user inputs and providing the intended functionality associated with the user inputs.

SUMMARY OF THE DESCRIPTION

At least certain embodiments of the present disclosure include one or more application programming interfaces in an environment with user interface software interacting with a software application. Various function calls or messages are transferred via the application programming interfaces between the user interface software and software applications. Example application programming interfaces transfer function calls to implement scrolling, gesturing, and animating operations for a device.

2

At least certain embodiments of the present disclosure include an environment with user interface software interacting with a software application. A method for operating through an application programming interface (API) in this environment includes transferring a set bounce call. The method further includes setting at least one of maximum and minimum bounce values. The set bounce call causes a bounce of a scrolled region in an opposite direction of a scroll based on a region past an edge of the scrolled region being visible in a display region at the end of the scroll.

At least certain embodiments of the present disclosure include an environment with user interface software interacting with a software application. A method for operating through an application programming interface (API) in this environment includes transferring a rubberband call. Rubberbanding a scrolled region within a display region occurs by a predetermined maximum displacement when the scrolled region exceeds a display edge. The method further includes transferring an edge rubberband call to set displacement values for at least one edge of the display (e.g., top and bottom edges, left and right edges).

At least certain embodiments of the present disclosure include gesture operations for a display of a device. The gesture operations include performing a scaling transform such as a zoom in or zoom out in response to a user input having two or more input points. The gesture operations also include performing a rotation transform to rotate an image or view in response to a user input having two or more input points.

At least certain embodiments of the present disclosure include a method for performing animations for a display of a device. The method includes starting at least one animation. The method further includes determining the progress of each animation. The method further includes completing each animation based on a single timer. The single timer can be based on a redraw interval of the display hardware.

Various devices which perform one or more of the foregoing methods and machine readable media which, when executed by a processing system, cause the processing system to perform these methods, are also described.

Other methods, devices and machine readable media are also described.

BRIEF DESCRIPTION OF THE DRAWINGS

The disclosure is described by way of example with reference to the accompanying drawings, wherein:

FIG. 1 is flow chart of a method for responding to a user input of a data processing device;

FIG. 2 illustrates details of an application programming interface in flow chart form according to certain teachings of the present disclosure;

FIG. 3 illustrates details of an application programming interface in flow chart form according to certain teachings of the present disclosure;

FIG. 4 is a schematic diagram illustrating an embodiment of user interface of a portable electronic device 400 having a touch-sensitive display 408;

FIG. 5A-5C illustrate at least some embodiments of user interface of a portable electronic device 400 having a touch-sensitive display;

FIG. 6A-6D illustrate the scrolling of a list of items to a terminus of the list, at which point an area beyond the terminus is displayed and the list is then scrolled in an opposite direction until the area beyond the terminus is no longer displayed, in accordance with some embodiments;

US 7,844,915 B2

3

FIG. 7 illustrates details of an application programming interface in flow chart form according to certain teachings of the present disclosure;

FIG. 8 illustrates first and second scroll angles for locking a scroll of a display of a device in a horizontal or vertical direction according to certain teachings of the present disclosure;

FIG. 9 illustrates details of an application programming interface in flow chart form according to certain teachings of the present disclosure;

FIG. 10 illustrates details of an application programming interface in flow chart form according to certain teachings of the present disclosure;

FIG. 11 illustrates details of an application programming interface in flow chart form according to certain teachings of the present disclosure;

FIG. 12 illustrates details of an application programming interface in flow chart form according to certain teachings of the present disclosure;

FIG. 13 illustrates details of an application programming interface in flow chart form according to certain teachings of the present disclosure;

FIG. 14 illustrates details of an application programming interface in flow chart form according to certain teachings of the present disclosure;

FIG. 15 illustrates a display of a device having a scaling transform of a view;

FIGS. 16A and 16B illustrate a display of a device with a view having a first and a second scaling factor;

FIG. 16C illustrates changing a view from a scale factor of 2x to a scale factor of 1x in at least some embodiments of the present disclosure;

FIG. 17 illustrates details of an application programming interface in flow chart form according to certain teachings of the present disclosure;

FIG. 18 illustrates details of an application programming interface in flow chart form according to certain teachings of the present disclosure;

FIG. 19 is flow chart of a method for animating views displayed on a display of a device;

FIG. 20 is flow chart of a method for animating views displayed on a display of a device;

FIG. 21 illustrates details of an application programming interface in flow chart form according to certain teachings of the present disclosure;

FIGS. 22A and 22B illustrate synchronizing the resizing of windows of a display of a device;

FIG. 23 illustrates a method for switching ownership of a view of an application displayed on a display of a data processing device;

FIG. 24 illustrates a method for memory management of a view of an application displayed on a display of a device;

FIGS. 25A and 25B illustrate a data structure having a hierarchy of layers with a layer being associated with a view;

FIG. 26 illustrates a method for compositing media and non-media content of user interface for display on a device;

FIG. 27 illustrates a data structure or layer tree having a hierarchy of layers;

FIG. 28 is a perspective view of a device in accordance with one embodiment of the present disclosure;

FIG. 29 is a perspective view of a device in accordance with one embodiment of the present disclosure;

FIGS. 30A and 30B illustrate a device 3070 according to one embodiment of the disclosure;

FIG. 31 is a block diagram of a system in which embodiments of the present disclosure can be implemented;

4

FIG. 32 shows another example of a device in accordance with one embodiment of the present disclosure;

FIG. 33A is a perspective view of a device in a first configuration (e.g. in a laptop configuration) in accordance with one embodiment of the present disclosure;

FIG. 33B is a perspective view of the device of FIG. 33A in a second configuration (e.g. a transition configuration) in accordance with one embodiment of the present disclosure;

FIG. 33C is a perspective view of the device of FIG. 33A in a third configuration (e.g., a tablet configuration) in accordance with one embodiment of the present disclosure; and

FIG. 34 illustrates details of an application programming interface in flow chart form according to certain teachings of the present disclosure.

DETAILED DESCRIPTION

Various embodiments and aspects of the disclosure will be described with reference to details discussed below, and the accompanying drawings will illustrate the various embodiments. The following description and drawings are illustrative of the disclosure and are not to be construed as limiting the disclosure. Numerous specific details are described to provide a thorough understanding of various embodiments of the present disclosure. However, in certain instances, well-known or conventional details are not described in order to provide a concise discussion of embodiments of the present disclosure.

Some portions of the detailed descriptions which follow are presented in terms of algorithms which include operations on data stored within a computer memory. An algorithm is generally a self-consistent sequence of operations leading to a desired result. The operations typically require or involve physical manipulations of physical quantities. Usually, though not necessarily, these quantities take the form of electrical or magnetic signals capable of being stored, transferred, combined, compared, and otherwise manipulated. It has proven convenient at times, principally for reasons of common usage, to refer to these signals as bits, values, elements, symbols, characters, terms, numbers, or the like.

It should be borne in mind, however, that all of these and similar terms are to be associated with the appropriate physical quantities and are merely convenient labels applied to these quantities. Unless specifically stated otherwise as apparent from the following discussion, it is appreciated that throughout the description, discussions utilizing terms such as "processing" or "computing" or "calculating" or "determining" or "displaying" or the like, can refer to the action and processes of a data processing system, or similar electronic device, that manipulates and transforms data represented as physical (electronic) quantities within the system's registers and memories into other data similarly represented as physical quantities within the system's memories or registers or other such information storage, transmission or display devices.

The present disclosure can relate to an apparatus for performing one or more of the operations described herein. This apparatus may be specially constructed for the required purposes, or it may comprise a general purpose computer selectively activated or reconfigured by a computer program stored in the computer. Such a computer program may be stored in a machine (e.g. computer) readable storage medium, such as, but is not limited to, any type of disk including floppy disks, optical disks, CD-ROMs, and magnetic-optical disks, read-only memories (ROMs), random access memories (RAMs), erasable programmable ROMs (EPROMs), electrically erasable programmable ROMs (EEPROMs), flash memory, mag-

US 7,844,915 B2

5

netic or optical cards, or any type of media suitable for storing electronic instructions, and each coupled to a bus.

A machine-readable medium includes any mechanism for storing information in a form readable by a machine (e.g., a computer). For example, a machine-readable medium includes read only memory ("ROM"); random access memory ("RAM"); magnetic disk storage media; optical storage media; flash memory devices; etc.

At least certain embodiments of the present disclosure include one or application programming interfaces in an environment with user interface software interacting with a software application. Various function calls or messages are transferred via the application programming interfaces between the user interface software and software applications. Transferring the function calls or messages may include issuing, initiating, invoking or receiving the function calls or messages. Example application programming interfaces transfer function calls to implement scrolling, gesturing, and animating operations for a device having a display region. An API may also implement functions having parameters, variables, or pointers. An API may receive parameters as disclosed or other combinations of parameters. In addition to the APIs disclosed, other APIs individually or in combination can perform similar functionality as the disclosed APIs.

The display region is a form of a window. A window is a display region which may not have a border and may be the entire display region or area of a display. In some embodiments, a display region may have at least one window and/or at least one view (e.g., web, text, or image content). A window may have at least one view. The methods, systems, and apparatuses disclosed can be implemented with display regions, windows, and/or views.

At least certain embodiments of the present disclosure include scrolling operations for scrolling a display of a device. The scrolling operations include bouncing a scrolled region in an opposite direction of a scroll when a scroll completes, rubberbanding a scrolled region by a predetermined maximum displacement when the scrolled region exceeds a display edge, and setting a scrolling angle that locks the scroll in a horizontal or vertical direction.

At least certain embodiments of the present disclosure include gesture operations for a display of a device. The gesture operations include performing a scaling transform such as a zoom in or zoom out in response to a user input having two or more input points. The gesture operations also include performing a rotation transform to rotate an image or view in response to a user input having two or more input points.

At least certain embodiments of the present disclosure include a method for performing animations for a display of a device. The method includes starting at least one animation. The method further includes determining the progress of each animation. The method further includes completing each animation based on a single timer. The single timer can be based on a redraw interval of the display hardware.

At least certain embodiments of the disclosure may be part of a digital media player, such as a portable music and/or video media player, which may include a media processing system to present the media, a storage device to store the media and may further include a radio frequency (RF) transceiver (e.g., an RF transceiver for a cellular telephone) coupled with an antenna system and the media processing system. In certain embodiments, media stored on a remote storage device may be transmitted to the media player through the RF transceiver. The media may be, for example, one or more of music or other audio, still pictures, or motion pictures.

6

The portable media player may include a media selection device, such as a click wheel input device on an iPod® or iPod Nano® media player from Apple Computer, Inc. of Cupertino, Calif., a touch screen input device, pushbutton device, movable pointing input device or other input device. The media selection device may be used to select the media stored on the storage device and/or the remote storage device. The portable media player may, in at least certain embodiments, include a display device which is coupled to the media processing system to display titles or other indicators of media being selected through the input device and being presented, either through a speaker or earphone(s), or on the display device, or on both display device and a speaker or earphone(s). In some embodiments, the display device and input device are integrated while in other embodiments the display device and input device are separate devices. Examples of a portable media player are described in published U.S. patent application Nos. 2003/0095096 and 2004/0224638, both of which are incorporated by reference.

Embodiments of the disclosure described herein may be part of other types of data processing systems, such as, for example, entertainment systems or personal digital assistants (PDAs), or general purpose computer systems, or special purpose computer systems, or an embedded device within another device, or cellular telephones which do not include media players, or multi touch tablet devices, or other multi touch devices, or devices which combine aspects or functions of these devices (e.g., a media player, such as an iPod®, combined with a PDA, an entertainment system, and a cellular telephone in one device). In this disclosure, electronic devices and consumer devices are types of devices.

FIG. 1 is flow chart of a method for responding to a user input of a device. The method 100 includes receiving a user input at block 102. The user input may be in the form of an input key, button, wheel, touch, or other means for interacting with the device. The method 100 further includes creating an event object in response to the user input at block 104. The method 100 further includes determining whether the event object invokes a scroll or gesture operation at block 106. For example, a single touch that drags a distance across a display of the device may be interpreted as a scroll operation. In one embodiment, a two or more finger touch of the display may be interpreted as a gesture operation. In certain embodiments, determining whether the event object invokes a scroll or gesture operation is based on receiving a drag user input for a certain time period. The method 100 further includes issuing at least one scroll or gesture call based on invoking the scroll or gesture operation at block 108. The method 100 further includes responding to at least one scroll call, if issued, by scrolling a window having a view (e.g., web, text, or image content) associated with the event object based on an amount of a scroll with the scroll stopped at a predetermined position in relation to the user input at block 110. For example, an input may end at a certain position on a display of the device. The scrolling may continue until reaching a predetermined position in relation to the last input received from the user. The method 100 further includes responding to at least one gesture call, if issued, by changing a view associated with the event object based on receiving a plurality of input points in the form of the user input at block 112.

In certain embodiments of the present disclosure scroll operations include attaching scroll indicators to a content edge of a display. Alternatively, the scroll indicators can be attached to the display edge. In some embodiments, user input in the form of a mouse/finger down causes the scroll indicators to be displayed on the display edge, content edge, or window edge of the scrolled region. If a mouse/finger up is

US 7,844,915 B2

7

then detected, the scroll indicators are faded out from the display region, content edge, or window edge of the scrolled region.

In certain embodiments of the present disclosure, gesture operations include responding to at least one gesture call, if issued, by rotating a view associated with the event object based on receiving a plurality of input points in the form of the user input. Gesture operations may also include scaling a view associated with the event object by zooming in or zooming out based on receiving the user input.

In some embodiments, a device includes a display region having multiple views or windows. Each window may have a multiple views including superviews and subviews. It is necessary to determine which window, view, superview, or subview is contacted by a user input in the form of a mouse up, mouse down, or drag, etc. An API can set various modes for making this determination. In one embodiment, a pass mode sends mouse down, mouse up, and drag inputs to the nearest subview. In another embodiment, an intercept on drag mode sends a drag input to the superview while mouse up and down inputs are sent to the subview. In another embodiment, an intercept mode sends all drag, mouse up and down inputs to the superview. The superview may be scroller software operating as a subclass of a view software. The subview may be view software operating as a subclass of the user interface software.

FIG. 2 illustrates details of an application programming interface in flow chart form according to certain teachings of the present disclosure. The application programming interface operates in an environment with user interface software interacting with a software application in order to provide a bounce operation. The method 200 for providing a bounce operation includes transferring a set bounce call at block 202. The method 200 further includes setting at least one of maximum and minimum bounce values at block 204. The minimum and maximum bounce values may be associated with at least one edge of a window that has received a user input. The method 200 further includes causing a bounce of a scrolled region in an opposite direction of a scroll based on a region past the scrolled region being visible in a display region at the end of the scroll at block 206. The scrolled region may be a content region.

In certain embodiments of the present disclosure, transferring the set bounce call is either one of issuing, initiating, invoking or receiving the set bounce call.

FIG. 3 illustrates details of an application programming interface in flow chart form according to certain teachings of the present disclosure. The application programming interface operates in an environment with user interface software interacting with a software application in order to provide a rubberband operation. The method 300 for providing a rubberband operation includes transferring a rubberband call to cause rubberbanding a scrolled region displayed within a display at block 302. The method 300 further includes transferring an edge rubberband call to set displacement values for at least one edge of the display at block 304. In some embodiments, the displacement values are set for top and bottom edges, left and right edges, or all edges.

Rubberbanding a scrolled region according to the method 300 occurs by a predetermined maximum displacement value when the scrolled region exceeds a display edge of a display of a device based on the scroll. If a user scrolls content of the display making a region past the edge of the content visible in the display, then the displacement value limits the maximum amount for the region outside the content. At the end of the scroll, the content slides back making the region outside of the content no longer visible on the display.

8

In certain embodiments of the present disclosure, transferring the rubberband call is either one of issuing, initiating, invoking or receiving the rubberband call.

FIG. 4 is a schematic diagram illustrating an embodiment of user interface of a portable electronic device 400 having a touch-sensitive display 408. The display 408 may include one or more windows 410. The window 410 may include one or more displayed objects, such as information objects 412-1 to 412-4. In an exemplary embodiment, the information objects 412 may correspond to contact information for one or more individuals in a list of items. The displayed objects may be moved in response to detecting or determining movement 414 of a point of contact with the display, such as that associated with one or more digits 416 of a user (which are not drawn to Scale in FIG. 4). In some embodiments, movement of the displayed objects may be accelerated in response to detecting or determining accelerated movement of the point of contact. While embodiment 400 includes one window 410, in other embodiments there may be two or more display windows. In addition, while embodiment 400 illustrates movement 414 in a particular direction, in other embodiments movement of the displayed objects may be in response to movement 414 in one or more other directions, or in response to a scalar (i.e., a determined or detected movement independent of the direction).

FIGS. 5A-5C illustrate the scrolling of a list of items on a device to a terminus of the list, at which point one or more displayed items at the end of the list smoothly bounce off the end of the display, reverse direction, and then optionally come to a stop. FIG. 5A is a schematic diagram illustrating an embodiment of user interface of a portable electronic device 400 having a touch-sensitive display. One or more displayed objects, such as information object 412-1 may be a distance 512-1 from a terminus 514 of the list of items which is an edge of a scrolled region and may be moving with a velocity 510-1 while the list is being scrolled. Note that the terminus 514 is a virtual boundary associated with the displayed objects, as opposed to a physical boundary associated with the window 410 and/or the display 408. As illustrated in FIG. 5B, when the one or more displayed objects, such as the information object 412-1, reach or intersect with the terminus 514, the movement corresponding to the scrolling may stop, i.e., the scrolling velocity may be zero at an instant in time. As illustrated in FIG. 5C, the one or more displayed objects, such as the information 412-1, may subsequently reverse direction. At a time after the intersection with the terminus 514, the information object 412-1 may have velocity 510-2 and may be a distance 512-2 from the terminus 514. In some embodiments, the magnitude of velocity 510-2 may be less than the magnitude of velocity 510-1 when the distance 512-2 equals the distance 512-1, i.e., the motion of the one or more displayed objects is damped after the scrolling list reaches and "bounces" at its terminus.

In at least some embodiments of the present disclosure, the method 200 performs the bounce operations described in FIGS. 5A-5C. The bounce call transferred at block 202 determines whether a bounce operation is enabled. The maximum and minimum bounces values determine the amount of bouncing of the scrolled region in an opposite direction of the scroll.

FIGS. 6A-6D illustrate the scrolling of a list of items to a terminus of the list, at which point an area beyond the terminus is displayed and the list is then scrolled in an opposite direction until the area beyond the terminus is no longer displayed, in accordance with some embodiments. The rubberband operation of method 300 is illustrated in the example of FIGS. 6A-6D with the listed items being email messages.

US 7,844,915 B2

9

FIGS. 6A-6D illustrate an exemplary user interface 3500A for managing an inbox in accordance with some embodiments. An analogous user interface may be used to display and manage other mailboxes (e.g., drafts, sent, trash, personal, etc.). In addition, other types of lists are possible, including but not limited to lists of instant message conversations, favorite phone numbers, contact information, labels, email folders, email addresses, physical addresses, ringtones, or album names.

If the list of emails fills more than the allotted screen area, the user may scroll through the emails using vertically upward and/or vertically downward swipe gestures on the touch screen. In the example of FIG. 6A, a portion of a list of emails is displayed in the screen area, including a top displayed email 3530 from Bruce Walker and a bottom displayed email 3532 from Kim Brook. A user performs a vertically downward swipe gesture 3514 to scroll toward the top of the list. The vertically downward gesture 3514 need not be exactly vertical; a substantially vertical gesture is sufficient. In some embodiments, a gesture within a predetermined angle of being perfectly vertical results in vertical scrolling.

As a result of detecting the vertically downward gesture 3514, in FIG. 6B the displayed emails have shifted down, such that the previous bottom displayed email 3532 from Kim Brook is no longer displayed, the previous top displayed email 3530 from Bruce Walker is now second from the top, and the email 3534 from Aaron Jones, which was not displayed in FIG. 6A, is now displayed at the top of the list.

In this example, the email 3534 from Aaron Jones is the first email in the list and thus is the terminus of the list. Upon reaching this email 3534, in response to continued detection of the vertically downward gesture 3514, an area 3536 (FIG. 6C) above the first email 3534 (i.e., beyond the terminus of the list) is displayed. In some embodiments, the area displayed beyond the terminus of the list is visually indistinct from the background of the list. In FIG. 6C, both the area 3536 and the background of the emails (e.g., emails 3534 and 3530) are white and thus are visually indistinct.

Once vertically downward gesture 3514 is complete, such that a corresponding object is no longer detected on or near the touch screen display, the list is scrolled in an opposite direction until the area 3536 is no longer displayed. FIG. 6D illustrates the result of this scrolling in the opposite direction, the email 3534 from Aaron Jones is now displayed at the top of the screen area allotted to the list and the area 3536 is not displayed.

In the example of FIGS. 6A-6D, a vertically downward gesture resulted in display of an area beyond the first item in the list. As described in FIG. 3, the values for the predetermined maximum displacement (e.g., display of an area beyond the first item in the list) are set at block 304 for top and bottom edges or at block 306 for all edges of the window.

Similarly, a vertically upward gesture may result in display of an area beyond the last item of the list, if the vertically upward gesture continues once the list has been scrolled to the last item. The last item may be considered a terminus of the list, similar to the first item. As discussed above, the gesture need not be exactly vertical to result in vertical scrolling; a gesture within a predefined range of angles from perfectly vertical is sufficient.

FIG. 7 illustrates details of an application programming interface in flow chart form according to certain teachings of the present disclosure. The application programming interface operates in an environment with user interface software interacting with a software application in order to provide a directional scrolling operation. The method 700 for operating through an application programming interface (API) includes

10

transferring a directional scroll angle call to determine if directional scrolling is enabled at block 702. The method 700 further includes transferring a directional scroll angle call to set a scroll angle for locking the scrolling in at least one of a vertical or a horizontal direction at block 704. The method 700 further includes locking the scrolling in the horizontal direction if a user input forms an angle with a horizontal direction that is less than or equal to a first scroll angle at block 706. The method 700 further includes locking the scrolling in the vertical direction if a user input forms an angle with the vertical direction that is less than or equal to a second scroll angle at block 708.

In certain embodiments, a user input in the form of a drag forms an angle with the horizontal direction that is less than the first scroll angle. In this case, the user presumably intends to scroll in the horizontal direction. The scrolling will be locked in the horizontal direction until the user input exceeds the first scroll angle. A second scroll angle may be used for locking the user input in the vertical direction. The second scroll angle may be set equal to the first scroll angle.

FIG. 8 illustrates first and second scroll angles for locking a scroll of a display of a device in a horizontal or vertical direction. The horizontal direction 802 and vertical direction 804 are in reference to a window or a display of a device. As discussed in the method 700, a user input such as a drag movement forming an angle with the horizontal direction 802 less than or equal to the first scrolling angle 806 or 808 will lock the user input in the horizontal direction. In a similar manner, a user input forming an angle with the vertical direction 810 less than or equal to the second scrolling angle 810 or 812 will lock the user input in the vertical direction. The first and second scrolling angles may be set at the same angle or at different angles as well. For example, the first and second scrolling angles may be set at 25 degrees. A user input less than or equal to 25 degrees with respect to the horizontal or vertical direction will lock the scrolling in the appropriate direction.

In some embodiments, the horizontal and vertical locking angles can be determined in part by the aspect of the content. For example, content in the form of a tall page may receive a larger vertical locking angle compared to the horizontal locking angle.

FIG. 9 illustrates details of an application programming interface in flow chart form according to certain teachings of the present disclosure. The application programming interface operates in an environment with user interface software interacting with a software application in order to provide a deceleration scroll operation. The method 900 for providing the deceleration scroll operation includes transferring a deceleration scroll call to set a deceleration factor for a drag user input at block 902. The method 900 further includes slowing the scroll to a stop based on the speed of the drag user input and the deceleration factor at block 904.

In certain embodiments, a user input in the form of a drag invokes a scroll operation for a certain time period. The user input has a certain speed. The scroll of the scrolled region of a window or a display region of a display of a device will be stopped after the user input stops by applying a deceleration factor to the speed of the user input during the drag movement.

FIG. 10 illustrates details of an application programming interface in flow chart form according to certain teachings of the present disclosure. The application programming interface operates in an environment with user interface software interacting with a software application in order to provide a scroll hysteresis operation. The method 1000 for providing the scroll hysteresis operation includes transferring a scroll

US 7,844,915 B2

11

hysteresis call to determine whether a user input invokes a scroll at block 1002. The method 1000 further includes setting a hysteresis value for determining whether a user input invokes a scroll at block 1004.

In certain embodiments, a user input in the form of a drag over a certain distance across a display or window within a display of a device invokes a scroll operation. The hysteresis value determines the certain distance which the user input must drag across the display or window prior to invoking a scroll operation. A user input that does not drag the certain predetermined distance will not invoke a scroll operation and may be considered a mouse up or down input or other type of input.

FIG. 11 illustrates details of all application programming interface in flow chart form according to certain teachings of the present disclosure. The application programming interface operates in an environment with user interface software interacting with a software application in order to attach a scroll indicator to a scroll region edge or a window edge of a device. In some embodiments, the scroll region edge is associated with a content edge. The window or display edge may be associated with the edge of a display region. The method 1100 for providing the scroll indicator includes transferring a scroll indicator call to determine whether at least one scroll indicator attaches to an edge of a scroll region or a window edge at block 1102. A scroll indicator may be displayed on any display edge, window edge or scroll region edge. The method 1100 further includes optionally attaching at least one scroll indicator to the edge of the scroll region based on the scroll indicator call at block 1104. Alternatively, the method 1100 further includes optionally attaching at least one scroll indicator to the window edge of the view based on the scroll indicator call at block 1106.

In some embodiments, the operations of method 1100 can be altered, modified, combined, or deleted. For example, block 1104 can be deleted. Likewise, block 1106 can be deleted from the method 1100. Alternatively, the order of block 1104 and block 1106 can be switched. Other methods having various operations that have been disclosed within the present disclosure can also be altered, modified, rearranged, collapsed, combined, or deleted.

In certain embodiments of the present disclosure, transferring the scroll indicator call is either one of issuing, initiating, invoking or receiving the scroll indicator call. For example, the user interface software (e.g., software kit or library) may receive the scroll indicator call from the software application.

FIG. 12 illustrates details of an application programming interface in flow chart form according to certain teachings of the present disclosure. The application programming interface operates in an environment with user interface software interacting with a software application in order to determine if an inadvertent user input contacts a view of a display of a device. The method 1200 includes transferring an inadvertent user input call to determine whether the user input was inadvertent at block 1202. The method 1200 further includes ignoring the inadvertent user input based on the determination of the inadvertent user input call at block 1204. In one embodiment, the inadvertent user input call comprises a thumb detection call to determine whether the user input was an inadvertent thumb.

In certain embodiments of the present disclosure, transferring the inadvertent user input call is either one of issuing, initiating, invoking or receiving the inadvertent user input call.

A gesture API provides an interface between an application and user software in order to handle gesturing. Gesturing may include scaling, rotating, or other changes to a view, window,

12

or display. A mask may merely permit certain changes while limiting or not permitting other changes. Events of all kinds come into the application via a graphics framework. They are enqueued, collated if necessary and dispatched. If the events are system level events (e.g., application should suspend, device orientation has changed, etc) they are routed to the application having an instance of a class of the user interface software. If the events are hand events based on a user input, the events are routed to the window they occurred over. The window then routes these events to the appropriate control by calling the instance's mouse and gesture methods. The control that receives a mouse down or mouse entered function will continue to get all future calls until the hand is lifted. If a second finger is detected, the gesture methods or functions are invoked. These functions may include start, change, and end gesture calls. The control that receives start gesture call will be sent all future change gesture calls until the gesture ends.

FIG. 13 illustrates details of an application programming interface in flow chart form according to certain teachings of the present disclosure. The application programming interface operates in an environment with user interface software interacting with a software application in order to provide a gesture operation. The method 1300 for providing the gesture operation includes transferring a handle gesture event call at block 1302. The method 1300 further includes transferring a gesture change call in response to the handle gesture event call at block 1304.

In certain embodiments, a user input in the form of two or more points is received by a display of a device. A multi-touch driver of the device receives the user input and packages the event into an event object. A window server receives the event object and determines whether the event object is a gesture event object. If the window server determines that a gesture event object has been received, then user interface software issues or transfers the handle gesture call at block 1302 to a software application associated with the view. The software application confirms that a gesture event has been received and passes the handle gesture call to a library of the user interface software. The window server also associates the gesture event object with the view that received the user input. The library responds by transferring a gesture change call in response to the handle gesture event call at block 1304.

In one embodiment, a window or view associated with the user input receives the change call in order to perform the gesture event. The user software that provides the view receives a gesture start event call, a gesture changed event call, a zoom to scale setting for the view, and a gesture end call. The gesture calls receive an input of a gesture event which may be base event having a type such as a hand event, keyboard event, system event, etc. A delegate associated with the application receives a start gesture call, gesture did change call, and gesture did finish call. The user software is dynamically linking into the application during the run time of the gesture process.

In some embodiments, the gesture changed function call contains the following information about the gesture:

- the number of fingers currently down;
- the number of fingers initially down;
- the rotation of the hand;
- the scale of the hand;
- the translation of the hand;
- the position of the inner and outermost fingers; and
- the pressure of the first finger.

US 7,844,915 B2

13

In other embodiments, more information about each finger down may be included as follows.

the stage of the finger Oust touch down, fully pressed, lifting off, etc);

the position of the finger;

the proximity of the finger (how hard you're touching);

the orientation of the finger (what angle the ovoid is at);

the length of the major and minor axis,

the velocity of the finger; and

the eccentricity of the finger's ovoid.

A gesture event object may be a chord event object having a chord count (e.g., number of fingers contacted the view or display), a chord start event, a chord change event, and a chord end event. A chord change event may include a scaling or rotation transform.

FIG. 14 illustrates details of an application programming interface in flow chart form according to certain teachings of the present disclosure. The application programming interface operates in an environment with user interface software interacting with a software application in order to provide a scaling transform of a display region, window, or view of a display of a device. The method 1400 for providing the scaling transform includes transferring a scaling transform call to determine a scaling transform for a view associated with a user input having a plurality of input points at block 1402. The method 1400 further includes transferring a scaling gesture start call at block 1404. The method 1400 further includes transferring a scaling gesture progress call at block 1406. The method 1200 further includes transferring a scaling gesture end call at block 1408.

In certain embodiments, a user input in the form of two or more input points (e.g., fingers) moves together or apart to invoke a gesture event that performs a scaling transform on the view associated with the user input. A scale transform includes a minimum and maximum scale factor. FIG. 15 illustrates a display 1502 of a device having a scaling transform of a view. The view 1504 (e.g., web, text, or image content) has a first scale factor. A user input (e.g., two fingers moving apart) associated with the view 1504 is interpreted as a gesture event to zoom out from view 1504 to view 1508 having a second scale factor that exceeds the maximum scale factor of the view 1516. A snapback flag determines whether the zoom out can proceed past the maximum scale factor to view 1508 prior to snapping back to the maximum scale factor associated with view 1516.

FIG. 16A illustrates a display 1604 of a device having a first scaling factor of a view 1616. A user input (e.g., two fingers 1608 and 1610 moving together) associated with the view 1614 is interpreted as a gesture event to zoom in from view 1614 to view 1664 having a second scale factor as illustrated in FIG. 16B. The dashed regions 1602 and 1650 represent the total area of the content with the only content being displayed in the display area 1604 and 1652. In performing the scaling transform from FIG. 16A to FIG. 16B, the center of the gesture event, center 1612 for FIG. 16A and center 1660 for FIG. 16B, remains in the same position with respect to the display 1604. The scroll indicator 1606 shrinks to become scroll indicator 1654 during the transform to indicate that a smaller portion of the total content 1650 is being displayed on display 1604 as a result of the zoom in operation. The dashed region 1650 is larger than the dashed region 1602

14

to represent that a larger portion of content is not being displayed on display 1652 in FIG. 16B as a result of the zoom in operation.

In at least some embodiments of the present disclosure, a user desires to change a view 1670 from a scale factor of 2x to a scale factor of 1x as illustrated in FIG. 16C. A first set of user inputs 1672 and 1674 that move to the second set of user inputs 1676 and 1678 will decrease the scale factor from 2x to 1x. It may be desirable for the user to scale from 2x to 1x without having to move the user inputs a large distance across the view 1670. In an environment with user interface software interacting with a software application, a gesture scaling transform flag may be set in order to determine a scaling transform for a view associated with a user input having a plurality of input points. The scaling transform flag scales either from a current scale factor to a minimum scale factor or from the current scale factor to a maximum scale factor. For example, a flag may be set at the position associated with a 1.5x scale factor and a third set of user inputs 1680 and 1682. A user desiring to change the scale factor from 2x to 1x would only have to move his fingers, the user inputs, from the first set 1672 and 1674 to the third set 1680 and 1682 if the gesture scaling transform flag has been set at a scale factor of 1.5x.

FIG. 17 illustrates details of an application programming interface in flow chart form according to certain teachings of the present disclosure. The application programming interface operates in an environment with user interface software interacting with a software application in order to provide a rotation transform of a view, window, or display region of a display of a device. The method 1700 for providing the rotation transform includes transferring a rotation transform call to determine a rotation transform for a view associated with a user input having a plurality of input points at block 1702. The method 1700 further includes transferring a rotation gesture start call at block 1704. The method 1700 further includes transferring a scaling gesture progress call at block 1706. The method 1700 further includes transferring a scaling gesture end call at block 1708.

In certain embodiments, a user input in the form of two or more input points rotates to invoke a gesture event that performs a rotation transform on the view associated with the user input. The rotation transform includes a minimum and maximum degree of rotation for associated minimum and maximum rotation views. The user input may temporarily rotate a view past a maximum degree of rotation prior to the view snapping back to the maximum degree of rotation.

FIG. 18 illustrates details of an application programming interface in flow chart form according to certain teachings of the present disclosure. The application programming interface operates in an environment with user interface software interacting with a software application in order to notify a delegate of at least one animation associated with a display region, window, or view of a display of a device. A delay in the animation may be specified by the API. Also, multiple animations may be assigned priority by the API. The method 1800 for notifying the delegate includes determining whether any animation occurs at block 1802. The method 1800 further includes checking the progress of an animation at block 1804. If progress has occurred, then the next state (e.g., position, opacity, or transform) of the animation can be calculated at block 1806. If progress has completed at block 1806, then at block 1808 it is determined whether the view associated with the completed animation is associated with a delegate. If so, a delegate call is transferred to notify the delegate of the animation for the view at block 1810. The delegate operating

US 7,844,915 B2

15

under the control of the software application can change other views in response to the view being modified by the animation.

In certain embodiments, software invokes an animation that performs a scaling transform on the view associated with the user input. A display may include numerous views. The view being increased in size by the scaling transform may obstruct other views in which case the other views may need to be reduced in size. Alternatively, the view being decreased in size by the scaling transform may create additional area for other views to increase in size.

FIG. 19 is flow chart of a method for animating a display region, windows, or views displayed on a display of a device. The method 1900 includes starting at least two animations at block 1902. The method 1900 further includes determining the progress of each animation at block 1904. The method 1900 further includes completing each animation based on a single timer at block 1906.

In certain embodiments of the present disclosure, the single timer includes a timer based on a redraw interval which is a time period between the display of a current frame and a next frame of the display of the device. In this case, changes in animation are updated to the display during the redraw interval in order to display the changes during the next frame of the display. The progress of each animation may be calculated periodically or based upon a progress call.

The method 1900 may further include determining whether each animation is associated with a delegate. The delegate is then notified of the animation. Other views not associated with an animation may be changed depending on the software application controlling the delegate.

FIG. 20 is flow chart of a method for animating a display region, windows, or views displayed on a display of a device. The method 2000 includes providing a single animation timer at block 2002. The method 2000 further includes animating a plurality of animations with the single animation timer at block 2004. For example, a single timer may control all animations which occur simultaneously. The animations may include a transform, a frame, and an opacity animation. An animation transform may include a scaling or rotation transform. A frame animation may include resizing of a frame. An opacity animation changes the opacity from opaque to transparent or vice versa.

FIG. 21 illustrates details of an application programming interface in flow chart form according to certain teachings of the present disclosure. The application programming interface operates in an environment with user interface software interacting with multiple software applications or processes in order to synchronize animations associated with multiple views or windows of a display of a device. The method 2100 for synchronizing the animations includes setting attributes of views independently with each view being associated with a process at block 2102. For example, an attribute or property of a view may include a position, size, opacity, etc. An animation alters one or more attributes from a first state to a second state. The method 2100 further includes transferring a synchronization call to synchronize animations for the multiple views of the display at block 2104. The synchronization call may include input parameters or arguments such as an identification of the synchronization of the processes and a list of the processes that are requesting animation of the multiple views. In one embodiment, the synchronization call includes the identification and the number of processes that are requesting animation. In one embodiment, each application or process sends a synchronization call at different times. The method 2100 further includes transferring a synchronization confirmation message when a synchronization flag is

16

enabled at block 2106. The synchronization flag can be enabled when the processes to be synchronized have each sent messages to a window server operating the user interface software. The method 2100 further includes updating the attributes of the views from a first state to a second state independently at block 2108. In one embodiment, the window server receives the updated attributes from each process at different times. The method 2100 further includes transferring a start animation call to draw the requested animations when both processes have updated attributes associated with the second state at block 2110.

In some embodiments, a first data structure or layer tree represents a hierarchy of layers that correspond to the views or windows of the processes. A second data structure or render tree represents a similar copy of the layer tree. However, the render tree is not updated until the independent processes have completed their separate animations. At this time, the render tree updates and redraws the screen with the new animations.

FIGS. 22A and 22B illustrate synchronizing the resizing of views or windows of a display of a device. For example, a window 2210 associated with a first process with a size attribute may increase in size by changing from a first state, window 2210 in FIG. 22A, to a second state window 2210 in FIG. 22B. At approximately the same time, a second window 2220 may decrease in size in proportion to the increase in size of the first window 2210. The method 2100 provides synchronization of the resizing of the windows 2210 and 2220 illustrated in FIGS. 22A and 22B. The animations in changing from the first state to the second state may occur incrementally and occur with the synchronization of method 2100.

FIG. 23 illustrates a method for switching ownership of a view of an application displayed on a display of a data processing device. The method 2300 includes constructing a data structure having a hierarchy of layers with a layer being associated with a view and owning the view at block 2302. The layers may be content, windows, video, images, text, media, or any other type of object for user interface of the application. The method 2300 further includes removing the layer from the data structure at block 2304. The method 2300 further includes switching ownership of the view from the layer to the view at block 2306.

In some embodiments, each layer from the data structure is associated with a view. The layer associated with the view sends a delegate function call to the view in order to generate content provided by the view. A first pointer reference points from the layer to the view. A second pointer reference points from the view to the layer. The number of references pointing to an object such as the view is defined as the retained count of the object. The view may receive notification that the layer will be removed from the data structure. Removing the layer from the data structure may occur based on the view associated with the layer being removed from the display of the device. When the layer is removed from the data structure or layer tree the pointer from the layer to the view will be removed. The view will have a retained count of zero and be deallocated or removed from memory if the ownership of the view is not reversed. The view will have a retained count of at least one if ownership is reversed.

FIG. 24 illustrates a method for memory management of a view of an application displayed on a display of a device. The method 2400 includes constructing a data structure having a hierarchy of layers with at least one layer being associated with the view at block 2402. The method 2400 further includes storing the data structure in memory at block 2404. The method 2400 further includes maintaining a retained count of the number of references to the view from other

US 7,844,915 B2

17

objects at block 2406. The method 2400 further includes deallocating the view from memory if the retained count is zero at block 2408. As discussed above, the retained count of the view will be decremented if the layer is removed from the data structure. Removing the layer from the data structure may occur based on the view associated with the layer being removed from the display of the device.

FIGS. 25A and 25B illustrate a data structure having a hierarchy of layers with a layer being associated with a view. The data structure includes layers 2502, 2504, and 2506. Layer 2506 is associated with the view 2510. The layer 2506 associated with the 2510 view sends a delegate call to the view in order to generate content provided by the view. A first pointer reference 2508 points from the layer 2506 to the view 2510. A second pointer reference 2512 points from the view 2510 to the layer 2506. A third pointer reference 2532 may point from user interface (UI) controller 2530 to the view 2510. The UI controller 2530 may control operations associated with the view 2510 such as scrolling the view 2510 in response to a user input. The view 2510 in FIG. 25A has a retained count of two based on the pointer references 2508 and 2532.

If the layer 2506 is removed from the data structure as illustrated in FIG. 25B, then the pointer 2508 is removed. View 2510 will have a lower retained count as illustrated in FIG. 25B. If view 2510 has a retained count of zero, then the memory storing the view 2510 will be deallocated.

FIG. 26 illustrates a method for compositing media and non-media content of user interface for display on a device. The method 2600 includes constructing a data structure having a hierarchy of layers associated with the user interface of the device at block 2602. The method 2600 further includes determining whether each layer of the data structure is associated with media or non-media content at block 2604. The data structure or layer tree is traversed in order to determine whether each of the layers of the data structure is associated with media or non-media content. The method 2600 further includes detaching a layer associated with media content from the data structure at block 2606. The method 2600 further includes storing media content in a first memory location at block 2606. The method 2600 further includes storing non-media content in a second memory location at block 2608. The method 2600 further includes compositing the media and non-media content for display on the device at block 2610.

In some embodiments, compositing the media and non-media content includes retrieving the media content from the first memory location, retrieving the non-media content from the second memory location, and scanning the media and non-media content directly to the display. The memory location can be any type of memory located in cache, main memory, a graphics processing unit, or other location within a device. The media content may include video, video plugin, audio, image, or other time varying media. The media content may be in the form of a YUV model with the Y representing a luminance component (the brightness) and U and V representing chrominance (color) components. The media content may be scanned to the display at a rate of substantially twenty to forty frames per second. The media content may be scaled prior to being scanned to the display of the device.

The non-media content may include content, views, and images that do not require frequent updating. The non-media content may be in the form of a RGB model which is an additive model in which red, green, and blue (often used in additive light models) are combined in various ways to repro-

18

duce other colors. The non-media content may be scanned to the display at a slower rate compared to the media content.

FIG. 27 illustrates a data structure or layer tree having a hierarchy of layers. The layers can be associated with media and non-media content. For example, layer 2704 is associated with media content 2706 such as a video. Layer 2710 is associated with non-media content 2712 which may be user interface view for the video. Layers 2720, 2730, and 2740 are associated with non-media content 2722, 2732, and 2742, respectively, that forms the components of the non-media content 2712. The method 2600 will determine whether each layer of the data structure is associated with media or non-content. Any layers associated with media content such as layer 2704 will be removed from the data structure and processed in a separate memory location.

In some embodiments, the methods, systems, and apparatuses of the present disclosure can be implemented in various devices including electronic devices, consumer devices, data processing devices, desktop computers, portable computers, wireless devices, cellular devices, tablet devices, handheld devices, multi touch devices, multi touch data processing devices, any combination of these devices, or other like devices. FIGS. 4-6 and 28-33 illustrate examples of a few of these devices.

FIG. 28 illustrates a device 2800 according to one embodiment of the disclosure. FIG. 28 shows a wireless device in a telephone configuration having a "candy-bar" style. In FIG. 28, the wireless device 2800 may include a housing 2832, a display device 2834, an input device 2836 which may be an alphanumeric keypad, a speaker 2838, a microphone 2840 and an antenna 2842. The wireless device 2800 also may include a proximity sensor 2844 and an accelerometer 2846. It will be appreciated that the embodiment of FIG. 28 may use more or fewer sensors and may have a different form factor from the form factor shown in FIG. 28.

The display device 2834 is shown positioned at an upper portion of the housing 2832, and the input device 2836 is shown positioned at a lower portion of the housing 2832. The antenna 2842 is shown extending from the housing 2832 at an upper portion of the housing 2832. The speaker 2838 is also shown at an upper portion of the housing 2832 above the display device 2834. The microphone 2840 is shown at a lower portion of the housing 2832, below the input device 3286. It will be appreciated that the speaker 2838 and microphone 2840 can be positioned at any location on the housing, but are typically positioned in accordance with a user's ear and mouth, respectively.

The display device 2834 may be, for example, a liquid crystal display (LCD) which does not include the ability to accept inputs or a touch input screen which also includes an LCD. The input device 2836 may include, for example, buttons, switches, dials, sliders, keys or keypad, navigation pad, touch pad, touch screen, and the like. Any well-known speaker, microphone and antenna can be used for speaker 2838, microphone 2840 and antenna 2842, respectively.

The data acquired from the proximity sensor 2844 and the accelerometer 2846 can be combined together, or used alone, to gather information about the user's activities. The data from the proximity sensor 2844, the accelerometer 2846 or both can be used, for example, to activate/deactivate a display backlight, initiate commands, make selections, control scrolling, gesturing, animating or other movement in a display, control input device settings, or to make other changes to one or more settings of the device. In certain embodiments of the present disclosure, the device 2800 can be used to implement at least some of the methods discussed in the present disclosure.

US 7,844,915 B2

19

FIG. 29 shows a device 2950 in accordance with one embodiment of the disclosure. The device 2950 may include a housing 2952, a display/input device 2954, a speaker 2956, a microphone 2958 and an optional antenna 2960 (which may be visible on the exterior of the housing or may be concealed within the housing). The device 2950 also may include a proximity sensor 2962 and an accelerometer 2964. The device 2950 may be a cellular telephone or a device which is an integrated PDA and a cellular telephone or a device which is an integrated media player and a cellular telephone or a device which is both an entertainment system (e.g. for playing games) and a cellular telephone, or the device 2950 may be other types of devices described herein. In one particular embodiment, the device 2950 may include a cellular telephone and a media player and a PDA, all contained within the housing 2952. The device 2950 may have a form factor which is small enough that it fits within the hand of a normal adult and is light enough that it can be carried in one hand by an adult. It will be appreciated that the term "portable" means the device can be easily held in an adult user's hands (one or both); for example, a laptop computer and an iPod are portable devices.

In one embodiment, the display/input device 2954 may include a multi-point touch input screen in addition to being a display, such as an LCD. In one embodiment, the multi-point touch screen is a capacitive sensing medium configured to detect multiple touches (e.g., blobs on the display from a user's face or multiple fingers concurrently touching or nearly touching the display) or near touches (e.g., blobs on the display) that occur at the same time and at distinct locations in the plane of the touch panel and to produce distinct signals representative of the location of the touches on the plane of the touch panel for each of the multiple touches.

In certain embodiments of the present disclosure, the device 2800 can be used to implement at least some of the methods discussed in the present disclosure.

FIGS. 30A and 30B illustrate a device 3070 according to one embodiment of the disclosure. The device 3070 may be a cellular telephone which includes a hinge 3087 that couples a display housing 3089 to a keypad housing 3091. The hinge 3087 allows a user to open and close the cellular telephone so that it can be placed in at least one of two different configurations shown in FIGS. 30A and 30B. In one particular embodiment, the hinge 3087 may rotatably couple the display housing to the keypad housing. In particular, a user can open the cellular telephone to place it in the open configuration shown in FIG. 30A and can close the cellular telephone to place it in the closed configuration shown in FIG. 30B. The keypad housing 3091 may include a keypad 3095 which receives inputs (e.g. telephone number inputs or other alphanumeric inputs) from a user and a microphone 3097 which receives voice input from the user. The display housing 3089 may include, on its interior surface, a display 3093 (e.g. an LCD) and a speaker 3098 and a proximity sensor 3084; on its exterior surface, the display housing 3089 may include a speaker 3096, a temperature sensor 3094, a display 3088 (e.g. another LCD), an ambient light sensor 3092, and a proximity sensor 3084A. Hence, in this embodiment, the display housing 3089 may include a first proximity sensor on its interior surface and a second proximity sensor on its exterior surface.

In at least certain embodiments, the device 3070 may contain components which provide one or more of the functions of a wireless communication device such as a cellular telephone, a media player, an entertainment system, a PDA, or other types of devices described herein. In one implementation of an embodiment, the device 3070 may be a cellular

20

telephone integrated with a media player which plays MP3 files, such as MP3 music files.

Each of the devices shown in FIGS. 4, 5A, 5B, 5C, 6A, 6B, 6C, 6D, 28, 29, 30A and 30B may be a wireless communication device, such as a cellular telephone, and may include a plurality of components which provide a capability for wireless communication. FIG. 31 shows an embodiment of a wireless device 3070 which includes the capability for wireless communication. The wireless device 3070 may be included in any one of the devices shown in FIGS. 4, 5A, 5B, 5C, 6A, 6B, 6C, 6D, 28, 29, 30A and 30B, although alternative embodiments of those devices of FIGS. 4, 5A, 5B, 5C, 6A, 6B, 6C, 6D, 28, 29, 30A and 30B may include more or fewer components than the Wireless device 3070.

Wireless device 3070 may include an antenna system 3101. Wireless device 3070 may also include a digital and/or analog radio frequency (RF) transceiver 3102, coupled to the antenna system 3101, to transmit and/or receive voice, digital data and/or media signals through antenna system 3101.

Wireless device 3070 may also include a digital processing system 3103 to control the digital RF transceiver and to manage the voice, digital data and/or media signals. Digital processing system 3103 may be a general purpose processing device, such as a microprocessor or controller for example.

Digital processing system 3103 may also be a special purpose processing device, such as an ASIC (application specific integrated circuit), FPGA (field-programmable gate array) or DSP (digital signal processor). Digital processing system 3103 may also include other devices, as are known in the art, to interface with other components of wireless device 3070. For example, digital processing system 3103 may include analog-to-digital and digital-to-analog converters to interface with other components of wireless device 3070. Digital processing system 3103 may include a media processing system 3109, which may also include a general purpose or special purpose processing device to manage media, such as files of audio data.

Wireless device 3070 may also include a storage device 3104, coupled to the digital processing system, to store data and/or operating programs for the Wireless device 3070. Storage device 3104 may be, for example, any type of solid-state or magnetic memory device.

Wireless device 3070 may also include one or more input devices 3105, coupled to the digital processing system 3103, to accept user inputs (e.g., telephone numbers, names, addresses, media selections, etc.) Input device 3105 may be, for example, one or more of a keypad, a touchpad, a touch screen, a pointing device in combination with a display device or similar input device.

Wireless device 3070 may also include at least one display device 3106, coupled to the digital processing system 3103, to display information such as messages, telephone call information, contact information, pictures, movies and/or titles or other indicators of media being selected via the input device 3105. Display device 3106 may be, for example, an LCD display device. In one embodiment, display device 3106 and input device 3105 may be integrated together in the same device (e.g., a touch screen LCD such as a multi-touch input panel which is integrated with a display device, such as an LCD display device). The display device 3106 may include a backlight 3106A to illuminate the display device 3106 under certain circumstances. It will be appreciated that the Wireless device 3070 may include multiple displays.

Wireless device 3070 may also include a battery 3107 to supply operating power to components of the system including digital RF transceiver 3102, digital processing system 3103, storage device 3104, input device 3105, microphone

US 7,844,915 B2

21

310A, audio transducer 3108, media processing system 3109, sensor(s) 3110, and display device 3106. Battery 3107 may be, for example, a rechargeable or non-rechargeable lithium or nickel metal hydride battery. Wireless device 3070 may also include audio transducers 3108, which may include one or more speakers, and at least one microphone 3105A. In certain embodiments of the present disclosure, the wireless device 3070 can be used to implement at least some of the methods discussed in the present disclosure.

FIG. 32 shows another example of a device according to an embodiment of the disclosure. This device 3200 may include a processor, such as microprocessor 3202, and a memory 3204, which are coupled to each other through a bus 3206. The device 3200 may optionally include a cache 3208 which is coupled to the microprocessor 3202. This device may also optionally include a display controller and display device 3210 which is coupled to the other components through the bus 3206. One or more input/output controllers 3212 are also coupled to the bus 3206 to provide an interface for input/output devices 3214 and to provide an interface for one or more sensors 3216 which are for sensing user activity. The bus 3206 may include one or more buses connected to each other through various bridges, controllers, and/or adapters as is well known in the art. The input/output devices 3214 may include a keypad or keyboard or a cursor control device such as a touch input panel. Furthermore, the input/output devices 3214 may include a network interface which is either for a wired network or a wireless network (e.g. an RF transceiver). The sensors 3216 may be any one of the sensors described herein including, for example, a proximity sensor or an ambient light sensor. In at least certain implementations of the device 3200, the microprocessor 3202 may receive data from one or more sensors 3216 and may perform the analysis of that data in the manner described herein. For example, the data may be analyzed through an artificial intelligence process or in the other ways described herein. As a result of that analysis, the microprocessor 3202 may then automatically cause an adjustment in one or more settings of the device.

In certain embodiments of the present disclosure, the device 3200 can be used to implement at least some of the methods discussed in the present disclosure.

FIGS. 33A-C show another example of a device according to at least certain embodiments of the disclosure. FIG. 33A illustrates a laptop device 3300 with a keyboard 3302, a body 3304, a display frame 3306, and a display 3308. The laptop device 3300 can be converted into a tablet device as illustrated in FIG. 33B and FIG. 33C. FIG. 33B illustrates the conversion of the laptop device into a tablet device. An edge of a display frame 3356 containing a display 3358 is slide within the body 3354 across the top of a keyboard 3352 until forming a tablet device as illustrated in FIG. 33C. The tablet device with a display 2362 and a display frame 3366 rests on top of a body 3360.

In certain embodiments of the present disclosure, the laptop device 3300 can be used to implement at least some of the methods discussed in the present disclosure.

FIG. 34 illustrates details of an application programming interface in flow chart form according to certain teachings of the present disclosure. The application programming interface operates in an environment with user interface software interacting with a software application. In some embodiments, a hierarchy of views operates on top of a hierarchy of layers within the user interface software. The API operates as illustrated in method 3400 that includes constructing a hierarchy of views operating on top of a hierarchy of layers at block 3402. The method 3400 further includes providing access to the hierarchy of views without providing access to

22

the hierarchy of layers at block 3404. An application may interact with the hierarchy of views via the API without accessing the hierarchy of layers operating below the hierarchy of views.

In some embodiments, a platform provides various scrolling, gesturing, and animating operations. The platform includes hardware components and an operating system. The hardware components may include a processing unit coupled to an input panel and a memory coupled to the processor. The operating system includes one or more programs that are stored in the memory and configured to be executed by the processing unit. One or more programs include various instructions for transferring function calls or messages through an application programming interface in order to perform various scrolling, gesturing, and animating operations.

In an embodiment, the one or more programs include instructions for transferring a bounce call through an API to cause a bounce of a scrolled region in an opposite direction of a scroll based on a region past an edge of the scrolled region being visible in a display region at the end of the scroll. In an embodiment, the one or more programs include instructions for transferring a rubberband call through an API to cause a rubberband effect on a scrolled region by a predetermined maximum displacement when the scrolled region exceeds a display edge based on a scroll. In an embodiment, the one or more programs include instructions for transferring a directional scroll call through an API to set a scroll angle for locking the scrolling in at least one of a vertical or a horizontal direction.

In an embodiment, the one or more programs include instructions for transferring a scroll hysteresis call through an API to determine whether a user input invokes a scroll. In an embodiment, the one or more programs include instructions for transferring a deceleration scroll call through an API to set a deceleration factor for a user input based on the user input invoking a scroll. In an embodiment, the one or more programs include instructions for transferring a scroll indicator call through an API to determine whether at least one scroll indicator attaches to a content edge or a display edge of a display region.

In some embodiments, the platform includes a framework containing a library of software code. The framework interacts with the programs of the platform to provide application programming interfaces for performing various scrolling, gesturing, and animating operations. The framework also includes associated resources (e.g., images, text, etc.) that are stored in a single directory.

In an embodiment, the library of the framework provides an API for specifying a bounce operation to cause a bounce of a scrolled region in an opposite direction of a scroll based on a region past an edge of the scrolled region being visible in a display region at the end of the scroll. In an embodiment, the library of the framework provides an API for specifying a rubberband operation that has a rubberband effect on a scrolled region by a predetermined maximum displacement when the scrolled region exceeds a display edge based on a scroll. In an embodiment, the library of the framework provides an API for specifying a directional scroll operation to set a scroll angle for locking the scrolling in at least one of a vertical or a horizontal direction.

In an embodiment, the library of the framework provides an API for specifying a scroll hysteresis operation to determine whether a user input invokes a scroll. In an embodiment, the library of the framework provides an API for specifying a deceleration scroll operation to set a deceleration factor for a user input based on the user input invoking a scroll. In an

US 7,844,915 B2

23

embodiment, the library of the framework provides an API for specifying a scroll indicator operation to determine whether at least one scroll indicator attaches to a content edge or a display edge of a display region.

In the foregoing specification, the disclosure has been described with reference to specific exemplary embodiments thereof. It will be evident that various modifications may be made thereto without departing from the broader spirit and scope of the disclosure as set forth in the following claims. The specification and drawings are, accordingly, to be regarded in an illustrative sense rather than a restrictive sense.

What is claimed is:

1. A machine implemented method for scrolling on a touch-sensitive display of a device comprising:

receiving a user input, the user input is one or more input points applied to the touch-sensitive display that is integrated with the device;

creating an event object in response to the user input; determining whether the event object invokes a scroll or gesture operation by distinguishing between a single input point applied to the touch-sensitive display that is interpreted as the scroll operation and two or more input points applied to the touch-sensitive display that are interpreted as the gesture operation;

issuing at least one scroll or gesture call based on invoking the scroll or gesture operation;

responding to at least one scroll call, if issued, by scrolling a window having a view associated with the event object based on an amount of a scroll with the scroll stopped at a predetermined position in relation to the user input; and

responding to at least one gesture call, if issued, by scaling the view associated with the event object based on receiving the two or more input points in the form of the user input.

2. The method as in claim 1, further comprising:

rubberbanding a scrolling region displayed within the window by a predetermined maximum displacement when the scrolling region exceeds a window edge based on the scroll.

3. The method as in claim 1, further comprising: attaching scroll indicators to a content edge of the window.

4. The method as in claim 1, further comprising: attaching scroll indicators to the window edge.

5. The method as in claim 1, wherein determining whether the event object invokes a scroll or gesture operation is based on receiving a drag user input for a certain time period.

6. The method as in claim 1, further comprising:

responding to at least one gesture call, if issued, by rotating a view associated with the event object based on receiving a plurality of input points in the form of the user input.

7. The method as in claim 1, wherein the device is one of: a data processing device, a portable device, a portable data processing device, a multi touch device, a multi touch portable device, a wireless device, and a cell phone.

8. A machine readable storage medium storing executable program instructions which when executed cause a data processing system to perform a method comprising:

24

receiving a user input, the user input is one or more input points applied to a touch-sensitive display that is integrated with the data processing system;

creating an event object in response to the user input;

determining whether the event object invokes a scroll or gesture operation by distinguishing between a single input point applied to the touch-sensitive display that is interpreted as the scroll operation and two or more input points applied to the touch-sensitive display that are interpreted as the gesture operation;

issuing at least one scroll or gesture call based on invoking the scroll or gesture operation;

responding to at least one scroll call, if issued, by scrolling a window having a view associated with the event object; and

responding to at least one gesture call, if issued, by scaling the view associated with the event object based on receiving the two or more input points in the form of the user input.

9. The medium as in claim 8, further comprising:

rubberbanding a scrolling region displayed within the window by a predetermined maximum displacement when the scrolled region exceeds a window edge based on the scroll.

10. The medium as in claim 8, further comprising:

attaching scroll indicators to a content edge of the view.

11. The medium as in claim 8, further comprising:

attaching scroll indicators to a window edge of the view.

12. The medium as in claim 8, wherein determining whether the event object invokes a scroll or gesture operation is based on receiving a drag user input for a certain time period.

13. The medium as in claim 8, further comprising:

responding to at least one gesture call, if issued, by rotating a view associated with the event object based on receiving a plurality of input points in the form of the user input.

14. The medium as in claim 8, wherein the data processing system is one of: a data processing device, a portable device, a portable data processing device, a multi touch device, a multi touch portable device, a wireless device, and a cell phone.

15. An apparatus, comprising:

means for receiving, through a hardware device, a user input on a touch-sensitive display of the apparatus, the user input is one or more input points applied to the touch-sensitive display that is integrated with the apparatus;

means for creating an event object in response to the user input;

means for determining whether the event object invokes a scroll or gesture operation by distinguishing between a single input point applied to the touch-sensitive display that is interpreted as the scroll operation and two or more input points applied to the touch-sensitive display that are interpreted as the gesture operation;

means for issuing at least one scroll or gesture call based on invoking the scroll or gesture operation;

means for responding to at least one scroll call, if issued, by scrolling a window having a view associated with the event object; and

US 7,844,915 B2

25

means for responding to at least one gesture call, if issued, by scaling the view associated with the event object based on receiving the two or more input points in the form of the user input.

16. The apparatus as in claim 15, further comprising: means for rubberbanding a scrolling region displayed within the window by a predetermined maximum displacement when the scrolling region exceeds a window edge based on the scroll.

17. The apparatus as in claim 15, further comprising: means for attaching scroll indicators to a content edge of the window.

18. The apparatus as in claim 15, further comprising: means for attaching scroll indicators to the window edge.

26

19. The apparatus as in claim 15, wherein determining whether the event object invokes a scroll or gesture operation is based on receiving a drag user input for a certain time period.

5 20. The apparatus as in claim 15, further comprising: means for responding to at least one gesture call, if issued, by rotating a view associated with the event object based on receiving a plurality of input points in the form of the user input.

10 21. The apparatus as in claim 15, wherein the apparatus is one of: a data processing device, a portable device, a portable data processing device, a multi touch device, a multi touch portable device, a wireless device, and a cell phone.

* * * * *