

nk

**Consumer Multimedia Semiconductors and Applications Worldwide—MSAM-WW**

Check  
to  
Re-  
order

Document  
Code

Publication  
Date

Document Title

**Tab: Perspective**

<input checked="" type="checkbox"/>	MSAM-WWW-DP-9701	January 27, 1997	DBS "Stars" Shine at Winter CES
<input checked="" type="checkbox"/>	MSAM-WWW-DP-9702	January 28, 1997	Reality Bites 1997 Winter Consumer Electronics Show
<input checked="" type="checkbox"/>	MSAM-WWW-DP-9703	January 29, 1997	DVD 1997: Are We There Yet?
<input checked="" type="checkbox"/>	MSAM-WWW-DP-9704	March 10, 1997	Consumer Electronics Semiconductor Application Market Quarterly Outlook: The Year Santa Never Came
<input checked="" type="checkbox"/>	MSAM-WWW-DP-9705	March 31, 1997	The Sun Rises on the Digital Camcorder Market
<input checked="" type="checkbox"/>	MSAM-WWW-DP-9706	March 25, 1997	WebTV: Convergence Creates New Opportunities in Digital Consumer Electronics
<input checked="" type="checkbox"/>	MSAM-WWW-DP-9707	June 2, 1997	Flash Memory Digital Film Standards Battle Heats Up
<input checked="" type="checkbox"/>	MSAM-WWW-DP-9708	June 23, 1997	Consumer Electronics Semiconductor Application Market Quarterly Outlook: First Quarter Blues
<input checked="" type="checkbox"/>	MSAM-WWW-DP-9709	September 1, 1997	Consumer Electronics Chip Competition: The Game Moves to the Next Level
<input checked="" type="checkbox"/>	MSAM-WWW-DP-9710	September 8, 1997	C-Cube Charts Path to Consumer MPEG-2 Codec Markets
<input checked="" type="checkbox"/>	MSAM-WWW-DP-9711	October 13, 1997	PC Multimedia Chip Vendors Climb a Rocky Slope
<input checked="" type="checkbox"/>	MSAM-WWW-DP-9712	November 3, 1997	Consumer Electronics Semiconductor Application Market Second Quarter Outlook
<input checked="" type="checkbox"/>	MSAM-WWW-DP-9713	December 15, 1997	Powerful Chips Drive New Consumer Electronics Market
<input checked="" type="checkbox"/>	MSAM-WWW-DP-9714	December 15, 1997	Set-Top Chip Market Hits an Air Pocket but Keeps Soaring Higher

**Tab: Market Trends**

<input checked="" type="checkbox"/>	MSAM-WWW-MT-9701	April 14, 1997	Home Appliance and Home Automation Semiconductor Application Markets
<input checked="" type="checkbox"/>	MSAM-WWW-MT-9702	July 14, 1997	Home Theater Is Music to the Ears of a Slowing Audio Market
<input checked="" type="checkbox"/>	MSAM-WWW-MT-9703	December 1, 1997	Consumer Electronics Semiconductor Forecast: Next-Generation Products Carry the Market into the 21 <sup>st</sup> Century
<input checked="" type="checkbox"/>	MSAM-WWW-MT-9704	December 15, 1997	Video, Interactive, and Personal Electronics Semiconductor Market Trends

**Tab: Reports**

<input checked="" type="checkbox"/>	MSAM-WWW-FR-9701	February 10, 1997	Digital Still Cameras Develop into a New Semiconductor Market
<input checked="" type="checkbox"/>	MSAM-WWW-FR-9702	April 21, 1997	Digital Television Semiconductors: Finding the Opportunity
<input checked="" type="checkbox"/>	MSAM-WWW-CT-9701	May 19, 1997	MPUs and MCUs Battle for the Hearts of Next-Generation Consumer Products
<input checked="" type="checkbox"/>	MSAM-WWW-CT-9702	August 25, 1997	1996 Consumer Electronics Semiconductor Market Share



3

1  
2  
3  
4

5  
6

7  
8  
9

10  
11  
12  
13  
14  
15

16  
17  
18  
19  
20  
21

22  
23  
24

25  
26  
27  
28  
29  
30  
31  
32  
33  
34  
35

36  
37  
38  
39  
40  
41  
42  
43  
44  
45  
46  
47  
48  
49  
50  
51  
52  
53  
54  
55  
56  
57  
58  
59  
60  
61  
62  
63  
64  
65  
66  
67  
68  
69  
70  
71  
72  
73  
74  
75  
76  
77  
78  
79  
80  
81  
82  
83  
84  
85  
86  
87  
88  
89  
90  
91  
92  
93  
94  
95  
96  
97  
98  
99  
100

101  
102  
103  
104  
105  
106  
107  
108  
109  
110  
111  
112  
113  
114  
115  
116  
117  
118  
119  
120  
121  
122  
123  
124  
125  
126  
127  
128  
129  
130  
131  
132  
133  
134  
135  
136  
137  
138  
139  
140  
141  
142  
143  
144  
145  
146  
147  
148  
149  
150  
151  
152  
153  
154  
155  
156  
157  
158  
159  
160  
161  
162  
163  
164  
165  
166  
167  
168  
169  
170  
171  
172  
173  
174  
175  
176  
177  
178  
179  
180  
181  
182  
183  
184  
185  
186  
187  
188  
189  
190  
191  
192  
193  
194  
195  
196  
197  
198  
199  
200

201  
202  
203  
204  
205  
206  
207  
208  
209  
210  
211  
212  
213  
214  
215  
216  
217  
218  
219  
220  
221  
222  
223  
224  
225  
226  
227  
228  
229  
230  
231  
232  
233  
234  
235  
236  
237  
238  
239  
240  
241  
242  
243  
244  
245  
246  
247  
248  
249  
250  
251  
252  
253  
254  
255  
256  
257  
258  
259  
260  
261  
262  
263  
264  
265  
266  
267  
268  
269  
270  
271  
272  
273  
274  
275  
276  
277  
278  
279  
280  
281  
282  
283  
284  
285  
286  
287  
288  
289  
290  
291  
292  
293  
294  
295  
296  
297  
298  
299  
300



## CONSUMER MULTIMEDIA SEMICONDUCTORS AND APPLICATIONS WORLDWIDE

*Consumer Multimedia Semiconductors and Applications (MSAM) is Dataquest's applications market program that focuses on semiconductor opportunities in the multimedia and consumer electronics markets, with emphasis on interactive, video, audio, and home convenience technologies.*

### Key Topics

The Consumer Multimedia Semiconductors and Applications program provides advice and analysis to help clients make successful business decisions. Publications include a mix of analytical articles, weekly news bulletins and event-driven faxes, focused reports, and timely market statistics published on a regular schedule throughout the year. Briefings and conference presentations bring clients together with analysts to share insights

and opinions. Key semiconductor application topics covered throughout the year in our publications and briefings will include:

- The forces shaping the development of ASIC and ASSP products for next-generation consumer electronics
- The growing memory market in consumer electronics and the impact of memory prices on market growth
- Key compression standards and chips and

the role they play in the digital consumer electronics age

- The development of the DVD video market and the creation of a DVD audio standard
- The growth of the DBS set-top box market and the emergence of the DVB standard
- The competitive/converging dynamics between PCs and consumer electronics and the opportunities for media engines in consumer electronics

Want to learn more about Dataquest?

Please visit **Dataquest Interactive** our Internet-based information service at: [www.dataquest.com](http://www.dataquest.com)

### Market Coverage

This program provides a comprehensive view of the products, applications, and semiconductor suppliers for the consumer electronics and home multimedia markets. Statistics include:

- Electronic equipment production estimates
- Semiconductor consumption by application market
- Market share and competitive analysis of multimedia/consumer IC manufacturers
- Consumer electronics-specific IC forecasts

### Application and Device Coverage

Market and production information for systems and semiconductors includes:

- Set-top boxes (Cable/DBS)
- Video game controllers, cable adapters, and cartridges
- DVD video and audio products
- Digital cameras
- Televisions (HDTV)
- VCRs
- Camcorders

- CD players
- Personal portable stereos (boom boxes, MD, DCC)
- Stereo components
- Multimedia PC (top-level data only)
- Appliances
- Video and graphics ASICs
- Compression chips (for example, AC-3, MPEG 1 and 2)
- Media engines
- 2-D CCDs

### Complementary Research

Dataquest offers complementary services, including bill of materials of electronic equipment.

## WHAT YOU WILL RECEIVE AS A CLIENT

# CONSUMER MULTIMEDIA SEMICONDUCTORS AND APPLICATIONS WORLDWIDE



### Perspectives

Event Summary  
Product Analysis  
Market Analysis  
Technology Analysis  
Competitive Analysis  
Vendor Analysis  
Dataquest Predicts

**Dataquest Perspectives:** These research documents provide analysis and commentary on key technologies, companies, products, market opportunities, events, trends, and strategic issues in the consumer multimedia and semiconductor industries. A minimum of 12 Dataquest Perspectives will be delivered to you on a regular schedule throughout the year. Topical in nature, these documents provide timely information and advice to help you stay ahead of your competition.

*Twelve Issues Available Throughout 1997*



### Market Trends

**Consumer Applications Market Trends Reports:** Market size and forecasts for principal consumer interactive and multimedia, video, audio, and appliance markets. Three reports will provide basic information about the semiconductor opportunity offered by particular applications. Information provided includes system market size (in production terms) in revenue, units, and average selling price; system market and product feature trends; hardware architecture trends; semiconductor content and market forecasts; and a listing of key OEMs.

- **Appliances/Home Convenience Application Markets** Q2/97
- **Audio Application Markets** Q3/97
- **Video, Interactive, and Personal Electronics Application Markets** Q4/97

**Consumer Semiconductor Consumption Forecast:** Five-year forecasts for consumer electronics-specific semiconductor consumption in major categories of consumer electronics equipment. Forecasts for multimedia and interactive products are closely tied to electronic equipment product forecasts produced by Dataquest's Multimedia research group.

*Available Fourth Quarter 1997*



### Electronic News

News and analysis delivered directly to your desktop

Clients have a choice of receiving one of the following weekly electronic newsletters:

- **DQ Monday Report:** Top news and commentary on semiconductor industry events and issues with a monthly snapshot of semiconductor pricing for 25 key semiconductors in six regions.
- **QuickTakes:** Top stories in the online, multimedia, and software industries. Each story is capped with the "DQ Take," our expert analysis of the news.

*Available Weekly via Electronic Mail*

**Dataquest Alerts:** These fax bulletins provide analysis of fast-breaking news, events, or announcements in the industry, as they unfold. Alerts also will be provided in hard copy to file in your binder.

*Event-Driven Faxes*

### Inquiry Support

Personalized inquiry support is a primary component of your annual subscription program. Dataquest analysts work with you to tailor the program to meet your needs.



### Market Statistics

**Worldwide Semiconductor Consumption and Shipment Forecast:** Five-year revenue forecasts for the global semiconductor market by region.

*Available Second and Fourth Quarters 1997*



### Special Reports

Focus Report  
Competitive Trends Report  
Industry Trends Report  
Company Profile Report

**Competitive Trends—Consumer Electronics Semiconductor Supplier Analysis:** Examines the competitive landscape of the consumer electronics and home multimedia semiconductor markets. Market share for companies supplying consumer electronics-specific chips and supplier matrices are provided for major product areas.

*Available Third Quarter 1997*

## Dataquest

A Gartner Group Company

Corporate Headquarters  
251 River Oaks Parkway  
San Jose, CA 95134-1913  
United States  
Phone: 1-408-468-6000  
Fax: 1-408-954-1780  
Fax-Back: 1-800-328-2954 and press 4

Boston Area  
Nine Technology Drive  
P.O. Box 5083  
Westborough, MA 01581-5083  
United States  
Phone: 1-508-871-5555  
Fax: 1-508-871-6262

United Kingdom  
Tamesis  
The Gianty  
Egham  
Surrey TW20 9AW  
United Kingdom  
Phone: +44 1784 43 1811  
Fax: +44 1784 48 8980

Asia/Pacific  
Suite 5904-7, Central Plaza  
18 Harbour Road  
Wan Chai  
Hong Kong  
Phone: 852-2824-6168  
Fax: 852-2824-6138

Japan  
Aobadai Hills 4-7-7  
Aobadai  
Meguro-ku  
Tokyo 153  
Japan  
Phone: 813-3481-3670  
Fax: 813-3481-3644

# **Dataquest** *A L E R T*

---

251 River Oaks Parkway • San Jose • CA • 95134-1913 • Phone 408-468-8000 • Fax 408-954-1780

## **Recent Deals Show Cable Has Regained Its Spark**

Two separate deals struck this week—each worth more than \$1 billion—show that the cable television business has regained its reputation as a vital industry with a strong future.

In a bid to ensure that its vision for digital television and high-speed Internet (data) access can be realized, Microsoft Corporation spent \$1 billion to gain a stake in cable television operator Comcast Corporation. Throwing its lot in with the cable industry, News Corporation made a \$1 billion deal to sell its U.S.-based satellite holdings to Primestar Partners L.P., a satellite television service currently owned by a group of the country's largest cable television companies.

These moves by the world's largest software company and one of the world's leading television programmers shows how far the reputation of the cable industry has come in less than one year. In mid-1996, the cable industry was saddled with a reputation for arrogance and poor customer service. The industry already was under siege from satellite television providers like DirectTV and EchoStar and the threat of News Corporation's impending entry into the U.S. satellite market. Ambitious digital television deployment plans from the telcos had cast a pall over the cable television industry. Cable companies' continual failure to live up to their promises of upgrading to new digital technology stirred up further concerns about the legitimacy of the cable industry and its capability to keep up with changing times. Many observers doubted that cash-poor cable companies could muster the capital to upgrade their networks with the digital technology that could allow them to stay competitive with the growing satellite and telco competition.

But in mid-1997, the cable scene looks quite different. Despite the accelerated rise of satellite television subscriptions in 1996, cable still managed a net increase in customers for the year. Meanwhile, satellite television subscription growth in the United States appears to be slowing somewhat in 1997. At the same time, the telcos have been retreating from their digital television plans, reducing the threat of a big new competitor entering into the television market.

As external pressures have eased, the cable companies have worked to get their own house in order. While they still have a long way to go to fix their image (as evidenced by Jim Carey's "The Cable Guy") they have put a priority on improving customer service. But the most telling evidence of change in the cable industry are the announcements of major digital deployments, a significant investment in their own futures. TCI has announced 90% of its 14 million customers will have access to digital service by the end of 1997, and Comcast also has committed to deploying digital technology.

## Microsoft's Romance with Comcast

It is this move to digital technology that has attracted Microsoft to Comcast. In April, Microsoft announced its approach to digital television (DTV) in cooperation with Intel Corporation and Compaq Computer Corporation. Together, the three companies announced an approach to DTV that involves the use of standard definition, progressive scan video enhanced with Internet data. Hoping to attract the support of the nation's broadcast networks, the three firms said they could provide a PC-based platform for DTV that will be cheaper, more appealing to consumers, and available in higher volumes faster than the interlaced-scan, high-definition televisions (HDTVs) that the consumer electronics industry initially plans to offer. Thus, Microsoft and its PC company allies hope to steal a portion of the 118 million unit-per-year television industry from the consumer electronics firms that own it now.

However, Microsoft's efforts to establish its format have run into resistance from network broadcasters who are suspicious of its motives. In addition, the technology to create progressive scan video is not yet widely available, casting doubt on the near-term technical feasibility of the PC industry's approach to DTV. Though Microsoft says it is still in productive dialogue with the networks, its goal of having programming for large volumes of DTV-enabled PCs by late 1998 may not be fulfilled, putting the computer industry's DTV plans in jeopardy.

With the Comcast deal, Microsoft now has partial ownership of a fat digital pipeline that someday will be capable of transmitting its version of DTV to as many as 7 million homes per year. Microsoft said it is in negotiation with other cable companies concerning DTV broadcasting, and has found them receptive to the idea. The Comcast deal gives Microsoft a \$1 billion ace-in-the-hole for its DTV technology and an example that could serve to attract the reticent networks to its DTV approach. The Comcast deal also has other dimensions, possibly providing a fast delivery mechanism for the WebTV Network Inc.'s Internet network service, which Microsoft acquired in April.

Microsoft said much of the \$1 billion it has invested in Comcast will be used to support the cable company's move to offer video over high speed digital networks. Altogether, Microsoft has invested a lot of money and a lot of its strategic plans in Comcast and cable in general, a major vote of confidence in an industry that a short time ago appeared moribund.

## News Corporation Sells Satellite Operations to Primestar

The second vote of confidence for the cable industry this week came from the unlikely source of Rupert Murdoch's News Corporation, which sold its ASkyB U.S. satellite television operations to the cable industry-held Primestar. ASkyB owned two high-power satellites under construction and a license to operate an satellite television service at an orbital location that had been coveted by Primestar. This is an amazing reversal of fortune for News Corporation, which once was considered the greatest threat to the American cable industry to ever arise. The deal gives News Corporation possession of \$1.1 billion worth of nonvoting Primestar securities. Primestar also announced it will restructure itself into a publicly-traded company.

News Corporation made the sale for several reasons. The company's primary motivation in establishing satellite television service in the United States and around the world was to provide an outlet for its extensive Fox programming. However, with the collapse of its deal to purchase EchoStar, it was clear that it would take billions of dollars and several years before it could establish satellite broadcasting in

America. The deal with Primestar gives News Corporation an instant presence in the United States, giving it a share of the country's second-largest digital satellite service, with 1.8 million subscribers.

On another level, the Primestar deal buys News Corporation some priceless goodwill with the cable industry. PrimeStar's cable owners – which include TCI, Time Warner, Comcast, and Cox – for four years had been attempting to secure an orbital slot that would allow it to expand and improve its service with high-power broadcast. News Corporation has now sold Primestar such a slot for a fair price. The deal does not include a guarantee that the owners of Primestar will carry Fox programming on their cable networks. However, it is likely Cable executives will now view Fox programming more favorably as it now comes from a deep-pocketed partner rather than from a dreaded competitor. And as cable networks increase their programming capacity with digital technology, there will be more room for News Corporation's Fox programming. Murdoch clearly has his eye on getting his programming carried on the new digital cable networks.

## **Digital Cable Carries Opportunities for Chipmakers**

The move to digital technology in the cable market provides a wealth of opportunities for semiconductor manufacturers. Reports from equipment manufacturers reveal solid orders and deliveries of infrastructure and subscriber equipment required for the digital upgrade. Cable makers will be upgrading their networks to digital speeds over the next several years, adding new digital head-ends and equipment to support two-way communications. The upgrade will require the deployment of millions of new digital cable set-top boxes, each of which sport a much higher semiconductor content than conventional analog set-top boxes. Semiconductor companies that are prepared to meet these demands will reap the rewards.

*By Jonathan Cassell*

# **Dataquest** *A L E R T*

---

251 River Oaks Parkway • San Jose • CA • 95134-1913 • Phone 408-468-8000 • Fax 408-954-1780

## The DVD Roller Coaster Rumbles On

### DVD Forum Delivers DVD-R and DVD-RAM Specifications

At a conference held in San Jose on May 28-29, 1997, DVD Forum members unveiled the details of Version 0.9 of the DVD-R and DVD-RAM specifications. The DVD-R (which refers to recordable digital versatile disc) specification will support 3.9 GB of storage capacity with recording on a single-layer disc. Work is already in progress to boost the recording capacity to 4.25 GB and 4.7 GB in the near future.

Top-level DVD-R specifications are: organic dye material discs; wobble and land pre-pit address method; support for incremental writing; and full compatibility with DVD-ROM and DVD-RAM. A key application for DVD-R will be in DVD authoring for creation of titles to be played in DVD-ROM drives. DVD-RAM, which enables reading, writing, and erasing, will support 2.6 GB per side of storage with allowance for both single- and double-sided discs.

Main features of the DVD-RAM specification are: wobbled land and groove addressing scheme; single-spiral land and groove; phase-change (PD) overwritable media; and DVD-R and DVD-RAM compatibility. Round-robin testing is being conducted currently, and there are plans to finalize both DVD-R and DVD-RAM specifications by July 1997.

### If the DVD Industry Sneezes, Will PC OEMs Catch the Flu?

It appears that the issue of compatibility between DVD-ROM, DVD-R, and DVD-RAM will become another stumbling block in the development of the DVD-ROM PC market in 1997. DVD-ROM drives are now shipping in upgrade kits from companies such as Creative Labs and in PCs from selected OEMs. Unfortunately, there are a number of problems that are giving PC OEMs ulcers as they try to develop some kind of effective roll-out strategy for DVD-ROM drives in PCs.

A major headache has been created by the inability to obtain licenses for implementing the Content Scrambling System (CSS) in software. In spite of the fact that announcements were made earlier in the year that agreement had been reached on both hardware and software CSS implementations, the only licenses that are being granted are for hardware implementations. Even with very aggressive pricing for the DVD-ROM drive itself, the added hardware costs that OEMs face to provide DVD-Video functionality, plus issues with implementing DVD



drivers and navigation software, appear to have created a general state of confusion and frustration among major PC OEMs. Now it appears that the issue of compatibility could give PC manufacturers a full-blown migraine headache.

While version 0.9 of the DVD-R and DVD-RAM specification calls for compatibility with DVD-ROM, there is no guarantee that first-generation DVD-ROM drives currently being produced will be able to read DVD-R and DVD-RAM discs. In a question-and-answer session, representatives of the forum conceded that compatibility could not be promised until version 1.0 is completed. If finalization of the version 1.0 specification is delayed beyond July, a distinct possibility given the previous track record of meeting DVD deadlines, the availability of DVD-ROM drives that provide full compatibility could be pushed into 1998.

In light of the ongoing difficulties facing the implementation of DVD in PCs, Dataquest will be lowering its forecast substantially for DVD drive shipments in PCs during 1997 and 1998. Total shipments of DVD drives in PCs will probably fall below 3 million in 1997. A complete revised forecast for this segment of the DVD market will be presented in the coming month. Meanwhile, the DVD Video player introduction in the United States is proceeding as expected, and Dataquest continues to stand by its worldwide market forecast of 750 thousand unit shipments in 1997.

### **Chip Forecast: Continued Storms in 1997, Changing to Clearing Skies in 1998**

Semiconductor suppliers continue to follow developments in the DVD industry with great interest. An informal survey of the audience at the DVD conference revealed that participants from the semiconductor industry far outnumbered attendees from any other industry including the PC community. On the positive side, the chip community was able to learn the specifications that will allow them to develop products targeted at the DVD-R and DVD-RAM drives. On the negative side, chip companies should lower their expectations for the size of the semiconductor market in DVD drives over the next 18 months.

*By Dale Ford*

# Dataquest *A L E R T*

251 River Oaks Parkway • San Jose • CA • 95134-1913 • Phone 408-468-8000 • Fax 408-954-1780

## Intel Finally Announces the Processor Formerly Known as Klamath

In the least surprise-packed announcement since January's launch of the Pentium Processor with MMX™ Technology, Intel today launched Pentium II (formerly known as Klamath), the cute and imaginative name it has created for its new flagship processor. Although Intel officially launched its sixth generation of x86 processors with Pentium Pro in November 1995, the introduction of Pentium II, along with the new name, suggests that this time, Intel means business.

Unless you have spent the past year on the space station *Mir*, you have probably known all about this device long before today. Intel has presented almost every detail associated with this product over the last few months; it's almost as if *they* forgot it had not yet been announced. The new Pentium II weighs in at 7.5 million transistors, 36 percent more than the Pentium Pro it will someday replace. Its larger on-chip caches (dual 16KB, versus dual 8KB on the Pro) consume most of the additional transistors. It runs at 233 MHz, 266 MHz and 300 MHz. Table 1 summarizes the price and performance figures for the new CPU. Table 2 looks at the Pentium II's price and performance relative to the earlier Pentium Pro. Alert readers will note that the integer performance of these devices (as measured by SPECint95) scales closely with regard to clock frequency while floating point performance (as measured by SPECfp95) scales less closely, a consequence of the cache-intensive nature of the SPEC floating point benchmark.

**Table 1**  
**Pentium II Price and Performance**

Chip	SPECint95	SPECfp95	Price (\$)
Pentium II at 233 MHz	9.49	6.43	636
Pentium II at 266 MHz	10.80	6.89	775
Pentium II at 300 MHz	12.18	7.77	1,981
Pentium Pro at 200 MHz	8.20	6.21	514

Source: Intel

**Table 2**  
**Pentium II Price and Performance Relative to 200 MHz Pentium Pro**

Chip	Relative Frequency (%)	Relative SPECint95 (%)	Relative SPECfp95 (%)	Relative Price (%)
Pentium II at 233 MHz	117	116	104	124
Pentium II at 266 MHz	133	132	111	151
Pentium II at 300 MHz	150	149	125	385
Pentium Pro at 200 MHz	100	100	100	100

Source: Dataquest (May 1997)

Given the initial prices Intel has set for these devices, they will likely appear in desktop configurations selling for \$2,500 or more, an area previously addressed by the 200 MHz Pentium Pro and the 200 MHz Pentium with MMX technology. Dataquest anticipates that as production volumes ramp, Intel will reduce chip prices, resulting in system prices of \$2,000 by the fourth quarter, and \$1,700 by this time next year. Dataquest also expects that Intel will ship between 12 million and 15 million of these devices by year's end.

### How the Pentium II Differs from the Pentium Pro

Intel's sixth-generation processors (Pentium Pro and Pentium II) utilize a dedicated bus to shuttle data between the external cache and the CPU chip. To avoid delays that would slow the chip down, this external cache must be located in close proximity to the processor. The Pentium Pro package included two chips—a processor die and a separate external cache die that contained either 256 KB or 512 KB of fast level-two cache. Intel designed and manufactured both devices internally. By sealing both chips inside a single package, Intel made the external cache operate at the same frequency as the processor—no mean feat at 200 MHz.

This design concept presented two major drawbacks. First, Intel had to manufacture the cache chip using the same state-of-the-art production equipment needed to make the CPU, but it could not charge as much for the cache chip as it could for a processor. This hardly mattered as long as it delivered Pentium Pro in (relatively) small volumes, but would have wreaked havoc with Intel's margins as the device moved into the mainstream. Second, the two dice needed to be mounted in a package, and then wired to each other and to the package itself. Intel never published data on its assembly yield through this process, but Dataquest imagines that it was not a pretty picture.

The Pentium II differs most dramatically from its predecessors in the approach Intel uses to provide the Pentium II's cache memory. Intel mounts the Pentium II processor chip and its associated caches on a small 6-layer card that is, in turn, mounted inside an aluminum and plastic housing that Intel calls the "single edge contact" (SEC) Cartridge. The SEC looks more like a Nintendo game cartridge than a microprocessor, and is decorated with a holographic image of the processor itself. Instead of a high-pincount socket, the SEC plugs into a motherboard connector dubbed "Slot 1."

The cartridge itself measures about 2 inches by 5 inches by 0.5 inches; a heat sink measuring 2 inches by 5 inches by 1.5 inches is normally attached to the cartridge, making the total

assembly 2 inches by 5 inches by 2 inches. Together with the heat sink, it weighs close to one pound. (The Pentium II is the first microprocessor that could hurt you if you drop it on your foot.)

Given the new package and associated connector, the Pentium II requires a new motherboard. Boards designed for the earlier Pentium Pro "Socket 8" cannot accommodate the Pentium II, and vice versa. Intel will cite the new advanced Slot 1 as a technology advancement, while AMD and Cyrix will plug their sixth-generation MPUs into the familiar Socket 7 that Intel used for Pentium, and they will cite their continuity with existing standards as an advantage. For the first time in quite a while, system vendors and end users may have to do some homework to determine which approach better meets their needs.

The SEC allows Intel to revert to a far more conventional manufacturing process for Pentium II. It produces the processor die using its most advanced semiconductor processes, mounts this die in a plastic ball-grid array package, and tests this standalone package before subsequent assembly operations. Intel purchases 32K x 32 (128 KB) SRAMs from a number of memory providers and uses conventional printed circuit assembly techniques to mount the BGA processor and the cache chips on the SEC card. Dataquest's memory service estimates that Intel will rapidly become the world's largest purchaser of SRAM devices.

Of course, the electrical signals that traveled less than an inch in the cozy dual cavity Pentium Pro package are forced to travel several inches over more hazardous terrain (the printed circuit board) in the SEC, and they cannot complete their journey as quickly as they could in the Pentium Pro. Intel solves this problem by running the cache at one-half the frequency of the CPU core (that is, 116 MHz in the 233 MHz version, and 150 MHz in the 300 MHz version). This change hinders the II's performance, relative to the Pro; to offset this slower cache access time, Intel beefed up the II's on-chip level-one caches from a dual 8 KB design to a dual 16 KB design. In theory, this means that the processor will access the external cache less often, and thus suffer less impact from the additional delays it encounters whenever it does so. The performance data presented in Table 1 suggests that this theory holds better for integer (fixed point) operations than for floating point calculations.

Along with the major overhaul of the cache design, (and the associated packaging changes), Intel's designers also enhanced two key aspects of the processor's logic. Best known are their efforts to incorporate the MMX functionality recently added to the Pentium processor. This feature should make the Pentium II far more useful in multimedia applications than the earlier Pentium Pro. Unfortunately, for instruction set extensions like MMX to do their work, software programs must know how to use them, and this means programmers must rewrite portions of their code. Consumers will need new MMX-aware programs to take full advantage of the chip's features. Such packages may be difficult to find today, but Dataquest expects their ranks to swell over the year. MMX significantly boosts the performance of image processing applications, so it is no surprise that Adobe's Photoshop and Microsoft's PictureIt are leading the pack in this regard. Intel's engineers also added some features to enhance the Pentium II's 16-bit performance, at least compared to the notoriously weak 16-bit performance of the Pentium Pro. These changes should appeal greatly to users that deploy the Pentium II in Windows 95 environments.

## **Pentium II and the Competitive Landscape**

The Pentium II arrives on the scene just as Intel faces credible x86 competition for the first time. AMD's K6, based on the design procured by the NexGen acquisition, comes amazingly close to the 233 MHz Pentium II's performance in many benchmarks, but costs \$180 less. The Cyrix M2 should hit the street within a month, and will also approach Intel's performance. AMD and Cyrix will sell their wares at a substantial discount to Intel's prices, and buyers will be forced to decide how much they are willing to pay for "Intel Inside."

Given the wide range of benchmark programs and operating environments available in today's personal computer market, Dataquest would be surprised if Intel, AMD, and Cyrix cannot each point to specific tests where they rate the highest. Performance data will be inconclusive at best. Intel will likely stress the Pentium II's "dual independent bus architecture" (DIBA)—its term for the dedicated cache bus described earlier—as the key to its performance, while AMD and Cyrix will argue that their larger (dual 32 KB) on-chip caches offset the need for new buses or form factors. The advantages of Intel's DIBA increase with increasing MPU core frequencies, a fact that AMD cannot refute, given that earlier NexGen designs used a similar approach. (NexGen abandoned this concept in order to gain compatibility with the Intel Socket 7 interface.) Consequently, Dataquest expects that the increasingly competitive environment will drive Intel to improve the clock rate of its processors as fast as it can, in an attempt to reach frequencies where the DIBA makes a real difference.

All-in-all, Dataquest expects to see Intel compete on the basis of its performance and manufacturing capacity, while AMD and Cyrix use price as their competitive weapon. Dataquest believes Intel will refrain from matching AMD or Cyrix prices, an expensive alternative because of its overwhelming market share. Thus, Dataquest regards the outbreak of a microprocessor price war as an extremely unlikely possibility.

### **Oh No! Not Another FPU Bug!**

Just as Intel began to chill the champagne for Pentium II's gala New York coming-out party, an ugly reminder of one of Intel's darkest moments surfaced on the Internet. Rumors emerged regarding a Pentium II design error that could, in certain cases, produce faulty arithmetic results. Although clearly undesirable, problems like this can be found in most complex microprocessors; once they are known, software developers can often program "work-arounds" that avoid detrimental effects. Intel has indicated that it will need several days to study and "characterize" this problem, making any analysis here premature; but Dataquest is encouraged that the company's more open response to this issue (as contrasted with its handling of the original error a few years ago) bodes well for an uneventful conclusion to this episode. The \$475 million Intel spent repairing the results of its last floating point bug appears not to have been spent in vain.

*By Nathan Brookwood*

# Dataquest *A L E R T*

---

251 River Oaks Parkway • San Jose • CA • 95134-1913 • Phone 408-468-8000 • Fax 408-954-1780

## **U.S. Robotics Is Invited to Play in 3Com Park**

3Com and U.S. Robotics announced a definitive agreement on Wednesday to merge the two companies. The new company will retain the 3Com name, but the merger will be treated as a 'pooling of interests' for accounting purposes. The goal of the merger is to create a communications powerhouse that can provide end-to-end solutions for networking. The combined company will have roughly \$5 billion in revenue and over 12,000 employees worldwide, which puts it in the same league as networking giant Cisco Systems.

Shareholders of U.S. Robotics will receive 1.75 shares of 3Com stock for each U.S. Robotics share. Pending shareholder approval and other regulatory issues, the merger should be finalized this summer. 3Com is planning to take a one-time charge against earnings for certain merger related expenses.

### **Dataquest Perspective**

*Is this good for 3Com and U.S. Robotics?* Yes, Dataquest believes it is. The reasons for the merger were clearly identified by 3Com and include the strength of each company's products and technologies, the fact that the product lines and sales channels are highly complementary with minor redundancy, and the opportunity to benefit from larger economies of scale for procurement, manufacturing, and distribution. Some folks on Wall Street have concerns about the near-term impact on earnings for the two companies, but the consensus appears to be that this merger is positive for long-term earnings potential.

Strategically, this merger gives 3Com the ability to provide end-to-end networking solutions for both LAN and WAN solutions and positions the company to compete more aggressively with Cisco. One advantage is one-stop shopping for companies who prefer to buy their networking (LAN and WAN) equipment from a single source. A second advantage is the opportunity for tighter integration of products and software to improve time-to-market as well as network management features. Tighter integration does not mean proprietary solutions, but does mean that the whole is greater than the sum of the parts because the various products are offered by a single vendor and are guaranteed to work together as a system by that vendor.

*What does this merger mean for other semiconductor vendors?* The new 3Com has three major sources for semiconductor devices, excluding commodity items such as standard memory devices. They are Texas Instruments for most of the modem-related chips, Lucent Microelectronics for many NIC-related chips and captive semiconductor manufacturing.

Texas Instruments is in a solid position because it has intellectual property ties to U.S. Robotics. Most U.S. Robotics modems are now based on TI DSPs. The company has a significant amount of intellectual property tied to software written for TI's DSP architecture, specifically including the x2 technology. TI also licenses some modem software back from U.S. Robotics and sells it in chips to other customers. Clearly, these two companies are tied together for modem technology issues and Dataquest does not see any downside risk to TI from this merger. In fact, the merger creates significant upside potential for TI because the 3Com is positioned to sell more modems in the future than U.S. Robotics alone could sell. The technology ties are critical for TI because U.S. Robotics is the company "being merged." The merger is not a marriage of two equals, so TI's affiliation with the weaker half would otherwise be at risk.

Lucent's relationship with 3Com is quite different. It appears to be more of a standard buyer/seller relationship that is product, price, and supply oriented rather than technology oriented. 3Com buys chips from Lucent because Lucent is a flexible supplier with a product line and ASIC capabilities that met 3Com's needs. 3Com bought network ICs from National Semiconductor before switching to Lucent and could switch to another vendor without significant consequences. However, this merger does not appear to have any immediate impact on Lucent. 3Com's reason for choosing Lucent as a supplier are still valid following the merger and 3Com is unlikely to make any sourcing changes until all of the merger details are settled. Once the dust settles however, Lucent could face greater competition for the NIC-related business at 3Com; TI might be able to leverage its relationship with U.S. Robotics on the modem side to win more designs within 3Com.

*By Geoff Ballew*

# **Dataquest** *A L E R T*

---

251 River Oaks Parkway • San Jose • CA • 95134-1913 • Phone 408-468-8000 • Fax 408-954-1780

## **The Western Cable Show: Digital Cable Becomes Real, Creates Real Opportunity for Chip Makers**

Faced with a growing competitive threat from satellite television, cable multiple service operators (MSOs) at the Western Cable Show in Anaheim, California, in December revealed they are finally making good on promises to enhance their systems using digital technology. This sounds the starting gun for the digital cable set-top box market, a new, high-volume opportunity for semiconductors that will grow to more than \$1.8 billion in 2001, according to Dataquest.

Time Warner, Tele-Communications Inc. (TCI), and other cable MSOs arrived at the Western Cable Show with orders for digital cable set-top boxes that together will equal as many as 4 million units over the next several years. Meanwhile, television manufacturer Zenith unveiled its new digital set-top box that has received a 3 million unit order from the Americast consortium.

The digital cable set-top box market has had false starts in the past, with MSOs announcing systems and orders only to quietly cancel them later when plans proved to be too costly and too ambitious. However, the cable MSOs' latest push into the digital world appears to be real, as equipment manufacturers and chipmakers report firm orders for digital set-top boxes and components. Also, cable MSOs for the first time have an incentive to upgrade their service with digital technology because they need new ammunition to fight the first real threat to their business: digital satellite.

Digital satellite represents a growing challenge to cable, with systems including DirecTV, EchoStar, and AlphaStar beginning to steal subscribers away from cable for the first time. Although digital satellite provides no price advantage to the consumer, it does offer a far greater number of channels than cable, with some systems sporting as many as 200 channels, compared to only 50 or 60 for analog cable systems. Cable giant TCI reported it actually saw a decline in its subscriber numbers last summer, a major reversal of fortune for a business that is accustomed to perennial growth.

Cable MSOs now hope to even the score with satellite by offering new digital cable systems that provide a larger number of channels than is possible with analog technology. Some of the digital cable systems are offering about 200 channels of programming. These systems also include other enhancements, including electronic programming guides (EPGs), interactive services and — in some cases — Internet access.



Scientific-Atlanta announced it has received an order for 550,000 digital cable set-top boxes from Time Warner. The SA Explorer 2000 digital cable boxes, which will be priced at about \$400 to \$450, will begin production in the fall at the company's plant in Juarez, Mexico—initially at a rate of tens of thousands per month. The Explorer 2000 is able to accept high-bandwidth signals from hybrid fiber/coax (HFC) lines, as well as to send out at rates of 1.54 Mbps. The high-speed back channel allows the Explorer 2000 to perform real-time two-way communications, data exchange, and Internet access.

The Explorer 2000 uses six major logic chips. The system is based primarily on SA-designed ASICs, including a MicroSPARC-based system processing ASIC and MPEG-2 decompression chips. Also included in the design is the Eagle graphics and audio chip from PowerTV Inc., which allows the display of video, crisp antialiased text, and the playing of high-quality audio on the television.

Scientific-Atlanta believes that it will continue to use ASICs in future digital set-top cable boxes, unlike many other companies, which believe the future lies mainly in application-specific standard products (ASSPs). The company believes the ASICs give it a competitive advantage by allowing it to aggressively integrate the parts and reduce costs on its own terms. By late 1998, SA plans to reduce the chip count required for digital cable set-top boxes to just three major logic chips, down from six now. SA has licensed Toshiba and Pioneer to use its ASICs in their own set-top box designs.

General Instrument Corporation already has begun production of its DCT-1000 digital cable set-top box for a major rollout of digital cable services by TCI. More than 3.5 million digital cable boxes will be delivered over the next several years. Manufacturing is now taking place at the company's Taiwan facility at a rate of 50,000 units per month. The DCT-1000 box, priced at about \$400, supports a larger number of channels than is possible with analog cable and can work with interactive applications that allow users to access news, weather, and sports updates using their remote controls. The DCT-1000 is expected to support Internet access as well.

The DCT-1000 box also makes use of GI-designed ASICs. However, unlike SA, GI is moving to use more standard types of chips by licensing its digital set-top box technologies to chip manufacturers. The company recently announced it is publishing a digital cable set-top box standard that will allow other companies to manufacture chips and boxes that are compatible with its products.

Zenith unveiled its digital set-top terminal, a digital cable box that it will deliver to the Americast consortium, which consists of entertainment giant Disney and telecommunications companies Ameritech Corporation, BellSouth Corporation, GTE Corporation, and SBC Communications Inc. Based on a Motorola 68000 microprocessor, the Zenith box is somewhat simpler than the SA and GI systems, with no support for Internet access. However, the Zenith box does come with an EPG that incorporates video and graphics.

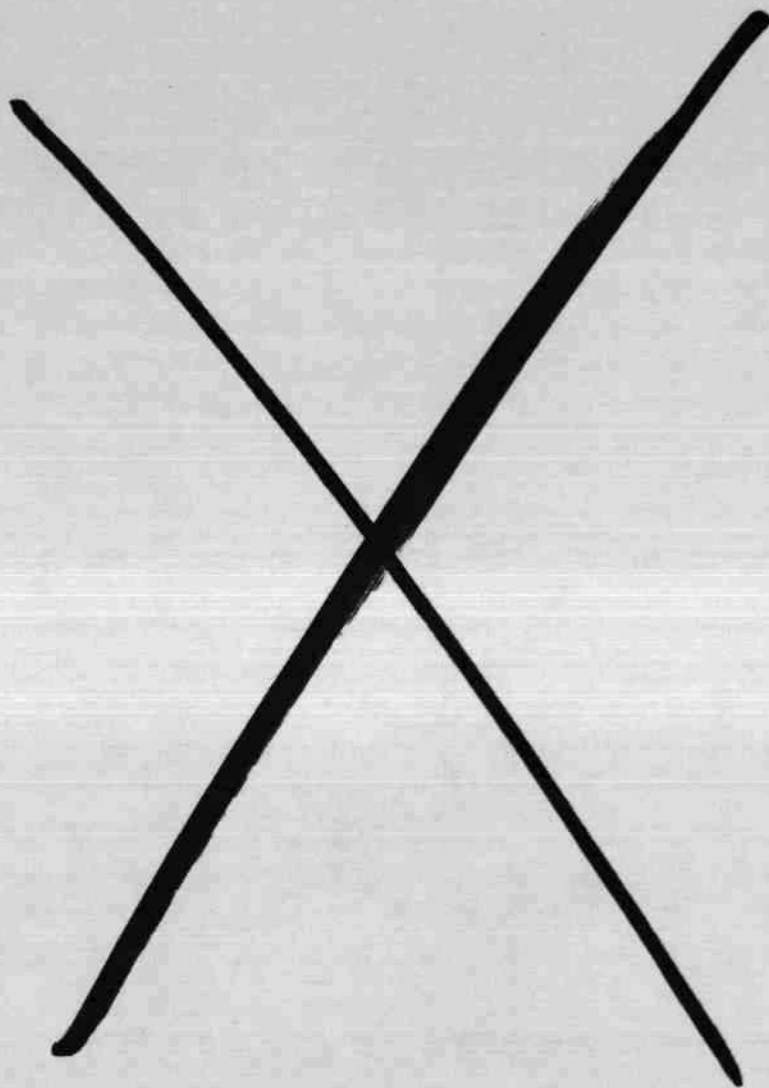
The Zenith digital set-top terminal will begin volume production in February. Americast has ordered up to 3 million boxes over a five-year period. However, it is unclear when the boxes will be delivered or how many will be used for cable and how many will be used for other types of digital systems. The boxes employ a network interface module (NIM), which is a

removable front-end module that allows them to be used with any type of digital delivery system, including HFC, satellite, and wireless cable. Of all the digital cable set-top boxes at the show, the Zenith digital set-top terminal makes the most use of standard parts, employing C-Cube's recently announced AViA chipset, which integrates MPEG-2 decompression, transport control, graphics, and audio into just two devices.

Dataquest predicts the digital cable set-top box market will enter serious volume for the first time in 1997, with production growing to 1.5 million units worldwide, up from only about 400,000 in 1996. As digital cable box production grows, so will the market for semiconductors for set-top boxes, rising from \$83 million in 1995 to \$260 million in 1996 and to more than \$1.8 billion in 2001.

Like many consumer electronics markets, digital set-top boxes initially will make heavy use of ASICs but later will evolve to use more and more ASSPs. With prices at about \$400 to \$450, digital cable set-top box manufacturers acknowledge that they will not enjoy a very large margin on their products initially. Dataquest estimates the factory average selling price of a digital cable set-top box will be \$383 in 1997. Thus, the emphasis for most of the market over the next few years will be on cost reduction using highly integrated ASSPs.

*By Jonathan Cassell*



**Dataquest**

Perspective



## Consumer Multimedia Semiconductors and Applications Worldwide Market Analysis

### Set-Top Chip Market Hits an Air Pocket but Keeps Soaring Higher

**Abstract:** *This Perspective analyzes the competitive landscape and opportunities for makers of semiconductors for digital set-top box boxes. A forecast of growth of set-top box sales and their semiconductors will be presented. This Perspective also will provide an analysis of trends in set-top box architectures, and ways semiconductor manufacturers can tailor their products and strategies to address those changes.*

*By Jonathan Cassell*

#### 1997: Stuck in the Middle

Inigorated by the entry of new digital technology, the market for television receiver set-top boxes (STBs) has emerged as one of the fastest-growing segments of the consumer electronics industry today. As shown in Figure 1, production of STBs is expected to increase to nearly 38 million units by the year 2001, up from about 17 million units in 1996, representing a compound annual growth rate (CAGR) of 17 percent. Note that Figure 1 includes a forecast of digital terrestrial television—also known as digital television (DTV)—STBs, which previously were not counted by Dataquest in the STB category.

#### Digital in the Driver's Seat

Driving growth in the STB market will be digital products, which will account for all increases on a unit and a revenue basis in the future. With digital technology coming on strong, analog box production has begun to decline. Production of analog boxes will drop to just above 6 million units in 2001, down from nearly 11 million in 1997.

#### Dataquest

**Program:** Consumer Multimedia Semiconductors and Applications Worldwide

**Product Code:** MSAM-WW-DP-9714

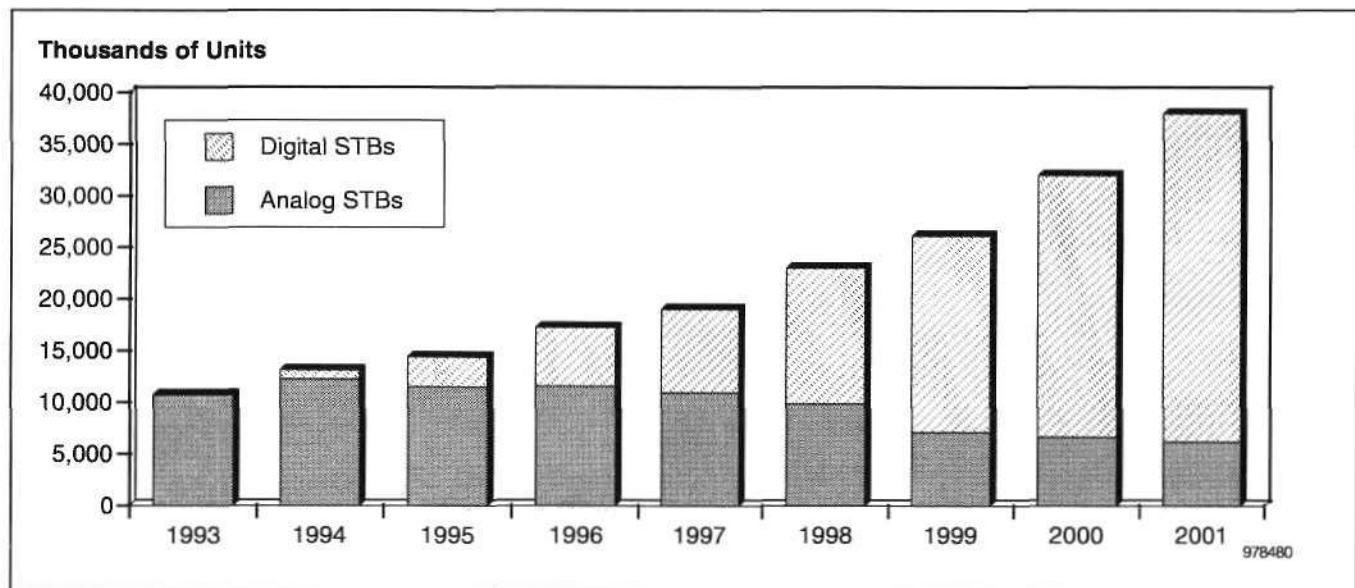
**Publication Date:** December 15, 1997

**Filing:** Perspective

(For Cross-Technology, file in the Semiconductor Applications Markets binder)

FILE COPY:  
MARIA VALENZUELA

**Figure 1**  
**Digital and Analog Set-Top Box Production Forecast**



Source: Dataquest (November 1997)

As 1997 draws to a close, the digital STB market stands at the beginning of what promises to be a massive expansion. The business is undergoing a transformation from a U.S.-based satellite market to a worldwide market, encompassing a variety of digital technologies including satellite, cable, MMDS, and terrestrial. This diversification will propel tremendous growth in digital STB production on a worldwide basis over the next several years.

However, in 1997, that glorious future seems to have been delayed somewhat. Production growth of digital STBs for the year is expected to be well below the levels of 1995 and 1996, primarily because of a slowdown in the satellite market in the United States. The following section examines recent developments and outlook for all major types of digital STBs worldwide.

### **Satellite Market Falls to Earth in United States, but Takes Off Elsewhere**

During the first three quarters of 1997, the direct broadcast satellite (DBS) STB market fell from its high orbit in 1995 and 1996. The primary market for DBS—the United States—experienced a slowdown in subscription increases, with new customers in the first nine months of the year down by as many as 400,000 units compared to the same period in 1996, according to estimates. With growth slowing, the U.S. satellite service provider market experienced a shakeout as the fledgling AlphaStar service filed for bankruptcy in May, and as ASkyB in June gave up its planned new service and merged with PrimeStar.

In other regions, the satellite market has been faring better, though still somewhat below projections. The PerfectTV system in Japan had signed 410,000 subscribers in October after 13 months of operation. While the European DBS market failed to get off the ground in 1996 because of delays,

systems including Canal Plus, DF-1, Television Pay Service (TPS), and Telepiu reportedly had signed more than 800,000 customers by September of 1997.

The U.S. subscription slowdown put the brakes on production increases. In 1997, production of DBS STBs is expected to grow by only 14 percent to 6.2 million units, up from 5.4 million in 1996, as presented in Table 1. The effects of the production slowdown were exacerbated by swelled inventories that were generated in 1996. Figure 2 shows Dataquest's worldwide digital STB production forecast by box type.

As shown in Figure 3, a vastly greater number of DBS STBs were produced and sold to dealers and services than actually ended up in the hands of subscribers in 1996. With subscriptions slowing and inventories swelling, box producers have been squeezed from both ends, impacting some players severely. NextLevel and Thomson Multimedia, which supply STBs to the PrimeStar and DirecTV/USSB services, respectively, both announced major workforce reductions in November.

Despite these problems, Dataquest is optimistic the worldwide DBS business can return to its winning ways. Satellite subscriber growth is expected to get back on track in the fourth quarter. Over the next five years, the digital satellite STB business will benefit from its internationalization, with large and growing subscriber bases having been established in the Americas, Europe, and Japan.

Meanwhile, new services are coming on line in late 1997 and in 1998 that will bring services to more countries and consumers within those regions, including Galaxy in Latin America, TeleSat in Canada, BSkyB in England and Scandinavia, and JSkyB and DirecTV in Japan. In 1998 and 1999, Europe will account for much of DBS' growth. Further in the future, a major portion of the growth in the DBS STB production and subscriptions will come from the Asia/Pacific.

Recent economic turmoil notwithstanding, the Asia/Pacific represents one of the most attractive long-term opportunities for sellers of DBS boxes. As presented in Table 1, the DBS STB market will grow to 17.4 million units in 2001 up from 5.4 million units in 1996, representing a CAGR of 26 percent. By 2001, satellite STBs will represent a nearly \$4 billion business.

Table 2 presents a ranking of the top 10 manufacturers of DBS STBs in 1995 and 1996. Just as in 1995, Thomson Multimedia was the No. 1 vendor of DBS STBs in 1996 because of strong sales of DBS boxes for the DirecTV/USSB system in the United States. However, the company's dominant position was eroded somewhat, with its market share falling from 40 percent in 1995 to only 27.3 percent in 1996.

The reduced market share reflects the growth of other players in the DBS market, including Sony and Hughes. It also comes as a result of the globalization of the DBS STB market, with European-based manufacturers Pace, Philips, Nokia, and others beginning production of DVB-compliant boxes for new European services.

**Table 1**  
**Worldwide Digital STB Production Forecast by Box Type**

Box Type	1993	1994	1995	1996	1997	1998	1999	2000	2001	CAGR (%) 1996-2001
<b>Digital Cable STBs</b>										
Units (K)	8	20	63	277	1,845	3,197	5,772	8,629	12,540	114
Factory ASP (\$)	900	509	437	473	389	330	290	258	231	-13
Factory Revenue (\$M)	7	10	28	131	564	1,056	1,676	2,225	2,891	86
<b>Digital Satellite STBs</b>										
Units (K)	1	874	2,841	5,427	6,189	9,753	12,620	15,777	17,441	26
Factory ASP (\$)	900	465	474	432	328	278	260	237	219	-13
Factory Revenue (\$M)	0	406	1,347	2,344	2,029	2,713	3,276	3,736	3,818	10
<b>Digital Terrestrial STBs</b>										
Units (K)	0	0	0	0	15	80	202	510	1,063	NA
Factory ASP (\$)	0	0	0	0	340	280	252	230	204	NA
Factory Revenue (\$M)	0	0	0	0	5	22	51	117	217	NA
<b>MMDS/LMDS STBs</b>										
Units (K)	0	0	0	5	35	77	389	410	719	NA
Factory ASP (\$)	0	0	0	900	529	514	448	442	431	-14
Factory Revenue (\$M)	0	0	0	5	19	39	174	181	310	133
<b>Total Digital STBs</b>										
Units (K)	9	894	2,904	5,709	8,084	13,107	18,984	25,326	31,762	41
Factory ASP (\$)	900	466	473	434	324	292	273	247	228	-12
Factory Revenue (\$M)	8	416	1,374	2,480	2,617	3,831	5,177	6,259	7,237	24

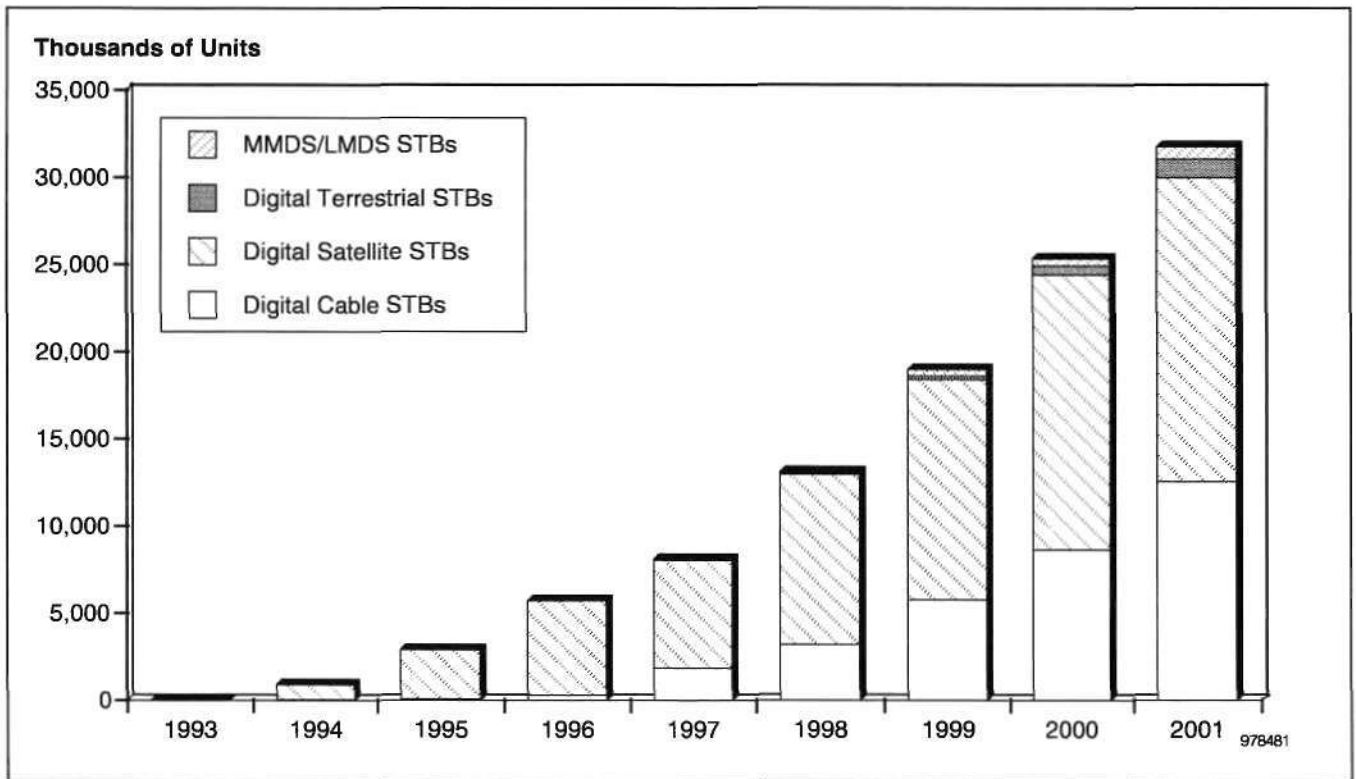
NA = Not applicable

Source: Dataquest (November 1997)

## Cable Goes Digital

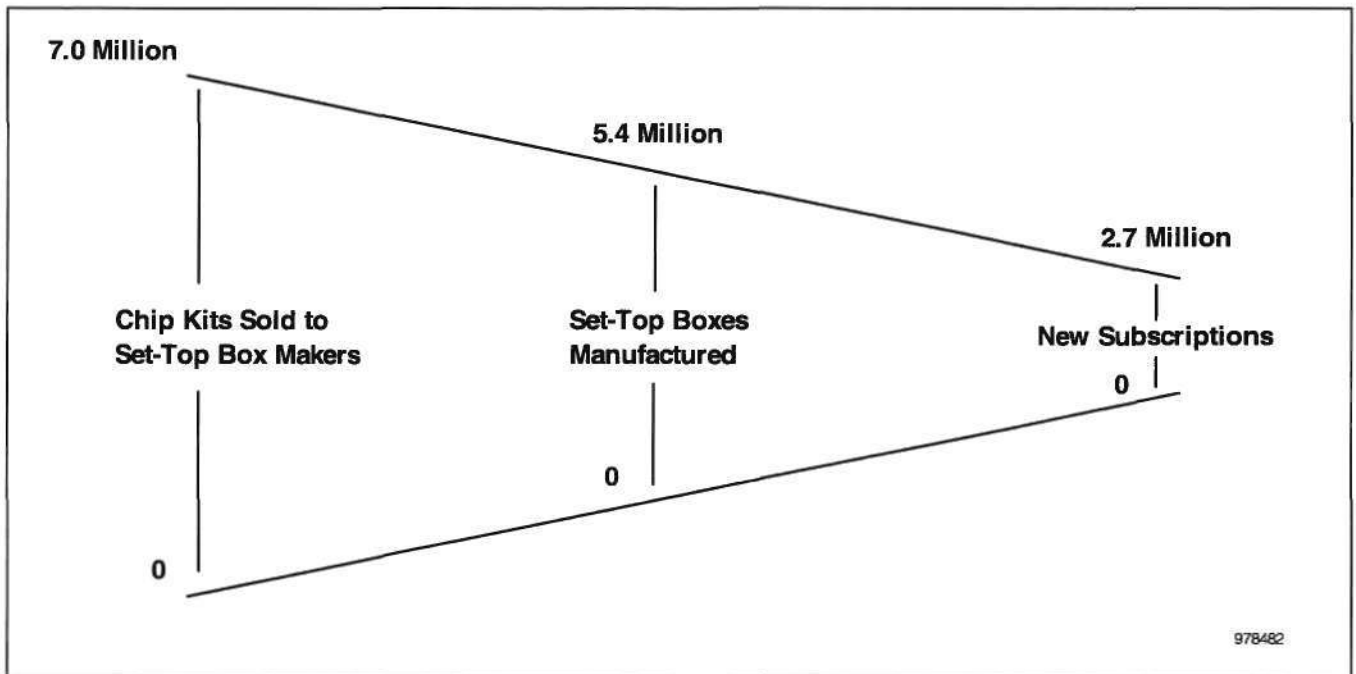
The digital cable market has come alive in 1997 in the United States and in Europe. U.S. cable service providers, motivated by stiff competition from DBS, began major upgrades of their infrastructure to digital technology. The digital upgrades have taken place rapidly. TCI, the nation's largest cable service provider, plans to make digital cable available to 65 percent of its 14 million subscribers by the end of 1997. In Europe, production of digital cable boxes began in 1996 and rose strongly in 1997. As shown in Table 1, Dataquest expects production of digital cable boxes to reach more than 1.8 million in 1997. However, just as in the DBS market, growth in subscriptions is seriously lagging production, with very few actual subscribers in both the United States and Europe.

**Figure 2**  
**Worldwide Digital STB Production Forecast by Box Type**



Source: Dataquest (November 1997)

**Figure 3**  
**Digital Satellite STB Supply Chain**



Source: Dataquest (November 1997)



**Table 2**  
**DBS STB Vendor Production Ranking**

Company	1995 Production (Units)	1995 Market Share (%)	1996 Production (Units)	1996 Market Share (%)
Thomson Multimedia	1,134,000	40.0	1,479,205	27.3
NextLevel (General Instrument)	858,000	30.3	951,000	17.5
Sony	205,000	7.2	625,000	11.5
Pace	183,912	6.5	540,917	10.0
Nokia	119,680	4.2	272,000	5.0
Philips	101,000	3.6	272,000	5.0
UEC-Panasonic	101,250	3.6	225,000	4.1
Hughes Network Systems	0	0	187,000	3.4
Sagem	0	0	97,083	1.8
Pioneer	20,896	0.7	35,417	0.7
Grundig	0	0	19,833	0.4
Other Vendors	120,000	3.9	722,500	13.3
<b>Total</b>	<b>2,843,738</b>	<b>-</b>	<b>5,426,955</b>	<b>-</b>

Source: Dataquest (November 1997)

The long-term prospects of cable look extremely bright. In the United States and Europe—the locations of the world's largest installed bases of cable subscribers—growth in digital cable box production is vastly exceeding that of DBS. As shown in Table 1, worldwide digital cable production will grow at a CAGR of more than 114 percent from 1996 to 2001, more than four times the increase of DBS. Production will increase from an estimated 1.8 million units in 1997 to 12.5 million units in 2001. With its high transmission speeds and two-way capability, digital cable is emerging as the most desirable medium for interactive television applications, attracting the notice of both the consumer electronics and computer industries. Indeed, Microsoft has begun to target digital cable as a key area to promote its vision of interactive television. Prospects for digital cable have also been brightened by the introduction of standards, such as Open Cable in the United States and DVB-C in Europe. Dataquest believes that digital cable systems in the United States and in Europe soon will begin to garner subscribers and justify the rapidly ramping production in both regions.

## Digital Terrestrial Gets Off the Ground

Production of digital terrestrial (DTV) STBs is expected to begin in 1997 in Europe, and manufacturers are anticipating the start of broadcasting in mid-1998. Europe is expected to be the driving region for production and subscriptions for DTV STBs through the year 2001. In the United States, low-volume production of DTV STBs is expected to start in 1998, preceding the beginning of broadcasts late in the year. From 1996 to 2001, digital terrestrial box production will remain small relative to the other types of boxes, growing to only 3.3 percent of total digital STBs manufactured by 2001.

However, in the next century, DTV STB production eventually will outstrip that of all other types of STBs, as analog broadcast systems convert to digital technology. As shown in Table 1, worldwide production of digital terrestrial boxes will grow to more than 1 million units by the year 2001, up from only 15,000 in 1997.

## **MMDS/LMDS Getting Back on Track**

The outlook for the market for MMDS/LMDS STBs has undergone significant changes. In recent years, MMDS/LMDS appeared to be an extremely hot area, as U.S.-based consortiums led by telecommunications companies formed to promote the technology, such as Tele-TV and Americast. However, the Tele-TV consortium was disbanded and Americast's MMDS plans were delayed, throwing the future of MMDS into doubt. The backing-off from MMDS/LMDS reflected a wholesale retreat from the digital video market by the telecommunications companies.

Nevertheless, the MMDS/LMDS market appears to be getting back on track with Pacific Telesis, now part of Southwestern Bell, beginning its MMDS service in Los Angeles in May and BellSouth starting its service in New Orleans by the end of 1997 or early 1998. As shown in Table 1, MMDS/LMDS production will grow from 5,000 in 1996 to 719,000 in 2001, representing a CAGR of 170.1 percent.

## **Chip Growth Sets a Fast Pace, but Tops Out in 1997**

Semiconductor suppliers did well in 1996, primarily because of the DBS STB business. As shown in Figure 3, makers of DBS STBs bought enough chips to build about 7 million units, even though far less were actually produced and delivered to subscribers. This helped the entire DBS STB industry to generate \$978 billion for semiconductors in 1996, up 72 percent from \$568 million in 1995, as shown in Table 3.

Table 4 lists the top 10 suppliers of semiconductors for all types of digital STBs in 1996, excluding memory, optoelectronics, and discrete. SGS-Thomson in 1996 was the leading digital STB chip vendor, with \$182.3 million in sales, mainly of MPEG-2 decoders for DBS STBs. The company also supplied microcontrollers and transport chips. LSI Logic was the No. 2 vendor, on the strength of sales of MPEG-2 decoders transport chips and demodulators also sold into the DBS market.

In the first half of 1997, the overproduction and swelling inventories of 1996 came back to haunt the major semiconductor suppliers. Box makers, with their warehouses full and their customers' subscription growth rates declining, reduced orders for new chips. Also, DBS STB chipmakers were stung by steep price erosion for their parts, caused by the general price plunge in chips and the reduced prices being charged for new, more-integrated parts.

**Table 3**  
**Digital STB Semiconductor Revenue Forecast by Type (Millions of Dollars)**

	1993	1994	1995	1996	1997	1998	1999	2000	2001	CAGR (%) 1996-2001
Digital Cable STBs	4	6	13	56	325	489	815	1,139	1,539	94.0
Digital Satellite STBs	0	229	568	978	874	1,048	1,321	1,555	1,686	11.5
Digital Terrestrial STBs	0	0	0	0	2	9	22	51	103	NA
MMDS/LMDS STBs	0	0	0	1	7	14	66	65	106	144.4
<b>Total Digital STBs</b>	<b>4</b>	<b>235</b>	<b>581</b>	<b>1,036</b>	<b>1,208</b>	<b>1,560</b>	<b>2,225</b>	<b>2,810</b>	<b>3,434</b>	<b>27.1</b>

NA = Not applicable

Source: Dataquest (November 1997)

**Table 4**  
**Top 10 Vendors of Semiconductors for Digital STBs, 1996**

Rank	Company	Revenue (\$M)
1	SGS	182.28
2	LSI	158.00
3	Motorola	87.10
4	Philips	53.90
5	VLSI	46.00
6	GEC Plessey	45.00
7	Sony	14.92
8	Rockwell	11.46
9	Texas Instruments	6.00
10	Comstream	4.04
-	Other Vendors	20.07

Note: Excludes memory, optoelectronics, and discrete semiconductors

Source: Dataquest (November 1997)

The double-whammy of lower chip prices and reduced orders had a strong impact on the results of chip suppliers to the DBS STB market in the first half of the year, including VLSI Technologies Inc. and SGS-Thomson. However, by the second half of the year, the digital STB chip business began to recover as the inventory problems were corrected, subscription growth in the United States began to increase, and European production blossomed.

Despite that recovery, the DBS STB chip market will end 1997 with lower sales than it had in 1996, just as Dataquest predicted in mid-1997. However, the decline will be somewhat steeper than previously estimated, falling to \$874 million, down nearly 11 percent from \$978 million in 1996.

The hottest segment of the digital STB chip market in 1997 will be digital cable, with sales rising to \$325 million, up from \$56 million in 1996. Chip suppliers who serve this market will record the best sales growth in 1997.

Overall, the rise in digital STB chip sales in 1997 will be driven entirely by growth in the cable market. Digital terrestrial and MMDS/LMDS will have a negligible effect on the digital STB chip market in 1997, generating just \$2 million and \$7 million in semiconductor sales, respectively.

Regardless of setbacks in 1997, the long-term prospects of the digital STB chip business are extremely strong. Tracking increases in box production, STB semiconductor sales will have a CAGR of 27 percent from 1996 to 2001, to reach \$3.4 billion. The biggest growth opportunity in the digital STB chip market over the next five years will continue to be in cable, where semiconductor sales will increase by a 94 percent CAGR to 1.5 billion in 2001. MMDS/LMDS will grow to 1.5 billion in 2001 and will remain a small portion of the total market on revenue basis. Digital terrestrial STB chips will grow to 106 million in 2001.

Although still a small part of the overall digital STB chip market, Dataquest believes that digital terrestrial will eventually represent the largest opportunity for STB semiconductors in the next century. Vendors should consider their participation in this area over the next five years to be an investment in future growth.

## **Technology and Market Trends Transform the STB**

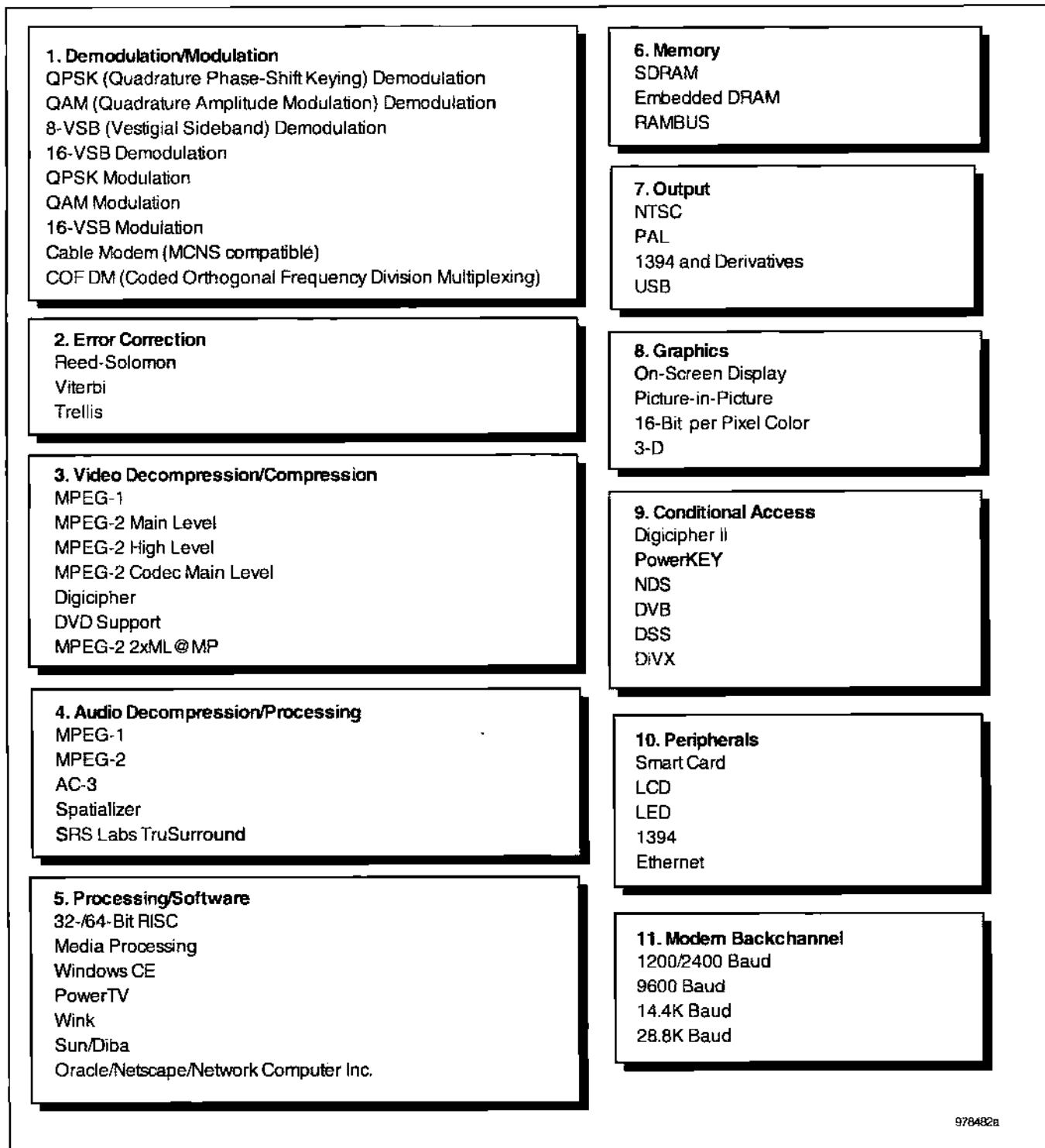
The digital STB has undergone remarkable evolution over the past few years. More sophisticated, highly integrated silicon has significantly reduced the cost of STBs while increasing their performance and capabilities. The next several years will bring even more dramatic changes in digital STB design, features, and capabilities. The major trends that will drive set-top box evolution over the next five years include flexibility, integration, interactivity convergence, and HDTV/DTV.

With digital STB chip prices having eroded so rapidly in recent times, semiconductor makers are seeking differentiating features that can preserve or increase the value of their products. By accommodating these five trends, semiconductor manufacturers can offer differentiated products that customers will be willing to pay a premium for. Companies that offer the first or best implementation of the five trends will be the most successful.

Figure 4 shows a block diagram of the functions within a generic digital STB. For each block, technologies and features that will be driven by the above trends are listed. Note that this figure is not intended to reflect a specific design, manufacturer, level of integration, or box type. Rather, it is meant to show the kinds of technologies and features semiconductor makers must have in their portfolios to stay abreast with developments in STB technology over the next several years.

The following section refers to each of the market trends that will drive the requirements for the technologies and features shown in Figure 4.

**Figure 4**  
**Technology and Feature Trends in Digital STB Silicon**



Source: Dataquest (November 1997)

### **Flexibility**

The digital STB market increasingly is seeking to develop general-purpose boxes that can be used in the greatest number of systems and countries. Flexibility can be added both in silicon and in box design. Semiconductor manufacturers can support this trend via the following:

- Offering back-end solutions that support all commonly used digital set-top data type standards, including MPEG-2 audio and video and AC-3 audio
- Developing chips that support all major standards for digital STBs, including DVB, DSS, OpenCable, ATSC, and HD-0
- Facilitating the use of modular front ends—such as Network Interface Modules (NIMs) or combined tuner-demodulator modules—by offering front-end chips that have integrated microcontrollers, thus allowing them to work independently of other parts of the STB, including the main microprocessor
- In the long run, producing front-end chips that are programmable, allowing them to be used with all types of demodulation systems, regardless of delivery medium or box standard
- Providing chips that support all commonly used conditional access schemes (see Figure 4 for a listing)
- Supporting the maximum number of microprocessor types in order to accommodate requirements from service providers
- Including a controller for a standard expansion network or bus system, such as Ethernet, to accommodate out-of-box expansion

### **Integration**

Integration of functions is taking place rapidly in STBs as manufacturers strive to reduce costs. Trends in the digital STB silicon integration include the following:

- The continuing integration of STB silicon into fewer chips. Dataquest believes integration within 18 months will reduce the number of logic chips in some production STBs to two devices: the front and back ends.
- The eventual integration of DRAM into the back-end logic. By 1999, the combination of advances in embedded DRAM technology and relatively high prices for low-density memory will make embedded DRAM a cost-effective alternative to standalone DRAM.

### **Interactivity**

Another important factor in the development of the digital STB will be the proliferation of interactive features. Over the next 12 months, numerous digital STBs for satellite, cable, terrestrial, and MMDS/LMDS systems will be introduced with interactive functions. Semiconductor developments to support Interactivity will include the following:

- The integration of powerful 32- and 64-bit RISC microprocessors in back-end STB chips

- Allowing software to drive semiconductor features and functions. As STBs increasingly become interactive platforms, they will need to run new interactive software. Service providers are using this type of software as a differentiating feature. Software increasingly is the most important decision the service providers will make, with the hardware choice becoming secondary. Thus, STBs and STB silicon should be developed with an eye to the software that will run on them. STB chips should support as many interactive software schemes as possible. Chip companies should become active participants in porting efforts. They should also ensure that required features to run the software are supported in their hardware. Figure 4 lists some of the various software schemes that should be supported.
- Microprocessors that are specifically designed to support new interactive software. Such software often requires or can benefit from specific features in the microprocessor. Windows CE, for example, requires a memory management unit, and Java runs best in its native form in a so-called "Java Processor." STB silicon suppliers should be familiar with the processing requirements for the various software schemes.
- The use of media processors. As set-top boxes become more interactive, they will need to process a greater number of data types, including video, audio, graphics, and text. Media processors shine when used with diverse multimedia data types such as this and could be an economical alternative to hardwired approaches.
- Truly interactive digital STBs will require backchannel communications to send commands and requests for data upstream. Backchannel communications methods will range from medium to high-speed telco modems, to MCNS-compliant cable modems, to QPSK modulation. STB silicon vendors should integrate these functions where appropriate.
- To support images for Internet data or advanced electronics programming guides, more powerful graphics controllers will be required in future digital STBs. Graphics controllers are moving to 16- and 24-bit color and use antialiasing or antijitter technology to improve the look of text on NTSC or PAL displays.
- Current satellite digital STBs employ slow-speed telephone line modems with baud rates of 1,200/2,400 that are designed for billing and monitoring rather than for interactive applications. Over time, satellite STBs will make use of faster telecommunications modems with speeds in the 28.8-Kbps range to support Internet and other forms of data access. In digital cable boxes, backchannel communications involves the transmission of data at high speeds up the cable line. The approach most commonly used for this is QPSK modulation. Compatibility with the MCNS cable modem standard will be required in these boxes.

### **Convergence**

Because of their video and audio decompression capabilities, digital STBs will increasingly be used in conjunction with or integrated entirely with other types of consumer products. This trend also plays into the move toward interactivity as digital STBs run advanced software and become the

centerpiece of consumer electronics in the home. Combination digital STBs/D-VHS players have already been introduced by EchoStar and JVC. In the near future, STBs combined with DVD players, Divx players, video CD players, telephones, and videoconferencing systems will be introduced. Semiconductor vendors can capitalize on this trend via the following:

- Supporting standards and functions for DVD and the related DiVX specification. This includes AC-3 audio, the Macrovision copy protection scheme, and the DiVX conditional access scheme. When recordable DVD players become available in 1999 or 2000, combination DVD/digital STBs will require full MPEG-2 codecs. Support should be included for 3-D audio processing technologies used with AC-3.
- Adding support for the Video CD 2.0 standard
- Providing support for the D-VHS compression algorithm
- Offering transcoding for video compressed in the DVC format used by digital video cameras
- Supporting voice telephony to accommodate the move by cable companies to offer telephone service
- Supporting videoconferencing capabilities at the high end. Digital STBs over time will evolve into two-way communicating devices, requiring video and audio codec functions, as well as a high-speed back channels

### **DTV/HDTV**

Some STBs produced over the coming years will be capable of receiving and decoding high-definition digital video. Most of these STBs will be for U.S. digital terrestrial broadcasts. However, satellite, cable, and MMDS/LMDS boxes that are DTV/HDTV-enabled also will be produced over the next five years. Semiconductor requirements for DTV/HDTV STBs include the following:

- All format MPEG-2 decoders capable of decompressing video with high-definition resolutions and down-converting it for display on NTSC televisions. Digital STBs with such decoders may appear as soon as late 1998.
- RAMBUS or other high-speed memory technology to support the fast data rates required for buffering high-definition video
- Embedded memory, also for accommodating the fast data rates of high-definition television



---

**For More Information...**

Jonathan Cassell, Senior Industry Analyst..... (408) 468-8195

Internet address ..... [jon.cassell@dataquest.com](mailto:jon.cassell@dataquest.com)

Via fax ..... (408) 954-1780

Dataquest Interactive ..... <http://www.dataquest.com>

The content of this report represents our interpretation and analysis of information generally available to the public or released by responsible individuals in the subject companies, but is not guaranteed as to accuracy or completeness. It does not contain material provided to us in confidence by our clients. Reproduction or disclosure in whole or in part to other parties shall be made upon the written and express consent of Dataquest.

©1997 Dataquest—Reproduction Prohibited

Dataquest is a registered trademark of A.C. Nielsen Company

Perspective



## Consumer Multimedia Semiconductors and Applications Worldwide

# Dataquest Predicts

## Powerful Chips Drive New Consumer Electronics Market

---

**Abstract:** *The summary forecast for worldwide production of consumer electronics and the related semiconductor market demand is presented in this document. The importance of digitally-enhanced and next-generation consumer products in driving the semiconductor market is illustrated along with regional production trends.*

*By Dale Ford*

---

## Next-Generation and Digitally-Enhanced Products Drive Recovery and Growth

After suffering its first significant decline in recent history in 1996, the consumer electronics equipment market is getting back on its feet again in 1997. Dataquest predicts that the consumer electronics market will pursue a solid growth path for the next five years with a compound annual growth rate (CAGR) of 4.2 percent. The forecast for consumer electronics production is presented in Table 1 and Figure 1. The semiconductor market for consumer electronic products is projected to pursue a higher growth path with a CAGR of 9 percent in this same period, reaching nearly \$35 billion by 2001 (see Table 2). The difference in growth rates between equipment production and semiconductor demand is driven by the digitization of consumer products from TVs to dishwashers.

Dataquest has segmented the consumer electronics market into three segments: legacy, digitally-enhanced, and next-generation.

As implied by the name, legacy consumer electronics includes those products such as standard color TVs, VCRs, and stereos that have been the traditional drivers of the consumer electronics market.

---

### Dataquest

**Program:** Consumer Multimedia Semiconductors and Applications Worldwide

**Product Code:** MSAM-WW-DP-9713

**Publication Date:** December 15, 1997

**Filing:** Perspective

(For Cross-Technology, file in the Semiconductor Application Markets binder)

FILE COPY:  
MARIA VALENZUELA

The digitally-enhanced category counts products that have added new features and benefits to legacy products through the application of digital technologies. A good example of this type of product is a camcorder that uses digital enhancements to provide improved zoom capabilities and motion compensation.

The next-generation category describes products that take advantage of powerful digital and signal processing semiconductor products to enable significant advances in consumer electronics products. The main drivers of this category are digital television (DTV), digital camcorders, video CD and DVD video players, digital still cameras, digital cable/satellite set-top boxes, and 32-/64-bit video games.

Dataquest predicts that the digitally-enhanced and next-generation products will be critical for driving future growth in both consumer electronics production and the semiconductor market for consumer electronics, as shown in Tables 3 and 4 and Figures 2 and 3. The market for legacy consumer electronics and its corresponding semiconductor market will be flat to declining in the future. All of the future growth for both equipment and semiconductors will be driven by products in the digitally-enhanced and next-generation categories.

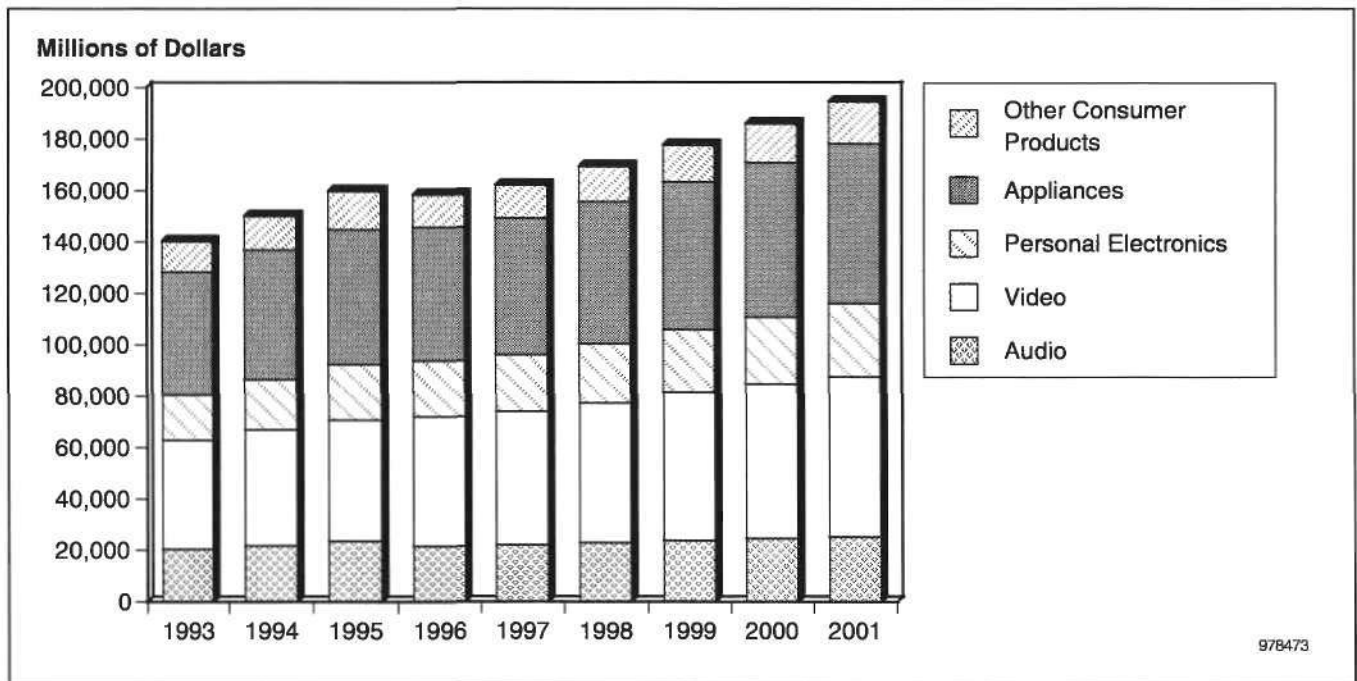
The consumer electronics industry is passing through a significant transition period, and its future growth depends heavily on consumer acceptance of these new products. Dataquest is optimistic about the growth of this industry and the associated semiconductor market over the next five years.

**Table 1**  
**Worldwide Consumer Electronic Equipment Production Revenue Forecast**  
**(Millions of Dollars)**

Segment	1993	1994	1995	1996	1997	1998	1999	2000	2001	CAGR (%) 1996-2001
Audio	20,588	21,916	23,711	21,616	22,200	23,039	23,870	24,668	25,267	3.2
Video	42,377	45,139	47,043	50,525	51,982	54,357	57,708	60,055	62,340	4.3
Personal Electronics	17,755	19,571	21,797	21,782	22,120	23,149	24,373	26,127	28,652	5.6
Appliances	47,717	50,445	52,475	52,014	53,046	55,193	57,505	60,044	62,080	3.6
Other Consumer Products	11,869	13,098	14,860	12,600	12,844	13,725	14,287	15,159	16,285	5.3
<b>Total</b>	<b>140,305</b>	<b>150,170</b>	<b>159,886</b>	<b>158,537</b>	<b>162,193</b>	<b>169,463</b>	<b>177,743</b>	<b>186,053</b>	<b>194,624</b>	<b>4.2</b>

Source: Dataquest (November 1997)

**Figure 1**  
**Worldwide Consumer Electronic Equipment Production Revenue Forecast**



Source: Dataquest (November 1997)

**Table 2**  
**Worldwide Semiconductor Consumption in Consumer Electronics by Product Category**  
**(Millions of Dollars)**

Device Type	1993	1994	1995	1996	1997	1998	1999	2000	2001	CAGR (%) 1996-2001
Audio	3,026	3,594	4,529	3,545	3,685	4,101	4,726	5,279	5,609	9.6
Video	7,557	8,287	8,949	10,185	10,749	11,719	12,938	13,839	14,590	7.5
Personal Electronics	2,924	3,846	5,640	5,127	5,673	6,296	6,888	7,736	8,303	10.1
Appliances	2,338	2,573	2,845	2,548	2,705	2,870	3,105	3,423	3,725	7.9
Other Consumer Products	1,069	1,286	1,675	1,235	1,310	1,496	1,772	2,274	2,662	16.6
<b>Total</b>	<b>16,914</b>	<b>19,586</b>	<b>23,638</b>	<b>22,639</b>	<b>24,123</b>	<b>26,482</b>	<b>29,429</b>	<b>32,550</b>	<b>34,889</b>	<b>9.0</b>

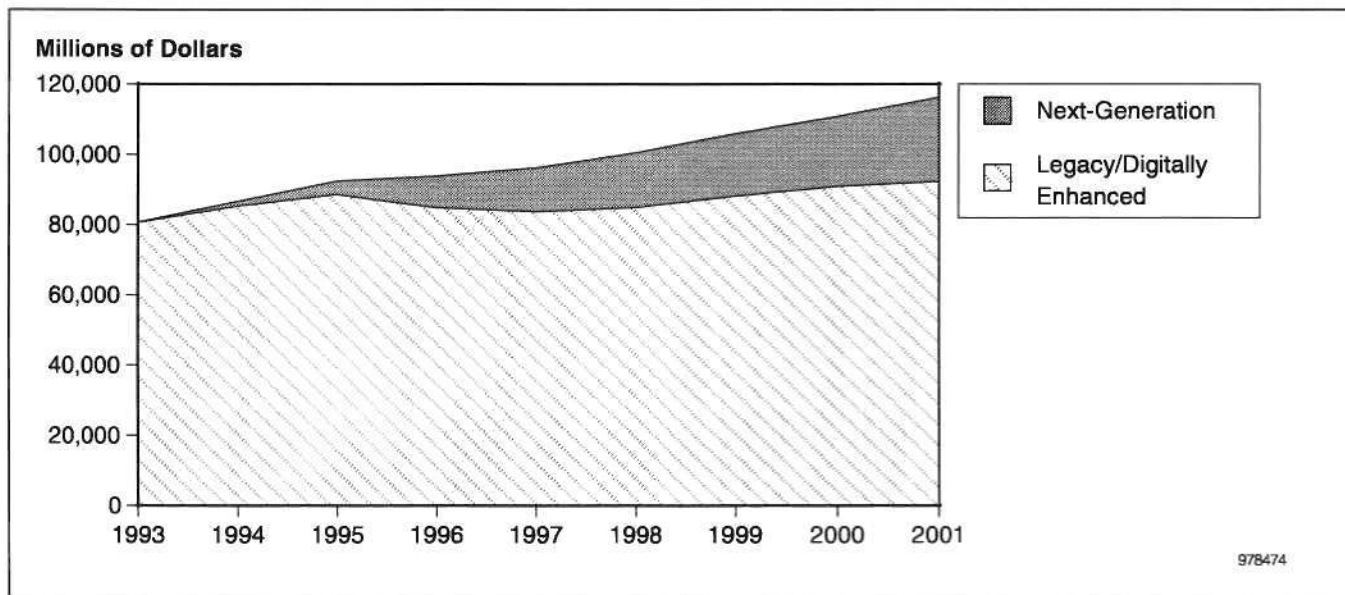
Source: Dataquest (November 1997)

**Table 3**  
**Consumer Electronics Equipment Production Forecast by Product Generation**  
**(Millions of Dollars)**

Product Generation	1993	1994	1995	1996	1997	1998	1999	2000	2001	CAGR (%) 1996-2001
Legacy/Digitally Enhanced	80,661	85,331	88,556	84,836	83,745	84,938	88,104	90,916	92,301	1.7
Next-Generation	58	1,295	3,995	9,087	12,557	15,607	17,847	19,934	23,958	21.4
<b>Total Consumer Electronics</b>	<b>80,719</b>	<b>86,626</b>	<b>92,551</b>	<b>93,923</b>	<b>96,303</b>	<b>100,545</b>	<b>105,951</b>	<b>110,850</b>	<b>116,259</b>	<b>4.4</b>

Note Does not include Appliance and Other Consumer Products categories  
Source: Dataquest (November 1997)

**Figure 2**  
**Consumer Electronics Equipment Production Forecast by Electronic Product Generation**



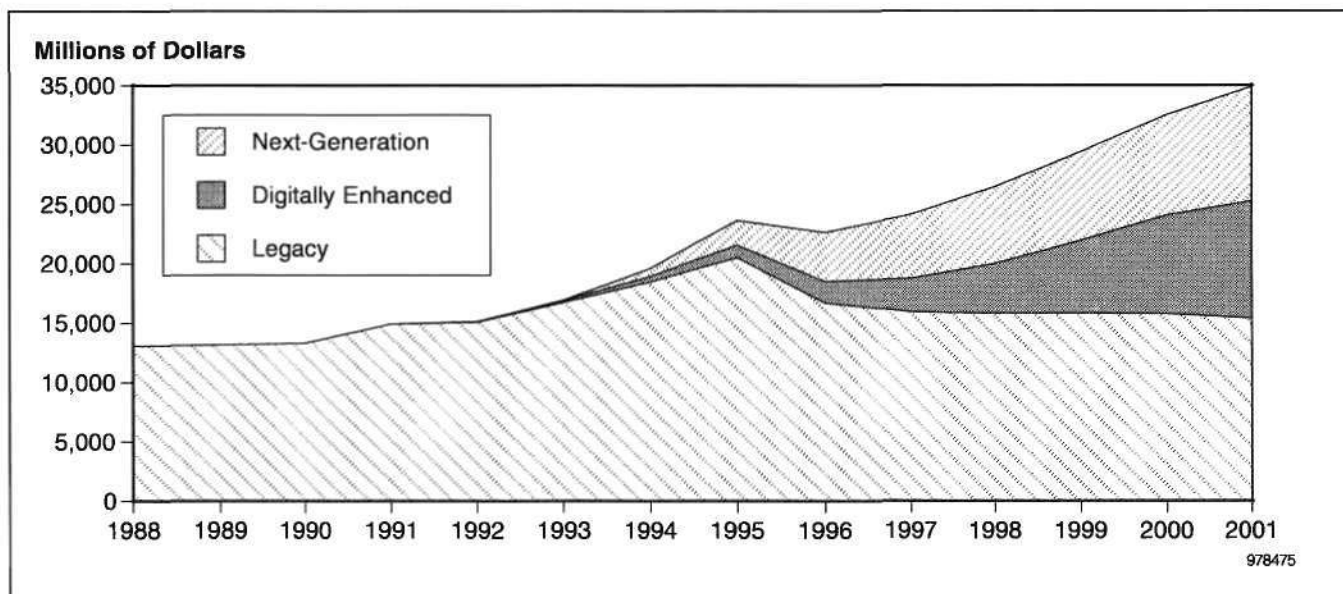
Note: Does not include Appliance and Other Consumer Products categories  
Source: Dataquest (November 1997)

**Table 4**  
**Worldwide Consumer Electronics Semiconductor Market Forecast by Product Generation (Millions of Dollars)**

Product Generation	1993	1994	1995	1996	1997	1998	1999	2000	2001	CAGR (%) 1996-2001
Legacy	16,734	18,467	20,501	16,697	15,958	15,809	15,807	15,796	15,403	-1.6
Digitally Enhanced	150	450	1,054	1,807	2,799	4,196	6,136	8,282	9,846	40.4
Next-Generation	30	668	2,083	4,135	5,367	6,477	7,486	8,472	9,640	18.4
<b>Total Consumer Electronics</b>	<b>16,914</b>	<b>19,586</b>	<b>23,638</b>	<b>22,639</b>	<b>24,123</b>	<b>26,482</b>	<b>29,429</b>	<b>32,550</b>	<b>34,889</b>	<b>9.0</b>

Source: Dataquest (November 1997)

**Figure 3**  
**Worldwide Consumer Electronics Semiconductor Market Forecast by Product Generation (Millions of Dollars)**



Source: Dataquest (November 1997)

## Regional Snapshot

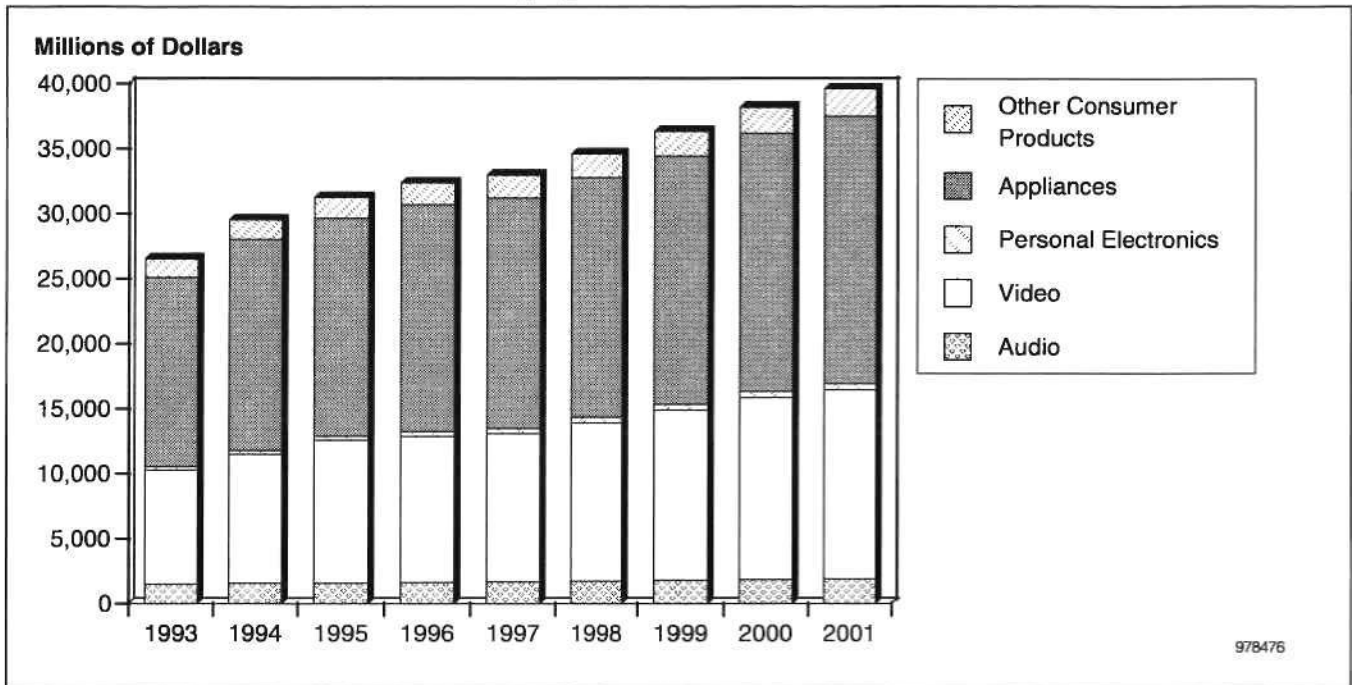
Consumer electronics equipment production in the Americas is forecast to grow by 4.1 percent CAGR through the year 2001, as shown in Table 5 and Figure 4. While the Americas production will continue on a steady pace, the large majority of production will still take place in Japan and the Asia/Pacific region. As illustrated in Figure 5, nearly two-thirds of all consumer electronics production takes place in these regions.

**Table 5**  
**Americas Consumer Electronics Equipment Production Revenue Forecast (Millions of Dollars)**

Segment	1993	1994	1995	1996	1997	1998	1999	2000	2001	CAGR (%) 1996-2001
Audio	1,498	1,575	1,576	1,622	1,686	1,743	1,796	1,856	1,914	3.4
Video	8,780	9,909	10,995	11,253	11,412	12,159	13,094	13,992	14,542	5.8
Personal Electronics	269	307	329	355	391	439	453	474	495	6.9
Appliances	14,547	16,211	16,759	17,470	17,723	18,416	19,073	19,849	20,546	3.3
Other Consumer Products	1,429	1,527	1,595	1,663	1,753	1,835	1,918	2,010	2,103	4.8
<b>Total</b>	<b>26,523</b>	<b>29,529</b>	<b>31,254</b>	<b>32,363</b>	<b>32,965</b>	<b>34,592</b>	<b>36,334</b>	<b>38,181</b>	<b>39,600</b>	<b>4.1</b>

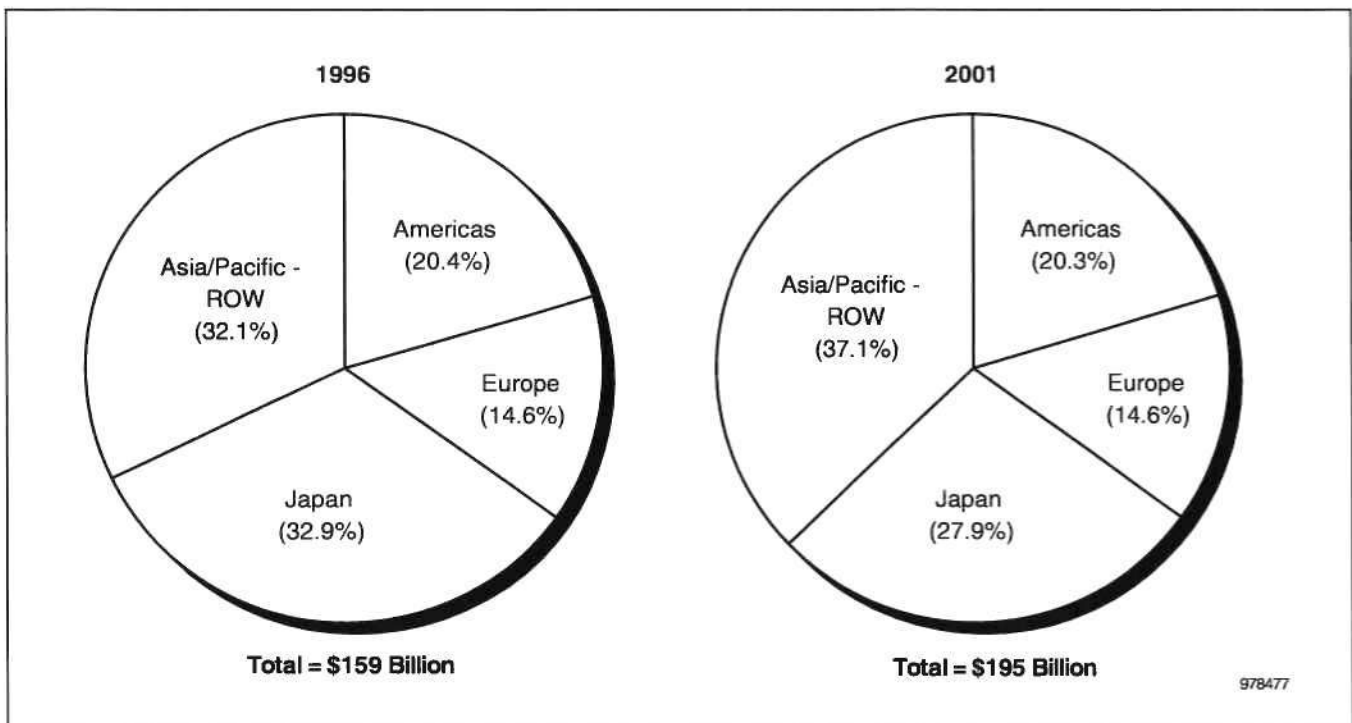
Source: Dataquest (November 1997)

**Figure 4**  
**Americas Consumer Electronics Equipment Production Revenue Forecast**



Source: Dataquest (November 1997)

**Figure 5**  
**Regional Share of Consumer Electronics Equipment Production Revenue**

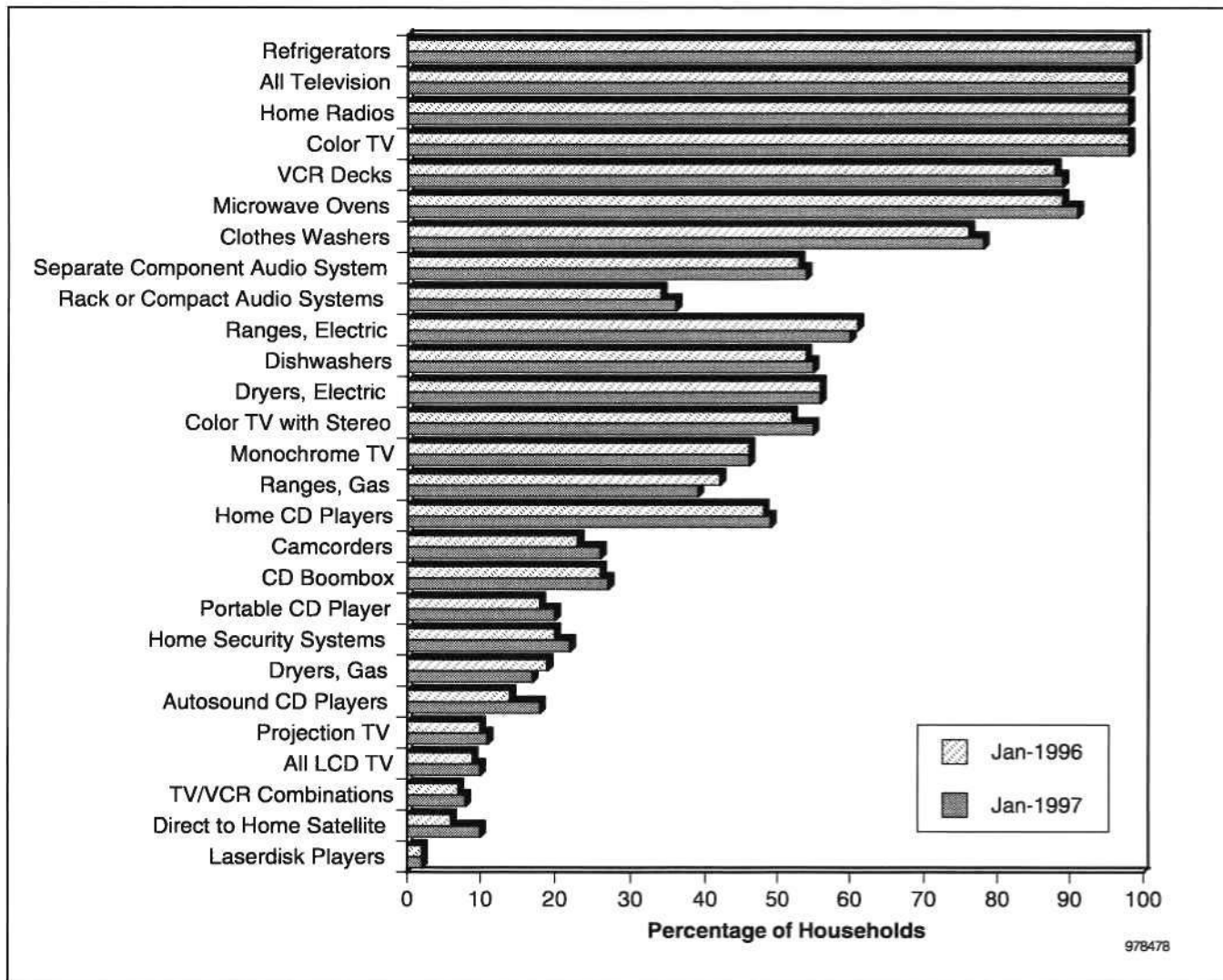


Source: Dataquest (November 1997)

Figure 6 provides an overview of the penetration of major consumer electronics products into U.S. homes. Although some products such as televisions, have reached near saturation, other products still have room for significant expansion. The market for high-penetration products such as TVs is mainly found in replacements and upgrades. As noted before, the consumer electronics industry is working to draw consumers back into the market with digitally-enhanced and next-generation products.

U.S. consumers are often some of the early adopters of new consumer electronics, and they are playing a critical role in driving nearly all of the next-generation consumer electronics markets. Although some products may be introduced in Japan first, the ultimate success of a product category often depends on its success in the U.S. market. The notable exception to this rule is the video CD market, which has boomed in China and other Asia/Pacific countries and is virtually unknown in the United States.

**Figure 6**  
**U.S. Household Penetration of Consumer Electronics Products**



Source: EIA, Appliance Magazine, Dataquest (November 1997)



## The Semiconductor Foundation

The relationship between the development of semiconductor technologies and products and the evolution of consumer electronics products is seen in Figure 7. Semiconductors play a fundamental enabling role in the development of next-generation consumer electronics markets. Over the next five years, technologies such as compression, encryption, and system-level integration will provide the foundation for the continued growth of an exciting consumer electronics market.

## Dataquest Perspective

Dataquest's optimism for the future growth of the consumer electronics industry is based on the early success and appeal of powerful and innovative new products. Semiconductor suppliers targeting this segment are depending on the ability of the consumer electronics industry to draw consumers back with these exciting new products.

However, appealing products and strong technologies are not enough to stimulate renewed growth in this industry. There are definite risks that could have a negative impact on the market. For example, frustrating standards battles have effectively delayed the development and growth of many of the new consumer electronics markets such as DVD and digital TV (DTV).

**Figure 7**  
**Semiconductor and Consumer Electronics Milestones**

	1950	1960	1970	1980	1990	2000
<b>Consumer Electronics</b>	1955 Transistor Radio	1966 IC Radio	1968 Minicassette IC Audio Tape Recorder	1979 Headphone Stereo 1982 CD Player	1987 DAT 1992 Mini-Disc Recorder/Player 1992 HDTV	1994 CD-ROM Based Game Machine 1996 DVD 1995 Digital VCR
		1960 Transistor TV	1964 Trinitron Transistor Color TV	1975 VCR	1985 8mm VCR 1986 DSB	
<b>Semiconductor Technology</b>	Discrete Device	IC Functional Parts	LSI System Components	VLSI Subsystems	LULSI System-on-a-Chip	
	Ge Transistor	Si Transistor MOS Transistor MOS IC Monolithic IC for Pocket Radio	256-Bit SRAM 4-Bit MCU	CMOS IC ICs for CD Player Semiconductor Laser CCD Imager	30,000 Gate ASIC 4Mb DRAM GaAs Device for SHF	100,000 Gate ASIC 16Mb DRAM

978479

Source: Sony

In spite of stated agreements, it is too early to tell if these battles are over—a better description would be a temporary truce. Ongoing standards issues in DVD could derail this market for another 12 to 18 months. The competing camps in DTV could also employ strategies that could delay this market. Another significant issue is the overall economic health and consumer confidence in critical markets. The financial and currency crisis in Asia/Pacific and Japan could inhibit the growth of these markets.

In sum, Dataquest is cautiously optimistic about the renewed growth of the consumer electronics industry and the associated semiconductor market.

---

**For More Information...**

Dale Ford, Principal Analyst ..... (408) 468-8311  
Internet address ..... dale.ford@dataquest.com  
Via fax ..... (408) 954-1780  
Dataquest Interactive ..... <http://www.dataquest.com>

The content of this report represents our interpretation and analysis of information generally available to the public or released by responsible individuals in the subject companies, but is not guaranteed as to accuracy or completeness. It does not contain material provided to us in confidence by our clients. Reproduction or disclosure in whole or in part to other parties shall be made upon the written and express consent of Dataquest.

©1997 Dataquest—Reproduction Prohibited  
Dataquest is a registered trademark of A.C. Nielsen Company

Perspective



Consumer Multimedia Semiconductors and Applications  
Worldwide  
**Market Analysis**

**Consumer Electronics Semiconductor Application Market  
Second Quarter Outlook**

---

**Abstract:** *This Perspective summarizes the worldwide situation for consumer electronics equipment and consumer electronics semiconductors in the second quarter of 1997. Descriptions and analysis of worldwide economic conditions, consumer electronic equipment sales, and company performance are provided, along with an outlook for the remainder of the year.*  
*By Kun Soo Lee*

---

**Second Quarter Market Status**

**The United States**

The economic situation in the United States continued to be strong in the second quarter. Real gross domestic product (GDP) in the United States increased at an annual rate of 3.6 percent in the second quarter, according to the Commerce Department. While GDP showed a healthy increase, it was down significantly from the blistering 4.9 percent in the first quarter of the year. Most economists said the slowdown was positive for economy, as it staved off any threat of inflation. Consumer optimism also was high in the quarter, with the Conference Board's consumer confidence index reaching 127.1 for the month, a 28-year high.

However, for the consumer electronics market, the strong economy and consumer confidence did not translate into a boom in sales. In video products, sales declined about 1 percent for the quarter compared to the second quarter of 1996. Some manufacturers say sales of televisions continue to be impacted by consumers' worries about the advent of digital television

---

**Dataquest**

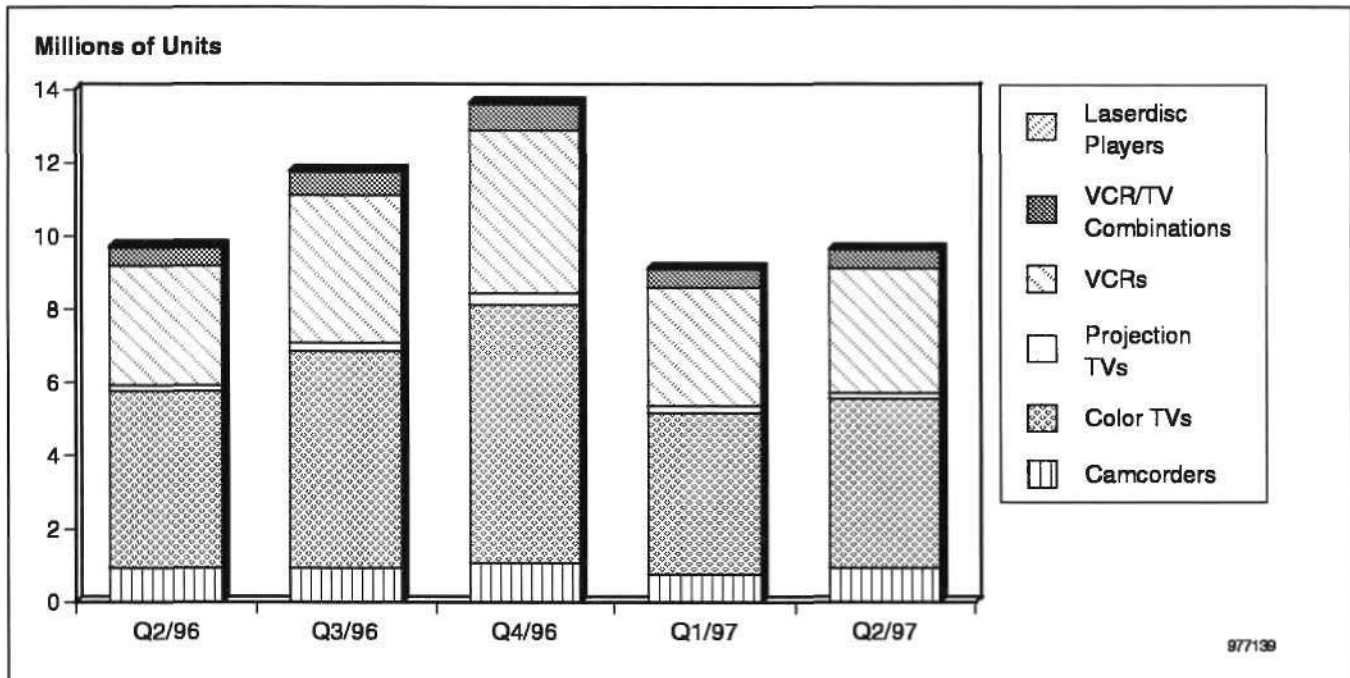
**Program:** Consumer Multimedia Semiconductors and Applications Worldwide  
**Product Code:** MSAM-WW-DP-9712  
**Publication Date:** November 3, 1997  
**Filing:** Perspective  
(For Cross-Technology, file in the Semiconductor Application Markets binder)

FILE COPY:  
MARIA VALENZUELA

(DTV) broadcasting in the United States in late 1998. However, some in the industry have begun to question whether alarming headlines about the demise of analog television have really had a negative effect on consumers' purchasing decisions. Those observers cite information from the Consumer Electronics Manufacturing Association (CEMA) indicating that sales of large-screen televisions (30 inches and larger) actually increased by 12 percent in the first half of the year. However, sales of projection televisions were down slightly for the first half of the year (see Figure 1).

Second-quarter doldrums appear to be affecting other portions of the market as well, including previously hot product areas like direct broadcast satellite (DBS) set-top boxes. DBS subscriber growth in the United States in the second quarter has slowed compared to the same period in 1996. However, if 1996 is an example, the DBS industry can expect a rebound in the fourth quarter because of the holiday buying season.

**Figure 1**  
**U.S. Sales of Consumer Electronics Video Equipment to Dealers (Millions of Units)**



Source: CEMA

### Europe

The economic climate in Europe continues to slow. France and Germany continue their economic slowdown as they prepare for monetary union. Most governments of European Union (EU) member countries are working hard to bring their economies into line with the EMU-entry criteria. Germany, the largest European consumer Europe, continues to slide slowly into recession, which means growth for consumer electronics is expected to be flat, at best, and will probably be negative.

In the United Kingdom, monetary union is less of a concern; however, consumer spending is starting to push inflation upward, and the Bank of

England has responded by increasing interest rates four times since the beginning of May. The aim is to control consumer spending, which is still expected to show modest growth by the end of the year.

The two main areas of interest in consumer applications are TVs and digital set-top boxes. TV production continues to grow in both Western and Eastern Europe. Still, Central and Eastern Europe show some economic indicators that are not so positive, which will have an effect on producers in the region, mainly Asian companies that have set up joint ventures to manufacture locally to service Eastern European markets as well as Western Europe. Consumers in the region are facing rising inflation, which in turn is reducing spending on luxury items such as TVs.

As for Western Europe, the growth continues in the home cinema and wide-screen 16:9 market. This has slowed from 1996, due mostly to a slowdown in France, where much of the growth came from early adopters. There are no signs that consumers are holding back from buying TVs in expectation of the imminent arrival of digital TV sets with integrated digital-terrestrial IRDs. These new sets are expected to enter the market in 1998, primarily in the United Kingdom and later in the Scandinavian markets.

Digital STB production slowed during the second quarter. Of the three methods of transmitting digital video in Europe, satellite is still the most advanced, with terrestrial in second place (because of launch in 1998) and cable following in third place. Digital satellite services have been launched in a number of countries in Europe, but only in France has the number of subscribers reached forecast numbers to date. Other services are suffering from low subscriber take-up, and as a result, slow revenue. The reasons for this slow adoption vary from the cultural to the commercial.

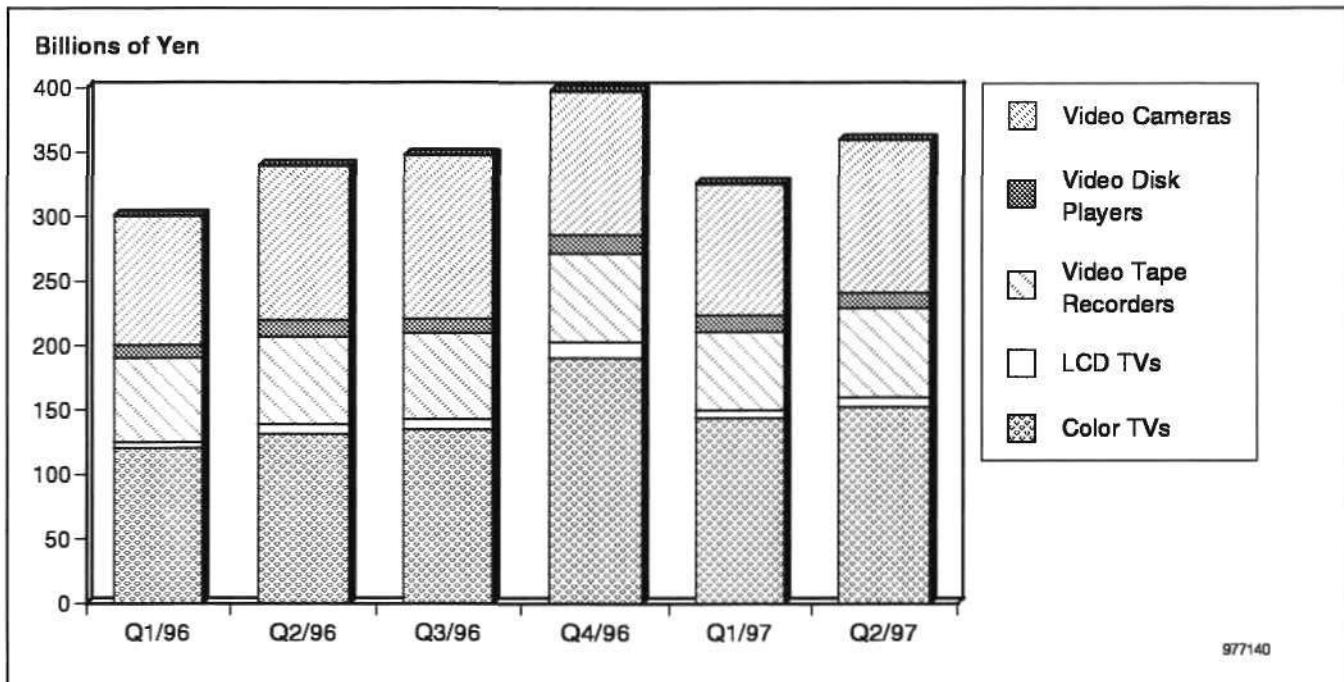
### **Japan**

In the second quarter of 1997, electronic equipment production in Japan grew 6 percent from a year ago to ¥360 billion. Compared to the first quarter in 1997, it was up 10.5 percent. However, this rise is not as encouraging as it may seem. As seen in Figure 2, production in fourth quarter 1996 recorded notable growth because of seasonal factors such as year-end bonuses and Christmas shopping. The following quarter suffered a decline in comparison to the booming quarter. Thus, double-digit growth from first quarter 1997 should be discounted to reflect these facts.

It is safe to say that seasonal factors worked again in the second quarter's production figures. But what about the annual 6 percent growth, which is not a reflection of seasonal factors? Breakdown of data by segment reveals why optimism is inappropriate. The growth has been driven entirely by a single segment: color TV. Color TV production soared 16.1 percent, totaling 153 billion yen and accounting for 42 percent of total video-related equipment production. In contrast, VCR production, second to color TV, showed a meager 1.7 percent increase. LCD TV production, in the third place, remained almost flat with a 0.9 percent increase. Video cameras recorded negative growth of 0.6 percent, and video disk player production dropped 11.3 percent.

Consumer electronic equipment inventory, an important indicator for the industry's outlook, declined 6.2 percent in April 1997 compared to a year earlier, down 16.4 percent in May and down 15.8 percent in June. Inventory shrinkage in three consecutive months of the second quarter is definitely a good sign for future growth.

**Figure 2**  
**Japanese Production of Video Equipment (Billions of Yen)**



Source: Dataquest (September 1997)

## Industry Participant Update

Table 1 summarizes revenue of leading companies in the consumer equipment industry during the second quarter. Note that these companies are classified into three categories: chip sellers, equipment sellers, and equipment/chip sellers.

Zoran has been negatively impacted by the delay in the takeoff the DVD market. Zoran is primarily a supplier of AC-3 audio chips into this market. With problems concerning patents and availability of titles, the growth of the DVD market has been delayed. Zoran had been counting on the DVD market to drive sales of its ZR38521 and ZR38500 AC-3 audio controllers and its ZR36120 PCI controller. This did not happen in the second quarter; meanwhile, Zoran is facing new competition in design-wins from other companies for AC-3 decoders.

Texas Instruments had revenue of \$2.6 billion in the second quarter, up 7 percent from \$2.4 billion in the second quarter of 1996.

**Table 1**  
**Key Consumer Electronic Market Equipment and Chip Sellers**

Company	Q2/97 or H1/97 Revenue (U.S.\$)	Q2/96 or H1/96 Revenue (U.S.\$)	Q2/97-Q2/96 or H1/97-H1/96 Revenue Change (%)	Q2/97-Q1/97 or H1/97-H2/96 Gross Margin Change (%)	Inventory Days Q2/97	Inventory Days Q1/97
<b>Chip Sellers</b>						
C-Cube Microsystems Inc.	71,098	72,958	-2.5	-0.5	61.8	43.1
ESS Technology Inc.	45,142	48,450	-6.8	-9.0	97.0	74.3
SCS-Thomson Microelectronics B.V.	963,900	1,039,700	-7.3	-0.2	84.1	79.8
Texas Instruments Inc.	2,559,000	2,845,000	-10.1	2.6	41.5	38.7
LSI Logic Corporation	332,004	325,359	2.0	2.3	50.1	44.3
Motorola Inc.	7,521,000	6,835,000	10.0	-0.7	65.7	71.3
Zoran Corporation	6,216	9,302	-33.2	16.0	26.7	26.5
<b>Equipment Sellers</b>						
Scientific-Atlanta Inc.	322,700	272,725	18.3	0	0	84.5
Zenith Electronics Corporation	261,800	282,100	-7.2	-8.0	0	83.8
NextLevel (formerly General Instruments)	450,403	408,028	10.4	-9.9	30.0	0
Nintendo Company Ltd.	NA	NA	NA	NA	NA	NA
Philips Electronics NV	9,425,400	9,510,000	-0.9	NA	NA	NA
Samsung Electronics Company Ltd.	NA	NA	NA	NA	NA	NA
NEC Corporation*	NA	10,011,500	NA	NA	NA	NA
Sony Corporation	11,930,895	11,721,560	1.8	NA	84.8	76.3
Pace Micro Technology plc	83,067	74,646	11.3	NA	81.0	85.0
<b>Equipment/Chip Sellers</b>						
SANYO Electric Company Ltd.*	NA	3,979,005	NA	NA	NA	NA
LG Electronics Company Ltd.	NA	NA	NA	NA	NA	NA
Sharp Electronics Corporation*	NA	3,061,940	NA	NA	NA	NA

\*Half-year reports shown

NA = Not available

Source: Dataquest (September 1997)

Scientific-Atlanta's 18.3 percent increase in revenue was partly because of rapid sales growth of its advanced analog cable set-top box products. Overall, its sales in this area were up 67 percent in the quarter compared to



the same period in 1996. During the quarter the company delivered 470,000 units of 8600x advanced analog set-top boxes.

## **Notable Industry and Product and Technology Introductions**

### **Bandai and Sega Cancel Merger**

Bandai and Sega Enterprise called off the engagement—the much-publicized merger that was slated for October 1, 1997. The announcement was made at separate press conferences held by the two companies on May 27—9 p.m. by Sega and 10 p.m. by Bandai. Both companies stated that the cancellation of the merger agreement was decided by a Bandai special board meeting on February 27, 1997, and that Sega was notified the same day. An official of Bandai said, "We found a major difference in corporate culture. There were uncertainties about customers and trade partners. Above all, we could not find any tangible synergy effect from the merger."

Nevertheless, the two companies will seek opportunities for alliance in the following areas:

- Use popular characters held by Bandai on Sega's arcade game machines
- Develop multimedia products that integrate Bandai's proprietary characters with Sega's graphic-drawing technology
- Proceed with collaboration in production and distribution

President Yamashina of Bandai commented on multimedia products, "We have not decided any concrete plan."

### **Bandai after the Merger Cancellation**

The proposed merger of Sega and Bandai promised to create an "integrated entertainment company." On May 27, the promise was broken suddenly. As it turned out, Mr. Makoto Yamashina, president of Bandai, was unable to obtain consensus of the management and had no choice but to notify Sega, which reluctantly agreed to call off the merger. The question remains, does this incident mean a total defeat for Mr. Yamashina?

Mr. Yamashina, despite his efforts to push the merger forward, has been forced to sound the retreat for three reasons. First of all, Mr. Yoshimasa Sugiura, Sega Group's chief of staff, made a quiescent protest by declining the offered appointment as executive vice president of the new company. Mr. Naoji Yamashina, Bandai's founder and active advisor, was persuaded by old-timers and turned against his son in April. Having learned about oppositions of the two key figures, 90 percent of department managers and deputy managers and 80 percent of section managers voiced their opposition by submitting a petition "to request careful consideration." Having so much to lose after the merger was the major reason for opposition by the management and employees. They should have realized this sooner, however; in fact, the concern was raised shortly after the announcement of the merger. Having second thoughts immediately before the closing of the merger agreement, followed by an embarrassing confusion, clearly reflects the indecisiveness of the management.

"As it turned out, all of Bandai's executive officers silently opposed the merger," a Sega's official concluded bitterly. If so, why did they fail to express their objections until the final moment? If they need the opposition of the two big shots and the rebellion by managers to summon their courage, they must accept the harsh criticism that "the board is dead and the company must be modernized to cast off its old shell of family business."

Again, does this episode mean total defeat for Mr. Yamashina? On May 29, only two days after the demise of the merger, Bandai announced that the president would become the chairman and appointed Mr. Takashi Mogi, president of a group company, as successor. At the same time, the father and founder formerly retired, accompanied by six directors, mainly those who opposed the merger. Clearly, Mr. Yamashina, maintaining his family-business style and converging power, seems to be ready to make a second attempt for "the integrated entertainment company."

### **Sega after the Failed Merger**

In fact, the unsuccessful merger attempt may have hit Sega harder than Bandai, for it will surely stir up the long-time discord between the two top executives by empowering Mr. Ohkawa, chairman of Sega and CSK (parent company), while enfeebling Mr. Nakayama, president of Sega. Mr. Ohkawa, who would become the chairman of the new company, will be able to wield his power after June by becoming a representative director. The two top executives have been rumored to differ in management policy, and many believe that they are headed for a direct collision sooner or later.

A potential source of conflict is the home game business where Sega fights a losing battle against Sony Computer Entertainment. Mr. Ohkawa urges the company to "join the Sony's pact even if it means a surrender" and refocus on the software business. On the other hand, Mr. Nakayama believes that "the home video game system is what has made Sega a household name," and he insists his company hold onto the hardware business. Although both of them voice the willingness to work together, if the relationship goes astray, its impacts on the company would be incalculable. In this sense, the failed merger may create more uncertainties for Sega than for Bandai.

### **Sega Shifts to MMX-Powered Game with VirtuaFighter 2**

Sega Enterprises will introduce video games using MMX technology and running on Windows 95. It plans to deliver one title per month. The new games, although running on non-MMX PCs, are touted as allowing more exciting play on machines equipped with MMX Pentium chips or other MMX-powered CPUs. PC games demand more CPU power, including graphics, and MMX technology delivers faster performance if other configurations are identical. Sega intends to supply more arcadelike games by incorporating MMX into its platform. It will start storefront sales of Denno Senki Virtuaron—the first game designed for MMX machines—in June. More titles will hit the market in late August and afterward, including the 3-D interactive combat game VirtuaFighter 2.

### **Sega's Next-Generation Game System Will Go without 3Dfx**

According to the announcement made by U.S.-based 3Dfx Interactive Inc., Sega Enterprises has decided to forgo the plan to use 3Dfx's 3-D graphics LSI in its next-generation home video game system. The company has been developing the graphics chip for Sega since March 1997. The chip was intended to be used in combination with Hitachi's SH4, which would perform matrix calculation on floating-point data, which are frequently used for conversion of coordinates in 3-D graphics. Sega has made an equity contribution of \$2 million to 3Dfx. Now, Sega will likely use a PowerVR-based 3-D graphic chip that is being developed by U.K.-based Video Logic Ltd. and NEC.

### **Bandai Says "No Withdrawal from Pippin" after the Failed Merger**

Bandai Digital Entertainment (BDE) has denied the withdrawal from Pippin reported by some media on May 11. Although the home multimedia terminal is still having a hard time in the market, the company emphasized it would continue the business. Mr. Shin Unosawa, a director of BDE, explained, "We have simply suspended production for inventory adjustment, which gave a misimpression to some as "BDE has terminated production, which means the withdrawal from the business," and assured that "production will be resumed once inventory is adjusted. The business will continue." Sales channels will also be expanded, in addition to custom production for businesses, to retail stores in order to serve general consumers. Support for the installed base will also continue. Mr. Unosawa further explained the reason for employment reduction, saying "We wanted to reallocate software engineers to Bandai." Clearly, the move is another evidence of the company's restructuring efforts. In the abandoned merger deal with Sega, BDE would have expanded this business as part of the multimedia company under the Sega Saturn brand.

### **LG Group Plans Additional Investments in the Philippines**

The LG Group, one of Korea's largest conglomerates, wants to cash in on the booming Philippine economy and has disclosed plans to expand its investment interests in the country to include telecommunications, construction, trading and securities brokerage. Kenn Suh, president of LG Electronics for Asian operations, recently told reporters that four subsidiaries—LG International, LG Information and Communication, LG Construction, LG Industrial Systems, and LG Securities—are currently checking out Manila's business prospects and are scouting for local joint-venture partners. So far, appliance and consumer electronics maker LG Electronics is gearing up to grab the top spot in the local market by expanding its manufacturing facility. It will soon transfer its manufacturing plant in Pasig to a 30-hectare appliance assembly facility in Batangas. Mr. Suh said the Philippines will be LG's fourth electronics production base in Southeast Asia after Indonesia, Thailand, and Vietnam.

LG Collins, a joint venture between LG Electronics and local businessmen led by the Lim family, will be developing a 130-hectare industrial estate in Batangas. Some 30 hectares will be dedicated to the company's manufacturing facility. Samie Lim, president of LG Collins, told reporters

they will be spending P1 billion for the development of the industrial estate, which will be called the Global Business Village. LG Collins, which distributes the Goldstar brands of home appliances including television sets, will engage in a multibrand, multiproduct marketing strategy to top the market, Mr. Lim said. Under the plan, LG will cater to the high-end market, and Goldstar will be dedicated to middle-and low-end consumers. He said the LG Group has also bought the American Zenith appliance brand, which will be marketed to middle-end buyers. "We are projecting sales of P3 billion this year from about P1 billion last year," he said. Mr. Lim said LG Collins currently ranks fifth among 35 appliance manufacturers and distributors.

### **New Chip Announcement Reflects Commitment of U.S. Companies to Information Appliance**

Between August 24 and 26, 1997, HOT Chips IX, a symposium on microprocessor and other design technologies was held at Stanford University in the United States. This year, a majority of presentations was on the chips for information appliances, such as digital TV, and home electronics equipment including PCs with enhanced 3-D capabilities.

There were two sessions to cover accelerators for time-varying image processing and 3-D graphics, titled Media/3D/Graphics Processors. France Telecom announced a media processor to modify processed images by using software. Cirrus Logic unveiled Lagna II, an accelerator for processing animated pictures and 3-D graphics that will be used in combination with Rambus DRAMs. In 3-D graphics, five companies, including U.S.-based 3Dlabs Inc., announced new chips.

In the session entitled Embedded Processors, Hitachi reported detailed specifications for the SH-4. The chip is reportedly a primary candidate for the next-generation game system from Sega Enterprises, and a major concern of participants in the session will be its 3-D graphics capabilities. NEC announced the RISC chip code-named Scarlet. The V830R is based on the superscalar architecture that enables simultaneous execution of two commands, and interface for Rambus DRAM.

In the Specialized Chips session, TI revealed architecture for a VLIW-type DSP core. TMS320C60 will be incorporated to the chip for asymmetric digital subscriber line (ADSL) modems. TI is developing the digital TV chip based on the core, which is capable of handling multiple data formats. Finally, Intel announced the accelerated graphics port (AGP)-based chipset known as 82440LX. It will be indicative of how far 3-D graphics capabilities for PCs can be improved.

In addition to these announcements, the symposium offered diverse programs including equipment trend reports and tutorials. One major feature of the symposium is the hyped efforts of the U.S. industry to bring the information revolution to home.

### **Set-Top Box Standards for Digital Transmission Cable TV Include Compatibility with PerfectTV Programs**

Japan CATV Technology Association, an external arm of the Ministry of Posts and Telecommunications, compiled standards for the set-top box used with digital transmission cable TV. It incorporates modulation system and error correcting code specifications recommended by the Council on Telecommunications Technology in May 1996. Digital transmission has been commenced by four cable TV companies—1997LCV, Tokyo Cable Television, Tokyo Cable Network, and Nippon Network Service—on an experimental basis, starting in May. Hitachi has already developed a prototype receiving device that complies with the proposed standards.

The new standards basically contain two key components. First of all, they adopt the same scrambling method and IC card interface (for accounting) as those used in PerfectTV receivers, which recently started digital satellite broadcast service. This allows scramble IC and other peripherals to be commonly used, hopefully to reduce the set-top box cost. As a result, cable companies will not have to unscramble programs purchased from satellite broadcasters. A block-encoding method developed by Hitachi, called MULT12, will be used for this purpose. Secondly, the standards allow cable companies to control unscrambling. This way, they will be able to offer their own programs and price systems. Satellite broadcast waves contain a key required for unscrambling (work key) and service provider's ID, and the standards specify the mechanism to convert them.

### **Two OFDM Demodulation LSIs from LSI Logic and Motorola**

U.S.-based LSI Logic and local subsidiaries of Motorola in Switzerland and Germany announced OFDM demodulation chips designed for digital terrestrial broadcasting service, which is scheduled to start in the United Kingdom in the summer of 1998.

LSI Logic announced the commercial shipment of the chip developed jointly with BBC, a public broadcasting corporation in the United Kingdom, starting in early 1998. The chip receives IF signals with a center frequency of 4.5 MHz. A-D converts them with 8-bit quantization level, which are OFDM demodulated, Viterbi-decoded, and de-interleaved before output. The signal then goes through the Reed-Solomon error correction process to obtain MPEG2 transport streams. The number of carrier waves for OFDM demodulation correspond to both 2K and 8K. Modulation methods are QPSK, 16-value QAM, and 64-value QAM. The guard interval can be selected from 1/4, 1/8, 1/16 or 1/32 of symbol length. According to LSI Logic Japan, the common phase error (CPE) correction circuit allows the use of a low-cost tuner circuit.

Motorola's OFDM demodulation chip was announced at ICCE '97 held in June (A. Buttar, presentation No.WPM7.3, June 1997). It consists of two chips, a serial-parallel conversion LSI required for OFDM demodulation and an FFT LSI (the number of carrier waves is equivalent to 2K). The A-D converter is externalized. The announcement was made jointly by Motorola (Switzerland and Germany) and DigiMedia Vision (of the United Kingdom).

### **Ministry of Posts and Telecommunications to Start Verification Test for Digital HDTV**

In preparation for digitization of satellite broadcasting (BS), the Ministry of Posts and Telecommunications of Japan will launch a verification test for digital high-definition TV (HDTV) in August 1997. A transponder installed on the active broadcast satellite (BS-3b) will be leased to a station for R&D and experimental service purposes. The test period will be up to 2000, until the BS-3b is available for commercial use. The BS-3 will be replaced with the BS-4 in August 1997.

### **LSI Logic Offers a Single Chip Solution for Integration of Digital Camera Image Processing**

LSI Logic and Minolta have jointly developed a chip integrating major image processing capabilities for digital still cameras. The DCAM-101 will be fabricated on the company's 0.35-micron process, which is used for production of its ASIC G10 series. DRAM and other memories and analog circuits including A-D converters are not included. Sample shipment will start at the end of 1997, followed by volume shipment now slated for the first half of 1997. The price, based on volume shipment, will be ¥3,900. The chip will be packaged in 256-pin, thin QFP, with maximum power consumption of 1.2W. The DCAM-101 consists of the following functional blocks: a JPEG-based coding/decoding circuit, a microprocessor core for system control (MiniRISC), a production-sum operation unit, a coprocessor for pixel generation (outline enhancement, color space conversion, pixel interpolation, and scaling), an interface circuit for CCD camera, an NTSC/PAL encoder, a DA converter for TV signal output, a liquid crystal controller, an AT Attachment (ATA) interface circuit for flash EEPROM, a serial interface circuit for PC connectivity, a DMA controller (10 channels), and a power management circuit. The microprocessor core operates at a clock frequency of 54 MHz and is capable of coding image data at a rate of 3.3 million pixels per second. This allows consecutive recording of 11 pictures at 640 x 480-pixel (VGA) resolution. The maximum resolution per picture that can be coded is 4 million pixels.

### **Draft Extended Specifications for Image Compression of TV Telephony Address Needs Related to Mobile Communication and Internet**

SG-15 of International Telecommunication Union-Telecommunication Sector (ITU-U), working with standardization of multimedia systems, has mostly compiled extended specifications for international standards for TV telephony image compression, ITU-U Recommendation H-263. These will be incorporated into formal recommendations as Annex to H-263 in January 1998. Until then, it is tentatively named H-263+. H-263 is based on analog telephone lines and is a major candidate for MPEG4, which is now in the standardization process.

H.263+ added nine functions in the coding area. One of them, NEW-PRED, has been jointly proposed by Nippon Telephone and Telegram (NTT) and Oki Electric. It is intended for networks that must tolerate transmitting channel errors, such as mobile communication problems, including PHS and

the Internet. It prevents any transmitting channel error occurring in a compressed frame (image) from propagating to subsequent frames. More precisely, if a transmitting channel error prohibits normal decoding, by using Nack signal (decode abnormal) or Ack signal (decode normal) or in combination, the reception side can continue the decoding process by using normally decoded frames as reference. The Nack approach uses Nack signals from the reception side to specify any change in reference frame. The Ack system updates the reference frame on the basis of the most recent Ack signals received by the transmission side. The Ack/Nack approach uses both signals.

### **PCI Bus-Based Voice Source Chip under Development at Yamaha**

Yamaha is developing a wave table voice source LSI (OPL5-DS) that maintains compatibility with Sound Blaster Pro—the de facto standard in sound boards—and supports PCI bus. Most voice source chips that are commercially available support ISA bus, which slows the data transfer rate (8 Mbps) and is a major bottleneck for advanced sound effects such as Dolby AC-3 and acoustic image location. Vendors are now moving to PCI bus, which is faster (133 Mbps). U.S.-based Oak Technology Inc. has announced products capable of such advanced sound effects.

Yamaha has intentionally excluded a circuit processing AC-3 or similar sound effects from the voice source chip under development. Instead, it offers optional solutions for PC vendors and other system companies—an external dedicated LSI (AC3F2) or software solution. Yamaha believes that this software solution will be cost-effective in the case of AC-3. If a circuit for AC-3 processing is integrated, the chip price will increase 50 percent.

But there are not many users who enjoy AC-3 sound movies on PCs. The OLL5-DS conforms to AC'97 established by Yamaha, Intel, and others. It can generate 64 sounds simultaneously. It does not use a waveform ROM for wave table voice source, and waveform data is read out from the PC's main memory. The package is 144-pin QFP. Sample shipment is slated for the second half of 1997.

---

#### **For More Information...**

Kun Soo Lee, Research Analyst..... 81-3-3481-3670  
 Internet address ..... [kunsoo.lee@dataquest.com](mailto:kunsoo.lee@dataquest.com)  
 Via fax ..... (408) 954-1780  
 Dataquest Interactive ..... <http://www.dataquest.com>

The content of this report represents our interpretation and analysis of information generally available to the public or released by responsible individuals in the subject companies, but is not guaranteed as to accuracy or completeness. It does not contain material provided to us in confidence by our clients. Reproduction or disclosure in whole or in part to other parties shall be made upon the written and express consent of Dataquest.  
 ©1997 Dataquest—Reproduction Prohibited

**Dataquest**

A Gartner Group Company

Dataquest is a registered trademark of A.C. Nielsen Company

Perspective



## Consumer Multimedia Semiconductors and Applications Worldwide Market Analysis

### PC Multimedia Chip Vendors Climb a Rocky Slope

---

**Abstract:** Pricing volatility limits PC semiconductor market growth despite growing shipments of PCs. This Perspective provides Dataquest's PC and PC semiconductor forecasts with discussion of the trends and dynamics for major segments of the PC semiconductor market.

By Geoff Ballew

---

### PC Market Displays Sustained Momentum

The PC market should top 19 percent unit growth for 1997. While still a teenager, the PC market is mellowing somewhat as it heads toward the end of its second decade. Growth during the next four years will decline to 15.5 percent.

The ongoing growth of PC shipments stems from a strong replace-and-upgrade cycle, combined with new sales to growing businesses or PC-less consumers. Market growth hiccuped in 1996 with unit growth of only 17.7 percent after the robust growth of the first half of the decade. This year appears stronger because of new microprocessor offerings from Intel Corporation, specifically Pentium with MMX technology and Pentium II. Intel's Accelerated Graphics Port (AGP) creates opportunity because it provides a higher bandwidth attach point for graphics chips. Microsoft Corporation's Memphis and Windows NT 5.0 would have been nice additions on the operating system side this year, but both have been pushed into 1998 for OEM releases. Table 1 and Figure 1 present Dataquest's PC and PC semiconductor consumption forecasts.

FILE COPY:  
MARIA VALENZUELA

---

#### Dataquest

**Program:** Consumer Multimedia Semiconductors and Applications Worldwide

**Product Code:** MSAM-WW-DP-9711

**Publication Date:** October 13, 1997

**Filing:** Perspective

(For Cross-Technology, file in the Semiconductor Application Markets binder)

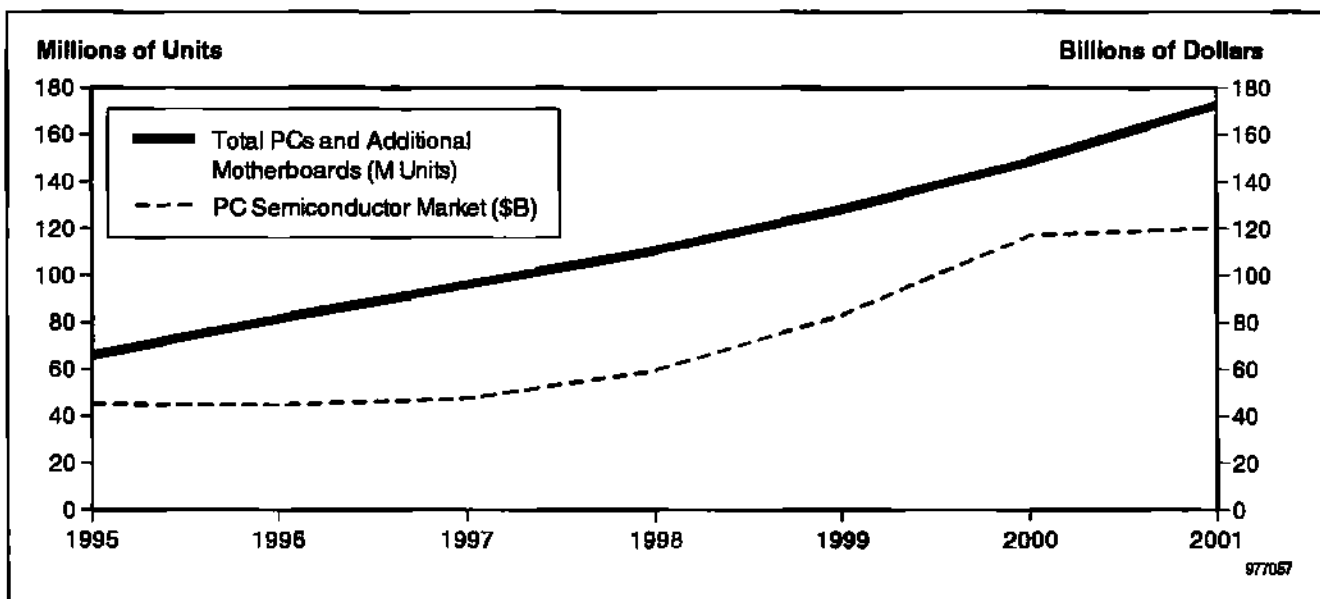


**Table 1**  
**PC Semiconductor Application Markets, 1995 to 2001**

	1995	1996	1997	1998	1999	2000	2001	CAGR (%) 1996-2001
PC Shipments (M Units)	60.2	70.9	84.3	98.4	113.6	131.2	151.6	16.4
Annual Growth (%)	-	17.7	19.0	16.7	15.5	15.5	15.5	-
ASP (K)	2.05	2.13	2.10	2.21	2.22	2.20	2.20	0.6
Revenue (\$B)	123.6	150.7	177.3	217.4	252.7	289.1	333.0	17.2
Handheld PCs (M Units)	0.244	0.573	0.803	1.144	1.723	2.396	3.830	46.2
ASP (K)	0.975	0.531	0.421	0.406	0.395	0.391	0.388	-6.1
Revenue (\$B)	0.238	0.304	0.338	0.464	0.681	0.937	1.487	37.4
Additional Motherboard (M Units)	5.5	10.2	10.9	11.4	13.1	15.0	17.2	11.0
Annual Growth (%)	-	84.3	7.1	3.8	14.8	14.9	15.0	-
Total PCs/ Additional Motherboards (M Units)	66.0	81.6	96.0	110.9	128.4	148.6	172.7	16.2
Semiconductor Content (\$)	685.2	548.8	497.1	539.2	647.4	787.5	697.4	4.9
PC Semiconductor Market (\$B)	45.2	44.8	47.7	59.8	83.1	117.0	120.4	21.9
Annual Growth (%)	-	-0.8	6.5	25.3	39.0	40.8	2.9	-

Source: Dataquest (September 1997)

**Figure 1**  
**PC Semiconductor Application Markets**



Source: Dataquest (September 1997)

### PC Pricing

Growth of the PC market is closely tied to the growth of features and performance but may also depend on reaching a broader consumer market. PC average selling prices (ASPs) have changed little during the past few years. The prices for specific models decline rapidly, but there is always a new PC offered at the old price point. For example, a \$2000 PC may sell for \$1,700 three months later, but only because a slightly better model has taken over that \$2000 price slot.

Microprocessor pricing has some similar dynamics. Intel's ASP has increased slowly despite the fact that the company lowers prices four times a year. Intel sells yesterday's \$350 processor for \$300 but convinces the consumer to buy a faster, more expensive processor that sells for \$355, slightly more than the previous product.

### **Attempts to Reach a Broader Market**

The problem with these PC marketing and pricing dynamics is that by the time a PC trickles down into the sub-\$1,000 price band, it is outdated. If everyone who wants a PC could afford to spend \$2,000, this issue would be moot. The reality is that many potential PC buyers are priced out of the market. PC OEMs tackling this untapped market have introduced new models designed to sell at prices around \$1,000. The sub-\$1,000 PC category also is referred to as "segment zero."

One example is the Presario 2200 series by Compaq Computer Corporation. These models feature the MediaGX processor from Cyrix Corporation rather than the latest and greatest from Intel. PC OEMs and software giants such as Microsoft are trying to broaden the appeal of PCs to the average consumer. Part of this strategy is to introduce compelling and less expensive models, but it also involves making PCs look and act more like consumer electronics. Issues involve everything from industrial design, ease of use, length of time it takes to "boot-up," and even audio and video quality.

The issue of audio and video quality is gaining much more attention. Taken to the extreme, this issue leads to "living room PCs," such as the Gateway Destination system with a big-screen, TV-sized monitor and the Compaq PC Theatre product. Audio and video quality is an issue in mainstream PCs, and the emphasis has grown to using traditional consumer devices as the standard (for example, TV-quality video playback). DVD is the ultimate bridge product between the consumer and computing markets and spurs the trend of comparing PC multimedia quality to that of consumer electronics products.

Attempts to broaden the appeal of PCs to more consumers may not be successful, but previous attempts have been half-hearted. This is the first year that new products have been designed and marketed without the stigma of being yesteryear's PC at a really low price. Note that the PC ASPs in the Dataquest forecast in Table 1 do not change over time. Segment zero sales resulting from the new low-cost PC initiatives could result in upside sales volume in the PC market. Greater sales of low-cost PCs would bring down the ASP but should result in higher units and total revenue.

### **Semiconductor Market Opportunities**

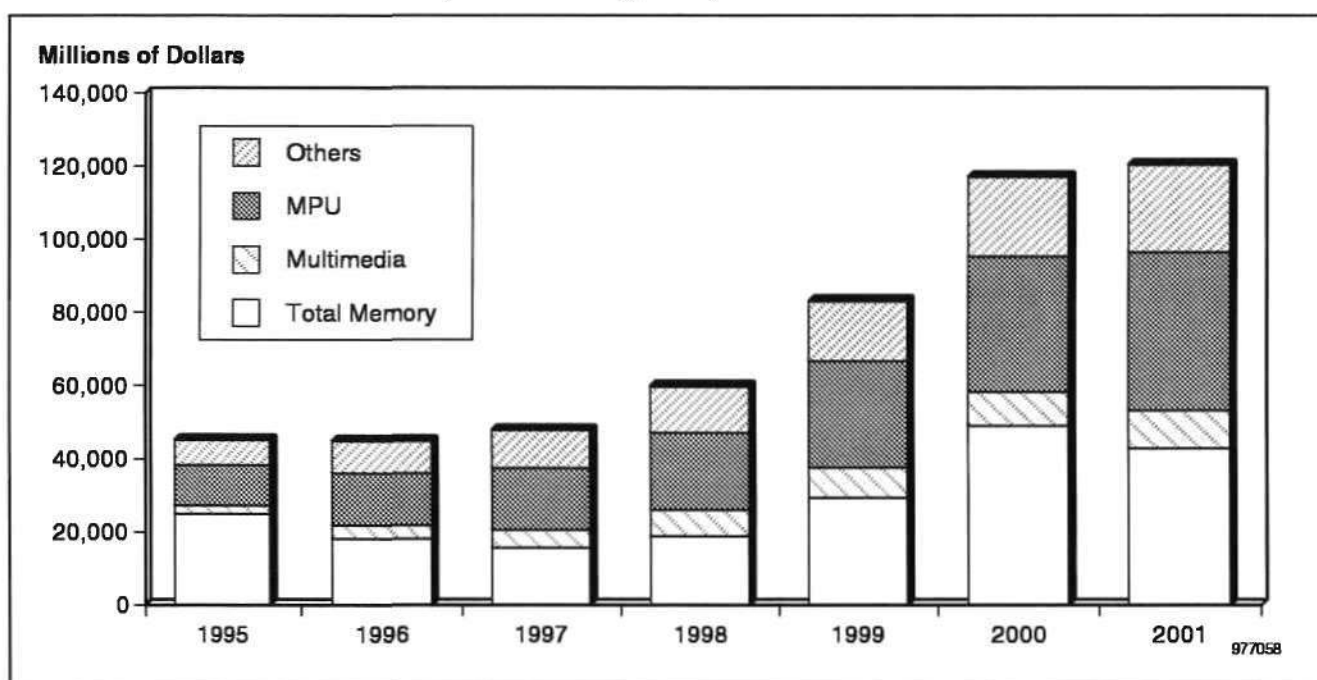
The PC semiconductor market is caught between falling DRAM prices and cutthroat competition on the multimedia peripheral side. Growth of 6.5 percent for the year follows almost a 1 percent decline in 1996. Table 2 and Figure 2 provide the same top-line PC semiconductor revenue forecast shown in Table 1 and add detail for the major market segments. The growth trends speak volumes about the market dynamics for each of the market segments.

**Table 2**  
**PC Semiconductor Forecast by Market Segment, 1995 to 2001 (Millions of Dollars)**

	1995	1996	1997	1998	1999	2000	2001	CAGR (%) 1996-2001
Total Memory	25,007.4	18,230.3	15,684.9	18,912.6	29,332.4	49,080.5	42,912.9	18.7
Multimedia	2,322.6	3,680.4	5,014.7	7,207.5	8,330.8	9,238.7	10,403.4	23.1
MPU	10,949.7	14,160.3	16,773.4	20,939.0	29,105.3	36,982.4	43,168.2	25.0
Others	6,916.0	8,740.9	10,266.1	12,735.7	16,345.4	21,728.4	23,937.7	22.3
<b>Total Revenue</b>	<b>45,195.8</b>	<b>44,811.8</b>	<b>47,739.1</b>	<b>59,794.9</b>	<b>83,113.9</b>	<b>117,030.0</b>	<b>120,422.1</b>	<b>21.9</b>

Source: Dataquest (September 1997)

**Figure 2**  
**PC Semiconductor Forecast by Market Segment, 1995 to 2001**



Source: Dataquest (September 1997)

### Microprocessors

Intel's dominance of the microprocessor market is shown clearly by the steady growth of microprocessor revenue. Pricing volatility is taken out of the equation for the most part, so revenue growth mirrors PC unit shipment growth. Of course, this segment grows a bit faster than PC unit shipments because of Intel's ability to increase its ASP every year. The rapid pace of clock scaling and product introduction has given Intel the ability to lower prices like clockwork while still getting buyers to spend a little more each year.

### Multimedia Chip Market

The multimedia segment of the PC semiconductor market is growing at the same time that price volatility erodes profit margins. This segment benefits from an increasing attach rate for PC audio chips and internal modems. Price

erosion in the multimedia chip market is severe. Single-chip audio products that were selling for \$10 at the end of last year now fetch less than \$5. Also, competition on the graphics side has moved up the feature list to include the 3-D category. Last year, only a few vendors had 3-D products priced for mainstream applications. This year, virtually every major vendor has 3-D products for sale. Rapid technology shifts in the multimedia chip market create opportunities for vendors to gain or lose significant market share.

### **3-D Graphics**

The shift to 3-D graphics from 2-D+video products creates volatility because so many new vendors are targeting the PC graphics market and using 3-D technology as their entree. Demand for 3-D features on the corporate desktop is a critical issue and affects who wins and loses in the market share game. Products such as S3 Incorporated's ViRGE DX/GX, Trident Microsystems Inc.'s 3D Image 975, Cirrus Logic's Laguna3D, and ATI Technologies Inc.'s RAGE II appeal to OEMs who want to add 3-D features to their designs but do not want to pay extra for better 3-D.

These products will continue to be successful as long as 3-D remains a check-off item. When actual 3-D performance is more of an issue, OEMs are more likely to pay a little more for the next tier of 3-D performance. That higher tier includes integrated 2-D/3-D products such as ATI's Rage Pro, NVIDIA's Riva 128, 3Dlabs Inc.'s Permedia2, Intel's upcoming chip named Auburn. Some 3-D-only accelerators, such as 3Dfx Interactive Inc.'s Voodoo Rush and NEC Electronics Inc.'s PowerVR PCX2, target the consumer gaming segment but require a 2-D+video chip for those functions rather than having them integrated into a single-chip product.

The huge number of multimedia chip suppliers is too great for the PC market to support, so Dataquest expects further consolidation in the areas of PC graphics and audio. Spring 1998 design-wins will separate winners from losers for those new vendors in the PC graphics arena. Good technology and products are plentiful, so technology is not a good metric for market success. Volume suppliers need access to fab capacity and leading-edge process technology. 3-D graphics acceleration and on-chip memories will drive the gate counts on these chips through the roof at the same time that suppliers need to maintain aggressive price points. Strategic partnerships or fab equity are critical for chip suppliers to succeed in million-plus unit volumes.

### **PC Audio**

PC audio faces several technology shifts, but the two most significant issues are the transition from Industry Standard Architecture (ISA) to Peripheral Component Interconnect (PCI) and the AC-97 style implementation. Demand for higher performance and sophisticated features, such as AC-3 decoding and positional 3-D audio, drives the need for audio to move to the PCI bus. Compatibility with legacy software and the Sound Blaster standard as well as cost issues have prevented this change from occurring. Chip vendors have addressed both issues, and many products coming to market offer advanced features at attractive prices.

Some of these products, such as Cirrus Logic Inc.'s 4610 and Oak Technology Inc.'s TelAudia3D, are essentially programmable Digital Signal Processors (DSPs) tailored for PC audio functions. All of the key PC audio chip vendors have announced PCI-based products or will announce them soon. Other examples include ESS Technology Inc.'s Maestro family and products from Aureal Semiconductor Inc. (formerly MediaVision), VLSI Technology Inc., Creative Labs Inc., and S3.

PC audio products are less gate-intensive than graphics products and, with the growth of AC-97 style codecs, will be less dependent on mixed-signal quality as high-quality codecs become commodity products. Price and features will continue to separate the leaders from the followers in PC audio.

### **Analog Modems**

Today's headlines on the analog modem front focus on 56-Kbps operation. Two technology camps vie for both mind share and market share, led by Rockwell International Corporation and 3Com Corporation (U.S. Robotics Inc.). Rockwell has Lucent Technologies, Motorola Incorporated, Analog Devices Inc., and others on its side. 3Com's list of supporters includes chip-makers Texas Instruments Inc., Cirrus Logic, ESS, and IBM Microelectronics.

Technology trademarks are K56flex for the Rockwell-led group and x2 for the 3Com-led team. The two technologies do not interoperate, so modem buyers run the risk of purchasing the "wrong" technology until the International Telecommunications Union (ITU) standard is finalized. Dataquest expects the ITU will ratify a new standard in the first half of 1998. Modem chipsets from virtually all suppliers promise to be upgradable to the new standard, so modem buyers have little long-term risk of incompatibility. PC OEMs have endorsed 56K modems wholeheartedly but are divided between the K56flex and x2 technologies. Compaq, the IBM PC Company, and Hewlett-Packard Company are shipping K56flex modems in their systems, while Dell Computer Corporation, Gateway 2000 Inc., and Packard Bell Inc. chose x2 modems.

## **Dataquest Perspective**

The market for PC semiconductors will grow dramatically from 1997 through 2000 following meager expectations for growth in 1997. Growth in 2001 will be anemic, driven by steep declines in memory prices because of another cycle of oversupply.

Profits and market share for semiconductor vendors will be more elusive than market growth for the next couple of years. Memory and multimedia chip suppliers face abundant competition, and price erosion is a direct consequence of that competition.

On the memory side, commodity market dynamics rule the roost. Supply will outpace demand until 2000, so margins will stay thin until supply becomes tighter. The multimedia chip market should firm a bit for the fall and winter, but spring 1998 will bring renewed volatility as the flurry of design activity for fall 1998 products determines who has the resources to

stick around. Consolidation during the next 12 to 18 months in the multimedia chip market should lead to less volatility in 1999. Multimedia chip suppliers are encouraged to build solid foundry relationships and—to the extent that they can—sell solutions rather than chips. Suppliers who address the software availability and compatibility issues for their customers will prevail.

---

**For More Information...**

Geoff Ballew, Senior Analyst ..... (408) 468-8676  
Internet address ..... [geoff.ballew@dataquest.com](mailto:geoff.ballew@dataquest.com)  
Via fax..... (408) 954-1780  
Dataquest Interactive ..... <http://www.dataquest.com>

---

The content of this report represents our interpretation and analysis of information generally available to the public or released by responsible individuals in the subject companies, but is not guaranteed as to accuracy or completeness. It does not contain material provided to us in confidence by our clients. Reproduction or disclosure in whole or in part to other parties shall be made upon the written and express consent of Dataquest. ©1997 Dataquest—Reproduction Prohibited

**Dataquest**  
A Gartner Group Company

Dataquest is a registered trademark of A.C. Nielsen Company

Perspective



Consumer Multimedia Semiconductors and Applications  
Worldwide

## Product Analysis

### C-Cube Charts Path to Consumer MPEG-2 Codec Markets

---

**Abstract:** C-Cube Microsystems formally introduced the world's first single-chip MPEG-2 codec on August 25, 1997. The first two products based on C-Cube's DVx architecture are targeted at the professional video equipment segment. While C-Cube has not announced any specific MPEG-2 codec chips for the consumer markets, it has charted a clear course to these markets with the DVx architecture. These high-volume markets hold the promise of rich rewards for the many years of C-Cube's MPEG development and investment.

By Dale Ford and Jonathan Cassell

---

### C-Cube Topples the Single-Chip MPEG-2 Codec Barrier

On August 25, 1997, C-Cube Microsystems formally introduced the world's first single-chip MPEG-2 codec, a product that promises to transform the digital video compression market from a high-end professional niche into a high-volume consumer bonanza. The chip, dubbed the DVx, is capable of simultaneous, real-time compression and decompression of MPEG-2 video in both consumer and professional profiles. Currently, to perform MPEG-2 video compression, a chipset consisting of three or more devices and priced at more than \$1,000 is required. By integrating the functions of several chips onto a single die, C-Cube has sent MPEG-2 compression on a ride down the semiconductor learning curve, resulting in rapid expected price declines. By 1999, Dataquest expects pricing for DVx derivatives to fall into the \$50 range, allowing them to be used in consumer electronics products.

A single DVx chip can both compress and decompress MPEG-2 video at up to 720 x 512 resolution at 30 frames per second for NTSC (720 x 604 at 25 frames per second for PAL) with the 4:2:2 profile and a data bandwidth ranging from 2 to 50 megabits per second (Mbps).

---

#### Dataquest

**Program:** Consumer Multimedia Semiconductors and Applications Worldwide

**Product Code:** MSAM-WW-DP-9710

**Publication Date:** September 8, 1997

**Filing:** Perspective

(For Cross-Technology, file in Semiconductor Application Markets binder)

FILE COPY:

MARIA VALENZUELA



It also can decompress video at resolutions up to 1280 x 720 progressive at 24 frames per second, suitable for lower-level, high-definition digital television. While a single DVx packs plenty of compression horsepower, multiple DVx chips can be linked together to deal with the really demanding jobs. Each DVx comes with an integrated, 80 megabytes per second (MB/sec) interface for linking with other DVx chips. Using eight to 10 DVx chips, MPEG-2 video can be encoded in 1080 interlaced at 24 frames per second, suitable for high-definition digital television.

The first derivative of the DVx line, the DVxpert 5110, is targeted at the broadcast encoding market, with support for standard Main Level@Main Profile video compression. The second member of the line, the DVxpert 6210, is a higher-end codec designed for professional encoding, with support for both main profile and professional profile encoding at data rates ranging from 6 to 50 Mbps.

C-Cube said initial pricing for the DVxpert products will be \$1,500 in 1,000 unit quantities. DVxpert chips are sampling now, with volume production scheduled to begin in the fourth quarter of 1997.

Table 1 lists the DVx architecture's specifications and features.

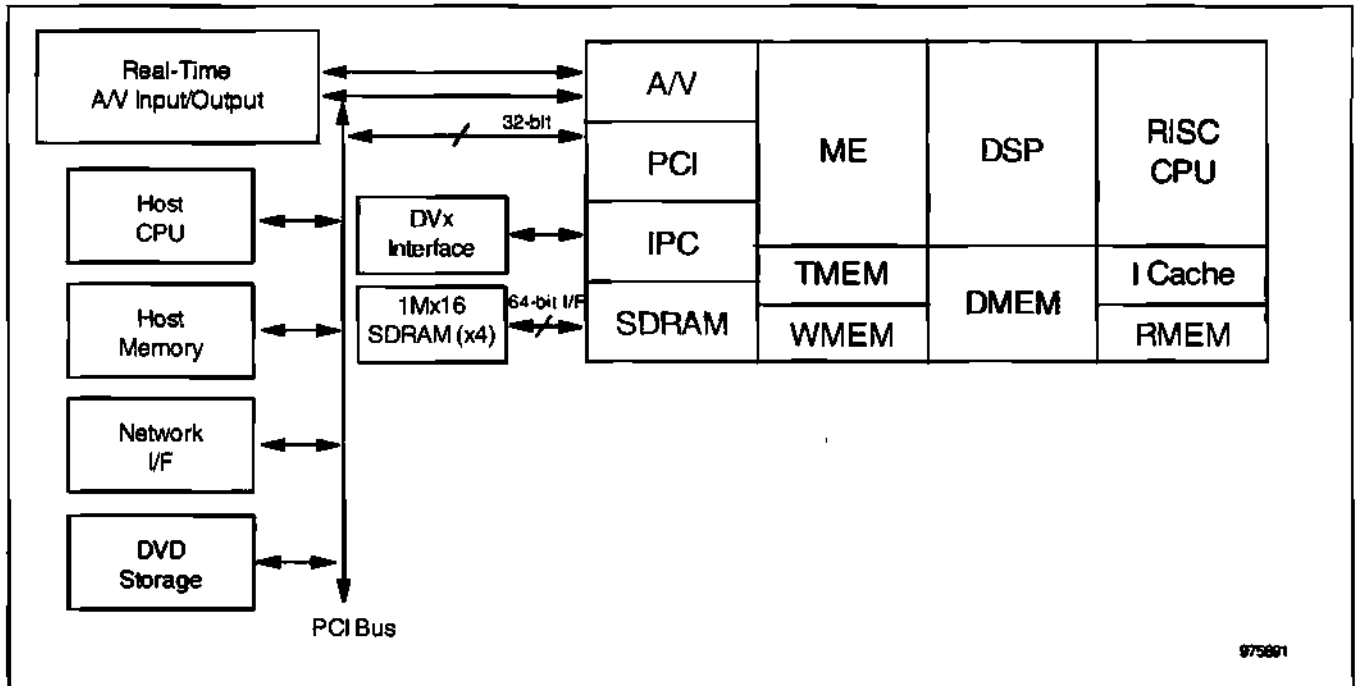
DVx is built around a version of Sun's microSPARC, 32-bit RISC microcontroller. The microSPARC in DVx packs more than 80 MIPS of horsepower and includes instructions optimized for video compression and decompression, allowing it to both assist in codec functions as well as perform system management tasks. However, the real processing work of video compression and decompression is handled by an on-chip DSP and motion estimation unit, which together offer performance of 20 billion operations per second (BOPS). Figure 1 presents a block diagram of the DVx architecture. While the focus of DVx is on video compression and decompression, the chip is far more than just a codec. DVx is virtually a complete system on a chip, with video special effects, on-screen display and graphics capabilities, including full x and y image scaling. For easy integration into PC-based encoding and editing systems, the DVx includes an on-chip PCI interface.

**Table 1**  
**DVx Architecture Specification and Features**

Feature	Specification
Transistors	5.5 million
Process Technology	0.35-micron, 4-layer metal CMOS
Packaging	352-Pin BGA
Power	3.5-4.0W (less than 2W at 2.2V)
DSP	64-bit programmable, 1.6 BOPS
Microcontroller	32-bit RISC microSPARC
CPU Frequency	100 MHz
Memory Requirement	8MB SDRAM for encoding and decoding

Source: C-Cube

**Figure 1**  
**DVx Architecture**



Source: C-Cube

While the hardware of DVx is impressive, most of the value of the product is in its software. Because it is based on a powerful microcontroller and programmable DSP, the DVx's capability can be tailored to specific applications simply by altering its microcode. The first two DVx products are physically identical but use separate code.

C-Cube also will offer versions of the DVx family with different peripheral functions on board to make them suitable for various markets. The company plans to introduce a consumer-oriented version of the DVx that omits the high-speed chip-to-chip and PCI interfaces to reduce costs. Also in the works are DVx chips with integrated AC-3 audio encoding and decoding functions.

## The Application Market Road Map

As shown in Figure 2, C-Cube plans initially to target the DVx at the high-end professional market and then gradually extend its reach into the "prosumer" and consumer areas. This way C-Cube can start by charging relatively higher prices for the DVx to recoup its developing costs and later cut prices to appeal to a wider market. In 1997 and 1998, the DVx will be targeted at the professional and prosumer encoding markets that C-Cube serves now with its VideoRISC line. In 1998 and 1999, the reach of DVx chips will extend into the higher-volume markets of PC multimedia, recordable DVDs, and digital VCRs, with other applications such as MPEG-2 camcorders making their debut in 2000.

**Figure 2**  
**C-Cube's DVx Road Map**

Professional	Digital TV	Post-Production	HDTV	
Prosumer	Digital Media (DVD)	Video Editing DVD-RAM	Video Communication	
Consumer		PC-Multimedia (DVD)	Recordable DVD Digital VCRs	MPEG2 Camcorders
	1997	1998	1999	2000

975802

Source: C-Cube

### Professional Applications

While C-Cube already is the leading player in the professional market for MPEG-2 encoding chips, the DVx architecture gives the company an opportunity to significantly expand its presence there. In multichip configurations, the DVx is capable of encoding video in the highest resolution digital TV, high-definition TV (DTV HDTV) formats, enabling it to be used to create content for the high-definition broadcasts expected to begin in late 1998. But beyond expanding C-Cube's sales in its existing professional applications, the DVx will allow C-Cube to bring its technologies into areas beyond broadcast encoding. DVx can also be used in capturing content in the digital MPEG-2 format, an area where analog equipment is used now.

### Prosumer Applications

Moving beyond the profession segment, prosumer products offer the next market opportunity for MPEG-2 codecs.

#### DVD-RAM Video Editing and PC-Based Media Editing

By enabling lower-cost DVD video editing platforms, C-Cube will open up the gates for significant new levels of digital video software/content creation. While the current emphasis in the DVD industry is on the availability of titles from the major Hollywood movie houses, linear-play movies represent only the beginning of the DVD potential. The number of interactive gaming titles and video content from other sources is severely limited by the production costs. Most titles that will be available in 1997 and early 1998 have had their production costs underwritten by major DVD development companies such as Toshiba and Matsushita.

By helping to enable the entrance of additional software suppliers to the market, C-Cube's technology will help generate the pull for consumer DVD products that is necessary for the success of this technology.

### **Video Communication**

A key market for the DVx product family will be video communications in corporate intranets. Straddling the professional and consumer markets, corporate intranets promise both good volume and good prices for DVx chips. As corporate intranets move toward faster network technology, such as 100-Mb Fast Ethernet, C-Cube anticipates that demand will grow for higher-quality video conferencing. MPEG-2 could serve such a role, particularly because the ITU's H.262 video conferencing specification specifies use of that video compression technology. DVx is particularly suited for this market, given its simultaneous coding/decoding capability and its adjustable frame rates.

### **Consumer Applications**

Although C-Cube has not announced any specific MPEG-2 codec chips for the consumer markets, it has charted a clear course to these markets with the DVx architecture. These high-volume markets promise rich rewards for the many years of C-Cube's MPEG development and investment.

### **PC Multimedia**

Because of the costs and difficulties associated with content creation in MPEG formats, most of this development has been done in non-MPEG environments such as Motion JPEG. The new DVx architecture will make MPEG-2 editing feasible for the first time by providing frame-accurate MPEG encode and decode functions in a single, cost-effective package. This will provide significant advantages in allowing the capture, transcoding, editing, and display of video in a single standardized MPEG-2 format. Additional significant savings are also realized with the storage savings enabled by the DVx MPEG-2 solution. C-Cube claims that its solution will enable an MPEG-2 4:2:2 bit-rate of 6 to 18 Mbps compared to the typical 30 to 50 Mbps output of Motion JPEG.

### **DVD Video Recorders and Digital VCRs**

In publishing its forecast for DVD video recorders a year ago, Dataquest predicted that the consumer market for DVD video recorders would commence in 1999. At that time it was noted that the MPEG-2 encoders/codec chips that would be necessary in this product had price tags of more than \$1,000. The prerequisite for consumer DVD video players was the development of an MPEG-2 codec that would make a major leap in price/performance and approach \$50 in cost. C-Cube is confidently charting a course that would make this product a reality. Dataquest predicts that the volume opportunity for MPEG-2 chip shipments in this market will hit 1.6 million units in 1999 and quickly grow to 8.1 million units by 2001. However, it is important to emphasize that the development of the DVD video recorder market is dependent on more than enabling technologies such as MPEG-2 codecs. Other necessary supporting elements such as copy protection, supporting infrastructure, and standards agreements must also

be established. While the current DVx solution requires 8MB of SDRAM, C-Cube is continuing to work on solutions that would use less memory. However, with the steep price decline in DRAM, this will not be as critical an issue in 1999 as it was in 1996. While an MPEG-2 codec could be used in a digital VCR, Dataquest does not expect these products to move beyond the professional studio environment.

### **Digital Camcorders**

The current generation of digital camcorders based on the DV standard has moved into high volume with production expected to pass 1.7 million units in 1997. These digital camcorders, sporting expensive price tags, have found their early acceptance in the Japanese consumer markets. Substantial cost reductions are forecast to enable the development of Americas and European markets for digital camcorders in 1999 and 2000. While MPEG-2 has always been on the road map for DV standard products, the key question has been when this goal would be reached. Hitachi demonstrated an MPEG-1 based digital camcorder in early 1997; however, the picture quality of MPEG-1 is not expected to drive a major consumer market.

An MPEG-2 codec with the right combination of price, performance, and power consumption would find a high-volume market already waiting with production of more than 6 million digital camcorders forecast for 2000. The combination of MPEG-2 technology and optical recording solutions would be a powerful combination in a digital camcorder. A digital camcorder with optical media would be the last major element in a formula that will accelerate the move of the consumer markets from tape-based, analog products to optical-based, digital products.

### **DTV**

DVx also can be used as a decoder for DTV applications. With a capability to decompress video in the 1280 x 720 resolution at 30 frames per second, the DVx fits into the U.S. ATSC specification for midlevel DTV HDTV that is expected to be adopted by most consumer electronics manufacturers. This falls short of the highest resolution picture specified by the ATSC, but it does comply with all the DTV formats proposed by the personal computer industry. When DTV broadcasts begin in 1998 to 1999, C-Cube is likely to introduce a version of the DVx targeted at the DTV market with modified firmware and a set of peripherals designed for consumer applications.

### **Digital Set-top Boxes**

In the outlying portions of C-Cube's applications road map—in the year 2000 and later—the company envisions DVx derivatives will be at the heart of a new generation of digital set-top boxes. Such boxes would be able to perform both MPEG-2 compression and decompression, making them suitable for two-way communications up and down the pipe, as well as DVD encoding and decoding. Many consumer electronics companies believe that the set-top box is the most likely platform to serve as the centerpiece of digital electronics products in the future. An encoding/decoding capability would be vital to make the set-top box fill such a role. Dataquest believes that a market for such boxes will appear around the year 2000, further expanding the market for DVx and similar devices.

## Dataquest Perspective

The importance of C-Cube's announcement of the DVx architecture and its potential cannot be understated. The development of MPEG-2 encode and codec products that would break down the barriers for applications in next-generation consumer electronics products has been the center of much speculation. The 1997 IEEE International Solid-State Circuits Conference (ISSCC) saw a number of papers presented that discussed the technologies and challenges associated with the development of MPEG-2 codecs. Some companies have speculated that consumer products employing MPEG-2 codec technology would not reach the market for at least five years. Continuing in its pioneering role in MPEG technologies, C-Cube has now demonstrated working silicon and software that open the gates to next-generation consumer electronics markets that will drive a renaissance in the consumer electronics industry.

Being the first to market with their MPEG-2 codec technology holds both rewards and risks for C-Cube. With the DVx technology in place, C-Cube can pursue design wins with key product manufacturers and work to establish an early competitive position in the expanding MPEG-2 markets. It is anticipated that there will be other entrants to this market, with the list of likely competitors coming from other companies with strong MPEG-2 technologies, such as LSI Logic, IBM, and SGS Thomson. The intellectual property and technological challenges of developing MPEG-2 encoding technology raise significant barriers to entry to this market and should limit the number of competitors in the near term. Now that C-Cube has announced its products and architectures, it remains to be seen who will join the competition—and how quickly.

While C-Cube has demonstrated its ability to deliver high-quality, competitive products, there are some key factors that are beyond its control that will determine the rewards it will reap from its investments. The timing and development of high-volume consumer markets will be a major variable in calculating the returns that C-Cube can generate from their MPEG-2 codec chips. In calculation of the net present value (NPV) of the potential revenue that can be generated by DVx products, the timing of the market introduction and growth of products such as DVD video recorders significantly influences the value assigned to C-Cube's announcement by the financial community. If the target application markets are delayed significantly, the benefits to C-Cube as a market leader are discounted at an increasing level as competitive pressures increase. One example of this type of risk can be seen in Zoran's inability to completely capitalize on its early lead in AC-3 (Dolby Digital) technology when the DVD market experienced extended delays. However, if the markets for next-generation consumer electronics products develop according to Dataquest's current forecasts, C-Cube should reap the rewards that its many years of investment merit.

---

**For More Information...**

Dale Ford, Senior Industry Analyst .....(408) 468-8311

Internet address .....dale.ford@dataquest.com

Via fax .....(408) 954-1780

Dataquest Interactive .....<http://www.dataquest.com>

The content of this report represents our interpretation and analysis of information generally available to the public or released by responsible individuals in the subject companies, but is not guaranteed as to accuracy or completeness. It does not contain material provided to us in confidence by our clients. Reproduction or disclosure in whole or in part to other parties shall be made upon the written and express consent of Dataquest.

©1997 Dataquest—Reproduction Prohibited

Dataquest is a registered trademark of A.C. Nielsen Company

Perspective



## Consumer Multimedia Semiconductors and Applications Worldwide Competitive Analysis

### Consumer Electronics Chip Competition: The Game Moves to the Next Level

---

**Abstract:** *This fax Perspective summarizes data presented in two recent reports issued by Dataquest's Consumer Multimedia Semiconductors and Applications Worldwide: "MPUs and MCUs Battle for the Hearts of Next-Generation Consumer Products" (MSAM-WW-CT-9701) and "1996 Consumer Electronics Semiconductor Market Share" (MSAM-WW-CT-9702). Both reports address trends in the consumer electronics semiconductor business. Rankings for 1996 of top vendors of all semiconductors for consumer electronics, MPEG and AC-3 decompression chips, ICs used in next-generation consumer products, and MPUs and MCUs used in next-generation consumer electronics products are provided.*

*By Dale Ford and Jonathan Cassell*

---

### 1996 Consumer Electronic Semiconductor Vendor Ranking

The 1996 semiconductor market for consumer electronics reflected the woes of the overall semiconductor market, shrinking by more than 4 percent from 1995, as shown in Table 1. Within this arena there was some significant shuffling among the ranks of the leaders as fortunes rose and fell. Suppliers of memory to the consumer electronics market suffered major losses because of the steep decline in memory prices and the relative nonelasticity of the memory market in consumer electronics. Suppliers of semiconductors to legacy consumer electronics products also were dealt major setbacks. The core legacy consumer electronics market experienced its first contraction in over 10 years in 1996. The companies that were most successful in either growing their markets or avoiding losses were typically those companies that have experienced the most success in the emerging next-generation consumer electronics market.

---

#### Dataquest

**Program:** Consumer Multimedia Semiconductors and Applications Worldwide

**Product Code:** MSAM-WW-DP-9709

**Publication Date:** September 1, 1997

**Filing:** Perspective

(For Cross-Technology, file in the Semiconductor Application Markets binder)

FILE COPY:  
MARIA VALENZUELA



**Table 1**  
**Top 10 Vendors of Semiconductors for Use in Consumer Electronics, Worldwide Revenue**

1996 Rank	1995 Rank	Company	1996 Revenue (U.S.\$M)	1995-1996 Growth (%)	1996 Market Share (%)
1	2	NEC	2,685	-0.9	11.9
2	1	Toshiba	2,663	-13.0	11.8
3	4	Philips	1,865	1.0	8.2
4	6	Hitachi	1,762	9.9	7.8
5	3	Matsushita	1,619	-15.0	7.1
6	5	SANYO	1,520	-5.8	6.7
7	9	Sony	1,215	-3.7	5.4
8	7	Mitsubishi	1,211	-15.4	5.3
9	8	Sharp	1,103	-17.8	4.9
10	10	Motorola	886	-8.1	3.9
-	-	All Others	6,110	-3.4	27.0
-	-	Total Market	22,639	-4.2	100.0

Source: Dataquest (July 1997)

## MPEG and AC-3 Decompression ICs

The primary market for MPEG-1 video decompression ICs was in video CD players, with the remainder used in personal computers. For MPEG-2 video decompression semiconductors, the highest volume market in 1996 was direct broadcast satellite (DBS) set-top boxes, with digital versatile disc (DVD) players and digital cable set-top boxes accounting for the remainder of sales. AC-3 decoders in 1996 were used mainly in home theater audio systems and DVD players. Table 2 presents a ranking of vendors of MPEG and AC-3 decompression chips.

**Table 2**  
**Top Five Vendors of MPEG and AC-3 Decoder ICs, Worldwide Revenue**

1996 Rank	Company	1996 Revenue (U.S.\$M)	1995-1996 Growth (%)	1996 Market Share (%)
1	C-Cube	255	218.8	48.5
2	SGS-Thomson	134	11.6	25.5
3	LSI Logic	60	1,400.0	11.4
4	Motorola	46	142.1	8.7
5	ESS Technology	17	NA	3.2
-	All Others	14	-29.0	2.7
-	Total Market	526	94.1	100.0

NA = Not available

Source: Dataquest (July 1997)

## Next-Generation Consumer Electronics Applications

Table 3 presents a ranking of semiconductor companies supplying chips into next-generation consumer electronics products, which consist of DBS set-top boxes, digital cable set-top boxes, 32-/64-bit video game controllers, video CD players, digital still cameras, digital camcorders, DVD video players, and other devices (mainly the WebTV box). Because of the tremendous high-growth opportunity the next-generation consumer electronics market represents, semiconductor companies are aggressively entering and competing in it. The 32-/64-bit video game controller is a major driver of the early market share success for chips. However, most of the companies in the top 10 are competing in multiple market segments. The companies that are most successful in leveraging their products into multiple segments will be in the best position for the future.

**Table 3**  
**Top 10 Vendors of ICs for Use in Next-Generation Consumer Electronics, Worldwide Revenue**

1996 Rank	Company	1996 Revenue (U.S.\$M)	1996 Market Share (%)
1	Sony	420	14.9
2	LSI Logic	354	12.6
3	Hitachi	333	11.8
4	NEC	270	9.6
5	C-Cube	246	8.7
6	SGS-Thomson	189	6.7
7	Motorola	155	5.5
8	Toshiba	90	3.2
9	Philips	89	3.2
10	VLSI Technology	60	2.1
-	All Others	611	21.7
-	<b>Total Market</b>	<b>2,817</b>	<b>100.0</b>

NA = Not available

Note: This revenue excludes memory, discrete components, and optoelectronics. Rank and revenue for 1995 are not available.

Source: Dataquest (July 1997)

## MPU/MCU Market in Next-Generation Consumer Electronics

Because of the success of the Nintendo 64 and Sony PlayStation systems, the MIPS architecture captured nearly 33 percent of the 1996 MPU/MCU chip unit market share in next-generation consumer systems, with almost 17 million chip unit shipments. SH processor shipments followed with over 26 percent market share and 13.7 million chip unit shipments (see Table 4).

**Table 4**  
**Top Five MPU/MCU Architectures Used in Next-Generation Consumer Electronics**  
**(Shipments in Thousands of Units)**

1996 Rank	Architecture	1996 System Shipments	1996 System Market Share (%)	1996 Chip Shipments	1996 Chip Market Share (%)
1	MIPS	12,950	35.1	16,950	32.9
2	SH	4,906	13.3	13,706	26.6
3	68K	2,349	6.4	2,349	4.5
4	SPARC	341	0.0	341	0.7
5	16-Bit	9,873	26.8	11,766	22.8
-	All Others*	6,461	17.52	6,461	12.5
-	<b>Total Market</b>	<b>36,880</b>	<b>100.0</b>	<b>51,573</b>	<b>100.0</b>

\*32-/64-bit and proprietary architectures  
 Source: Dataquest (May 1997)

**For More Information...**

Dale Ford, Senior Industry Analyst.....(408) 468-8311

Internet address.....dale.ford@dataquest.com

Via fax.....(408) 954-1780

Dataquest Interactive.....<http://www.dataquest.com>

The content of this report represents our interpretation and analysis of information generally available to the public or released by responsible individuals in the subject companies, but is not guaranteed as to accuracy or completeness. It does not contain material provided to us in confidence by our clients. Reproduction or disclosure in whole or in part to other parties shall be made upon the written and express consent of Dataquest.  
 ©1997 Dataquest—Reproduction Prohibited  
 Dataquest is a registered trademark of A.C. Nielsen Company

Perspective



**Consumer Multimedia Semiconductors and Applications  
Worldwide**

## **Market Analysis**

### **Consumer Electronics Semiconductor Application Market Quarterly Outlook: First Quarter Blues**

---

**Abstract:** *This Perspective summarizes the worldwide situation for consumer electronics equipment and consumer electronics semiconductors in the first quarter of 1997. Descriptions and analysis of worldwide economic conditions, consumer electronic equipment sales, and company performance are provided, along with an outlook for the remainder of the year.*

*By Jonathan Cassell*

---

#### **First Quarter Market Status: Slow Start Belies Eventual Recovery**

##### **First Quarter Blues**

The first quarter is perennially the time of the year when the worldwide consumer electronics industry sails into the doldrums. Consumers, who are still feeling light in the wallet from their holiday purchases, make few major electronics buys in the first quarter—at least until they have paid off their first credit card bill. For manufacturers, the first quarter represents the low point of the year for sales and production of all major consumer electronics products, including audio, video, and personal electronics. Thus, events in the first quarter rarely present an accurate picture of what the year as a whole will look like, particularly the all-important holiday shopping season that is still nine to 11 months away.

However, this year's first quarter foreshadows that 1997 will bring a return to healthy growth after a dismal 1996. One sign is a robust economy in most of the world's major regions. Another indication is the continued consumer

---

##### **Dataquest**

**Program:** Consumer Multimedia Semiconductors and Applications Worldwide

**Product Code:** MSAM-WW-DP-9708

**Publication Date:** June 23, 1997

**Filing:** Perspective

(For Cross-Technology, file in the Semiconductor Application Markets binder)

FILE COPY:  
MARIA VALENZUELA

interest in new digital consumer products, including satellite television receivers, video CD players, and 32- and 64-bit video game consoles.

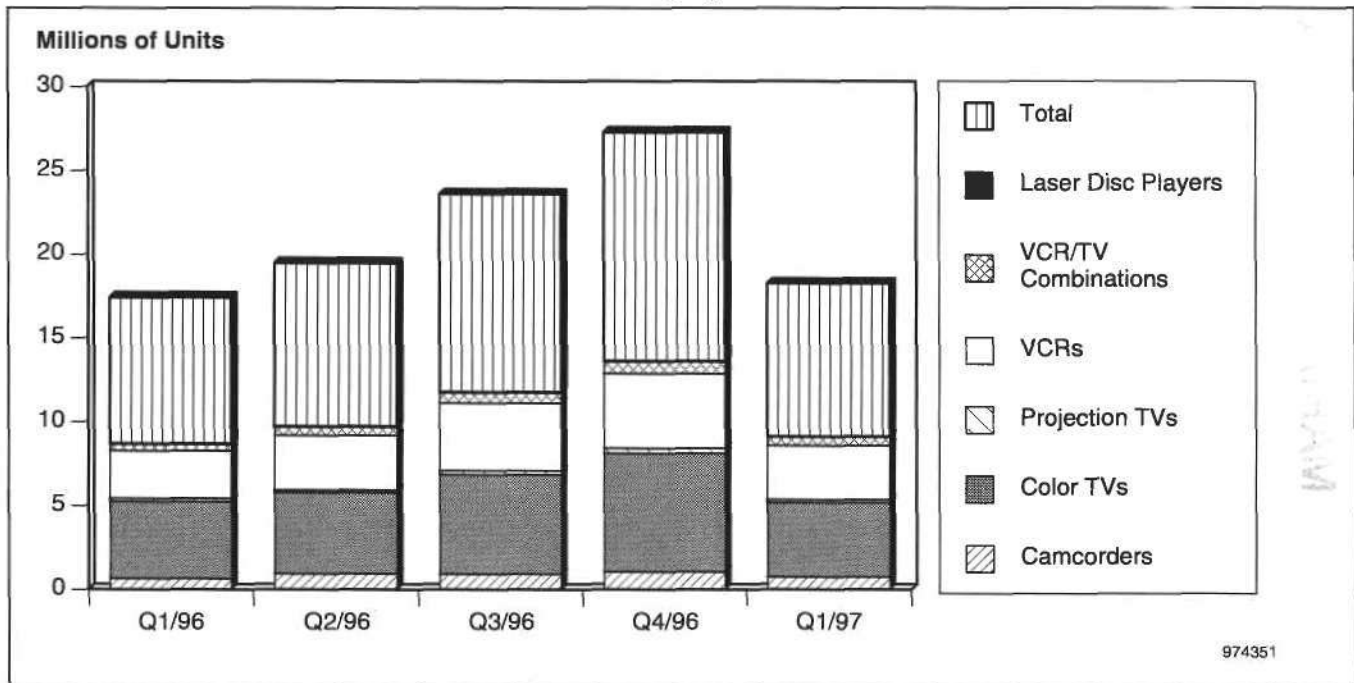
But the most encouraging sign is the strong acceptance of digital versatile disc (DVD), an exciting technology that will serve as the new engine of growth for the consumer market in 1997 and beyond. Despite these positive signs, the consumer electronics industry in some regions still is wrestling with slow sales growth in key traditional product areas such as color televisions.

**The United States**

The first quarter was great for the U.S. economy and U.S. consumers. The U.S. gross domestic product (GDP) reached 5.8 percent in the first quarter, the fastest growth rate in nearly 10 years, according to the U.S. Department of Commerce. Unemployment in the first quarter fell to just 5.3 percent in the first quarter and was moving toward its lowest level in a generation. All this good economic news translated into unbridled optimism among the American public as consumer confidence levels flirted with record highs. In February, the Conference Board's Present Situation Index rose to 143.4, a 27-year high.

The question is, did all that good economic news and optimism translate into increased sales of consumer electronics goods in the United States? The answer is yes and no. As shown in Figure 1, sales to dealers of traditional video product types grew by nearly 5 percent on a unit basis compared to the first quarter of 1996—a respectable rise.

**Figure 1**  
**U.S. Sales of Consumer Electronics Video Equipment to Dealers (Millions of Units)**



NA = Not Applicable  
 Source: Consumer Electronics Manufacturers Association (CEMA)

Much of the increase came from strong sales of TV/VCR combinations (up 34.6 percent) and camcorders (up 12.7 percent). Other categories showed a decline, with televisions and projection television falling 3.3 percent and 2.6 percent, respectively. The biggest drop in sales on a percentage basis was for laser disc players, which fell 53.8 percent. Meanwhile, DVD sales began what is expected to be a rapid ramp up to high volume with unit sales to dealers reaching 22,000 in the first quarter, according to Dataquest.

But while video sales were on the rise, audio sales in the first quarter slipped 2 percent from the first quarter of 1996 to \$1.58 billion. The fall was provoked by declining sales of portable audio and stereo components, which fell 8 percent to \$408 million and 16 percent, respectively, compared to the first quarter of 1996. However, sales of stereo systems and auto sound equipment grew 15 percent to reach about \$362 million, and auto sound rose 4 percent to hit more than \$445 million.

### **Europe**

In Europe, the economic scene is far less rosy. Economic conditions remain difficult for most Western European countries. To meet European Monetary Union requirements, European countries have imposed austerity programs that restrict growth and keep unemployment at historically high levels. Germany, France, and Italy all suffered economic slowdowns over the winter, contributing to an atmosphere of caution among consumers. As a result, first quarter sales growth of consumer products in Europe ranged from flat to mild.

A bright spot in the European market is the home theater/Dolby surround-sound market. Manufacturers are heavily promoting wide screen high-end TVs with surround sound. Despite strong sales in home theater, interest in home theater-oriented 16:9 aspect ratio televisions has tapered off after a strong start.

### **Japan**

Japan's economy appeared to gain steam in the first quarter. Industrial output moved upward, rising 2.1 percent from the previous quarter. The dramatic depreciation of the yen through the first quarter boosted exports, improving the business climate in Japan. Inspired by growing business confidence, consumer spending has begun to show signs of renewed vigor. Consumer spending in March was higher in advance of an increase in the consumption tax in April. In March, sales at Japan's large retailers jumped 14.1 percent from the year-ago quarter to ¥2.271 trillion (U.S.\$19 billion), according to the Ministry of International Trade and Industry (MITI). Sales at department store posted the first increase in five months in March, rising 21.1 percent to ¥1.1816 trillion (U.S.\$9.9 billion), MITI said.

Among Japanese consumers, the biggest electronics craze in the first quarter was the Tamagotchi, a "virtual pet" that fits on a key chain. Beyond the Tamagotchi popular products include digital satellite television and digital still cameras.

### **Asia/Pacific**

In Asia/Pacific, the major economies appear to be slowing somewhat from the fast pace of growth in recent years. China's GDP reached 1.4686 trillion yuan during the first quarter of this year, representing a year-on-year increase of 9.4 percent in real terms, according to the State Statistics Bureau. While impressive, that growth margin is 0.8 percent lower than in the same period of the previous year.

In China, sales of video CD players continue to boom because of declining prices of titles. While video CD extends its amazing sales gains, DVD is beginning to make its entry into the Asia/Pacific region. As Chinese consumers upgrade their television sets from 20-to-24-inch models to 28-inch models, there is a desire to take advantage of the higher picture quality that DVD offers. Along with video CD, video game console sales also are growing at a fast rate. Consumer electronics sales growth is expected to be stable in Asia/Pacific in the second quarter.

### **What Does the First Quarter Indicate?**

With the world economies strong, for the most part, and consumer spending solid, the road to a great 1997 appears to be clear. The biggest beneficiaries of this potential bonanza will be sellers of next-generation, digital consumer products, including DVD players, video CD players, digital still cameras, digital cable and digital satellite boxes, and 32- and 64-bit video games.

Volume DVD shipments started with a bang in the first quarter. Prices in the first quarter already fell into the \$500-or-less range, making them affordable for a wider range of consumers. More and more DVD titles appeared in stores, generating more appeal to consumers. These trends will continue throughout 1997 in all major regions of the world. By the end of the year—after the crucial holiday shopping season—Dataquest expects 1.5 million DVD players to be produced.

Despite these hopeful signs, consumer electronics manufacturers in some regions are concerned about a lack of growth in key traditional product segments. Dataquest expects (to a degree) flat or minimal growth in product areas such as color TVs in regions like the United States, where product penetration approaches 100 percent and every house has several TV sets.

However, another factor retarding sales growth in some regions is concern among consumers that any analog product they buy now will quickly be outdated with the advent of new digital replacements. Television manufacturers in the United States are already feeling the effects of consumer concern about the transition to digital television (DTV). To counter this effect, consumer electronics manufacturers should try to inform consumers that the advent of digital technology doesn't necessarily mean the obsolescence of their analog equipment. Some manufacturers have taken this lesson to heart. Sony, for example, has dedicated a page of its Web site to telling consumers that the advent of digital television doesn't mean their analog televisions will instantly become useless.

## Industry Participant Update:

Table 1 presents results for consumer semiconductor, equipment, and combination semiconductor and equipment vendors. Semiconductor sellers are defined as companies that derive a significant amount of their revenue from sales of chips into the consumer market (more than 10 percent of revenue) but that do not sell a significant amount of consumer electronics equipment.

**Table 1**  
**First Quarter Results for Key Consumer Electronic Market Equipment Producers and Chip Purveyors**

Company	Revenue Q1/97 (U.S.\$) <sup>2</sup>	Revenue Q1/96 (U.S.\$) <sup>1</sup>	Revenue Change Q1/97 over Q1/96 (%) <sup>3</sup>	Gross Margin Change Q1/97 over Q4/96 (%) <sup>4</sup>	Inventory Days Q1/97 <sup>5</sup>	Inventory Days Q4/96 <sup>6</sup>
<b>Chip Sellers</b>						
C-Cube Microsystems	94,132	68,100	38.23	0.46	43	60.1
ESS Technology	81,468	41,188	97.80	-2.04	74	79.0
SGS Thomson Microelectronics	940,500	1,019,100	-7.71	-1.65	80	75.7
Texas Instruments	2,263,000	3,076,000	-26.43	19.62	39	30.4
LSI Logic	308,388	311,352	-0.95	1.99	4	48.8
Motorola	6,642,000	6,955,000	-15.75	NA	NA	NA
Zoran	6,316	6,605	-4.38	2.08	27	27.1
<b>Equipment Sellers</b>						
Nintendo*	NA	2,123,218	NA	NA	NA	15.5
General Instrument	641,271	615,762	4.14	28.10	NA	50.8
Scientific Atlanta	301,700	271,883	10.97	1.03	NA	81.6
Philips Electronics*	20,149,584	0	NA	-0.68	NA	154.2
Samsung Electronics*	7,726,453	11,868,787	-34.90	NA	NA	NA
NEC*	NA	28,209,500	NA	NA	NA	57.5
Sony	12,311,838	12,022,750	2.40	NA	NA	NA
Pace Micro Technology*	641,520	597,172	7.43	NA	NA	NA
Zenith Electronics	259,000	237,400	9.10	4.86	NA	NA
<b>Equipment/Chip Sellers</b>						
Sanyo Electric*	NA	NA	NA	NA	NA	78.7
LG Electronics*	9,002,942	8,567,000	5.09	NA	19	16.6
Sharp*	8,974,984	9,360,825	-4.12	NA	NA	24.2

NA = Not applicable

<sup>1</sup>Or H2/95

<sup>2</sup>Or H2/96

<sup>3</sup>Or H2/96 over H2/95

<sup>4</sup>Or H2/96 over H1/96

<sup>5</sup>Or H2/96

<sup>6</sup>Or H1/96

\*Companies report according to the Japanese fiscal calendar

Source: Dataquest (June 1997)



As Table 1 shows, one of the biggest success stories in the consumer semiconductor market in the first quarter was ESS Technology Inc., which saw its revenue rise by 97.8 percent. Much of that growth is attributable to ESS' aggressive price-cutting in the market for MPEG-1 decoders used in video CD players. ESS' price cuts put the squeeze on C-Cube Microsystems, which previously had virtually monopolized the video CD market. Despite that, C-Cube still managed nearly 40 percent growth in the first quarter's tougher business climate.

The biggest loser among the chipmakers in the first quarter was Texas Instruments (TI). The company suffered from declining DRAM prices, with its falling revenue failing to offset rising revenue from sales of digital signal processing (DSP)-related products into the consumer and communications markets.

Consumer electronic equipment sellers are defined as companies that sell consumer electronics equipment and that derive less than 10 percent of their revenue from consumer semiconductor sales. Among equipment makers, Scientific Atlanta stands out with 10.97 percent growth. The company attributed its strong performance in part to continuing acceptance of its advanced analog terminals into the cable market. Samsung saw its revenue fall 34.9 percent in the second half the 1996 Japanese fiscal year, in part because of memory chip price erosion and in part because of the declining value of the Korean won compared to the dollar.

Companies that sell both consumer electronics equipment and chips are defined as those companies that derive more than 10 percent of their revenue from sales of consumer electronics chips and that sell a significant amount of consumer electronics equipment. Among those companies, LG Electronics saw a 5 percent rise in revenues, while Sharp experienced a 4 percent drop.

## **Notable Industry Developments and Product and Technology Introductions**

The first quarter saw the announcement of two major acquisitions that would later collapse. Sega Enterprises in January agreed to acquire Bandai in a transaction valued at ¥129 billion (U.S.\$1.09 billion) in Sega stock. Executives outlined ambitious plans for the combined company, to be called Sega Bandai, involving computer games, virtual reality, computer graphics, character merchandising, movies, music, computer networks, satellite communications, and other information technologies. However, the deal was scuttled in May.

The second deal to go awry was News Corporation's bid to buy a 50 percent stake in EchoStar in order to establish an immediate presence in the North American digital satellite television market. The deal appeared to be made in heaven, with the two firms having a great deal of synergy between them on the technological, tactical, and strategic levels. However, by the second quarter, the heavenly match had gone to hell in a bucket, as legal challenges mounted and technical issues reared their heads, causing News to back

away from the deal. Finally, in May, EchoStar filed a \$5 billion lawsuit against News Corporation for breach of contract.

At the Western Cable Show in January, cable multiple service operators (MSOs), including Time Warner and Tele-Communications Inc. (TCI), arrived at the show with orders for digital cable set-top boxes that together will equal as many as 4 million units over the next several years. After years of delay, cable MSOs finally began to roll out digital cable service, primarily in reaction to competitive threats from digital satellite television.

February's Photo Marketing Association (PMA) trade show saw the introduction of a new wave of digital still cameras that use removable flash memory cards as their sole means of storing pictures. Introductions at the PMA show indicated most manufacturers are opting to use the CompactFlash card specification backed by SanDisk.

Another digital still camera development of note was Toshiba's March announcement of a half-inch image sensor that has a resolution of 1.3 million pixels and uses one-tenth the power of conventional charge-coupled devices (CCDs). Such a device could serve to overcome power, resolution, and cost barriers that are limiting the acceptance of digital still cameras among consumers.

Also in March, Nintendo of America sued Taiwanese semiconductor manufacturer Winbond Electronics Corporation for patent infringements contained in counterfeit Nintendo video game products. The suit alleged Nintendo had identified semiconductor chips made by Winbond's fab that were being distributed with counterfeit Nintendo video game software in North America, Europe, Latin America, and Asia. Winbond is the second Taiwan company sued by Nintendo over game counterfeiting in the last year-and-a-half. Taiwan Semiconductor Manufacturing Co., the world's largest dedicated foundry, was sued by Nintendo in March 1996.

In a major milestone in the consumer electronic industry, Japan in March signaled that its effort to establish analog high-definition television (HDTV) as the next generation of video entertainment may be coming to an end. An advisory committee to the Japanese Ministry of Posts and Telecommunications recommended that the BS-4 satellite, set to be launched in the year 2000, use a digital broadcast format rather than the country's MUSE analog HDTV technology as originally planned. Dataquest is predicting this means the eventual demise of MUSE in Japan and the end of an epic undertaking by Japan's consumer electronics industry to control the next-generation of television technology.

Meanwhile, the United States continued to push ahead in digital television in March as the Federal Communications Commission (FCC) issued licenses for DTV broadcast. The FCC action began the countdown for the beginning of DTV service in the United States. DTV broadcasts are expected to commence by November 1, 1998, paving the way for the first sales of DTV television sets during the holiday shopping season.

C-Cube launched its ZiVA DVD product family—including the ZiVA DVD decoder that integrates both audio and video decoding functions—in March. It is the first DVD system decoder with this level of integration to receive Dolby Digital (AC-3) certification. Leading consumer electronics and PC manufacturers, including Toshiba, Samsung, Aiwa, and Diamond Multimedia, have already endorsed C-Cube's ZiVA DVD decoder solution. The ZiVA family accelerates time to market and lowers overall system costs for system manufacturers.

Because of reduced semiconductor costs, in March Nintendo cut the price of its 64-bit game machine by ¥8,200 (U.S.\$68.88) to ¥16,800 (U.S.\$141.12) in Japan. The price cuts came in response to stiff competition from Sony and Sega, which respectively sell the 32-bit PlayStation and Sega Saturn machines for ¥19,800 (U.S.\$166.32) and ¥20,000 (U.S.\$168). Total shipments of the Nintendo 64 since its debut in June last year were expected to reach 6 million units by mid-March. Nintendo said it planned to increase production of the machine from the monthly 700,000 units in March to 800,000 in April and to 1 million in May because of strong demand in the United States and Europe.

## The Outlook

Dataquest predicts that 1997 will be a bounce-back year for the worldwide consumer electronics market. Worldwide consumer electronics equipment production revenue is expected to rise 6.4 percent to \$182.1 billion in 1997. This is welcome news to a consumer electronics industry that saw production rise only 3.4 percent in 1996 and experienced flat or declining sales in major product segments like color television. However, the biggest opportunities for growth lie in next-generation digital consumer products. DVD will be the star of the show, particularly in major industrialized regions like the United States and Japan, with production and sales growing rapidly as the year progresses.

*Dataquest Analysts Dale Ford, Kun Soo Lee, Ben Lee, and Paul O'Donovan contributed to this report.*

### For More Information...

Jonathan Cassell, Industry Analyst..... (408) 468-8195

Internet address ..... [jonathan.cassell@dataquest.com](mailto:jonathan.cassell@dataquest.com)

Via fax..... (408) 954-1780

Dataquest Interactive ..... <http://www.dataquest.com>

The content of this report represents our interpretation and analysis of information generally available to the public or released by responsible individuals in the subject companies, but is not guaranteed as to accuracy or completeness. It does not contain material provided to us in confidence by our clients. Reproduction or disclosure in whole or in part to other parties shall be made upon the written and express consent of Dataquest.

©1997 Dataquest—Reproduction Prohibited

Dataquest is a registered trademark of A.C. Nielsen Company

Perspective



## Consumer Multimedia Semiconductors and Applications Worldwide Market Analysis

### Flash Memory Digital Film Standards Battle Heats Up

---

**Abstract:** *The flash memory industry is struggling to decide which of three competing standards will be used for the emerging "digital film" market. This Perspective discusses the merits and motivations of each and the market size for the winner.*  
*By Bruce Bonner and Jonathan Cassell*

---

#### The Players

A full-blown standards war is now in progress in the flash memory market. The three camps all are well-armed, strong, and motivated to win and have a "take no prisoners" attitude. The three groups and their leaders are:

- CompactFlash—SanDisk
- Miniature Card—Intel, Advanced Micro Devices, Fujitsu, and Sharp
- Solid-State Floppy Disk Card (SSFDC)—Toshiba and Samsung

Each of these standards is backed with a trade association, and all have shipped product to prime the market.

#### The Products

The three products are very different, with totally different design philosophies guiding each one.

##### **CompactFlash**

The CompactFlash card is a solid-state disk drive, and its sponsor is SanDisk Corporation, which was founded in 1988 with a product like this in mind.

---

##### **Dataquest**

**Program:** Consumer Multimedia Semiconductors and Applications Worldwide

**Product Code:** MSAM-WW-DP-9707

**Publication Date:** June 2, 1997

**Filing:** Perspective

(For Cross-Technology, file in the Semiconductor Application Markets binder)

FILE COPY:  
MARIA VALENZUELA

The basic assumption is that flash memory is just a medium, like the platters in rigid disk drives (RDDs), and should be somewhat imperfect to give the lowest cost per bit, just like RDDs. In order to realize this goal, the company uses a high-level RDD interface, the AT Attachment (ATA) standard, to allow for efficient management of the flash media. This also has the advantage of being hardware compatible with all computer systems that support RDD use—which is virtually all of them! This is music to the ears of those who have an allergy to software drivers and the problems they cause in complex system setups. A Motorola 68000 microcontroller core is used in the card to control the ATA interface, data flow, and media management. Physically, it uses a pin-and-socket connector like the PCMCIA cards from which it evolved.

### **Miniature Card**

The Miniature Card is sponsored by Intel and Advanced Micro Devices (in one of the few instances in which these silicon adversaries have agreed on anything without a judge in the middle), with Fujitsu and Sharp. The card is a housing for either a single flash device or a few. A small amount of glue logic may be included, but long term, this function will probably be absorbed by the flash chips. The PC requirement for RDD emulation is fulfilled with drivers, and these are included as plug-and-play with Microsoft's Windows 95 operating system. The guiding principle for this approach is to reduce the overhead cost of the assembly, so no processor is included. Lowering the overhead cost of delivering flash "bits" to the user is this standard's way of minimizing cost per bit. The media management function is performed by the system processor (Pentium or K6?) executing the drivers. The card is physically about the same size as the CompactFlash specification, but it uses an elastomeric connector instead of the traditional pin-and-socket connector to make it more consumer-friendly.

### **Solid-State Floppy Disk Card**

The SSFDC is sponsored by memory powerhouses Toshiba and Samsung, which also call it "Smart Media." The guiding strategy is similar to that of the Miniature Card, to lower overhead cost for the lowest possible cost per bit. The card's only component is a single flash chip, and the software drivers are similar in many ways to the Miniature Card's. The unique aspect of SSFDC is that it is not an assembly but is instead a large semiconductor package that lowers the cost of construction significantly compared to the other two. Electrical connection is made with metallic pads on the surface of the SSFDC in a manner similar to smart cards, also known as IC cards. The interface is optimized for the NAND flash memories being marketed by Toshiba and Samsung. Both the NAND chips and the SSFDC interface are serial, instead of the byte-wide or word-wide configurations of Miniature Card or CompactFlash card, which could lower the cost of both the chips and cards.

## The Market

The primary market for "flash film" is for use with digital still cameras, which capture images directly to digital form for use in Internet communications and desktop publishing.

The value of flash is as nonvolatile data storage of images, offering low power, high shock resistance, and small size, compared to mechanical alternatives.

Current implementations tend to use 2MB of flash for about 20 images. The number of pictures is limited by both the cost of higher-resolution charge-coupled devices for image sensing and the cost of flash. Dataquest believes that the flash sweet spot for digital photography will be the capacity (density) of the lowest-cost-per-bit flash memory. Samsung is now shipping a 32Mb (4MB) NAND flash chip and is starting to sell a 64Mb (8MB) device. Because of the rapid advances being made in flash memory technology, such as the use of multilevel cell technology, Dataquest believes that flash will not be a limiting factor but that it will be used in higher densities when it is available for those users that need the extra capacity and are willing to pay a premium for it.

As shown in Table 1, Dataquest believes that two scenarios should be considered for the digital still camera market. Scenario A, with the systems being used simply as PC peripherals, is most likely. In Scenario B, the cameras are used to replace existing silver halide-film cameras in some manner. Because of the inferior quality of the digital images, Dataquest believes this scenario is much less likely. The card forecast in the table assumes that cards will be used in more generic applications, not just in digital cameras, and that two cards per system will be used in the systems that take advantage of the cards.

**Table 1**  
**Projected Shipments of Digital Still Cameras and Small-Form-Factor Flash Memory Cards (Thousands of Units)**

	1994	1995	1996	1997	1998	1999	2000
Scenario A, Digital Still Cameras	30	254	1,100	1,914	4,154	4,984	5,981
Scenario B, Digital Still Cameras	30	254	1,100	2,667	5,670	10,524	13,902
Small-Form-Factor Cards	-	-	-	229	4,912	11,631	17,895

Source: Dataquest (May 1997)

## Dataquest Perspective

It is really easy to get drawn into the heat of this battle, but before this happens, consider: This market may never happen! Digital film has competition for downloading images to the PC from Universal Serial Bus, infrared links, and wireless technologies. Sure, nobody wants to run out of film at the bottom of the Grand Canyon, but how often does that occur? Maybe all the cameras *will* have card slots, but they won't be used very

often. Instead, the flash companies can start selling insurance on lost picture opportunities. They could end up making more money that way, considering semiconductor boom-and-bust cycles.

What if this technology does take off? According to Dataquest's *Flash Memory Applications Market Trends Report* (MMRY-WW-MT-9701, May 1997), even an optimistic forecast for digital film usage still makes it only a small percentage (10 percent) of the flash "bit" market. Anything but resounding success will leave the loudest proponents with big hangovers.

Which will win? Table 2 tabulates the strengths and weaknesses of the market leaders. Right now, CompactFlash has the most design-wins, but the *real* test will be who ships the most first and creates a legacy installed base that drives consumer purchase decisions. If Intel and AMD, both of which have demonstrated consumer and OEM marketing prowess, really wake up, this situation could change fast. TV ads might show dancing fab workers hawking flash chips instead of processors. Change the channel!

**Table 2**  
**Competitive Strengths and Weaknesses for Small-Form-Factor Flash Memory Card**  
**Market Leaders**

	Miniature Card	CompactFlash	SSFDC
Sponsors	Intel, AMD, Fujitsu, Sharp	SanDisk	Toshiba, Samsung
Card Cost	Almost best, but has printed circuit board assembly and multipart case	Worst, a microcontroller in each card with printed circuit board assembly and multipart case	Best, same as chip package
Software Support	Good, included in Windows 95	Best, ATA support everywhere	Good, included in Windows 95
Flash Memory Technology for Mass Storage	Worst, writes 100 KB/sec	In middle position, has low cost per bit but writes 100 KB/sec	Best, able to write 1 MB/sec; has low cost per bit because of highest density
Marketing Capability	Best, already on TV for consumers and good with OEMs for design-wins	Good with OEMs	Good with OEMs
Power Position	Intel is world's largest semiconductor company, very profitable	SanDisk was first in this market, has relationships with key OEMs but is smallest	Samsung is world's largest memory company

Source: Dataquest (May 1997)

#### For More Information...

Jonathan Cassell, Industry Analyst..... (408) 468-8195

Internet address ..... [jonathan.cassell@dataquest.com](mailto:jonathan.cassell@dataquest.com)

Via fax ..... (408) 954-1780

Dataquest Interactive ..... <http://www.dataquest.com>

The content of this report represents our interpretation and analysis of information generally available to the public or released by responsible individuals in the subject companies, but is not guaranteed as to accuracy or completeness. It does not contain material provided to us in confidence by our clients. Reproduction or disclosure in whole or in part to other parties shall be made upon the written and express consent of Dataquest.

©1997 Dataquest—Reproduction Prohibited

Dataquest is a registered trademark of A.C. Nielsen Company

Perspective



Consumer Multimedia Semiconductors and Applications  
Worldwide

## Product Analysis

### WebTV: Convergence Creates New Opportunities in Digital Consumer Electronics

---

**Abstract:** Speculation about the convergence of computing and digital consumer electronics is creating quite an industry buzz. Many semiconductor vendors that traditionally supply the PC industry are asking how they can tap the consumer electronics market as new digital consumer products hit the streets. This Perspective examines the semiconductor content of a WebTV Internet terminal as an indicator of future convergence opportunities in digital consumer electronics for semiconductor suppliers.

By Geoff Ballew

---

#### What Is WebTV?

WebTV Networks Inc. is a California-based company that has a vision of millions of consumers surfing the Internet with low-cost terminals instead of PCs. The company is working to make this vision become reality by licensing a reference design for a low-cost Internet terminal as well as providing online services, including Internet access, for those terminals. The basic idea is a set-top box that sells for about \$300 and connects to the user's TV for a display. A user purchases a WebTV terminal, hooks it up to a TV and a standard telephone line and is automatically connected to the WebTV online service. The service is required but is priced competitively with other online services at \$19.95 per month for unlimited access.

Revenue for WebTV Networks comes from both license fees for the reference design as well as monthly service revenue from the users themselves. The reference design includes a custom chip manufactured by NEC and many off-the-shelf components. Two consumer electronics companies, Sony and

---

#### Dataquest

Program: Consumer Multimedia Semiconductors and Applications Worldwide

Product Code: MSAM-WW-DP-9706

Publication Date: March 25, 1997

Filing: Perspective

(For Cross-Technology, file in the Semiconductor Application Markets binder)

FILE COPY:  
MARIA VALENZUELA



Philips, have licensed the WebTV reference design so far, and both companies had product in the retail channel for Christmas 1996.

## What's Inside a WebTV Box?

Dataquest performed a system teardown specifically to answer this question. The heart of the system is a microprocessor and a large application-specific IC (ASIC) containing system logic and the graphics processor. Memory (ROM, flash, and SGRAM) and a handful of peripheral application-specific standard products (ASSPs) round out the system. Figure 1 illustrates the board layout of the Sony WebTV design. Following is a list of the major semiconductor components in the Sony WebTV terminal:

- MIPS R4640 with DSP enhancements
- Custom graphics processor with system logic
- 2MB mask ROM, two 8Mb chips, 512Kx16 organization
- 2MB flash memory, two 8Mb chips, 512Kx16 organization
- 2MB SGRAM, two 8Mb chips, 128Kx32x2 organization
- Controllerless V.34 modem chipset
- Keyboard controller
- TV encoder

## What Does a WebTV Box Cost?

The Sony WebTV product was introduced at a retail price of \$329 and dropped below \$300 in January. The cost to produce a WebTV terminal is much lower and, in fact, is low enough to provide some margin for the OEM as well as the retailer. In this respect, the WebTV terminal is more like a PC than some other digital consumer electronics products. Two consumer electronics products that are often sold at a loss (or at least near cost) are home video game consoles and satellite set-top boxes. WebTV terminals do not appear to be following this "razor blade" marketing (give buyers the razor handle, then sell them blades for profit).

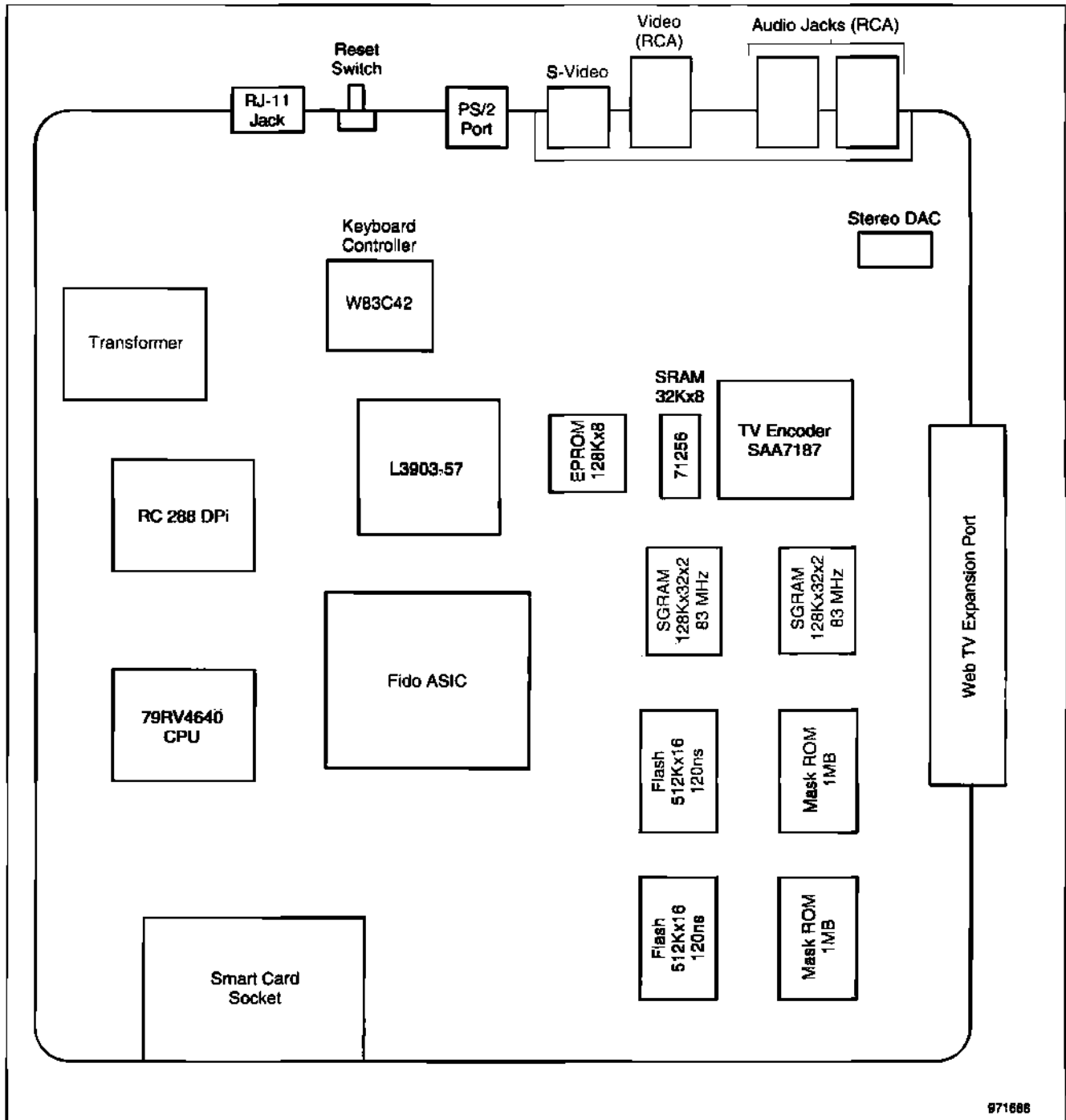
### System Costs

Dataquest believes the manufacturing cost of the Sony WebTV product to be well under \$200. Figure 2 shows the estimated costs by major subsystem, and Table 1 presents the actual dollar estimates.

## Semiconductor Opportunity

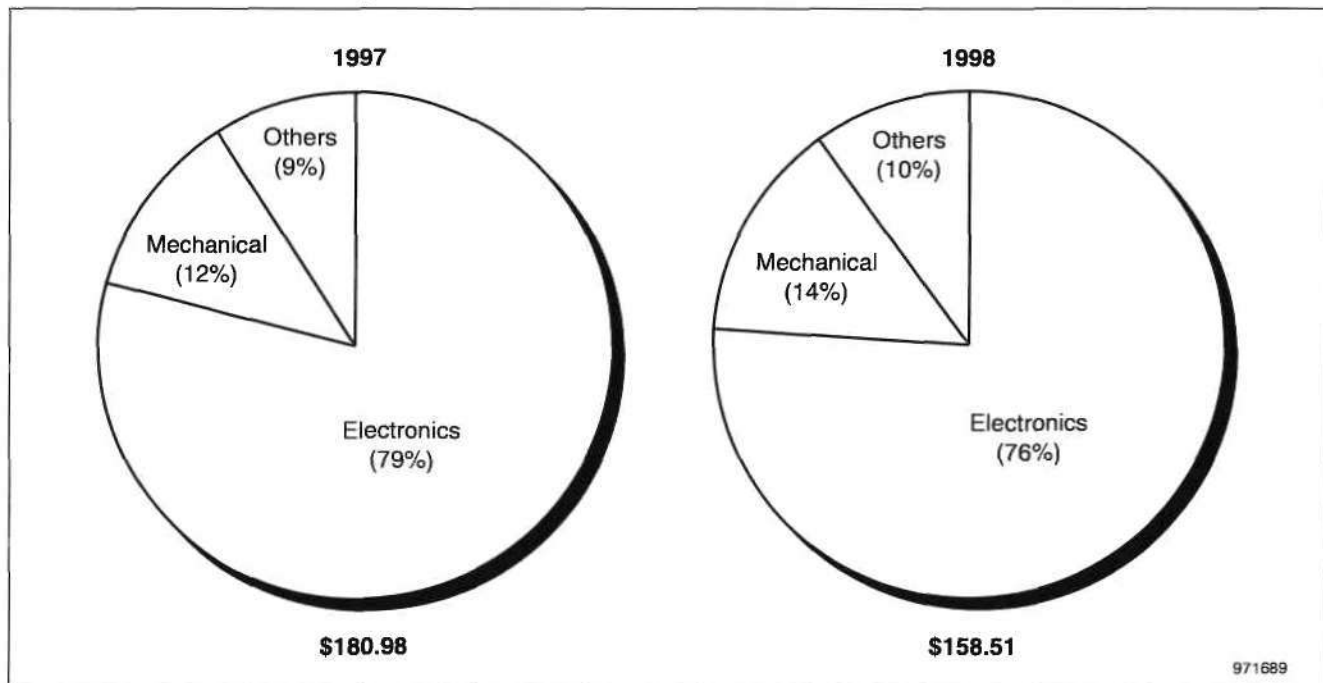
The semiconductor content of the Sony WebTV terminal is two-thirds of its production cost. Microcomponents provide most of the functionality and command the lion's share of the semiconductor dollars. Memory is also a vital part of the system. ROM is used to store the operating software with flash memory for software updates and new features.

**Figure 1**  
**Board Layout of the Sony WebTV Design**



Source: Dataquest (March 1997)

**Figure 2**  
**Estimated Costs for Sony WebTV Terminal**



Source: Dataquest (March 1997)

**Table 1**  
**Estimated Costs for Sony WebTV Terminal (Dollars)**

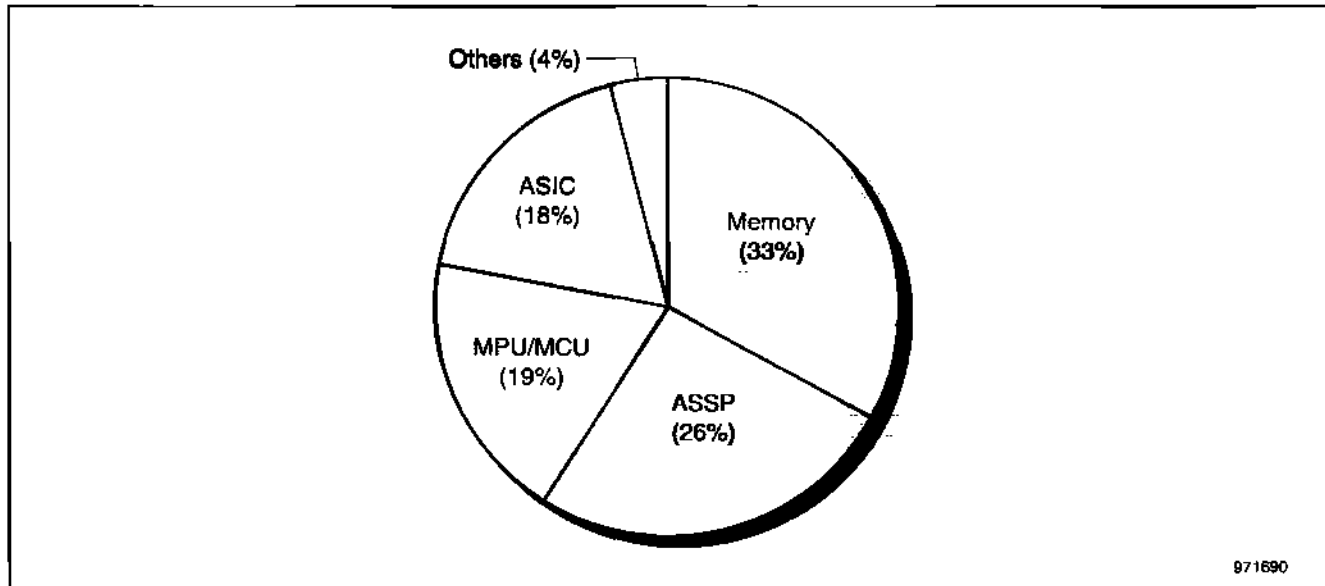
	1997	1998	Two-Year Average
<b>Electronics</b>			
Audio Subsystem	3.43	3.36	3.40
Central Electronics Subsystem	65.70	56.40	61.05
Communications Subsystem	28.48	21.94	25.21
Graphics Subsystem	14.26	12.22	13.24
Printed Circuit Boards	5.88	5.76	5.82
Power Subsystem	4.90	4.80	4.85
Processor	20.16	16.13	18.14
Total Electronics	142.82	120.62	131.72
<b>Mechanical</b>			
External Cables	7.65	7.65	7.65
Mechanical Subsystem	8.88	8.74	8.81
Remote Control	5.16	5.06	5.11
Total Mechanical	21.69	21.45	21.57
Assembly	10.00	10.00	10.00
Packaging	5.00	5.00	5.00
Publications	1.47	1.44	1.46
<b>Total</b>	<b>180.98</b>	<b>158.51</b>	<b>169.74</b>

Source: Dataquest (March 1997)

### Semiconductor Content per System

Figure 3 shows the distribution of semiconductor content among several product categories, with the actual data listed in Table 2. The comparison of costs between 1997 and 1998 assumes that the components do not change, even though minor upgrades, such as a 56-Kbps modem instead of V.34, are likely. These numbers exclude the semiconductor content of the power supply and remote control.

**Figure 3**  
Semiconductor Content for Sony WebTV Terminal (Dollars)



Source: Dataquest (March 1997)

**Table 2**  
Semiconductor Content for Sony WebTV Terminal (Dollars)

	1997	1998	Change (%) 1997-1998
ASSP	30.39	23.83	21.6
Memory	40.07	33.25	17.0
MPU/MCU	22.16	18.13	18.2
ASIC	21.79	17.43	20.0
Others	4.74	4.71	0.6
Total	119.15	97.34	18.3

Source: Dataquest (March 1997)

### Overall Market Opportunity

The size of the semiconductor market for a given application, such as Internet terminals, is important but is not the focus of this document. The bigger picture comes from using the WebTV terminal as an example of many digital consumer electronics products. Dataquest classifies many new digital consumer products as "next-generation" consumer electronics products. This category includes digital cable set-top boxes, digital satellite set-top boxes,

DVD video players, video CD players, home video game consoles, high-definition TV (HDTV) receivers, digital cameras, and other products.

The Dataquest forecast for the total ASIC and ASSP semiconductor revenue for these products is \$2.6 billion in 1997. The forecast climbs to \$5.6 billion for the year 2000, with ASSP revenue topping \$4 billion in that year. That \$4 billion segment is a new part of the consumer electronics semiconductor market where traditional PC semiconductor suppliers might compete effectively. Even marginal penetration of this \$4 billion market could boost a company's revenue by tens or hundreds of millions.

### **Sockets: Who Has Them**

The WebTV design is a mix of ASIC and standard product semiconductor devices. This variety opens the door of opportunity for virtually all major semiconductor suppliers to compete and potentially supply components. The high level of integration and high pin count for the custom graphics processor does limit the competition for that socket to top-tier ASIC suppliers. A much broader opportunity exists for the ASSPs and memory products. Suppliers that traditionally sell semiconductors for PCs will find opportunity to compete for the modem chipset, keyboard controller, TV encoder, and audio digital-to-analog converter (DAC). The memory components are commodity products, but the 5V-write feature of Advanced Micro Devices' flash memory is critical because this design does not include a 12V supply like the PC. Table 3 shows the suppliers of key semiconductor components.

**Table 3**  
**Semiconductor Suppliers for Sony's WebTV Terminal**

<b>Product</b>	<b>Supplier</b>
Microcomponents	
MPU	IDT
Graphics Processor (ASIC)	NEC
Modem Chipset	Rockwell Semiconductor
Keyboard Controller	Winbond
TV Encoder	Philips Semiconductor
Audio DAC	Asahi Kasei
Memory	
SGRAM	NEC
Flash	AMD
ROM	Samsung

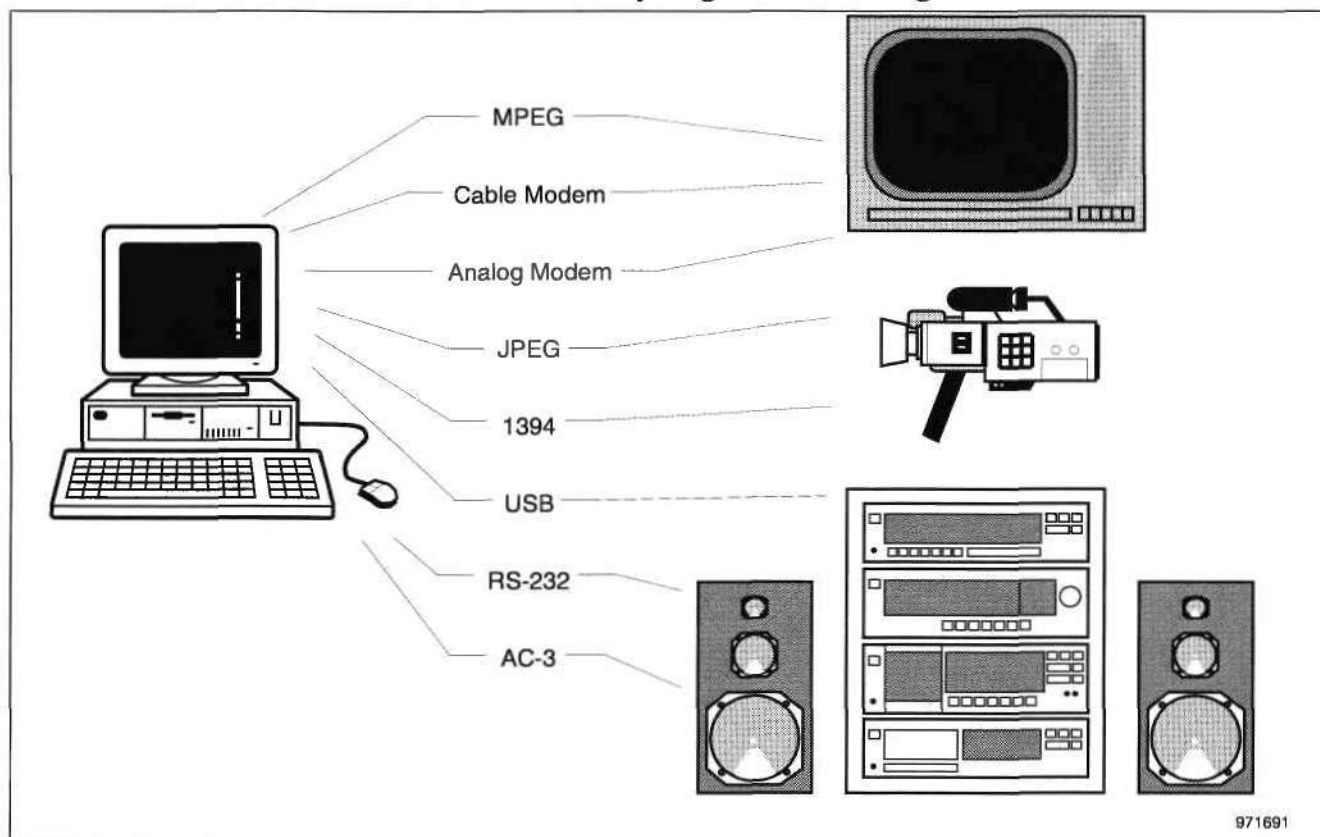
Source: Dataquest (March 1997)

## **The Convergence Semiconductor Opportunity**

This new digital consumer market offers semiconductor suppliers the opportunity to leverage product development across both consumer markets and PCs because many of the same technologies are required in each market.

With their knowledge of technologies and products related to Internet access through the PC, many traditional PC semiconductor suppliers will be seeking to leverage this capability into new products that are targeted at consumer electronics. Opportunities will exist in both dedicated function products, such as the WebTV system, and in multifunction products that incorporate Internet access as an important feature enhancement. Traditional consumer electronics semiconductor suppliers can view the entrance of PC semiconductor companies into this space as either a competitive threat or a market development opportunity. PC and consumer electronics chip companies possess complementary technologies and market knowledge that could be combined through partnerships to develop optimized system-level solutions. Figure 4 shows a number of digital technologies that overlap the PC and consumer electronics markets.

**Figure 4**  
**PCs and Consumer Electronics Share Many Digital Technologies**



Source: Dataquest (March 1997)

### Dataquest Perspective

WebTV is an exciting example of the convergence of computing and consumer electronics. It demonstrates an opportunity for PC peripheral chipset suppliers to sell to a new market—the consumer electronics market—as that market incorporates more digital technologies. It also presents an opportunity for consumer electronics players, just beginning their foray into

the wild world of the Internet, to build on the communications and Internet-related expertise developed in the PC industry. However, it should be recognized that historical and continuing differences do exist between the PC and consumer electronics markets.

PC semiconductor markets are characterized by standard products interfacing via standard interfaces. At this time, there is no equivalent to the PCI bus for consumer electronics. Standard interfaces do exist in the consumer electronics world, but they do not have the ubiquity that bus architectures in the PC world have. Consumer electronics is largely a mixture of ASIC and ASSP, while the PC semiconductor market is easily characterized as ASSP.

Semiconductor suppliers that sell to the PC market and wish to target the consumer electronics market should proceed with cautious optimism. Dataquest recommends that PC semiconductor suppliers evaluate their core competencies with respect to those that differentiate them from their traditional competitors as well as those that have impact for consumer markets. Bringing a "me too" solution to the convergence market is unlikely to be rewarding. Those products that truly offer differentiation are the tickets to success in this emerging market.

---

**For More Information...**

Dale Ford, Senior Industry Analyst..... (408) 468-8311  
 Internet address..... dale.ford@dataquest.com  
 Via fax..... (408) 954-1780Dataquest Interactive  
 ..... <http://www.dataquest.com>

The content of this report represents our interpretation and analysis of information generally available to the public or released by responsible individuals in the subject companies, but is not guaranteed as to accuracy or completeness. It does not contain material provided to us in confidence by our clients. Reproduction or disclosure in whole or in part to other parties shall be made upon the written and express consent of Dataquest.

©1997 Dataquest—Reproduction Prohibited

Dataquest is a registered trademark of A.C. Nielsen Company

Perspective



Consumer Multimedia Semiconductors and Applications Worldwide

## Dataquest Predicts

### The Sun Rises on the Digital Camcorder Market

---

**Abstract:** Digital technologies and formats are increasingly finding their way into analog-dominated consumer electronic equipment such as digital still cameras and DVD. Another would-be hot product in this emerging market is digital video cassettes (DVC) or digital camcorders incorporating the Super Density (SD) format into traditional video cameras. This document focuses on digital camcorder technology, analyzing demand and production trends, the positions of manufacturers, and major issues facing semiconductor manufacturers.

By Kun Soo Lee

---

### The Background on Video Camera Technology

Before discussing digital camcorders, the product's predecessors and background are worth reviewing. Camcorders are indeed a brainchild of Japanese consumer equipment manufacturers, integrating head and mechanical technologies that have been developed and refined in conventional VCRs, mounting technology such as double-sided mounting, and diverse semiconductor devices such as charge-coupled devices (CCDs). This technological leadership has enabled Japanese manufacturers to dominate the market for a while. Japanese VCRs were exported in mass quantities worldwide, far exceeding domestic demand.

According to Dataquest's estimates, 40.6 percent of world camcorder shipments in 1996 went to the Americas market, followed by Europe (30.4 percent). Japan, a leading producer, represented 14.1 percent of total demand. Clearly, two major markets, the United States and Europe, hold the key to future demand trends and should occupy a central position in vendors' marketing strategies.

---

#### Dataquest

**Program:** Consumer Multimedia Semiconductors and Applications Worldwide

**Product Code:** MSAM-WW-DP-9705

**Publication Date:** March 31, 1997

**Filing:** Perspective

(For Cross-Technology, file in the Semiconductor Application Markets binder)

FILE COPY:  
MARIA VALENZUELA



Camcorders are typically classified as consumer equipment, and their users are mostly general consumers. They are also positioned as luxury items, and demand is influenced by market factors and purchase requirements that vary greatly according to geographical area.

For instance, new models of camcorders are priced over ¥200,000 (or about \$2,200) and are positioned at the high end of consumer products. Asian consumers, including Japanese consumers, are attracted by high picture quality and other features and buy the high-end models regardless of price. However, price has proven to be a principal factor in purchase decisions in the United States and Europe, with very few people buying "prosumer products," which offer sophisticated capabilities equivalent to professional gadgets. The price range in these markets that attracts the majority of consumers is fairly low compared to Asia, under \$1,000 for camcorders.

### **The Digital Camcorder—A New Wave for the Camcorder Market**

Home digital camcorders, introduced in 1994, experienced a booming Japanese market in 1996 and the Japanese and Asian markets are continuing to ramp. The digital camcorders currently produced are based on specifications for consumer digital VCRs, the standards adopted by the industry in April 1994. In the Japanese market, digital camcorders gained more than 50 percent of the camcorder market in 1996.

Although digital camcorders are consumer products, they are characterized by a richness of the features that form an integral part of professional video cameras. For instance, the mechanism for recording an image digitally offers many of the advanced features, except for the lens, that are seen in TV station equipment. Digital camcorders also produce a much clearer and more focused picture than analog-based products. Digital technology allows the recording of an original image without its being affected by noise signals. Also, the picture quality never deteriorates with repeated replay and recording. Digital voice recording achieves high sound quality equivalent to that of CDs.

Cassette tapes used by digital camcorders are smaller than 8mm tape cassettes and capable of one hour of recording. They indeed are "matchbox size," much smaller than credit cards—7cm x 5cm, with a tape width of 6mm and a cassette thickness of 1cm. The use of this tiny tape medium allows the digital camcorder to be more compact and lighter weight than its analog counterpart, in addition to offering higher performance.

As in the case of traditional camcorders, the success of the digital camcorder depends on its ability to penetrate the U.S. and European markets. It is likely, however, that a significant price decline is a prerequisite to proliferation in these thrifty markets—less than one-half the original price—overshadowing the prospects for early ramp-up of demand. Meanwhile, consumption of digital camcorders to replace traditional camcorders is growing rapidly in Japan and Asia/Pacific, which is expected to keep the

marketplace busy until mainstream users in the United States and Europe come in.

Dataquest predicts that worldwide digital camcorder demand will surge 57.6 percent on an annual basis to 1.5 million units in 1997 and 64.5 percent to 2.5 million units in 1998, as shown in Table 1 and Figure 1. Figure 2 shows the digital camcorder average retail price forecast. Depending on the exchange rate, the market will become full-fledged as the price declines toward \$1,000. Penetration in the U.S. and European markets will become visible around 2000, when the price rapidly closes on \$1,000, and will take off in 2001 when the price drops below \$1,000. Dataquest expects that worldwide digital camcorder demand in 2000 will grow to 5.2 million units and to 7 million units in 2001, when digital camcorders will account for a majority of the camcorder market. Digital camcorder production driven by this demand is shown in Table 2.

**Table 1**  
**Worldwide Digital Camcorder Market Shipment Forecast by Region**  
**(Thousands of Units)**

	1994	1995	1996	1997	1998	1999	2000	2001	CAGR (%) 1996-2001
Americas	0	19	128	252	616	922	1,644	2,317	78.3
Europe	0	0	90	129	375	617	1,166	1,755	81.0
Japan	52	189	715	1,015	1,131	1,334	1,453	1,584	17.3
Asia/Pacific	0	0	15	98	337	549	892	1,288	144.6
Worldwide	52	208	948	1,494	2,458	3,421	5,156	6,944	48.9

Source: Dataquest (March 1997)

## Entering the Second Generation

With the second-generation products announced in September 1996, digital camcorders are becoming a mainstream market for manufacturers.

The lineup intended for the 1996 bonus season capitalized on digital technology with improved user-friendliness, reflecting consumer feedback from the first-generation product.

Common improvements seen among different vendors' models are a compact design leveraging a small tape size, the addition of a long-play (LP) mode that can prolong recording time by 50 percent, and an LCD monitor. The PC interface is addressed by including an IEEE 1394 port.

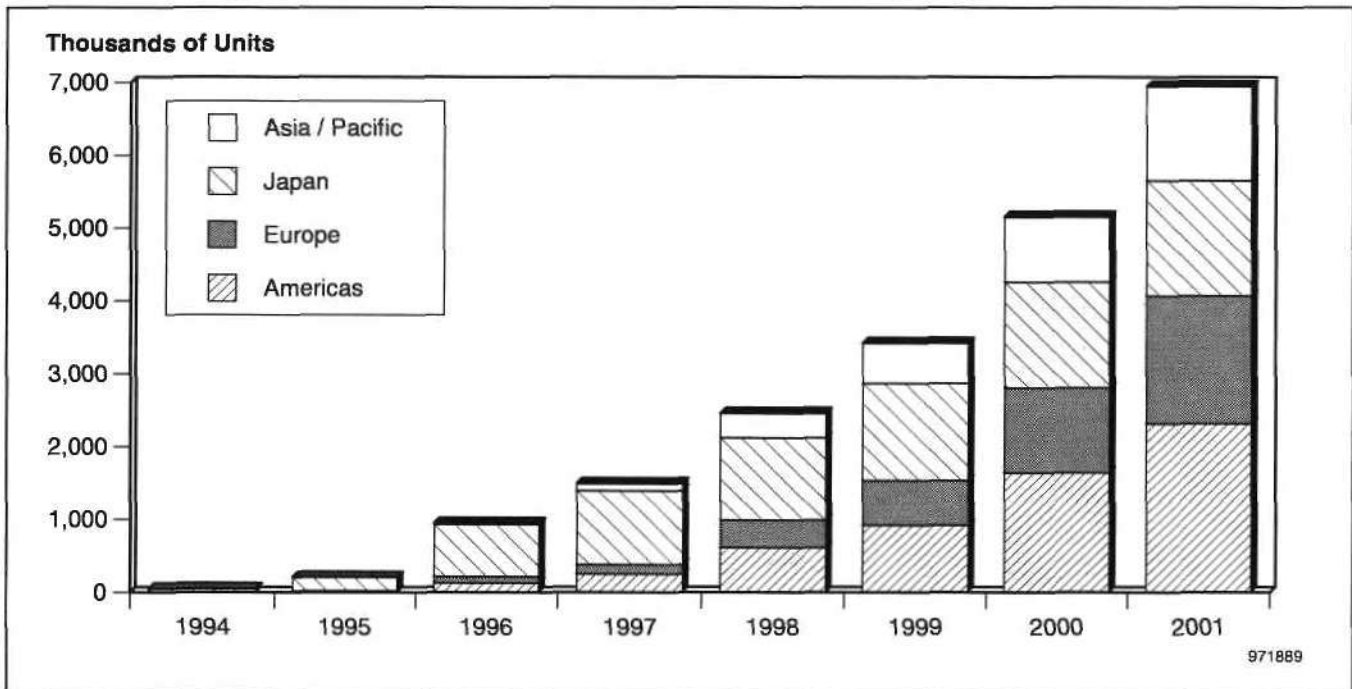
Although the second-generation models are offered at more affordable prices, one of the key components, the CCD, is much more powerful and capable than the first-generation product. As a result, the second-generation models offer better price/performance ratio.

The following sections discuss second-generation models.

**Sony**

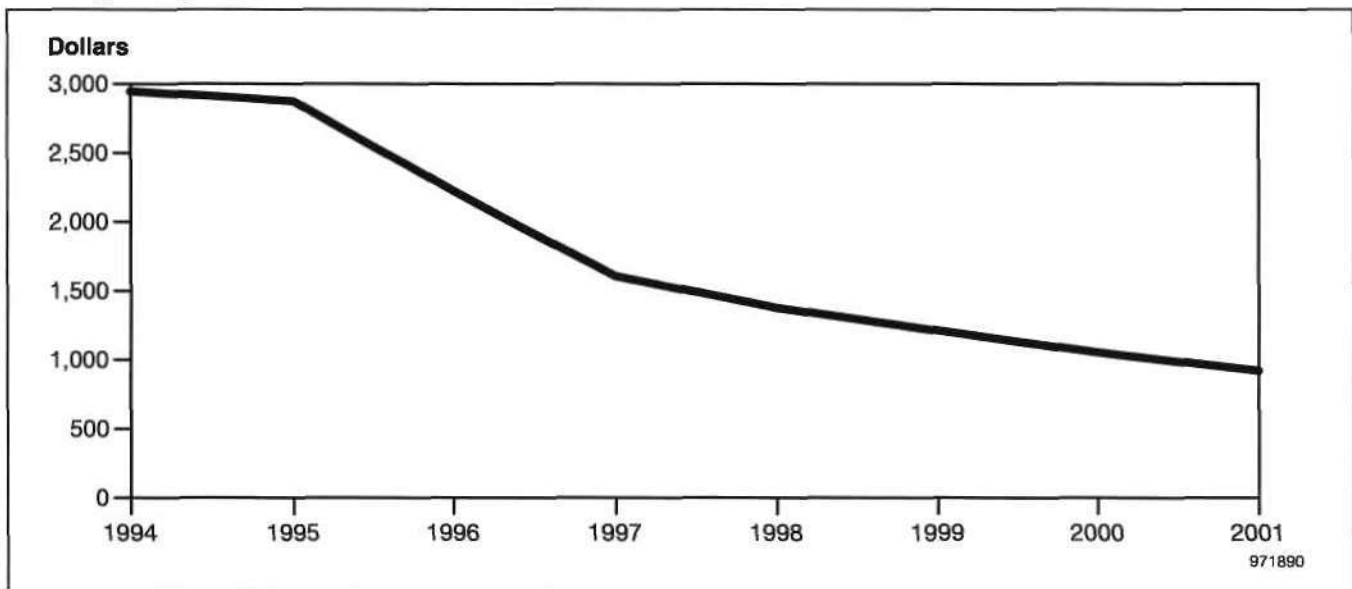
Sony Corporation's DCR-PC7 has successfully incorporated technological strengths developed during the analog age and is powerful enough to lead the digital camcorder market.

**Figure 1**  
Worldwide Digital Camcorder Market Shipment Forecast by Region



Source: Dataquest (March 1997)

**Figure 2**  
Average Digital Camcorder Retail Price Forecast



Source: Dataquest (March 1997)

**Table 2**  
**Worldwide Digital Camcorder Production Forecast**

	1994	1995	1996	1997	1998	1999	2000	2001	CAGR (%) 1996-2001
Units (K)	59	208	966	1,712	3,124	4,808	6,062	7,673	51.7
Factory ASP (\$)	2,100	1,661	1,523	1,221	989	772	604	528	-19.1
Factory Revenue (\$M)	124	346	1,472	2,091	3,090	3,710	3,663	4,053	22.7
Semiconductor Content (\$)	420	382	350	281	227	178	139	121	-19.1
Semiconductor TAM (\$M)	25	79	338	481	709	855	842	932	22.7

Source: Dataquest (March 1997)

This model, dubbed the Digital Passport, is impressively compact—the size of a passport—and takes advantage of the small digital tape. This miniaturization technology has been a result of efforts to minimize the mechanical part according to tape size and of tab grid array (TGA) mounting for IC fitting.

Its 2.5-inch LCD display is of the TFT type, consisting of 84,000 pixels. The batteries are the lithium-ion type and display the capacity remaining. In this generation, CCDs were specially developed for the digital camcorder, implementing 680,000 pixels and high picture quality. The DV terminal allows direct dubbing of digital images without deterioration. The DCR-PC7 has eliminated digital's major shortcoming, recording time, which is extended to 90 minutes by an LP mode. Unlike the analog mode, the digital product's LP mode is identical to its standard mode in terms of picture and sound qualities. However, a narrower track width results in lower reliability than the standard mode, so improvements in that, and thus, in accuracy, and in the head material are required. In the future, the issue of the shorter recording time can be overcome, as Sony plans to develop an 80-minute tape with the thickness reduced from 7mm to 5mm, which would offer 120 minutes of play in the LP mode.

### **Matsushita Electric Industrial**

The new lens is one of the major eye-catching features of Matsushita Electric Industrial Company Ltd.'s NV-DLI. It is larger in diameter than existing products and is primarily designed for higher brightness. It offers 14-times zoom, with a digitally based optional power zoom of up to 100 times. Another attractive feature is a large LCD display. A four-inch wide screen is packed with 115,000 pixels. Like the DCR-PC7, the NV-DLI adopts the LP mode to solve the disadvantage of a short recording time.

One major difference in the product concept from that of other vendors is its emphasis on interaction with PCs. Also, the NV-DLI is the first digital camcorder with a digital still picture terminal that allows the user to download image information to the RS-232C serial port.

### **Sharp**

The proliferation of wide-screen TVs has motivated Sharp Electronics Corporation to equip the VL-DH4000 with a wide screen with a 16:9 aspect

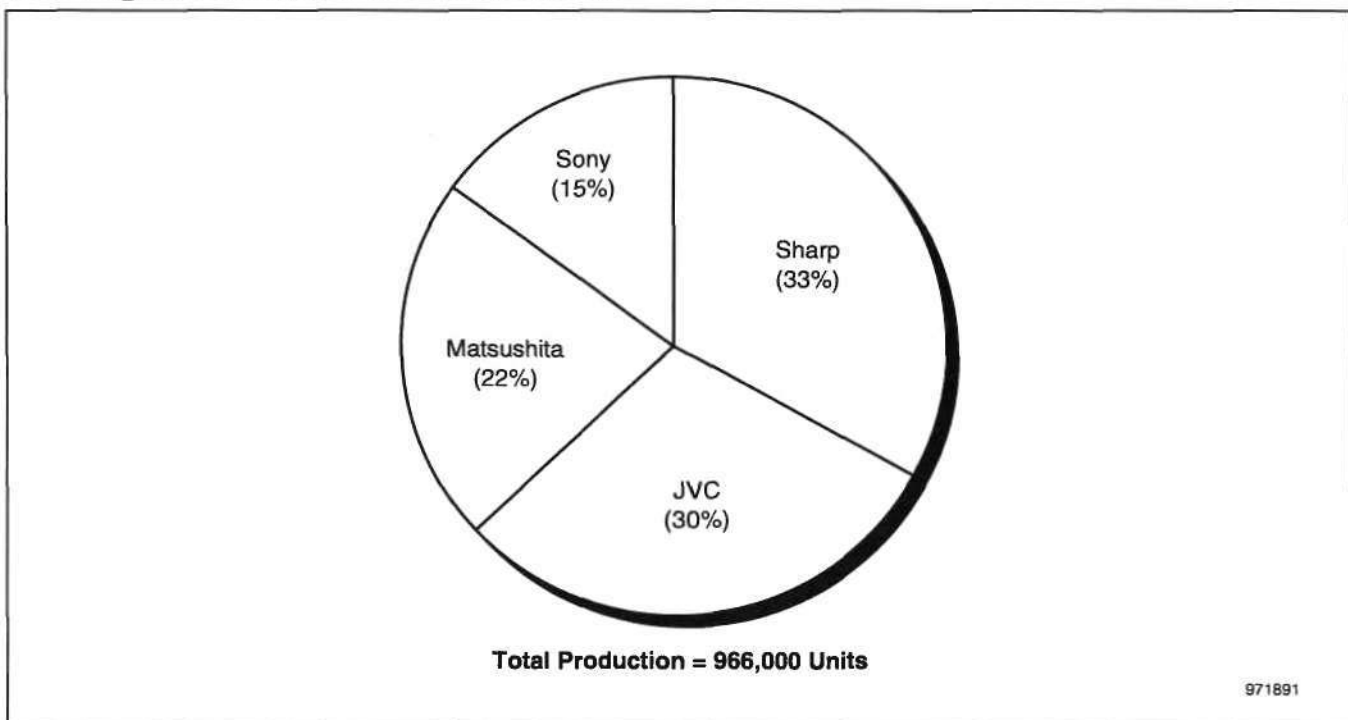
ratio. The company has developed 410,000-pixel CCDs, which permits the VL-DH4000 to show a full wide picture without cutting the upper and lower margins, as was done in the previous 4:3 CCDs. Also, the use of a 3CCD imager, which is a stacked CCD that incorporates three separate CCDs, reduces blurred color and noise. A mechanism for digital zooming up to 30 times is available. Sharp's technological strength is reflected in a 4.3-inch-wide LCD screen, which accommodates 154,000 pixels, up 40 percent from the 112,000 pixels for the previous four-inch screen. Combined with an optional still picture unit, the VL-DH4000 turns into a digital still camera, and still pictures can be stored and transmitted to PCs via a digital optical communication IrDA medium. Optional cables are supplied for serial communication. The still picture unit has a 2Mb flash memory and can store 30 still pictures of 720 x 480 dots in a standard mode or 60 still pictures in an economy mode.

## Production Shares

As manufacturers make committed efforts to serve the emerging market, worldwide production of digital camcorders neared 1 million units in 1996.

Figure 3 shows Dataquest's estimates of the share of each manufacturer, based on the 1996 production. The large share of JVC reflects its speed in entering the digital camcorder market by introducing new products ahead of competitors.

**Figure 3**  
**1996 Digital Camcorder Production Share**



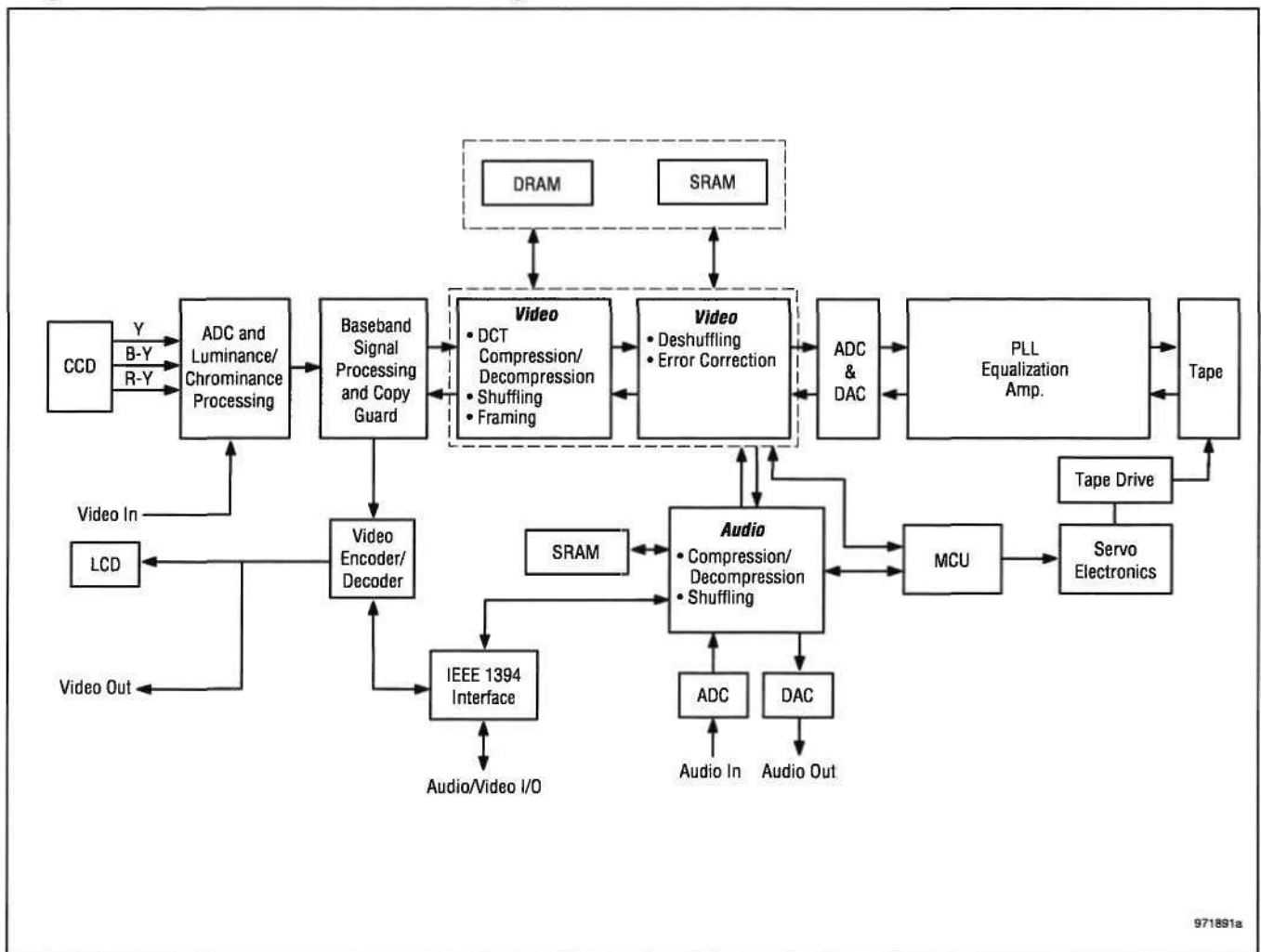
Source: Dataquest (March 1997)

However, other vendors were quick to catch up in the third and fourth quarters of 1996. In particular, Sony's DCR-PC7 has gained popularity and is showing an impressive recovery. Although the 1996 market was divided solely among Japanese manufacturers, who made a head start, from 1997 onward, competition will heighten as foreign vendors, such as Samsung, enter the market, and this will likely change the market share landscape.

## Semiconductor Opportunities

The digital camcorder provides opportunities for chip suppliers in audio/video digital and mixed-signal processing, as well as SRAM and DRAM. The basic block diagram shown in Figure 4 presents an outline of the functions performed in a digital camcorder. Many of the first-generation products have fairly nonintegrated solutions. With the expected integration in future products, the digital camcorder provides ripe opportunities for ASSPs and ASICs.

**Figure 4**  
**Digital Camcorder (DVC) Block Diagram**



Source: Dataquest (March 1997)

## Dataquest Predicts

Dataquest expects steady growth in digital camcorder demand up to 2001, with a compound annual growth rate (CAGR) of 48.9 percent between 1996 and 2001. It should be noted, however, that the digital camcorder market will not grow entirely on top of the existing analog market. Rather, it must rely for much of its momentum on replacement. The most significant change in the camcorder market will occur in the ratio between analog and digital camcorder models.

Another important trend is burgeoning market recognition of the digital-format digital camcorder as a promising PC peripheral, as seen in digital still cameras, which are increasingly used as an emerging image input device for PCs. Although it is still difficult for current PCs to manipulate animated pictures and rich content comfortably, the digital camcorder could be tomorrow's digital camera as soon as the task can be done without excessive resource stress.

Clearly, functional enhancement and cost reduction will determine the success of the digital camcorder market, and in the process, semiconductor design technology holds the key. Digital camcorder manufacturers will likely demand technical upgrading in various areas from chip suppliers, such as a lower operating voltage (2V to 1.5V) and higher-density processing and mounting.

The primary target for higher integration will be a single chip implementation of a chipset for DV conversion, which currently uses video compression/decompression based on quantization cosine conversion DCT technology or in a tape/audio format. In the next step, the IEEE 1394 interface and video or audio signal processing will be prime candidates, and mixed-signal ICs and embedded memory technology for frame buffer memory need to be incorporated.

As for high-density mounting, Dataquest believes that the thin quad flat pack (TQFP) of 0.5mm to 0.4mm, currently in wide use, will be gradually replaced by the chip-size package that was already adopted by Sony.

Dataquest expects that the development of such system-on-a-chip application-specific ICs (ASICs) will progress swiftly within the next two years and will contribute greatly to the digital camcorder's functional enhancement and cost reduction. Nevertheless, it is increasingly difficult for chipmakers to reap sufficient profit from investment while facing increasing cost pressure from customers, and Dataquest believes that they must solve this trade-off by relying on economies of scale.

---

**For More Information...**

Dale Ford, Senior Industry Analyst..... (408) 468-8311

Internet address ..... dale.ford@dataquest.com

Via fax ..... (408) 954-1780

..... <http://www.dataquest.com>

The content of this report represents our interpretation and analysis of information generally available to the public or released by responsible individuals in the subject companies, but is not guaranteed as to accuracy or completeness. It does not contain material provided to us in confidence by our clients. Reproduction or disclosure in whole or in part to other parties shall be made upon the written and express consent of Dataquest. ©1997 Dataquest—Reproduction Prohibited

Dataquest is a registered trademark of A.C. Nielsen Company



Perspective



## Consumer Multimedia Semiconductors and Applications Worldwide Market Analysis

### Consumer Electronics Semiconductor Application Market Quarterly Outlook: The Year Santa Never Came

---

**Abstract:** *This Perspective summarizes the worldwide situation for consumer electronics equipment and consumer electronics semiconductors in the fourth quarter of 1996. It provides a description of market conditions, significant events, and outlook for consumer electronics. Figures showing market performance and a table listing company results are included.*

*By Jonathan Cassell*

---

#### Market Status: A Flat Fourth Quarter Ends an Uninspiring 1996, but Glimmers of Hope Remain

##### Christmas Brings No Gifts to Consumer Electronics Makers

The fourth quarter was great for the consumer electronics industry in only one regard: It marked the end of 1996, a lackluster year for sales of all major types of consumer electronics equipment. Otherwise, the fourth quarter and the vital Christmas shopping season gave manufacturers little reason for holiday cheer, as consumers steered away from electronics and headed for the clothes, jewelry, and PC departments. The slowdown was not confined to a particular region, with most of the world reporting flat sales and flat-to-declining production in the fourth quarter.

In the world's largest consumer electronics markets—the United States and Europe—sales were flat for both the year and for the fourth quarter in the major categories of audio, video, and personal electronics. In Japan,

---

##### Dataquest

Program: Consumer Multimedia Semiconductors and Applications Worldwide

Product Code: MSAM-WW-DP-9704

Publication Date: March 10, 1997

Filing: Perspective

(For Cross-Technology, file in the Semiconductor Application Markets binder)

FILE COPY:  
MARIA VALENZUELA

production was down in most major consumer electronic categories. The Asia/Pacific region bucked the worldwide trend, with China experiencing respectable growth of 5 to 10 percent in major consumer electronic product areas such as televisions, radios, and appliances.

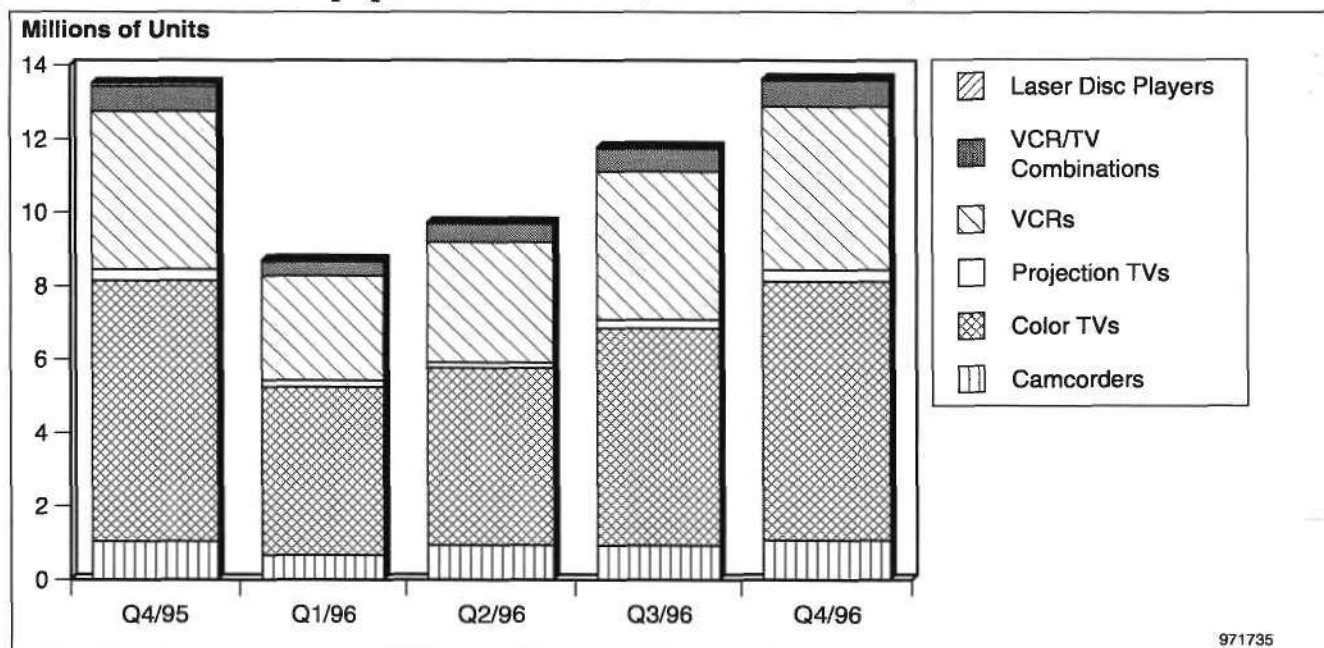
In the United States, video products showed barely any growth in dealer sales in the fourth quarter of 1996, compared to the fourth quarter of 1995. As shown in Figure 1, sales to dealers of color televisions and laser discs fell slightly, and sales to dealers of VCRs, camcorders, and projection televisions rose barely. For all video equipment, sales to dealers increased by less than 1 percent.

In Japan, the world's largest consumer electronics manufacturing region, production of video equipment was down 13.6 percent in the fourth quarter, compared to the fourth quarter of 1995, as shown in Figure 2. Production of video cameras and color televisions was down more than 8 percent for both categories on a dollar basis, although up on a yen basis. A combination of factors, including feeble demand, a weakening yen, and shifts in production from Japan to the Asia/Pacific region, contributed to the decline.

### Encouraging Signs

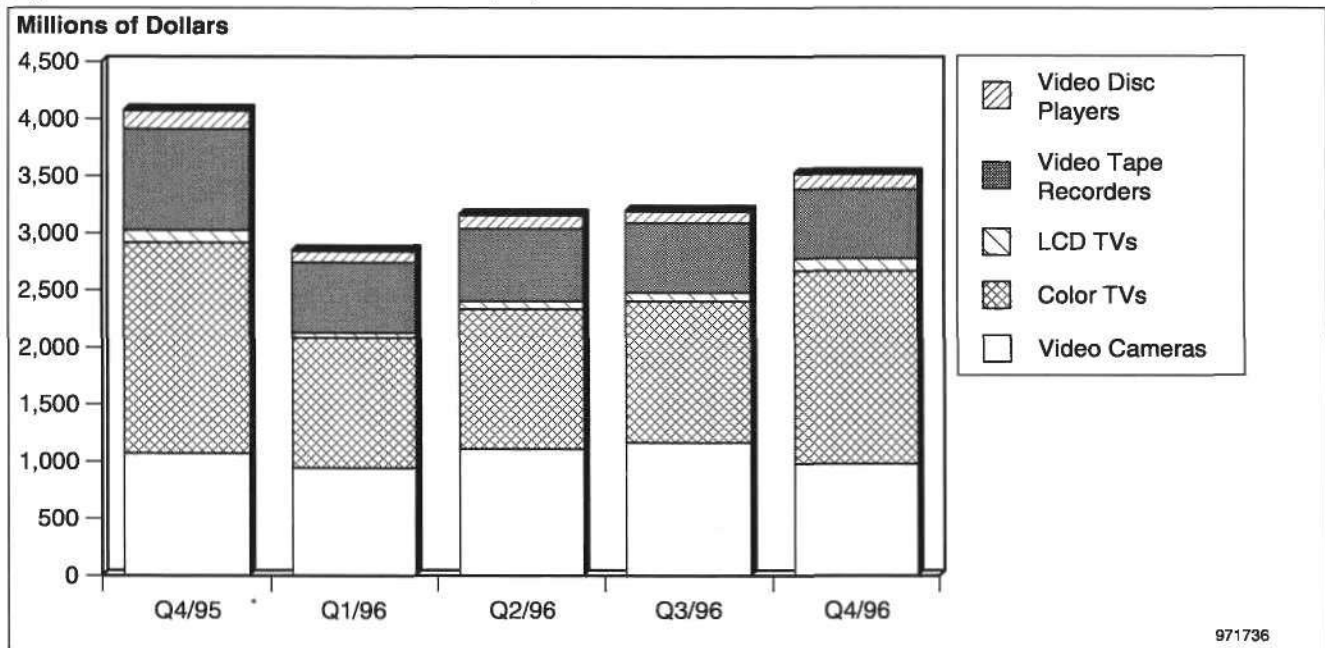
But a few silver linings were hidden in the gloom of 1996. Television makers report enthusiastic consumer acceptance of large-screen TVs used for home theater in the United States. Stereo VCRs and TV/VCR combinations were a hit with U.S. consumers as well.

**Figure 1**  
U.S. Sales of Video Equipment to Dealers (Millions of Units)



Source: Consumer Electronics Manufacturers Association

**Figure 2**  
**Japanese Production of Video Equipment (Millions of Dollars)**



Source: Ministry of International Trade and Industry

But the biggest success story in the fourth quarter and in 1996 as a whole was the overwhelming consumer acceptance of new, digital consumer electronics products in most regions. Despite delays in the introduction of DVD players, consumers flocked to buy other types of digital products. In the United States, sales of digital satellite television set-top boxes (STBs) hit record levels in the fourth quarter. In Japan, consumers snapped up digital camcorders. In China, video CD sales continued to boom. Consumers in numerous regions, including the United States and Japan, bought digital still cameras and 32- and 64-bit video games.

### Lessons Learned

The consumer rush to digital afforded an important lesson to equipment makers. By the fourth quarter, consumer electronics manufacturers were moving quickly to offer digital products in order to hop on the new wave of growth in the market. By late 1996, 13 manufacturers had introduced digital satellite boxes compatible with the Digital Satellite System (DSS) standard used by DirecTV/USSB. Once-conservative manufacturers like Zenith and Curtis Mathes showed television-based Internet access. Companies ranging from Philips to LG Electronics made forays into computing, showing consumer-oriented palmtops based on Microsoft's CE operating system.

However, the digital transition offers a second important lesson to consumer electronics manufacturers that may explain the lackluster 1996 and fourth quarter performance. Faced with a dizzying array of new digital choices, consumers have shied away from making major consumer electronics purchases until a clearer picture of the digital transition emerges.

With the approval of standards for digital television broadcast in the United States and Europe, consumers put off buying new sets for fear that their purchases might be outdated in a few short years. With the heavily touted DVD technology on the horizon, consumers hesitated to invest in new VCRs.

The lesson consumer electronics makers *should* learn from 1996 and the fourth quarter is that it is important to help consumers understand what the digital transition means to them. For example, consumer electronics makers must dispel the misperception that the advent of digital television broadcast and High-Definition Television (HDTV) means that their existing equipment will be useless. Also, consumers must be made aware that the introduction of new DVD players does not mean the immediate obsolescence of their VCRs.

With a clear understanding of the timing of the transition to digital broadcast and the availability of technologies that will allow their current equipment to continue to be useful, consumers' fears of immediate obsolescence could be dispelled.

### **Chipmakers Suffer and Benefit**

The year 1996 and the fourth quarter were not great for most consumer electronics chipmakers, either. Hit with the double whammy of lackluster consumer sales and plunging DRAM prices, Japanese and Asia/Pacific semiconductor suppliers saw their revenue shrink. However, for many chipmakers, the consumer rush to digital was a major boon, with suppliers of video decompression chips, in particular, reaping the benefits.

## **Industry Participant Update: Revenue Rises while Inventories Decline**

Chip sellers are defined as companies that derive a significant amount of their revenue from sales of chips into the consumer market (more than 10 percent of revenue) but that do not sell a significant amount of consumer electronics equipment. As shown in Table 1, consumer electronics chip sellers for the most part saw an increase in revenue in the fourth quarter of 1996 or in the second half of the year, compared to the same period one year earlier. Inventory days declined as manufacturers adjusted to slower market conditions compared to the same period in 1995. Some of the larger companies like Texas Instruments Inc., Motorola Inc., and LSI Logic Corporation experienced either little growth or major declines in revenue. TI's semiconductor business suffered from the precipitous drop in DRAM prices. However, its sales of digital signal processors (DSPs) and analog/mixed signal products grew strongly during the quarter, though the company attributed the sales gain to wireless and mass storage applications, rather than to consumer products. Motorola reported its semiconductor sales in the fourth quarter were down 18 percent and orders were down 11 percent. The company's semiconductor segment took a loss for the quarter.

**Table 1**  
**Key Consumer Electronic Market Equipment Producers and Chip Purveyors**

Company	Revenue Q4/96 or H1/96* (Millions of Dollars)	Change Q4/96 over Q4/95 or H1/96 over H1/95* (%)	Gross Margin Change Q4/96 over Q3/96 or H1/96 over H2/95* (% Points)	Inventory Days Q4/96	Inventory Days Q4/95
<b>Chip Sellers</b>					
C-Cube Microsystems Inc.	95.5	89.0	1.01	25.7	20.5
SGS-Thomson Microelectronics	1058.9	8.7	-1.29	NA	40.4
Texas Instruments Inc.	2,459.0	-21.9	-11.63	25.0	32.0
LSI Logic Corporation	301.8	-13.8	3.11	26.2	35.0
Motorola Inc.	7,685.0	5.3	1.44	36.7	42.3
<b>Equipment Sellers</b>					
Nintendo Co. Ltd.**	2,001.2	29.6	-3.11	8.7	15.7
General Instrument	736.6	13.6	NA	40.0	33.4
Scientific-Atlanta	282.2	8.1	NA	55.4	82.6
<b>Equipment Sellers/Chip Sellers</b>					
Philips Electronics N.V.**	19,041.0	4.7	NA	70.7	NA
Samsung Electronics Co. Ltd.**	11,003.3	19.4	NA	14.8	12.2
NEC Corporation**	29,642.0	NA	NA	27.8	20.8
Sony Corporation**	2,374.4	20.6	-13.07	66.1	71.0
LG Electronics Co. Ltd.**	4,645.0	13.0	NA	16.4	18.4
Sanyo Electric Co. Ltd.**	7,577.3	NA	NA	39.8	37.7
Sharp Corporation	5,913.0	-1.3	NA	9.3	8.4

\*According to the Japanese fiscal calendar

\*\*Companies that report according to the Japanese fiscal calendar

NA = Not available

Source: Dataquest (February 1997)

The brightest stars among consumer chip sellers were those companies that cashed in on the digital video revolution by offering video decompression chips.

C-Cube Microsystems saw its revenue jump 88.95 percent in the fourth quarter of 1996, compared to the fourth quarter of 1995. Although SGS-Thomson experienced only a single-digit increase in revenue in the fourth quarter, 1996 was a great year for the company overall, as revenue increased 24 percent to \$4.2 billion for the entire year and its ranking as worldwide chip supplier rose from No. 14 to No. 9. A factor in SGS-Thomson's success was its strong position in MPEG-2 decompression chips used in digital satellite television set-top boxes.

Consumer electronic equipment sellers are defined as companies that sell consumer electronics equipment and that derive 10 percent or less of their revenue from consumer semiconductor sales. These companies experienced a rise in revenue in the fourth quarter. This boost in revenue was shared by both large and small companies, with smaller outfits General Instrument and Nintendo growing in the double-digit range, as well as giants like Sony and Samsung. Although gross margin data was not available for most of the

companies in the segment, indications are that gross margins declined. Inventories were nearly unchanged in the fourth quarter and in the second half of 1996, compared to the fourth quarter of 1995, increasing a little more than one percentage point.

Companies that sell both consumer electronics equipment and chips are defined as those companies that derive more than 10 percent of their revenue from sales of consumer electronics chips and that sell a significant amount of consumer electronics equipment. Also included in this segment are consumer electronic equipment manufacturers that Dataquest has ranked among the world's top 10 consumer semiconductor makers. Such companies saw their revenue grow about 3 percent in the fourth quarter or the first half of the Japanese fiscal year. Meanwhile, inventories for these companies dropped significantly.

## **Notable Industry Developments and Product and Technology Introductions**

The fourth quarter saw many significant developments in the consumer electronics market, including the following:

- In October, Dataquest predicted that the consumer electronics equipment market would grow at a compound rate of 6.1 percent from 1996 to the year 2000. The associated semiconductor market was projected to grow much more strongly, with increases predicted to be more than 13 percent during the same period because of the continued digitization of consumer electronics as well as the introduction of new digital consumer types of products.
- In November, SGS-Thomson became the third manufacturing partner after Toshiba and LG Semicon for Chromatic Research Inc.'s line of Mpack media processors. Although SGS-Thomson is not a strong player in the PC market, it is a major supplier to consumer electronics worldwide and particularly in Europe. By partnering with SGS-Thomson, the long-term opportunity for the Mpack in the consumer electronics market has been boosted.
- After nine years of political wrangling, the U.S. Federal Communications Commission (FCC) in December approved a standard for digital television broadcast. The approved standard uses the broadcast technology supported by the "Grand Alliance," a group of consumer electronics companies and others, including Philips, General Instrument Corporation, and Zenith. However, the FCC did not approve a specification for the display aspect of digital television, leaving it up to the market to decide which format to use. By deciding not to decide on the display format, the FCC bowed to political pressure exerted by the computer industry, which had resisted the adoption of the Grand Alliance display specification because of its inclusion of interlaced scanning technology.
- China's color television industry in the fourth quarter began to show signs of recovery after a year of sluggish growth and consolidation. Increases in production efficiency, combined with strong consumer

spending, helped the industry make its way back to health. Because of a government austerity plan meant to cool inflation, consumer spending fell and numerous state-run enterprises bankrupted, downsized, or have merged with major national manufacturers in 1996. However, new competition from foreign imports represents a growing threat to the Chinese manufacturers.

- After years of unfulfilled promises, digital cable finally began to roll in the fourth quarter of 1996. At the Western Cable Show in December, Time Warner Communications, Tele-Communications Inc., and other cable operators said they had orders for digital cable set-top boxes that together will equal as many as 4 million units over the next several years. Television manufacturer Zenith at the show unveiled its new digital set-top box that has received a 3 million-unit order from the Americast consortium.
- In October, Cable Television Laboratories announced a new specification for digital cable boxes that incorporates General Instrument's demodulation and data encryption technology. Chief set-top box rival Scientific-Atlanta Inc. endorsed the specification. The publication of the specification and the endorsement of Scientific-Atlanta clears the way for the emergence of a North American digital cable box standard, allowing numerous manufacturers to compete in the market.
- The fourth quarter was the best of times for the digital satellite industry, as price cuts helped the business return to the kinds of growth rates to which it has become accustomed. Many of the major direct broadcast satellite (DBS) service providers reported record subscription levels in December. For the year, collective subscriptions for the five major U.S. DBS service providers—DirecTV, USSB, PrimeStar, EchoStar, and AlphaStar—were up nearly 9 percent from 1995's total. Makers of DBS set-top boxes also did well in 1996, with leading manufacturer Thomson Consumer Electronics reporting a 48 percent increase in box sales to dealers.
- With the digital cable business under way and the satellite business continuing to grow, chipmakers rushed to offer comprehensive silicon solutions for set-top boxes. Among the more notable introductions was VLSI Integrated Set-Top Architecture (VISTA), an application-specific standard product (ASSP) chipset introduced in September that incorporates most logic needed to build a digital television subscriber set-top box in just six devices.
- Nintendo on September 29 made the long-awaited U.S. introduction of its Nintendo 64 game machine. The product was a resounding success, with all 350,000 units in the initial shipment sold out within three days. By early December, 900,000 units had reached the market.
- Nintendo's prime competitor in the video game console business, Sony, had a great year in 1996, with sales of its PlayStation reaching 10 million units. Sony expects the installed base to grow to 20 million in 1997.

## Dataquest Perspective

Dataquest believes that 1997 will bring a return to growth in the consumer electronics market. However, the recovery will not be fully realized until the fourth quarter, leaving the market in a languid state early in the year. Despite that, in early 1997, digital consumer products sales are expected to grow at a rapid pace. DVD video players are beginning to enter the market now and are expected to ship in larger numbers by the fourth quarter of 1997 on a worldwide basis. In Japan and Europe, the deployment of digital satellite television is moving into higher gear, spurring sales of set-top boxes. In the United States, sales of digital still cameras will boom. In China and the rest of the Asia/Pacific region, sales of video CD will continue to grow at a rapid pace.

Equipment makers and chipmakers should continue to identify and exploit new opportunities in digital consumer products. They also should prepare for tougher competition in some of the existing digital product categories. Many new vendors have entered the digital still camera, digital set-top box, and video CD markets in 1996 and many more will appear on the scene in 1997. The result of the proliferation of new players has been declining prices and increasing features for these products and the chips used in them.

*Dale Ford, Kun Soo Lee, Ben F.P. Lee, Daniel Heyler, Mike Williams, and Paul O'Donovan contributed to this report.*

---

### For More Information...

Jonathan Cassell, Industry Analyst.....(408) 468-8195  
 Internet address..... [jonathan.cassell@dataquest.com](mailto:jonathan.cassell@dataquest.com)  
 Via fax .....(408) 954-1780

The content of this report represents our interpretation and analysis of information generally available to the public or released by responsible individuals in the subject companies, but is not guaranteed as to accuracy or completeness. It does not contain material provided to us in confidence by our clients. Reproduction or disclosure in whole or in part to other parties shall be made upon the written and express consent of Dataquest.  
 ©1997 Dataquest—Reproduction Prohibited

**Dataquest**  
 A Gartner Group Company

Dataquest is a registered trademark of A.C. Nielsen Company



Perspective



## Consumer Multimedia Semiconductors and Applications Worldwide Market Analysis

### DVD 1997: Are We There Yet?

---

**Abstract:** *This winter could be called the winter of discontent for the DVD community. With delayed market delivery and lingering doubts hanging over their heads, DVD manufacturers entered the 1997 winter Consumer Electronics Show (CES) hoping to rebuild confidence in retailers and consumers. This report presents a review of the current DVD market status and provides information on new announcements and details that emerged at winter CES.*  
*By Dale Ford*

---

### The U.S. Market: Land of Opportunity

In stark contrast to the bravado of a year ago, DVD promoters limped into the 1997 winter Consumer Electronics Show (CES) beset by diminished credibility, a less than stellar November launch in Japan, and indications that the hardware was still not truly ready for prime time. Indeed, the unbounded optimism where "the sky is the limit" of the January 1996 show has been replaced by cautious marketing plans and a "wait-and-see" attitude. Although there were repeated demonstrations of the capabilities of DVD, show attendees have grown jaded after a year of continual delays and broken promises. Typical responses from most people were, "We've been here before." Most companies are still long on promise and short on details, and the lesson learned in 1996 is that "the devil is in the details."

When Dataquest issued its first forecast for DVD video players in July 1996, it was roundly criticized by DVD proponents as far too pessimistic and conservative. Dataquest's forecast called for worldwide market shipments of 60,000 DVD video players in 1996, followed by 750,000 unit shipments in 1997. Based on this market demand, unit production was forecast to be 360,000 units in 1996 and 1.5 million units in 1997. With 1996 now history

---

#### Dataquest

**Program:** Consumer Multimedia Semiconductors and Applications Worldwide

**Product Code:** MSAM-WW-DP-9703

**Publication Date:** January 29, 1997

**Filing:** Perspective

(For Cross-Technology, file in the Semiconductor Application Markets, Volume 2, binder)

FILE COPY:  
MARIA VALENZUELA

and 1997 coming into better focus, the statistics and forecasts by leading industry players are coming closer to Dataquest's original forecast. In Japan, where DVD players finally reached the market in October 1996, early reports indicate that about 30,000 DVD video players were purchased by consumers and fewer than 100,000 units were produced by the three companies shipping players, Toshiba, Matsushita, and Pioneer. Weak software support at the time of the Japan launch left the players with little market pull. Only one movie title was available on the day of the launch because of bugs found in two other titles at the last minute, and by November there were only 14 titles available for DVD, including music videos. The Japan launch provided a valuable lesson for DVD manufacturers that had confidently predicted throughout 1996, "If we build it, they [consumers] will come." With a weak DVD market rollout in Japan, manufacturers have now turned their focus and their hopes to the U.S. market.

The current forecasts for the overall DVD video market shared by leading companies at the show are: Sony—500,000 unit shipments in the United States in the first 12 months after launch; Toshiba—1 million unit shipments in the United States in the first 12 months after launch; Matsushita—650,000 to 1 million unit shipments in the United States in 1997; Pioneer—400,000 unit shipments worldwide in the first 12 months after launch.

## Delivering the Goods

After losing the confidence of retailers and consumers in their promises of supplying products to the market, DVD manufacturers were much more cautious in their product launch announcements. The earliest dates were promised by Pioneer and Samsung, with U.S. market introductions scheduled for February. Pioneer may have more freedom to come to the market with its hybrid DVD/laser disc player because it can rely on an existing base of laser disc titles and does not have to anticipate the availability of DVD software. Most of the other leading companies were indicating market introductions in March or April, with other companies indicating they will follow launches by the leaders within 30 to 60 days. Table 1 provides details on the latest product and market launch announcements made by the 22 companies that have announced that they will sell DVD video players. It should be noted that a number of companies will bring DVD players to market that are supplied through an OEM arrangement with another leading manufacturer. There are only 10 companies currently able to manufacture their own DVD video players.

A list of companies demonstrating actual products at the show is also indicated in Table 1. Most companies either did not show actual products or were still showing prototype models. Even though companies were showing working hardware, a number of sources indicated that compatibility problems still exist among DVD hardware platforms. In other words, a DVD that would play on a Toshiba DVD player would not necessarily work on a Sony DVD player. It appears that there are still problems in the formatting of the content that create incompatibilities in playback. This fundamental issue

will have to be solved before manufacturers begin a major U.S. introduction unless they wish to commit market suicide.

A new and compelling group of seven companies announced plans to market DVD video drives. Denon, Harmon Kardon, Kenwood, Meridian, Marantz, Sherwood, and Yamaha are major players in the market for home theater products and audio. The addition of a DVD video player to their lineup is a very smart move, because the audio experience is one of the key features of DVD and the early adopters will come heavily from the ranks of home theater enthusiasts. This group of companies will be ideally positioned to capitalize on the DVD consumer interest. Typical plans involve sourcing the actual DVD player from another OEM and then bringing a complete DVD home theater system to market. Some companies, such as Yamaha, will play a greater role in product development with the semiconductor and sound processing technology that they possess. For DVD manufacturers, these arrangements are appealing because they will help drive higher production volumes to bring them down the cost curve more quickly. Matsushita and Toshiba appear to be the two principal companies that have developed DVD manufacturing agreements with these home theater companies.

**Table 1**  
**DVD Video Product Introduction Plans for the U.S. Market**

Manufacturer	Model(s)	Planned U.S. Introduction Date	Planned Introduction Price (\$)	Actual Product at CES?	Comments
Akai	DVD-P1000	April 1997	700-800	No	Plan to introduce integrated TV, Web NC, DVD in second half 1997
Aiwa	-	Q4/97	-	No	
Denon	DVD-2000	March 1997	999	No	Sourcing player from Matsushita
Harmon Kardon	HVD-715	-	-	No	
Hitachi	Two models	June 1997	-	No	
JVC	-	1997	-	No	
Kenwood	Two models	Second half 1997	-	No	One model sourced from Toshiba
LG Electronics	-	-	-	No	
Matsushita (Panasonic)	DVD-A100/ DVD-A300	Q1/97	599/749	Yes	
Meridian	-	-	-	No	
Mitsubishi	-	"30 days after major player introduction"	-	No	Acquiring its player through an OEM relationship

**Table 1 (Continued)**  
**DVD video Product Introduction Plans for the U.S. Market**

Manufacturer	Model(s)	Planned U.S. Introduction Date	Planned Introduction Price (\$)	Actual Product at CES?	Comments
Onkyo	DVD-7	1997	-	No	
Philips/ Marantz	-	-	-	No	
Pioneer	DVL-90/DVL-700/DV-500	February 1997	1,750/999/ 599	Yes	DVL-90 and DVL-700 include integrated laser disc player
Samsung	DVD-705U/ DVD-905	February 1997/Q3/97	699/?	Yes	DVD 705 will be shipped only to select outlets. DVD-905 will incorporate a Dolby Digital decoder for wider shipment
Sanyo	-	-	-	No	
Sherwood	-	1997	-	No	
Sony	DVP-S7000	April 1997	999	Yes	Plans to bundle four titles with its system
Thomson Multimedia	RCA: RC-5200/ RC-5500P ProScan: PS8600P	March or April 1997	499/599-649 649-699	Yes	
Toshiba	SD-2006/SD-3006	Q1/97	599/699	Yes	
Yamaha	DVD-1000	May 1997	-	No	Player manufactured by OEM using Yamaha technology
Zenith	2000/2100	-	749/?	No	

Source: Dataquest (January 1997)

## Hollywood Unveils Tempting Titles

On the bright side for DVD prospects, four companies announced specific plans to bring DVD titles to market in 1997. (Five are listed below, but Columbia TriStar and Sony Music Entertainment are both owned by Sony.) Announced plans indicate that there will be at least 50 DVD titles available in the early stages of the U.S. DVD rollout and more than 110 titles within the first year of the DVD market launch (see Table 2). DVD manufacturers are hoping that these announcements are just the beginning and that future announcements will push the total number of DVD titles released in 1997 to more than 200. One of the major companies that has not announced its intentions yet is Disney. Of course, all of these announcements are contingent on creation of adequate authoring facilities to enable the production of DVD encoded titles. Also, the cost of a DVD title remains a critical unknown. When asked about pricing for DVD software, companies

are responding that it will be more than VHS cassette prices but less than laser disc prices, which leaves a range between \$20 and \$60.

**Table 2**  
**Hollywood Studio Software Releases for DVD Video Players**

Warner Home Video	MGM Home Entertainment	Columbia TriStar Home Video	Sony Music Entertainment	New Line Home Video
<b>Announced Plans</b>				
Initial release of titles to begin in March 1997 followed by future releases simultaneous with VHS release	Will release 10 titles in April 1997, followed by 30 titles before the end of 1997	Will release 20 titles during 1997	Will release five music and children's programs during the initial launch phase	Six titles to be released as soon as possible and possibly 25 more titles during 1997-1998
<b>Announced Titles</b>				
Batman	The Birdcage	Close Encounters of the Third Kind	Beavis & Butthead's The Final Judgement	Dumb and Dumber
Blade Runner: The Director's Cut	Casablanca	Fly Away Home	Odyssey into the Mind's Eye	The Mask
The Bodyguard	Get Shorty	In the Line of Fire	Sesame Street's 25th Anniversary	Mortal Kombat
The Bridges of Madison County	Goldeneye	Jumanji	Streetfighter II- the Animated Movie	The Player
Bonnie and Clyde	Midnight Cowboy	Legends of the Fall	Tony Bennett's MTV Unplugged	Rumble in the Bronx
Casablanca	Raging Bull	Matilda		Seven
The Color Purple	Rocky	Taxi Driver		
Doctor Zhivago	Singin' in the Rain			
Eraser	Species			
The Exorcist	The Wizard of Oz			
The Fugitive				
The Glimmer Man				
Gone with the Wind				
Goodfellas				
Interview with the Vampire				
JFK: Special Edition Director's Cut				
Lethal Weapon				
The Road Warrior				
Singin' in the Rain				
Space Jam				
A Streetcar Named Desire: Director's Cut				
A Time to Kill				
Twister				
Unforgiven				
Woodstock: Director's Cut				

Source: Dataquest (January 1997)

Future releases planned by Warner include:

- Mars Attacks!
- Michael
- Michael Collins
- My Fellow Americans
- Sleepers

It is worth noting that the software providers will control which features of DVD are available to consumers, such as multiple languages, screen formats, and parental control. The only way these features will be enabled is if the producers of the titles incorporate the features in their release. As a result, a feature such as parental screening will probably wait for consumer demand to develop and for industry bodies to create a uniform system. A feature such as incorporating multiple language tracks and subtitles may actually work against Hollywood interests and their insistence on a regional coding scheme so they can control title releases in different markets. Although DVD enables many new features, it will be up to the software providers to determine which features are actually delivered to the consumer.

## The Devil Is in the Details

In terms of providing details on their DVD product and marketing, Sony was the best prepared for the show. Toshiba and Matsushita were also attempting to communicate their product and marketing plans. One of the major players in DVD, Philips was strangely quiet relative to the other show participants. Sony was showing its DVD video player, the DVP-S700, and its DVD-ROM drive, the DDU-100E. In discussions about the DVD video player, the company shared additional technical details as it worked to justify the high-end price of \$1,000 for the system. Sony did not announce pricing for the DVD-ROM drive. It is convinced that the early adopter will gravitate to a higher-end product and its salesforce will work to make their sales based on quality rather than price. The company also shared some of its DVD market plans. There were no representatives from the PlayStation division at the conference, and so no comment was made on the future of DVD in Sony's video game console. Some of the details from the conference with Sony executives are:

- The DVP-S7000 uses technology developed at Sony, and the semiconductors were all designed and produced by Sony, including the MPEG-2 video processor and the Dolby digital processor. The exclusive use of internally developed chips is common among the leading DVD systems manufacturers. System and technology features include:
  - 10-bit video digital-to-analog converter (DAC)
  - Smooth Scan viewing in either direction in any mode using a 32-bit RISC MPU
  - A digital video noise-reduction chip

- ❑ Advanced 24-bit digital processing
- ❑ Digital cinema sound fields and bass redirection
- ❑ Dual discrete optical pickup mechanism for CD
- ❑ Current-pulse DAC and feed-forward filter
- ❑ Low-resonance BMC honeycomb chassis
- ❑ Highly stable R-Core transformer
- This system will be available in spring 1997, and the product lineup will expand by late 1997.
- Four titles will come bundled with the DVD video player, and the company will launch a promotional campaign with Blockbuster Video.
- DVD authoring centers have been established in Japan and Culver City, California.
- Sony disc manufacturing plants will have a capacity of 200,000 DVD discs per month at launch, and capacity for another 300,000 discs per month will be available at Sony's facility in Indiana. (Previously, Sony has produced over 4 billion CDs in 11 plants worldwide.)
- The DDU-100E DVD-ROM drive will be compatible with most other PC optical storage drives and will ship in sample quantities to PC OEMs by late January.
- PC by Sony will incorporate a DVD drive by summer 1997.

Differentiation among the different DVD systems will be difficult for manufacturers to establish. Most technical brochures for the DVD models being demonstrated provided a simple recitation of the DVD specification. Although Sony has worked to illustrate distinguishing features in its system, these are details that are meaningful for sophisticated consumers—hence the positioning of its system at the top end of the market.

There is one feature that will be easy for a consumer to understand and is already being used as a price differentiator. The incorporation of Dolby Digital (AC-3) decoding and six speaker outputs is not a standard feature in all DVD systems. Many systems will require the consumer to purchase a separate Dolby Digital decoder in order to get true surround sound. For example, the Sony DVD video player does not include a Dolby Digital decoder. In order to access this feature, a consumer will have to purchase a separate processor such as the Sony SDP-E9ES for an additional \$799. Otherwise, the consumer will have to settle for stereo playback instead of true surround sound. Other players such as the Matsushita system include the Dolby Digital decoder in the DVD video player. The appeal of surround sound as a DVD feature has created new market opportunities for companies supplying virtual surround sound technology over two speakers.

## From Transistor Radios to Virtual Surround Sound

Although the early adopters who purchase DVD video players may be willing to make the additional investment in Dolby Digital sound systems with six speakers that enable the complete surround sound promised by DVD, the added cost of a high-end surround sound system is beyond the reach of most consumers. Chips and technology that will allow consumers to enjoy the advanced audio features of DVD without investing in a complete home theater system are already poised to penetrate the next generation of DVD players and stereo receivers. These chips will allow a consumer to enjoy the advances of Dolby Digital technology over a two-speaker system instead of a more costly six-speaker system through a technology called virtual surround sound. In addition to permitting a consumer to leverage investments in existing stereo equipment, this technology also finds application in the multimedia PC segment where DVD content is played back over a two-speaker system. Acknowledging the development of this technology, Dolby has established two new labels, Virtual Dolby Surround and Virtual Dolby Digital. The Virtual Dolby Surround label will be applied to products that input the analog Dolby Pro Logic signal and produce virtual surround sound over two speakers. The Virtual Dolby Digital name will identify products that input the Dolby Digital AC-3 encoded signal and produce virtual surround sound over two speakers.

The core processing techniques of creating virtual speakers have been evolving for 30 years or more, but it is only recently that digital signal processors (DSPs) have enabled many of these products to be brought to market at affordable prices. In addition to Dolby's own Virtual processing technique, technologies that are applicable for Virtual Dolby processors include: A3D from Aureal Semiconductor, 3D Phonic from JVC, N-2-2 DVS from Spatializer Audio Laboratories, TruSurround from SRS, QSurround from QSound Labs, Sensaura from EMI/CRL, Virtual Sonic from Matsushita, and VMaX from Harman International. The N-2-2, TruSurround, A3D, and QSurround products support both Virtual Dolby Surround and Virtual Dolby Digital, which is required for DVD audio processing.

Some of the recent chip announcements and plans related to virtual surround sound processing are:

- Leading into the winter CES show, Zoran, the leader in Dolby Digital AC-3 semiconductor technology, announced the first single-chip Dolby Digital/Pro Logic solution with 3-D audio, the ZR38600. Five of the leading suppliers of virtual surround sound algorithms—Dolby, Harman, QSound, Spatializer, and SRS Labs, have ported their algorithms to the ZR38600.
- The Motorola 56xxx chip can implement virtual surround sound using the Spatializer N-2-2 algorithm that was developed on this platform.
- Chromatic Research has licensed the TruSurround technology from SRS Labs and will integrate the technology into its next release of Mpack media software.



- Aureal Semiconductor is shipping the VSP901 Virtual Surround Processor, which employs the A3D algorithm. It has also licensed its technology to Rockwell Semiconductor and Oak Technology.
- MedianiX Semiconductor announced a single-chip solution, the MED25006, that will support Virtual Dolby Surround but not Virtual Dolby Digital. This chip is targeted at the PC market.

As next-generation products that employ Dolby Digital technology increase their penetration of the broader consumer electronics marketplace, chips that implement virtual surround sound processing will find expanding opportunities.

## Perspective

Dataquest maintains its measured optimism with regard to the DVD market and continues to stand by its forecast for DVD video players. The U.S. DVD market should spring to life by the second quarter of 1997 with limited shipments to selected markets. This limited initial rollout will allow retailers and manufacturers to make preparations for a ramp to the critical 1997 holiday selling season. By then, manufacturers will hope to add a "T" to the end of the product category name to describe market conditions (DV/DT = acceleration).

---

**For More Information...**

Dale Ford, Senior Industry Analyst..... (408) 468-8311  
Internet address..... [dale.ford@dataquest.com](mailto:dale.ford@dataquest.com)  
Via fax..... (408) 954-1780

---

The content of this report represents our interpretation and analysis of information generally available to the public or released by responsible individuals in the subject companies, but is not guaranteed as to accuracy or completeness. It does not contain material provided to us in confidence by our clients. Reproduction or disclosure in whole or in part to other parties shall be made upon the written and express consent of Dataquest.

©1997 Dataquest—Reproduction Prohibited  
Dataquest is a registered trademark of A.C. Nielsen Company

Perspective



## Consumer Multimedia Semiconductors and Applications Worldwide Event Summary

### Reality Bites 1997 Winter Consumer Electronics Show

**Abstract:** Although 1996 saw the rapid market growth of selected consumer electronics markets, such as digital satellite set-top boxes and the video game console market, the overall decline in U.S. consumer electronics sales and the slide in core product areas instilled a sense of mortality in industry executives. The disappointments surrounding the missed launch of DVD in the United States could be emblematic of the overall industry psyche. Determined to generate renewed growth and recapture consumer interest and dollars, the industry came together at the 1997 Winter Consumer Electronics Show (CES) to demonstrate their latest products and share their ideas and strategies for stimulating increased revenue and profits. This document provides information and analysis on the most significant product announcements and demonstrations at the 1997 winter CES.

By Dale Ford, Jonathan Cassell, Paul O'Donovan, and Tom Starnes

### Laying the Foundation for Renewed Growth

A more somber mood pervaded the discussions at the 1997 Winter Consumer Electronics Show (CES) as consumer electronics executives tried to absorb and understand a market that fell flat during 1996 and saw the first decline in eight to 10 years in core product areas such as color television. Just as a company seeking to survive and stay competitive and profitable must periodically reinvent itself, the consumer electronics industry has reached a stage in its life where it must pursue a process of metamorphosis if it hopes to stimulate new revenue and profit growth. Most consumer electronics companies have seen this time coming and have already begun the process of developing new products and markets, but the slump in the industry has added a tangible sense of urgency to their plans. Although most expect the industry slump to last another two to three quarters, they hope to generate a

#### Dataquest

Program: Consumer Multimedia Semiconductors and Applications Worldwide

Product Code: MSAM-WW-DP-9702

Publication Date: January 28, 1997

Filing: Perspective

(For Cross-Technology, file in the Semiconductor Application Markets, Volume 2, binder)

FILE COPY:  
MARIA VALENZUELA

turnaround as they head into the critical fourth quarter of 1997, when holiday sales either make or break the year.

In a preshow presentation, James Meyer, executive vice president of Thomson Multimedia, outlined a forward-looking strategy for his company that illustrates the direction the overall industry must head. His strategy had four key elements:

- "Rebirth" core products with new and exciting features that will motivate consumers not only to buy but also to spend an additional \$50 to \$100 per unit. This concept captures the idea behind the consumer electronics category developed by Dataquest called "digitally enhanced" products. Renewed growth in consumer electronics will depend on the growth of these products, while the traditional core products, called "legacy" products by Dataquest, are destined for a flat to declining future.
- Establish and maintain leadership in digital categories such as Digital Satellite System (DSS) set-top boxes, DVD, and high-definition TV (HDTV). Again, this product category has been labeled "next generation" by Dataquest and represents a promising, high-growth segment of the market.
- Develop new products that take advantage of interactive content and services, such as program guides and the Internet. Although Dataquest is not a fan of the specific Network Computer (NC) concept in which Thomson is a partner, the idea of adding enhanced features to products that leverage the services and content available through the Internet has great potential. A number of products were introduced at this show that are based on the Internet. Although most of these products still leave much to be desired, it is important to remember that they are first-generation products. The creation of products that generate strong consumer appeal will be a process, and it should be expected that this road will be littered with failed products and concepts. Dataquest believes that the pursuit of products that incorporate Internet value is a solid strategy.
- Develop services complementary to the hardware through partnerships, alliances, and investments that can lead to new revenue and margin opportunities. Examples of Thomson's activities in this area are its investment in Starsight, which has been transferred to Gemstar in the recent merger, and its partnership agreements with DirecTV and USSB in the digital satellite set-top box arena. Activities in this realm present a significant risk in the true business sense. Although tapping into the revenue stream of a successful service can lead to big profit boosts, there is an accompanying downside potential. Major Japanese consumer electronics companies have learned this difficult lesson with their investment activities in Hollywood.

The products that are reviewed in the following section represent the tangible result of industry efforts to pursue strategies similar to those outlined above. Each of these products is at a different stage of development,

and each holds unique opportunities. However, embodied as a whole, these products represent the hope for the future of the consumer electronics industry.

## **DVD Demonstrations at Winter CES: Round Three**

In stark contrast to the bravado of a year ago, DVD promoters limped into the 1997 show beset by diminished credibility, a less than stellar November launch in Japan, and indications that the hardware was still not truly ready for prime time. Indeed, the unbounded optimism that "the sky is the limit" of the January 1996 show has been replaced by cautious marketing plans and a "wait-and-see" attitude. Although there were repeated demonstrations of the capabilities of DVD, show attendees have grown jaded after a year of continual delays and broken promises. Typical responses from most people were, "We've been here before." Most companies are still long on promise and short on details, and the lesson learned in 1996 is that "the devil is in the details."

After losing the confidence of retailers and consumers in their promises of supplying products to the market, DVD manufacturers were much more cautious in their product launch announcements. In terms of providing details on their DVD product and marketing, Sony was the best prepared for the show. Toshiba and Matsushita were also attempting to communicate their product and marketing plans. One of the major players in DVD, Philips was strangely quiet relative to the other show participants. For additional details on the status of DVD and developments at the Winter CES, please see the Dataquest document "DVD 1997: Are We There Yet?" (MSAM-WW-DP-9703, January 27, 1997).

## **Dolby Digital Goes Virtual**

Acknowledging the development of virtual surround sound technology, Dolby has established two new labels, Virtual Dolby Surround and Virtual Dolby Digital. The Virtual Dolby Surround label will be applied to products that input the analog Dolby Pro Logic signal and produce virtual surround sound over two speakers. The Virtual Dolby Digital name will identify products that input the Dolby Digital AC-3 encoded signal and produce virtual surround sound over two speakers.

Although the core processing techniques of creating virtual speakers have been evolving for 30 years or more, it is only recently that digital signal processors (DSPs) have enabled many of these products to be brought to market at affordable prices. In addition to Dolby's own Virtual processing technique, technologies that are applicable for Virtual Dolby processors include: A3D from Aureal Semiconductor, 3D Phonic from JVC, N-2-2 DVS from Spatializer Audio Laboratories, TruSurround from SRS, QSurround from QSound Labs, Sensaura from EMI/CRL, Virtual Sonic from Matsushita, and VMAX from Harman International. As next-generation products that employ Dolby Digital technology increase their penetration of

the broader consumer electronics marketplace, chips that implement virtual surround sound processing will find expanding opportunities.

## **DBS Delivers**

The direct broadcast satellite (DBS) industry bucked the trend in the consumer electronics market, as service providers reported an increase in sales in 1996. Despite a widely held perception of slowing in the DBS box market in 1996, overall DBS subscriptions and box sales actually increased for the year. Many manufacturers and service providers said sales and new subscriptions grew at record levels during the Christmas buying season. Attracted by aggressive promotions that cut the price tag of DBS boxes to as low as \$199, \$149, and even \$99, consumers snapped up DBS boxes used with the DirecTV, USSB, PrimeStar, and EchoStar systems.

DBS makers and service providers at CES turned their attention to new product introductions that filled some vital gaps in the business. Several companies announced new boxes that use various technologies to receive local channels. Lack of local channel support has been a thorn in the side of the DBS industry. Many DBS buyers have retained their cable subscriptions rather than risk missing out on local affiliates, while other consumers have been scared away from the product altogether. For additional details on the DBS market and the Winter CES announcements, please see the Dataquest document titled "DBS 'Stars' Shine at Winter CES" (MSAM-WW-DP-9701, January 27, 1997).

## **Digital Still Cameras Push to Meet Expectations**

In general, 1996 may not have been a great year for consumer electronics. But for digital still camera makers, it was a barn burner. Canon at CES estimated in 1996 that 320,000 digital still cameras were shipped in North America alone. Casio predicts that 2 million digital still cameras will be sold in 1997 in the United States alone.

With such great expectations for the digital still camera market, 12 companies arrived at CES bearing their digital camera wares. Eight companies at CES introduced new products, previewed upcoming offerings, or showed recently unveiled cameras. Including the CES announcements, there are now more than 50 digital still cameras on the market, ranging from \$200 consumer models to \$30,000 professional cameras.

The products introduced at CES indicated that digital still camera makers over the past two years have learned important lessons about price, features, and even the very nature of the product itself. Although many in the past have seen digital still cameras as a replacement for film cameras, manufacturers at a panel discussion said that their products are not intended to play that role. Because of their limited resolution, the vendors said digital still cameras cannot be used to produce photographs that rival 35mm prints. Instead, the vendors stressed the digital still camera's role as a PC

peripheral, providing an easy way to import photographs into computers for applications like Internet publishing and communications. A Canon representative put it best when he described digital still cameras as "PCs that take pictures."

Vendors also have learned valuable lessons about product differentiation and consumer wants and needs. Perhaps the best examples of those lessons learned were new digital still cameras that use CMOS sensor technology to deliver new levels of price and performance. CMOS sensors are a new image acquisition technology that perform the same function as charge-coupled devices (CCDs). Like CCDs, CMOS sensors can turn photons into electrons that can then be digitally processed. Unlike CCDs, which must be fabbed using a specialized process, CMOS sensors can be built using inexpensive and widely available manufacturing technology and facilities. Thus, CMOS sensors can be made at a far lower cost and at much higher resolutions than CCDs.

Reducing the cost of image acquisition is key to bringing digital still camera prices down to a more affordable level. CCDs frequently are the most expensive component in a digital still camera, costing as much as \$45 in high volume for a 640 x 480-resolution part.

Perhaps the most impressive digital still camera shown at CES was from start-up Sound Vision Inc. The Sound Vision product addresses two of the biggest problems consumers have encountered with digital still cameras: price and resolution. Priced in the low \$300s, the Sound Vision camera offers a resolution of 800 x 1000 pixels, comparable to products costing hundreds of dollars more. Sound Vision says the company's goal is to offer a \$200 digital still camera with extremely high resolution. This is a worthy goal, given that Dataquest has identified \$200 as a key price point for digital still cameras that will massively increase their acceptance. Sound Vision sources its CMOS sensor from VLSI Vision Ltd., based in Edinburgh, Scotland.

Running a close second on the "wow" scale was Toshiba's PDR-2A digital still camera, which also uses a CMOS sensor. At 640 x 480 resolution (which is becoming standard for digital still cameras), the PDR-2A does not offer the overwhelming picture quality of the Sound Vision camera. What it does do is use the low-cost CMOS sensor as the basis of a full-featured, attractively packaged digital still camera that is relatively affordable. Though it is priced at \$499 and is small enough to fit in a shirt pocket, the PDR-2A boasts an impressive feature set, including JPEG image compression, removable storage, and a built-in PCMCIA card. Toshiba is using its own CMOS sensor for the PDR-2A.

Several other companies are poised to jump on the CMOS sensor bandwagon, including Vivitar.

Although the digital still camera makers have come a long way, it is clear that they still have some major hurdles to jump. The biggest hurdle is confusion and disagreement over the various formats for memory expansion cards. Memory expansion cards, which are based on nonvolatile flash

memory, are matchbook-size modules that expand the photo capacity of digital still cameras. They also can allow easier exporting of digital images to computers and to development systems. Several cameras using the cards were introduced or shown at CES, including the Toshiba PDR-2A, the Fuji DS-7, the PowerShot 600, the Kodak DC25, and a camera from Konica.

Because flash cards are becoming so important to digital still cameras, it would be desirable to have a single standard for the cameras that all consumers can use. However, numerous flash card standards exist. The most prominent ones now are the Solid-State Floppy Disk Card (SSFDC) flash card technology championed by Toshiba; the Miniature Card, led by Intel; and CompactFlash, from SanDisk.

Cameras at CES using the SSFDC technology were the Toshiba PDR-2A, and the Fuji DS-7. Showing CompactFlash cameras at CES were Canon, with the PowerShot 600, and Kodak, with the DC25. Although it was not officially introduced at the time of the show, a Konica camera using Miniature Card technology was demonstrated.

Other digital camera happenings at CES included Sharp's showing of its VE-LS5 and MD-PS1 MD, ACS' showing of its Compro Digital Color Internet Camera, Vivitar's showing of its ViviCam 2000, and Panasonic's plan to introduce a digital still camera soon, as well.

## **Browsing the Web with the TV**

The TV is obviously a consumer product. There are many changes being attempted on the TV, from high definition to surround sound to satellite to digitization. The computer world has been trying to take entertainment away from the TV by putting it on the PC in the form of games, Video CD, and video feeds. But the computer world is also assaulting the TV by imposing itself on the unsuspecting couch potato who is computer fearful, computer illiterate, or just computer poor.

The Internet and the World Wide Web have become so prolific in the last couple of years as to entice advertisers to list their home pages before their telephone numbers on their ads and studios to note a home page among the credits of their programming. Because many of those ads appear on television, it might be really nice if the viewer could quickly redirect his TV to further information. TV browsers are hitting the electronics shelves to allow the TV to be used as the display for browsing the Web for a minimal cost and without the permanence of a hard disk for storage or a printer for hard copy.

The TV browsers are typically a \$300 set-top box that provides a window into the Web and allows electronic mail (e-mail) to be transmitted (made easier with a \$75 infrared keyboard). They usually require a subscription to their own special Internet service provider (ISP) for about \$35/month to back up the stripped-down box at the TV with a high-performance server. A telephone line connects the TV browser through its unseen modem to its



host. In the last few months, various models of these low-end Web interfaces have been demonstrated and even sold. Many TV browsers were on display at CES, and some organized discussion panels were heavily attended. This is a product category that is new and exciting but that has some growing pains to endure before it finds its place at home.

Part of the challenge of these Web interfaces is understanding the limits of the technology and of the consumer market. Limitations of the technology include the speed and loading of the modems and servers. Understanding and making use of the behaviors of the typical TV viewer could be one of the biggest impediments to the expansion of this market. Included in this is the content to be delivered to the system, as well.

At the home entertainment center, the listeners or viewers have instantaneous access to content that is broadcast to them. Interactivity is limited to changing stations or the tape or disc for program control or control of the volume, bass, or other audio quality, but it is instantaneous. The TV's picture and sound are there three seconds after the system is turned on.

With computerlike additions come computerlike response. Systems crash, modems hang, and phone lines get "noise." Set-top boxes and servers take minutes, not seconds, to "reboot." Servers get busy, and boxes take time to display the images and text, and sometimes the material is simply not available. These conditions were experienced at the demonstrations at CES. They will probably be seen more frequently in the less-trained hands of the department store or electronics superstore.

Will normal consumers tolerate the relative slowness of the Web when they are used to blazing through 15 channels looking for something better each time an advertisement interrupts the TV show they are watching? Television is a very dynamic medium. People do not read the TV, they absorb the full-motion action that the TV presents to them. Will people accept text and still images to supplement the familiar full-screen, full-motion, real life action? News programs tease with "film at 11" to highlight to the viewer that they'll get to experience the local fire when they watch the 11 p.m. news, not just read about it in the daily newspaper. After a few minutes of quietly reading the text of a news story on the TV screen, readers can find themselves missing the sound, video, and energy they're used to from their entertainment system. Are typed-text chat rooms a substitute for discussing the decisions made by the emergency room staff in the show "ER" with the spouse sitting next to you on the couch? Is the excitement of a football game expressed in a hunt-and-pecked message to a chat room, or do you just end up with a lot of expletives? Or do you just want to shout? Larry King hosts a talk show. The text of the show could get across the general idea of the discussion, but it is only by listening and seeing the discussion that a person gets the full emotion, expression, and interplay that underscore the words that were spoken.

## Program Guides

Most of the vendors of TV browsers tied the use of the system to TV viewing. Activities associated with the TV promoted by the vendors were program guides, news, sports scores, chat rooms, "for more information" diversions, and financial market data. For these uses, simple program guides would suffice. Dataquest's CES perspective last year ("Digital' Dominates the News at the 1996 Winter Consumer Electronics Show," MCRO-WW-DP-9601, February 12, 1996) highlighted a number of dedicated program guides. For about \$100 plus a possible \$4 per month service fee, these can sit on top of or be designed into a television and provide a day's worth to a week's worth of programming for the TV reflecting the local broadcast or cable channels. They can record a program on the VCR. Some of these devices also provide a (text-based) news service, up-to-the-minute sports scores, or weather information. Stock tickers cannot be far behind or are available on CNBC or Cable News Network's Headline News. The program guides are passive devices—the information is either there or it isn't—but they do not require a phone line to operate and are as instantaneous as the original TV. They are also tied to the TV, so they can record an upcoming program on the VCR, a task that seems to elude all but the more talented consumers, as well as instantly switch to the channel showing the basketball game in progress that was reported on the sports score display. For convenience and ease of use, integration with the TV/VCR, and initial cost and ongoing service charge, the dedicated program guides have the TV browser beat. The TV browser shines brighter when the viewer wants more.

The owner of a PC may need to add only about \$100 in modems and software and pay \$20 to an ISP to gain access to the Web in all its naked beauty. On a PC, the text is crisp, the images are sharp, and the pages are viewed as intended. Plus, it is rare that someone sits down at the PC, turns it on, and expects to then simply sit back and absorb the material that is sent (as happens with the TV) without providing significant amounts of input.

The TV browsers allow the home without a PC to get onto the Web for about \$300, plus \$35 per month to a specific ISP for a somewhat tailored view into the Web. This is certainly a cheaper approach than spending \$1,000 to \$2,000 for a personal computer and does not require additional space to be dedicated to all that computer gear. It is also intended to be self-upgrading so that the consumer need not be concerned every time a certain Redmond-based company opens another window or office. Should a friend mention a new processor buzzword or throw out a higher "megahertz" number, the consumer may indeed shudder, because these cannot be accommodated without the dreaded hardware upgrade/replacement, but at least the software enhancements should appear to be free (time will tell). Generally, for the long term, TV browsers are designed to be loss-leaders on the hardware but a revenue stream on the service side. This is obvious enough that one CES panelist was asked by a retailer how he could get a piece of the action on the service revenue rather than just selling the one-time box. No satisfactory response was given.

Another activity the TV browser enables for low cost is electronic communications. E-mail can be read on the TV screen quite readily. With a (usually optional) keyboard, a message can be composed and sent via e-mail. Although it has not been announced, it is quite conceivable that faxes could be viewed on the TV (with zooming capability so the fine detail can be worked out). To date, these items do not have the storage and printing facility that PC users are fond of, though at least the printing would be a reasonable thing to add for a couple of hundred dollars, and the device would then allow word processing output, as well.

As for out-and-out Web browsing, the TV browsers are adequate. Depending on the specific box, the display on the TV screen is good enough but nowhere near what a PC monitor can show. Of course, at CES and in the stores, the TV browsers are attached to the better 32-inch screens so that they look as sharp and big as possible. Text can be quite challenging if it is in the wrong small font, and many of the TV browsers do not seem to automatically set a minimum font size or constrict the typeface to those that display best on a TV screen. Comments like, "Well, you can get a better TV or put it on a monitor ..." were heard at CES. Chances are that a TV browser on a \$200 19-inch color TV in a child's bedroom would soon be returned to the store. The layout of a Web page destined for a TV screen would ideally be put together differently than one destined for the PC (the usual target). Apparently, some feel that the opposite is true, as Philips' Web site cautions: "For the optimum viewing, do not look at [the Web-based user's manual] through your PC but rather on the Philips Magnavox Internet Unit. On the Web you simply will not find this online owners manual to be as crisp, clear and effectively designed as the rest of the Magnavox site. But with the Philips Magnavox Internet Unit, you'll see it in all its glory."

Apparently Philips and others are also convinced of the quality of their equipment and of the average consumer's patience—they have put the owner's manual on a medium that is accessible only when the entire system is up and running properly.

Similarly, the Web page displayed on a small LCD telephone display or a Windows CE handheld PC will likely be disappointing when it was designed to be shown on a PC monitor. It is difficult for a universal (software or hardware) platform to accommodate every conceivable target well. Yet the ability to attain the desired result will play a big factor in the eventual success in any of these products.

A variety of TV browsers were shown at Winter CES, with many more to debut in the near future as more companies are attracted by the potential for making money as the service supplier. One hopes the right combination of features, usability, price, service, and content is found before consumers back away from the idea completely and companies shy away from the boneyard. Taking the best name category, WebTV was introduced in October, with 50,000 units reportedly sold already by Sony and Philips (Magnavox), based on MIPS RISC processors. Sega sells a browser as an add-on to its Saturn video game system and is said to have moved 100,000 of

them. Another software provider dedicated to TV viewing, ViewCall America, which is marketing a service called On-TV, was demonstrated in the Hitachi booth, and Mitsubishi is reported to be working with the company.

Oracle Corporation is credited with generating great interest in the latest concept of a network computer, a part of which became the TV browser concept. It spun out Network Computer Inc., which is promoting a platform based on the ARM processor. RCA is one of the best-known consumer names to be bringing out Network Computer's NC version of TV browsers. However, prices from some manufacturers of up to \$500 may indicate a mismatch there. Network Computer's browsers can include a smart card slot so that users can make purchases while online. One supposes that calling the Home Shopping Network with a Touch-Tone phone is rather outdated. Curtis Mathes was showing both an Network Computer-based set-top box as well as a built-in TV browser, which seemed to be higher end than most for the same low price. Akai has a slightly different business model, talking about a TV browser that allows the user to select any ISP.

The following are typical characteristics of the TV browsers coming to market:

- Vendors
  - Sony, Philips, RCA
- Processors
  - IDT R4640 112 MHz, ARM 7500
- Browser services
  - WebTV, On-TV, NetChannel
- Additional features
  - 33.6-Kbps modem, card reader, printer port
- Price
  - \$300-\$500 (keyboard, \$75)

## Information Appliances

The TV browser can be considered only one of many possible information appliances. An information appliance is designed to look and act like a simple household or business appliance performing a dedicated information-oriented function while using digital computer technology and information that might be obtained over the Internet, from a CD, or stored locally. Key to these products are the concepts that the computer workings are completely masked from the user and that the device is not threatening to the average person. The TV browser tends to stretch the definition, as quite a bit of the computer and Web structure can be exposed to the user and it almost looks like a PC (CRT-like screen, box with wires sticking out of it, and keyboard with function keys).

## Diba

Diba Inc. was at CES in the Mitsubishi booth showing demonstrations of its information appliance concepts. Along with a TV browser, Diba was demonstrating a telephone and e-mail unit, a kitchen cooking reference, and a travel guide. Additional concepts shown but not operating were a financial assistant and a telephone directory. Most of these had a small LCD screen and only a few buttons. Especially important to Diba for the success of these devices is their physical appearance and simplicity. Only where necessary are there glimpses of the computer within: there is a QWERTY keyboard for the browser and the e-mail telephone so that letters can be drafted. The financial planner looks like a leather-bound ledger, to fit in with traditional finance tools, and it links to a printer through an infrared interface. The most interesting products are driven by a touch screen and an easy interface. The information is clearly displayed in full color and easily navigated using about three touches to get to the desired data. Some of the units will primarily use a CD-ROM for data, while others may connect to the Internet (some only intermittently to book hotels or download additional/updated information).

Diba is primarily a software house with some very advanced ideas about the Internet appliance and the potential for well-designed information appliances as true consumer products, sold in department stores by salesmen with minimal training and used by common folks using intuitive controls without extensive user manuals. Diba is pulling together hardware, programming, and content partners and can offer almost turnkey service to the OEM that simply wants to produce the appliance. Shelf prices of \$200 to \$300 are expected on the appliances, keeping them in the range of a great number of household budgets. Instead of fitting the model of getting over the hump of a \$2,000 computer purchase before having its many resources available, this fits the appliance model of buying a \$200 device and finding that it is useful enough to make it comfortable to spend another \$300 on a completely different appliance. Many homes have second or third televisions and stereos and telephones, let alone hair dryers, curling irons, and clocks, in various rooms, because the appliance is useful and the price is low enough that an additional one can be used by someone else or where they are most convenient. Low-cost information appliances could follow this trend one day.

Mitsubishi is a key hardware partner, driving the microcomponent development to best support the information appliance designs. At the heart of most of the Diba information appliances is Mitsubishi's M32R/D 32-bit processor with embedded DRAM. Mitsubishi is progressing toward a single-chip integration of essentially all of the microprocessor, memory, and peripheral circuits needed in the platform—something for which it has unique qualifications (see Dataquest's document "Deeply Embedding Microprocessors with DRAM—A Great Marriage," MCRO-WW-DP-9606, December 9, 1996). Diba has engaged with other processor vendors offering its software for such architectures as NEC's V830 and Motorola's 68360 and PowerPC processors.

### **Internet on the Telephone**

Besides Diba, others were talking about information appliances in the form of Internet telephones. These tend to be an exotic telephone with an LCD screen and a compact keyboard to allow directory services, e-mail, or outright Web browsing from the terminal. Last autumn, Nortel talked about such a device, which was Java-driven for the business environment working with the private automatic branch exchange (PABX). Most of the Internet telephones at CES were somewhat more targeted to the home.

Many of the same pros and cons discussed previously apply to these devices: cost, convenience, simplicity, and alternatives will determine the ultimate success of these superphones, with some benefit tipping to the consumer-oriented sales channel that telephones have established. What kind of experience is it to waltz through the Web looking through a 4 x 6-inch monochrome LCD? If looking up phone numbers is simpler or cheaper on an electronic directory, then the idea might sell. Minitel in France has certainly proven that a miniature terminal in every household can have enormous potential, but the government-owned French telephone utility underwrote most of the costs and deployment of that system.

Philips was showing its P200 Screen Phone, which slides a full-size keyboard out from under the sleek telephone set with the LCD screen. A more mundane model seemed to have similar features but looked like the discount store model. Smart card readers on these phones could be used for purchases (when smart cards come to mainstream America) or it might be possible to use swiped long distance cards. A MIPS microprocessor and 1MB to 2MB of ROM, 2MB of RAM, and a 14.4-Kbps modem are central to the phone. Panasonic was showing a Diba-based Internet telephone. Uniden also was showing a browsing telephone, although its origins could not be determined.

## **Additional Show Highlights and Notes**

### **Camcorders for Parents and Kids**

Although new digital camcorders based on the DV standard have now captured over half of the Japanese camcorder market, their expensive price tag has limited them to only 2 to 3 percent of the U.S. camcorder market. As a result, they did not capture as much attention at the show. However, there were product announcements from three companies—JVC, Hitachi, and Tyco Toys—that merit attention.

#### **JVC**

The GR-DVM1D multimedia camcorder from JVC incorporates one of the most popular features on camcorders today, a side-mounted color LCD monitor/viewfinder. This 2.5-inch polycrystalline silicon TFT active matrix monitor includes a special antiglare coating and pixel arrangement that prevents washout problems in bright light. It also produces 400 video lines, compared to 200 lines in conventional camcorder models.

More notable than the actual camcorder is JVC's promotion of a control protocol called Joint Level Interface Protocol (JLIP) that connects personal computers with video equipment and enables operational control through communication. JVC is promoting the incorporation of this system into VHS video equipment, camcorders, and its peripheral equipment. The development of the protocol was based on the following criteria:

- Enable bidirectional equipment control by connecting with personal computers
- Achieve flexible system construction by enabling multiple equipment connection
- Materialize communication via RS-232C (RS-422) by simple connection to a junction box containing a converter to adjust the equipment to computer level
- Facilitate interface design and usage as an interequipment connection control terminal without computers

JVC was demonstrating its new docking station, the GV-DS1, which is based on the JLIP protocol. The benefits of this system and its simplified PC interface were compelling. As more users seek to import their video clips and still images to their multimedia PCs, products that employ the JLIP protocol should gain additional support.

### **Hitachi**

Hitachi announced the introduction of the world's first prototype MPEG camera. This MPEG-1-based system allows for real time compression of full-motion video, which is stored on a PC hard disk. The camera captures images with resolution of 352 x 240 pixels. Compression allows about 20 minutes of video or 300 photographs to be stored on the hard disk. Also, a maximum of four hours of audio can be stored. All of the camera's functions, such as compression and full-motion video playback, are handled by a single chip developed by Hitachi. The chip is produced in a three-layer, 0.5-micron process and uses 500mW of power. The chip also enables high-speed encoding of still images in the JPEG format.

### **Tyco Toys**

For the parents who get nervous when their children start playing with the remote control for the TV, this is the perfect product. For \$99, this black-and-white camera allows kids to shoot their own video programs without placing the family camcorder in mortal danger. This camcorder uses a CMOS sensor from VLSI Vision. This is the same company that is supplying the imaging sensor for the Sound Vision digital camera, the Fisher-Price Creative Effects camera, and the Vivitar MPP2 video phone. The company that brought you Tickle Me Elmo for the 1996 holiday season will be promoting the ColorCam in 1997. Start saving now for the time your child, a budding movie director, starts begging for this \$150 "toy."

## **HDTV**

With the FCC's December passage of a broadcast standard for digital HDTV and advanced television (ATV), TV makers got the green light to show their new, high-definition technologies at CES. The companies showing HDTV technology at CES were all members of the Grand Alliance, a group of companies that banded together to encourage FCC approval of their HDTV broadcast and display technology. Leading the HDTV charge was Zenith, which demonstrated its HDTV-capable Pro 900 projection system at the show. The Pro 900 is capable of displaying both NTSC and HDTV resolution video.

Philips gave a technology demonstration of its HDTV technology, showing a Grand Alliance-compliant HDTV CRT display. The display had an aspect ratio of 16:9 and used the interlaced version of the Grand Alliance display specification with MPEG-2 main level, high-profile compression.

General Instrument also demonstrated HDTV. However, the demonstration was meant to showcase the HDTV interface on its new 4DTV hybrid digital/analog satellite box (see the DBS section above).

## **Data Storage Products Find New Markets**

With the increasingly digital and information-oriented nature of consumer electronics, requirements for storage are growing. Platforms including digital still cameras, digital camcorders, voice recorders, and handheld organizers are using a variety of storage media, including flash memory expansion cards, hard drives, and MiniDiscs.

Flash memory cards were in strong evidence at CES, appearing in numerous digital still camera products (see the digital still camera section above). However, they also appeared in other types of products, including voice recorders and Windows CE-based computers. Examples include the Olympus D1000 digital voice recorder, which replaces magnetic tape with an Intel flash memory Miniature Card. Also, there was the Philips Velo Windows CE handheld PC, which actually has two Miniature Card slots, one for memory expansion, the other for operating system upgrades. Cherry Electrical Products demonstrated a Universal Serial Bus-enabled keyboard with a Miniature Card reader built in that makes it easy to load images and other data into PCs. The Miniature Cards shown at CES typically were 2MB or 4MB flash memory cards, with prices around \$40 for a 2MB card and \$75 for the 4MB version.

Tiny hard disks appeared in some interesting places at CES. Hitachi's MPEG-1 digital camcorder uses a 260MB hard disk in a PCMCIA Type III card that can store up to 20 minutes of video. Canon's PowerShot 600 digital still camera has an optional 170MB hard drive in a Type III PCMCIA card.

MiniDisc made a comeback at CES, this time as a recordable medium for video, audio, and data. Sharp showed several MiniDisc-based products, including a digital still camera. Sony showed a portable MiniDisc recorder/player.



### **Virtual Joystick**

One of the more unusual products shown at CES was the MindDrive, a game control device for PCs that is billed as being responsive to human thoughts. However, rather than reading a person's mind, MindDrive actually works by reading a person's galvanic skin response, similar to the operation of lie detectors. To use the MindDrive, a player inserts his or her finger into a slot. To go right in a game, players relax their minds. To go left, players increase their level of mental activity. MindDrive also seems to move the game in the same direction a player's eyes are looking. A Dataquest analyst's brief try at using the MindDrive at CES showed that the product was responsive to his level of relaxation. However, the analyst could not achieve enough control to score a strike in the MindBowling bowling game. MindDrive is sold by a company called The Other 90% Technologies Inc.

### **CES from the European Point of View**

The nearest European equivalent to the CES is probably the CeBit Home exhibition in Hannover, Germany. Although most European countries hold their own consumer electronic shows, CeBit Home is definitely the largest, as befits the largest consumer market in Europe. Both CES and CeBit cover a vast area (CES is, of course, bigger) and both carry most of the major consumer electronics manufacturers' newest offerings. There are, naturally, differences between the two, as there are between the European and American way of life, Hannover and Las Vegas, and chalk and cheese. However, the main difference is the targeted audiences. CES is aimed at the electronics trade, primarily the retail trade. CeBit Home, on the other hand, is aimed first at the consumer and second at the trade. In fact, most European consumer electronic shows are aimed principally at the consumer. Differences apart, the CES is a good way to test the up-and-coming worldwide trends from the major consumer manufacturers, although care must be taken that America not be read as "the world."

As with its German cousin, CES covered almost the whole range of consumer products and all the ancillary equipment and support products that lie between the borders and on the periphery of consumer electronic products. DVD, as in Europe, continues to take pride of place as the latest innovative offering but is being jostled by Digital Video Broadcast (DVB), Web browsers, and digital video and still cameras in the race to satisfy the consumer's desire for all things digital. All of these products are available in Europe. So where are the product differences noticeable?

Where the United States and Europe diverge most noticeably is in the area of the humble television. The NTSC standard and only 525 lines has been the millstone around the U.S. television industry's neck for years. Those used to the European PAL system are immediately struck by the difference in the quality. Sadly, even the introduction of DVB and DVD will not improve the overall quality to any great degree, as was evident from some of the displays. Wide-screen 16:9 ratio sets are also not on the agenda for the U.S. consumer. Although some manufacturers were showing some 16:9 sets, they

were by way of promoting either their built-in Internet browsers in sets brought directly from Japan or merely as a novelty. Certainly there was no active promotion of the 16:9 format. This differs strongly from Europe, where all the manufacturers, no matter how small, are promoting 16:9 as the future for television. This is especially true with regard to DVB, which in Europe is being pushed by the broadcasters as the natural format for wide-screen programming. Indeed, broadcasters are claiming that over 75 percent of digital transmissions in Europe will be in the 16:9 format. DVD is also being promoted as a natural medium for wide-screen films—something no VHS player can offer, except in the letterbox format. However, the United States does have the prospect of HDTV, which could well use the 16:9 ratio, in the not too distant future—something that Europe may well come to envy over time.

The other main attraction shown by all the TV manufacturers was the introduction of the Internet browser. Interestingly, at CeBit in September 1996, only Sony and Philips were showing an Internet browser, but now all the manufacturers have one, in various degrees of readiness. These are being promoted primarily as an access to the latest news, weather, and program listings. They should prove very successful, as the European experience of Teletext (which shows exactly the same kind of information but doesn't require a set-top box) has been over the last 20 years. Clearly the Internet browsers can display much more information from the World Wide Web and offer the ability to send and receive e-mail, but no one is quite sure if that is what the average consumer wants. Given that with the advent of DVB, exactly the same information could be received via satellite or cable, including downloads of the most popular Web sites, one can only wonder whether the Internet browser might have a very short life.

Apart from TVs and the questionable nature of Internet browsers for the living room, the CES confirms that most of the trends in the consumer electronic market are global. Now all Europe has to do is to introduce high-definition PAL, convert the world to it, enforce 250V electrical supply through the United Nations and, hey presto, a true global standard. One world, one standard, one market.

## **Dataquest Perspective**

Although it is not feasible to report on all the new consumer electronics product introductions at the 1997 Winter CES, this report has attempted to capture the most important products demonstrated at the show. Dataquest remains optimistic that, in spite of the recent stagnation in the consumer electronics market, manufacturers and retailers will be able to deliver new and enhanced products that will generate renewed industry growth. It is the hope of industry participants that this turnaround can take place over the next three quarters so the year can end with a positive holiday selling season. This is a daunting but achievable goal that will depend to a large degree on the aggregate success of the products discussed in this report.

**For More Information...**

Dale Ford, Senior Industry Analyst..... (408) 468-8311  
 Internet address..... dale.ford@dataquest.com  
 Via fax..... (408) 954-1780

The content of this report represents our interpretation and analysis of information generally available to the public or released by responsible individuals in the subject companies, but is not guaranteed as to accuracy or completeness. It does not contain material provided to us in confidence by our clients. Reproduction or disclosure in whole or in part to other parties shall be made upon the written and express consent of Dataquest.  
 ©1997 Dataquest—Reproduction Prohibited

**Dataquest**  
 A Gartner Group Company

Dataquest is a registered trademark of A.C. Nielsen Company

Perspective



## Consumer Multimedia Semiconductors and Applications Worldwide Market Analysis

### DBS "Stars" Shine at Winter CES

---

**Abstract:** *Players in the direct broadcast satellite (DBS) market at the winter Consumer Electronics Show (CES) said strong sales during the Christmas shopping season helped to make 1996 a better year for sales and subscription growth than 1995. DBS set-top box makers and service providers at CES introduced new products designed to add local programming capability to satellite systems. CES also saw the announcement of services and products that bring new types of data access capabilities to satellite dish owners.*

---

*By Jonathan Cassell*

---

### DBS Ends Year on High Note

Despite a widely held perception of slowing in the direct broadcast satellite (DBS) market in 1996, service providers and equipment manufacturers at the winter Consumer Electronics Show (CES) said the number of overall DBS subscriptions and box sales was up, compared to 1995. The larger and better-established service providers—PrimeStar and DirecTV/USSB—saw their rate of new subscriptions decline slightly for the year. However, rapid sales growth for the new EchoStar service more than made up for the slowing sales of the larger services (see Table 1). Many manufacturers and service providers said sales and new subscriptions grew at record levels during the Christmas buying season. Attracted by aggressive promotions that cut the price tag of DBS boxes to as low as \$199, \$149, and even \$99, consumers snapped up DBS boxes used with the DirecTV, USSB, and EchoStar systems.

DirecTV said December 1996 was its strongest sales month ever, with 165,000 new subscribers, 30 percent better than its previous record, which was in September. EchoStar added 65,000 subscribers in December, also a monthly record for the service.

---

#### Dataquest

Program: Consumer Multimedia Semiconductors and Applications Worldwide

Product Code: MSAM-WW-DP-9701

Publication Date: January 27, 1997

Filing: Perspective

(For Cross-Technology, file in the Semiconductor Application Markets, Volume 2, binder)

FILE COPY:  
MARIA VALENZUELA

**Table 1**  
**DBS Service Subscription Announcements at CES**

Service/Manufacturer	New 1995 Subscriptions	New 1996 Subscriptions	Year-to-Year Growth (%)	Total Sales/Subscribers
Total DSS (DirecTV and USSB)	1,200,000	1,100,000	-8.4	2,300,000
EchoStar	-	350,000	-	350,000
PrimeStar	800,000	700,000	-12.5	1,700,000
AlphaStar	-	28,000	-	28,000
Total	2,000,000	2,178,000	8.9	4,378,000

Source: Dataquest (January 1996)

Makers of DBS boxes did even better in 1996, as they reported strong sales to dealers. Thomson Consumer Electronics at CES said dealers in 1996 bought 2 million of its Digital Satellite System (DSS) set-top boxes, which are used to access the DirecTV/USSB services. That is nearly double the number of new subscriptions for DirecTV/USSB, meaning that a great many DSS boxes are waiting in dealer warehouses in anticipation of future sales growth.

However, the success of DBS in 1996 has not been without its costs. Like the cellular phone business, DBS boxes in 1996 became a market where money is made on sales of services—the low-priced equipment itself generates no revenue. Consumer electronics retailers at CES expressed concern that falling prices are causing profits to evaporate. Some in the industry have fretted that satellite set-top boxes will be free by the end of 1997.

## **CES Showcases New Products, Services**

DBS makers and service providers used CES to introduce new products and services that fill some vital gaps in the business. Several companies announced new boxes that use various technologies to receive local channels. Lack of local channel support has been a thorn in the side of the DBS industry. Many DBS buyers have retained their cable subscriptions rather than risk missing out on local affiliates, while other consumers have been scared away from the product altogether.

The satellite players at CES also announced new data systems that bring a broadcast-oriented model to data access. The new buzzwords for the DBS market are "the roof-top modem," that is, data access using satellites and roof-top receiver dishes. This new emphasis on data access provides new competition for the emerging markets for cable modems and digital cable set-top boxes. Meanwhile, DBS service providers at CES said they are seeking to expand their services, launching new satellites to increase the number of channels they can broadcast.

### **EchoStar**

EchoStar at CES showed its new EchoStar 5000, a DBS box that seamlessly integrates satellite and local channel access. The EchoStar 5000 has two separate tuners that allow it to receive satellite channels through its dish as

well as to accept local channels through an antenna or via a cable line. The box features an electronic programming guide that viewers can use to choose either satellite or local channels simply by selecting them from an on-screen menu. Many competitive DBS boxes require viewers to switch inputs on their television sets before they can move between satellite and local programming. The EchoStar 5000 box will be available in February at a price of \$500. EchoStar, which has already has two satellites in orbit, said it will launch its third satellite in the fall and its fourth in the first quarter of 1998.

### **PrimeStar**

PrimeStar, the granddaddy of all the digital satellite services, is taking a similar direction toward incorporating local programming into its offerings. The company announced plans to offer a set-top box in the third quarter that can accept both cable and satellite input. The box would be PrimeStar's first to use high-power satellite broadcast technology, which will enable subscribers to receive programming with the small 18-inch dishes employed by other DBS providers rather than the 36- and 27-inch antennas the service has used historically. The new product and service also will use MPEG-2 video rather than the DigiCipher technology now employed for the PrimeStar system. The box will be part of a new service—separate from PrimeStar's present entertainment offerings—that is intended to complement cable with 70 to 80 satellite channels.

PrimeStar also plans to offer a new medium-power service starting in April that will increase the number of channels it offers to 160, up from 95 now. The company said the new service will attract as many as 750,000 new subscribers to its fold. Besides the additional channels, the new service will have a feature that PrimeStar claims will give it a major advantage over the competition. Details were not provided, but Dataquest believes the new service will involve the use of an advanced electronic programming guide.

### **DirecTV**

The largest of the satellite services, DirecTV, said it will accommodate local content using a secondary "off-air" antenna that will receive broadcasts. The secondary antenna will sit beside the satellite dish on the roof, allowing the DSS-type boxes used with its system to receive local channels. The system will be compatible with the installed base of DSS systems, regardless of their manufacturer, and will be available in the second half of 1997, DirecTV said.

DirecTV also announced a new technology designed to bring data and television broadcast into the PC. The new technology, dubbed DSS-PC, will enhance DirecTV's existing television service with text and graphics. The receiver for DSS-PC will reside on PCI-based PC add-in cards that will be available in the fourth quarter for an undisclosed price. The cards will be built by Hughes Network Systems, ComStream, and Adaptec and will include ComStream-built tuners and VLSI Technology Inc.-made encryption chips. DirecTV already is offering a satellite data service, called DirecPC, which is designed to give PCs high-speed Internet access. However, DSS-PC is not intended to be an Internet access service. Rather, it is designed to be a data broadcast system, sending prescheduled data dumps to PCs. Examples

of such data services include stock and sports tickers and "near data on demand," where software and information are broadcast at regular intervals to anyone who cares to receive them. Data will move at rates ranging from 100 Kbps to 4 Mbps.

DirecTV also said it plans to extend its highly successful \$200 cash-back deal on DBS boxes through the end of February.

### **USSB**

DirecTV's DSS partner, USSB, also expressed its support for receiving local content using an off-air antenna. USSB said it expects most of its customers to use the off-air antenna rather than keep cable to retain local programming. The company released the results of a survey at CES that indicated that 63 percent of its subscribers use an interior or exterior antenna to receive local broadcasts, rather than using cable. The survey also said that more than 80 percent of USSB subscribers drop cable within eight weeks of beginning satellite service.

### **Thomson Consumer Electronics**

Thomson Consumer at CES said it is considering offering a dual cable/satellite tuner box similar to EchoStar's. The company said it also was studying other options for providing local content. Thomson is the leading DBS set-top box maker and accounts for the majority of sales of the DSS boxes used with the DirecTV and USSB services. The company plans to offer its third-generation DSS box in March 1997. The third-generation box will include a high-speed data interface that will allow it to link with other equipment, possibly including HDTV receivers. The company said it will introduce its fourth-generation box in 1998.

### **Hitachi**

Hitachi at CES showed its first DSS box, which is being built by Hughes Network Systems. Hitachi's second-generation box, which will be introduced in the summer, will include a 50-Mbps interface derived from IEEE 1394 that is intended to link it with the company's new D-VHS digital VCR.

### **Hughes Network Systems**

Hughes Network Systems (HNS), which is a unit of the same company that owns the DirecTV service, announced its support of the DirecTV DSS/PC technology. HNS plans to offer a DSS-PC card by late 1997, in time for the Christmas selling season. To support the continued integration of PC and satellite television technologies, Hughes introduced what it is calling the "convergence antenna," a satellite dish that can be used to receive both television and data signals from satellites. Scheduled to begin selling in April, the convergence antenna is designed to accept signals from two separate satellite services. The antenna has two low-noise block downconverters (LNBS), as well as three coaxial cables running out from it, two for a DSS box and one for the PC add-in card. Hughes said the antenna can be used for DirecTV, DirecPC, and the new DSS/PC services. Hughes would not give a price for the new product.

**General Instrument**

While DBS has been hot, analog satellite customers have been left out in the cold. Analog satellite dish owners have been excluded from the explosion of new channels and services available to digital subscribers. At CES, General Instrument introduced the 4DTV box, a combination analog/digital satellite box that allows owners of analog satellite dishes to access digital programming from the PrimeStar digital service.

4DTV is intended to bridge the gap between analog and digital, enabling users to access virtually every analog satellite broadcast available and, giving them a choice of 750 channels among which to surf. 4DTV also has a built-in high-speed link that is suitable for HDTV data rates.

**Emc3**

Emc3 at CES unveiled its electronic digital delivery (EDD) technology that accelerates the sending of video data to speeds much faster than real time. Intended for video on demand, EDD can be used in cable, satellite, and telephony systems. Using a combination of time and space compression, EDD allows a two-hour movie to be downloaded in only 10 minutes.

**Dataquest Perspective**

In 1996, the DBS market enjoyed booming growth as price cuts attracted hoards of new subscribers. At CES, satellite television service providers and DBS set-top box makers showed new products that are designed to keep the momentum rolling in 1997. DBS players are overcoming what has been the biggest shortcoming of their product by providing new equipment and services that give subscribers access to local content. Furthermore, the DBS industry is adding a new wrinkle by offering data access services that complement their core business in television entertainment.



**For More Information...**

Jonathan Cassell, Industry Analyst ..... (408) 468-8195

Internet address .....jcassell@dataquest.com

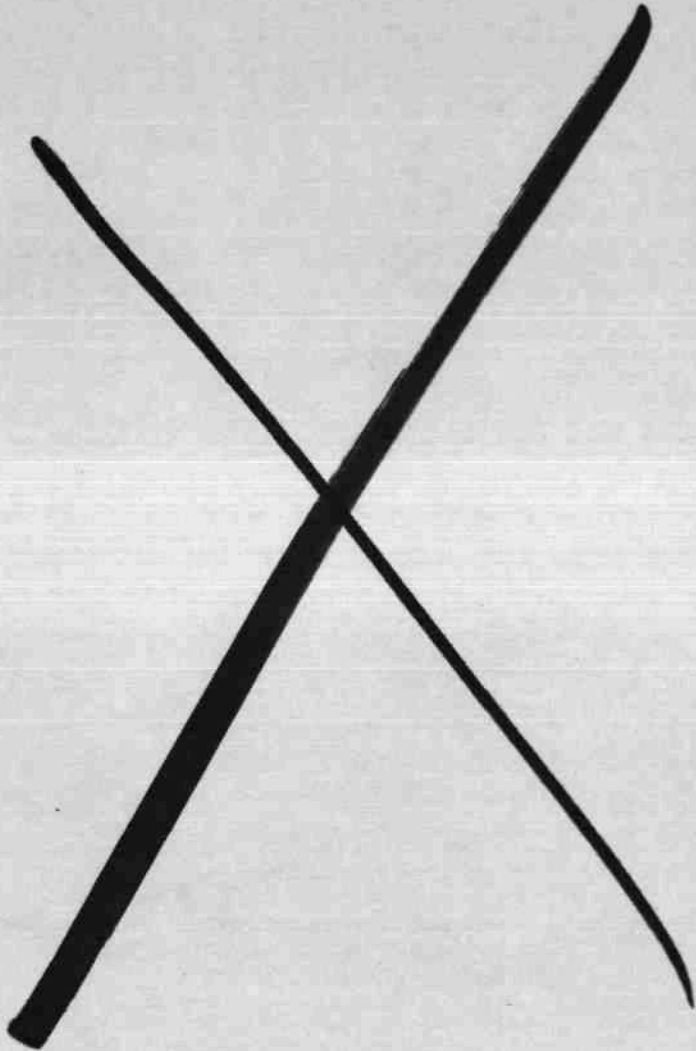
Via fax..... (408) 954-1780

The content of this report represents our interpretation and analysis of information generally available to the public or released by responsible individuals in the subject companies, but is not guaranteed as to accuracy or completeness. It does not contain material provided to us in confidence by our clients. Reproduction or disclosure in whole or in part to other parties shall be made upon the written and express consent of Dataquest.

©1997 Dataquest—Reproduction Prohibited

Dataquest is a registered trademark of A.C. Nielsen Company

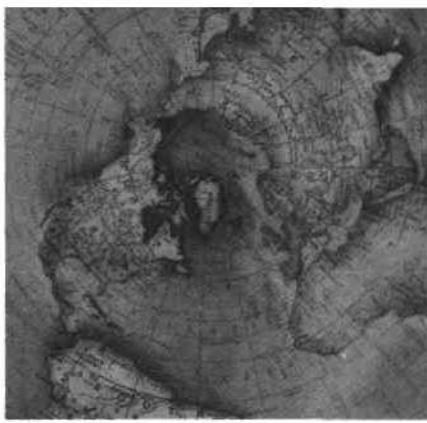
**Dataquest**  
A Gartner Group Company



**Dataquest**



**Market Trends**



FILE COPY:  
MARIA VALENZUELA

# Dataquest

## **Video, Interactive, and Personal Electronics Semiconductor Market Trends**



### Market Trends

---

**Program:** Consumer Multimedia Semiconductors and Applications Worldwide  
**Product Code:** MSAM-WW-MT-9704  
**Publication Date:** December 15, 1997  
**Filing:** Market Trends

# **Video, Interactive, and Personal Electronics Semiconductor Market Trends**



**Market Trends**

---

**Program:** Consumer Multimedia Semiconductors and Applications Worldwide  
**Product Code:** MSAM-WW-MT-9704  
**Publication Date:** December 15, 1997  
**Filing:** Market Trends

## Table of Contents

---

	Page
1. Executive Summary .....	1
2. Video Equipment .....	3
Methodology .....	3
Video Equipment Reigns as King of the Consumer Hill .....	4
Market Trends .....	8
Color Television .....	9
VCRs .....	16
Camcorders .....	21
Market Trends .....	22
Analog Camcorders .....	22
Digital Camcorders .....	26
Brand Share Leaders .....	29
DTV .....	30
U.S. DTV's New Challenges .....	31
DTV in Other Regions .....	35
DVD Video Players .....	35
Video CD Players .....	40
3. Interactive Products and Personal Electronics .....	43
Interactive Television and Set-Top Box Definitions .....	43
Markets for Subscriber Terminals .....	45
Production and Market Forecast .....	45
Technology Requirements .....	51
Manufacturers .....	52
Interactive Video Games .....	54
Cameras, Watches, and Clocks .....	61

## List of Figures

Figure	Page
2-1 Worldwide Video Equipment Production Revenue Forecast .....	5
2-2 Regional Share of Video Equipment Production Revenue.....	6
2-3 Americas Video Equipment Production Revenue Forecast .....	6
2-4 U.S. Household Penetration of Video Products .....	9
2-5 Worldwide Color Television Production Revenue and Unit Shipment Forecast .....	10
2-6 Regional Share of Color Television Production Revenue .....	11
2-7 U.S. Color Television Sales by Screen Size for 1996.....	12
2-8 U.S. Television Sales by Type for 1996.....	12
2-9 Block Diagram of Multifunction, High-Performance Color TV .....	15
2-10 Worldwide VCR Production Forecast .....	17
2-11 Regional Share of VCR Production Revenue .....	18
2-12 Block Diagram of a Typical VCR.....	20
2-13 Regional Share of Analog Camcorder Production Revenue .....	21
2-14 Block Diagram of a Typical Analog Camcorder.....	25
2-15 Regional Share of Digital Camcorder Production Revenue .....	27
2-16 Block Diagram of a Typical Digital Camcorder .....	28
2-17 Worldwide DTV Receiver Production Forecast .....	30
2-18 Worldwide DVD Video Player Production Forecast .....	37
2-19 Representative DVD-ROM Video Player Block Diagram.....	39
2-20 Worldwide Video CD Player Production Forecast .....	41
2-21 Block Diagram of a Representative Video CD System.....	41
3-1 Interactive Television Systems Block Diagram .....	44
3-2 Regional Share of Analog Set-Top Box Production Revenue .....	48
3-3 Worldwide Digital Set-Top Box Production Forecast.....	49
3-4 Worldwide Digital Set-Top Box Average Selling Price Forecast.....	49
3-5 Worldwide Digital Set-Top Box Factory Revenue Forecast.....	50
3-6 Regional Share of Digital Set-Top Box Production Revenue.....	50
3-7 Block Diagram of a Typical CATV/DBS Set-Top Box .....	51
3-8 Worldwide Video Game Controller Production Forecast.....	55
3-9 Worldwide Video Game Controller Production Forecast by Type ..	56
3-10 Regional Share of Video Game Controller Production Revenue.....	57
3-11 Worldwide Video Game Controller Market Share, 1996 .....	57
3-12 Generic Block Diagram of RISC Video Game Controller .....	60

## List of Tables

Table	Page
2-1 Worldwide Video Equipment Production Revenue Forecast.....	5
2-2 Americas Video Equipment Production Revenue Forecast.....	7
2-3 North American Video R&D and Manufacturing.....	7
2-4 Worldwide Color Television Production Forecast.....	10
2-5 Americas Color Television Market Forecast.....	11
2-6 Americas Color Television Production Forecast.....	11
2-7 U.S. Color Television Brand Share Leaders, Q1/95 to Q4/95.....	13
2-8 U.S. Color Television Brand Share Leaders, Q1/96 to Q4/96.....	13
2-9 Worldwide VCR Production Forecast.....	17
2-10 Americas VCR Market Forecast.....	18
2-11 Americas VCR Production Forecast.....	18
2-12 U.S. VCR Brand Share Leaders, Q1/95 to Q4/95.....	19
2-13 U.S. VCR Brand Share Leaders, Q1/96 to Q4/96.....	19
2-14 Worldwide Analog Camcorder Production Forecast.....	23
2-15 Americas Analog Camcorder Market Forecast.....	23
2-16 Americas Camcorder Production Forecast.....	23
2-17 Worldwide Digital Camcorder Production Forecast.....	26
2-18 Americas Digital Camcorder Market Forecast.....	27
2-19 U.S. Camcorder Brand Share Leaders, Q1/95 to Q4/95.....	29
2-20 U.S. Camcorder Brand Share Leaders, Q1/96 to Q4/96.....	29
2-21 Worldwide DTV Receiver Production Forecast.....	31
2-22 Americas DTV Receiver Market Forecast.....	31
2-23 Americas DTV Receiver Production Forecast.....	31
2-24 U.S. ATSC DTV Specification.....	32
2-25 DTV Team HD-0 Specification.....	34
2-26 DVB 1.0 Specification.....	35
2-27 Worldwide DVD Video Player Production Forecast.....	38
2-28 Worldwide Video CD Player Production Forecast.....	40
3-1 Descriptions of Various Products Referred to as "Set-Top Boxes" ..	43
3-2 Worldwide Analog Cable/Satellite Set-Top Box Production Forecast.....	46
3-3 Americas Analog Cable/Satellite Set-Top Box Market Forecast.....	46
3-4 Americas Analog Cable/Satellite Set-Top Box Production Forecast.....	46
3-5 Worldwide Digital Cable/Satellite Set-Top Box Production Forecast.....	47
3-6 Americas Digital Cable/Satellite Set-Top Box Market Forecast.....	47
3-7 Americas Digital Cable/Satellite Set-Top Box Production Forecast.....	48
3-8 Semiconductor Opportunities in Interactive TV.....	52
3-9 Interactive Digital Set-Top Box Technology Evolution.....	53
3-10 Worldwide Digital Cable and Satellite Decoder Revenue Market Share, 1995.....	53

## List of Tables (Continued)

---

Table	Page
3-11 Worldwide Digital Cable and Satellite Decoder Revenue Market Share, 1996.....	54
3-12 Worldwide Video Game Controller Production Forecast.....	55
3-13 Worldwide Video Game Controller Production Forecast by Type..	56
3-14 Americas Video Game Controller Production Forecast.....	56
3-15 Americas Revenue from Production of Cameras, Watches, and Clocks .....	61



## Chapter 1

# Executive Summary

---

This document examines market trends in consumer electronics video equipment, interactive products and personal electronics. Video equipment is the largest segment of the consumer electronics market and is a major driver of semiconductor volume and technology. DVD Video players will be the fastest-growing product in the video equipment area over the next five years. The Asia/Pacific region has emerged as the largest region for video equipment production and will remain so through the year 2001.

Information provided in the report includes the following:

- A description and review of video equipment manufacturing facilities and developments in the Americas over the last 12 months
- Penetration rates for various types of video equipment in the United States
- Production forecasts, market reviews, news, and technology descriptions for color televisions, VCRs, digital television (DTV), camcorders, Digital Versatile Disc (DVD) players, Video CD players, analog cable and satellite boxes, digital cable and satellite cable satellites, video game controllers, cameras, watches, and clocks

Among the conclusions in the report are the following:

- The entire video equipment market will experience a 4.3 percent compound annual growth rate (CAGR) in production revenue from 1996 to 2001. Production revenue will grow to \$62.3 billion in 2001, up from \$50.5 billion in 1996.
- Color television production revenue will increase at a rate of only 3.2 percent from 1996 to 2001.
- Facing competition from new DVD Video players, worldwide VCR production revenue will fall 6.6 percent from 1996 to 2001.
- Worldwide analog camcorder production will fall by 9.2 percent from 1996 to 2001, while digital camcorder production will increase 22.3 percent.
- Digital satellite and cable set-top box receiver production will increase by 245 percent and 12.3 percent, respectively, from 1996 to 2001.

*Project Analysts: Dale Ford and Jonathan Cassell*

## Chapter 2

# Video Equipment

---

### Methodology

The consumer electronics semiconductor application market will be examined in three separate Dataquest documents covering the following topics:

- Home appliance and automation application markets
- Audio applications market
- Video, interactive, and personal electronic application markets

This document provides reference information and analysis about the video, interactive, and personal electronic application markets for semiconductors. It brings forth basic information about the opportunity offered by particular systems:

- System market size (in production terms) in factory revenue, units, and average selling price (ASP)
- System, market, and technology trends
- Semiconductor device opportunities, content, and market forecast
- A listing of key OEMs

The information in this report is gathered from both primary and secondary sources. Primary sources include surveys and interviews of industry vendors and customers, as well as analyst knowledge and opinion. Some of the primary sources include Dataquest's own industry services. Secondary sources include various government and trade sources on sales, production, trade, and public spending. Semiconductor content assumptions are based both on surveys of producing OEMs and physical teardown evaluations of representative systems by Dataquest analysts.

The brand share information presented in this book comes from *The Scout Report*<sup>®</sup> of The Polk Company. *The Scout Report*<sup>®</sup> has been designed to accurately measure the retail purchase activity of U.S. households. Based on a widely accepted survey methodology, the sample is drawn quarterly from a nationally representative group of 50,000 respondents, and response rates average 70 percent. Brand shares reported in *The Scout Report*<sup>®</sup> are point estimates of the actual brand shares and have a small margin of error. Brand shares are based on a representation of retail sales to end-use consumers in the United States and may not correspond directly to other commonly reported measures of product movement such as production or wholesale shipments.

The forecast methodology is based on various methods and assumptions, depending upon the area. To form a solid basis for projecting system demand, capital, government, and consumer spending assumptions are made for various regions of the world. For specific markets, saturation and displacement dynamics are considered as well. Key exogenous factors such as new software introductions, exchange rate changes, and government policies also are considered. Semiconductor content forecasts are based on interviews of system marketers and designers (including makers of enabling semiconductor technology) along with an analysis of historical trends.

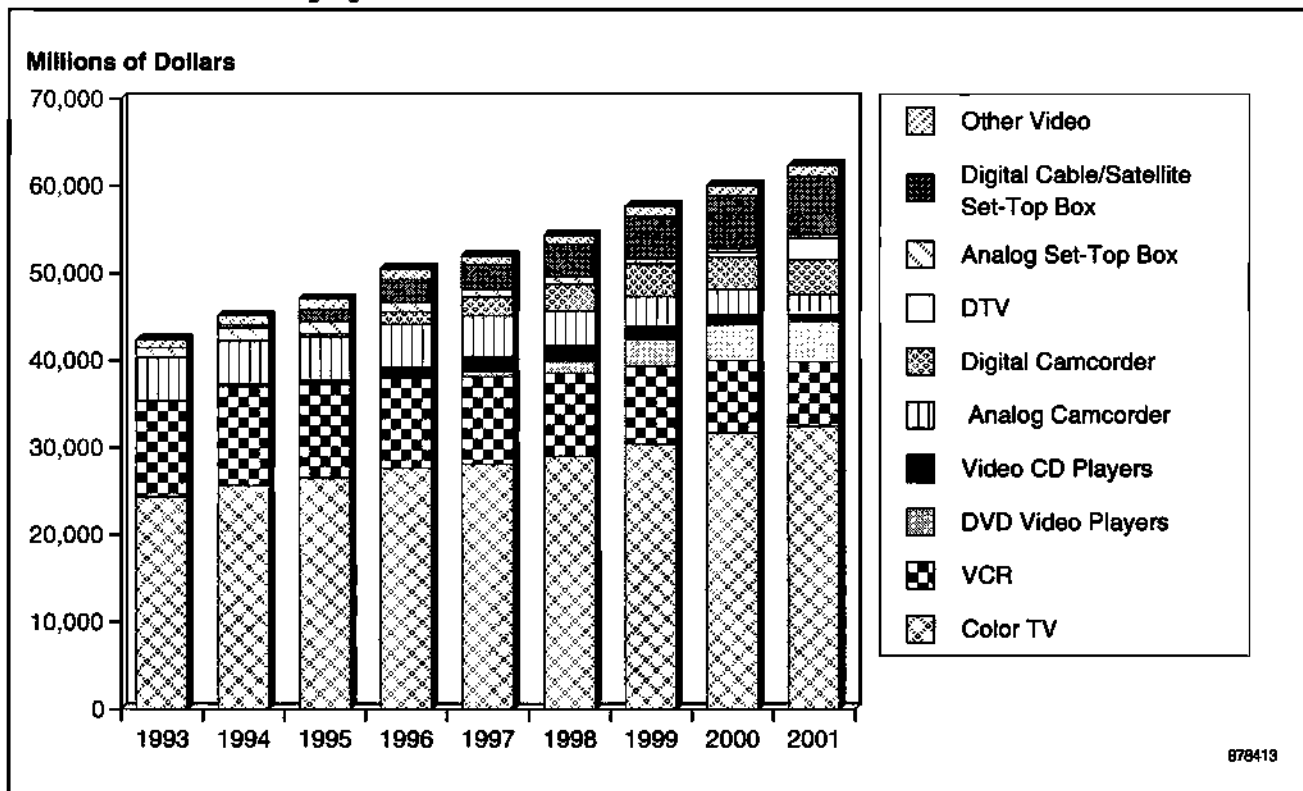
## Video Equipment Reigns as King of the Consumer Hill

Video equipment represents the single-largest segment of the consumer electronics market, with nearly 45 percent of all equipment sales in 1996. Video has attained its dominating size because it is positioned in the consumer market as entertainment equipment. Home use of entertainment equipment assures wide market penetration because it is less affected or impeded by social and cultural barriers. Video equipment demand potentially covers the entire world and grows with the economic development in each country.

The dynamic of supply and demand for video products has served to ensure continued growth in the market. Establishment of video equipment production bases in the areas offering low-cost labor has helped expand regional economies, which in turn has created the economic base that stimulates video equipment demand. Video has been serving as a technology and volume driver for the electronics equipment and semiconductor industries. It has spurred the development and commercialization of numerous production technologies and systems, which have also promoted the growth of industries that supply necessary components and materials. Because of this, video products represent the largest segment of the consumer electronics chip market, accounting for close to 45 percent of consumption in 1996.

Figure 2-1 and Table 2-1 show the anticipated worldwide growth forecast of video equipment production revenue. The CAGR for the next five years in video equipment is expected to be 4.3 percent. Leading the way in the video products market will be DVD Video players, which will experience a 177 percent CAGR from 1996 through 2001. Japan has already shifted a significant portion of its production of video equipment to the Asia/Pacific, making that region the dominant area for manufacturing of TVs, VCRs, and other devices. As illustrated in Figure 2-2, the Asia/Pacific region will continue to increase its portion of worldwide video equipment products, with the percentage of manufacturing there increasing to 38 percent in 2001, up from 36 percent in 1996. The forecast for Americas video equipment production is given in Figure 2-3 and Table 2-2. Although color televisions represent the dominant slice of revenue production in the Americas, new technology developments are pushing production rates of VCRs and set-top boxes to much higher levels. The "other video" equipment category includes items such as LCD TV, black-and-white TV, video accessories, and various emerging products. Table 2-3 lists major North American video research and design and manufacturing locations.

**Figure 2-1**  
**Worldwide Video Equipment Production Revenue Forecast**



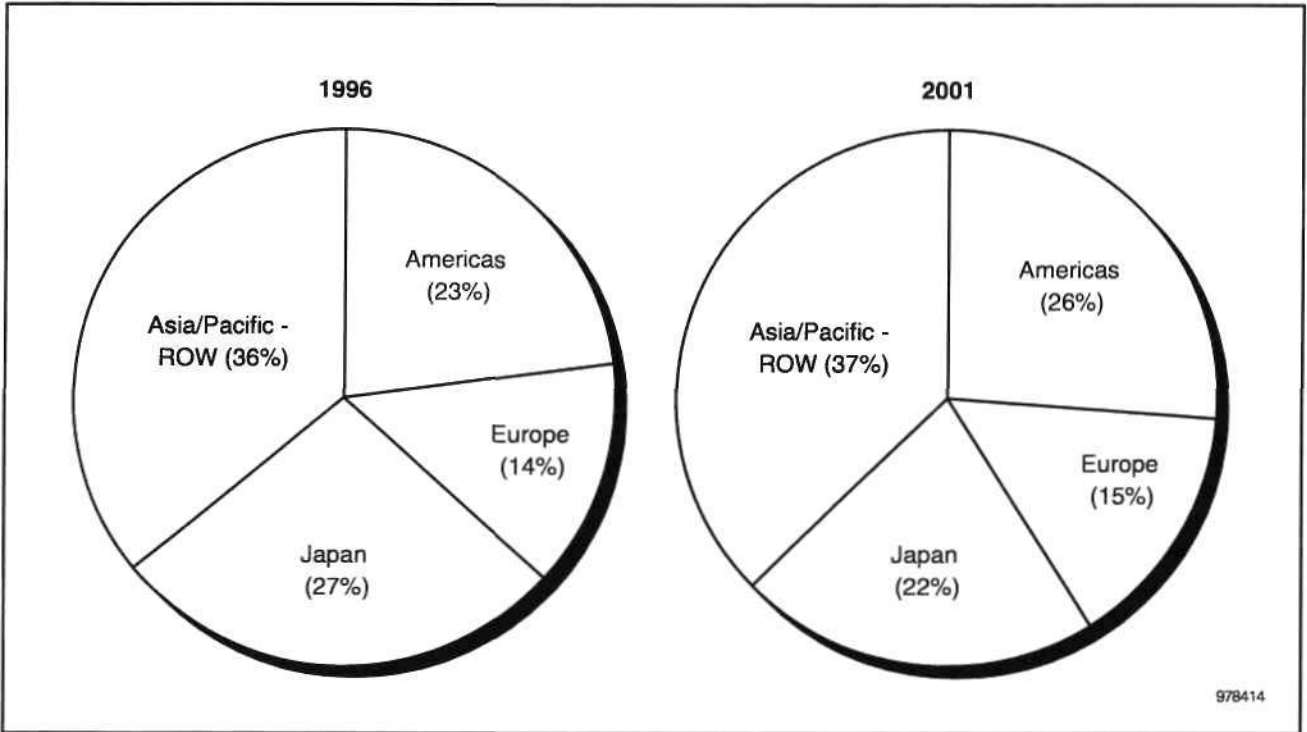
Source: Dataquest (November 1997)

**Table 2-1**  
**Worldwide Video Equipment Production Revenue Forecast**

Segment	1993	1994	1995	1996	1997	1998	1999	2000	2001	CAGR (%) 1996-2001
Color TV	24,343	25,689	26,503	27,677	28,111	29,033	30,427	31,734	32,468	3.2
VCR	11,010	11,331	10,742	10,305	10,015	9,517	8,934	8,264	7,339	-6.6
DVD-Video Players	0	0	0	29	615	1,423	3,055	4,089	4,654	177.0
Video-CD Players	17	242	497	1,204	1,725	1,806	1,500	1,225	780	-8.3
Analog Camcorder	4,984	4,931	5,002	4,921	4,696	3,922	3,430	2,891	2,288	-14.2
Digital Camcorder	0	124	346	1,472	2,091	3,091	3,704	3,675	4,027	22.3
DTV	0	0	0	0	0	6	68	544	2,415	-
Analog Set-Top Boxes	1,104	1,382	1,313	1,135	956	791	538	471	409	-18.5
Digital Cable/Satellite Set-Top Boxes	8	421	1,390	2,509	2,772	3,769	4,952	5,961	6,710	21.7
Other Video	910	1,020	1,250	1,273	1,000	1,000	1,100	1,200	1,250	-0.4
<b>Total</b>	<b>42,377</b>	<b>45,139</b>	<b>47,043</b>	<b>50,525</b>	<b>51,982</b>	<b>54,357</b>	<b>57,708</b>	<b>60,055</b>	<b>62,340</b>	<b>4.3</b>

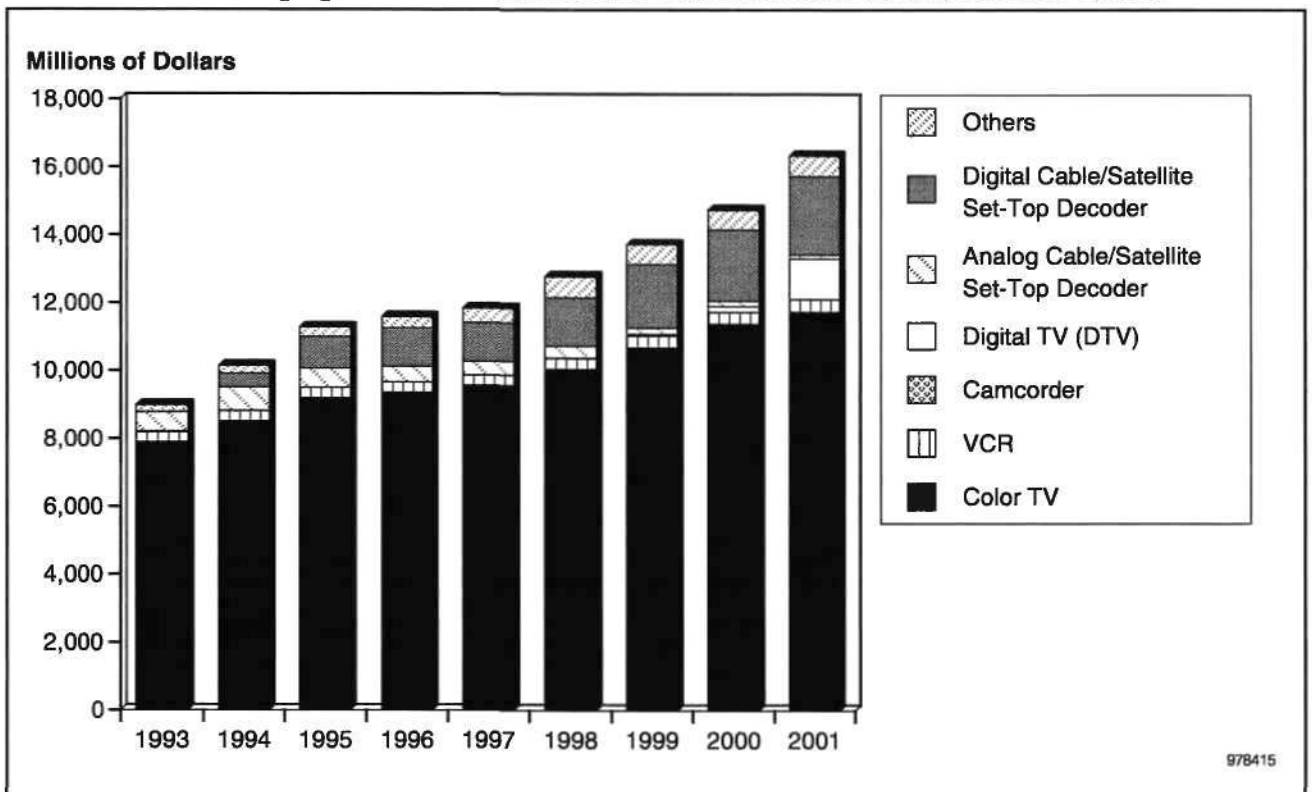
Source: Dataquest (November 1997)

**Figure 2-2**  
**Regional Share of Video Equipment Production Revenue**



Source: Dataquest (November 1997)

**Figure 2-3**  
**Americas Video Equipment Production Revenue Forecast (Millions of Dollars)**



Source: Dataquest (November 1997)

**Table 2-2**  
**Americas Video Equipment Production Revenue Forecast (Millions of Dollars)**

Segment	1993	1994	1995	1996	1997	1998	1999	2000	2001	CAGR (%) 1996-2001
Color TV	7,894	8,507	9,183	9,356	9,570	10,053	10,685	11,381	11,731	4.6
VCR	292	305	313	307	303	319	343	355	378	4.2
Camcorder	31	8	0	0	0	0	0	0	0	NA
Digital TV (DTV)	0	0	0	0	0	3	47	170	1,194	NA
Analog Cable/Satellite Set-Top Decoder	556	689	570	462	401	353	190	154	121	-23.6
Digital Cable/Satellite Set-Top Decoder	7	407	930	1,128	1,139	1,435	1,876	2,103	2,312	15.4
Other	201	230	279	329	429	612	584	578	600	12.8
<b>Total</b>	<b>8,981</b>	<b>10,146</b>	<b>11,274</b>	<b>11,582</b>	<b>11,841</b>	<b>12,774</b>	<b>13,725</b>	<b>14,741</b>	<b>16,336</b>	<b>7.1</b>

NA = Not applicable

Source: Dataquest (November 1997)

**Table 2-3**  
**North American Video R&D and Manufacturing**

Company	R&D Center Location	Manufacturing Location
Curtis Mathes	Dallas, Texas	McDonald Technologies, Carrollton, Texas Dallas, Texas (assembly)
Daewoo	-	Sonora, Mexico
Emerson	North Bergen, New Jersey	-
Hitachi	-	Greenville, South Carolina
JVC (Matsushita)	-	Tijuana, Mexico
LG Electronics	-	Mexico
Matsushita	-	Mexico
Mitsubishi	Braselton, Georgia, Santa Ana, California, Orange County, California	Somerset, New Jersey; Costa Mesa, California; Braselton, Georgia; Santa Ana, California (closed at end of 1997); Mexicali, Mexico;
Philips	Atlanta, Georgia	Mexico
Samsung	-	Tijuana, Mexico
Sony	San Diego, California, San Jose, California	San Diego, California; Baja California, Mexico
Thomson Multimedia	Indianapolis, Indiana	Bloomington, Indiana (will close in 1998); Ottawa, Ohio; Pennsylvania; Juarez, Mexico
Zenith (LG Electronics)	Glenview, Illinois	Melrose Park, Illinois; Chihuahua, Mexico; Juarez, Mexico

Source: Dataquest (November 1997)

The following discusses major announcements related to video R&D and manufacturing investments in the Americas.

- Thomson Consumer in February said it will shut down its color television manufacturing plant in Bloomington, Indiana, the largest such facility in North America. Production at the plant will be phased out through April, 1998, and all operations will be transferred to Juarez, Mexico. Thomson said it was forced to end production at the Bloomington plant by plunging prices in the U.S. color television market, which made manufacturing in Indiana uneconomical. The closing announcement came as some surprise, given that the Bloomington plant was considered a highly advanced facility. The plant also is producing large-screen and projection color televisions, which represent the fastest-growing portion of the TV market. Thomson had been expected to manufacture next-generation digital television receivers at the site, as well. Thomson in February also announced it would shut down production of color televisions at its plant in Prescott, Ontario.
- Mitsubishi in February said it will shut down its projection television plant in Santa Ana, California, and move production to Mexicali, Mexico. The move, which is expected to be completed at the end of 1997, was described as a cost-saving measure by Mitsubishi.
- Philips in May sold its Greenville, Tennessee-based color television plant, which produces about 1.2 million sets per year. Philips will continue to source televisions for the next three years from the plant's new owner, GC Capital. The sale was part of general move by Philips to sell off all its U.S. manufacturing resources and to move production to Mexico.
- Sony in August announced it will expand its Center for Engineering and Development in San Diego. At the center, Sony will develop high-definition television sets. Sony has produced 15 million television sets and 30 million picture tubes in San Diego since establishing a plant there in 1972.

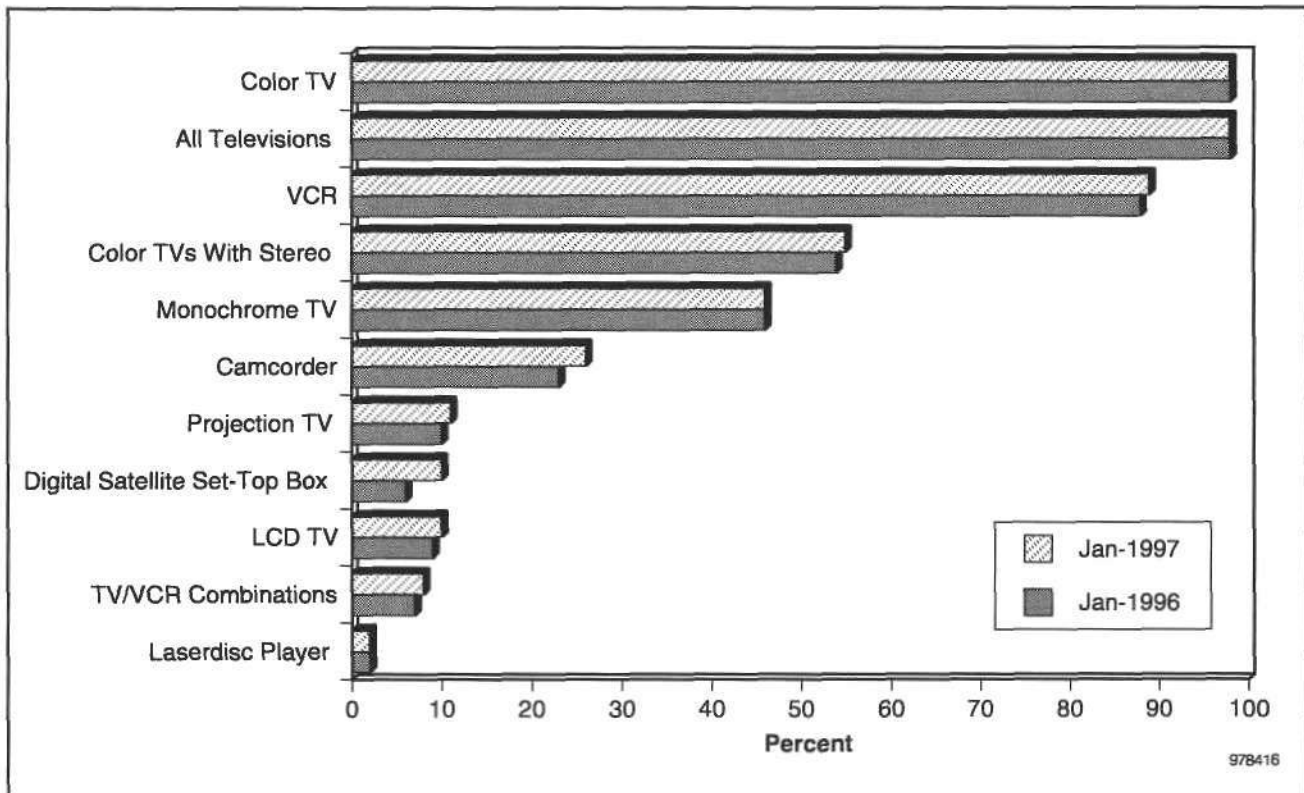
## Market Trends

Today, worldwide video equipment demand is stratified by the following distinguishable levels:

- Replacement and additional purchase demand in industrialized countries, where the first-time buyer market is nearing a saturation point
- First-time purchase for low-end and low-cost products, particularly in developing regions
- Demand for hybrid products, such as TV/VCR combinations
- Demand for next-generation video equipment, including wide-screen TV, HDTV, DVD, and Video CD players

As shown in Figure 2-4, color TVs and VCRs are now found in almost all U.S. homes. The majority of homes in the United States and Canada have more than one TV, and many families have more than one VCR. Most purchases in these categories are for replacement or upgrade of existing products.

**Figure 2-4**  
**U.S. Household Penetration of Video Products**



Source: Dataquest (November 1997)

Despite favorable economic conditions and considerable price reductions for large screen sets in the United States, television sales growth in America has stalled. A combination of factors has contributed to poor sales, including saturation and fear that DTV will make conventional analog sets obsolete. Much of this recent slowing has been balanced by worldwide demand for new, digital video technologies, such as direct broadcast satellite (DBS) receivers, DVD players, and Video CD players. The following sections provide more detailed discussion of the high-volume video equipment—color TVs, VCRs, and camcorders. Emerging opportunities in DTV, Video CD, and DVD also are discussed at the end of this chapter. Detailed information on analog and digital set-top boxes is presented in Chapter 5, where interactive products are discussed.

## Color Television

Table 2-4 and Figure 2-5 present the worldwide color television production forecast. Most major color TV producers are locating the manufacturing of color TVs closer to the region where they are consumed. As shown in Figure 2-6, Asia/Pacific is the leading region for television production, with 33.3 percent of TV manufacturing revenue in 1996, growing to 33.8 percent in 2001. Production in the Asia/Pacific over the next few years will be slower than had been previously expected. Overproduction in China led to swelling inventories, causing a revision in the government's approach to television manufacturing plans. By late 1996, Chinese television manufacturing had begun to rebound. Tables 2-5 and 2-6 show the Americas color TV market and production forecast, respectively.



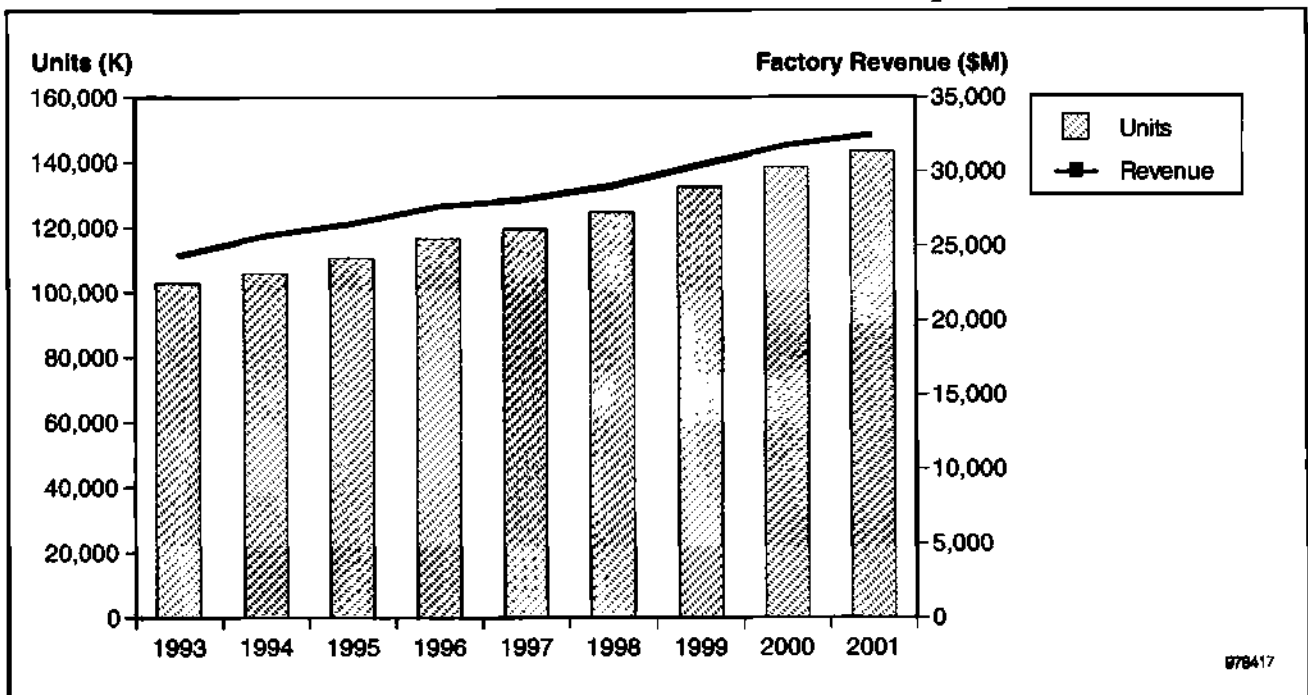
Figures 2-7 and 2-8 show the sales mix of color TVs sold in the United States. Magnavox was the leading brand in the United States during 1996, displacing RCA. Tables 2-7 and 2-8 list leading color television brands in 1995 and 1996.

**Table 2-4**  
**Worldwide Color Television Production Forecast**

	1993	1994	1995	1996	1997	1998	1999	2000	2001	CAGR (%) 1996-2001
Units (K)	102,861	105,748	110,527	116,466	119,372	124,664	132,363	138,332	143,233	4.2
Factory ASP (\$)	237	243	240	238	235	233	230	229	227	-0.9
Factory Revenue (\$M)	24,343	25,689	26,503	27,677	28,111	29,033	30,427	31,734	32,468	3.2
Semiconductor Content (\$)	33	32	31	32	32	33	33	34	34	1.1
Semiconductor Market (\$M)	3,346	3,379	3,424	3,753	3,826	4,158	4,432	4,674	4,870	5.3
<b>Regional Production Trends (Percentage of World by Unit Production)</b>										
Americas	23	24	24	23	23	23	23	23	23	-
Europe	19	19	22	22	22	22	22	22	21	-
Japan	10	9	7	6	6	5	5	5	5	-
Asia/Pacific	48	49	46	49	49	50	51	50	51	-

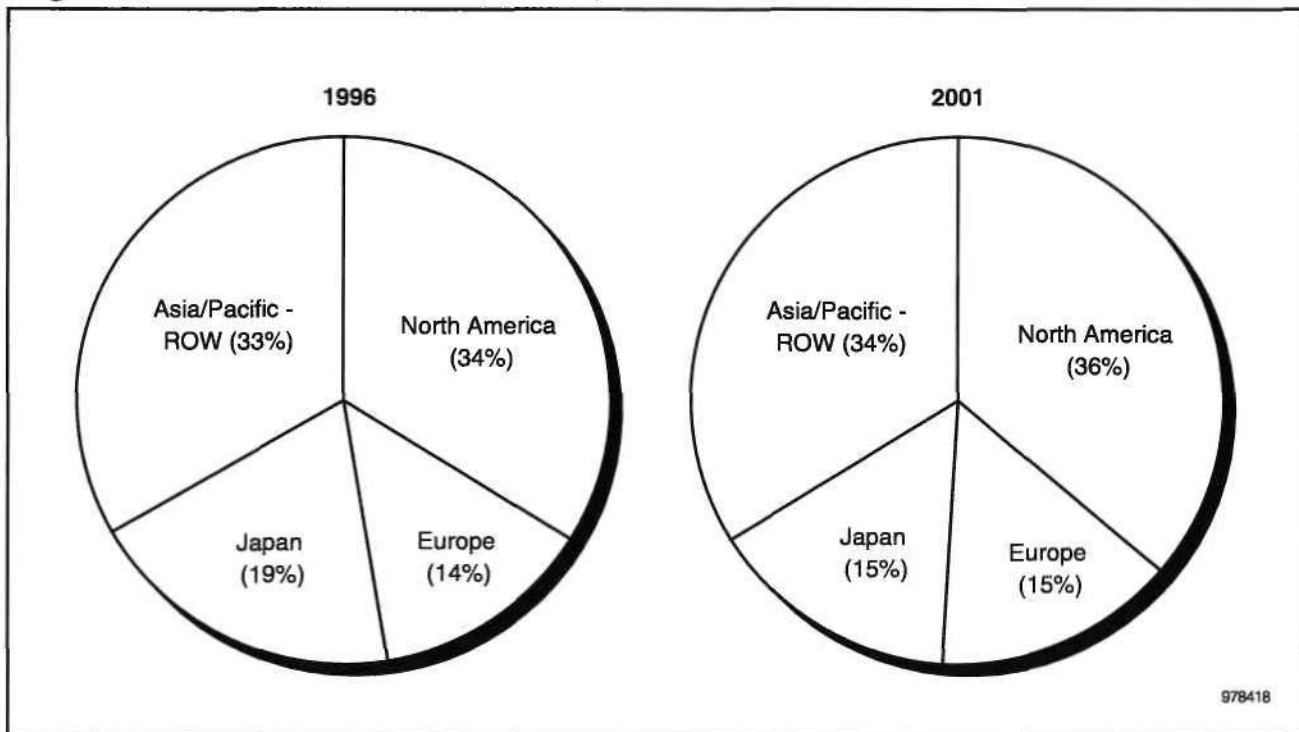
Source: Dataquest (November 1997)

**Figure 2-5**  
**Worldwide Color Television Production Revenue and Unit Shipment Forecast**



Source: Dataquest (November 1997)

**Figure 2-6**  
**Regional Share of Color Television Production Revenue (Percent)**



Source: Dataquest (November 1997)

**Table 2-5**  
**Americas Color Television Market Forecast**

	1993	1994	1995	1996	1997	1998	1999	2000	2001	CAGR (%) 1996-2001
<b>Color TV Only</b>										
N.A. Units (K)	33,817	36,331	34,684	33,223	33,498	34,842	36,226	37,908	39,486	3.5
Factory ASP (\$)	318	292	293	289	286	283	280	277	274	-1.1
Factory Revenue (\$M)	10,754	10,609	10,162	9,601	9,580	9,861	10,147	10,507	10,825	2.4
<b>TV/VCR Combo</b>										
N.A. Units (K)	1,884	2,333	2,567	2,582	2,665	2,888	3,125	3,391	3,673	7.3
Factory ASP (\$)	368	350	334	319	309	306	303	299	296	-1.5
Factory Revenue (\$M)	693	817	857	824	823	883	946	1,016	1,087	5.7

Note: Includes direct view stereo and nonstereo TVs. Does not include monochrome TVs, color LCD TVs, or projection TVs.

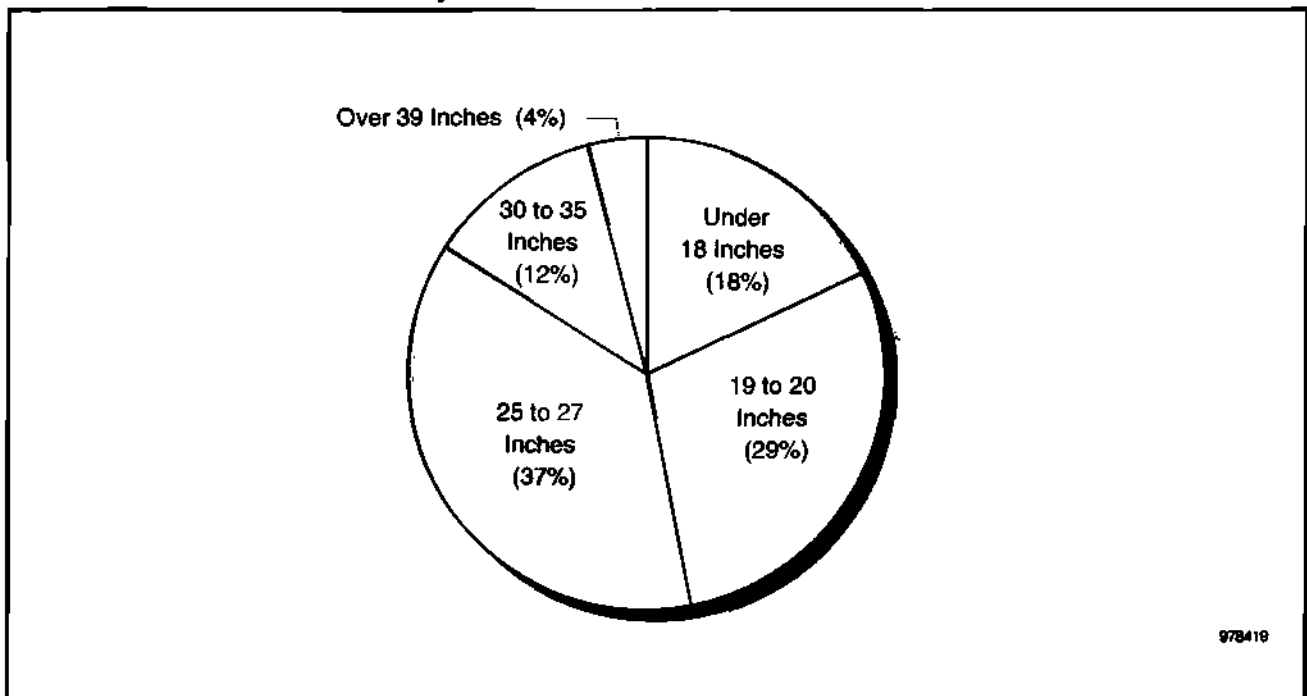
Source: Dataquest (November 1997)

**Table 2-6**  
**Americas Color Television Production Forecast**

	1993	1994	1995	1996	1997	1998	1999	2000	2001	CAGR (%) 1996-2001
Units (K)	23,408	24,976	26,850	27,119	27,390	28,507	30,065	31,929	32,905	3.9
Factory ASP (\$)	337	341	342	345	349	353	355	356	357	0.7
Factory Revenue (\$M)	7,894	8,507	9,183	9,356	9,570	10,053	10,685	11,381	11,731	4.6
Semiconductor Content (\$)	29	29	28	29	30	32	32	33	35	4.1
Semiconductor Market (\$M)	677	731	752	784	833	912	974	1,054	1,165	8.2

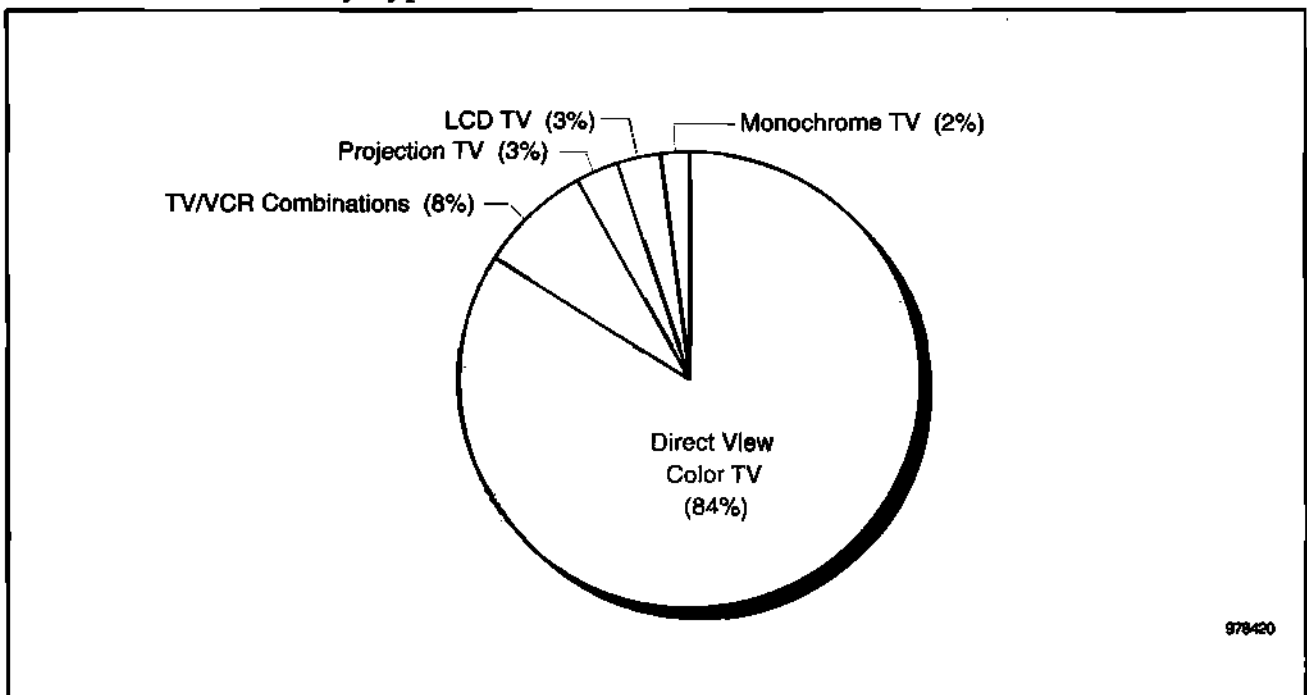
Source: Dataquest (November 1997)

**Figure 2-7**  
**U.S. Color Television Sales by Screen Size for 1996 (Unit Basis)**



Source: The Scout Report<sup>®</sup>/The Polk Company

**Figure 2-8**  
**U.S. Television Sales by Type for 1996 (Unit Basis)**



Source: Consumer Electronics Manufacturers Association (CEMA)

**Table 2-7**  
**U.S. Color Television Brand Share Leaders, Q1/95 to Q4/95**

Brand	Unit Market Share (%)	Revenue Market Share (%)
RCA	16.4	17.5
Magnavox	15.8	13.9
Zenith	12.6	11.9
Sony	7.9	10.6
GE	6.3	4.3
Sharp	5.4	3.3
Sanyo	5.3	3.2
Panasonic	3.9	4.2
Emerson	3.7	1.9
Toshiba	3.2	5.8
Others	19.5	23.4
<b>Total</b>	<b>100.0</b>	<b>100.0</b>

Source: The Scout Report®/The Polk Company

**Table 2-8**  
**U.S. Color Television Brand Share Leaders, Q1/96 to Q4/96**

Brand	Unit Market Share (%)	Revenue Market Share (%)
Magnavox	16.1	14.7
RCA	15.1	16.1
Zenith	11.8	11.6
Sony	7.2	9.7
GE	6.8	4.5
Sanyo	6.4	3.9
Sharp	5.0	3.4
Panasonic	4.0	4.2
Emerson	3.5	6.5
Toshiba	2.4	1.3
Others	21.7	24.1
<b>Total</b>	<b>100.0</b>	<b>100.0</b>

Source: The Scout Report®/The Polk Company

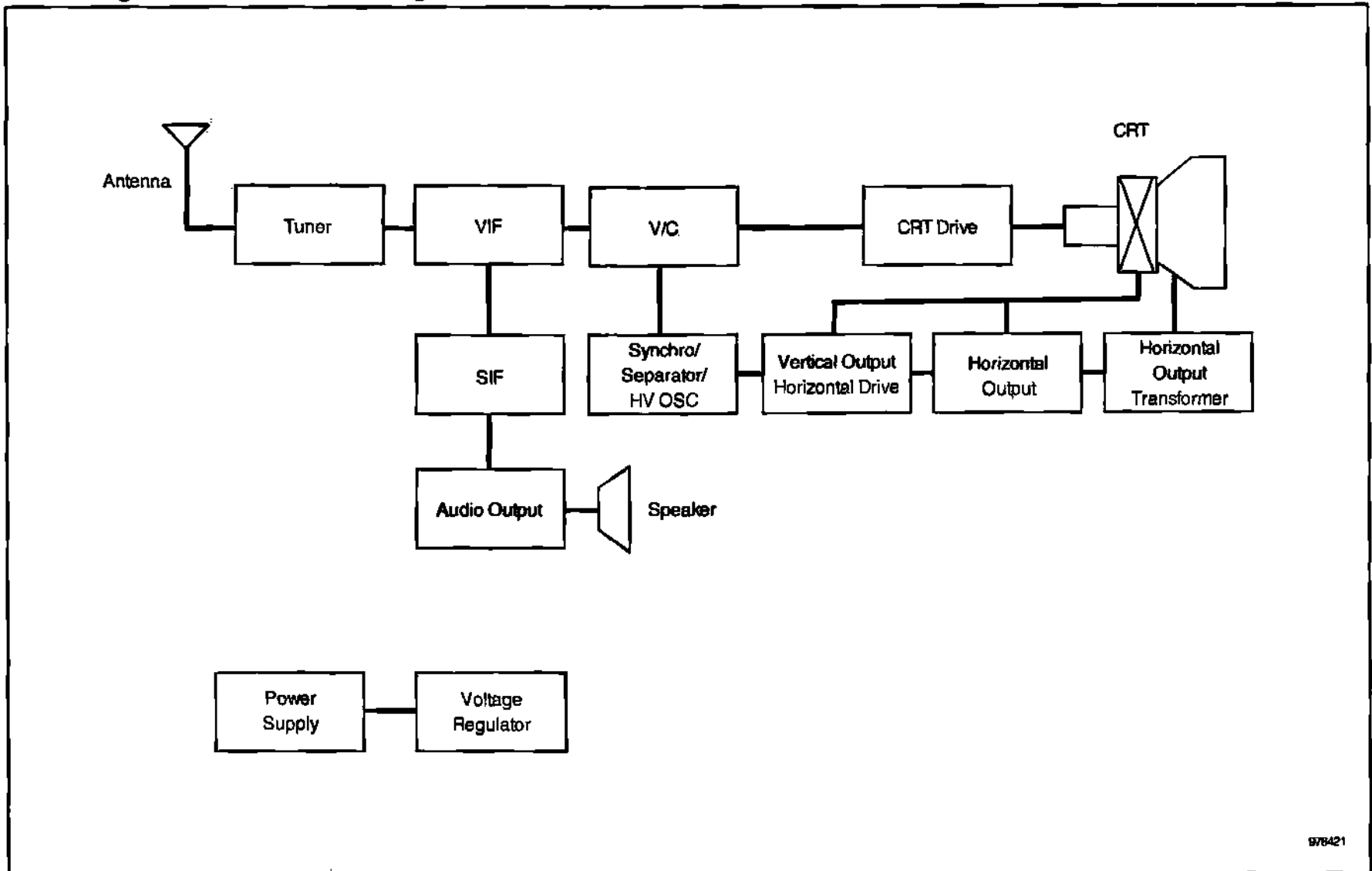
Key market trends and product developments affecting the color television market include the following:

- TV/VCR combinations will continue to grow significantly as several manufacturers introduce new models. These are preferred by families as a unit for children because they save room and are easy to operate.
- Direct viewscreens of 20 inches and less are losing favor to screen sizes of 25 inches and more. The 25-to-27-inch category is now the largest segment of the color television market in the United States, with 37 percent of the market in 1996. A continued shift of the sales mix to larger screen sizes is expected. Screen sizes over 30 inches already represent 16 percent of the market in the United States for the 12 months ended March 1996.

- Plasma displays for home theater television display have finally moved from the trade show floor to the show room floor. A number of companies have begun to bring to market second-generation plasma televisions with larger screen sizes and higher contrast ratios. Fujitsu, NEC, Pioneer, Matsushita, and Mitsubishi have introduced large-screen plasma displays as large as 50 inches and with resolutions as high as 1,365 x 768. Fujitsu in September showed three new flat panel displays targeted at the television market, a 42-inch VGA panel with a high 400:1 contrast ratio, and a television panel supporting HDTV resolution. Fujitsu said initial production of the 42-inch display will be 4,000 units per month. NEC in October said it will begin selling in Japan a 50-inch plasma display television in late 1997 or early 1998 that will be priced at about \$22,300. The display will have a 1,365 x 768-pixel resolution. NEC also has introduced a second-generation version of its 42-inch plasma television display priced at ¥1.45 million. NEC plans to produce 300,000 plasma displays in 1998, including the two television screens and a 33-inch computer monitor. Pioneer in October introduced a 50-inch panel with a resolution of 1280 x 768. The sets will go on sale late 1998 at a price of about \$16,500. Matsushita in October introduced a 42-inch plasma television. Mitsubishi has introduced a plasma display targeted at HDTV applications. The display is 1,014 x 570 mm<sup>2</sup> in size and has a resolution of 1280 x 1024. Philips, Sony, and Sharp have joined to develop 40-inch plasma-addressed liquid crystal displays that can hang on walls. The displays, which combine features of plasma and LCD displays, offers higher contrast and brightness than plasma alone, according to Sony. High-volume shipments of the display will not be available until the end of the century.
- Digital micromirror display (DMD) technology from Texas Instruments also has begun to move into home theater television applications. The TI DMD device measures 2cm<sup>2</sup> and holds between 300,000 and 480,000 movable aluminum mirrors, each about 16 square microns. By controlling the mirrors' movement, the device projects a brighter image than today's LCD-based video projectors. Employing processing techniques TI calls Digital Light Processing (DLP), DMD supports a 640 x 480 display. After years of anticipation, the first consumer-oriented products that use Texas Instruments' Digital Light Processing (DLP) Digital Micromirror Dx (DMD) technology were introduced in late 1997. These products are targeted at the home theater market. Vidikron, Projectavision, and Runco have introduced products, while Curtis Mathes is expected to bring to market a 60-inch DMD display rear projection television. Prices for the new DMD home theater projection systems range from around \$10,000 to \$70,000. Screen sizes range from 60- to 260-inches with resolutions 800 x 600, suitable for SDTV. However, the larger companies that have endorsed DLP—including Sony—have yet to step up to the plate and announce their own DLP-based consumer-oriented products, although Sony has brought to market professionally-oriented devices.

Functionally, color TVs have reached near-maturity, and the focus is being placed on improvement of productivity in the manufacturing process through digitization. Integration of peripherals devices into semiconductor chips allows reduction of components, and thus reduction of inspection/adjustment points. Also, an increasing use of microcomputers enables signal processing control by computer bus, leading to standardization of chassis design. Figure 2-9 shows a block diagram of a currently available multifunction, high-performance color TV.

**Figure 2-9**  
**Block Diagram of Multifunction, High-Performance Color TV**



978421

Source: Dataquest (November 1997)

Major technological trends in electronic circuits for televisions are classified as follows:

- Digital processing of image, voice, and mechanical control signals. Digital processing of video and voice signals for low-end products has been incorporated into ICs, except for CRT video and horizontal output circuits, which are configured by discrete devices.
- Ghost cancellation technology. Since the adoption of the Ghost Cancellation Reference (GCR) by the U.S. Federal Communications Commission (FCC) in May 1993, awareness of this technology has increased. Many more stations are including the reference in their transmission. Ghost cancellation technology is also being introduced to the public through a consumer standalone unit. With time, ghost cancellation will become more widely accepted, and the technology will become a commonly integrated feature of the television receiver or VCR.
- Interframe signal processing using TBC technology and semiconductor memory. Improved-definition TV (IDTV) and enhanced-definition TV (EDTV) use digital memories to scan 525 lines at a frequency twice that used in the National Television Standards Committee (NTSC) standard. The use of digital memory also allows currently available color TVs to adopt technologies to improve picture quality by eliminating or reducing cross-color and jitter.
- Closed-captioning decoders. Closed-captioning decoders for the hearing impaired are now mandatory on U.S. market TVs.
- Use of the bus system for interactive control of ICs. In particular, the I2 bus technology patented by Philips is beginning to be adopted by color TVs.
- Incorporation of new features. Digitization of signal processing has promoted incorporation of new features, such as picture-in-picture, digital still, and on-screen display.

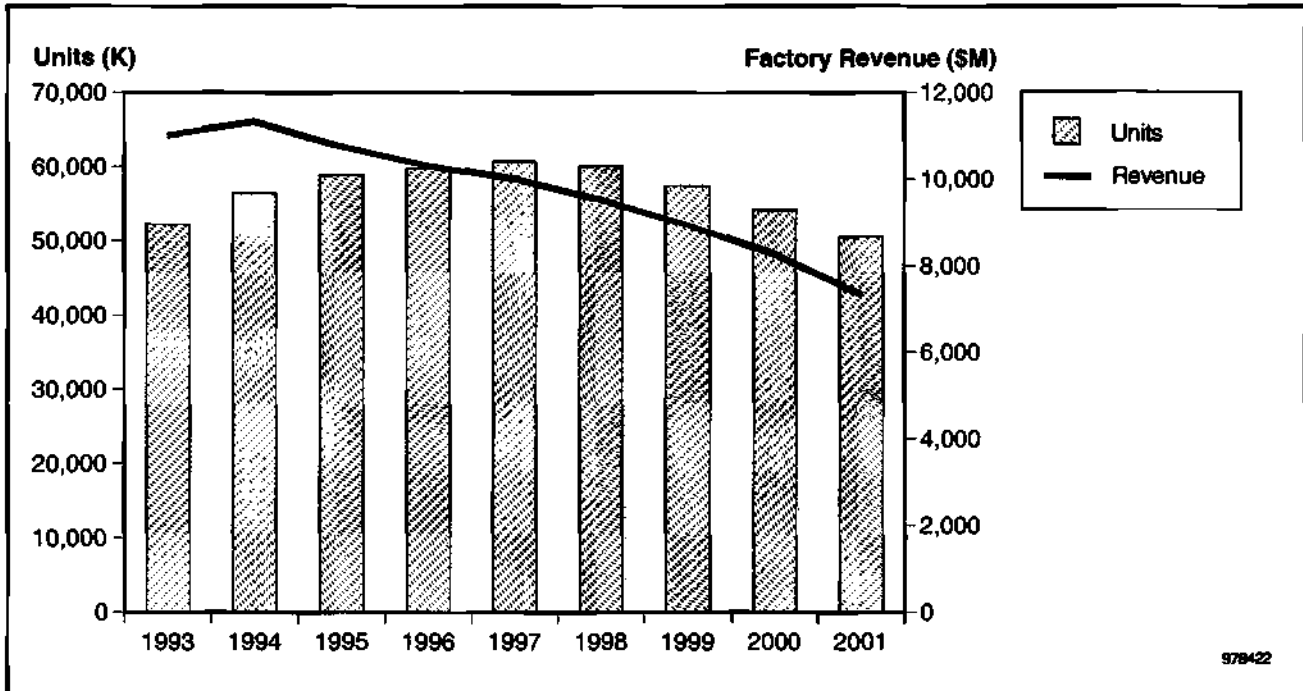
## VCRs

Figure 2-10 and Table 2-9 show the forecast for worldwide VCR production. With high household penetration rates in the United States and popular alternative products such as Video CD players in Japan and Asia/Pacific, Dataquest expects unit shipments and revenue for the next five years to decline. Sales are now sustained by replacement, upgrades, and households adding a VCR. As new DVD Video players assert themselves in the market, they will cause the market for VCRs to start to decline in 1998. With the introduction of rewritable DVD players, the decline of the VCR market will accelerate in 2000 and 2001. Asia/Pacific is now the dominant region for VCR production. Figure 2-11 shows the distribution of VCR production revenue by region. Tables 2-10 and 2-11 show the Americas VCR market and production forecast, respectively. Tables 2-12 and 2-13 list the leading VCR brands in 1995 and 1996. Key trends to note among VCRs are as follows:

- The most popular upgrade feature is stereo audio. In 1996, U.S. sales of VCRs with stereo audio jumped 38 percent and now represent 46 percent of total VCR sales. Other advanced features include special effects with four heads and the S format, which offers more effective scan lines.

- Electronic programming guides, such as StarSight, are available in VCRs, but continue to encounter low acceptance. The VCR Plus+ system, which offers a simple approach to programming, has been more successful. VCR Plus+ is now a standard feature on many step-up VCR models.

**Figure 2-10**  
**Worldwide VCR Production Forecast**



Source: Dataquest (November 1997)

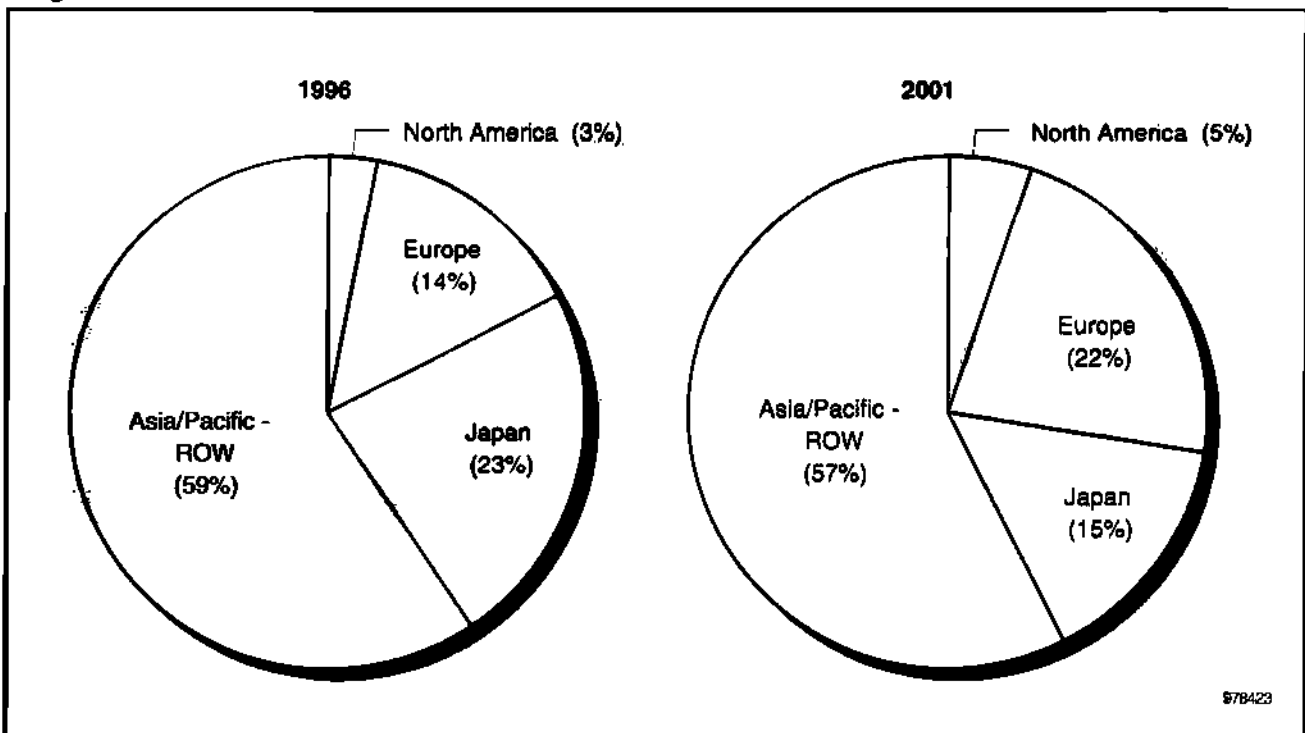
**Table 2-9**  
**Worldwide VCR Production Forecast**

	1993	1994	1995	1996	1997	1998	1999	2000	2001	CAGR (%) 1996-2001
Units (K)	52,214	56,475	58,821	59,808	60,687	60,049	57,393	54,153	50,480	-3.3
Factory ASP (\$)	211	201	183	172	165	158	156	153	145	-3.3
Factory Revenue (\$M)	11,010	11,331	10,742	10,305	10,015	9,517	8,934	8,264	7,339	-6.6
Semiconductor Content (\$)	43	44	42	41	41	40	40	39	38	-1.6
Semiconductor Market (\$M)	2,233	2,459	2,456	2,452	2,498	2,393	2,282	2,134	1,912	-4.9
<b>Regional Production Trends (Percentage of World by Unit Production)</b>										
Americas	2	2	2	2	2	2	3	3	3	-
Europe	13	13	15	16	16	16	18	19	20	-
Japan	29	25	19	15	13	12	12	12	8	-
Asia/Pacific	56	60	64	67	69	69	68	66	68	-

Source: Dataquest (November 1997)



**Figure 2-11**  
**Regional Share of VCR Production Revenue (Percent)**



Source: Dataquest (November 1997)

**Table 2-10**  
**Americas VCR Market Forecast**

	1993	1994	1995	1996	1997	1998	1999	2000	2001	CAGR (%) 1996-2001
Units (K)	15,249	16,751	17,766	19,503	19,596	19,869	19,936	19,395	18,929	-0.6
Factory ASP (\$)	229	218	204	180	172	169	167	164	162	-2.1
Factory Revenue (\$M)	3,492	3,652	3,624	3,510	3,371	3,365	3,324	3,184	3,060	-2.7

Note: Does not include TV/VCR combos or camcorders

Source: Dataquest (November 1997)

**Table 2-11**  
**Americas VCR Production Forecast**

	1993	1994	1995	1996	1997	1998	1999	2000	2001	CAGR (%) 1996-2001
Units (K)	1,238	1,313	1,365	1,378	1,385	1,427	1,518	1,550	1,635	3.5
Factory ASP (\$)	236	232	229	223	219	224	226	229	231	0.7
Factory Revenue (\$M)	292	305	313	307	303	319	343	355	378	4.2
Semiconductor Content (\$)	31	31	31	33	34	34	34	34	34	0.9
Semiconductor Market (\$M)	39	41	43	45	48	48	52	53	56	4.4

Source: Dataquest (November 1997)

**Table 2-12**  
**U.S. VCR Brand Share Leaders, Q1/95 to Q4/95**

Brand	Unit Market Share (%)	Revenue Market Share (%)
RCA	13.5	14.5
Magnavox	12.6	12.2
Panasonic	8.0	8.7
Emerson	7.5	5.4
Zenith	5.9	6.2
Sony	5.5	7.5
JVC	5.1	6.1
Sharp	5.0	4.5
GE	4.8	4.2
SANYO	3.4	2.7
Others	28.7	28.0
<b>Total</b>	<b>100.0</b>	<b>100.0</b>

Source: The Scout Report®/The Polk Company

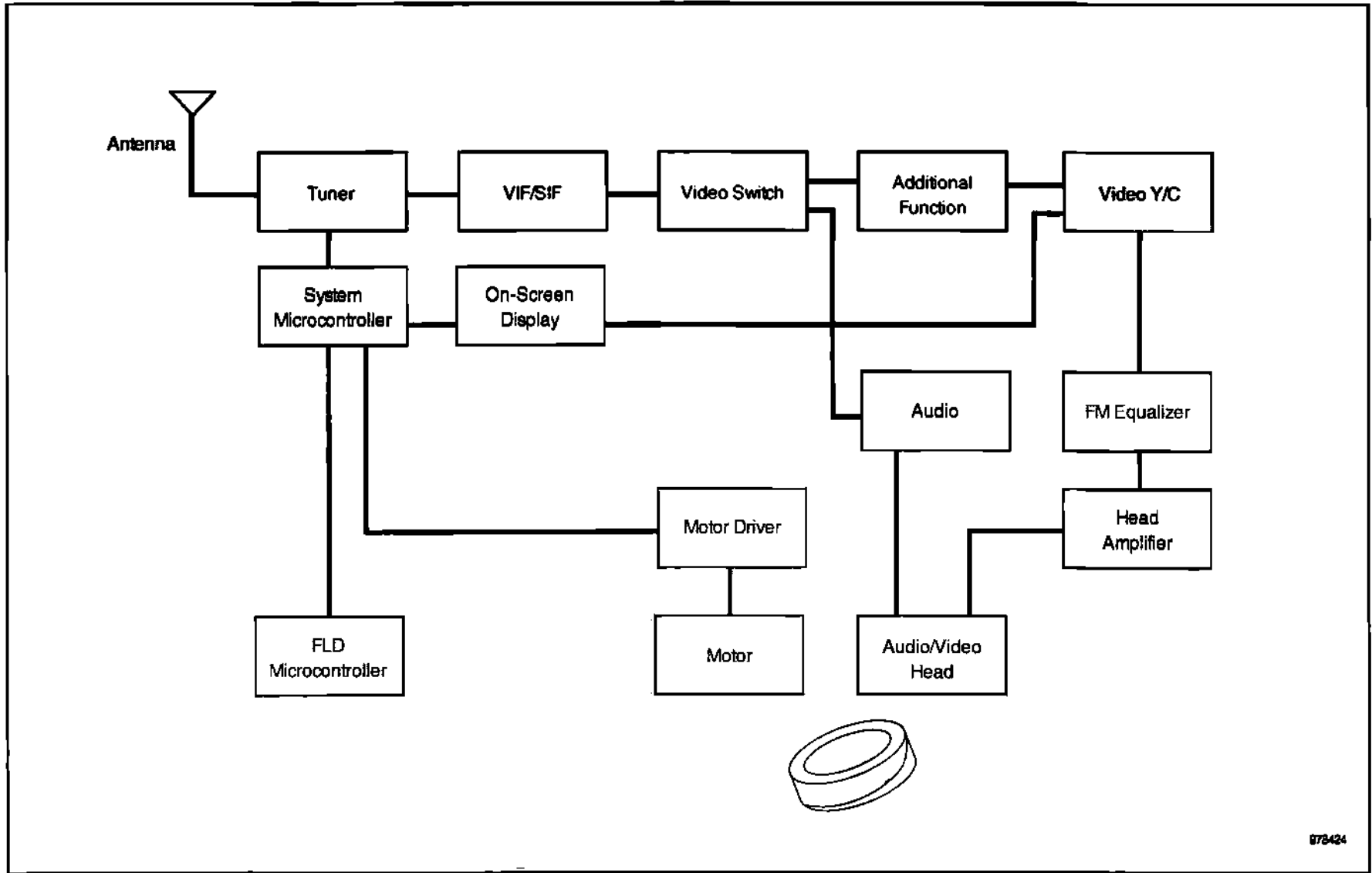
**Table 2-13**  
**U.S. VCR Brand Share Leaders, Q1/96 to Q4/96**

Brand	Unit Market Share (%)	Revenue Market Share (%)
Magnavox	14.4	13.7
RCA	14.1	14.6
Sony	6.8	8.6
Panasonic	6.5	7.3
JVC	5.9	7.1
Emerson	5.8	4.3
Zenith	5.3	5.2
Sharp	5.1	5.0
GE	4.9	4.0
SANYO	3.3	2.7
Others	27.9	27.5
<b>Total</b>	<b>100.0</b>	<b>100.0</b>

Source: The Scout Report®/The Polk Company

In terms of basic features and functions, VCRs have reached a state of near perfection. Basic signal processing circuits are increasingly digitized by using analog-to-digital converters (ADCs) and digital-to-analog converters (DACs) and are being integrated into semiconductor chips incorporating digital signal processors (DSPs). New developments are expected in restoration of original signals, in addition to accurate replay, as well as the ability to provide output according to diverse consumer demand. Digitization has boosted the number of ICs capable of handling NTSC, PAL (European), and SECAM (French) formats. Also, the use of on-screen display ICs and filter-equipped ICs is reducing the number of components and adjustment points at the factory. Copy-protection circuitry from Macrovision is becoming more popular as both Philips and Texas Instruments are producing copy-protection chips. Figure 2-12 shows a block diagram of a typical VCR.

Figure 2-12  
Block Diagram of a Typical VCR



878424

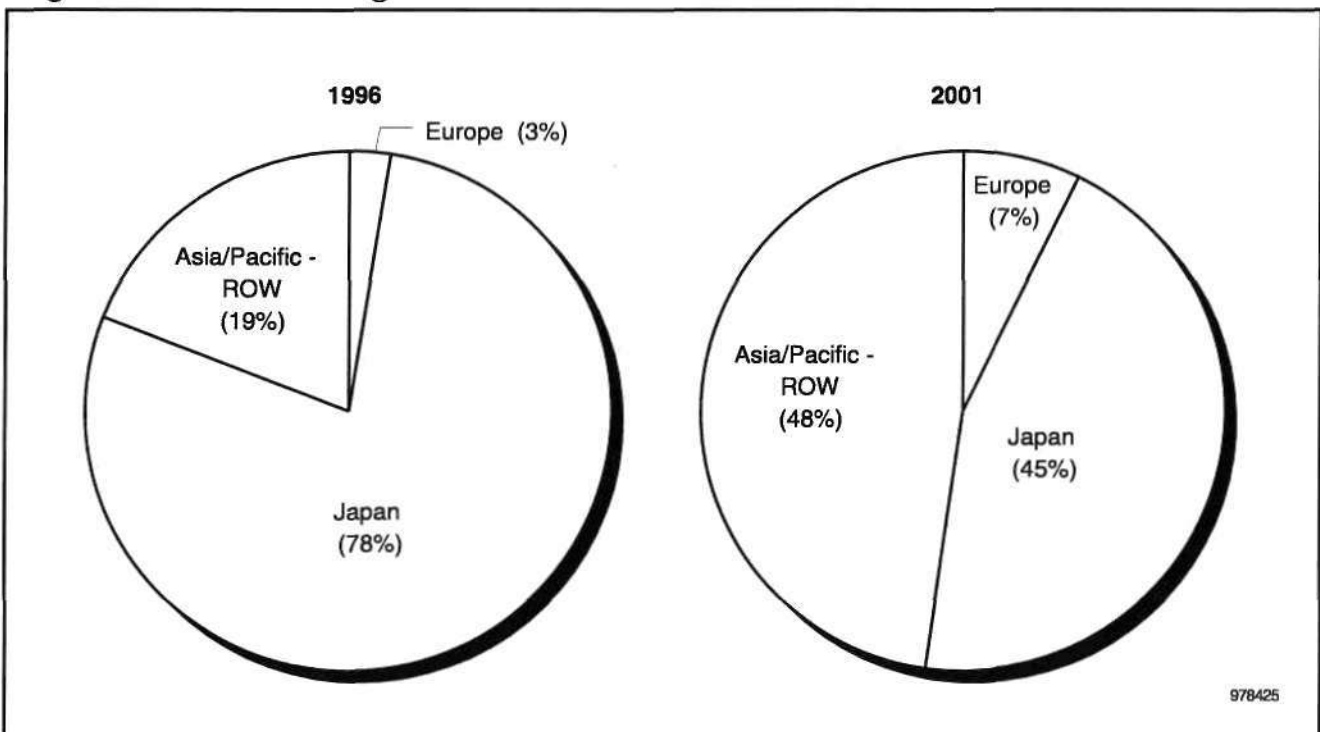
Source: Dataquest (November 1997)

In 1997, the first VCRs complying with the Data-VHS (D-VHS) standard entered the market. The new D-VHS system is backward-compatible with the VHS format and also adds a bitstream recording capability to allow recording of compressed digital data. The standard uses existing Super VHS media and is capable of offering 49 hours of recording per cassette. D-VHS also records analog broadcasts such as NTSC and PAL. This feature allows VCR to be used in data storage and multimedia systems. JVC has consulted with Hitachi, Matsushita, and Philips Electronics in developing this new standard. Also, the following companies have expressed support for the D-VHS format: LG Electronics, Mitsubishi Electric, Samsung Electronics, SANYO Electric, Sharp, Sony, Thomson Consumer Electronics, and Toshiba. JVC in October rolled out a combination D-VHS VCR and DBS receiver that works with the EchoStar service. The box is designed to take advantage of the digital video synergy between the D-VHS format and digital satellite. With an antenna, the JVC DBS/D-VHS is priced at \$999.

## Camcorders

In the midst of a general malaise in traditional consumer electronics, the worldwide camcorder production showed solid growth during 1996. The strong growth in demand for digital camcorders with their high prices in the Japan market helped push revenue growth up by nearly 20 percent in 1996. Overall continued growth is forecast through 1999 in the camcorder market along with an increasing penetration by digital camcorders. However, Dataquest's expectations for significant cost and price erosion in digital camcorders in 2000 lead to a forecast dip in revenue starting in 2000. Figure 2-13 shows regional share of analog camcorder production revenue.

**Figure 2-13**  
**Regional Share of Analog Camcorder Production Revenue**



Source: Dataquest (November 1997)

## Market Trends

Key market trends to note among camcorders are as follows:

- More than 26 percent of U.S. homes had camcorders by January 1997, although it is primarily homes with children that are buying camcorders. Aggressive pricing by some companies has pushed entry-level pricing well below \$400. The hottest price points for analog camcorders remain in the \$700 to \$800 range. Toward the end of 1997 the street prices for digital camcorders continue to range from \$1,800 to \$2,600.
- Viewfinders that rely on LCDs rather than on traditional optical techniques are contributing to the impressive market surge for camcorders. The percentage of camcorders equipped with LCD monitors continues to be a significant factor in Japan and abroad, according to statistics from Sharp, a leader in LCD technology implementation in camcorders. Sharp estimated that camcorders with built-in LCD monitors represented 25 percent of all U.S. camcorder sales in 1996. Hitachi, JVC, Matsushita, Minolta, Sharp, and Sony all introduced new LCD-based products in 1996.
- The VHS-C format appears to be capturing a greater share of the U.S. market at the expense of the full-size VHS camcorders. According to the Photo Marketing Association, in 1991, the full-size VHS standard represented 42 percent of the U.S. camcorder market, with 8mm accounting for 37 percent and VHS-C for 22 percent. By 1994, the mix had shifted to: VHS, 26 percent; VHS-C, 38 percent; and 8mm, 36 percent. In 1995, it appeared that VHS-C and 8mm were neck-and-neck at 41 percent, and VHS was declining to 18 percent of the market. (JVC claims that VHS-C captured 44 percent of the market, compared with 37 percent for 8mm in 1995.) The combined 1996 sales for compact camcorders, VHS-C and 8mm, represented 87 percent of U.S. camcorders sales volume. Sony and JVC continue to make competing claims regarding leading market share between 8mm and VHS-C. Sales of VHS camcorders sank to around 10 percent in 1996 and should drop to 7 or 8 percent in 1997.
- In April 1997 JVC announced that it would stop production of Super VHS-C camcorders in order to concentrate on its digital camcorder business. JVC expected this format to disappear from store shelves by September 1997 and eliminate a competitor to its digital camcorder business.

## Analog Camcorders

Table 2-14 present Dataquest's forecast for worldwide analog camcorder production. Factory revenue reached a relative plateau from 1993 to 1996. With the introduction and acceptance of digital camcorders, Dataquest is predicting that shipments of analog camcorders will start to decline in 1998 and lead to a corresponding decline in factory revenue. Figure 2-13 shows a significant shift of production to the Asia/Pacific region from 1996 to 2001. Tables 2-15 and 2-16 present the Americas market and production forecast, respectively.

**Table 2-14**  
**Worldwide Analog Camcorder Production Forecast**

	1993	1994	1995	1996	1997	1998	1999	2000	2001	CAGR (%) 1996-2001
Units (K)	8,833	9,510	10,249	10,474	10,500	9,310	8,648	7,717	6,460	-9.2
Factory ASP (\$)	564	519	488	470	447	421	397	375	354	-5.5
Factory Revenue (\$M)	4,984	4,931	5,002	4,921	4,696	3,922	3,430	2,891	2,288	-14.2
Semiconductor Content (\$)	145	137	128	118	113	110	108	103	99	-3.6
Semiconductor Market (\$M)	1,277	1,301	1,308	1,238	1,189	1,026	931	795	637	-12.4
<b>Regional Production Trends (Percentage of World by Unit Production)</b>										
Americas	1	0	0	0	0	0	0	0	0	-
Europe	10	3	3	4	4	5	6	7	8	-
Japan	88	82	80	73	71	65	60	51	38	-
Asia/Pacific	1	15	16	24	25	30	35	42	54	-

NA = Not applicable

Source: Dataquest (November 1997)

**Table 2-15**  
**Americas Analog Camcorder Market Forecast**

	1993	1994	1995	1996	1997	1998	1999	2000	2001	CAGR (%) 1996-2001
Units (K)	3,428	3,594	3,987	4,148	4,389	4,597	4,818	5,050	5,252	4.8
Factory ASP (\$)	630	621	596	586	581	578	577	577	573	-0.4
Factory Revenue (\$M)	2,159	2,232	2,376	2,431	2,550	2,657	2,780	2,914	3,009	4.4

Source: Dataquest (November 1997)

**Table 2-16**  
**Americas Camcorder Production Forecast**

	1993	1994	1995	1996	1997	1998	1999	2000	2001	CAGR (%) 1996-2001
Units (K)		50	15	0	0	0	0	0	0	NA
Factory ASP (\$)		611	555	0	0	0	0	0	0	NA
Factory Revenue (\$M)		31	8	0	0	0	0	0	0	NA
Semiconductor Content (\$)		92	87	0	0	0	0	0	0	NA
Semiconductor Market (\$M)		5	1	0	0	0	0	0	0	NA

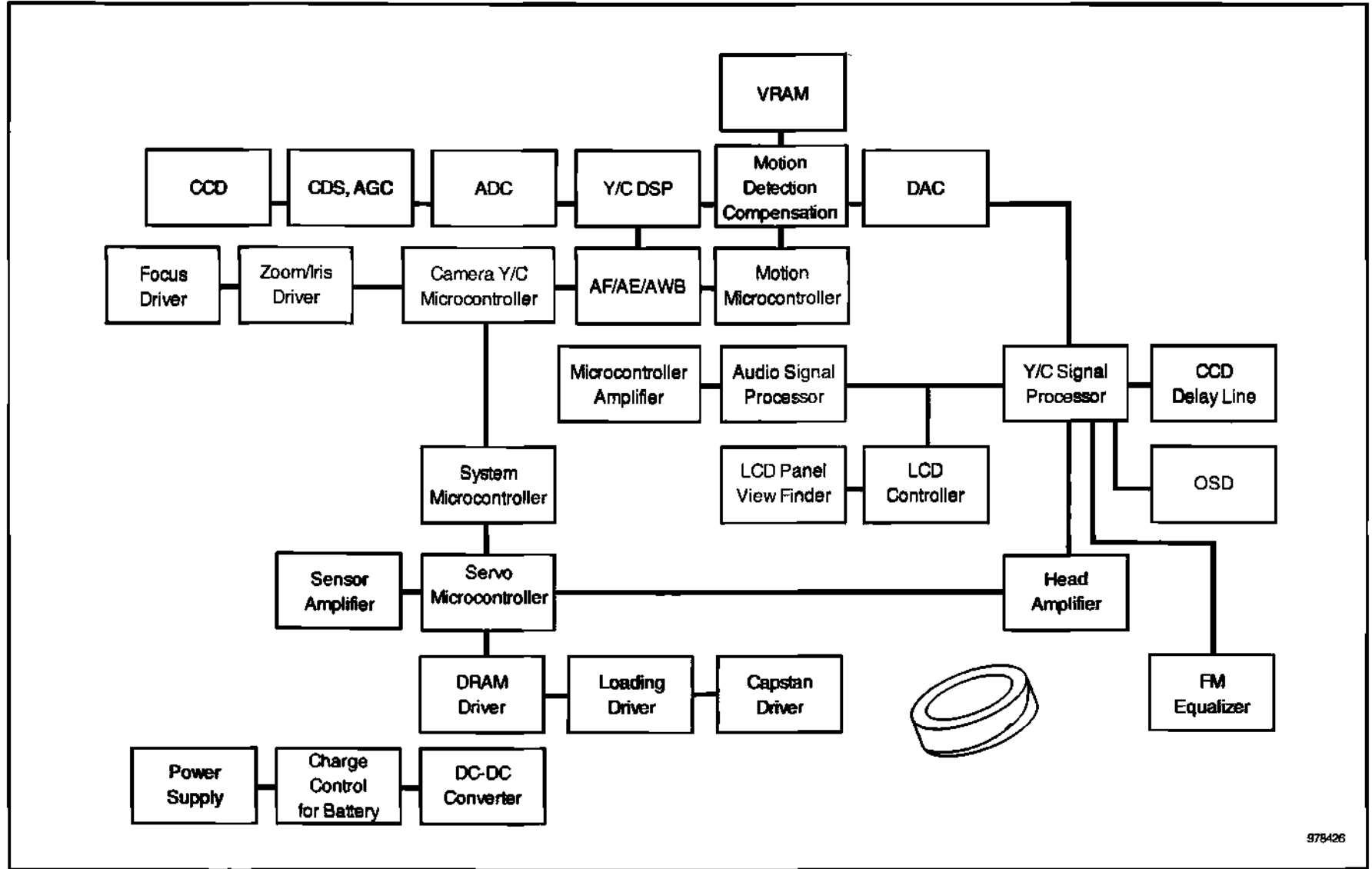
NA = Not applicable

Source: Dataquest (November 1997)

Figure 2-14 shows a block diagram of a typical analog camcorder. Some technology features and trends with implications for semiconductor opportunities are as follows:

- Charge-coupled devices (CCD) continue to be a significant cost driver in camcorders. CCDs are becoming smaller and are accommodating more picture elements.
- CCD output signals, which have been conventionally analog processed, are converted to digital signals through a 10-bit DAC and, after luminance and chrominance (Y/C) signal processing by the DSP, are sent to the processing stage for functions such as blur correction and electronic zooming. Auto focus/auto iris/auto white balance (AF/AE/AWB) detection has been integrated into digital circuits on a single chip. Peripheral circuits related to blur correction consist of fuzzy logic circuits for motion detectors, blur-correction control, and memory control, which are incorporated into standard cells (DSPs).
- Mechanism control is handled by an 8-bit microcomputer (servo microcomputer). With the increasing emphasis on portability, development efforts are being shifted from low power consumption to lower operation voltage to 3.3V (3V). Further demand for high-performance camcorders will encourage digital processing, incorporation of a battery charge circuit into a single chip, and development of a single/hybrid chip.
- In the video equipment market, advanced technology developed for industrial use (broadcast equipment) is finding its way to consumer applications that demand much lower levels of picture quality. Various technologies unique to consumer products, such as blur correction, have been commercialized. At the same time, because color TVs, VCRs, and camcorders share common features, new technology developed for any of them is diffused to others.
- Vibration or shake compensation has become a key feature in camcorders, equal in importance to compact, lightweight design and strong-magnification zooms. There are two approaches to shake compensation, one electronic and the other optical. Recently, almost all but the low-end camcorders have adopted some version of electronic shake compensation.
- With the adoption of digital circuits, many camcorders feature digital zooms allowing greater magnification. For example, combining a 12X optical zoom lens with a 2X digital zoom function makes it possible to record images at 24X magnification.

Figure 2-14  
Block Diagram of a Typical Analog Camcorder



978426

Source: Dataquest (November 1997)



## Digital Camcorders

Production of the first digital camcorders began in 1994. With strong adoption of this new format by Japanese consumers the market took a major jump in 1996 reaching almost 1 million units as shown in Table 2-17. These camcorders are based on the Digital Video (DV) format specification for home-use digital camcorders that was agreed to by 55 manufacturers as part of the HD Digital VCR Conference. Matsushita and Sony were the first manufacturers to offer digital camcorders, followed by JVC and Sharp. Hitachi has also introduced a camcorder that will record in an MPEG format. The most recent to enter the market is Canon, launching its new product in October 1997. Samsung is also expected to enter the market. Japan is expected to dominate production over the forecast period as shown in Figure 2-15.

The steep initial pricing of these new digital camcorders limited the early market beyond Japan to semiprofessionals and the top 1 percent to 2 percent of the consumer camcorder market. Pricing on these early models ranges from \$2,200 to \$4,700. By late 1997 typical street prices had dropped to between \$1,800 and \$2,600. However, significant cost reductions for digital camcorders are expected, and this drives a forecast for the Americas market that tops 2.3 million units in 2001 (see Table 2-18). A 1997 survey by the Digital Imaging Market Association showed that 9 percent of the U.S. households in their survey plan to purchase a digital camcorder in the near future.

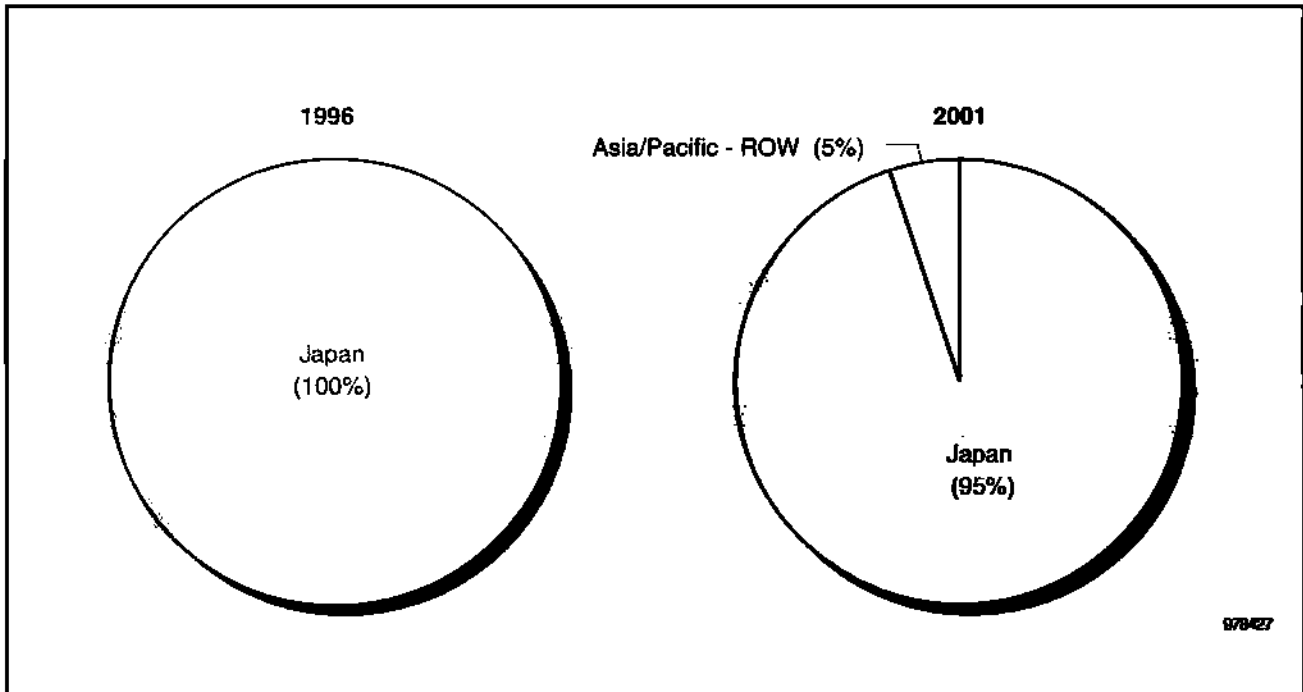
To record image signals, camcorders using the DV format adopt the digital component system, recording luminance, and chrominance signals separately. This format provides a resolution of 500 horizontal lines. Instead of the standard 0.3-MHz color signal bandwidth, the DV format works with a 1.4-MHz bandwidth. The format also calls for a built-in time base correction (TBC) function to diminish jitter. Audio recording involves the use of pulse code modulation (PCM) stereo. There are two possible audio modes. For audio quality equal to that of compact discs and digital audio tapes (DAT), a 16-bit sound system using two channels and 48-KHz sampling frequencies can be used. The specification also defines a 12-bit audio system with four channels and 32-KHz sampling frequencies. Figure 2-16 shows a block diagram for a typical digital camcorder.

**Table 2-17**  
**Worldwide Digital Camcorder Production Forecast**

	1993	1994	1995	1996	1997	1998	1999	2000	2001	CAGR (%) 1996-2001
Units (K)	0	59	208	966	1,712	3,125	4,788	6,085	7,625	51.2
Factory ASP (\$)	0	2,100	1,661	1,523	1,221	989	774	604	528	-19.1
Factory Revenue (\$M)	0	124	346	1,472	2,091	3,091	3,704	3,675	4,027	22.3
Semiconductor Content (\$)	0	420	382	350	281	227	178	139	121	-19.1
Semiconductor Market (\$M)	0	25	79	338	481	709	854	845	926	22.3
<b>Regional Production Trends (Percentage of World by Unit Production)</b>										
Americas	0	0	0	0	0	0	0	0	0	-
Europe	0	0	0	0	0	0	0	0	0	-
Japan	0	100	100	100	100	94	94	94	95	-
Asia/Pacific	0	0	0	0	0	6	6	6	5	-

Source: Dataquest (November 1997)

**Figure 2-15**  
**Regional Share of Digital Camcorder Production Revenue (Percentage)**



Source: Dataquest (November 1997)

**Table 2-18**  
**Americas Digital Camcorder Market Forecast**

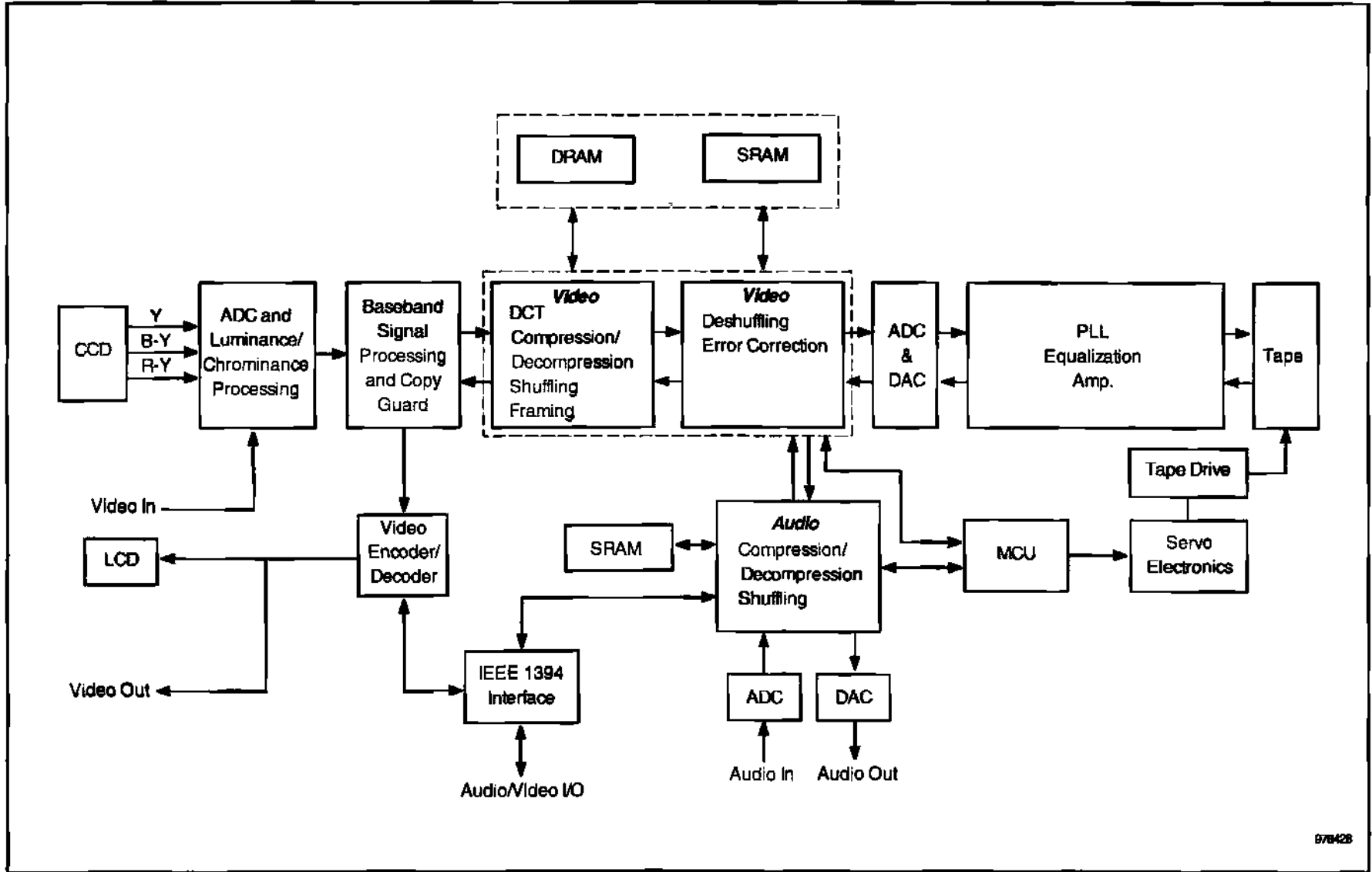
	1993	1994	1995	1996	1997	1998	1999	2000	2001	CAGR (%) 1996-2001
Units (K)	-	-	19	128	252	616	922	1,644	2,317	78.3
Factory ASP (\$)	-	2,947	2,875	2,226	1,606	1,377	1,211	1,054	922	-16.2
Factory Revenue (\$M)	-	-	55	286	405	848	1,117	1,732	2,137	49.5

Source: Dataquest (November 1997)

It appears that the interface format for connecting digital camcorders to other devices such as personal computers will continue to be a competitive issue for manufacturers. Sony was the first to adopt a IEEE-1394 type port in its digital camcorder. However, Sony uses a four-pin connector that eliminates the power pin as opposed to the standard six-pin connector specified in the IEEE-1394 standard. Matsushita's newest product lineup will incorporate a standard 1394 port. JVC continues to push its internally developed JLIP (Joint Level Interface Protocol) standard.

As mentioned previously, Matsushita was one of the first manufacturers to bring a digital camcorder to market. This first model integrated 2.5 million transistors into five main video chips on a 0.5-micron process. Two of the chips, error correction and digital modulation devices, were produced by LSI Logic. A PCM device is made by Mitsubishi Electric. Mitsubishi can use the PCM chip for its camcorder with Matsushita's agreement. The digital camcorder represents a prime opportunity for system-level integration (SLI) devices with embedded memory.

Figure 2-16  
Block Diagram of a Typical Digital Camcorder



Source: Dataquest (November 1997)

### Brand Share Leaders

Tables 2-19 and 2-20 list the camcorder brand share leaders in the U.S. market for 1995 and 1996.

**Table 2-19**

#### U.S. Camcorder Brand Share Leaders, Q1/95 to Q4/95

Brand	Unit Market Share (%)	Revenue Market Share (%)
Sony	22.8	26.1
RCA	18.7	18.3
Panasonic	15.6	15.7
JVC	12.6	11.9
Sharp	8.6	9.4
GE	4.3	3.2
Hitachi	4.2	4.8
Magnavox	3.5	2.6
Samsung	1.9	1.2
Canon	1.8	1.9
Others	6.0	4.9
<b>Total</b>	<b>100.0</b>	<b>100.0</b>

Source: The Scout Report®/The Polk Company

**Table 2-20**

#### U.S. Camcorder Brand Share Leaders, Q1/96 to Q4/96

Brand	Unit Market Share (%)	Revenue Market Share (%)
Sony	24.4	26.4
RCA	19.4	18.0
Panasonic	15.8	16.8
JVC	11.7	11.8
Sharp	8.8	9.3
Canon	3.9	4.6
Hitachi	2.8	2.9
Magnavox	2.6	1.9
GE	2.2	1.4
Samsung	1.9	1.5
Others	6.5	5.4
<b>Total</b>	<b>100.0</b>	<b>100.0</b>

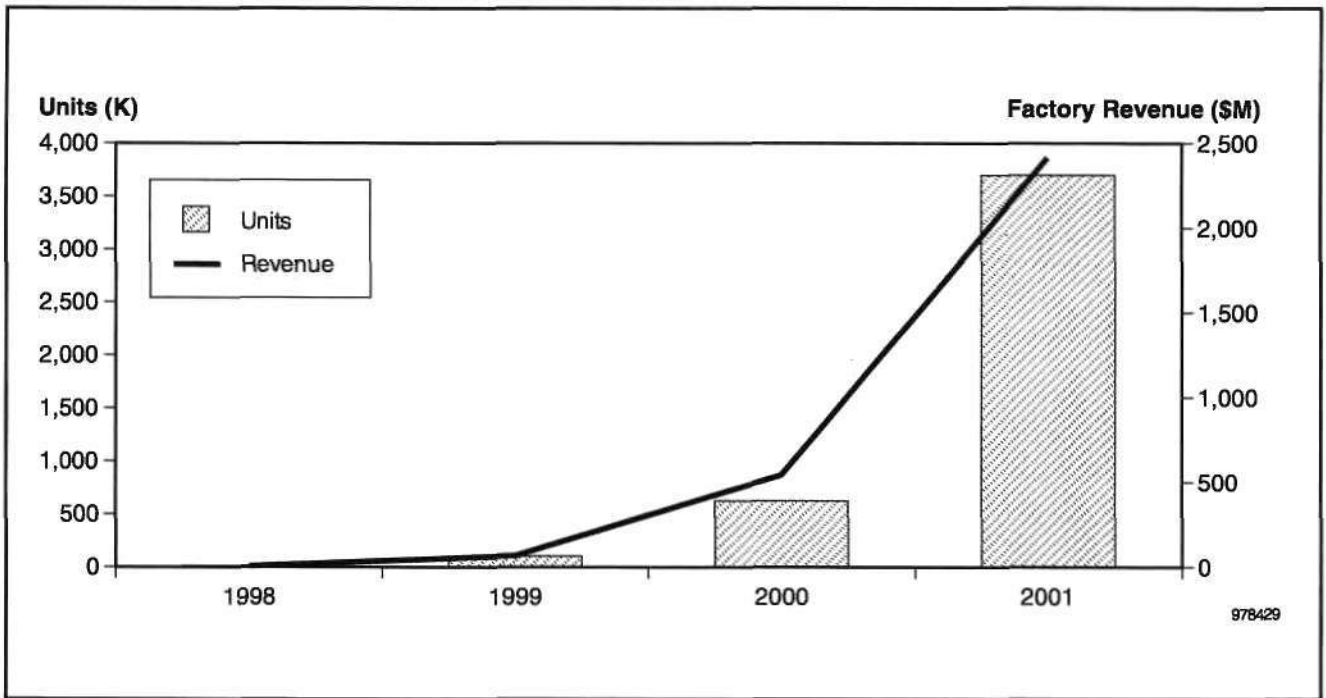
Source: The Scout Report®/The Polk Company

**DTV**

In 1998, the worldwide television market will begin its transition to digital technology. In the United States and Europe, DTV broadcasts are expected to begin. Japan is not expected to start DTV broadcasts until 2000. Initial production levels will be low. However, production will increase rapidly as broadcasters complete their transition to digital technology in the next century. Figure 2-17 and Table 2-21 forecast production of DTV receivers through the year 2001. Equipment covered in this forecast includes high-definition television sets (HDTVs), standard definition television sets (SDTVs), and DTV set-top boxes.

In the United States, the FCC in December 1996 passed the Advanced Television Systems Committee (ATSC) DTV broadcast standard, ending a nine-year journey through the political process. The FCC in April allotted frequencies for DTV broadcast. With the passage of the standard, and frequencies having been allotted, the way is clear for U.S. broadcasters to begin transmission of digital video. Tables 2-22 and 2-23 provide the forecast for the U.S. DTV receiver market and production, respectively.

**Figure 2-17**  
**Worldwide DTV Receiver Production Forecast**



Source: Dataquest (November 1997)

**Table 2-21**  
**Worldwide DTV Receiver Production Forecast**

	1998	1999	2000	2001
Units (K)	11	104	626	3,699
Factory ASP (\$)	516	654	870	653
Factory Revenue (\$M)	6	68	544	2,415
Semiconductor Content (\$)	122	123	118	113
Semiconductor Market (\$M)	1.3	12.7	74.0	419.1

Source: Dataquest (November 1997)

**Table 2-22**  
**Americas DTV Receiver Market Forecast**

	1998	1999	2000	2001
Units (K)	1	20	191	2,398
Factory ASP (\$)	2,876	2,141	801	448
Factory Revenue (\$M)	3	42	153	1,075

Source: Dataquest (November 1997)

**Table 2-23**  
**Americas DTV Receiver Production Forecast**

	1998	1999	2000	2001
Units (K)	1	22	212	2,664
Factory ASP (\$)	2,876	2,141	801	448
Factory Revenue (\$M)	3	47	170	1,194
Semiconductor Content (\$)	211	172	131	114
Semiconductor Market (\$M)	0	4	28	303

Source: Dataquest (November 1997)

### **U.S. DTV's New Challenges**

Just as one chapter of DTV's struggle has ended, a new one is beginning. DTV now faces several new challenges before it can become a high-volume consumer market.

- **Standards:** Although the FCC passed the broadcast portion of the ATSC standard, it left the display aspect of the technology up to the market to decide, opening up the possibility of confusion among consumers.
- **Competition with PCs:** Segments of the PC industry are promoting their own approach to DTV—one that is at odds with the formats promoted by the consumer electronics industry.
- **Broadcasters:** With no standards set for display, and no clear winner in the battle between the PC and consumer industries, broadcasters are in a quandary over what direction to take for DTV formats.
- **Politics:** The U.S. Congress has been pressuring broadcasters to transmit in the high-definition television (HDTV), throwing a monkey wrench into the networks' plans to offer standard-definition television (SDTV) broadcasts.

- **Cost:** Digital television receivers in the United States initially are expected to be costly HDTV sets that will be priced as high as \$12,000. This high cost is likely to limit initial consumer acceptance of the product.

### Standards

The consumer electronics industry supports the ATSC standard for DTV, which is shown in Table 2-24. ATSC was derived from technology developed by the Grand Alliance, a group of companies consisting of Lucent Technologies, Zenith Electronics Corporation, General Instrument Corporation, Massachusetts Institute of Technology, Philips Consumer Electronics, Thomson Consumer Electronics, and the David Sarnoff Research Center.

**Table 2-24**  
**U.S. ATSC DTV Specification**

Video Format Resolution	Aspect Ratio	Picture Rate	Scanning
1920 x 1080	16:9	60	Interlaced
1920 x 1080	16:9	30	Progressive
1920 x 1080	16:9	24	Progressive
1280 x 720	16:9	60	Progressive
1280 x 720	16:9	30	Progressive
1280 x 720	16:9	24	Progressive
704 x 480	16:9	60	Progressive
704 x 480	16:9	60	Interlaced
704 x 480	16:9	30	Progressive
704 x 480	16:9	24	Progressive
704 x 480	4:3	60	Progressive
704 x 480	4:3	60	Interlaced
704 x 480	4:3	30	Progressive
704 x 480	4:3	24	Progressive
640 x 480	4:3	60	Interlaced
640 x 480	4:3	60	Progressive
640 x 480	4:3	30	Progressive
640 x 480	4:3	24	Progressive
Feature	Specification		
Modulation Type	8-VSB, 16-VSB		
Broadcast Type	Terrestrial (at 8-VSB), Cable (at 16-VSB)		
Audio Format	AC-3 (Dolby Digital)		
Number of Channels	Up to Six		
Data Format	Packetized Data Transport Structure		
Data Rate	19-Mbps data transfer for each 6 MHz space		

Source: Dataquest (November 1997)

The ATSC standard consists of 18 separate formats, each of which includes its own resolution, frame rate, scanning format and aspect ratio. Formats within ATSC range from 640 x 480 resolution, progressive scanning and 24 frames per second to 1920 x 1080 resolution, interlaced scanning 60 frames per second. At all resolutions, ATSC supports both interlaced scanning, which is used in conventional, analog NTSC television sets, and progressive scanning, which is employed in computer monitors. The wide range of resolutions makes it possible for equipment makers to offer a variety of DTV products, from low-cost set-top boxes, to midpriced SDTV television sets to expensive HDTV sets. It also gives broadcasters a range of choices, allowing them to divide their frequency allocations in a vast variety of ways, employing different mixes of HDTV, SDTV, and data. The audio standard for ATSC is Dolby Digital, also known as AC-3, the same technology used for DVD players.

This cornucopia of formats ostensibly gives equipment makers and broadcasters a lot of choice, but could also lead to confusion in the market. Much of the success of NTSC analog television in the United States can be attributed to the fact that it is supported universally by all broadcasters and all manufacturers supported in all regions of the country. With this kind of standardization, consumers could be assured that any color television they purchased would always work, no matter what channel they watched, what state they lived in, or how many years had passed since they bought it. With no such assurances for DTV, consumers may shy away from purchasing digital television receivers.

#### **Competition with PCs**

The PC industry—led by Microsoft, Intel and Compaq—are making an aggressive move to claim a piece of the television market using DTV as its entry point. The three companies, which together are known as the DTV Team, have proposed their own standard for DTV that is a subset of the ATSC specification. The specification is designed to be friendly to computers, concentrating on progressive scanning and standard resolution display. The DTV Team specification will evolve over time, improving in quality and performance to accommodate the increasing capabilities of hardware. The first version of the DTV Team specification, known as HD-0, fits the capabilities of today's affordable PCs and consumer electronics devices, according to the DTV team. The DTV Team is aiming HD-0 at a variety of platforms, ranging from desktop PCs, to full-blown, large-screen PC/TVs, to consumer electronics-oriented set-top boxes. Table 2-25 summarizes the DTV team's HD-0 specification.

The PC industry represents a significant challenge to the consumer electronics industry. The DTV team is promoting its approach as lower cost and more appealing to consumers than ATSC. Thus, the DTV team believes it and its partners will be able to sell far more HD-0 compliant boxes than the consumer electronics industry will be able to sell ATSC receivers that support HDTV display. This could result in the PC industry stealing some of the TV market away from the consumer electronics industry.



**Table 2-25**  
**DTV Team HD-0 Specification**

Video Format Resolution	Aspect ratio	Picture rate	Scanning
1280 x 720	16:9	24	Progressive
704 x 480	16:9	60	Progressive
704 x 480	16:9	60	Interlaced
704 x 480	16:9	24	Progressive
704 x 480	4:3	30	Progressive
Feature	Specification		
Modulation Type	8-VSB, 16-VSB		
Broadcast Type	Terrestrial (at 8-VSB); Cable (at 16-VSB)		
Audio Format	AC-3 (Dolby Digital)		
Number of Channels	Up to Six		
Data Format	Packetized Data Transport Structure		
Data Rate	19 Mbps data transfer for each 6 MHz space		

Source: Dataquest (November 1997)

### Broadcasters

Broadcasters face a dizzying array of choices when addressing the issue of DTV. With no standards for display and two powerful camps vying for their support, broadcasters have to decide which horse to bet on, while keeping a close eye on the actions of the government. With limited bandwidth available, each broadcaster will have to decide how it will utilize its allotted spectrum. Each choice has trade-offs. If a broadcaster chooses to provide an HDTV channel, it leaves less room for other channels or for data services. If a broadcaster opts to offer multiple channels of SDTV, it will leave no room for an HDTV channel and less room for data services. Executives from NBC and CBS have indicated they will provide at least some of the type of HDTV broadcasting supported by consumer electronics manufacturers and the ATSC. While Microsoft has been actively lobbying the broadcasters to support HD-0, as of yet none of the networks has endorsed it publicly. The choice that broadcasters make will determine the direction of DTV in the United States. A choice in favor of HDTV and interlaced scanned broadcasting would benefit supporters of the ATSC specification within the consumer electronics industry. A choice in favor of SDTV, even without progressive scanning, is generally seen as a victory for the PC industry and the DTV team.

### Politics

The federal government is playing a major role in the development of DTV in the United States, affecting both its content and its rate of growth. ABC in August said it would use its spectrum to offer multiple channels of pay television in the SDTV resolution, rather than HDTV. However, Senator John McCain stepped in, saying the network had reneged upon an implicit promise to use its government-furnished spectrum for high-quality, free HDTV. Mr. McCain, who is chairman of the Senate Commerce, Science and Transportation Committee, criticized ABC, but did not recommend any specific action to be taken against it. ABC quickly capitulated, making a statement assuring the public that it would broadcast at least some HDTV programming. The federal government also has determined that it will reclaim the networks' existing analog spectrum in 2006, forcing broadcasters to go over entirely to digital broadcast. However, the networks have been attempting to delay the planned analog take-back or stop it altogether.

### Cost

The high cost of DTV receivers could slow the acceptance of the product in the United States. Initial DTV receivers in the United States are expected to be high-priced HDTV sets with consumer price tags as high as \$12,000. This is because of the high semiconductor cost and expensive displays used in such televisions. HDTVs will have to be capable of receiving and displaying DTV signals in all resolutions, requiring a high-level MPEG-2 decoder and large densities of DRAM. HDTVs also will utilize more expensive projection and direct view display technologies than conventional television.

### DTV in Other Regions

In Europe, the path to DTV has been much smoother than in the United States. All European manufacturers and countries have agreed upon the DVB-T standard for terrestrial digital video broadcast. Table 2-26 summarizes the DVB specification. Initial DVB-T broadcasts are expected to begin in mid-1998. Unlike the United States, where the first DTV receivers will be high-priced HDTV receivers, in Europe the market will begin with relatively low-cost DTV set-top boxes. From a functional and cost standpoint, the European DTV receivers will resemble the DVB set-top boxes already in wide use in digital satellite systems around the world. In Japan, a standard is being developed for digital broadcasting that is expected to incorporate HDTV. The first televisions complying to the new standard are expected to be ready in the year 2000.

**Table 2-26**  
**DVB 1.0 Specification**

Feature	Specification
Resolution	640 x 480
Video Compression	MPEG-2 main level, main profile
Audio Compression	MUSICAM
Modulation	64-QAM for hard-wired networks (cable and telco)
Upstream Data Rates	1.544 Mbps and 256 Kbps

Source: Dataquest (November 1997)

## DVD Video Players

The development of DVD continues to ride along a dangerous roller coaster course. DVD is the next generation of compact disc technology that is predicted to impact significantly consumer VCRs, as well as computer delivery of digital content, because of its several-gigabyte storage capabilities. Development of products and markets has been confused and delayed by heavyweight competitors promoting separate technologies and standards. On multiple occasions it has appeared that a critical mass has been reached and basic standards and agreements have been put in place. However, just as expectations begin to mount that the market will begin to get on track, a new competing standard or technology is introduced that leads to delays while a new round of negotiation and strategic intrigue plays out.

In September 1995, Philips, Sony, and Toshiba announced an agreement to develop a single standard for DVD. The agreement put an end to a 10-month format war between two camps that was similar to the one that occurred in the early 1980s between the opposing consumer videotape camps, Beta and VHS. The agreement ended almost 10 months of format competition between the two primary camps: Multimedia CD (MMCD), led by Sony and Philips, and the Super Density (SD) alliance, led by Toshiba, Matsushita, and Time Warner.

From the perspective of the different manufacturers, perhaps the most important issue to be resolved is intellectual property rights. An immediate difficulty is the sheer number of companies involved in the DVD-format unification. At least nine companies have staked claims to become license holders: Sony, Philips Electronics, Thomson Multimedia, Hitachi, Matsushita, Toshiba, Mitsubishi, Pioneer, and JVC. Unable to reach an agreement in the DVD Consortium, Sony and Philips broke from the group negotiation as the end of 1996 was approaching and announced that they would license their patents independently. They invited other companies to join them in an attempt to bring DVD products to the market before the end of 1996.

In the announcement of the initial DVD agreement, the parties stated their intent to release a final specification in December 1995. This was followed by promises to release the final specification almost every month during 1996. During this period additional difficulties were encountered because of disputes between Hollywood and the PC community over copy protection. This issue was finally addressed through agreement on a copy protection system called Content Scrambling System (CSS).

Eager to ship products to the market before the end 1996, limited DVD Video player shipments began in Japan in November 1996. However, this first rollout was commonly considered to be a major disappointment and hopes for stimulating the market were placed on the U.S. market. The first U.S. DVD Video player introductions took place in the first quarter of 1997. Most plans assumed that the first nine months would be used for market development in the United States followed by a major sales push during the November and December holiday shopping season.

The Consumer Electronics Manufacturers Association (CEMA) reported that by the end of September, slightly more than 200,000 DVD Video players had been shipped to retailers. The number of these systems that had been purchased by consumers was a matter of debate. However, it began to appear that a U.S. market of 400,000 units and a worldwide market of 750,000 units was within reach. However, announcement of a new standard called Digital Video Express (Divx) was made in September.

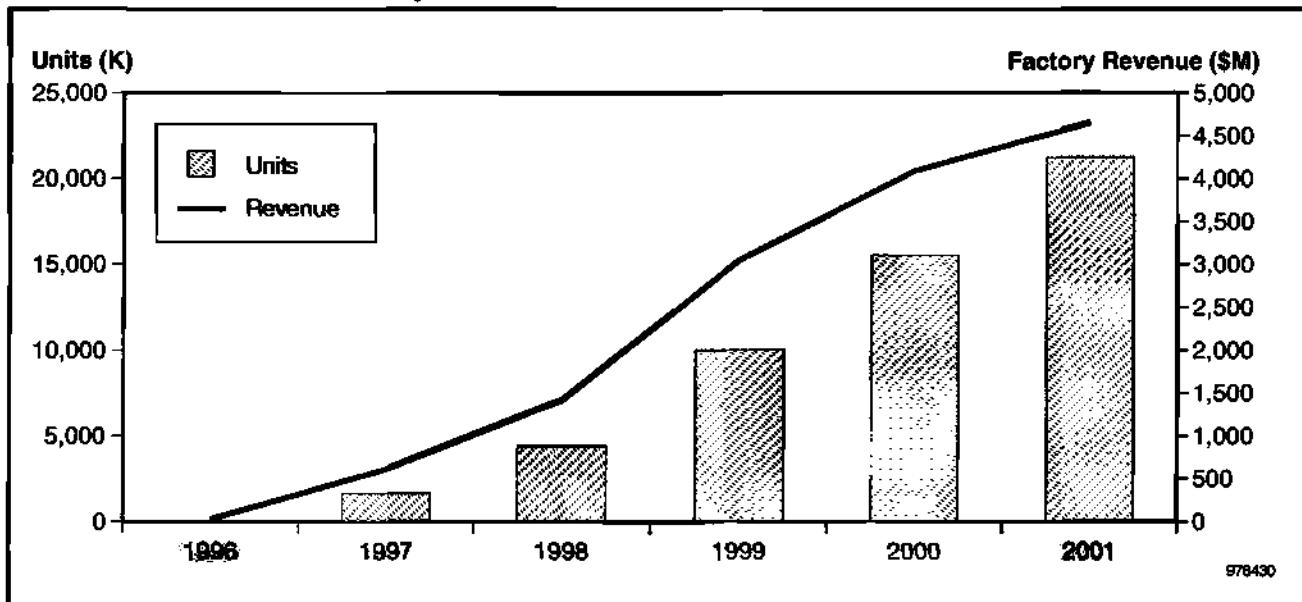
The Divx standard was developed by Circuit City in partnership with a major entertainment law firm and has the backing of several major studios, such as Disney. As described by its promoters, Divx uses a triple-DES (Data Encryption Standard) encryption scheme that more effectively protects the movies from illegal copying. This has resulted in favorable reaction from the major movie studios. For the consumer, Divx promises the capability to rent Divx discs without having to return them and suffer possible late penalties. This capability is enabled by a modem in the Divx

player that calls a billing center, which tracks usage of the titles that are played in it. On the negative side, Divx players will not be available until summer 1998, and they will cost \$100 more than DVD players. Also, DVD players will not be able to play Divx titles.

The Divx standard is not the only new element to roil the DVD market. New fronts of competition have opened up surrounding the recordable technologies for DVD. When the DVD Forum announced the final DVD-R and DVD-RAM standards in mid-1997, Sony and Philips announced a competing product called DVD+RW. At least two other groups have also announced rewritable optical storage technologies that will compete with the official DVD standards.

All of these developments in the last half of 1997 have introduced a major level of confusion in the market and are likely to delay the DVD market by more than 12 months. The DVD Video player forecast shown in Figure 2-18 and Table 2-27 should now be considered optimistic forecasts. While Dataquest continues to remain cautiously optimistic about the long-term prospects of the DVD market, further delays will seriously harm the market and allow electronic video delivery options such as digital cable to compete for this segment.

**Figure 2-18**  
**Worldwide DVD Video Player Production Forecast**



Source: Dataquest (November 1997)

**Table 2-27**  
**Worldwide DVD Video Player Production Forecast**

	1996	1997	1998	1999	2000	2001	CAGR (%) 1996-2001
Units (K)	65	1,642	4,390	10,017	15,539	21,234	218.5
Factory ASP (\$)	441	375	324	305	263	219	-13.0
Factory Revenue (\$M)	29	615	1,423	3,055	4,089	4,654	177.0
Semiconductor Content (\$)	147	130	122	114	105	94	-8.5
Semiconductor Market (\$M)	9	214	536	1,144	1,630	1,994	191.4
<b>Regional Production Trends (Percentage of World by Unit Production)</b>							
Americas	0	0	0	0	0	0	+
Europe	0	2	2	1	1	1	-
Japan	100	21	18	13	16	17	-
Asia/Pacific	0	77	81	86	84	82	-

Source: Dataquest (November 1997)

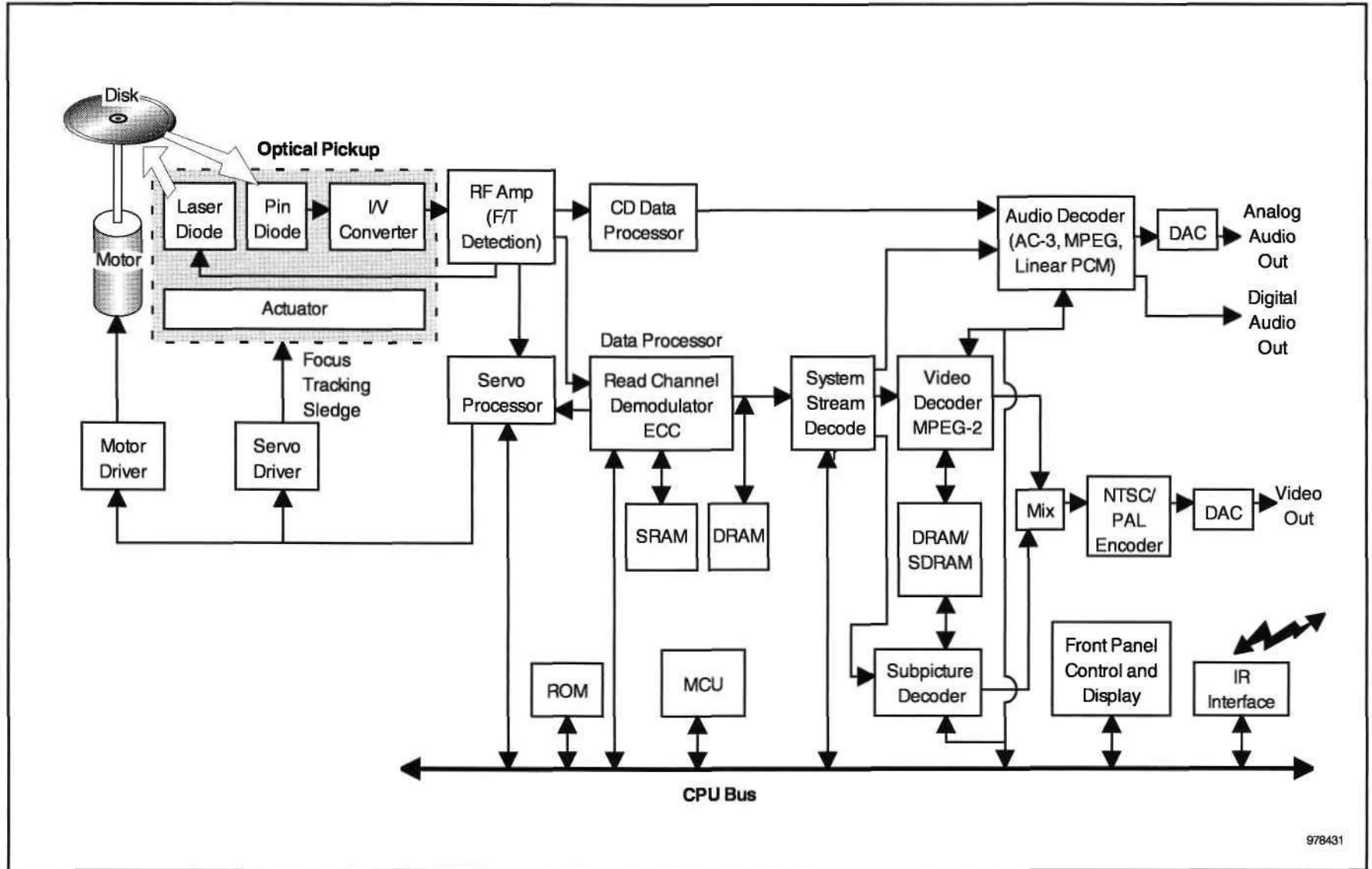
Figure 2-19 shows a representative block diagram of a DVD Video player. Some of the important elements of the DVD-ROM format that have been agreed to are as follows:

- 4.7GB storage in a single layer
- Dual-layer and double-sided discs
- Backward-compatibility with all current CDs
- MPEG-2 video compression
- AC-3, MPEG-2, and Linear PCM audio compression
- Compatibility between computer-based and consumer-based (television) products
- 0.6mm x 2 substrate thickness, bonded disc
- EFM Plus modulation/demodulation
- Reed-Solomon error-correction code

Some of the important issues related to the rollout and development of DVD players are as follows:

- Initial pricing for DVD players was targeted at \$500. Instead, typical pricing of early players ranges between \$600 and \$700 with some models climbing to \$1,000 and above. Only very low-end models had hit street prices just under \$500 by mid-1997. Divx players are expected to cost \$100 over comparable DVD players.
- There are now at least four competing rewritable standards: DVD-R and DVD-RAM as defined by the DVD Forum; DVD+RW supported by Sony, Philips, Mitsubishi, Hewlett-Packard, Ricoh and Yamaha; NEC's Multimedia Video File (MMVF) format; and a standard developed by ASMO (Advanced Storage Magneto Optic group). Each of these standards makes competing claims for superiority based on key items such as storage capacity, cost, and compatibility with DVD-ROM.

Figure 2-19  
Representative DVD-ROM Video Player Block Diagram



Source: Dataquest (November 1997)

978431

- The competition between the formal DVD standard and the Divx format should occupy center stage in most DVD discussions for the next year. Competing surveys have been announced showing either highly positive consumer reaction to Divx or extremely negative reaction. All comments from the Divx management indicates that their focus will be purely on the consumer player market. They have stated very clearly that opportunities in the PC market will be a very minor consideration for the next two to three years. If this is true, one of the key benefits of PC and consumer product convergence would be lost. Also, the only current market where Divx is being promoted is the U.S. There are no announced plans for Divx in other regions at this writing. The bottom line is that significant confusion continues to beset DVD and its related markets as the end of 1997 approaches.

## Video CD Players

The market for early-generation video disc players, Video CD, has grown much more quickly than called for by early predictions. Production of Video CD players reached 7 million units in 1996 and are on target to hit 15 million units in 1997, making this one of the most successful product introductions in the consumer electronics industry. Although Video CD is virtually unknown in the Americas, it enjoys enormous popularity in Japan, China and the Asia/Pacific region. The most popular use of Video CD is in karaoke applications. Video CDs are also finding their way into PC applications. Manufacturers from Japan, Korea, Taiwan, and China are all competing in this market. Over 90 percent of the market and production of Video CD products is in China. As shown in Table 2-28 and Figure 2-20, Dataquest expects this market to continue its rapid expansion through 1998 with growth tapering off in 1999 and then declining as DVD competition increases approaching the year 2000.

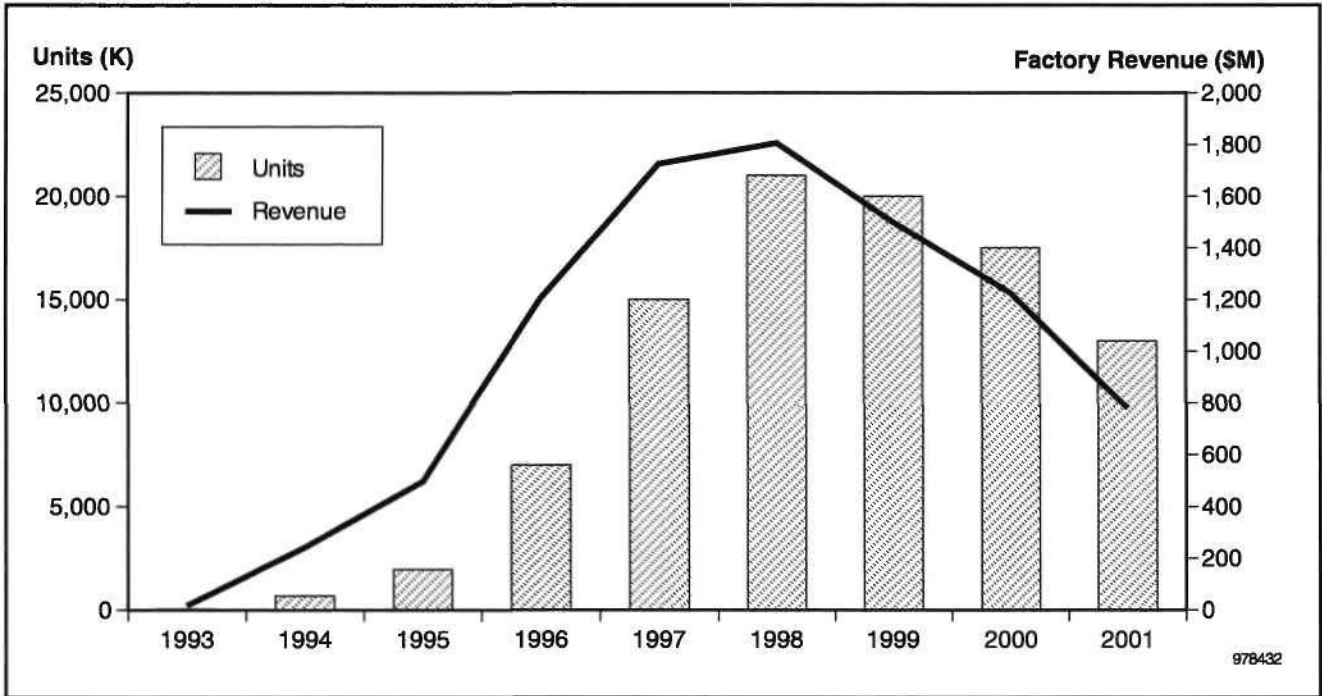
These players use MPEG-1 technology and allow 74 minutes of storage for full-motion video. Figure 2-21 shows a block diagram for a Video CD system. At 352 x 240/288 pixels, Video CD's resolution is limited but has still found many applications in portable players and minicomponent systems, many of which use LCD displays.

**Table 2-28**  
**Worldwide Video CD Player Production Forecast**

	1993	1994	1995	1996	1997	1998	1999	2000	2001	CAGR (%) 1996-2001
Units (K)	38	685	1,950	7,000	15,000	21,000	20,000	17,500	13,000	13.2
Factory ASP (\$)	460	354	255	172	115	86	75	70	60	-19.0
Factory Revenue (\$M)	17	242	497	1,204	1,725	1,806	1,500	1,225	780	-8.3
Semiconductor Content (\$)	120	101	85	71	38	30	28	25	22	-20.9
Semiconductor Market (\$M)	5	69	166	496	574	636	551	445	285	-10.5

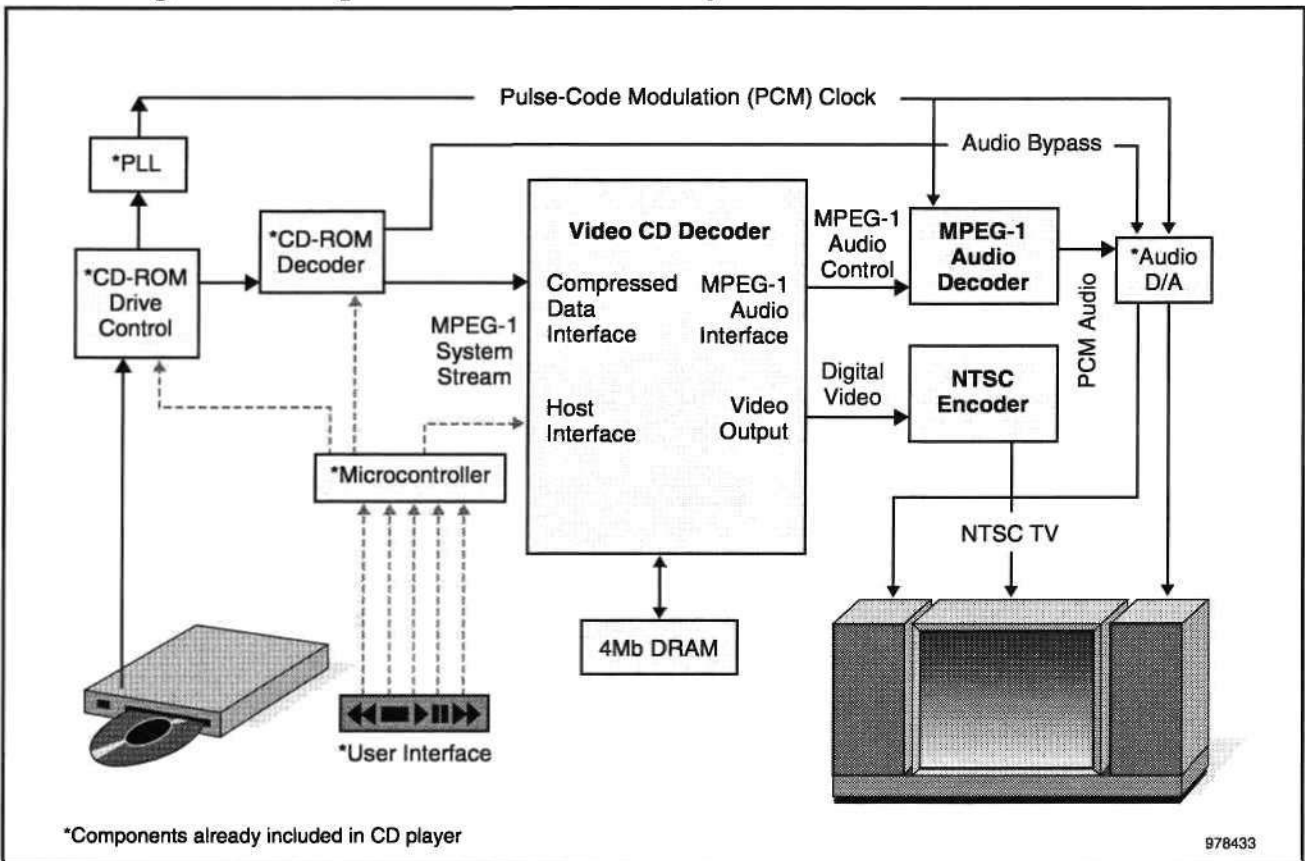
Source: Dataquest (November 1997)

**Figure 2-20**  
**Worldwide Video CD Player Production Forecast**



Source: Dataquest (November 1997)

**Figure 2-21**  
**Block Diagram of a Representative Video CD System**



Source: Dataquest (November 1997)



There are numerous Video CD models, and it is estimated that there were over 7,000 Video CD software titles available in 1996. Of this number, 3,000 were karaoke titles and 60 percent were targeted at non-Japanese markets. This number should expand dramatically as Video CD players are introduced in India, with its prolific movie industry. One of the major issues surrounding Video CD has been the large pirate movie industry associated with it. This has probably added to its success. Trade negotiations between China and the United States in 1996 focused on this issue, and a new agreement has been reached on intellectual property protection. Following this agreement, Warner Home Video and MGM/UA announced licensing agreements with one of China's largest manufacturers and distributors of Video CD and laser disc (LD) hardware and software.

C-Cube Microsystems Inc. has been one of the major semiconductor winners in the Video CD market, with design-wins for its MPEG-1 decompression chips in all market leaders and a large majority of other Video CD manufacturers. Because of its dominant position in this market C-Cube was able to hold pricing for the MPEG-1 chipset at over \$30 for most of 1996. However, ESS Technology took the market by storm in the fourth quarter of 1996 and captured a major share of the market. The price war that took place between C-Cube and ESS Technology drove pricing for the Video CD chipsets to the low-teens by the second half of 1997. Oak Technology Inc. is another chip company competing for the merchant market MPEG-1 chip business in Video CD players.

## Chapter 3

# Interactive Products and Personal Electronics

Interactive consumer products include those that allow users real-time control of information presented on the TV screen. The primary examples covered here include interactive television and associated set-top decoder boxes and video games. Some visionaries are projecting that these technologies may merge, at least in part, in the coming decade with each other or with the standard TV set.

### Interactive Television and Set-Top Box Definitions

"Set-top box" is a generic term that means different things to different industries. The seven product categories presented in Table 3-1 have all been referred to as "set-top boxes," based merely on their location in relation to the TV set.

This section will focus on the first category, pay-TV receivers. Within the combined pay-TV industries, the terminology used is "subscriber terminal." Figure 3-1 presents a diagram of an interactive system that shows how a subscriber terminal would be used in a cable, satellite, or telephone system. The following terms are also synonymous with pay-TV receivers:

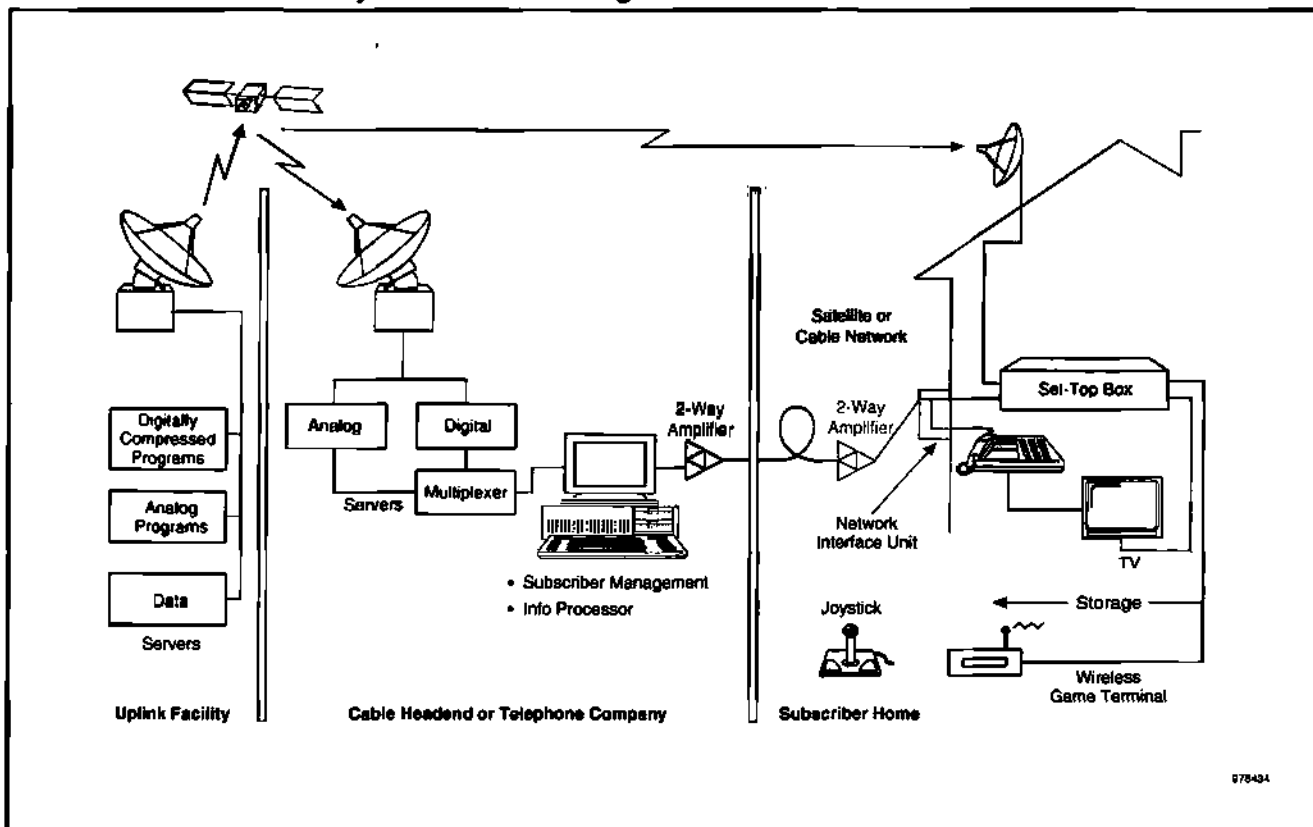
- Integrated receiver/decoder (IRD): satellite industry
- Customer-premises equipment (CPE): telco industry
- Subscriber terminal, cable converter: cable industry
- Compuverter, pay-TV receivers

**Table 3-1**  
**Descriptions of Various Products Referred to as "Set-Top Boxes"**

Product	Description
Pay-TV Receivers	Includes cable, DBS, C-band satellite, MMDS, LMDS, and now telco
Dedicated Game Consoles	Examples: Sony PlayStation and Sega Saturn
Read-Only Multimedia Computers	Examples: 3DO and Philips CD-I. Formerly known as Dataquest as TV CD-ROM players. This category is being replaced by dedicated game consoles.
Backchannel Transmitters	Allow user to play along with networked sports and game shows—TV Answer, for example
Audio and Data Decoders	Used for nonvideo signals transmitted out-of-band in the vertical blanking interval, in-band video, or in-band audio. Include digital cable radio and closed captioning.
Navigational Systems	A special type of data decoder for electronic programming guides. Dedicated hardware systems exist, but most are being integrated into pay-TV receivers. Examples include StarSight, Prevue Network, and Interactive TV Guide
Data Storage Devices	Examples are VCR-Plus and Sega Channel Game Adapter

Source: Dataquest (September 1996)

**Figure 3-1**  
**Interactive Television Systems Block Diagram**



Source: Dataquest (November 1997)

Subscriber terminals are further divided into the following four subcategories by technology:

- Nonaddressable analog
- Addressable analog
- Advanced analog (includes addressability and upstream communications)
- Digital

A digital set-top box includes a digital video decoder for receiving digitally encoded TV signals. The compression schemes are typically MPEG-2, but also include General Instrument's DigiCipher I and DigiCipher II. The difference between addressable analog boxes and advanced analog boxes is that advanced boxes also include an embedded modem for upstream communications. Embedded modems are the basic semiconductor components for receiving interactive services. Cable modems fall into a separate category, more closely related to PC modems than to set-top boxes. As subscriber terminals move from nonaddressable to addressable to advanced analog and finally to digital, almost every major component maker is eyeing this market as a major application area.

## Markets for Subscriber Terminals

The following six network systems represent potential markets for subscriber terminals:

- Cable TV
- C-band satellite (also known as full-view satellite)
- Ku-band satellite (also known as DBS and DTH)
- Wireless cable (also known as MMDS)
- Cellular cable (also known as LMDS)
- Telco

## Production and Market Forecast

Analog terminals are being buoyed temporarily by new sales of advanced analog terminals. However, shipments of new digital set-top boxes will overtake their analog predecessors by 1998.

Because of the controlled nature of the cable equipment business, competition in the set-top box market has been limited. With consumers given no choice of boxes to buy, analog set-top box pricing has been frozen, remaining at a selling price of about \$105 for the last 10 years. However, the advent of digital technology and associated standards have totally rewritten the rules in the set-top box market and have significantly brought down prices.

In 1996, a full-scale price war broke out among satellite television service providers in the United States. With a one-year service deal and rebate, consumers were able to purchase satellite set-top boxes from various manufacturers and service providers for as little as \$50 in some parts of the country. This price is far below the estimated factory price of \$404 in 1996. Box makers have moved to integrate the silicon content of their boxes to bring costs more in line with consumer prices.

The aggressive price reductions in digital set-top boxes in the second half of the year helped that market to grow in 1996. The rapid increases in satellite subscriptions took a toll upon the cable industry, which lost about 1 million subscribers to satellite in 1996, according to CEMA. Cable service providers responded with aggressive moves toward digital technology. By late 1996, over 100,000 digital cable boxes had been manufactured. 1997 has seen a slowdown in the rate of new digital satellite television subscriptions in the United States.

However, European and Asian systems are beginning to increase their subscriber rolls, accounting for much of the increase in production for the year. In the United States, digital cable is moving into higher gear, with General Instrument (Now NextLevel Systems) alone expected to account for more than 1 million boxes produced in the year.

Tables 3-2 through 3-4 show Dataquest's forecast for worldwide analog set-top box production, the Americas analog set-top box market, and the Americas analog set-top box production, respectively. Table 3-5 and

Figures 3-2, 3-3, and 3-4 present the forecast for worldwide and regional digital set-top box production and average selling price forecast. Tables 3-6 and 3-7 show the Americas market and production forecast for digital set-top boxes. Figures 3-5 and 3-6 show worldwide and regional share of production by revenue for digital set-top boxes.

**Table 3-2**  
**Worldwide Analog Cable/Satellite Set-Top Box Production Forecast**

	1993	1994	1995	1996	1997	1998	1999	2000	2001	CAGR (%) 1996-2001
Units (K)	10,719	12,233	11,505	11,559	10,937	9,891	7,118	6,639	6,175	-11.8
Factory ASP (\$)	103	113	114	98	87	80	76	71	66	-7.6
Factory Revenue (\$M)	1,104	1,382	1,313	1,135	956	791	538	471	409	-18.5
Semiconductor Content (\$)	42	46	47	41	38	35	32	30	28	-7.4
Semiconductor Market (\$M)	454	560	541	473	415	345	228	199	172	-18.3
<b>Regional Production Trends (Percentage of World by Unit Production)</b>										
Americas	50	50	43	41	41	43	32	29	24	-
Europe	40	41	44	45	40	29	22	15	8	-
Japan	3	3	3	3	2	2	3	2	2	-
Asia/Pacific	6	6	9	12	16	26	43	54	65	-

Source: Dataquest (November 1997)

**Table 3-3**  
**Americas Analog Cable/Satellite Set-Top Box Market Forecast**

	1993	1994	1995	1996	1997	1998	1999	2000	2001	CAGR (%) 1996-2001
Units (K)	4,860	5,490	4,500	4,230	4,050	3,870	2,070	1,710	1,350	-20.4
Factory ASP (\$)	103	113	114	98	89	82	82	81	80	-3.9
Factory Revenue (\$M)	501	620	513	416	360	317	171	139	109	-23.6

Source: Dataquest (November 1997)

**Table 3-4**  
**Americas Analog Cable/Satellite Set-Top Box Production Forecast**

	1993	1994	1995	1996	1997	1998	1999	2000	2001	CAGR (%) 1996-2001
Units (K)	5,400	6,100	5,000	4,700	4,500	4,300	2,300	1,900	1,500	-20.4
Factory ASP (\$)	103	113	114	98	89	82	82	81	80	-3.9
Factory Revenue (\$M)	556	689	570	462	401	353	190	154	121	-23.6
Semiconductor Content (\$)	42	46	50	42	39	35	32	31	30	-6.4
Semiconductor Market (\$M)	228	281	250	196	176	151	74	58	45	-25.5

Source: Dataquest (November 1997)

**Table 3-5**  
**Worldwide Digital Cable/Satellite Set-Top Box Production Forecast**

	1993	1994	1995	1996	1997	1998	1999	2000	2001	CAGR (%) 1996-2001
<b>Cable Converters</b>										
Units (K)	8	20	63	277	1,450	3,197	5,772	8,629	12,540	114.4
Factory ASP (\$)	900	509	437	473	389	330	290	258	231	-13.4
Factory Revenue (\$M)	7	10	28	131	564	1,056	1,676	2,225	2,891	85.8
Semiconductor Content (\$)	479	287	208	202	176	153	141	132	123	-9.5
Semiconductor Market (\$M)	4	6	12	56	255	489	815	1,139	1,539	94.0
<b>Satellite Converters</b>										
Units (K)	1	874	2,841	5,490	6,734	9,753	12,620	15,777	17,441	26.0
Factory ASP (\$)	900	465	474	433	328	278	260	237	219	-12.8
Factory Revenue (\$M)	0	406	1,347	2,378	2,208	2,713	3,276	3,736	3,818	9.9
Semiconductor Content (\$)	400	262	200	180	141	107	105	99	97	-11.7
Semiconductor Market (\$M)	0	229	568	990	951	1,048	1,321	1,555	1,686	11.2
<b>Total Digital Converters</b>										
Units (K)	9	894	2,904	5,767	8,184	12,950	18,392	24,405	29,980	39.1
Factory ASP (\$)	900	466	473	435	339	291	269	244	224	-12.4
Factory Revenue (\$M)	8	416	1,374	2,509	2,772	3,769	4,952	5,961	6,710	21.7
Semiconductor Content (\$)	474	263	200	181	147	119	116	110	108	-9.9
Semiconductor Market (\$M)	4	235	580	1,046	1,206	1,537	2,136	2,694	3,225	25.3
<b>Regional Production Trends (Percentage of World by Unit Production)</b>										
Americas	94	98	73	48	42	36	35	32	31	-
Europe	6	2	12	29	32	36	37	39	38	-
Japan	0	0	5	9	8	6	5	4	4	-
Asia/Pacific	0	0	11	13	19	22	23	25	27	-

Source: Dataquest (November 1997)

**Table 3-6**  
**Americas Digital Cable/Satellite Set-Top Box Market Forecast**

	1993	1994	1995	1996	1997	1998	1999	2000	2001	CAGR (%) 1996-2001
<b>Cable Converters</b>										
Units (K)	7	18	51	8	225	914	2,156	3,055	3,972	245.2
Factory ASP (\$)	900	509	483	443	368	324	285	251	221	-13.0
Factory Revenue (\$M)	6	9	25	4	83	296	614	766	877	200.3
<b>Satellite Converters</b>										
Units (K)	0	771	1,849	2,504	2,831	3,317	3,649	4,014	4,473	12.3
Factory ASP (\$)	0	462	439	404	333	300	294	281	269	-7.8
Factory Revenue (\$M)	0	357	812	1,011	942	995	1,074	1,126	1,204	3.6

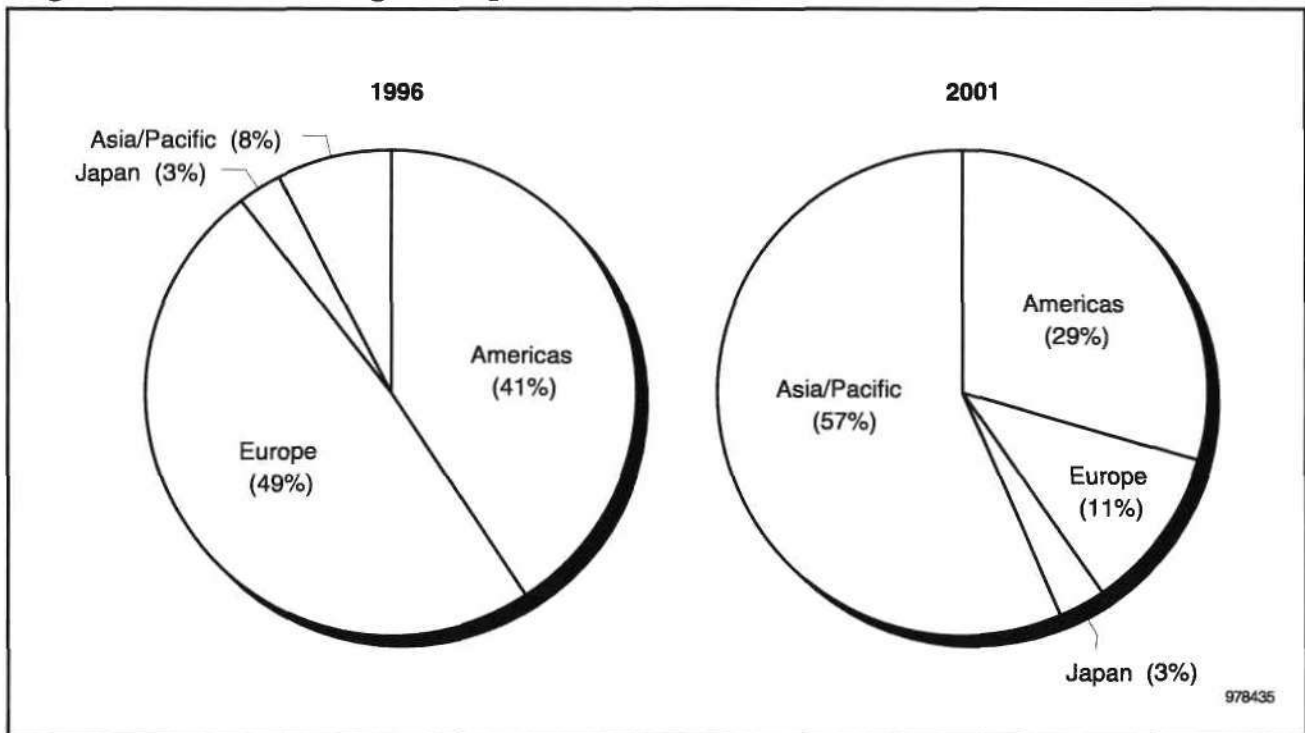
Source: Dataquest (November 1997)

**Table 3-7**  
**Americas Digital Cable/Satellite Set-Top Box Production Forecast**

	1993	1994	1995	1996	1997	1998	1999	2000	2001	CAGR (%) 1996-2001
<b>Cable Converters</b>										
Units (K)	8	20	57	9	250	1015	2,395	3,395	4,413	245.2
Factory ASP (\$)	900	509	483	443	368	324	285	251	221	-13.0
Factory Revenue (\$M)	7	10	28	4	92	329	683	851	974	200.3
Semiconductor Content (\$)	479	287	204	197	172	141	138	133	127	-8.4%
Semiconductor Market (\$M)	4	6	12	2	43	143	329	452	560	216.3
<b>Satellite Converters</b>										
Units (K)	0	857	2,054	2,782	3,146	3,686	4,054	4,460	4,970	12.3
Factory ASP (\$)	0	462	439	404	333	300	294	281	269	-7.8
Factory Revenue (\$M)	0	396	902	1,124	1,047	1,106	1,193	1,251	1,338	3.6
Semiconductor Content (\$)	0	261	185	179	156	128	125	121	118	-8.0
Semiconductor Market (\$M)	0	223	381	498	490	473	507	540	586	3.3
<b>Total Digital Converters</b>										
Units (K)	8	877	2,111	2,791	3,396	4,701	6,449	7,855	9,383	27.4
Factory ASP (\$)	900	463	440	404	335	305	291	268	246	-9.4
Factory Revenue (\$M)	7	407	930	1128	1139	1435	1876	2103	2312	15.4
Semiconductor Content (\$)	479	261	186	179	157	131	130	126	122	-7.4
Semiconductor Market (\$M)	4	229	392	500	533	616	836	991	1,147	18.1

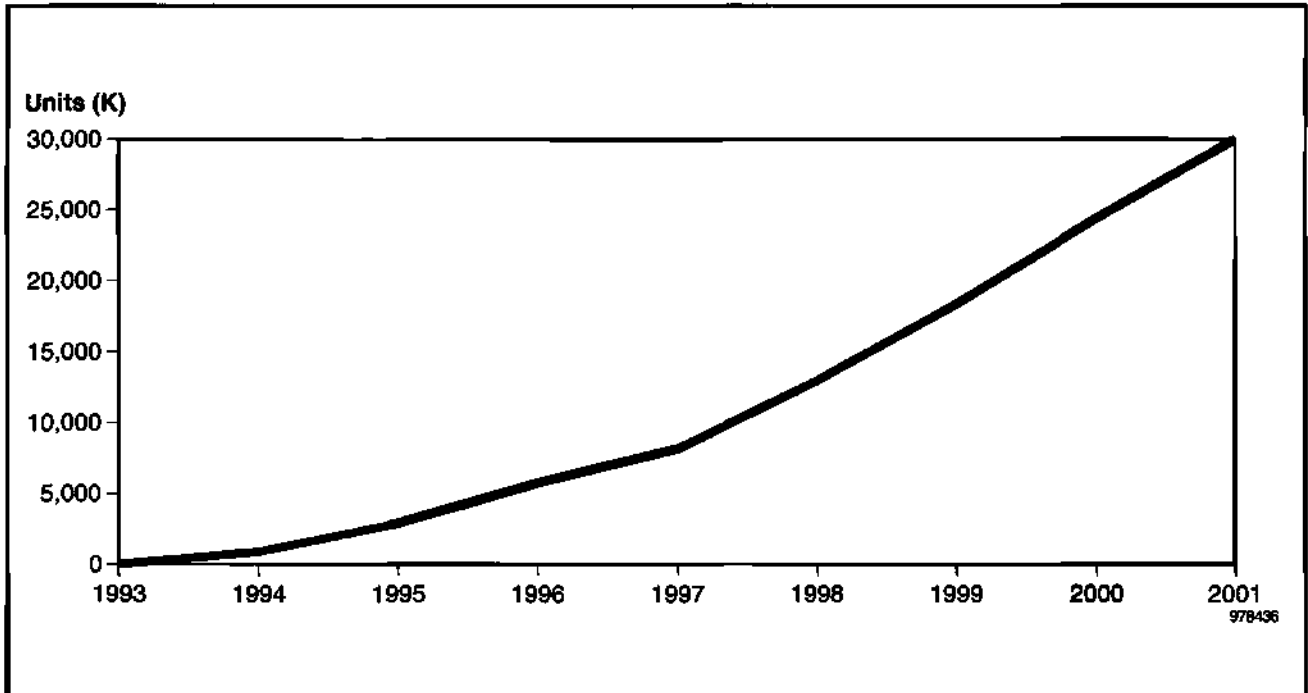
Source: Dataquest (November 1997)

**Figure 3-2**  
**Regional Share of Analog Set-Top Box Production Revenue**



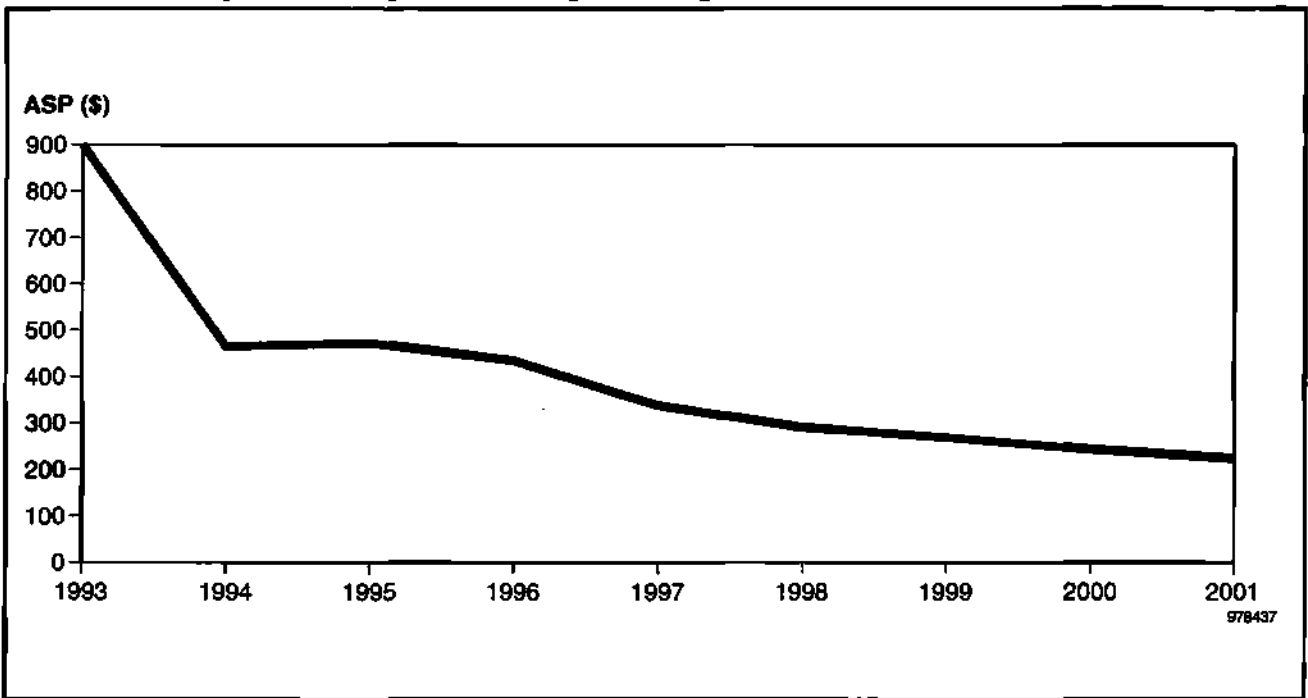
Source: Dataquest (November 1997)

**Figure 3-3**  
**Worldwide Digital Set-Top Box Production Forecast**



Source: Dataquest (November 1997)

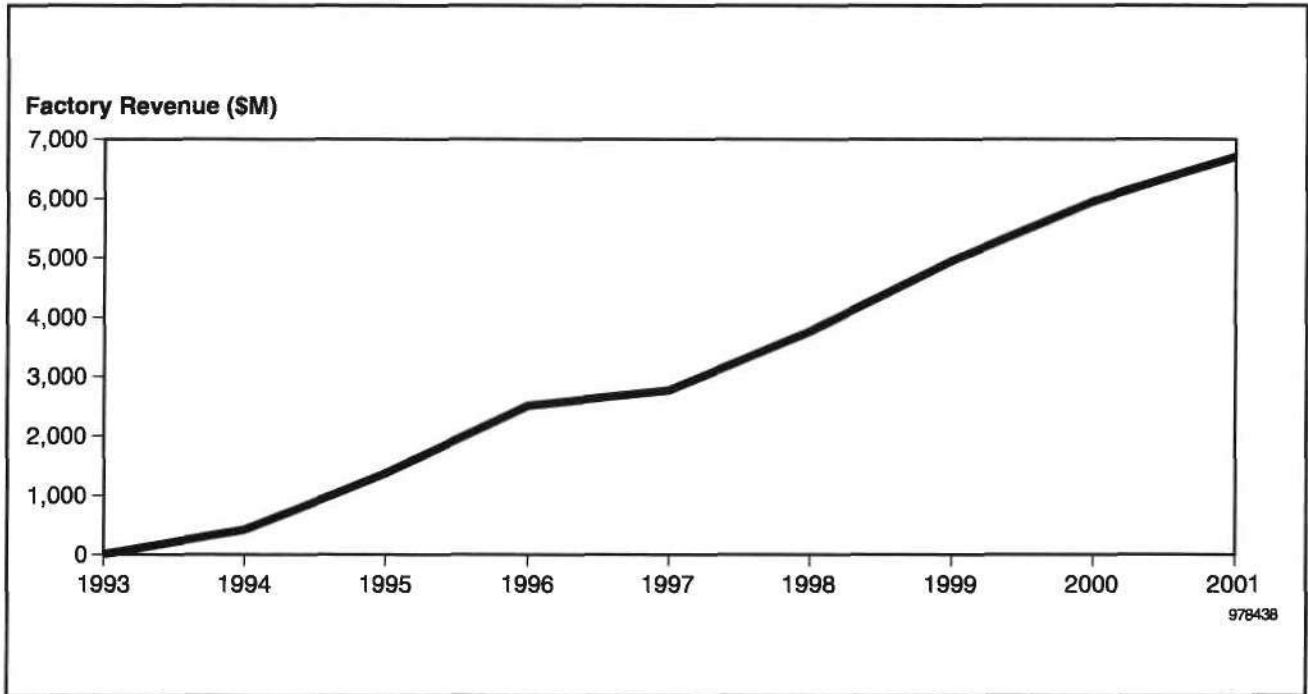
**Figure 3-4**  
**Worldwide Digital Set-Top Box Average Selling Price Forecast**



Source: Dataquest (November 1997)

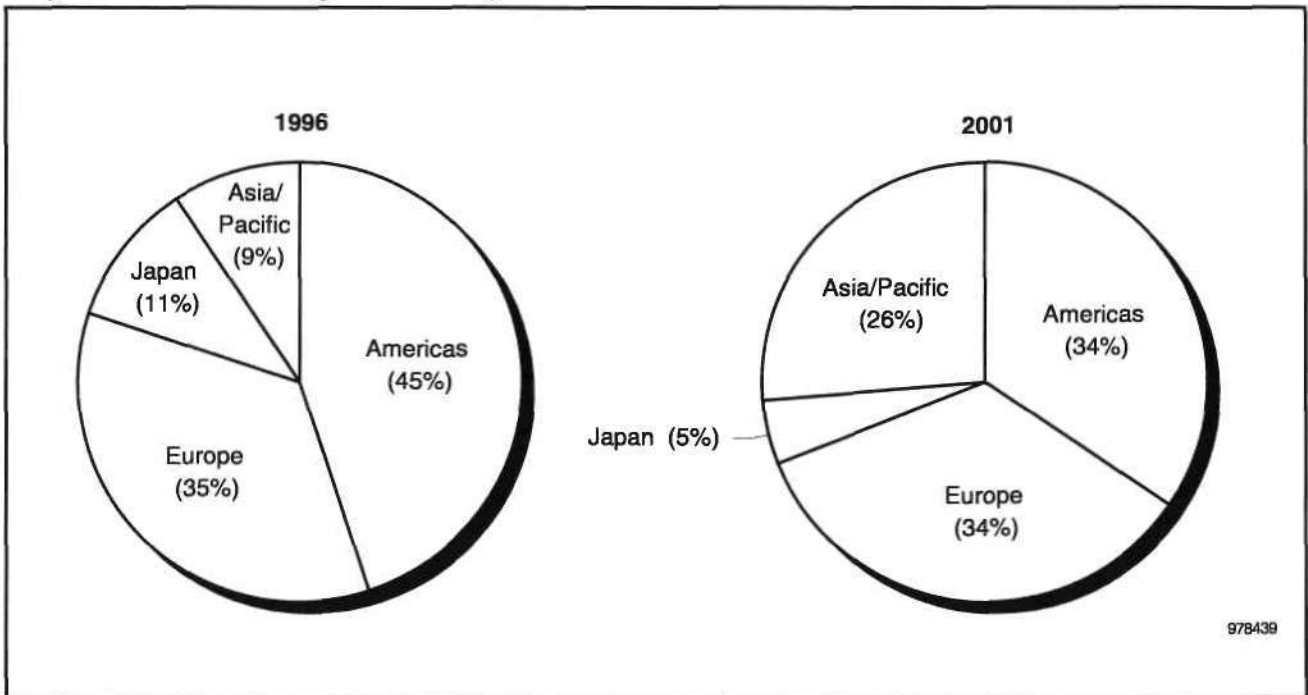


**Figure 3-5**  
**Worldwide Digital Set-Top Box Factory Revenue Forecast**



Source: Dataquest (November 1997)

**Figure 3-6**  
**Regional Share of Digital Set-Top Box Production Revenue**



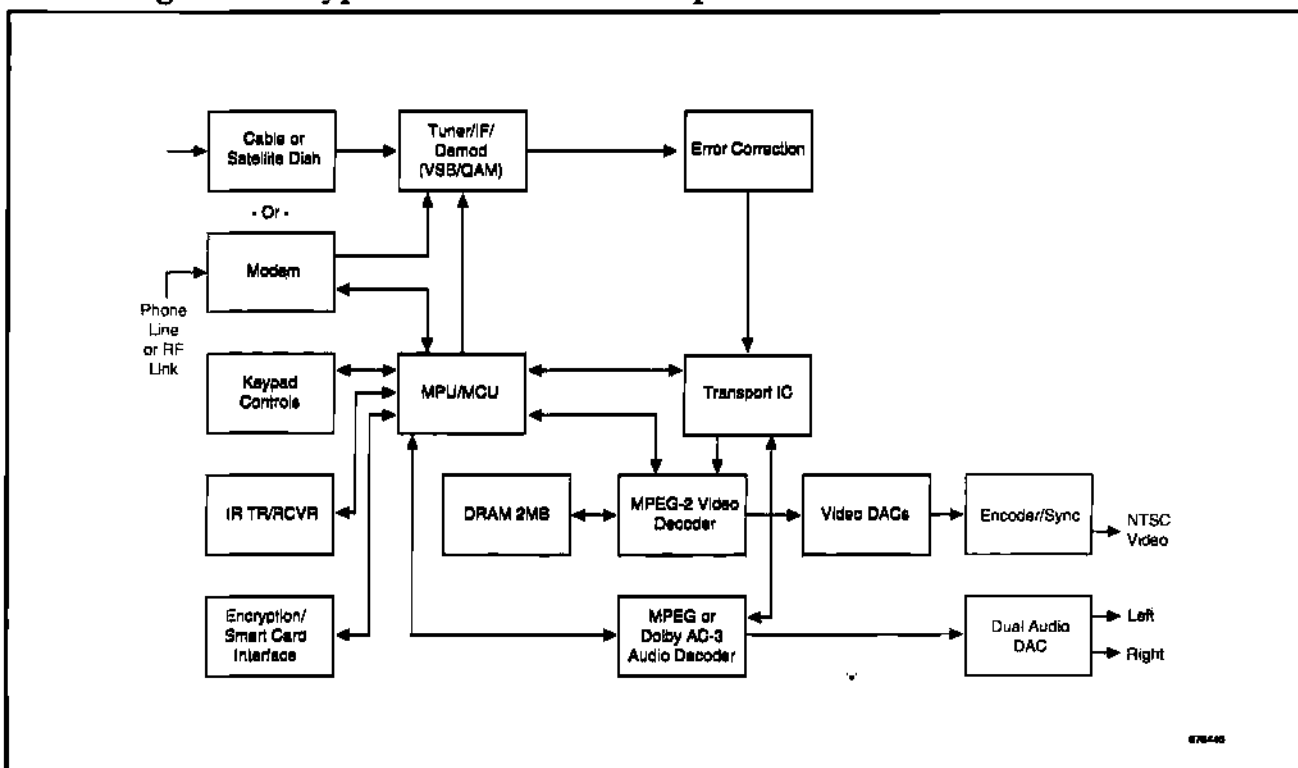
Source: Dataquest (November 1997)

## Technology Requirements

Figure 3-7 presents a generic block diagram of the type of technology required in a digital satellite set-top box. A generic digital set-top box requires a variety of technologies ranging from RF to CMOS (see Table 3-8). Likewise, the opportunities range from standard products to ASICs as the box OEMs wrestle with design and cost structure issues. The satellite set-top box market is increasingly characterized by the use of standard products, while the cable boxes—at least initially—are extremely ASIC-oriented. There are many layers of software involved, and companies including Diba/Sun PowerTV Inc., OpenTV Inc. and Oracle/Network Computer Inc. are offering products ranging from real time operating systems to application programming interfaces (APIs) to end-to-end interactive television application suites. Initial set-top boxes deployed by cable systems service providers are capable of running such software for features including interactive programming guides and Internet access.

Up to this point, digital set-top boxes have been platforms for passive, noninteractive video entertainment. However, digital technology is ushering in a new generation of interactive, two-way television. Service providers are implementing systems that use software from the companies listed above to provide such services. Interactive, two-way television services are being developed for digital cable, XDSL, digital satellite, and other delivery technologies.

**Figure 3-7**  
Block Diagram of a Typical CATV/DBS Set-Top Box



Source: Dataquest (November 1997)

**Table 3-8**  
**Semiconductor Opportunities in Interactive TV**

Semiconductor Function	Technology
Broadband Up/Down Conversion	Bipolar/GaAs
IF Processing	Bipolar
Modulation/Demodulation (VSB, QAM)	CMOS, bipolar
Transport Layer and Error Correction	CMOS
Video Standard Decode/Encode	Bipolar/CMOS
Video DAC	Bipolar
Video Conversion, Scaling	CMOS
Video Compression (MPEG-2, DigiCipher)	CMOS
Audio Conversion	Bipolar/CMOS
Audio Compression (AC-3, MPEG)	CMOS
DRAM	CMOS
VRAM/Field Memory	CMOS
Fast DRAM (SDRAM, FRAM)	CMOS
SRAM	CMOS
MPU (32/64-Bit RISC)	CMOS
Encryption (Decryption) Functions	CMOS
Modem (Up to V Fast)	CMOS
ASICs (for above Functions)	CMOS/bipolar

Source: Dataquest (November 1997)

As shown in Table 3-9, the interactive terminal will require more features in the coming years, including embedded two-way capability, greater processing power, and support for higher-bandwidth transmission links. The digital set-top box of 1995 is capable of digital reception, decompression, and audio/video processing. The video decompression standard primarily is MPEG-2, and audio decompression is mainly MPEG. Line transmission opportunities include 64-level QAM or higher. Error correction is needed to clean up the fast-moving bit stream, decryption for privacy, and a transport layer function for network overhead. As more sophisticated interactive capabilities become available, the hardware requirements of interactive digital set-top boxes will increase. About 2MB of DRAM or tailored field memory is required for decompression buffering. Additional memory is used for code and data storage. Many of the functions initially are ASIC-based, with the overall design controlled by the decoder box companies. Eventually, standard functions will dominate as cost reduction considerations become paramount.

## Manufacturers

Table 3-10 and 3-11 present market shares for manufacturers of digital set-top boxes in 1995 and 1996. Note that the numbers reflect sales and not subscriptions. Thomson Multimedia in 1996 was the world's largest vendor of digital satellite set-top boxes, just as in 1995. The company sold nearly 1.5 million DSS boxes capable of receiving authorized programming from the DirecTV or USSB satellite television services.

**Table 3-9**  
**Interactive Digital Set-Top Box Technology Evolution**

Category	1995	1997	1999
Transmission	Cable: analog; cable: digital test, FM subcarrier; fiber-optic/ADSL tests	Cable: analog, cable: digital initial deployment	Cable/DBS; digital/two-way, IVDS, FM, VBI; fiber-optic, ATM; QAM
Processing	Addressing, pay-per-view; DBS down conversion; Digital video, audio; MPEG decompression, error correction; bipolar/CMOS ASIC	Digital video, audio; MPEG decompression, error correction; bipolar/CMOS ASIC/ASSP	Digital video, audio; high-level MPEG decompression, AC-3 audio decompression, error correction; bipolar/CMOS ASSP
Memory (DRAM)	4MB	4MB	4MB
Others	security/decryption	security/decryption; Internet access capability	Modular design; security/decryption, Internet access capability, high-definition video output

Source: Dataquest (November 1997)

**Table 3-10**  
**Worldwide Digital Cable and Satellite Decoder Revenue Market Share, 1995**

Brand	Unit Market Share (%)	Revenue Market Share (%)
Thomson Consumer Electronics	39.2	37.1
NextLevel (General Instrument)	30.0	30.0
Sony	7.1	7.5
Pace	6.4	6.6
Philips	4.7	4.2
Nokia	4.1	4.4
UEC-Panasonic	3.5	3.6
Pioneer	0.7	0.7
Others	4.4	5.8

Source: Dataquest (November 1997)

General Instrument (now called NextLevel) in 1996 was the second largest vendor of digital set-top boxes, primarily because of sales of systems to the PrimeStar service. The company also shipped a significant number of digital cables boxes during the year. Sony was the third largest seller of digital set-top boxes. The company is a major supplier of DSS boxes in the United States as well as boxes for the PerfectTV system in Japan and services in Europe.

**Table 3-11**  
**Worldwide Digital Cable and Satellite Decoder Revenue Market Share, 1996**

Brand	Unit Market Share (%)	Revenue Market Share (%)
Thomson Consumer Electronics	25.9	24.0
NextLevel (General Instrument)	18.5	18.0
Sony	11.0	10.5
Pace	9.5	10.5
Philips	7.5	8.4
Nokia	4.8	5.4
UEC-Panasonic	3.9	4.1
Hughes Network Systems	3.3	2.4
Sagem	1.7	1.8
Pioneer	0.6	0.6
Grundig	0.3	0.4
Scientific Atlanta	0.1	0.1
Others	12.9	13.7

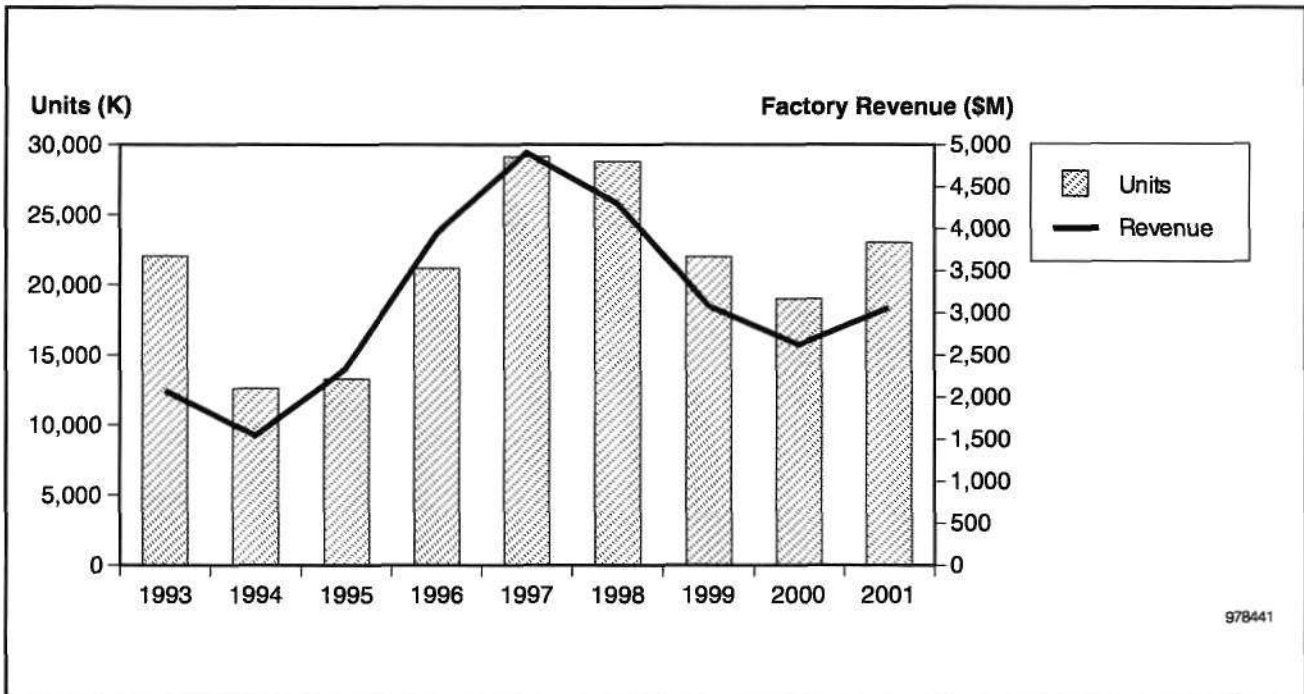
Source: Dataquest (November 1997)

## Interactive Video Games

Figure 3-8 and Tables 3-12 through 3-14 present the production forecast for video game consoles. With the hardware costs being subsidized to an increasing level by software sales and royalties of the manufacturers, the market price and factory price charged to dealers for video game hardware has become disconnected from the true value of the hardware. Figure 3-8 and Table 3-12 represent estimated "factory value" rather than the actual price charged by the factory or factory ASP. This factory value would be analogous to internal transfer pricing. Figure 3-9 shows the regional share of production revenue for video game consoles. Figure 3-10 presents the market share for video game controllers. Figure 3-11 shows worldwide video game controller market share for 1996.

The competition in the video game controller market is becoming a two-horse race. Nintendo introduced its Nintendo 64 platform in 1996 and achieved strong success in the U.S. markets during the 1996 holiday season. Nintendo continues to find strong acceptance in U.S. markets while the Sony PlayStation enjoys great popularity in Japan. Both companies engaged in another round of price cuts in mid-1997 dropping the prices of their systems below \$150. At the same time they have ramped production of their systems to historic levels. In fact, the apparent differential between production levels and end-user market shipments may signal another round of hardware price cuts heading into the 1997 holiday season. A significant round of software price reductions were already announced in the third quarter of 1997.

**Figure 3-8**  
**Worldwide Video Game Controller Production Forecast**



Note: Does not include handhelds  
 Source: Dataquest (November 1997)

**Table 3-12**  
**Worldwide Video Game Controller Production Forecast**

	1993	1994	1995	1996	1997	1998	1999	2000	2001	CAGR (%) 1996-2001
Units (K)	22,045	12,590	13,269	21,177	29,130	28,800	22,000	19,000	23,000	1.7
Factory Value (\$)	94	123	176	186	168	149	140	138	133	-6.5
Factory Revenue (\$M)	2,077	1,542	2,341	3,943	4,904	4,302	3,080	2,622	3,059	-4.9
Semiconductor Content (\$)	36	54	109	104	87	79	81	82	75	-6.2
Semiconductor Market (\$M)	788	682	1,448	2,202	2,535	2,265	1,772	1,551	1,736	-4.6
<b>Regional Production Trends (Percentage of World by Unit Production)</b>										
Americas	0	0	1	0	0	0	0	0	0	-
Europe	0	2	1	1	0	0	0	0	0	-
Japan	83	72	72	67	63	51	19	16	12	-
Asia/Pacific	17	25	26	32	37	49	81	84	88	-

NA = Not applicable  
 Note: Does not include handhelds  
 Source: Dataquest (November 1997)

**Table 3-13**  
**Worldwide Video Game Controller Production Forecast by Type**

	1993	1994	1995	1996	1997	1998	1999	2000	2001	CAGR (%) 1996-2001
8-Bit Players	1,110	400	130	55	30	0	0	0	0	-100.0
16-Bit Players	18,710	8,860	7,349	4,650	1,600	800	0	0	0	-100.0
32-/64-Bit/Future RISC Players	100	1,570	5,123	16,000	27,500	28,000	22,000	19,000	23,000	7.5
TV Set-Top CD-ROM Players	1,525	860	385	435	0	0	0	0	0	-100.0
CD-ROM Peripherals	600	900	281	37	0	0	0	0	0	-100.0
Total	22,045	12,590	13,269	21,177	29,130	28,800	22,000	19,000	23,000	1.7

Source: Dataquest (November 1997)

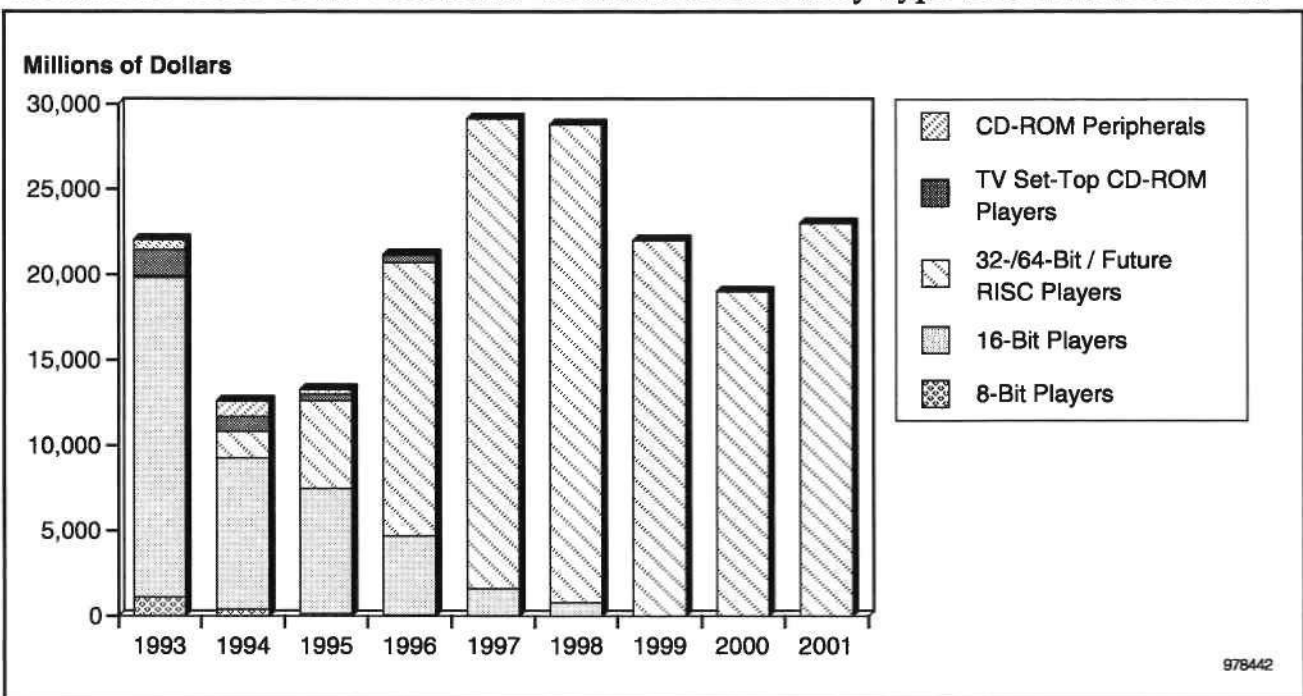
**Table 3-14**  
**Americas Video Game Controller Production Forecast**

	1993	1994	1995	1996	1997	1998	1999	2000	2001	CAGR (%) 1996-2001
Units (K)	52	53	77	0	0	0	0	0	0	-
Factory ASP (\$)	122	146	102	0	0	0	0	0	0	-
Factory Revenue (\$M)	6	8	8	0	0	0	0	0	0	-
Semiconductor Content (\$)	42	40	38	0	0	0	0	0	0	-
Semiconductor Market (\$M)	2	2	3	0	0	0	0	0	0	-

Note: Does not include handhelds

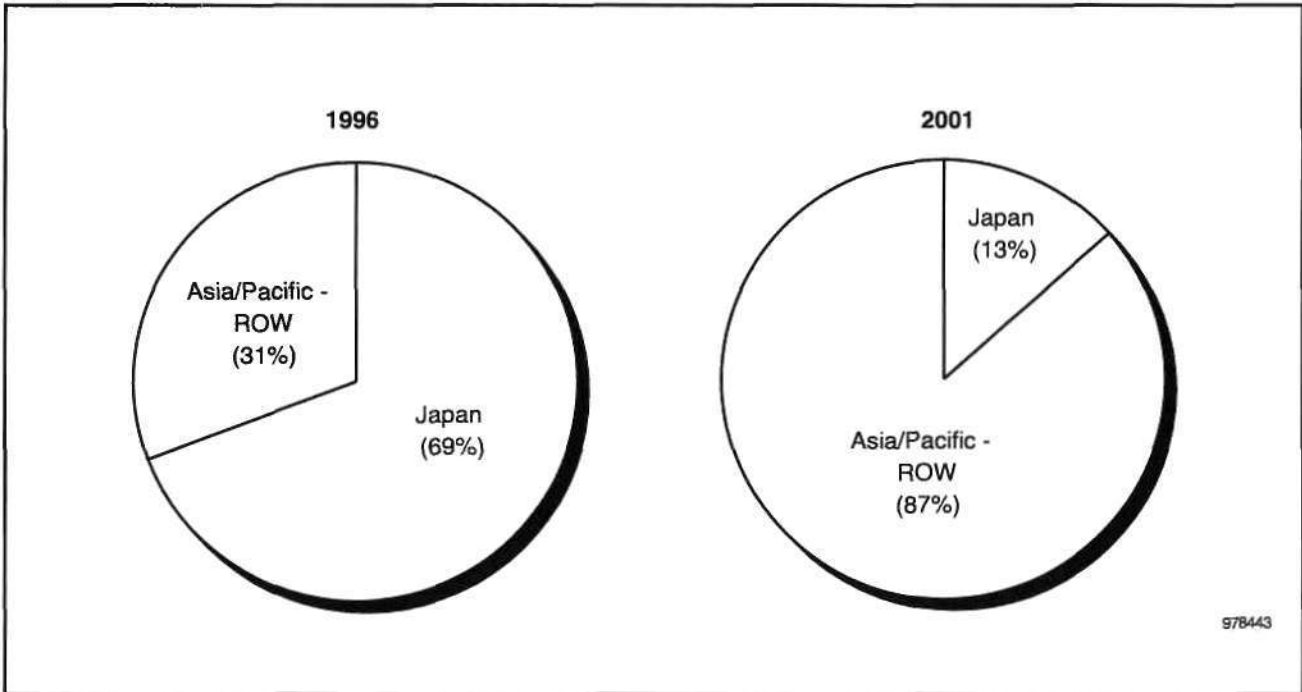
Source: Dataquest (November 1997)

**Figure 3-9**  
**Worldwide Video Game Controller Production Forecast by Type (Thousands of Units)**



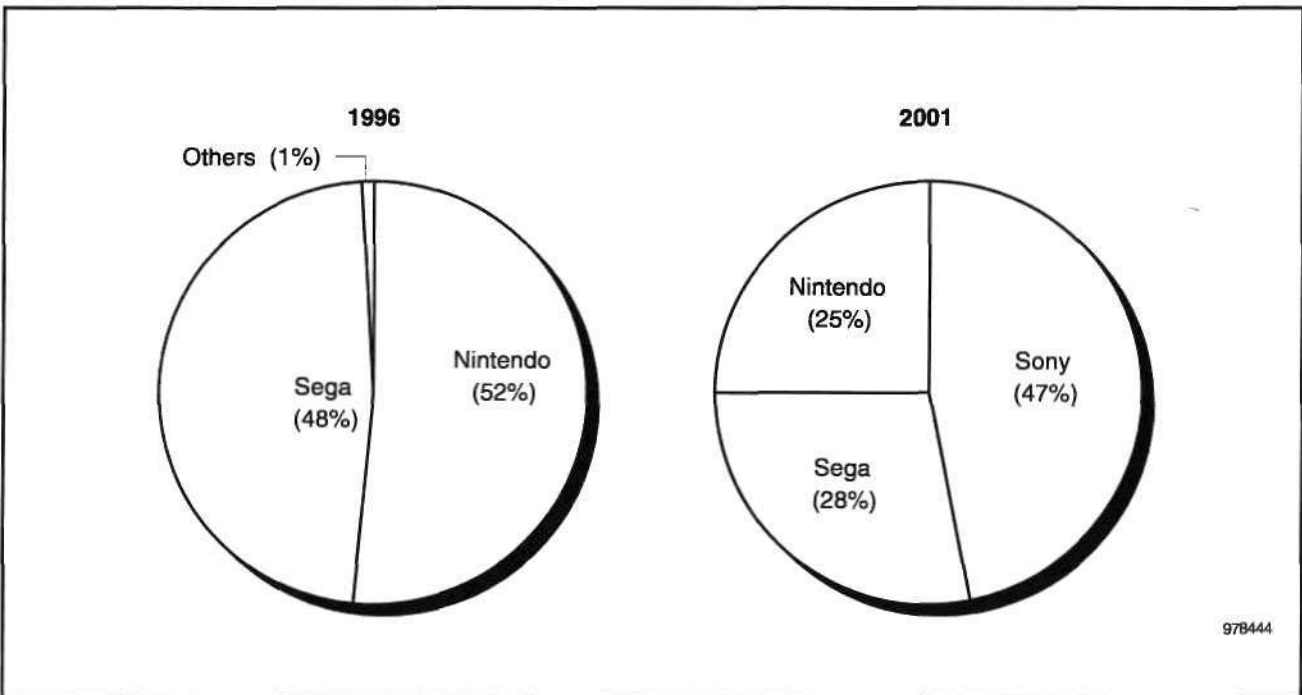
Source: Dataquest (November 1997)

**Figure 3-10**  
**Regional Share of Video Game Controller Production Revenue (Percentage)**



Source: Dataquest (November 1997)

**Figure 3-11**  
**Worldwide Video Game Controller Market Share, 1996**



Source: Dataquest (November 1997)



Meanwhile, Sega has dropped to a very distant third place in the market while it struggles with its Sega Saturn system. The production cost of the Sega Saturn is one of the significant challenges facing Sega and has limited its ability to respond to price cuts by its competitors. Although most industry observers are reluctant to count Sega out because of its strong creative talent, it is in jeopardy of becoming an insignificant player in the console segment of the market. A new hardware platform and innovative market strategy will be necessary for Sega to regain its status as a major competitor in the video game console market.

Based on announced monthly production levels by Sony and Nintendo, Dataquest predicts that worldwide shipments of 32-/64-bit video game controllers will climb to 27.5 million units in 1997, a historic high. With the semiconductor content of the next-generation game controllers leaping to over 66 percent of manufacturing cost, the semiconductor market driven by these video game controllers will reach \$4.9 billion in 1997.

Acknowledging the cyclical nature of the video game market, Dataquest predicts that unit shipments will plateau in 1998 and then decrease during 1999 and 2000 before recovering in 2001. Some of the important market, technology, and production trends are as follows:

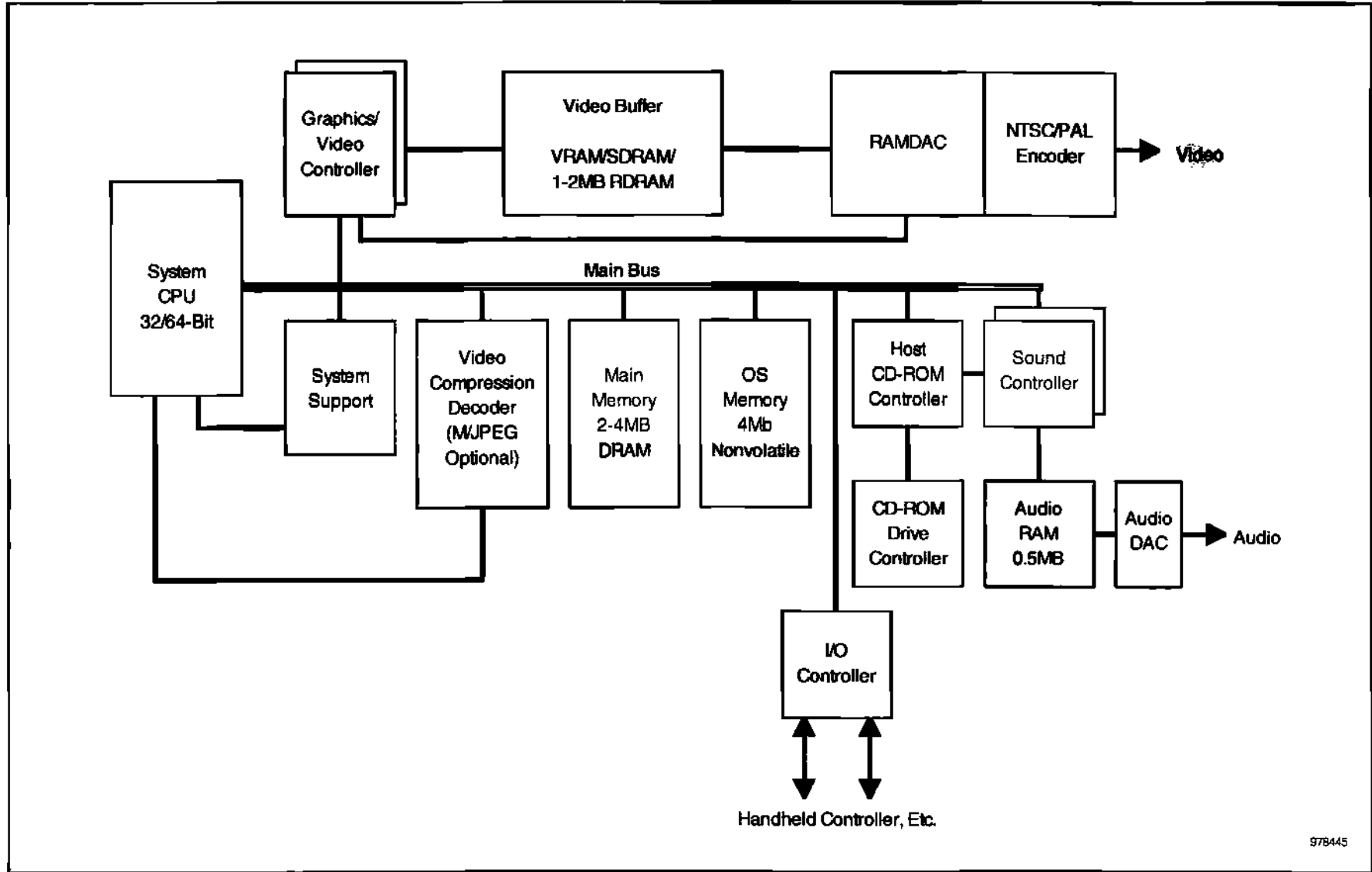
- At one point it appeared that the Internet was destined to shape future video gaming platforms. However, Sony and Nintendo have defined their video game businesses as highly focused on the gaming experienced and have signaled their intent to not modify their platforms to diversify into other markets. Most of the development of titles oriented toward the social gaming experiences will be centered around the PC. Video game console manufacturers plan to focus on delivering the best gaming experience possible for highly competitive prices.
- The introduction of a DVD drive in the video game environment will come in the PC first and will then migrate to the dedicated console as a peripheral initially. Sony and Sega have both indicated their reluctance to add the significant costs to their platforms that DVD drives would entail. It appears that late 1999 would be the earliest time that a new platform with an integrated DVD drive will be introduced to the market.
- The Nintendo 64 departs from the model followed by Sega and Sony of delivering software in a CD-ROM format opting for cartridge-based media instead. The key issues here are a trade-off of system hardware cost versus software production and distribution costs. With Nintendo the only remaining game manufacturer supplying software in cartridge format, the production of video game cartridges should drop sharply.
- Nintendo has developed its own mass storage device for the Nintendo 64 that it calls the Nintendo 64 Disk Drive (64DD). This drive will attach to the bottom of a Nintendo 64 console and provide 64MB of data storage on 3-3/4 inch magnetic disks. It is scheduled for release in Japan in March 1998 and the United States in the spring of 1998. Introduction will rely on availability of game titles currently under development that will benefit from this added feature.
- With force feedback joysticks gaining popularity in PC-based gaming, Nintendo introduced the Rumble Pak during 1997. This accessory attaches to the handheld controller and provides vibration feedback in reaction to action on the screen.

- Following the loss of support from AT&T, Toshiba, Creative Labs, and SANYO for the 3DO platform, 3DO sold exclusive rights to control the use of its M2 64-bit platform to Matsushita Electric. 3DO effectively relinquished control over the technology's application in most markets in exchange for \$100 million in licensing fees plus royalties from Matsushita. While Matsushita had shown demonstrations of a new platform based on M2 technology, it now appears that it has either postponed or canceled plans to introduce a new video game console.
- Atari, the video game pioneer, exited from the market at the end of 1995.
- The dramatic rise in the value of the yen has created a major challenge for Japanese manufacturers of video games. The strong yen has forced these companies to move production of video game players offshore to meet critical price targets for increasing consumer demand. Although most production is taking place in Asia/Pacific, during 1997 Sony began modest production of the PlayStation in its Mexico facilities.

Figure 3-12 presents a generic block diagram of a RISC video game controller. Key chip opportunities include:

- 32/64-bit RISC or CISC MPU
- 2MB to 4MB DRAM (VRAM for some designs)
- 1MB to 2MB VRAM, SDRAM, or RDRAM
- 32KB SRAM
- CMOS ASIC (100,000 to 200,000 gates) graphics/sound processing
- NTSC/PAL encode
- Sound DAC/amplification
- MPEG/JPEG decompression (optional)
- CD-ROM drive controller

Figure 3-12  
Generic Block Diagram of RISC Video Game Controller



978445

Source: Dataquest (November 1997)

## Cameras, Watches, and Clocks

Table 3-15 presents the Americas region production in these areas. Production for the most part has moved to Asia for all but the very high-end products.

**Table 3-15**

### Americas Revenue from Production of Cameras, Watches, and Clocks (Millions of Dollars)

	1993	1994	1995	1996	1997	1998	1999	2000	2001	CAGR (%) 1996-2001
Cameras	24	25	26	26	27	28	28	29	30	2.4
Watches	168	202	217	238	254	268	281	291	301	4.8
Clocks	68	71	74	76	77	79	81	83	85	2.3
<b>Total</b>	<b>261</b>	<b>298</b>	<b>317</b>	<b>340</b>	<b>358</b>	<b>375</b>	<b>390</b>	<b>403</b>	<b>415</b>	<b>4.1</b>

Source: Dataquest (November 1997)

---

**For More Information...**

Dale Ford, Principal Analyst ..... (408) 468-8311  
Internet address ..... [dale.ford@dataquest.com](mailto:dale.ford@dataquest.com)  
Via fax ..... (408) 954-1780  
Dataquest Interactive ..... <http://www.dataquest.com>

---

The content of this report represents our interpretation and analysis of information generally available to the public or released by responsible individuals in the subject companies, but is not guaranteed as to accuracy or completeness. It does not contain material provided to us in confidence by our clients. Reproduction or disclosure in whole or in part to other parties shall be made upon the written and express consent of Dataquest.  
©1997 Dataquest—Reproduction Prohibited

## DATAQUEST WORLDWIDE OFFICES

### NORTH AMERICA

**Worldwide Headquarters**  
251 River Oaks Parkway  
San Jose, California 95134-1913  
United States  
Phone: 1-408-468-8000  
Facsimile: 1-408-954-1780

### East Coast Research Center

Nine Technology Drive  
P.O. Box 5093  
Westborough, Massachusetts 01581-5093  
United States  
Phone: 1-508-871-5555  
Facsimile: 1-508-871-6262

### Dataquest Global Events

3990 Westerly Place, Suite 100  
Newport Beach, California 92660  
United States  
Phone: 1-714-476-9117  
Facsimile: 1-714-476-9969

### EUROPE

**European Headquarters**  
Tamesis, The Glanty  
Egham, Surrey TW20 9AW  
United Kingdom  
Phone: +44 1784 431 611  
Facsimile: +44 1784 488 980

### Dataquest France

Immeuble Défense Bergères  
345, avenue Georges Clémenceau  
TSA 40002  
92882 - Nanterre CTC Cedex 9  
France  
Phone: +33 1 41 35 13 00  
Facsimile: +33 1 41 35 13 13

### Dataquest Germany

Martin-Kollar-Strasse 15  
D-81829 München  
Germany  
Phone: +49 89 42 70 4-0  
Facsimile: +49 89 42 70 4-270

### JAPAN

**Japan Headquarters**  
Aobadai Hills 4-7-7  
Aobadai  
Meguro-ku, Tokyo 153  
Japan  
Phone: 81-3-3481-3670  
Facsimile: 81-3-3481-3644

### ASIA/PACIFIC

**Asia/Pacific Headquarters**  
Suite 5904-7, Central Plaza  
18 Harbour Road, Wanchai  
Hong Kong  
Phone: 852-2824-6168  
Facsimile: 852-2824-6138

### Dataquest Korea

Suite 2407, Trade Tower  
159 Samsung-dong, Kangnam-gu  
Seoul 135-729  
Korea  
Phone: 822-551-1331  
Facsimile: 822-551-1330

### Dataquest Taiwan

11F-2, No. 188, Section 5  
Nan King East Road  
Taipei  
Taiwan, R.O.C.  
Phone: 8862-756-0389  
Facsimile: 8862-756-2663

### Dataquest Singapore

6 Temasek Boulevard, #26-02/03  
Suntec City Tower 4  
Singapore 038986  
Phone: 65-333-6773  
Facsimile: 65-333-6768

### Dataquest Thailand

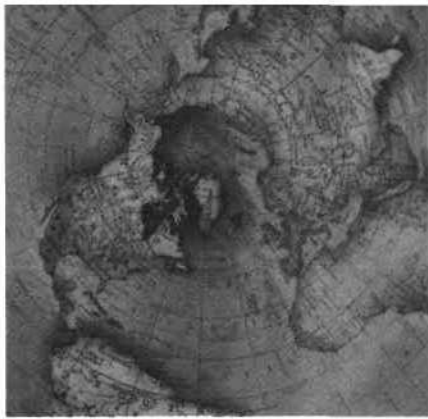
12/F, Vanissa Building  
29 Soi Chidlom  
Ploenchit Road  
Patumwan, Bangkok 10330  
Thailand  
Phone: 662-655-0577  
Facsimile: 662-655-0576

### Dataquest Australia

80 Alfred Street  
Milsons Point NSW 2061  
Australia  
Phone: 61-2-9941-4860  
Facsimile: 61-2-9941-4868

# Dataquest

A Gartner Group Company



**Dataquest**

# **Consumer Electronics Semiconductor Forecast: Next-Generation Products Carry the Market into the 21st Century**



**Market Trends**

---

**Program:** Consumer Multimedia Semiconductors and Applications Worldwide  
**Product Code:** MSAM-WW-MT-9703  
**Publication Date:** December 1, 1997  
**Filing:** Market Trends

# **Consumer Electronics Semiconductor Forecast: Next-Generation Products Carry the Market into the 21st Century**



## **Market Trends**

---

**Program:** Consumer Multimedia Semiconductors and Applications Worldwide  
**Product Code:** MSAM-WW-MT-9703  
**Publication Date:** December 1, 1997  
**Filing:** Market Trends



## Table of Contents

---

	Page
1. Executive Summary .....	1
Introduction .....	1
2. Next-Generation Consumer Chips Return for a Curtain Call .....	3
Welcome News .....	3
3. Consumer Electronics Semiconductor Market: The Next-Generation .....	11
Digital Satellite and Cable Set-Top Boxes .....	18
DVD Video Players .....	18
Video CD Players .....	20
Next-Generation Video Game Consoles .....	22
DTV .....	23
Digital Still Cameras .....	23
Digital Video Camcorders.....	25
Other Next-Generation Consumer Electronics Products .....	26
4. The Expanding Market for Compression Chips .....	29
Compression Standards .....	29
JPEG and Motion JPEG .....	29
MPEG-1 .....	29
MPEG-2 and AC-3 .....	30
H.261 .....	30
H.263 .....	30
Indeo and Proprietary Algorithms.....	30
Content Creation and Distribution Encoding Systems .....	31
Compression Technologies in PC Applications.....	31
The Compression Semiconductor Opportunity .....	32
5. DRAM Dives into Digital Consumer Electronics .....	45

## List of Figures

---

Figure	Page
2-1 Worldwide Consumer Electronics Semiconductor Market Forecast by Product Generation .....	5
2-2 Worldwide Semiconductor Market Opportunity for Next-Generation Consumer Electronics Products.....	7
2-3 Semiconductor Market for Next-Generation Consumer Electronics Products by Technology Type .....	9
2-4 Semiconductor Market for Next-Generation Consumer Electronics Products by Integration Type .....	10
3-1 Summary of Chip Market for Next-Generation Consumer Products by Chip Type .....	11
4-1 Worldwide Compression Semiconductor Market Summary by Standard .....	34
4-2 Worldwide Compression Semiconductor Market Summary by System.....	36
5-1 Worldwide DRAM Memory Market in Next-Generation Consumer Electronics .....	46

## List of Tables

Table	Page
2-1 Worldwide Consumer Electronics Semiconductor Market Forecast by Product Generation.....	6
2-2 Total Consumer Electronics Semiconductor Market Forecast by Equipment Type .....	6
2-3 Worldwide Semiconductor Market Opportunity for Next-Generation Consumer Electronics Products .....	8
2-4 Semiconductor Market for Next-Generation Consumer Electronics Products by Technology Type .....	8
2-5 Semiconductor Market for Next-Generation Consumer Electronics Products by Integration Type.....	9
2-6 Worldwide Audio/Video/Graphics Processing Chip Market for Next-Generation Consumer Products.....	10
3-1 Worldwide Chip Market for Next-Generation Consumer Products by Semiconductor Type .....	12
3-2 Worldwide Chip Market for Digital Cable Set-Top Boxes by Semiconductor Type.....	19
3-3 Worldwide Chip Market for Digital Satellite Set-Top Boxes by Semiconductor Type.....	19
3-4 Worldwide Chip Market for DVD Video Players by Semiconductor Type .....	21
3-5 Worldwide Chip Market for Video CD Players by Semiconductor Type .....	22
3-6 Worldwide Chip Market for Next-Generation Video Game Consoles by Semiconductor Type .....	24
3-7 Worldwide Chip Market for DTV Receivers by Semiconductor Type .....	24
3-8 Worldwide Chip Market for Digital Still Cameras by Semiconductor Type .....	25
3-9 Worldwide Chip Market for Digital Camcorders by Semiconductor Type .....	26
3-10 Worldwide Chip Market for Other Consumer Electronics Products by Semiconductor Type .....	27
4-1 Worldwide Compression Semiconductor Function Shipment Summary by Standard .....	33
4-2 Worldwide Compression Semiconductor Market Summary by Standard.....	33
4-3 Worldwide Compression Semiconductor Market Summary by System .....	35
4-4 Worldwide Video Compression Semiconductor Function Shipments by Standard (Units in Thousands).....	37
4-5 Worldwide Audio Compression Semiconductor Function Shipments by Standard (Units in Thousands).....	39
4-6 Worldwide Video Compression Semiconductor Market by Standard .....	41
4-7 Worldwide Audio Compression Semiconductor Market by Standard .....	43
5-1 Worldwide DRAM Memory Market in Next-Generation Consumer Electronics.....	47

# Chapter 1

## Executive Summary

---

### Introduction

The consumer electronics semiconductor market is expected to reach \$24.1 billion in 1997, up 6.6 percent from \$22.6 billion in 1996. The return to growth is welcome news for the consumer electronics semiconductor market after a decline of more than 4.2 percent in 1996. However, the sales increase in 1997 will be below the compound annual growth rate (CAGR) of 9 percent expected for the consumer electronics semiconductor market for the years 1996 to 2001. Two factors are combining to depress chip sales growth in 1997. The first factor is the continuing flatness in overall consumer electronics sales growth. The second factor is the semiconductor industrywide price erosion that has drastically reduced the cost of memories and other devices.

Flatness in consumer electronic equipment sales can be attributed to negative growth in mainstay legacy products, such as color televisions and audio equipment. With traditional products stuck in the doldrums, much of the attention in the consumer electronics semiconductor business has shifted to next-generation consumer electronics and digitally enhanced consumer electronics. Just as in 1996, the real growth opportunity in the consumer electronics market in 1997 is in these products.

This document presents Dataquest's forecast for semiconductor consumption in consumer electronics equipment, along with the market for compression semiconductors in all types of equipment. With the emergence of a new digital consumer electronics era, this document emphasizes the opportunity created by next-generation consumer electronics. These products, along with digitally enhanced consumer electronics, will drive the growth of semiconductors in this segment in the future. The forecasts in this report rely on systems forecasts established for major consumer electronics categories, along with predicted semiconductor trends and valuations in this equipment.

*Project Analysts: Dale Ford, Jonathan Cassell, Greg Sheppard, and Geoff Ballew*

## Chapter 2

# Next-Generation Consumer Chips Return for a Curtain Call

---

### Welcome News

The consumer electronics semiconductor market is expected to reach \$24.1 billion in 1997, up 6.6 percent from \$22.6 billion in 1996. The return to growth is welcome news for the consumer electronics semiconductor market after a decline of more than 4.2 percent in 1996. However, the sales increase in 1997 will be below the 9 percent CAGR expected for the consumer electronics semiconductor market for the years 1996 to 2001. Two factors are combining to depress chip sales growth in 1997. The first factor is the continuing flatness in overall consumer electronics sales growth. The second factor is the semiconductor industrywide price erosion that has drastically reduced the cost of memories and other devices.

Flatness in consumer electronic equipment sales can be attributed to negative growth in mainstay legacy products, such as color televisions and audio equipment. With traditional products stuck in the doldrums, much of the attention in the consumer electronics semiconductor business has shifted to next-generation consumer electronics and digitally enhanced consumer electronics. Just as in 1996, the real growth opportunity in the consumer electronic market in 1997 is in these products. As illustrated in Table 2-1 and Figure 2-1, it is the next-generation and digitally enhanced consumer electronics products that will drive the consumer electronics semiconductor market to \$34.9 billion by the year 2001. Meanwhile, the chip market for legacy products will remain relatively flat during the same time period. As illustrated in Table 2-2, video is the largest segment of the consumer electronics semiconductor market and will maintain its lead through the year 2001. Japan and Asia/Pacific will continue to dominate consumer electronics semiconductor consumption.

The following points present definitions for each of the next-generation product categories in these tables and figures:

- **Next-generation consumer electronics:** Products that are included in this category are digital cable set-top boxes, digital satellite set-top boxes, 32-/64-bit video game consoles, digital versatile disc (DVD) video players, DVD audio players, digital still cameras, video CD players, digital television (DTV) receivers, digital camcorders, and other products employing advanced semiconductor technologies. These products represent a new generation of consumer electronics.
- **Digitally enhanced consumer electronics:** These are consumer electronics products that have been enhanced by the addition of new digital technology. Examples include camcorders that now employ motion compensation and digital zoom, TVs with V-chips (to block violent programming) and closed captioning, VCRs with Video Guide incorporated, and CD Audio players with additional memory and circuits to provide shock protection, among others. These are all products that have been in the home for many years but now have new, enhanced features delivered by digital technology.

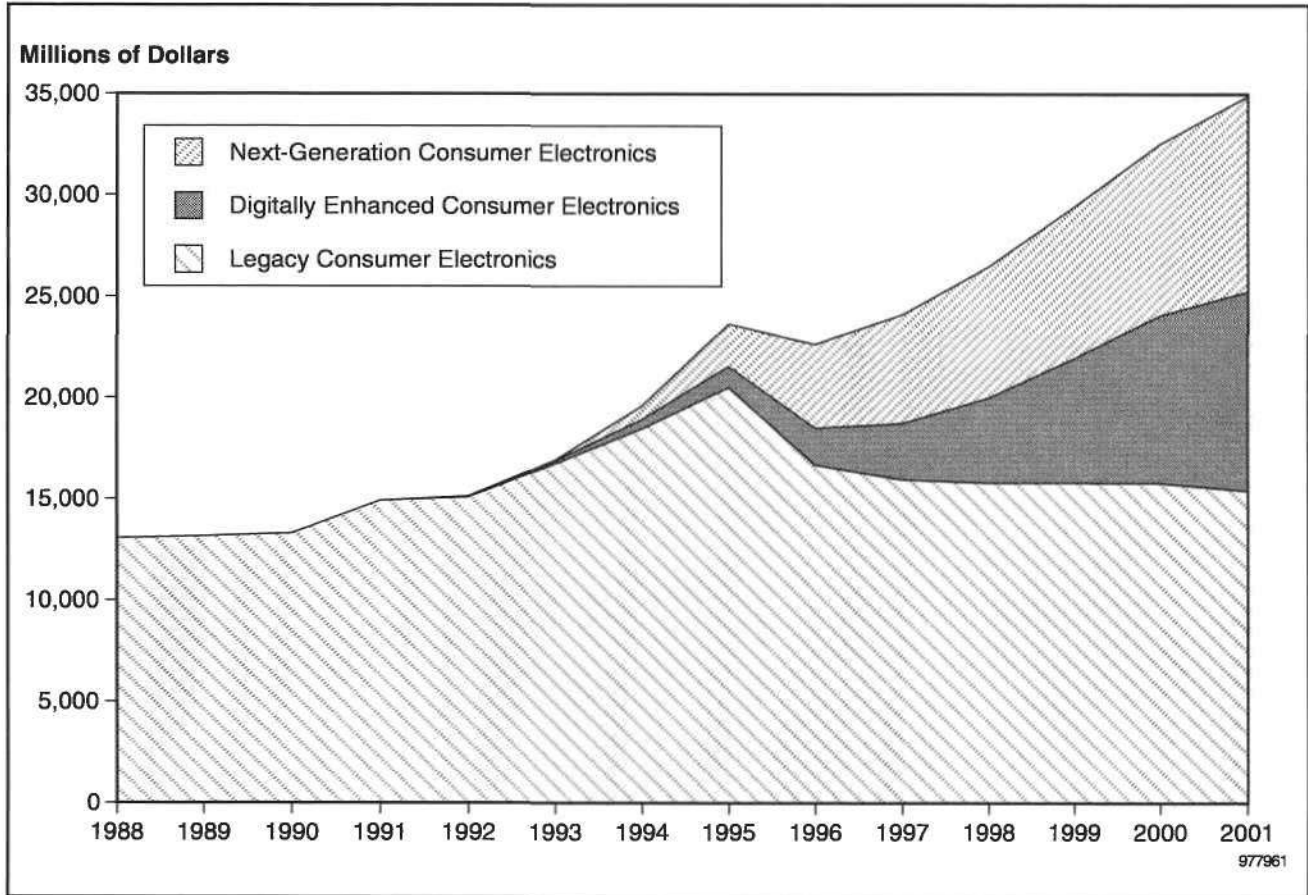
- **Legacy consumer electronics:** These are products that have been on the market for many years, such as standard color TVs, portable stereos, and VCRs, among others. They represent the current high-volume portion of the consumer electronics market and will continue to find markets at the mid-to-low-end segments. However, the chip market opportunities in these products are flat to declining.

Tables 2-3 through 2-5 and Figures 2-2 through 2-4 present summaries of the semiconductor forecasts for chips consumed in next-generation consumer electronics. More detailed forecasts for these products are presented in Chapter 3. As shown in Table 2-3 and Figure 2-2, digital satellite and digital cable set-top boxes will comprise the largest portion of next-generation consumer semiconductor sales, with the two products together accounting for more than 35 percent of the \$9.2 billion market by the year 2001. The next-largest semiconductor market will be video CD and DVD players, which will consume more than 20 percent of next-generation consumer electronics chips in 2001.

In terms of technology type, digital semiconductors will be the most used chips, accounting for greater than 44 percent of the total market, as shown in Table 2-4 and Figure 2-3. However, the fastest-growing semiconductor technology type will be mixed-signal, which will experience a 42 percent growth rate from 1996 to 2001. From an integration viewpoint, ASICs and ASSPs are the most heavily used types of chip, reflecting the increasing utilization of system-level devices in the next-generation consumer electronics market. As shown in Table 2-5, ASICs/ASSPs will encompass more than 70 percent of the total market in 2001.

Starting in 1997, more than half the value created for semiconductors in next-generation products comes from chips directly involved in processing audio, video, and graphics, as shown in Table 2-6. The chips counted in this category include products such as audio and video decoding chipsets, NTSC and PAL converters, and analog-to-digital (A/D) and digital-to-analog (D/A) converters.

**Figure 2-1**  
**Worldwide Consumer Electronics Semiconductor Market Forecast by Product Generation (Millions of Dollars)**



Source: Dataquest (September 1997)

**Table 2-1**  
**Worldwide Consumer Electronics Semiconductor Market Forecast by Product Generation (Millions of Dollars)**

	1993	1994	1995	1996	1997	1998	1999	2000	2001	CAGR (%) 1996-2001
Legacy Consumer Electronics	16,734	18,467	20,501	16,697	15,958	15,809	15,807	15,796	15,403	-1.6
Digitally Enhanced Consumer Electronics	150	450	1,054	1,807	2,799	4,196	6,136	8,282	9,846	40.4
Next-Generation Consumer Electronics	30	668	2,083	4,135	5,367	6,477	7,486	8,472	9,640	18.4
<b>Total Consumer Electronics</b>	<b>16,914</b>	<b>19,586</b>	<b>23,638</b>	<b>22,639</b>	<b>24,123</b>	<b>26,482</b>	<b>29,429</b>	<b>32,550</b>	<b>34,889</b>	<b>9.0</b>

Source: Dataquest (September 1997)

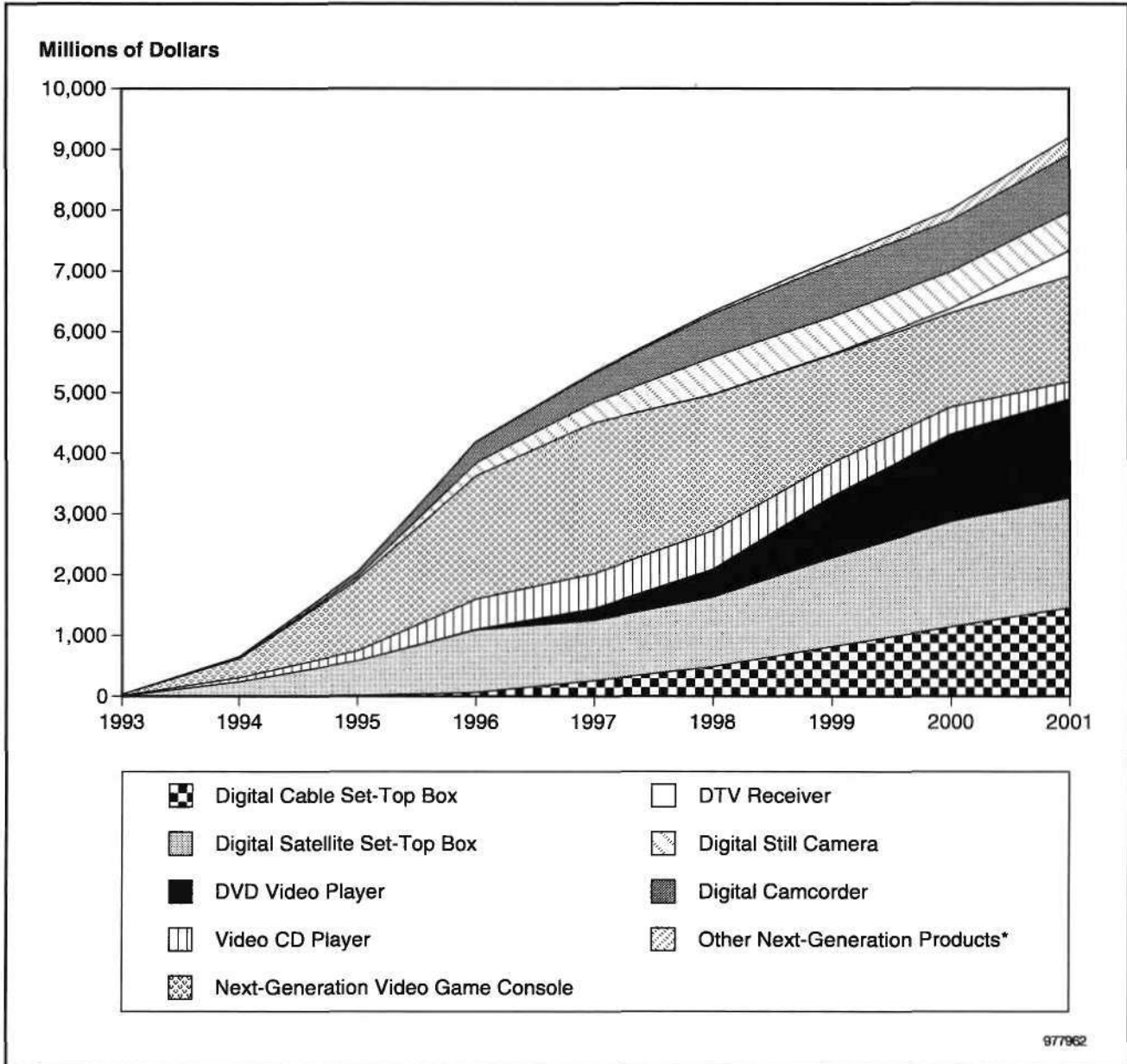
**Table 2-2**  
**Total Consumer Electronics Semiconductor Market Forecast by Equipment Type (Millions of Dollars)**

	1993	1994	1995	1996	1997	1998	1999	2000	2001	CAGR (%) 1996-2001
Audio	3,026	3,594	4,529	3,545	3,685	4,101	4,726	5,279	5,609	9.6
Video	7,557	8,287	8,949	10,185	10,749	11,719	12,938	13,839	14,590	7.5
Personal Electronics	2,924	3,846	5,640	5,127	5,673	6,296	6,888	7,736	8,303	10.1
Appliances	2,338	2,573	2,845	2,548	2,705	2,870	3,105	3,423	3,725	7.9
Other Consumer	1,069	1,286	1,675	1,235	1,310	1,496	1,772	2,274	2,662	16.6
<b>Total</b>	<b>16,914</b>	<b>19,586</b>	<b>23,638</b>	<b>22,639</b>	<b>24,123</b>	<b>26,482</b>	<b>29,429</b>	<b>32,550</b>	<b>34,889</b>	<b>9.0</b>
<b>Regional Consumption Trends (Percentage of World by Total Revenue)</b>										
Americas	10.1	11.2	11.2	12.1	11.2	10.9	11.0	10.8	10.3	-3.1
Europe	9.6	9.9	9.2	11.9	11.7	11.6	11.4	11.2	12.0	0.3
Japan	51.7	47.4	43.7	40.9	43.3	43.0	42.3	42.0	43.2	1.1
Asia/Pacific	28.5	31.5	35.9	35.1	33.8	34.5	35.3	36.0	34.4	-0.4

Source: Dataquest (September 1997)



**Figure 2-2**  
**Worldwide Semiconductor Market Opportunity for Next-Generation Consumer Electronics Products (Millions of Dollars)**



NA = Not applicable

\*Other next-generation products includes digital VCRs, DVD audio, and others.

Source: Dataquest (September 1997)

**Table 2-3**  
**Worldwide Semiconductor Market Opportunity for Next-Generation Consumer Electronics Products (Millions of Dollars)**

	1993	1994	1995	1996	1997	1998	1999	2000	2001	CAGR (%) 1996-2001
Digital Cable Set-Top Box	4	6	13	61	259	488	819	1,144	1,459	88.7
Digital Satellite Set-Top Box	0	230	568	1,032	988	1,144	1,460	1,737	1,807	11.9
DVD Video Player	0	0	0	9	197	458	1,010	1,429	1,628	179.9
Video CD Player	5	69	166	496	574	636	551	445	285	-10.5
Next-Generation Video Game Console	21	314	1,166	2,027	2,478	2,237	1,772	1,551	1,736	-3.0
DTV Receiver	0	0	0	0	0	1	13	74	419	NA
Digital Still Camera	0	7	50	214	336	611	618	609	646	24.8
Digital Camcorder	0	25	79	338	481	709	854	845	926	22.3
Other Next-Generation Products*	0	0	0	6	20	45	90	176	287	114.6
<b>Total</b>	<b>29</b>	<b>650</b>	<b>2,042</b>	<b>4,183</b>	<b>5,333</b>	<b>6,331</b>	<b>7,187</b>	<b>8,008</b>	<b>9,194</b>	<b>17.1</b>

NA = Not applicable

\*Other next-generation products includes digital VCRs, DVD audio, and others.

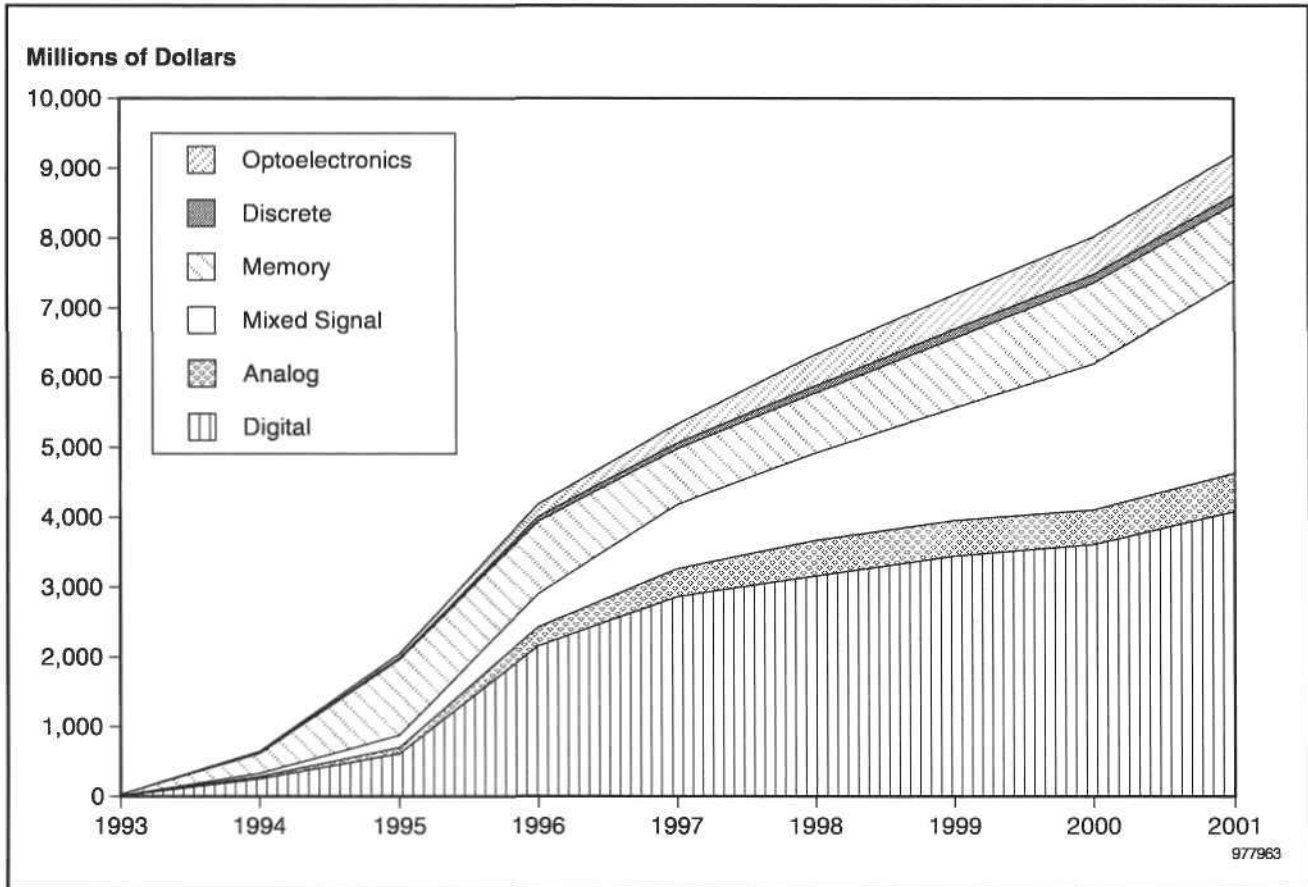
Source: Dataquest (September 1997)

**Table 2-4**  
**Semiconductor Market for Next-Generation Consumer Electronics Products by Technology Type (Millions of Dollars)**

	1993	1994	1995	1996	1997	1998	1999	2000	2001	CAGR (%) 1996-2001
Digital	10	252	617	2,157	2,860	3,159	3,446	3,609	4,083	13.6
Analog	1	36	86	267	400	511	508	495	548	15.4
Mixed-Signal	2	43	173	478	920	1,251	1,610	2,088	2,759	42.0
Memory	15	289	1,085	1,037	799	861	996	1,160	1,088	1.0
Discrete	0	10	23	67	81	101	128	118	132	14.5
Optoelectronics	2	20	57	177	273	447	499	537	584	26.9
<b>Total</b>	<b>29</b>	<b>650</b>	<b>2,042</b>	<b>4,183</b>	<b>5,333</b>	<b>6,331</b>	<b>7,187</b>	<b>8,008</b>	<b>9,194</b>	<b>17.1</b>

Source: Dataquest (September 1997)

**Figure 2-3**  
**Semiconductor Market for Next-Generation Consumer Electronics Products by Technology Type (Millions of Dollars)**



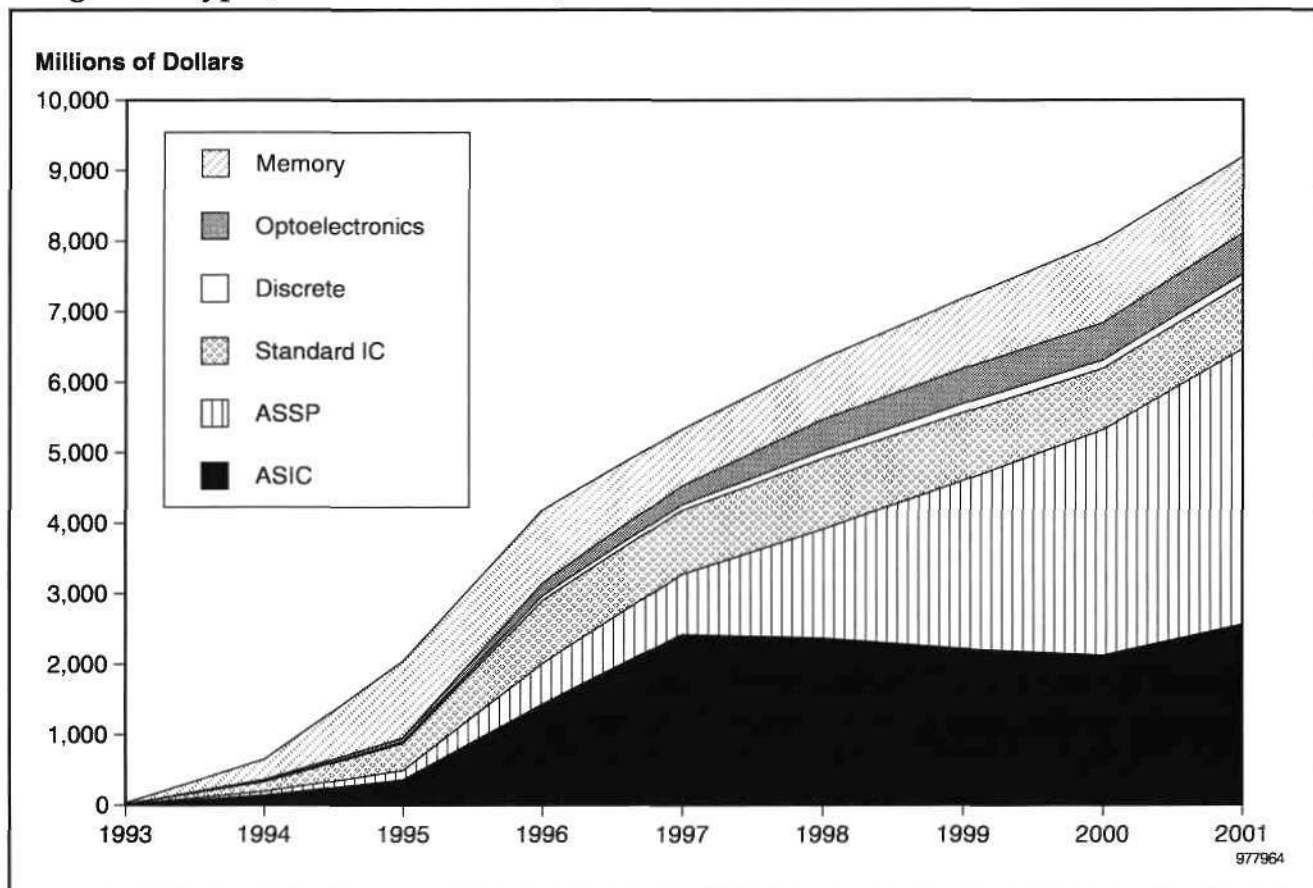
Source: Dataquest (September 1997)

**Table 2-5**  
**Semiconductor Market for Next-Generation Consumer Electronics Products by Integration Type (Millions of Dollars)**

	1993	1994	1995	1996	1997	1998	1999	2000	2001	CAGR (%) 1996-2001
ASIC / ASSP	7	196	495	2,008	3,273	3,911	4,606	5,323	6,462	26.3
ASIC	7	139	364	1,428	2,420	2,367	2,215	2,121	2,560	12.4
ASSP	1	58	131	580	853	1,545	2,391	3,202	3,903	46.4
Standard IC	5	135	381	894	907	1,010	958	870	928	0.7
Discrete	0	10	23	67	81	101	128	118	132	14.5
Optoelectronics	2	20	57	177	273	447	499	537	584	26.9
Memory	15	289	1,085	1,037	799	861	996	1,160	1,088	1.0
<b>Total</b>	<b>29</b>	<b>650</b>	<b>2,042</b>	<b>4,183</b>	<b>5,333</b>	<b>6,331</b>	<b>7,187</b>	<b>8,008</b>	<b>9,194</b>	<b>17.1</b>

Source: Dataquest (September 1997)

**Figure 2-4**  
**Semiconductor Market for Next-Generation Consumer Electronics Products by Integration Type (Millions of Dollars)**



Source: Dataquest (September 1997)

**Table 2-6**  
**Worldwide Audio/Video/Graphics Processing Chip Market for Next-Generation Consumer Products (Millions of Dollars)**

	1993	1994	1995	1996	1997	1998	1999	2000	2001	CAGR (%) 1996-2001
Digital Cable Set-Top Box	2	3	8	30	124	234	393	548	699	87.4
Digital Satellite Set-Top Box	0	114	332	546	540	593	722	845	934	11.3
DVD Video Player	0	0	0	3	78	183	415	582	653	187.8
Video CD Players	3	41	93	329	312	326	270	210	130	-17.0
Next-Generation Video Game Console	6	90	302	923	1,478	1,428	1,153	1,011	1,203	5.4
DTV Receiver	0	0	0	0	0	1	10	56	314	NA
Digital Still Camera	0	5	42	161	201	308	310	230	242	8.4
Digital Camcorder	0	0	12	54	89	156	230	280	336	44.0
Other Next-Generation Products*	0	0	0	2	6	15	32	64	93	114.0
<b>Total</b>	<b>10</b>	<b>253</b>	<b>789</b>	<b>2,049</b>	<b>2,827</b>	<b>3,244</b>	<b>3,534</b>	<b>3,824</b>	<b>4,603</b>	<b>17.6</b>

NA = Not applicable

\*Other next-generation products includes digital VCRs, DVD audio, and others.

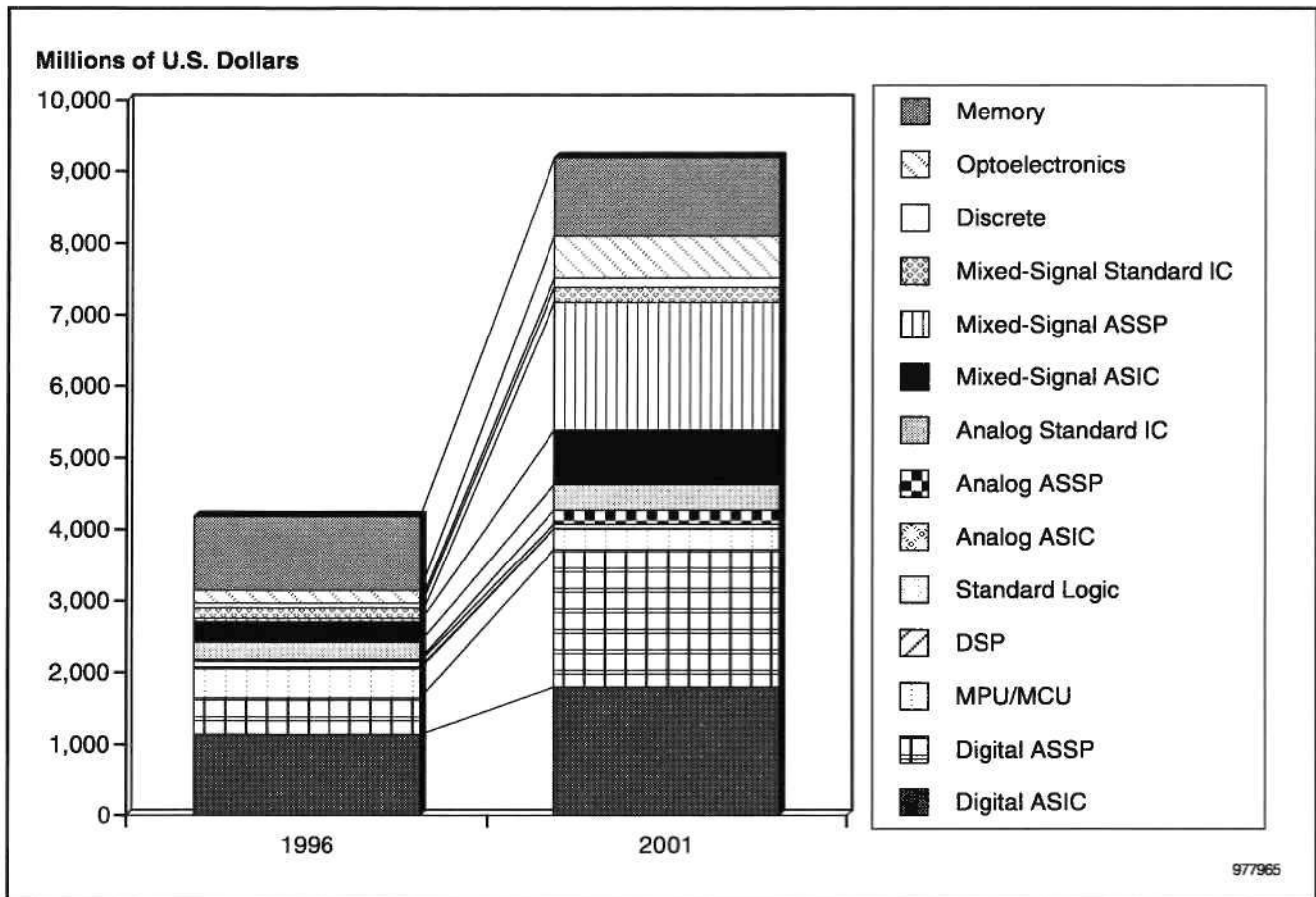
Source: Dataquest (September 1997)

## Chapter 3

# Consumer Electronics Semiconductor Market: The Next-Generation

This chapter explores the tremendous opportunities for growth in the market for next-generation consumer electronics equipment. The establishment of industry standards for most of these products will help to create extremely high growth rates for analog, digital, and mixed-signal ASSP products. On the other hand, the continued price erosion in memory chips and lack of elasticity for memory demand in these systems will combine to cause minimal growth in the memory market from 1996 to 2001. Table 3-1 and Figure 3-1 present a summary of the detailed semiconductor forecast for each of the defined next-generation products in the following tables. It is important to note that these tables present the combined value of semiconductors on end-equipment shipping from the factory. In a high-growth market such as this, the actual units and value of chip shipments from semiconductor manufacturers to equipment manufacturers in a given year will typically be higher than the forecasts in these tables because of inventory and work-in-process.

**Figure 3-1**  
**Summary of Chip Market for Next-Generation Consumer Products by Chip Type**  
(Millions of Dollars)



Source: Dataquest (September 1997)

**Table 3-1**  
**Worldwide Chip Market for Next-Generation Consumer Products by Semiconductor Type (Millions of Dollars)**

	1993	1994	1995	1996	1997	1998	1999	2000	2001	CAGR (%) 1996-2001
<b>Digital ASIC</b>	<b>7</b>	<b>135</b>	<b>273</b>	<b>1,140</b>	<b>1,897</b>	<b>1,834</b>	<b>1,652</b>	<b>1,547</b>	<b>1,801</b>	<b>9.6</b>
Digital Cable Set-Top Box	1	1	3	27	128	242	309	353	351	66.9
Digital Satellite Set-Top Box	0	45	57	316	314	228	139	88	82	-23.6
DVD Video Player	0	0	0	1	15	38	83	83	81	153.6
Video CD Players	2	15	0	0	0	0	0	0	0	NA
Next-Generation Video Game Console	4	67	188	658	1,211	1,120	924	836	1,012	9.0
DTV Receiver	0	0	0	0	0	1	5	20	102	NA
Digital Still Camera	0	3	16	86	154	108	81	57	52	-9.4
Digital Camcorder	0	3	10	51	72	92	102	93	93	12.8
Other Next-Generation	0	0	0	1	3	6	8	18	28	82.7
<b>Digital ASSP</b>	<b>0</b>	<b>49</b>	<b>109</b>	<b>503</b>	<b>620</b>	<b>983</b>	<b>1,454</b>	<b>1,737</b>	<b>1,919</b>	<b>30.7</b>
Digital Cable Set-Top Box	0	0	0	3	26	66	131	277	441	163.4
Digital Satellite Set-Top Box	0	40	45	264	316	468	724	726	576	16.9
DVD Video Player	0	0	0	2	55	135	305	460	542	201.4
Video CD Players	0	10	64	234	207	200	160	123	72	-21.1
Next-Generation Video Game Console	0	0	0	0	0	0	0	0	0	NA
DTV Receiver	0	0	0	0	0	0	2	18	127	NA
Digital Still Camera	0	0	0	0	0	74	73	66	71	NA
Digital Camcorder	0	0	0	0	14	35	51	51	65	NA
Other Next-Generation	0	0	0	0	1	4	8	17	26	NA
<b>Digital Standard IC</b>	<b>3</b>	<b>68</b>	<b>235</b>	<b>513</b>	<b>344</b>	<b>343</b>	<b>340</b>	<b>325</b>	<b>362</b>	<b>-6.7</b>
Digital Cable Set-Top Box	0	0	1	3	13	23	38	51	67	88.6
Digital Satellite Set-Top Box	0	15	31	51	56	51	60	67	67	5.8
DVD Video Player	0	0	0	0	9	17	35	41	41	154.8
Video CD Players	0	8	20	69	38	21	16	11	7	-37.7
Next-Generation Video Game Console	3	42	170	333	138	130	88	72	83	-24.3
DTV Receiver	0	0	0	0	0	0	1	3	19	NA
Digital Still Camera	0	1	7	29	50	49	49	33	31	1.3
Digital Camcorder	0	2	6	27	38	50	51	42	42	9.0
Other Next-Generation	0	0	0	0	1	2	2	5	6	67.1

**Table 3-1 (Continued)**  
**Worldwide Chip Market for Next-Generation Consumer Products by Semiconductor Type (Millions of Dollars)**

	1993	1994	1995	1996	1997	1998	1999	2000	2001	CAGR (%) 1996-2001
<b>Digital Standard IC— Standard Logic</b>	<b>0</b>	<b>9</b>	<b>26</b>	<b>79</b>	<b>67</b>	<b>71</b>	<b>72</b>	<b>64</b>	<b>66</b>	<b>-3.5</b>
Digital Cable Set-Top Box	0	0	0	0	0	1	1	2	2	110.0
Digital Satellite Set-Top Box	0	2	0	0	0	0	0	0	0	23.4
DVD Video Player	0	0	0	0	3	3	5	4	4	104.5
Video CD	0	4	11	38	11	2	0	0	0	-100.0
Next-Generation Video Game	0	2	8	10	4	4	1	1	1	-39.2
DTV Receiver	0	0	0	0	0	0	0	0	1	NA
Digital Camera	0	0	3	13	22	23	23	16	15	3.6
Digital Camcorder	0	1	4	18	27	37	41	40	42	18.5
Other	0	0	0	0	0	0	0	1	1	67.1
<b>Digital Standard IC—MPU/MCU</b>	<b>2</b>	<b>52</b>	<b>190</b>	<b>410</b>	<b>265</b>	<b>261</b>	<b>262</b>	<b>256</b>	<b>291</b>	<b>-6.6</b>
Digital Cable Set-Top Box	0	0	0	3	13	23	37	49	64	88.0
Digital Satellite Set-Top Box	0	14	30	50	55	49	57	65	64	5.3
DVD Video Player	0	0	0	0	6	14	30	37	37	167.9
Video CD	0	4	9	31	26	19	16	11	7	-26.9
Next-Generation Video Game	2	34	144	300	124	117	84	71	82	-22.9
DTV Receiver	0	0	0	0	0	0	1	3	18	NA
Digital Camera	0	1	4	17	29	26	26	17	16	-0.7
Digital Camcorder	0	1	2	9	12	12	10	2	0	-100.0
Other	0	0	0	0	1	1	1	2	3	67.1
<b>Digital Standard IC—DSP</b>	<b>1</b>	<b>6</b>	<b>17</b>	<b>24</b>	<b>10</b>	<b>10</b>	<b>4</b>	<b>3</b>	<b>3</b>	<b>-36.1</b>
Digital Cable Set-Top Box	0	0	0	0	0	0	0	0	0	NA
Digital Satellite Set-Top Box	0	0	0	0	0	0	0	0	0	NA
DVD Video Player	0	0	0	0	0	0	0	0	0	NA
Video CD	0	0	0	0	0	0	0	0	0	NA
Next-Generation Video Game	1	6	17	23	10	9	3	1	0	-100.0
DTV Receiver	0	0	0	0	0	0	0	0	0	NA
Digital Camera	0	0	0	0	0	0	0	0	0	NA
Digital Camcorder	0	0	0	0	0	0	0	0	0	NA
Other	0	0	0	0	1	1	1	2	3	67.1

**Table 3-1 (Continued)**  
**Worldwide Chip Market for Next-Generation Consumer Products by Semiconductor Type (Millions of Dollars)**

	1993	1994	1995	1996	1997	1998	1999	2000	2001	CAGR (%) 1996-2001
<b>Analog ASIC</b>	0	0	0	0	0	0	0	0	0	NA
Digital Cable Set-Top Box	0	0	0	0	0	0	0	0	0	NA
Digital Satellite Set-Top Box	0	0	0	0	0	0	0	0	0	NA
DVD Video Player	0	0	0	0	0	0	0	0	0	NA
Video CD Players	0	0	0	0	0	0	0	0	0	NA
Next-Generation Video Game Console	0	0	0	0	0	0	0	0	0	NA
DTV Receiver	0	0	0	0	0	0	0	0	0	NA
Digital Still Camera	0	0	0	0	0	0	0	0	0	NA
Digital Camcorder	0	0	0	0	0	0	0	0	0	NA
Other Next-Generation	0	0	0	0	0	0	0	0	0	NA
<b>Analog ASSP</b>	0	3	8	28	66	109	136	170	193	47.6
Digital Cable Set-Top Box	0	0	0	0	0	0	0	0	0	NA
Digital Satellite Set-Top Box	0	0	0	0	0	0	0	0	0	NA
DVD Video Player	0	0	0	0	4	10	22	31	36	185.3
Video CD Players	0	2	4	15	29	40	36	30	20	6.1
Next-Generation Video Game Console	0	0	1	2	1	0	0	0	0	-100.0
DTV Receiver	0	0	0	0	0	0	0	0	0	NA
Digital Still Camera	0	0	0	0	0	0	0	0	0	NA
Digital Camcorder	0	1	2	10	29	53	68	81	105	59.5
Other Next-Generation	0	0	0	1	3	6	10	27	33	104.0
<b>Analog Standard IC</b>	1	33	79	240	334	401	372	326	356	8.2
Digital Cable Set-Top Box	0	0	1	8	38	66	70	66	79	59.3
Digital Satellite Set-Top Box	0	23	51	130	145	154	124	95	94	-6.3
DVD Video Player	0	0	0	0	3	5	12	17	20	158.1
Video CD Players	0	4	7	19	35	40	34	26	17	-2.2
Next-Generation Video Game Console	0	2	8	30	59	56	42	34	39	5.5
DTV Receiver	0	0	0	0	0	0	1	4	23	NA
Digital Still Camera	0	0	0	2	3	8	9	10	11	42.5
Digital Camcorder	0	3	11	51	51	71	77	68	65	5.0
Other Next-Generation	0	0	0	0	1	1	4	5	9	83.1



**Table 3-1 (Continued)**  
**Worldwide Chip Market for Next-Generation Consumer Products by Semiconductor Type (Millions of Dollars)**

	1993	1994	1995	1996	1997	1998	1999	2000	2001	CAGR (%) 1996-2001
<b>Mixed-Signal ASIC</b>	0	4	91	288	523	533	564	574	759	21.4
Digital Cable Set-Top Box	0	0	0	0	0	0	69	121	201	NA
Digital Satellite Set-Top Box	0	0	0	0	0	0	0	0	0	NA
DVD Video Player	0	0	0	1	8	17	30	36	33	99.4
Video CD Players	0	0	0	0	0	0	0	0	0	NA
Next-Generation Video Game Console	0	0	76	218	420	386	310	258	302	6.7
DTV Receiver	0	0	0	0	0	0	1	8	58	NA
Digital Still Camera	0	0	0	0	0	0	0	0	0	NA
Digital Camcorder	0	4	14	68	91	124	145	139	148	17.0
Other Next-Generation	0	0	0	1	3	6	8	12	18	65.5
<b>Mixed-Signal ASSP</b>	0	6	14	49	168	452	800	1,296	1,791	105.5
Digital Cable Set-Top Box	0	0	0	0	0	0	52	86	138	NA
Digital Satellite Set-Top Box	0	0	0	0	0	66	204	551	827	NA
DVD Video Player	0	0	0	1	47	116	247	354	455	222.7
Video CD Players	0	6	14	48	96	127	118	102	73	8.9
Next-Generation Video Game Console	0	0	0	0	0	0	0	0	0	NA
DTV Receiver	0	0	0	0	0	0	1	6	40	NA
Digital Still Camera	0	0	0	0	0	81	80	73	82	NA
Digital Camcorder	0	0	0	0	24	57	85	101	130	NA
Other Next-Generation	0	0	0	0	1	5	13	23	46	NA
<b>Mixed-Signal Standard IC</b>	1	34	68	141	229	266	246	219	210	8.3
Digital Cable Set-Top Box	0	0	0	0	1	1	2	3	4	108.7
Digital Satellite Set-Top Box	0	14	20	2	2	3	4	5	6	22.7
DVD Video Player	0	0	0	0	0	0	0	0	0	NA
Video CD Players	0	8	14	38	72	87	76	61	40	1.3
Next-Generation Video Game Console	1	9	26	61	98	87	64	51	55	-2.1
DTV Receiver	0	0	0	0	0	0	0	0	1	NA
Digital Still Camera	0	0	1	5	6	15	17	19	21	34.4
Digital Camcorder	0	2	7	34	48	70	81	76	79	18.3
Other Next-Generation	0	0	0	1	2	2	2	3	3	41.1

**Table 3-1 (Continued)**  
**Worldwide Chip Market for Next-Generation Consumer Products by Semiconductor Type (Millions of Dollars)**

	1993	1994	1995	1996	1997	1998	1999	2000	2001	CAGR (%) 1996-2001
<b>Discrete</b>	<b>0</b>	<b>10</b>	<b>23</b>	<b>67</b>	<b>81</b>	<b>101</b>	<b>128</b>	<b>118</b>	<b>132</b>	<b>14.5</b>
Digital Cable Set-Top Box	0	0	0	2	8	14	22	17	23	64.9
Digital Satellite Set-Top Box	0	8	15	42	41	47	54	34	36	-3.1
DVD Video Player	0	0	0	0	4	5	15	29	24	164.3
Video CD	0	0	0	1	3	4	3	3	2	10.5
Next-Generation Video Game	0	2	6	12	15	11	9	8	9	-6.5
DTV	0	0	0	0	0	0	0	1	7	NA
Digital Camera	0	0	1	7	8	17	17	17	17	18.9
Digital Camcorder	0	0	0	2	2	4	4	4	5	22.3
Other Next-Generation	0	0	0	0	0	0	3	5	9	120.4
<b>Optoelectronics</b>	<b>2</b>	<b>20</b>	<b>57</b>	<b>177</b>	<b>273</b>	<b>447</b>	<b>499</b>	<b>537</b>	<b>584</b>	<b>26.9</b>
Digital Cable Set-Top Box	0	0	0	0	0	0	0	0	0	NA
Digital Satellite Set-Top Box	0	0	0	0	0	0	0	0	0	NA
DVD Video Player	0	0	0	1	18	43	90	129	160	190.1
Video CD Players	0	5	10	31	55	76	71	61	44	7.2
Next-Generation Video Game Console	1	11	27	57	72	101	78	66	78	6.7
DTV Receiver	0	0	0	0	0	0	0	0	0	NA
Digital Still Camera	0	1	10	48	66	135	142	158	158	27.0
Digital Camcorder	0	3	9	41	60	92	115	118	134	27.1
Other Next-Generation	0	0	0	0	1	0	3	5	9	106.6
<b>Memory</b>	<b>15</b>	<b>289</b>	<b>1,085</b>	<b>1,037</b>	<b>799</b>	<b>861</b>	<b>996</b>	<b>1,160</b>	<b>1,088</b>	<b>1.0</b>
Digital Cable Set-Top Box	2	3	9	18	46	76	126	170	155	54.1
Digital Satellite Set-Top Box	0	85	348	227	115	127	151	170	118	-12.2
DVD Video Player	0	0	0	2	34	73	171	248	236	148.8
Video CD Players	1	12	31	41	39	42	37	30	11	-22.7
Next-Generation Video Game Console	12	181	664	656	464	345	257	225	159	-24.7
DTV Receiver	0	0	0	0	0	0	2	13	44	NA
Digital Still Camera	0	1	13	36	49	125	149	176	202	40.9
Digital Camcorder	0	7	20	56	50	61	73	71	62	2.2
Other Next-Generation	0	0	0	1	2	12	30	56	101	170.5

**Table 3-1 (Continued)**  
**Worldwide Chip Market for Next-Generation Consumer Products by Semiconductor Type (Millions of Dollars)**

	1993	1994	1995	1996	1997	1998	1999	2000	2001	CAGR (%) 1996-2001
<b>Total Market</b>	<b>29</b>	<b>650</b>	<b>2,042</b>	<b>4,183</b>	<b>5,333</b>	<b>6,331</b>	<b>7,187</b>	<b>8,008</b>	<b>9,194</b>	<b>17.1</b>
Digital ASIC	7	135	273	1,140	1,897	1,834	1,652	1,547	1,801	9.6
Digital ASSP	0	49	109	503	620	983	1,454	1,737	1,919	30.7
Digital Standard IC	3	68	235	513	344	343	340	325	362	-6.7
MPU/MCU	2	52	190	410	265	261	262	256	291	-6.6
DSP	1	6	17	24	10	10	4	3	3	-34.0
Standard Logic	0	9	26	79	67	71	72	64	66	-3.5
Analog ASIC	0	0	0	0	0	0	0	0	0	NA
Analog ASSP	0	3	8	28	66	109	136	170	193	47.6
Analog Standard IC	1	33	79	240	334	401	372	326	356	8.2
Mixed-Signal ASIC	0	4	91	288	523	533	564	574	759	21.4
Mixed-Signal ASSP	0	6	14	49	168	452	800	1,296	1,791	105.5
Mixed-Signal Standard IC	1	34	68	141	229	266	246	219	210	8.3
Discrete	0	10	23	67	81	101	128	118	132	14.5
Optoelectronics	2	20	57	177	273	447	499	537	584	26.9
Memory	15	289	1,085	1,037	799	861	996	1,160	1,088	1.0

NA = Not applicable

Source: Dataquest (September 1997)

## Digital Satellite and Cable Set-Top Boxes

Digital set-top boxes represent a fast-growing market for video and audio compression and processing devices. They also are significant consumers of memory, mainly DRAM, although SRAM and flash also are used in such systems. The primary type of video compression used in both cable and satellite systems is MPEG-2. For audio, both the MPEG-1 and MPEG-2 standards are used. In addition to decompression, digital set-top boxes perform a variety of different types of video and audio processing, including transport demultiplexing, graphics control and acceleration, and NTSC/PAL encoding.

In a quest for cost reduction, the market as a whole is migrating away from a mix of ASICs and standard parts and toward highly integrated ASSPs. Analog, digital, and mixed-signal ASSPs all are playing an increasingly important role in new and future set-top boxes and will account for an ever-larger percentage of value in those systems. The cost of memory used in digital set-top boxes significantly decreased in 1996 and 1997 as DRAM prices continued to plunge.

Because of intense competition among service providers, digital satellite set-top boxes have been sold to consumers at prices well below manufacturing cost for more than a year now. This has spurred makers of digital satellite set-top boxes to make increasing use of highly integrated chips to cut costs. Still in its early stages, the digital cable box market is lagging the digital satellite box market in terms of integration, causing the products to have a higher semiconductor content. Digital cable boxes also tend to possess a larger amount of differentiation, more microprocessor horsepower, and a higher level of audio/visual processing than satellite systems, further contributing to higher semiconductor content. Near the end of the century, some new cable boxes will include audio and video compression capabilities to support two-way communication and data storage applications. Tables 3-2 and 3-3 present detailed semiconductor market forecasts for digital cable and digital satellite set-top boxes, respectively.

## DVD Video Players

DVD video players experienced a disappointing market launch when they were introduced in Japan on November 1, 1996. The first shipments in the United States started in the first quarter of 1997 with modest shipments into selected markets. The plan by most manufacturers was to work during 1997 to develop channels and educate consumers and salespeople in preparation for a major sales effort during the holiday season of 1997. This market preparation period would also allow movie studios to introduce a solid lineup of DVD movies during this period. Typical expectations were for U.S. DVD sales in excess of 400,000 during 1997. By October 1, 1997, about 180,000 units had been shipped into the retail channel. Sales patterns indicate that the early purchasers of DVD players were people who had driven the laser disc player market in the past.

**Table 3-2**  
**Worldwide Chip Market for Digital Cable Set-Top Boxes by Semiconductor Type**  
 (Millions of Dollars)

	1993	1994	1995	1996	1997	1998	1999	2000	2001	CAGR (%) 1996-2001
Digital ASIC	1	1	3	27	128	242	309	353	351	66.9
Digital ASSP	0	0	0	3	26	66	131	277	441	163.4
Digital Standard IC	0	0	1	3	13	23	38	51	67	88.6
MPU/MCU	0	0	0	3	13	23	37	49	64	84.4
DSP	0	0	0	0	0	0	0	0	0	NA
Standard Logic	0	0	0	0	0	1	1	2	2	NA
Analog ASIC	0	0	0	0	0	0	0	0	0	NA
Analog ASSP	0	0	0	0	0	0	0	0	0	NA
Analog Standard IC or discrete	0	0	1	8	38	66	70	66	79	59.3
Mixed-Signal ASIC	0	0	0	0	0	0	69	121	201	NA
Mixed-Signal ASSP	0	0	0	0	0	0	52	86	138	NA
Mixed-Signal Standard IC	0	0	0	0	1	1	2	3	4	108.7
Discrete	0	0	0	2	8	14	22	17	23	63.0
Optoelectronics	0	0	0	0	0	0	0	0	0	NA
Memory	2	3	9	18	46	76	126	170	155	54.1
<b>Total</b>	<b>4</b>	<b>6</b>	<b>13</b>	<b>61</b>	<b>259</b>	<b>488</b>	<b>819</b>	<b>1,144</b>	<b>1,459</b>	<b>88.7</b>

NA = Not applicable

Source: Dataquest (September 1997)

**Table 3-3**  
**Worldwide Chip Market for Digital Satellite Set-Top Boxes by Semiconductor Type**  
 (Millions of Dollars)

	1993	1994	1995	1996	1997	1998	1999	2000	2001	CAGR (%) 1996-2001
Digital ASIC	0	45	57	316	314	228	139	88	82	-23.6
Digital ASSP	0	40	45	264	316	468	724	726	576	16.9
Digital Standard IC	0	15	31	51	56	51	60	67	67	5.8
MPU/MCU	0	14	30	50	55	49	57	65	64	5.1
DSP	0	0	0	0	0	0	0	0	0	NA
Standard Logic	0	2	0	0	0	0	0	0	0	NA
Analog ASIC	0	0	0	0	0	0	0	0	0	NA
Analog ASSP	0	0	0	0	0	0	0	0	0	NA
Analog Standard IC	0	23	51	130	145	154	124	95	94	-6.3
Mixed-Signal ASIC	0	0	0	0	0	0	0	0	0	NA
Mixed-Signal ASSP	0	0	0	0	0	66	204	551	827	NA
Mixed-Signal Standard IC	0	14	20	2	2	3	4	5	6	22.7
Discrete	0	8	15	42	41	47	54	34	36	-3.0
Optoelectronics	0	0	0	0	0	0	0	0	0	NA
Memory	0	85	348	227	115	127	151	170	118	-12.2
<b>Total</b>	<b>0</b>	<b>230</b>	<b>568</b>	<b>1,032</b>	<b>988</b>	<b>1,144</b>	<b>1,460</b>	<b>1,737</b>	<b>1,807</b>	<b>11.9</b>

NA = Not applicable

Source: Dataquest (September 1997)

By the first part of September, the DVD market foundation began to crumble. While version 1.0 of DVD-R and DVD-RAM drives was announced, key members of the DVD forum broke away with plans to introduce their own competitive DVD rewritable drives. At least four major competing standards, including the standard adopted by the DVD forum, are now being developed. Another competitor to the DVD-Video standard was introduced with the backing of Circuit City called Digital Video Express, Divx. While the first Divx drives are not expected to ship until mid-1998, it has introduced a significant degree of uncertainty along with concerns about obsolescence and incompatibility into the DVD market. These developments have the potential to delay DVD market growth by 18 to 24 months beyond the forecast presented in this publication.

DVD video players are based on MPEG-2 and AC-3 compression technology and use shorter-wavelength diodes to allow playback of full-length movies from one CD-ROM-size disc. Although early video players will employ a variety of ASICs and ASSPs in a low-integration solution, there will be a shift to second-generation products quickly that employ highly integrated ASSP and ASIC solutions. Many chip companies are targeting this opportunity with competitive digital and mixed-signal ASSP solutions. The advanced optical storage technology employed in these products drives higher costs for the optical electronics and motor drivers. The channel and video processing requirements in these systems are 2.5MB of DRAM. These initial video players are playback devices only and use decoder technology that combines MPEG-2 and AC-3 as mandatory standards with other optional compression standards.

Although the cost for MPEG-2 compression chipsets ranges in the thousands of dollars currently, Dataquest's forecast for this market anticipates the development of low-cost MPEG-2 encoding chipsets that would enable a mass market for recordable DVD video players. Full read/write-capable players that employ codecs are expected to reach the market by late 1998 or early 1999. These expectations are supported by the C-Cube announcement of its DVx MPEG-2 codec architecture. The road map for chips based on this architecture should support chips with the necessary price and performance to enable a recordable DVD video player. There are also opportunities to create hybrid set-top box and DVD products because of the common compression technologies employed in these products. This forecast does not attempt to project the market for these hybrid products. Table 3-4 presents a detailed semiconductor market forecast for DVD video players. However, it should be re-emphasized that recent market developments make this forecast a best-case scenario.

## Video CD Players

Although relatively unknown in the Americas and Europe, video CD players have achieved high-volume shipments in Japan and Asia/Pacific. More than 90 percent of the market was driven by China during 1996 and 1997. Worldwide production, dominated by China, reached 7 million units in 1996 and is expected to hit 15 million in 1997 with significant price decreases and improved performance. With their application in karaoke products and the support of a large number of low-cost movie titles, these players are expected to continue on a strong growth path over the next two years reaching a plateau toward the end of 1998 or early 1999. However a large market will still exist through 2000 and 2001.

**Table 3-4**  
**Worldwide Chip Market for DVD Video Players by**  
**Semiconductor Type (Millions of Dollars)**

	1996	1997	1998	1999	2000	2001
Digital ASIC	1	15	38	83	83	81
Digital ASSP	2	55	135	305	460	542
Digital Standard IC	0	9	17	35	41	41
MPU/MCU	0	6	14	30	37	37
DSP	0	0	0	0	0	0
Standard Logic	0	3	3	5	4	4
Analog ASIC	0	0	0	0	0	0
Analog ASSP	0	4	10	22	31	36
Analog Standard IC	0	3	5	12	17	20
Mixed-Signal ASIC	1	8	17	30	36	33
Mixed-Signal ASSP	1	47	116	247	354	455
Mixed-Signal Standard IC	0	0	0	0	0	0
Discrete	0	4	5	15	29	24
Optoelectronics	1	18	43	90	129	160
Memory	2	34	73	171	248	236
<b>Total</b>	<b>9</b>	<b>197</b>	<b>458</b>	<b>1,010</b>	<b>1,429</b>	<b>1,628</b>

NA = Not applicable

Source: Dataquest (September 1997)

These players are based on MPEG-1 compression technology. Through most of 1996, C-Cube Microsystems Inc. was the dominant supplier of MPEG-1 chipsets for video CD. With heavy market demand and C-Cube's dominance during 1996, the MPEG-1 chipset pricing remained high after an earlier drop during 1995. Toward the end of 1996, ESS Technology entered the market and presented a strong challenge for market share. The ensuing price war caused a steep drop in the price of MPEG-1 chipsets during 1997.

The chips in these players are highly integrated, and even with the introduction of a new video CD standard, the technology is maturing and has the potential for further cost reductions. The channel/video processing in these players only requires 4Mb of memory, which could eventually be integrated with the other logic in the next level of integration. Table 3-5 presents a detailed semiconductor market forecast for video CD players.

**Table 3-5**  
**Worldwide Chip Market for Video CD Players by Semiconductor Type**  
**(Millions of Dollars)**

	1993	1994	1995	1996	1997	1998	1999	2000	2001	CAGR (%) 1996-2001
Digital ASIC	2	15	0	0	0	0	0	0	0	NA
Digital ASSP	0	10	64	234	207	200	160	123	72	-21.1
Digital Standard IC	0	8	20	69	38	21	16	11	7	-37.7
MPU/MCU	0	4	9	31	26	19	16	11	7	-25.7
DSP	0	0	0	0	0	0	0	0	0	NA
Standard Logic	0	4	11	38	11	2	0	0	0	-100.0
Analog ASIC	0	0	0	0	0	0	0	0	0	NA
Analog ASSP	0	2	4	15	29	40	36	30	20	6.1
Analog Standard IC	0	4	7	19	35	40	34	26	17	-2.2
Mixed-Signal ASIC	0	0	0	0	0	0	0	0	0	NA
Mixed-Signal ASSP	0	6	14	48	96	127	118	102	73	8.9
Mixed-Signal Standard IC	0	8	14	38	72	87	76	61	40	1.3
Discrete	0	0	0	1	3	4	3	3	2	14.9
Optoelectronics	0	5	10	31	55	76	71	61	44	7.2
Memory	1	12	31	41	39	42	37	30	11	-22.7
<b>Total</b>	<b>5</b>	<b>69</b>	<b>166</b>	<b>496</b>	<b>574</b>	<b>636</b>	<b>551</b>	<b>445</b>	<b>285</b>	<b>-10.5</b>

NA = Not applicable

Source: Dataquest (September 1997)

## Next-Generation Video Game Consoles

With the introduction of the Nintendo 64, the industry completed its shift from 16-bit hardware to an emphasis on shipments of next-generation 32- and 64-bit video game consoles by all three major players, Sega, Sony, and Nintendo. All of these systems employ ASICs extensively. However, the Nintendo 64 has achieved the highest level of integration in its design and the most efficient use of DRAM. The Nintendo 64 uses two Rambus RDRAM chips, while the Sega Saturn and Sony PlayStation use a variety of DRAM and VRAM. The high cost of memory in these systems was a major cost driver until the major DRAM price erosion in 1996. This drop in memory costs helped Sony and Nintendo to drop the retail price for their systems to \$149 by mid-1997.

During 1996 production of these systems reached 16 million units with very strong market demand. The combination of low-price and high-performance continues to drive strong market demand during 1997. Sony and Nintendo have ramped production to unprecedented rates that could drive unit production over 27 million in 1997. Sega is slipping badly with its Saturn system and is in danger of falling out of the video game console market unless it is able to introduce a system that will allow it to compete more effectively with Sony and Nintendo on the aggressive price/performance curve they are following. With Sega's decline, the average semiconductor content and composition is increasingly driven by the more integrated Sony and Nintendo systems.



One of the main differentiators between the Sony and Sega systems and the Nintendo system is their use of a CD-ROM instead of cartridges for software delivery. There is no compression technology employed in any of these systems today. There has been some discussion of eventual migration to DVD drives, but Dataquest does not expect this to happen until late 1999 at the earliest. Table 3-6 presents a detailed semiconductor market forecast for next-generation video game consoles.

## DTV

The digital television (DTV) market is expected to commence in the United States and in Europe in 1998. In the United States, the passage of the ATSC DTV standard by the Federal Communications Commission (FCC) has cleared the way for the start of the market late next year. In Europe, the DTV market is expected to start in mid-1998. In Japan, DTV is not expected to arrive until the year 2000. Manufacturers are expected to offer three types of DTV receivers: HDTV television sets, SDTV television sets, and DTV set-top boxes. (Manufacturers also will sell personal computers with DTV tuners, but those are not covered in this report.) In Europe, the market is expected to consist mainly of DTV set-top boxes. In Japan, HDTV appears to be the primary direction for DTV receivers. In the United States, all three types of platforms will be produced and sold. From a high-level point of view, the semiconductor content of DTV receivers resembles that of digital cable and digital satellite set-top boxes. Both DTV receivers and digital cable and satellite set-top boxes can use MPEG-2 video decompression chips, AC-3 or MPEG-2 audio decompression devices, and DRAM for decompression buffering. Semiconductor cost for DTV receivers can vary depending on the type of platform, the resolution of the image it can receive and display, and other factors. Table 3-7 presents a detailed semiconductor market forecast for DTV receivers. It should be noted that this forecast does not include analog HDTV televisions.

## Digital Still Cameras

Sales of digital still cameras are expected to grow rapidly as prices decline. The strongest unit growth is expected to start in 1998 and hold through the end of the century as mainstream camera prices drop into the range of \$300 or less. Although digital still cameras can replace conventional film cameras, most consumers through the end of the century will use them exclusively to import images into PCs. Because of this, the available market for digital still cameras is expected to be limited primarily to PC owners and PC buyers through the end of the century. Graphics processing accounts for the majority of the value of the semiconductor content in a digital camera. The charge-coupled device (CCD) has been the single most expensive component in most digital still cameras, although competition and learning curve reductions in CCD prices are helping to reduce digital camera average selling prices (ASPs) significantly. New CMOS sensor devices also should serve to reduce camera prices and improve functionality and quality. To maximize memory efficiency, digital still cameras also include compression engines that use JPEG and/or a proprietary algorithm.

**Table 3-6**  
**Worldwide Chip Market for Next-Generation Video Game Consoles by Semiconductor Type (Millions of Dollars)**

	1993	1994	1995	1996	1997	1998	1999	2000	2001	CAGR (%) 1996-2001
Digital ASIC	4	67	188	658	1,211	1,120	924	836	1,012	9.0
Digital ASSP	0	0	0	0	0	0	0	0	0	NA
Digital Standard IC	3	42	170	333	138	130	88	72	83	-24.3
MPU/MCU	2	34	144	300	124	117	84	71	82	-22.8
DSP	1	6	17	23	10	9	3	1	0	-100.0
Standard Logic	0	2	8	10	4	4	1	1	1	-36.9
Analog ASIC	0	0	0	0	0	0	0	0	0	NA
Analog ASSP	0	0	1	2	1	0	0	0	0	-100.0
Analog Standard IC	0	2	8	30	59	56	42	34	39	5.5
Mixed-Signal ASIC	0	0	76	218	420	386	310	258	302	6.7
Mixed-Signal ASSP	0	0	0	0	0	0	0	0	0	NA
Mixed-Signal Standard IC	1	9	26	61	98	87	64	51	55	-2.1
Discrete	0	2	6	12	15	11	9	8	9	-5.6
Optoelectronics	1	11	27	57	72	101	78	66	78	6.7
Memory	12	181	664	656	464	345	257	225	159	-24.7
<b>Total</b>	<b>21</b>	<b>314</b>	<b>1,166</b>	<b>2,027</b>	<b>2,478</b>	<b>2,237</b>	<b>1,772</b>	<b>1,551</b>	<b>1,736</b>	<b>-3.0</b>

NA = Not applicable

Source: Dataquest (September 1997)

**Table 3-7**  
**Worldwide Chip Market for DTV Receivers by Semiconductor Type (Millions of Dollars)**

	1997	1998	1999	2000	2001
Digital ASIC	0	1	5	20	102
Digital ASSP	0	0	2	18	127
Digital Standard IC	0	0	1	3	19
MPU/MCU	0	0	1	3	18
DSP	0	0	0	0	0
Standard Logic	0	0	0	0	1
Analog ASIC	0	0	0	0	0
Analog ASSP	0	0	0	0	0
Analog Standard IC	0	0	1	4	23
Mixed-Signal ASIC	0	0	1	8	58
Mixed-Signal ASSP	0	0	1	6	40
Mixed-Signal Standard IC	0	0	0	0	1
Discrete	0	0	0	1	7
Optoelectronics	0	0	0	0	0
Memory	0	0	2	13	44
<b>Total</b>	<b>0</b>	<b>1</b>	<b>13</b>	<b>74</b>	<b>419</b>

Source: Dataquest (September 1997)

The compressed images are stored in flash memory. Flash memory cost reductions also should help to further drive down the price of digital still cameras. The current trend in the digital still camera market is to use removable flash memory cards as the exclusive medium for storing images. Current digital still cameras make heavy use of standard digital products. However, as cameras evolve, they are expected to make increasing use of more cost-effective ASSPs. Table 3-8 presents a detailed semiconductor market forecast for digital still cameras. It should be noted that this forecast includes flash memory that comes in removable cards that are sold bundled with digital still cameras.

## Digital Video Camcorders

Home digital camcorders, introduced in 1994, experienced a booming Japanese market in 1996, and the Japanese and Asian markets are continuing to ramp. The digital camcorders currently produced are based on specifications for consumer digital VCRs, the standards adopted by the industry in April 1994. In the Japanese market, digital camcorders gained more than 50 percent of the camcorder market in 1996. Acceptance in U.S. and European markets has been much lower because of high retail prices, more than \$2,000 on average. Dataquest expects new digital camcorders to be introduced that will benefit from higher levels of chip integration and lower costs. This will enable lower retail pricing, which will support growth in U.S. and European markets.

**Table 3-8**  
**Worldwide Chip Market for Digital Still Cameras by Semiconductor Type**  
(Millions of Dollars)

	1993	1994	1995	1996	1997	1998	1999	2000	2001	CAGR (%) 1996-2001
Digital ASIC	0	3	16	86	154	108	81	57	52	-9.4
Digital ASSP	0	0	0	0	0	74	73	66	71	NA
Digital Standard IC	0	1	7	29	50	49	49	33	31	1.3
MPU/MCU	0	1	4	17	29	26	26	17	16	-1.2
DSP	0	0	0	0	0	0	0	0	0	NA
Standard Logic	0	0	3	13	22	23	23	16	15	2.9
Analog ASIC	0	0	0	0	0	0	0	0	0	NA
Analog ASSP	0	0	0	0	0	0	0	0	0	NA
Analog Standard IC	0	0	0	2	3	8	9	10	11	42.5
Mixed-Signal ASIC	0	0	0	0	0	0	0	0	0	NA
Mixed-Signal ASSP	0	0	0	0	0	81	80	73	82	NA
Mixed-Signal Standard IC	0	0	1	5	6	15	17	19	21	34.4
Discrete	0	0	1	7	8	17	17	17	17	19.4
Optoelectronics	0	1	10	48	66	135	142	158	158	27.0
Memory	0	1	13	36	49	125	149	176	202	40.9
<b>Total</b>	<b>0</b>	<b>7</b>	<b>50</b>	<b>214</b>	<b>336</b>	<b>611</b>	<b>618</b>	<b>609</b>	<b>646</b>	<b>24.8</b>

NA = Not applicable

Source: Dataquest (September 1997)

Although optical components are a major cost element, the digital camcorder will drive opportunities for low-power ASIC and ASSP chips. This segment is also a prime candidate for system-level integration products. The variety of DRAM and SRAM blocks used in various segments of the system would ideally be integrated into a system-level solution driving down the cost significantly. Currently, discrete cosine transform (DCT) compression technology is used in digital camcorders. However, Hitachi has demonstrated an MPEG-1-based camcorder, and products employing MPEG-2 compression should become available perhaps as early as 2000 or 2001. Table 3-9 presents a detailed semiconductor market forecast for digital video camcorders.

## Other Next-Generation Consumer Electronics Products

Products included in the other category of this forecast include DVD audio players, digital VCRs, and other advanced consumer devices that may be introduced over the next five years. Table 3-10 lists the worldwide chip market for such products.

**Table 3-9**  
**Worldwide Chip Market for Digital Camcorders by Semiconductor Type**  
(Millions of Dollars)

	1993	1994	1995	1996	1997	1998	1999	2000	2001	CAGR (%) 1996-2001
Digital ASIC	0	3	10	51	72	92	102	93	93	12.8
Digital ASSP	0	0	0	0	14	35	51	51	65	NA
Digital Standard IC	0	2	6	27	38	50	51	42	42	9.0
MPU/MCU	0	1	2	9	12	12	10	2	0	-100.0
DSP	0	0	0	0	0	0	0	0	0	NA
Standard Logic	0	1	4	18	27	37	41	40	42	18.5
Analog ASIC	0	0	0	0	0	0	0	0	0	NA
Analog ASSP	0	1	2	10	29	53	68	81	105	59.5
Analog Standard IC	0	3	11	51	51	71	77	68	65	5.0
Mixed-Signal ASIC	0	4	14	68	91	124	145	139	148	17.0
Mixed-Signal ASSP	0	0	0	0	24	57	85	101	130	NA
Mixed-Signal Standard IC	0	2	7	34	48	70	81	76	79	18.3
Discrete	0	0	0	2	2	4	4	4	5	22.3
Optoelectronics	0	3	9	41	60	92	115	118	134	27.1
Memory	0	7	20	56	50	61	73	71	62	2.2
<b>Total</b>	<b>0</b>	<b>25</b>	<b>79</b>	<b>338</b>	<b>481</b>	<b>709</b>	<b>854</b>	<b>845</b>	<b>926</b>	<b>22.3</b>

NA = Not applicable

Source: Dataquest (September 1997)

**Table 3-10**  
**Worldwide Chip Market for Other Consumer Electronics Products by Semiconductor Type (Millions of Dollars)**

	1995	1996	1997	1998	1999	2000	2001	CAGR (%) 1996-2001
Digital ASIC	0	1	3	6	8	18	28	82.7
Digital ASSP	0	0	1	4	8	17	26	NA
Digital Standard IC	0	0	1	2	2	5	6	67.1
MPU/MCU	0	0	1	1	1	2	3	67.1
DSP	0	0	1	1	1	2	3	67.1
Standard Logic	0	0	0	0	0	1	1	67.1
Analog ASIC	0	0	0	0	0	0	0	NA
Analog ASSP	0	1	3	6	10	27	33	104.0
Analog Standard IC	0	0	1	1	4	5	9	83.1
Mixed-Signal ASIC	0	1	3	6	8	12	18	65.5
Mixed-Signal ASSP	0	0	1	5	13	23	46	NA
Mixed-Signal Standard IC	0	1	2	2	2	3	3	41.1
Discrete	0	0	0	0	3	5	9	120.4
Optoelectronics	0	0	1	0	3	5	9	106.6
Memory	0	1	2	12	30	56	101	170.5
<b>Total</b>	<b>0</b>	<b>6</b>	<b>20</b>	<b>45</b>	<b>90</b>	<b>176</b>	<b>287</b>	<b>114.6</b>

NA = Not applicable

Source: Dataquest (September 1997)

## Chapter 4

# The Expanding Market for Compression Chips

---

Compression technology sits at the heart of most advanced consumer electronics products, and these products are driving a strong market demand for compression. However, compression products are finding important markets in other areas beyond the consumer electronics category, such as PCs, PC add-in cards, videoconferencing equipment, and broadcast/head-end/postproduction equipment. To present a more complete forecast of the compression market opportunity, this report presents a forecast for the use of compression in these products in addition to the consumer electronics products.

## Compression Standards

Forecasts for the major compression standards of JPEG, Motion JPEG, MPEG-1, MPEG-2, AC-3, Indeo, DigiCipher, and H.261/H.263 are presented in this chapter. A brief discussion of these standards and their applications is presented in the following sections.

### JPEG and Motion JPEG

JPEG stands for Joint Picture Experts Group and is the nickname for the committee that defined this standard. This standard was defined as a still-image compression standard, but it is also used extensively for video compression and is referred to as Motion JPEG in these applications. In Motion JPEG, each video frame is compressed independently of all others, which is different from the MPEG and H.261 standards, which employ inter-frame and intraframe compression. Because each frame is entirely independent of the others, Motion JPEG performs well in applications where random access or the ability to recover easily from lost frames is required, such as video editing or high-quality videoconferencing on normal packet LANs.

### MPEG-1

The MPEG acronym stands for Motion Picture Experts Group, the committee that established the standard. The MPEG-1 standard was developed for delivery of movies at encoded data rates of about 1.5 Mbps. This rate fits well with applications such as single-speed CD-ROMs and T1 connections. In a single-speed CD-ROM application, the compressed video stream occupies about 1.1 Mbps of the overall data rate, with audio and overhead processing consuming the remaining bandwidth. The compression artifacts of MPEG-1 appear as "blockiness" at the edges of 8 x 8-pixel blocks and other image degradation is inherent in this algorithm. Because the encoding process is so processor intensive, dedicated hardware encoding systems range in price from a few thousand dollars to more than \$50,000. The video CD standard uses MPEG-1 for video and audio encoding. However, low-cost MPEG-1 encoding systems are becoming available for PC-based video editing applications.

### **MPEG-2 and AC-3**

The MPEG-2 standard is a superset of the MPEG-1 standard and offers a greater variety of options and higher-quality reproduction of video and audio. The primary MPEG-2 applications are digital cable and satellite set-top boxes, DVD video players and PC add-in cards, and DTV. The DVD standard specifies a combination of MPEG-2 video compression and AC-3 audio compression with an optional, undefined third compression standard. The AC-3 audio compression standard was developed by Dolby Laboratories, working closely with Zoran Corporation. The use of AC-3 compression in DVD and set-top boxes applications and the related MPEG-2/AC-3 market is included in this forecast. The AC-3 chips are used in home theater surround sound stereo systems also. However, these stereo implementations do not employ the compression element of the algorithm and are not counted in this forecast.

### **H.261**

This Integrated Telecommunications Union standard has become the mainstream method of compressing video information in room, roll-about, and PC-based videoconferencing systems. The mainstreaming of this technology has supplanted or complemented a variety of proprietary algorithms employed by companies like PictureTel, Compression Labs, and Intel (Proshare/Indeo). H.261 is part of an overall H.320 standard that specifies all of the aspects of protocol and control involved in establishing and maintaining a videoconferencing session. H.261 is oriented toward operating with ISDN bearer channels (at 64 Kbps) and fractional T1 and E1 rates up to 2 Mbps. H.261 is similar to MPEG in that it uses digital cordless telephony (DCT) algorithms to eliminate redundant visual information.

### **H.263**

This DCT-based algorithm is designed to work with the H.324 plain old telephone service (POTS) standard. Designed to operate over a 28.8-Kbps dial-up modem, the standard can work with 88 x 72-pixel images up to four times standard NTSC TV resolution. It was tailored to be visually effective at low bit rates, but many believe it is better than H.261 at higher bit rates and therefore could possibly supplant that standard eventually.

### **Indeo and Proprietary Algorithms**

Before the broad international support of H.261 and H.263 appeared, a variety of proprietary compression algorithms existed in videoconferencing. As noted above, each major videoconferencing vendor had its own approach. These algorithms were used as one of the points of product differentiation, as the vendors claimed theirs had the better quality. The problem was that the algorithms were not interoperable with each other—one had to have PictureTel and Compression Labs systems in all conferencing locations in order to communicate. Intel's support for Indeo was largely motivated by its desire to ensure that a MIPS-consuming application would be enabled on the desktop PC. For the most part, these proprietary approaches have been phased out or remain as backwardly compatible options on videoconferencing systems.

## **Content Creation and Distribution Encoding Systems**

In the creation of video-based content, a variety of systems are employed. These systems prepare the content for publication or storage and help in the editing and mastering process. In the process, these systems encode or compress the video (and audio) content using one of a variety of compression standards. Key content examples include CD-ROM titles (games, reference, and so on), video CD (primarily video karaoke), and the emerging market of DVD movie titles. The systems span the range from PC-based add-in cards and software (including soft codecs), to rack-mounted editing and production systems costing \$100,000 or more for Hollywood film editing and mastering. The bulk of desktop PC (or workstation) systems currently deal with MPEG-1 and other PC-oriented algorithms such as CinePak. There is an emerging opportunity for systems that employ MPEG-2 algorithms to create DVD movie titles.

There are also systems that are oriented toward real-time (or near-real-time) encoding of broadcast television and private satellite links. The primary purpose of these systems is to conserve bandwidth and push more content through the same bandwidth. Key standards employed in these systems are MPEG-2, DigiCipher (1 and 2), and other proprietary versions from companies like Compression Labs. These are mostly expensive rack-mounted systems costing tens of thousands of dollars each. These systems can be employed by one or more of the following:

- Direct broadcast satellite services (like DirectTV or PerfecTV)
- Remote live news gathering (like the Cable News Network)
- Terrestrial broadcast and cable TV back-haul and distribution
- Local ad insertion by CATV and multipoint, multichannel distribution systems (MMDS) systems
- Private satellite links

## **Compression Technologies in PC Applications**

Video compression technologies will see much greater use in PC applications in the future. This is driven by a combination of faster PCs, higher-quality software codecs, improved video acceleration features in graphics chips, and new types of high-density, removable mass storage. The CD-ROM made digital video content economical to deliver to end users, but performance limitations of the drives and PCs limited the playback quality and therefore limited acceptance. Digital video playback has been hindered by perceptions of low quality (lower than broadcast TV), which was caused by PC performance and codec compatibility issues. This is changing as Pentium and Pentium II microprocessors get higher clock rates and with use of special multimedia instruction sets such as Intel's MMX. Faster PCs, together with higher-quality software codecs and faster CD-ROM drives, will drive greater use of digital video on PCs. Software codecs will be heavily leveraged for MPEG-1 content.

MPEG-2 usage will be driven by the availability of DVD drives and software content. MPEG-2 decoders require much greater processing power than MPEG-1 decoders and will realistically require some degree of hardware acceleration outside the host CPU for the next 18 to 24 months.



Audio compression technologies will rise in use as audio chip vendors continue to add value to the digital controllers for audio subsystems. One application that will drive a need for audio compression in the corporate computing environment is videoconferencing. Other applications of audio compression are tied to consumer and entertainment applications. MPEG audio and AC-3 will be tied to use of MPEG digital video and are expected to grow as use of those video compression technologies grows.

Audio and video compression technologies will see greater use in PCs because all of the pieces of the puzzle are in place. Fast CPUs, quality software codecs, inexpensive hardware codecs, and high-speed, high-density, inexpensive mass storage all create an environment where the PC users' expectation of quality can be reasonably achieved. TV-quality (or better) digital video is becoming affordable because of these compression technologies, and that will drive greater usage for business and consumer applications.

## The Compression Semiconductor Opportunity

Tables 4-1, 4-2, and 4-3 present the forecast of systems shipping that include some form of hardware compression content. Because the possible chip implementations of compression can range from multichip solutions through single-chip products to embedded functions in larger processors and ASSPs, the unit shipments in these tables are not intended to represent actual chip shipment numbers. It is important to understand that these tables present system shipments and not chip shipments. Also, Tables 4-4 and 4-5 present separate shipment numbers for systems with video and audio compression, respectively. Because most systems include both audio and video compression, the total compression shipments are not additive, as can be seen in the summary shown in Table 4-1. It should be noted that increased use of MPEG-2 and AC-3 decoding software in PCs could result in decreased sales of systems with hardware video and audio compression content. This phenomenon could result in shipments falling somewhat below the forecasts for systems with MPEG-2 and AC-3 decoders and codecs presented in the following tables.

The forecast of market value for compression semiconductor products is presented in Tables 4-4, 4-5, 4-6, and 4-7, as well as Figures 4-1 and 4-2. Again, the silicon implementation of the compression function can take many forms. In valuing the compression market, these forecasts assign a value to the chips or portion of the chip actually implementing the decoding or codec function. If the compression function is part of a larger ASIC or ASSP, only the estimated value of the compression silicon is included in the market value, instead of the price of the complete chip. Tables 4-6 and 4-7 present separate market value numbers for video and audio compression, respectively. In this case, the total value of the separate audio and video compression markets is additive, as shown in the summary in Table 4-2. The value of silicon employed in compression applications is forecast to grow from \$629 million in 1996 to more than \$2.2 billion by the year 2001. The combined market for compression in DVD video players and DVD encode/decode boards for the PC will grow to represent more than one-half of the silicon compression market by the year 2001, followed by digital set-top boxes, with slightly more than one-third of the market.

**Table 4-1**  
**Worldwide Compression Semiconductor Function Shipment Summary by Standard**  
**(Thousands of Units)**

	1993	1994	1995	1996	1997	1998	1999	2000	2001	CAGR (%) 1996-2001
<b>Decoders</b>	<b>90</b>	<b>2,531</b>	<b>10,001</b>	<b>18,390</b>	<b>30,638</b>	<b>50,231</b>	<b>73,259</b>	<b>88,954</b>	<b>95,940</b>	<b>39.2</b>
MPEG-1	82	1,637	7,097	12,557	19,776	25,749	24,437	21,145	14,785	3.3
MPEG-2/AC-3/Others	9	524	1,824	5,008	10,164	24,103	48,822	67,809	81,155	74.6
Digicipher	0	370	1,080	825	698	378	0	0	0	-100.0
<b>Codecs</b>	<b>186</b>	<b>329</b>	<b>701</b>	<b>1,791</b>	<b>4,154</b>	<b>8,918</b>	<b>20,158</b>	<b>46,837</b>	<b>74,614</b>	<b>110.8</b>
JPEG and Motion JPEG	32	69	191	675	1,150	2,527	3,123	3,894	5,456	51.9
MPEG-1	36	138	206	173	172	64	29	17	25	-32.0
MPEG-2/AC-3/Others	0	0	0	1	3	715	3,846	10,266	20,473	695.3
Indeo	8	18	26	18	0	0	0	0	0	-100.0
H.261/H.263 Codec	6	58	100	203	408	764	1,266	1,972	3,078	72.3
Other	105	47	178	722	2,420	4,848	11,894	30,688	45,582	129.1
<b>Total Decoder and Codec</b>	<b>277</b>	<b>2,860</b>	<b>10,702</b>	<b>20,181</b>	<b>34,792</b>	<b>59,148</b>	<b>93,417</b>	<b>135,791</b>	<b>170,555</b>	<b>53.2</b>

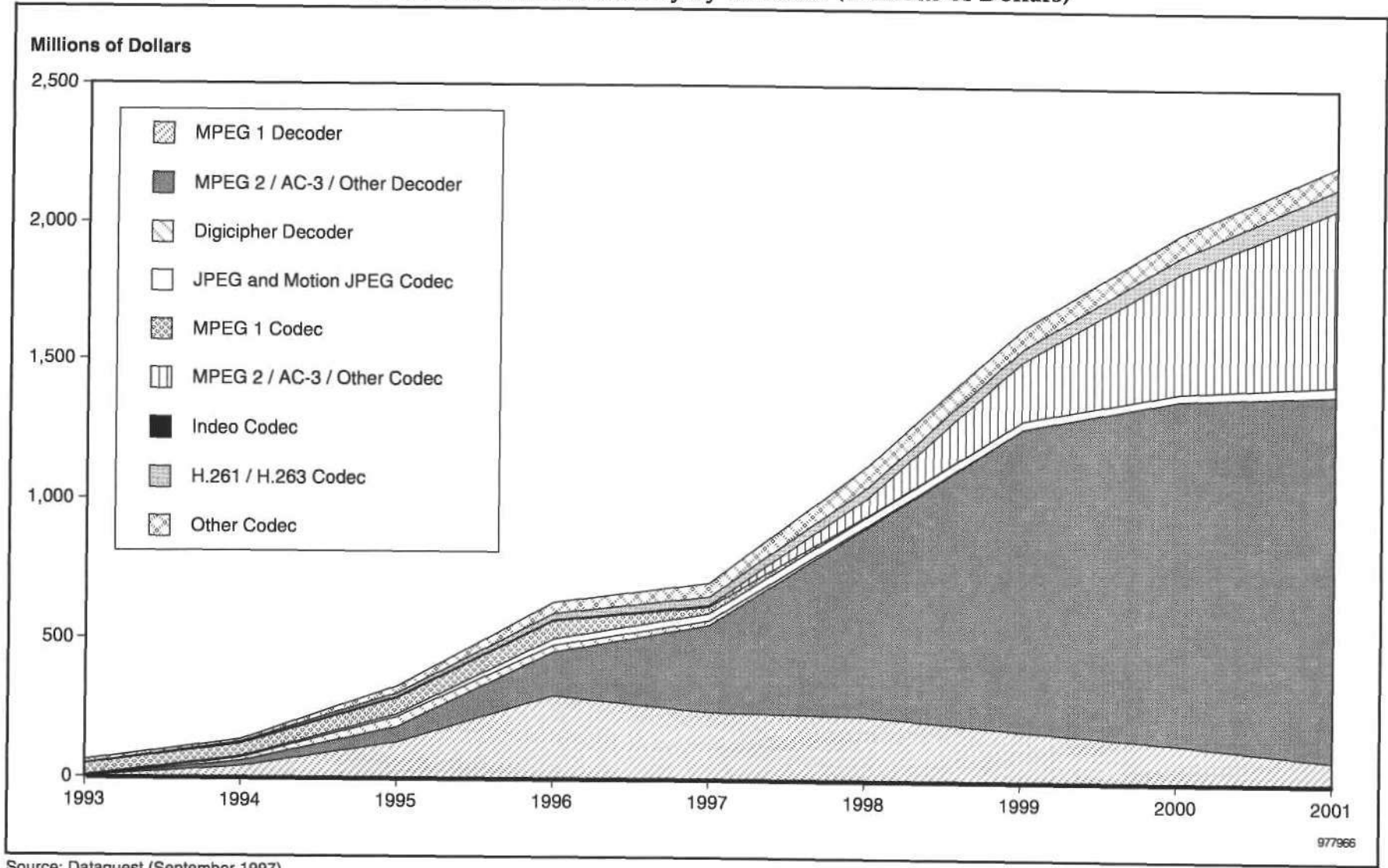
Source: Dataquest (September 1997)

**Table 4-2**  
**Worldwide Compression Semiconductor Market Summary by Standard**  
**(Millions of Dollars)**

	1993	1994	1995	1996	1997	1998	1999	2000	2001	CAGR (%) 1996-2001
<b>Decoder</b>	<b>3</b>	<b>69</b>	<b>216</b>	<b>476</b>	<b>566</b>	<b>909</b>	<b>1,265</b>	<b>1,371</b>	<b>1,393</b>	<b>23.9</b>
MPEG-1 Decoder	2	39	126	295	238	227	179	136	79	-23.1
MPEG-2/AC-3/Other Decoder	0	18	55	157	312	675	1,086	1,235	1,313	52.9
Digicipher Decoder	0	12	36	24	16	7	0	0	0	-100.0
<b>Codec</b>	<b>57</b>	<b>66</b>	<b>111</b>	<b>153</b>	<b>134</b>	<b>216</b>	<b>366</b>	<b>608</b>	<b>834</b>	<b>40.4</b>
JPEG and Motion JPEG Codec	3	5	9	23	26	33	29	26	35	8.7
MPEG-1 Codec	39	45	59	64	24	3	0	0	0	-69.3
MPEG-2/AC-3/Other Codec	0	0	1	2	6	65	216	439	644	228.0
Indeo Codec	1	2	3	2	0	0	0	0	0	-100.0
H.261/H.263 Codec	1	5	14	23	30	39	47	60	76	27.4
Other	12	9	26	39	49	77	74	82	79	14.9
<b>Total Decoder and Codec</b>	<b>59</b>	<b>135</b>	<b>327</b>	<b>629</b>	<b>701</b>	<b>1,125</b>	<b>1,631</b>	<b>1,979</b>	<b>2,227</b>	<b>28.8</b>

Source: Dataquest (September 1997)

**Figure 4-1**  
**Worldwide Compression Semiconductor Market Summary by Standard (Millions of Dollars)**



Source: Dataquest (September 1997)

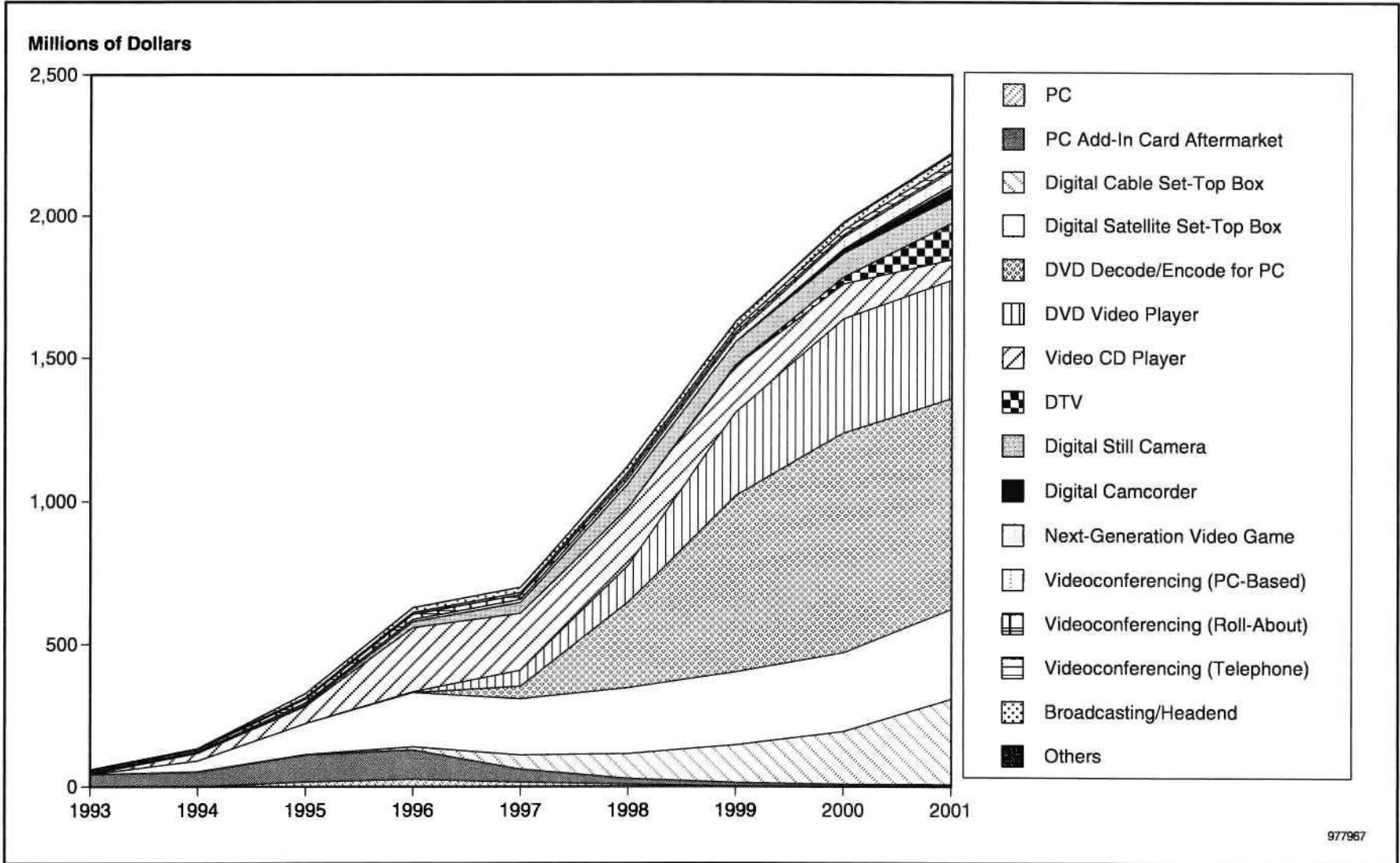
**Table 4-3**  
**Worldwide Compression Semiconductor Market Summary by System**  
**(Millions of Dollars)**

	1993	1994	1995	1996	1997	1998	1999	2000	2001	CAGR (%) 1996-2001
<b>Total</b>	<b>59</b>	<b>135</b>	<b>327</b>	<b>629</b>	<b>701</b>	<b>1,125</b>	<b>1,631</b>	<b>1,979</b>	<b>2,227</b>	<b>28.8</b>
PC	0	0	16	25	16	8	2	1	1	-48.4
PC Add-in Card Aftermarket	43	52	95	105	46	19	13	8	7	-42.3
Digital Cable Set-Top Box	0	1	2	11	50	88	133	186	301	94.9
Digital Satellite Set-Top Box	0	38	109	190	197	231	255	276	316	10.7
DVD Decode/Encode for PC	0	0	0	0	43	301	618	767	736	NA
DVD Video Player	0	0	0	2	57	130	291	402	416	179.0
Video CD Player	2	27	60	225	200	200	160	123	72	-20.5
DTV	0	0	0	0	0	1	5	24	128	NA
Digital Still Camera	0	1	5	21	37	83	82	83	89	33.9
Digital Camcorder	0	0	0	0	0	0	0	12	37	NA
Next-Generation Video Game	0	0	0	0	0	0	0	4	11	NA
Videoconferencing (PC-Based)	4	5	6	8	11	16	24	41	50	42.6
Videoconferencing (Roll-About)	6	8	14	18	16	13	11	9	9	-13.8
Videoconferencing (Telephone)	4	3	4	6	8	10	13	16	23	30.2
Broadcasting / Headend	0	0	14	17	19	22	23	25	28	10.5
Others	0	0	0	0	0	1	2	4	6	973.1

NA = Not applicable

Source: Dataquest (September 1997)

**Figure 4-2**  
**Worldwide Compression Semiconductor Market Summary by System (Millions of Dollars)**



Source: Dataquest (September 1997)

977967

**Table 4-4**  
**Worldwide Video Compression Semiconductor Function Shipments by Standard (Units in Thousands)**

	1993	1994	1995	1996	1997	1998	1999	2000	2001	CAGR (%) 1996-2001
<b>JPEG (Codec)</b>	-	6	51	297	724	2,151	2,830	3,713	5,250	77.6
Digital Still Camera	-	6	51	297	724	2,151	2,830	3,713	5,250	77.6
<b>Motion JPEG (Codec)</b>	32	63	140	378	426	376	293	181	206	-11.4
PC / Workstation	-	-	18	33	43	55	53	45	52	9.7
PC / Workstation Add-in Card Aftermarket	32	63	122	346	383	320	240	136	154	-14.9
<b>MPEG-1 (Decoder)</b>	38	747	3,615	8,023	16,005	21,876	20,352	17,889	13,493	11.0
PC	-	-	503	537	603	554	-	-	-	-100.0
PC Add-in Card Aftermarket	-	62	1,162	486	402	322	352	389	493	0.3
Video CD Player	38	685	1,950	7,000	15,000	21,000	20,000	17,500	13,000	13.2
<b>MPEG-1 (Codec)</b>	31	126	206	259	194	81	13	12	14	-44.4
PC	-	-	-	-	22	17	13	12	14	NA
PC Add-in Card Aftermarket	31	126	206	259	172	64	-	-	-	-100.0
<b>MPEG-2 (Decoder)</b>	9	524	1,824	5,008	10,164	24,103	48,822	67,809	81,155	74.6
Digital Cable Set-Top Box	8	20	63	277	1,450	3,197	5,772	7,766	10,032	105.1
Digital Satellite Set-Top Box	1	504	1,761	4,667	6,037	9,375	12,620	15,777	17,441	30.2
DVD Decode/Encode for PC	-	-	-	-	1,035	7,451	22,381	32,176	37,114	NA
DVD Video Player	-	-	-	65	1,642	4,069	7,944	11,465	12,869	188.2
DTV Receiver	-	-	-	-	-	11	104	626	3,699	NA
<b>MPEG-2 (Codec)</b>	-	-	0	1	3	715	3,846	10,266	20,473	695.3
Digital Cable Set-Top Box	-	-	-	-	-	-	-	863	2,508	NA
DVD Decode/Encode for PC	-	-	-	-	-	381	1,749	5,050	8,408	NA
DVD Video Player	-	-	-	-	-	321	2,073	4,074	8,365	NA
Broadcasting/Headend	-	-	0	1	3	13	24	36	49	137.8
Digital Camcorder	-	-	-	-	-	-	-	243	1,144	NA
<b>Indeo (Codec)</b>	8	18	26	18	-	-	-	-	-	-100.0
Videoconferencing (PC-Based)	8	18	26	18	-	-	-	-	-	-100.0
<b>H.261/H.263 (Codec)</b>	6	58	100	203	408	764	1,266	1,972	3,078	72.3
Videoconferencing (PC-Based)	6	7	14	47	115	242	485	960	1,550	101.4
Videoconferencing (Roll-About)	-	1	15	26	30	31	30	29	31	3.6
Videoconferencing (Telephone)	-	50	70	130	225	405	608	820	1,312	58.8
PC Add-in Card Aftermarket	-	-	-	-	38	85	144	163	185	NA

**Table 4-4 (Continued)**  
**Worldwide Video Compression Semiconductor Function Shipments by Standard (Units in Thousands)**

	1993	1994	1995	1996	1997	1998	1999	2000	2001	CAGR (%) 1996-2001
Digicipher (Decoder)	-	370	1,080	825	698	378	-	-	-	-100.0
Digital Satellite Set-Top Box	-	370	1,080	825	698	378	-	-	-	-100.0
Other (Codec)	105	47	178	722	2,420	4,848	11,894	30,688	45,582	129.1
Digital Still Camera	-	18	152	693	1,345	3,226	3,459	3,713	3,500	38.2
Videoconferencing (PC-Based)	14	11	7	7	13	13	26	51	47	45.2
Videoconferencing (Roll-About)	8	13	15	16	12	6	3	1	-	-100.0
Videoconferencing (Telephone)	83	6	-	-	-	-	-	-	-	NA
Broadcasting/Headend	-	-	3	6	8	9	6	4	3	-15.0
DVD Decode/Encode for PC	-	-	-	-	1,035	1,546	8,270	26,659	41,566	NA
Others	-	-	0	0	7	49	130	260	467	947.1
<b>Total</b>	<b>228</b>	<b>1,958</b>	<b>7,220</b>	<b>15,733</b>	<b>31,042</b>	<b>55,292</b>	<b>89,316</b>	<b>132,52</b>	<b>169,251</b>	<b>60.8</b>
PC	-	-	521	570	668	627	66	57	66	-35.1
PC Add-in Card Aftermarket	63	250	1,491	1,090	995	792	737	688	833	-5.3
Digital Cable Set-Top Box	8	20	63	277	1,450	3,197	5,772	8,629	12,540	114.4
Digital Satellite Set-Top Box	1	874	2,841	5,491	6,735	9,753	12,620	15,777	17,441	26.0
DVD Decode/Encode for PC	-	-	-	-	2,070	9,378	32,401	63,885	87,088	NA
DVD Video Player	-	-	-	65	1,642	4,390	10,017	15,539	21,234	218.5
Video CD Player	38	685	1,950	7,000	15,000	21,000	20,000	17,500	13,000	13.2
DTV Receiver	-	-	-	-	-	11	104	626	3,699	NA
Digital Still Camera	-	24	203	990	2,069	5,377	6,289	7,426	8,749	54.6
Videoconferencing (PC-Based)	28	35	48	72	128	255	510	1,010	1,597	85.9
Videoconferencing (Roll-About)	8	14	30	42	42	37	33	30	31	-5.7
Videoconferencing (Telephone)	83	55	70	130	225	405	608	820	1,312	58.8
Broadcasting/Headend	-	-	3	6	12	21	30	40	52	51.6
Digital Camcorder	-	-	-	-	-	-	-	243	1,144	NA
Others	-	-	0	0	7	49	130	260	467	NA

NA = Not applicable

Source: Dataquest (September 1997)

**Table 4-5**  
**Worldwide Audio Compression Semiconductor Function Shipments by Standard (Units in Thousands)**

	1993	1994	1995	1996	1997	1998	1999	2000	2001	CAGR (%) 1996-2001
<b>MPEG-1 (Decoder)</b>	82	1,637	7,097	12,557	19,776	25,749	24,437	21,145	14,785	3.3
PC	-	-	1,006	1,074	1,005	554	-	-	-	-100.0
PC Add-in Card Aftermarket	36	76	1,572	1,382	574	320	120	-	-	-100.0
Digital Cable Set-Top Box	8	20	63	85	248	437	724	647	564	46.0
Digital Satellite Set-Top Box	-	857	2,507	3,015	2,949	3,438	3,593	2,998	1,221	-16.5
Video CD Player	38	685	1,950	7,000	15,000	21,000	20,000	17,500	13,000	13.2
<b>MPEG-1 (Codec)</b>	36	138	206	173	172	64	29	17	25	-32.0
PC	-	-	-	-	-	-	-	-	-	NA
PC Add-in Card Aftermarket	36	138	206	173	172	64	-	-	-	-100.0
Digital Cable Set-Top Box	-	-	-	-	-	-	29	17	25	NA
<b>MPEG-2 (Decoder)</b>	1	17	334	2,475	3,766	5,701	7,573	9,732	10,651	33.9
Digital Satellite Set-Top Box	1	17	334	2,475	3,766	5,691	7,491	9,419	10,116	32.5
DTV Receiver	-	-	-	-	-	10	82	313	535	NA
<b>AC-3 (Decoder)</b>	-	-	-	-	26	695	1,744	4,040	9,936	NA
Digital Satellite Set-Top Box	-	-	-	-	19	624	1,536	3,356	6,104	NA
DTV Receiver	-	-	-	-	-	1	22	312	3,164	NA
<b>AC-3/MPEG-2/Others (Decoder)</b>	-	-	-	256	3,931	14,899	37,277	55,229	67,764	205.1
Digital Cable Set-Top Box	-	-	-	191	1,202	2,760	4,471	6,256	9,467	118.2
DVD Decode/Encode for PC	-	-	-	-	1,087	8,070	24,862	37,508	45,428	NA
DVD Video Player	-	-	-	65	1,642	4,069	7,944	11,465	12,869	188.2
Digital Camcorder	-	-	-	-	-	-	-	-	-	-
Others	-	-	-	-	-	-	-	-	-	-
<b>AC-3/MPEG-2/Others (Codec)</b>	-	-	0	0	7	774	4,563	11,460	21,089	2,143.5
Digital Cable Set-Top Box	-	-	-	-	-	-	548	1,708	2,483	NA
DVD Decode/Encode for PC	-	-	-	-	-	381	1,749	5,050	8,408	NA
DVD Video Player	-	-	-	-	-	321	2,073	4,074	8,365	NA
Digital Camcorder	-	-	-	-	-	-	-	243	1,144	NA
Others	-	-	0	0	7	72	192	384	690	NA
<b>Others (Codec)</b>	-	-	-	20	41	108	126	149	175	54.6
Digital Still Camera	-	-	-	20	41	108	126	149	175	54.6



Table 4-5 (Continued)

## Worldwide Audio Compression Semiconductor Function Shipments by Standard (Units in Thousands)

	1993	1994	1995	1996	1997	1998	1999	2000	2001	CAGR (%) 1996-2001
<b>Total</b>	<b>118</b>	<b>1,792</b>	<b>7,638</b>	<b>15,481</b>	<b>27,713</b>	<b>47,920</b>	<b>75,563</b>	<b>101,399</b>	<b>123,757</b>	<b>51.6</b>
PC	-	-	1,006	1,074	1,005	554	-	-	-	-100.0
PC Add-in Card Aftermarket	72	213	1,778	1,555	746	385	120	-	-	-100.0
Digital Cable Set-Top Box	8	20	63	277	1,450	3,197	5,772	8,6289	12,540	114.4
Digital Satellite Set-Top Box	1	874	2,8401	5,490	6,735	9,753	12,620	15,772	17,441	26.0
DVD Decode/Encode for PC	-	-	-	-	1,087	8,451	26,612	42,5578	53,835	NA
DVD Video Player	-	-	-	645	1,642	4,390	10,017	15,539	21,234	218.5
Video CD Player	38	685	1,950	7,000	15,000	21,000	20,000	17,500	13,000	13.2
DTV Receiver	-	-	-	-	-	11	104	626	3,699	NA
Digital Still Camera	-	-	-	20	41	108	126	149	175	54.6
Digital Camcorder	-	-	-	-	-	-	-	243	1,144	NA
Others	-	-	0	0	7	72	192	384	690	1,032.0

NA = Not applicable

Source: Dataquest (September 1997)

**Table 4-6**  
**Worldwide Video Compression Semiconductor Market by Standard (Millions of Dollars)**

	1993	1994	1995	1996	1997	1998	1999	2000	2001	CAGR (%) 1996-2001
<b>JPEG (Codec)</b>	-	0	1	4	9	21	22	23	32	48.4
Digital Still Camera	-	0	1	4	9	21	22	23	32	48.4
<b>Motion JPEG (Codec)</b>	3	5	8	19	17	12	8	4	3	-29.1
PC/Workstation	-	-	1	2	2	2	1	1	1	-12.2
PC/Workstation Add-in Card Aftermarket	3	5	7	17	15	10	6	3	3	-31.9
<b>MPEG-1 (Decoder)</b>	1	22	67	181	137	138	112	89	53	-21.7
PC	-	-	7	16	8	5	-	-	-	-100.0
PC Add-in Card Aftermarket	-	2	16	15	5	3	3	3	3	-29.5
Video CD Player	1	20	43	151	125	131	109	87	51	-19.6
<b>MPEG-1 (Codec)</b>	37	38	52	58	19	2	0	0	0	-73.7
PC	-	-	-	-	2	0	0	0	0	NA
PC Add-in Card Aftermarket	37	38	52	58	17	2	-	-	-	-100.0
<b>MPEG-2 (Decoder)</b>	0	18	49	115	199	414	703	782	821	48.1
Digital Cable Set-Top Box	0	1	2	7	28	49	71	76	98	71.5
Digital Satellite Set-Top Box	0	17	47	107	116	143	155	155	171	9.8
DVD Decode/Encode for PC	-	-	-	-	26	164	380	418	364	NA
DVD Video Player	-	-	-	1	29	57	92	111	80	128.1
Next-Generation Video Game Controller	-	-	-	-	-	-	-	4	11	NA
DTV Receiver	-	-	-	-	-	0	4	19	97	NA
<b>MPEG-2 (Codec)</b>	-	-	1	2	6	50	149	305	459	206.5
Digital Cable Set-Top Box	-	-	-	-	-	-	-	28	81	NA
DVD Decode/Encode for PC	-	-	-	-	-	23	52	114	142	NA
DVD Video Player	-	-	-	-	-	13	78	133	185	NA
Broadcasting/Headend	-	-	1	2	6	13	19	22	27	73.4
Digital Camcorder	-	-	-	-	-	-	-	8	25	NA
<b>Indeo (Codec)</b>	1	2	3	2	-	-	-	-	-	-100.0
Videoconferencing (PC-Based)	1	2	3	2	-	-	-	-	-	-100.0
<b>H.261/H.263 (Codec)</b>	1	5	14	23	30	39	47	60	76	27.4
Videoconferencing (PC-Based)	1	1	2	5	9	14	20	33	43	52.5
Videoconferencing (Roll-About)	-	1	7	11	12	11	10	8	9	-5.3
Videoconferencing (Telephone)	-	3	4	6	8	10	13	16	23	30.2
PC Add-in Card Aftermarket	-	-	-	-	2	3	4	2	2	NA

**Table 4-6 (Continued)**  
**Worldwide Video Compression Semiconductor Market by Standard (Millions of Dollars)**

	1993	1994	1995	1996	1997	1998	1999	2000	2001	CAGR (%) 1996-2001
<b>Digicipher (Decoder)</b>	-	12	36	24	16	7	-	-	-	-100.0
Digital Satellite Set-Top Box	-	12	36	24	16	7	-	-	-	-100.0
Others	-	-	-	-	-	-	-	-	-	NA
<b>Other (Codec)</b>	12	9	26	39	49	76	73	81	78	14.7
Digital Still Camera	-	1	4	16	28	61	59	59	56	28.6
Videoconferencing (PC-Based)	2	2	1	1	2	2	4	8	7	45.2
Videoconferencing (Roll-About)	6	7	7	7	5	2	1	0	-	-100.0
Videoconferencing (Telephone)	4	0	-	-	-	-	-	-	-	NA
DVD decode/encode for PC	-	-	-	-	1	1	4	11	13	NA
Broadcasting/Headend	-	-	14	15	13	9	5	2	1	-38.0
Others	-	-	0	0	0	0	0	1	1	NA
<b>Total</b>	<b>56</b>	<b>110</b>	<b>255</b>	<b>468</b>	<b>482</b>	<b>757</b>	<b>1,113</b>	<b>1,345</b>	<b>1,523</b>	<b>26.6</b>
PC	-	-	8	18	11	7	2	1	1	-44.6
PC Add-in Card Aftermarket	40	44	75	90	39	18	12	8	7	-40.5
Digital Cable Set-Top Box	0	1	2	7	28	49	71	104	179	93.3
Digital Satellite Set-Top Box	0	29	83	132	132	150	155	155	171	5.3
DVD Decode/Encode for PC	-	-	-	-	27	188	437	543	518	NA
DVD Video Player	-	-	-	1	29	70	170	244	265	189.8
Video CD Player	1	20	43	151	125	131	109	87	51	-19.6
Next-Generation Video Game Controller	-	-	-	-	-	-	-	4	11	NA
DTV Receiver	-	-	-	-	-	1	4	19	97	NA
Digital Still Camera	-	1	5	20	37	82	81	82	88	34.0
Videoconferencing (PC-Based)	4	5	6	8	11	16	24	41	50	43
Videoconferencing (Roll-About)	6	8	14	18	16	13	11	9	9	-13.8
Videoconferencing (Telephone)	5	3	4	6	8	11	13	17	23	30.2
Broadcasting/Headend	-	-	14	17	19	22	23	25	28	10.5
Digital Camcorder	-	-	-	-	-	-	-	8	25	NA
Others	-	-	0	0	0	0	0	1	1	591.4

NA = Not applicable

Source: Dataquest (September 1997)

**Table 4-7**  
**Worldwide Audio Compression Semiconductor Market by Standard (Millions of Dollars)**

	1993	1994	1995	1996	1997	1998	1999	2000	2001	CAGR (%) 1996-2001
<b>MPEG-1 (Decoder)</b>	<b>1</b>	<b>17</b>	<b>59</b>	<b>113</b>	<b>101</b>	<b>89</b>	<b>67</b>	<b>47</b>	<b>26</b>	<b>-25.4</b>
PC	-	-	8	8	4	1	-	-	-	-100.0
PC Add-in Card Aftermarket	0	1	13	10	3	1	0	-	-	-100.0
Digital Cable Set-Top Box	0	0	1	1	1	2	3	2	2	23.2
Digital Satellite Set-Top Box	-	9	20	21	17	16	13	9	4	-29.6
Video CD Player	0	7	17	75	75	69	51	36	21	-22.5
<b>MPEG-1 (Codec)</b>	<b>2</b>	<b>7</b>	<b>7</b>	<b>5</b>	<b>4</b>	<b>1</b>	<b>0</b>	<b>0</b>	<b>0</b>	<b>-54.6</b>
PC	-	-	-	-	-	-	-	-	-	NA
PC Add-in Card Aftermarket	2	7	7	5	4	1	-	-	-	-100.0
Digital Cable Set-Top Box	-	-	-	-	-	-	0	0	0	NA
<b>MPEG-2 (Decoder)</b>	<b>0</b>	<b>0</b>	<b>6</b>	<b>37</b>	<b>47</b>	<b>57</b>	<b>72</b>	<b>87</b>	<b>96</b>	<b>21.0</b>
Digital Satellite Set-Top Box	0	0	6	37	47	57	71	85	91	19.7
DTV Receiver	-	-	-	-	-	0	1	3	5	NA
<b>AC-3 (Decoder)</b>	<b>-</b>	<b>-</b>	<b>-</b>	<b>-</b>	<b>0</b>	<b>9</b>	<b>18</b>	<b>33</b>	<b>81</b>	<b>NA</b>
Digital Satellite Set-Top Box	-	-	-	-	0	8	16	28	50	NA
DTV Receiver	-	-	-	-	-	0	0	3	26	NA
Others	-	-	-	-	0	1	2	3	6	NA
<b>AC-3/MPEG-2/Other (Decoder)</b>	<b>-</b>	<b>-</b>	<b>-</b>	<b>5</b>	<b>66</b>	<b>195</b>	<b>293</b>	<b>332</b>	<b>315</b>	<b>132.7</b>
Digital Cable Set-Top Box	-	-	-	3	21	37	49	53	80	87.8
DVD Decode/Encode for PC	-	-	-	-	16	105	162	183	166	NA
DVD Video Player	-	-	-	1	28	53	83	96	68	125.6
<b>AC-3/MPEG-2/Other (Codec)</b>	<b>-</b>	<b>-</b>	<b>-</b>	<b>-</b>	<b>-</b>	<b>15</b>	<b>67</b>	<b>134</b>	<b>185</b>	<b>NA</b>
Digital Cable Set-Top Box	-	-	-	-	-	-	10	27	39	NA
DVD Decode/Encode for PC	-	-	-	-	-	8	19	41	51	NA
DVD Video Player	-	-	-	-	-	7	38	63	83	NA
Digital Camcorder	-	-	-	-	-	-	-	4	11	NA

**Table 4-7**  
**Worldwide Audio Compression Semiconductor Market by Standard (Millions of Dollars)**

	1993	1994	1995	1996	1997	1998	1999	2000	2001	CAGR (%) 1996-2001
Other (Codec)	-	-	0	0	0	1	1	1	1	29.7
Digital Still Camera	-	-	-	0	0	1	1	1	1	28.7
Others	-	-	0	0	0	0	0	0	0	NA
<b>Total</b>	<b>3</b>	<b>24</b>	<b>72</b>	<b>161</b>	<b>219</b>	<b>367</b>	<b>518</b>	<b>634</b>	<b>704</b>	<b>34.4</b>
PC	-	-	8	8	4	1	-	-	-	-100.0
PC Add-in Card Aftermarket	3	8	20	15	7	2	0	-	-	-100.0
Digital Cable Set-Top Box	0	0	1	4	23	39	62	82	121	97.4
Digital Satellite Set-Top Box	0	9	27	58	65	81	100	121	145	20.0
DVD Decode/Encode for PC	-	-	-	-	16	113	181	224	217	NA
DVD Video Player	-	-	-	1	28	60	120	158	151	164.6
Video CD Player	0	7	17	75	76	69	51	36	21	-22.5
DTV Receiver	-	-	-	-	-	0	1	5	31	NA
Digital Still Camera	-	-	-	0	1	1	1	1	1	28.7
Digital Camcorder	-	-	-	-	-	-	-	4	11	NA
Others	-	-	-	-	0	1	2	3	6	NA

NA = Not applicable

Source: Dataquest (September 1997)

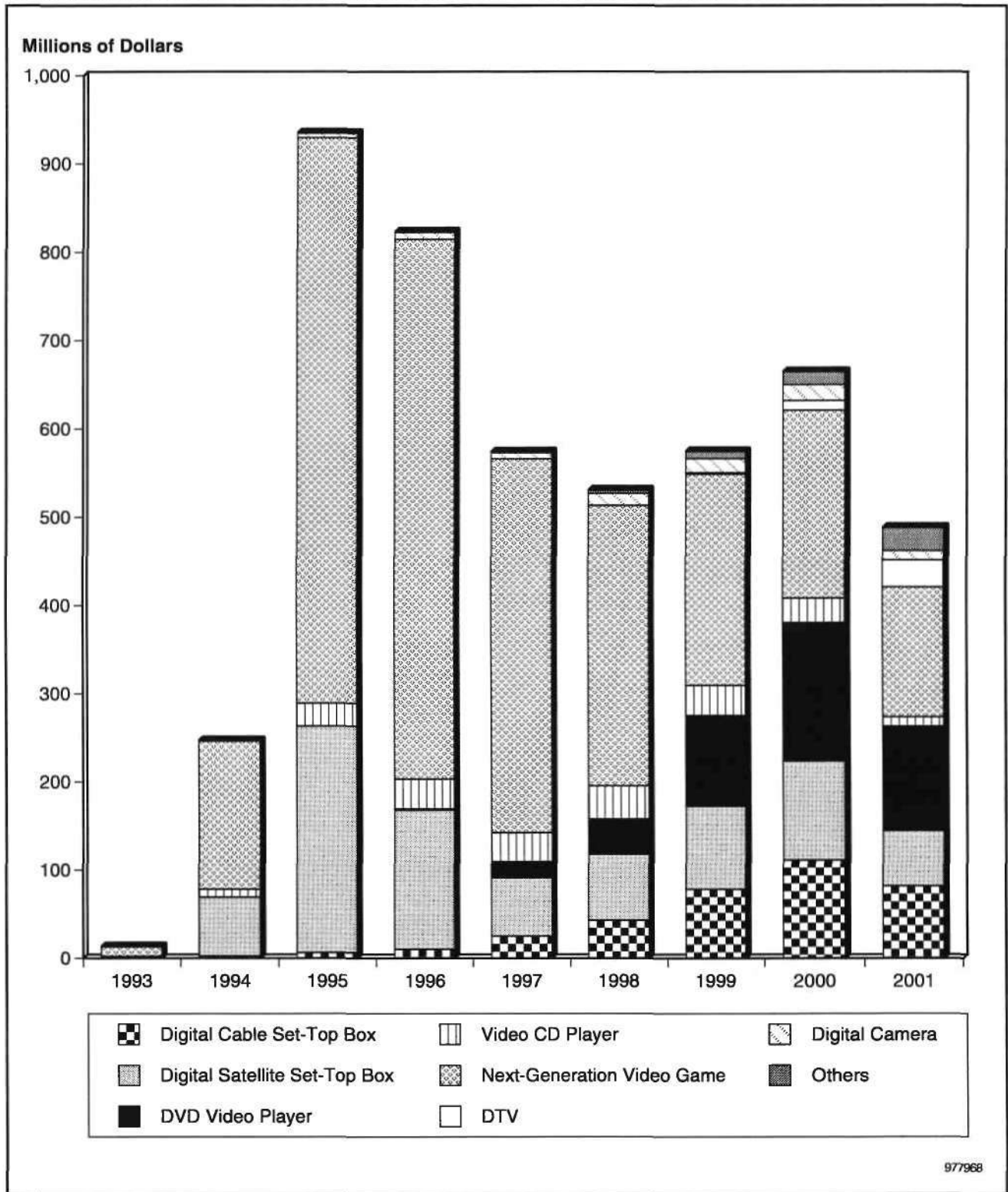
## Chapter 5

# DRAM Dives into Digital Consumer Electronics

---

The new generation of digital consumer electronics will muster significant demand for DRAM through the year 2001. However, the predicted decline in DRAM prices and the inelasticity of DRAM demand in these products will combine to cause an overall decline in DRAM revenue over the forecast period, as shown in Figure 5-1 and Table 5-1.

**Figure 5-1**  
**Worldwide DRAM Memory Market in Next-Generation Consumer Electronics**



Source: Dataquest (September 1997)

**Table 5-1**  
**Worldwide DRAM Memory Market in Next-Generation Consumer Electronics**

	1993	1994	1995	1996	1997	1998	1999	2000	2001	CAGR (%) 1996-2001
<b>Average MB per System</b>										
Digital Cable Set-Top Box	12.0	6.0	4.0	4.0	4.0	4.0	4.0	4.0	4.0	0
Digital Satellite Set-Top Box	12.0	3.3	3.4	3.0	2.3	2.3	2.2	2.2	2.2	-6.0
DVD Video Player	-	-	-	2.5	2.5	2.7	3.0	3.2	3.5	6.9
Video CD Player	0.5	0.5	0.5	0.5	0.5	0.5	0.5	0.5	0.5	0
Next-Generation Video Game	3.0	3.0	3.7	3.5	3.3	3.2	3.2	3.5	4.0	2.7
DTV	-	-	-	-	-	3.7	4.7	5.4	5.0	NA
Digital Camera	-	0.8	0.8	0.8	0.8	0.8	0.8	0.8	0.8	0
Others	1.0	1.0	1.0	1.0	1.0	1.0	1.0	1.0	1.0	0
<b>Total MB (K)</b>	<b>421</b>	<b>8,118</b>	<b>30,378</b>	<b>79,259</b>	<b>126,340</b>	<b>153,158</b>	<b>173,466</b>	<b>211,311</b>	<b>297,923</b>	<b>30.3</b>
Digital Cable Set-Top Box	96	121	252	1,106	5,800	12,788	23,087	34,515	50,159	114.4
Digital Satellite Set-Top Box	6	2,839	9,716	16,470	15,153	21,945	27,765	34,708	38,369	18.4
DVD Video Player	-	-	-	162	4,106	11,777	30,225	49,033	73,998	240.4
Video CD Player	19	343	975	3,500	7,500	10,500	10,000	8,750	6,500	13.2
Next-Generation Video Game	300	4,710	18,972	56,000	90,000	88,200	70,400	66,500	92,000	10.4
DTV	-	-	-	-	-	41	485	3,368	18,586	NA
Digital Camera	-	23	191	825	1,567	4,033	4,717	5,569	6,562	51.4
Others	-	-	2	37	160	750	2,000	4,000	7,175	186.6
<b>Total Market Revenue (\$M)</b>	<b>13</b>	<b>249</b>	<b>942</b>	<b>834</b>	<b>583</b>	<b>542</b>	<b>591</b>	<b>680</b>	<b>496</b>	<b>-9.9</b>
Digital Cable Set-Top Box	2	3	7	11	25	43	78	112	82	50.7
Digital Satellite Set-Top Box	0	67	257	158	66	75	94	112	63	-16.8
DVD Video Player	-	-	-	2	18	40	103	157	118	137.9
Video CD Player	0	9	26	34	33	38	34	28	10	-20.9
Next-Generation Video Game	11	168	640	612	424	318	239	213	147	-24.8
DTV	-	-	-	-	-	0	2	11	30	NA
Digital Camera	-	1	5	8	7	14	16	18	11	6.4
Others	-	-	0	0	1	3	8	14	26	141.4

NA = Not applicable

Source: Dataquest (September 1997)



---

**For More Information...**

Jonathan Cassell, Industry Analyst ..... (408) 468-8195  
Internet address ..... [jonathan.cassell@dataquest.com](mailto:jonathan.cassell@dataquest.com)  
Via fax ..... (408) 954-1780  
Dataquest Interactive ..... <http://www.dataquest.com>

The content of this report represents our interpretation and analysis of information generally available to the public or released by responsible individuals in the subject companies, but is not guaranteed as to accuracy or completeness. It does not contain material provided to us in confidence by our clients. Reproduction or disclosure in whole or in part to other parties shall be made upon the written and express consent of Dataquest.

©1997 Dataquest—Reproduction Prohibited

Dataquest is a registered trademark of A.C. Nielsen Company

## **DATAQUEST WORLDWIDE OFFICES**

### **NORTH AMERICA**

#### **Worldwide Headquarters**

251 River Oaks Parkway  
San Jose, California 95134-1913  
United States  
Phone: 1-408-468-8000  
Facsimile: 1-408-954-1780

#### **East Coast Research Center**

Nine Technology Drive  
P.O. Box 5093  
Westborough, Massachusetts 01581-5093  
United States  
Phone: 1-508-871-5555  
Facsimile: 1-508-871-6262

#### **Dataquest Global Events**

3990 Westerly Place, Suite 100  
Newport Beach, California 92660  
United States  
Phone: 1-714-476-9117  
Facsimile: 1-714-476-9969

### **EUROPE**

#### **European Headquarters**

Tamesis, The Glanty  
Egham, Surrey TW20 9AW  
United Kingdom  
Phone: +44 1784 431 611  
Facsimile: +44 1784 488 980

#### **Dataquest France**

Immeuble Défense Bergères  
345, avenue Georges Clémenceau  
TSA 40002  
92882 - Nanterre CTC Cedex 9  
France  
Phone: +33 1 41 35 13 00  
Facsimile: +33 1 41 35 13 13

#### **Dataquest Germany**

Martin-Kollar-Strasse 15  
D-81829 München  
Germany  
Phone: +49 89 42 70 4-0  
Facsimile: +49 89 42 70 4-270

### **JAPAN**

#### **Japan Headquarters**

Aobadai Hills 4-7-7  
Aobadai  
Meguro-ku, Tokyo 153  
Japan  
Phone: 81-3-3481-3670  
Facsimile: 81-3-3481-3644

### **ASIA/PACIFIC**

#### **Asia/Pacific Headquarters**

Suite 5904-7, Central Plaza  
18 Harbour Road, Wanchai  
Hong Kong  
Phone: 852-2824-6168  
Facsimile: 852-2824-6138

#### **Dataquest Korea**

Suite 2407, Trade Tower  
159 Samsung-dong, Kangnam-gu  
Seoul 135-729  
Korea  
Phone: 822-551-1331  
Facsimile: 822-551-1330

#### **Dataquest Taiwan**

11F-2, No. 188, Section 5  
Nan King East Road  
Taipei  
Taiwan, R.O.C.  
Phone: 8862-756-0389  
Facsimile: 8862-756-2663

#### **Dataquest Singapore**

105 Cecil Street  
#06-01/02 The Octagon  
Singapore 069534  
Phone: 65-227-1213  
Facsimile: 65-227-4607

#### **Dataquest Thailand**

12/F, Vanissa Building  
29 Soi Chidlom  
Ploenchit Road  
Patumwan, Bangkok 10330  
Thailand  
Phone: 662-655-0577  
Facsimile: 662-655-0576

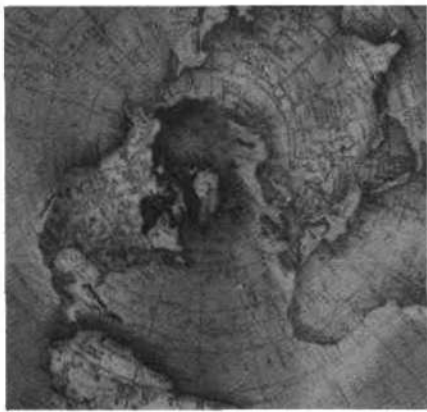
#### **Dataquest Australia**

80 Alfred Street  
Milsons Point NSW 2061  
Australia  
Phone: 61-2-9941-4860  
Facsimile: 61-2-9941-4868

# **Dataquest**

A Gartner Group Company

©1997 Dataquest



**FILE COPY:  
MARIA VALENZUELA**

**Dataquest**

## **Home Theater Is Music to the Ears of a Slowing Audio Market**



**Market Trends**

---

**Program:** Consumer Multimedia Semiconductors and Applications Worldwide  
**Product Code:** MSAM-WW-MT-9702  
**Publication Date:** July 14, 1997  
**Filing:** Market Trends

# Home Theater Is Music to the Ears of a Slowing Audio Market



Market Trends

---

**Program:** Consumer Multimedia Semiconductors and Applications Worldwide  
**Product Code:** MSAM-WW-MT-9702  
**Publication Date:** July 14, 1997  
**Filing:** Market Trends

## Table of Contents

	Page
1. Executive Summary .....	1
2. The Audio Semiconductor Applications Market.....	3
Methodology.....	3
Market Outlook.....	4
3. Audio Markets .....	7
Audio CD Players .....	7
Personal CD Players .....	9
MiniDisc .....	9
Personal/Portable Stereos, Headsets, and Boom Boxes.....	10
Stereo Rack Systems.....	11
Rack Stereo Receivers.....	12
Cassette Tape Players.....	13
Compact Stereo.....	14
Home Theater .....	14
Stereo/Home Theater Speakers.....	15
Car Audio .....	16
Emerging Audio Markets.....	16
Digital Radio.....	16
DVD Audio.....	16
4. Audio Equipment Manufacturers .....	17
5. Conclusions .....	25

## List of Figures

---

Figure	Page
2-1 Worldwide Audio Equipment Production Revenue Forecast .....	5
2-2 Regional Share of Audio Equipment Production Revenue, 1996 .....	5
3-1 Worldwide CD Audio Player Production Revenue and Unit Shipment Forecast .....	7
3-2 Worldwide Personal/Portable Stereo Production Revenue and Unit Shipment Forecast .....	10

## List of Tables

---

Table	Page
2-1 Worldwide Audio Equipment Production Revenue Forecast .....	4
2-2 North American Equipment Production Revenue Forecast .....	6
3-1 Worldwide CD Audio Player Production Revenue and Unit Shipment Forecast .....	8
3-2 U.S. CD Audio Player Brand Share Leaders, 1995 and 1996 .....	8
3-3 U.S. Personal CD Audio Player Brand Share Leaders, 1995 and 1996 .....	9
3-4 Worldwide Personal/Portable Stereo Production Revenue and Unit Shipment Forecast .....	10
3-5 U.S. Personal Tape Player Brand Share Leaders, 1995 and 1996 .....	11
3-6 U.S. Boom Box Brand Share Leaders, 1995 and 1996 .....	12
3-7 U.S. Stereo Rack System Brand Share Leaders, 1995 and 1996 .....	12
3-8 U.S. Stereo Receiver Brand Share Leaders, 1995 and 1996 .....	13
3-9 U.S. Cassette Tape Player Brand Share Leaders, 1995 and 1996 .....	13
3-10 U.S. Compact Stereo Rack System Brand Share, 1995 and 1996 .....	14
4-1 Audio Equipment Manufacturers Listed by Product (Part 1 of 2) ..	18
4-2 Audio Equipment Manufacturers Listed by Product (Part 2 of 2) ..	18

## Chapter 1

# Executive Summary

---

Audio is the oldest segment of the consumer electronics entertainment market. From the days of the Victrola phonograph, audio equipment has been a fixture in households in countries around the world. However, the audio market is now undergoing one of the most fundamental changes in its history. Digital integrated circuit (IC) technology has and continues to reshape audio equipment, making high-quality sound easier to implement and more affordable for the average consumer. With basic audio functions significantly reduced in cost, manufacturers have been freed to introduce an impressive array of innovative features in their products. The latest audio products include 200 disc CD players, Dolby Digital (AC-3) audio decoders, recordable MiniDisc systems, and Radio Data System (RDS) receivers. Digital technology also is making possible cheaper portable systems that have an ever-growing list of extras, such as personal CD players priced at less than \$40, personal cassette players with LCD displays, and boom boxes with remote controls.

Perhaps even more significant than the new digital wave is the influence of video-oriented products on the audio market. Audio products increasingly are being designed to be used as parts of larger systems involving sound, video, and even data. New audio products are developed with the intent that they should be used in conjunction with video equipment, such as home theater systems, digital satellite, and digital versatile disc (DVD). The upside of this trend for audio equipment makers is that consumers are beginning a wave of upgrades of their equipment as they build complete audio/video systems. On the downside, audio equipment will face increasing competition from video-oriented products, specifically DVD.

Because of saturation, the worldwide audio equipment market is expected to grow slowly over the next few years, with sales rising at a compound annual growth rate (CAGR) of only 3 percent from 1996 to 2001. The Asia/Pacific is the leading region for audio equipment manufacturing and will continue to account for the majority of production through the year 2001. After years of uninterrupted growth, production of audio CD players will begin to decline in 1999 because of the rising popularity of DVD.

While the overall audio market slows, audio equipment manufacturers are finding significant opportunity in home theater equipment. Home theater systems require consumers to make a significant investment in equipment such as surround-sound tuners, subwoofers, and five-piece speaker sets. Other opportunities are appearing in emerging audio markets, such as DVD players and digital radios.

*Project Analysts: Jonathan Cassell and Dale Ford*



## Chapter 2

# The Audio Semiconductor Applications Market

---

## Methodology

The consumer electronics semiconductor application market will be examined in three separate Dataquest documents covering the following topics:

- Home appliance and automation application markets
- Audio applications market
- Video, interactive, and personal electronic application markets

This document provides reference information and analysis about the audio application markets for semiconductors. It brings forth basic information about the opportunity offered by particular systems:

- System market size (in production terms) in factory revenue, units, and average selling price (ASP)
- System, market, and technology trends
- Semiconductor device opportunities, content, and market forecast
- A listing of key OEMs

The information in this report is gathered from both primary and secondary sources. Primary sources include surveys and interviews of industry vendors and customers, as well as analyst knowledge and opinion. Some of the primary sources include Dataquest's own industry services. Secondary sources include various government and trade sources on sales, production, trade, and public spending. Semiconductor content assumptions are based both on surveys of producing OEMs and physical teardown evaluations of representative systems by Dataquest analysts.

The brand share information presented in this book comes from *The Scout Report*® of The Polk Company. *The Scout Report*® has been designed to accurately measure the retail purchase activity of U.S. households. Based on a widely accepted survey methodology, the sample is drawn quarterly from a nationally representative group of 50,000 respondents, and response rates average 70 percent. Brand shares reported in *The Scout Report*® are point estimates of the actual brand shares and have a small margin of error. Brand shares are based on a representation of retail sales to end-use consumers in the United States and may not correspond directly to other commonly reported measures of product movement such as production or wholesale shipments.

The forecast methodology is based on various methods and assumptions, depending upon the area. To form a solid basis for projecting system demand, capital, government, and consumer spending assumptions are made for various regions of the world. For specific markets, saturation and displacement dynamics are considered as well. Key exogenous factors such as new software introductions, exchange rate changes, and government policies also are considered. Semiconductor content forecasts are based on interviews of system marketers and designers (including makers of enabling semiconductor technology) along with an analysis of historical trends.

## Market Outlook

Worldwide audio production revenue is expected to grow at a compound annual growth rate (CAGR) of 3 percent from 1996 to 2001, as illustrated in Table 2-1. The slow growth in the coming years results from saturation in the market. Reflecting general weakness in the consumer electronics market worldwide, audio equipment production in 1996 fell to \$22.4 billion, down 9.5 percent from \$24.7 billion in 1995. Though production will recover in 1997—growing 2.9 percent to reach more than \$23 billion—the downturn of 1996 will have a long-lasting effect on growth in the audio equipment market. Production will not recover to its 1995 level until the year 2000.

As shown in Figures 2-1 and 2-2, the Asia/Pacific region dominates and will continue to command production of audio equipment through the year 2001. This region's share of worldwide production will increase from 63 percent in 1996 to 66 percent in 2001. Most audio equipment manufacturing in Asia/Pacific is conducted by manufacturers from other regions who are attracted by the low cost of production in the region. Japan in particular has shifted its production of audio equipment from domestic factories to Asia/Pacific over the past few years. That trend accelerated in 1996, when Japanese audio production fell to less than \$5 billion, down 25 percent from \$6.7 billion in 1995. The drop came as a result of a shift in production to Asia/Pacific combined with the overall decline in the worldwide audio market.

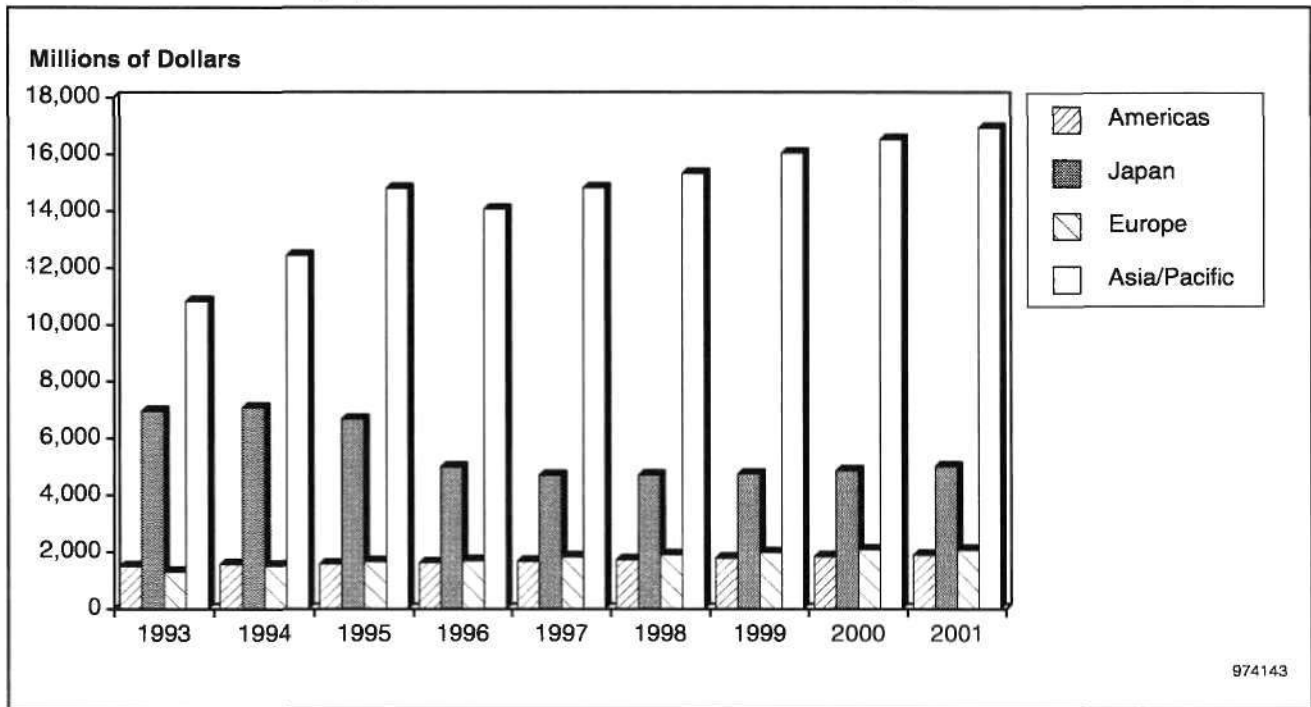
While North America is a minor region for audio equipment production, the rate of manufacturing increase there will be slightly higher than the worldwide average over the next four years. As presented in Table 2-2, the strongest growth in production in North America will be accounted for by personal/portable stereos, while musical instruments and radio production will experience the slowest growth rates.

**Table 2-1**  
**Worldwide Audio Equipment Production Revenue Forecast (Billions of Dollars)**

	1993	1994	1995	1996	1997	1998	1999	2000	2001	CAGR (%) 1996-2001
Revenue	20.588	22.616	24.711	22.367	23.017	23.691	24.564	25.317	25.925	3.00

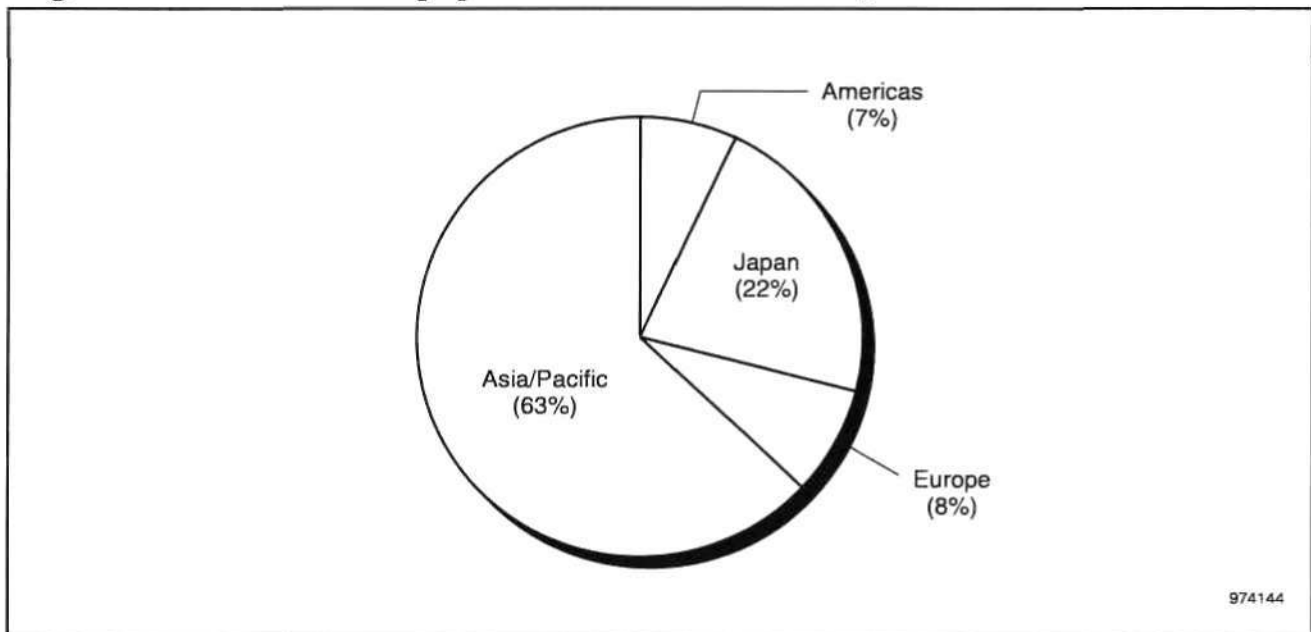
Source: Dataquest (May 1997)

**Figure 2-1**  
**Worldwide Audio Equipment Production Revenue Forecast (Billions of Dollars)**



Source: Dataquest (May 1997)

**Figure 2-2**  
**Regional Share of Audio Equipment Production Revenue, 1996**



Source: Dataquest (May 1997)

**Table 2-2**  
**North American Equipment Production Revenue Forecast (Millions of Dollars)**

	1993	1994	1995	1996	1997	1998	1999	2000	2001	CAGR (%) 1996-2001
Compact Disc Player	55	59	61	64	67	70	73	77	81	4.74
Radio	840	880	850	865	887	912	938	963	990	2.74
Portable/Personal Stereo	87	92	95	102	110	119	127	134	142	6.94
Stereo Component	237	248	256	263	271	280	289	299	309	3.24
Musical Instrument	223	226	230	236	241	248	255	261	266	2.43
Tape Recorder	56	71	84	92	99	102	103	109	112	4.00
Total	1,498	1,575	1,576	1,622	1,675	1,732	1,786	1,842	1,900	3.21

Source: Dataquest (May 1997)

# Chapter 3 Audio Markets

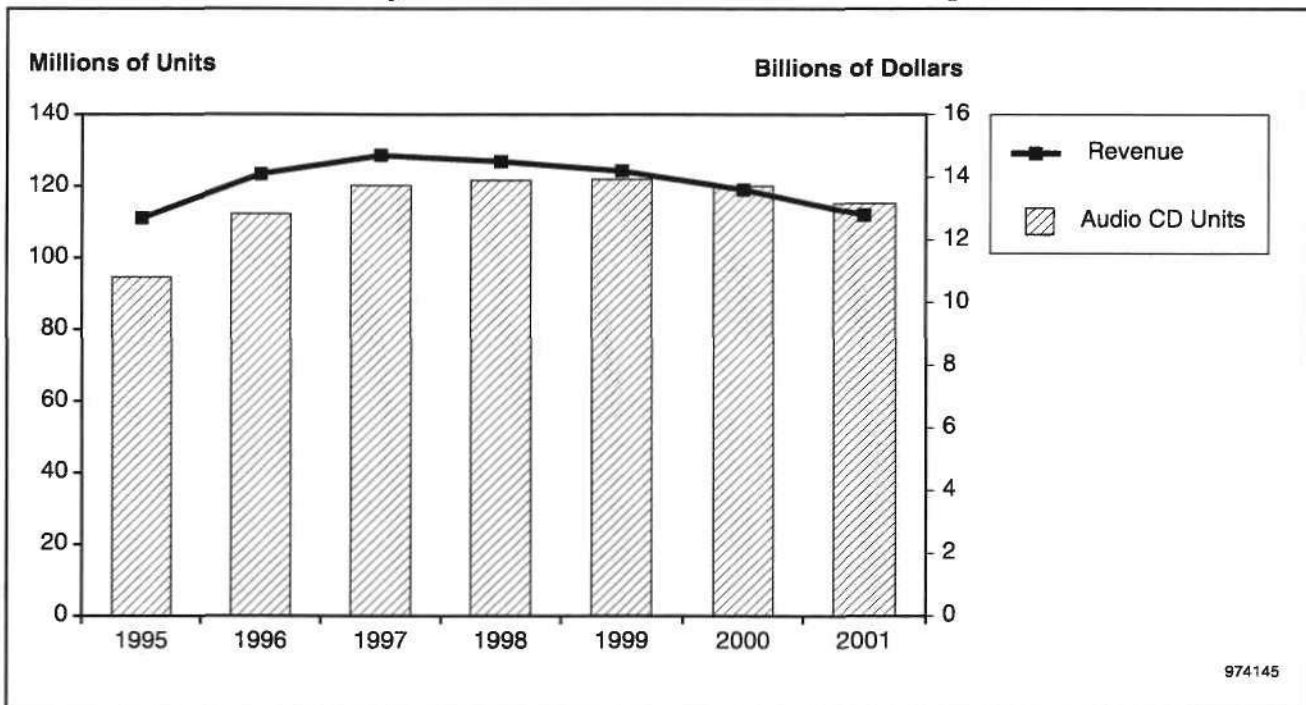
## Audio CD Players

The audio CD player market has reached a state of maturity. In the 14 years since the introduction of the product in 1983, the mechanical and electronic portions of audio CD technology have been perfected. With the technical issues and manufacturing reduced to a fine art, audio CD players for the most part have become a commodity product (excluding high-end component and professional CD players). Prices of personal CD players have dropped to as low as \$39. With prices so low, audio CDs have become pervasive, with players found in the stereos, cars, and personal players of consumers the world over.

Figure 3-1 and Table 3-1 present Dataquest's forecast for audio CD player production revenue and unit shipments. This forecast comprises all types of audio CD players, including rack audio CD players, compact stereo CD audio players, and personal audio CD players.

Audio CD players have enjoyed 14 years of uninterrupted production and sales growth at the expense of record turntables and audio cassette players. However, audio CD players now face their first serious competition: DVD players. Though DVD players are far more expensive than audio CD players and are intended primarily for video playback rather than audio playback, they will encroach upon the territory of the audio CD players over the next few years because of the growth in popularity of home theater systems.

**Figure 3-1**  
**Worldwide CD Audio Player Production Revenue and Unit Shipment Forecast**



Source: Dataquest (May 1997)

**Table 3-1**  
**Worldwide CD Audio Player Production Revenue and Unit Shipment Forecast**

	1995	1996	1997	1998	1999	2000	2001	CAGR (%) 1996-2001
Audio CD Units (M)	94.6	112.2	120.2	121.6	121.9	120.0	115.2	0.65
Factory ASP (\$)	134.29	125.24	122.25	119.32	116.45	113.66	110.93	-2.99
Revenue (\$B)	12.7	14.1	14.7	14.5	14.2	13.6	12.8	-2.36

Source: Dataquest (May 1997)

Consumers increasingly are combining their home stereo and home theater systems together. Manufacturers are feeding this trend by making home theater features standard—even in stereo systems not specifically targeted at the home theater market. With high-quality AC-3 decoding and Dolby Surround support built into DVD players, consumers will use them for both video and audio playback. In the later portions of the forecast period, DVD prices will decline and sales will rise. This trend will cause CD audio player unit production to begin to decline in the year 2000 after peaking at 121.9 million units in 1999. Audio CD production revenue will peak in 1997 at \$14.7 billion. By 2001, audio CD production revenue will have declined to \$12.8 billion.

Table 3-2 displays the U.S. CD audio player brand share leaders in 1995 and 1996.

Much of the growth in the CD audio player market now is accounted for by players that can accommodate multiple discs, which are called multi-disc players or CD changers. Players with the capability to change three to six discs are a common component of rack stereo systems and mini stereo systems. Rack multidisc audio CD players that can accommodate 100 or 200 CDs are generally available in electronics stores. Prices for multidisc players have fallen into a range where they are an attractive alternative to single-disc players for most consumers, with 200 disc players available with manufacturers' suggested prices as low as \$450.

**Table 3-2**  
**U.S. CD Audio Player Brand Share Leaders, 1995 and 1996**

Brand	1995 Unit Market Share%	1996 Unit Market Share%	1995 Revenue Market Share%	1996 Revenue Market Share
Sony	28.4	26.2	28.4	25.6
Pioneer	13.9	10.2	15.3	11.3
JVC	6.8	9.4	6.0	9.5
Technics	7.7	8.3	6.8	8.0
Kenwood	5.3	6.8	4.5	8.0
RCA	5.3	5.3	4.6	3.8
Panasonic	5.2	4.3	4.0	4.0
Magnavox	3.5	3.8	2.3	2.7
Fisher *	1.9	3.1	2.2	3.1
Teac	2.9	2.0	1.7	1.1
Other	19.1	20.6	24.2	22.9

Source: Pathfinder (May 1997)

Multidisc CD players are becoming more refined and easier to use. Features include disc naming, which allows listeners to "label" discs by placing a name for them in the memory of the player that can be displayed on the unit's LCD panel. Other extras include disc exchange, wherein one loaded disc keeps playing while discs are changed.

### Personal CD Players

Apart from multidisc players, growth in the audio CD player market is being spurred by sales of personal CD audio players. Nearly three out of every four audio CD players sold in the United States is of the personal type. As prices have fallen below \$40 for low-end products, personal audio CD players have become affordable for nearly all consumers. High-end personal CD players include features such as LCD displays and multi-playback modes. These products also include built-in shock protection, making them more rugged.

Table 3-3 presents the U.S. personal CD audio player brand share leaders in 1995 and 1996.

### MiniDisc

A variation on CD technology is MiniDisc, a smaller version of CD audio player technology at just 2.5-inches in diameter. MiniDisc is intended to be the portable counterpart of CDs, with built-in shockproofing using a RAM buffer that allows music to continue to play even when the laser has mis-tracked and stopped reading data from the disc. While MiniDisc has been a hit in Japan, so far it has not made much headway in the United States, although after several tries and failures MiniDisc has been reborn in the United States as a recordable format. With its small size, recordable MiniDisc is well-suited for personal audio applications, providing an alternative to personal cassette players. Such products went on sale early this year, with prices for Sony models ranging from \$199 to \$549.

**Table 3-3**  
**U.S. Personal CD Audio Player Brand Share Leaders, 1995 and 1996**

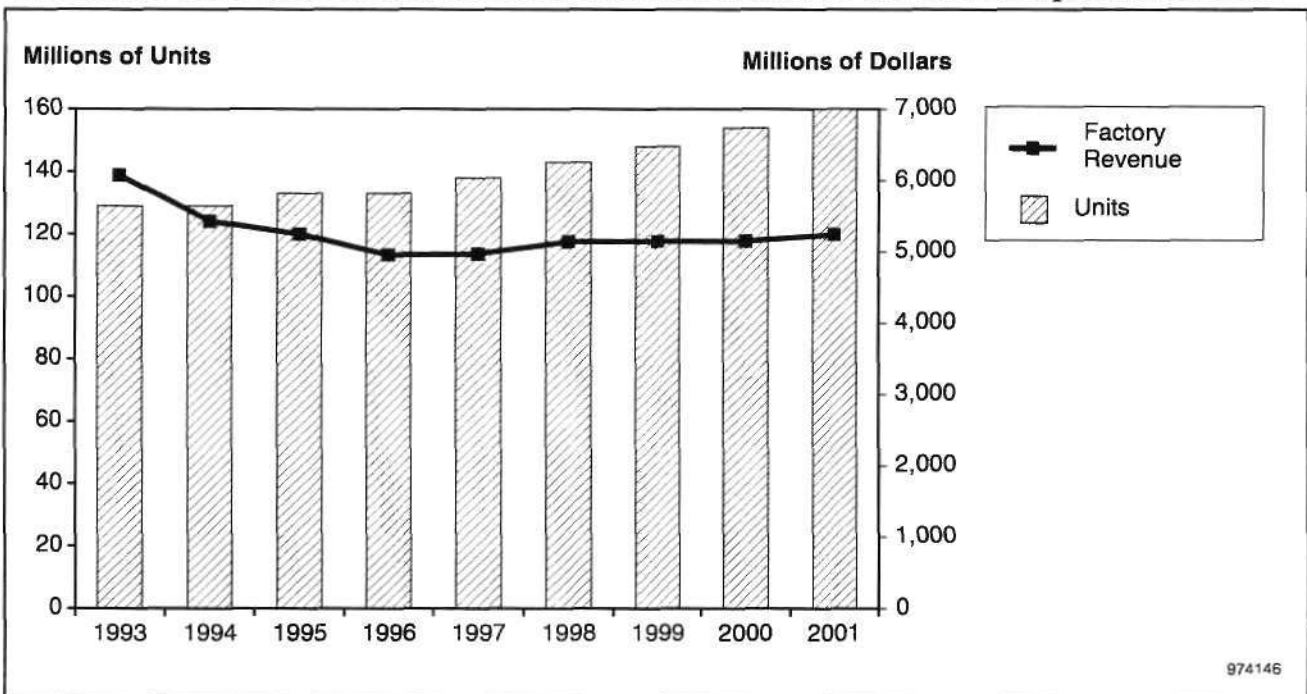
Brand	1995 Unit Market Share%	1996 Unit Market Share%	1995 Revenue Market Share%	1996 Revenue Market Share
Sony	42.8	43.1	41.6	45.4
RCA	12.1	11.2	11.3	9.7
Panasonic	13.9	8.4	14.0	9.1
Magnavox	5.4	7.0	5.1	6.5
Aiwa	2.7	3.8	3.3	4.4
Koss	3.5	3.7	3.1	2.8
Craig	2.1	3.5	1.4	2.3
Kenwood	1.9	2.6	2.1	3.6
Sanyo	2.8	1.9	2.6	1.8
Fisher	3.0	1.7	5.0	2.7
Other	9.8	13.1	10.5	11.7

Source: Pathfinder (May 1997)

## Personal/Portable Stereos, Headsets, and Boom Boxes

The personal/portable stereo market remains one of the real growth opportunities in the audio market on a unit basis. However, on a revenue basis, growth will remain flat, as shown in Figure 3-2. From 1996 through 2001, compound revenue growth will be only 1.13 percent, as presented in Table 3-4. The weak growth in production revenue will be because of falling factory average selling prices (ASPs). The ASP of personal tape players fell to about \$39 in 1996, down about 3 percent from 1995. The strongest portion of the personal/portable stereo market is the personal CD player. The market for personal cassette tape players and boom boxes shows signs of saturation.

**Figure 3-2**  
**Worldwide Personal/Portable Stereo Production Revenue and Unit Shipment Forecast**



Source: Dataquest (May 1997)

**Table 3-4**  
**Worldwide Personal/Portable Stereo Production Revenue and Unit Shipment Forecast**

	1993	1994	1995	1996	1997	1998	1999	2000	2001	CAGR (%) 1996-2001
Units (M)	129	129	133	133	138	143	148	154	160	3.66
Factory ASP (\$)	47	42	40	37	36	36	35	33	33	-2.44
Factory Revenue (\$M)	6,077	5,434	5,251	4,960	4,973	5,143	5,150	5,152	5,246	1.13

Source: Dataquest (May 1997)



Low-end personal tape players that simply play back stereo audio are available at prices as low as the midteens. Higher-priced personal tape players increasingly resemble miniature stereos, with LCD displays, built-in clocks, digital tuners, and Dolby noise reduction. Mid-priced personal cassette tape players use Dolby S noise reduction, which provides the highest level of noise reduction possible for cassette tapes. The very high-end personal cassette players support digital audio tape and come with price tags as high as \$500 to \$900. Table 3-5 shows U.S. personal tape player brand share leaders for 1995 and 1996.

The market for boom boxes has reached a state of saturation. Though it remains a very large market, with more than 10 million units sold in 1996 in the United States, U.S. boom box sales actually declined slightly in 1996, despite the enormous value they provide. Boom boxes, which had a consumer U.S. ASP of \$106.87 in 1996, offer stereo sound quality approaching that of much more expensive compact stereos. New models include remote control, making them an attractive alternative to compact and rack stereo systems in the home.

Table 3-6 presents the U.S. boom box brand share leaders in 1995 and 1996.

## Stereo Rack Systems

Though smaller, cheaper audio products have long been available, rack systems remain the solution of choice for lovers of high-quality sound. While components are available at all kinds of price points, rack stereo tends to be the most expensive way to build a sound system. Thus, sales of complete rack systems are small compared to other audio solutions, such as compact stereos or boom boxes. A complete high-end rack stereo system can consist of a great many components, including a preamplifier, a power amplifier, a tuner, an equalizer, a cassette deck, an audio CD player, a turntable, and as many as five speakers.

Table 3-7 lists the U.S. stereo rack system brand share leaders in 1995 and 1996.

**Table 3-5**  
**U.S. Personal Tape Player Brand Share Leaders, 1995 and 1996**

Brand	1995 Unit Market Share%	1996 Unit Market Share%	1995 Revenue Market Share%	1996 Revenue Market Share
Sony	41.4	40.7	46.0	45.2
GE	9.4	8.1	6.9	5.9
Aiwa	5.6	7.5	7.5	8.5
Panasonic	6.5	5.7	8.5	7.1
GPX	4.9	5.5	4.5	3.3
RCA	3.6	5.3	3.4	4.6
Lennox Sound	2.5	3.6	1.4	2.9
Radio Shack Brands	4.0	2.9	4.5	2.7
Philco	2.0	2.5	1.1	1.4
Sanyo	1.8	1.6	1.4	1.7
Other	18.3	16.6	14.8	16.7

Source: Pathfinder

**Table 3-6**  
**U.S. Boom Box Brand Share Leaders, 1995 and 1996**

Brand	1995 Unit Market Share%	1996 Unit Market Share%	1995 Revenue Market Share%	1996 Revenue Market Share
Sony	31.8	29.7	33.0	30.9
Magnavox	8.4	12.2	8.1	11.7
RCA	8.8	9.6	8.7	9.1
Aiwa	3.3	4.7	4.5	6.4
Sanyo	5.6	4.6	5.1	4.3
Panasonic	4.6	4.3	5.3	5.2
Craig	3.4	3.3	2.4	2.4
Sharp	3.6	3.1	3.8	3.5
Emerson	3.6	3.1	2.8	2.4
GPX	3.3	3.0	2.6	2.2
Other	23.6	22.4	23.7	21.9

Source: Pathfinder

**Table 3-7**  
**U.S. Stereo Rack System Brand Share Leaders, 1995 and 1996**

Brand	1995 Unit Market Share%	1996 Unit Market Share%	1995 Revenue Market Share%	1996 Revenue Market Share
Sony	18.0	18.3	19.9	16.7
Pioneer	9.5	12.6	13.4	18.5
Aiwa	9.4	10.6	8.1	8.6
RCA	4.2	8.5	2.2	4.2
Sharp	6.8	8.2	5.1	6.2
Fisher	6.8	7.4	9.2	13.4
JVC	3.8	4.3	5.5	5.6
Kenwood	6.7	3.2	9.6	3.7
Technics	5.0	2.9	8.3	4.8
Soundesign	5.4	2.8	3.8	1.5
Other	24.4	21.2	14.9	16.8

Source: Pathfinder

### Rack Stereo Receivers

The receiver—a device that combines the stereo preamplifier, power amplifier, and tuner into a single unit—is the heart of most rack stereo systems. Sound mavens claim stereo receivers built using discrete devices offer better quality audio than systems based on integrated circuits. Many high-end systems employ designs based on discrete components, and thus they are sold as separate preamplifiers, amplifiers, and tuners. However, more affordable systems, which offer adequate audio quality for most consumers, exploit the integration brought by ICs to combine the preamplifier, power amplifier, and tuner into a single unit. Quality receivers from brand names like Sony can be purchased for as little as \$170. Stereo receivers increasingly incorporate home-theater type Dolby Pro Logic and Dolby AC-3 decoding functions, even those that are not targeted directly at the home theater market.

Table 3-8 presents the stereo receiver brand share leaders in 1995 and 1996.

## Cassette Tape Players

New high-end cassette tape players are employing Dolby's latest noise reduction technology, Dolby S. Developed using professional spectral recording techniques, Dolby S offers sound quality similar to that of audio CD players. A single cassette player with Dolby S is available from major brand names for around \$250, compared to the \$166.77 U.S. consumer ASP for cassette players.

Table 3-9 displays the U.S. cassette tape player brand share leaders in 1995 and 1996.

**Table 3-8**  
**U.S. Stereo Receiver Brand Share Leaders, 1995 and 1996**

Brand	1995 Unit Market Share%	1996 Unit Market Share%	1995 Revenue Market Share%	1996 Revenue Market Share
Sony	27.2	17.4	27.3	16.2
Pioneer	17.0	15.4	17.6	13.4
JVC	8.7	10.7	7.2	8.8
Kenwood	8.5	10.3	7.6	11.0
Technics	9.7	7.4	9.1	6.6
Onkyo	4.4	6.4	6.9	7.1
Harman-Kardon	1.3	5.1	1.8	9.2
Yamaha	3.0	4.8	4.4	7.0
RCA	1.5	3.7	1.6	3.9
Radio Shack Brands	2.4	3.5	1.4	2.5
Other	16.3	15.3	15.1	14.3

Source: Dataquest (May 1997)

**Table 3-9**  
**U.S. Cassette Tape Player Brand Share Leaders, 1995 and 1996**

Brand	1995 Unit Market Share%	1996 Unit Market Share%	1995 Revenue Market Share%	1996 Revenue Market Share
Sony	22.3	23.6	27.2	23.6
JVC	9.0	15.3	9.3	15.5
Pioneer	14.1	12.1	13.7	14.0
Radio Shack Brands	5.0	6.9	3.8	5.0
Kenwood	6.0	4.5	6.6	4.5
GPX	2.4	3.7	1.8	2.0
GE	4.9	3.5	NA	2.0
Fisher	3.3	3.4	2.1	2.8
Teac	4.5	2.0	2.8	1.5
Technics	5.4	1.6	5.8	1.6
Other	23.1	23.4	26.9	27.5

Source: Pathfinder

## Compact Stereo

Just as digital IC technology has allowed the development of cheaper, and more compact stereo components, it has spurred the creation of high-quality compact stereo systems. Consumers are attracted to compact stereo systems (sometimes called mini stereo systems) by their small size and their low price. The U.S. ASP for a compact stereo system was less than \$246.97 in 1996. Like their full-size counterparts, compact stereos are appearing with a range of advanced features, including multidisc CD players, dual cassette decks with Dolby noise reduction and remote control.

Table 3-10 provides U.S. compact stereo rack system brand share leaders in 1995 and 1996.

## Home Theater

Home theater now is emerging as the primary driver of sales in the worldwide audio market. The effect of home theater is particularly pronounced in the United States, where factory sales of home theater audio products jumped 21 percent in 1996 to reach \$945 million, according to the Consumer Electronics Manufacturing Association (CEMA).

Consumers are buying pieces of audio equipment with an eye toward using them as part of a larger home theater system. Thus, as mentioned above, more and more stereo receivers are incorporating home-theater-oriented sound technologies. To build a home theater system, consumers must make a major investment in new or additional equipment. Required pieces of equipment include a receiver with Dolby Pro Logic or Dolby AC-3 decoding and at least four or as many as five speakers (plus a sub-woofer) that are tailored to home theater sound requirements.

**Table 3-10**  
**U.S. Compact Stereo Rack System Brand Share Leaders, 1995 and 1996**

Brand	1995 Unit Market Share%	1996 Unit Market Share%	1995 Revenue Market Share%	1996 Revenue Market Share
Aiwa	13.7	20.6	22.0	28.8
Sony	16.4	14.7	18.6	15.9
RCA	9.2	9.4	6.3	6.3
Sharp	7.5	9.2	6.3	7.4
Magnavox	8.3	5.4	7.1	4.5
JVC	3.1	4.2	4.3	5.2
Emerson	2.5	3.6	1.3	1.7
GPX	3.9	3.6	1.7	1.9
Soundesign	6.1	1.4	3.6	1.0
GE	4.2	0.5	2.1	0.3
Other	25.1	27.4	26.7	27.0

Source: Pathfinder (May 1997)

Dolby Pro Logic is an analog surround-sound technology that provides a significant improvement in audio quality compared to conventional stereo sound. With Pro Logic, music and special effects come from four speakers and dialogue from a fifth center channel speaker. Pro Logic offers a single channel of surround sound with limited bandwidth. The newer AC-3 is a digital surround-sound technology that has six separate channels of audio. AC-3 provides two separate full-range surround channels, one for the left, the other for the right, providing better localization of sounds. THX is a technology that offers enhancements to AC-3 for reproducing the audio effects experienced in a real movie theater.

Dolby Pro Logic- and Dolby AC-3-enabled receivers include a digital signal processor (DSP) that creates the sound fields for home theater systems. Pro Logic receivers are available from major manufacturers at prices as low as \$200. AC-3-enabled receivers tend to be more expensive, with price tags from \$400 to \$700 or more for a major brand-name receiver.

Dolby AC-3 is expected to gain popularity for home theater systems over the next few years, in part because the cost of Dolby AC-3 enabled receivers will fall, making them more affordable for more users. A second factor is that home theater equipment that uses the AC-3 audio specification, including DVD players and digital television (DTV) receivers, will become more common.

### **Stereo/Home Theater Speakers**

Like other segments of the audio market, speakers have been affected by consumers' move to home theater systems. For stereo makers, the home theater craze has been a major boon, causing consumers to massively increase the amount of money they spend on their products. In the United States, factory sales of home theater speakers, both separate units and packages, increased 59 percent to \$442 million in 1996, according to CEMA.

At the very least, a consumer's upgrade from a stereo to a true home theater system requires the purchase of additional speakers to build a five-channel Dolby Surround system or to set up a six-channel Dolby Digital system. At the most, an upgrade would require the purchase of a completely new speaker set, including left, right, and center channels, left and right channel surrounds, and a subwoofer. For the best sound experience, a complete home theater set of speakers is recommended. Many speaker manufacturers are now offering complete home theater speaker sets. Many speaker companies are positioning their products that offer a "dispersed" sound source, rather than a direct "point source" sound as a perfect solution for home theater systems, which may be placed in a variety of positions to achieve proper stereo sound.

Because home theater speakers must be located at various points in a room, placing and concealing wires has become a major concern for consumers. Manufacturers including Altec Lansing are offering wireless speakers to remedy this problem.

## Car Audio

Automobiles represent a huge market for audio products, with U.S. factory sales reaching \$4.3 billion in 1996, according to CEMA. Popular products include in-dash audio CD players and multisc players. Also, speaker systems with subwoofers are popular both in new cars and in the automotive aftermarket.

## Emerging Audio Markets

### Digital Radio

Another aspect of the digitization of audio equipment is the radio data system (RDS). RDS adds a layer of digitally encoded data transferred at a rate of 1200 bps to the main audio channel of an FM signal. RDS data can be used for a number of applications, including sending a station's call letters for display on the face of a radio, making that station easier to find. It also can be used to send data on the station's format, commercial messages, and titles and performers for songs currently playing. As of the beginning of 1997, more than 600 stations in the United States were broadcasting using RDS, according to CEMA. RDS is appearing on more stereo systems, portable radios, and car audio systems, including those from manufacturers Denon Electronics, Pioneer Electronics, and Onkyo. Despite this, RDS is suffering from poor acceptance, mainly because of ignorance on the part of both consumers and broadcasters.

Another digital radio initiative is the WorldSpace satellite radio system. WorldSpace will be launching three satellites that will provide digital broadcast to Africa, the Middle East, Asia, the Mediterranean Basin, Latin America, and the Caribbean. The signals can be picked up by handheld receivers that have a flip-up antenna and an LCD screen. The receivers, which are based on chipsets produced by SGS-Thomson and ITT Intermetall, will be available in mid-1998.

Still another effort to develop digital radio is digital audio radio (DAR). The goals of DAR include CD-quality sound, immunity to interference, reduction of transmission and reception complexity and costs, and additional data capacity. DAR recently concluded testing in San Francisco, but it is unclear when commercial broadcasts will begin.

### DVD Audio

Though DVD players are primarily oriented toward video, they are capable of playing conventional CD audio titles. As such, they are being used by consumers as the center of both their audio and video systems, as mentioned before. Realizing this, many manufacturers who derive much or most of their revenue in the consumer sales from audio equipment sales are making a foray into the DVD market. These manufacturers include Akai, Harmon Kardon, JVC, and Onkyo. Again, DVD's use of the Dolby AC-3 digital surround-sound technology will serve to drive adoption of AC-3 in home theater systems.

## **Chapter 4**

# **Audio Equipment Manufacturers**

---

Tables 4-1 and 4-2 present a list of audio equipment manufacturers and the product areas they participate in.

**Table 4-1**  
**Audio Equipment Manufacturers Listed by Product (Part 1 of 2)**

Company	CD Audio Player	Personal/Portable Stereos, Headsets, and Boom Boxes	Amplifiers (Rack)	Preamplifiers (Rack)	Tuners (Rack)	CD Player (Rack)	Cassette Deck (Rack)	Speakers	Electronic Musical Instruments
ADS Technologies									
Aiwa America	x	x	x		x	x	x	x	
Akai Electric	x	x	x		x	x	x	x	x
Altec Lansing Technologies								x	
Audio Concepts									
Audio Research			x	x		x			
Aura Systems								x	
Bang & Olufsen of America						x	x	x	
Blue Circle Audio			x	x					
BOSE	x					x		x	
Bryston			x	x					
California Audio Labs	x					x			
Carver			x	x	x			x	
Cary Audio Design			x			x			
Counterpoint Electronic Systems			x	x				x	
Craig		x							
Creek Audio Limited			x	x		x			
Daewoo Electronics Corporation of America									
DCM								x	
Definitive Technology								x	
Denon Electronics	x		x		x	x	x	x	
Emerson		x							
Fisher	x	x	x		x	x	x		
Goldmund	x					x		x	
GPX		x					x		



**Table 4-1 (Continued)**  
**Audio Equipment Manufacturers Listed by Product (Part 1 of 2)**

Company	CD Audio Player	Personal/Portable Stereos, Headsets, and Boom Boxes	Amplifiers (Rack)	Preamplifiers (Rack)	Tuners (Rack)	CD Player (Rack)	Cassette Deck (Rack)	Speakers	Electronic Musical Instruments
GE		x					x		
Harman Kardon			x		x	x	x		
Infinity Systems								x	
Jamo Hi-Fi U.S.A.								x	
JBL Consumer Products								x	
JVC Company of America	x	x	x		x	x	x	x	
Kenwood U.S.A.	x	x	x			x	x	x	
Koss		x							
Legacy Audio			x					x	
Lenoxx Sound		x							
Linn Products	x		x	x	x	x		x	
Madrigal Audio Laboratories	x		x	x		x			
Magnavox	x	x	x	x	x	x	x	x	
Marantz America			x	x	x	x	x		
Meridian America	x		x		x			x	
Miller & Kreisel Sound								x	
Mondial Designs	x		x	x		x			
MTX								x	
NAD Electronics U.S.A.	x		x		x	x	x	x	
Naim Audio	x		x	x	x			x	
Nakamichi America	x		x		x	x	x		
New England Audio Resource (N.E.A.R.)								x	
Now Hear This (NHT)								x	
OHM Acoustics								x	
Onkyo U.S.A.	x		x		x	x	x	x	
Panasonic	x	x							

**Table 4-1 (Continued)**  
**Audio Equipment Manufacturers Listed by Product (Part 1 of 2)**

Company	CD Audio Player	Personal/Portable Stereos, Headsets, and Boom Boxes	Amplifiers (Rack)	Preamplifiers (Rack)	Tuners (Rack)	CD Player (Rack)	Cassette Deck (Rack)	Speakers	Electronic Musical Instruments
Parasound Products			x	x		x		x	
Phase Technology								x	
Philips Consumer Electronics	x	x	x		x	x	x	x	
Pioneer Electronics USA	x					x	x		
Platinum Audio								x	
Polk Audio								x	
Rotel of America	x		x	x	x	x	x		
Samsung Electronics America Inc.	x		x	x				x	
Sanyo Fisher USA	x	x	x	x	x	x	x		
Sharp Electronics	x	x			x	x	x	x	
Sonic Frontiers	x		x	x		x			
Sonic Systems									
Sony Electronics	x	x	x	x	x	x	x	x	
Soundesign	x		x		x	x	x		
TEAC America	x		x		x	x	x	x	
Technics	x		x		x	x	x		
Thomson Multimedia (RCA)	x	x				x			
Triad Speakers								x	
Velodyne Acoustics								x	
Wadia Digital						x			
Wilson Audio Specialties								x	
Yamaha Electronics Corporation USA			x	x	x	x		x	x

\* Includes planned introductions

Source: Dataquest (May 1997)

**Table 4-2**  
**Audio Equipment Manufacturers Listed by Product (Part 2 of 2)**

Company	Radio Data System (RDS)	Surround Sound (Pro Logic) AMP/Proc. (Home Theatre) (AMP Tuner) (receiver)	AC-3 (Dolby Digital) Home Theatre Decoder	THX Amplifier	DVD*	Car Audio	Compact Stereo System	Minidisc
ADS Technologies	x							
Aiwa America		x			x		x	
Akai Electric		x			x			
Altec Lansing Technologies								
Audio Concepts								
Audio Research								
Aura Systems						x		
Bang & Olufsen of America	x						x	
Blue Circle Audio								
BOSE		x					x	
Bryston								
California Audio Labs								
Carver		x						
Cary Audio Design								
Counterpoint Electronic Systems		x						
Craig								
Creek Audio Limited								
Daewoo Electronics Corporation of America	x					x		
DCM								
Definitive Technology								
Denon Electronics	x	x	x	x	x	x		x
Emerson							x	
Fisher								
Goldmund								
GPX							x	

**Table 4-2 (Continued)**  
**Audio Equipment Manufacturers Listed by Product (Part 2 of 2)**

Company	Radio Data System (RDS)	Surround Sound (Pro Logic) AMP/Proc. (Home Theatre) (AMP Tuner) (receiver)	AC-3 (Dolby Digital) Home Theatre Decoder	THX Amplifier	DVD*	Car Audio	Compact Stereo System	Minidisc
GE							x	
Harman Kardon		x	x		x			
Infinity Systems								
Jamo Hi-Fi U.S.A.								
JBL Consumer Products								
JVC Company of America		x			x		x	
Kenwood U.S.A.		x		x	x	x		
Koss								
Legacy Audio								
Lenoxx Sound								
Linn Products								
Madrigal Audio Laboratories		x		x				
Magnavox		x					x	
Marantz America	*	x	x	x	x		x	
Meridian America		x	x	x	x	*		
Miller & Kreisel Sound								
Mondial Designs		x	x					
MTX		x		x		*		
NAD Electronics U.S.A.		x						
Naim Audio								
Nakamichi America		x	x			*		
New England Audio Resource (N.E.A.R.)								
Now Hear This (NHT)								
OHM Acoustics								
Onkyo U.S.A.	x	x	x	x	x		x	
Panasonic								

**Table 4-2 (Continued)**  
**Audio Equipment Manufacturers Listed by Product (Part 2 of 2)**

Company	Radio Data System (RDS)	Surround Sound (Pro Logic) AMP/Proc. (Home Theatre) (AMP Tuner) (receiver)	AC-3 (Dolby Digital) Home Theatre Decoder	THX Amplifier	DVD*	Car Audio	Compact Stereo System	Minidisc
Parasound Products								
Phase Technology								
Philips Consumer Electronics		x	x		x		x	x
Pioneer Electronics USA	x		x		x	x		
Platinum Audio								
Polk Audio						x		
Rotel of America		x	x	x				
Samsung Electronics America Inc.					x		x	
Sanyo Fisher USA		x			x		x	
Sharp Electronics		x					x	x
Sonic Frontiers								
Sonic Systems								
Sony Electronics		x			x		x	x
Soundesign							x	
TEAC America		x					x	
Technics								
Thomson Multimedia (RCA)					x		x	
Triad Speakers								
Velodyne Acoustics								
Wadia Digital								
Wilson Audio Specialties								
Yamaha Electronics Corporation USA		x	x		x			

\* Includes planned introductions

Source: Dataquest (May 1997)

## Chapter 5

# Conclusions

---

With the worldwide audio market saturated, sound equipment manufacturers and chip makers will face slow sales growth over the next several years, despite the enormous value and rich features that today's sound products offer through the use of digital IC technology. The biggest opportunity in the audio market over the next few years is in home theater products, including surround-sound speakers and Dolby receivers. While the home theater boom creates some opportunity for audio equipment makers, it also opens the door for increased competition with video-oriented products, specifically DVD players. The emergence of DVD as a major consumer product will eventually cause a decline in production of audio CD players. Other opportunities in the audio market lie in emerging products including digital radio.

---

**For More Information...**

Jonathan Cassell, Industry Analyst ..... (408) 468-8195  
Internet address ..... [jonathan.cassell@dataquest.com](mailto:jonathan.cassell@dataquest.com)  
Nancy Jamison, Principal Analyst ..... (408) 468-8182  
Internet address ..... [nancy.jamison@dataquest.com](mailto:nancy.jamison@dataquest.com)  
Via fax ..... (408) 954-1780

---

The content of this report represents our interpretation and analysis of information generally available to the public or released by responsible individuals in the subject companies, but is not guaranteed as to accuracy or completeness. It does not contain material provided to us in confidence by our clients. Reproduction or disclosure in whole or in part to other parties shall be made upon the written and express consent of Dataquest.

©1997 Dataquest—Reproduction Prohibited

Dataquest is a registered trademark of A.C. Nielsen Company

## **DATAQUEST WORLDWIDE OFFICES**

### **NORTH AMERICA**

#### **Worldwide Headquarters**

251 River Oaks Parkway  
San Jose, California 95134-1913  
United States  
Phone: 1-408-468-8000  
Facsimile: 1-408-954-1780

#### **East Coast Headquarters**

Nine Technology Drive  
P.O. Box 5093  
Westborough, Massachusetts 01581-5093  
United States  
Phone: 1-508-871-5555  
Facsimile: 1-508-871-6262

#### **Dataquest Global Events**

3990 Westerly Place, Suite 100  
Newport Beach, California 92660  
United States  
Phone: 1-714-476-9117  
Facsimile: 1-714-476-9969

#### **Sales Offices:**

Washington, DC (Federal)  
New York, NY (Financial)  
Dallas, TX

### **LATIN AMERICA**

Research Affiliates and Sales Offices:  
Buenos Aires, Argentina  
Sao Paulo, Brazil  
Santiago, Chile  
Mexico City, Mexico

### **EUROPE**

#### **European Headquarters**

Tamesis, The Glanty  
Egham, Surrey TW20 9AW  
United Kingdom  
Phone: +44 1784 431 611  
Facsimile: +44 1784 488 980

#### **Dataquest France**

Immeuble Défense Bergères  
345, avenue Georges Clémenceau  
TSA 40002  
92882 - Nanterre CTC Cedex 9  
France  
Phone: +33 1 41 35 13 00  
Facsimile: +33 1 41 35 13 13

#### **Dataquest Germany**

Kronstadter Strasse 9  
81677 München  
Germany  
Phone: +49 89 93 09 09 0  
Facsimile: +49 89 93 03 27 7

#### **Sales Offices:**

Brussels, Belgium  
Kfar Saba, Israel  
Milan, Italy  
Randburg, South Africa  
Madrid, Spain

### **JAPAN**

#### **Japan Headquarters**

Aobadai Hills 4-7-7  
Aobadai  
Meguro-ku, Tokyo 153  
Japan  
Phone: 81-3-3481-3670  
Facsimile: 81-3-3481-3644

### **ASIA/PACIFIC**

#### **Asia/Pacific Headquarters**

Suite 5904-7, Central Plaza  
18 Harbour Road, Wanchai  
Hong Kong  
Phone: 852-2824-6168  
Facsimile: 852-2824-6138

#### **Dataquest Korea**

Suite 2407, Trade Tower  
159 Samsung-dong, Kangnam-gu  
Seoul 135-729  
Korea  
Phone: 822-551-1331  
Facsimile: 822-551-1330

#### **Dataquest Taiwan**

11F-2, No. 188, Section 5  
Nan King East Road  
Taipei  
Taiwan, R.O.C.  
Phone: 8862-756-0389  
Facsimile: 8862-756-2663

#### **Dataquest Singapore**

105 Cecil Street  
#06-01/02 The Octagon  
Singapore 069534  
Phone: 65-227-1213  
Facsimile: 65-227-4607

#### **Dataquest Thailand**

12/F, Vanissa Building  
29 Soi Chidlom  
Ploenchit Road  
Patumwan, Bangkok 10330  
Thailand  
Phone: 662-655-0577  
Facsimile: 662-655-0576

#### **Research Affiliates and Sales Offices:**

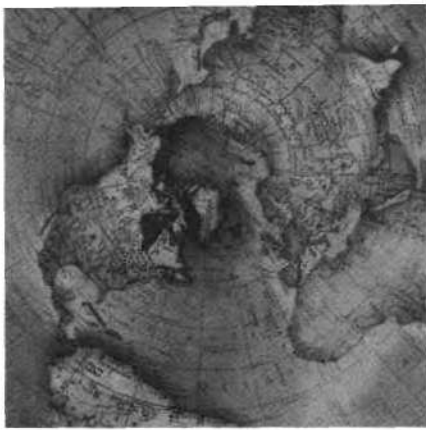
Melbourne, Australia  
Beijing, China

# **Dataquest**

**A Gartner Group Company**

©1997 Dataquest





FILE COPY:  
MARIA VALENZUELA

**Dataquest**

# **Home Appliance and Home Automation Semiconductor Application Markets**



**Market Trends**

---

**Program:** Consumer Multimedia Semiconductors and Applications Worldwide  
**Product Code:** MSAM-WW-MT-9701  
**Publication Date:** April 14, 1997  
**Filing:** Market Trends

# Home Appliance and Home Automation Semiconductor Application Markets



## Market Trends

---

**Program:** Consumer Multimedia Semiconductors and Applications Worldwide  
**Product Code:** MSAM-WW-MT-9701  
**Publication Date:** April 14, 1997  
**Filing:** Market Trends

## Table of Contents

	<b>Page</b>
1. Executive Summary .....	1
2. Introduction.....	3
3. Appliances and Other Consumer Equipment.....	5
Appliance Market Trends.....	5
New Influential Regions in the World .....	8
Brand Share Leaders of U.S. Major Appliances.....	9
Other Consumer Products Markets.....	12
Alarm Systems .....	12
Technology Trends and Semiconductor Opportunities.....	14
4. Home Automation.....	19
Driving Forces.....	19
Show Stoppers .....	20
The Solution: Open Systems .....	21
Current Home Network Technologies .....	22
Semiconductor Trends .....	23

## List of Figures

Figure	Page
1-1 Worldwide Consumer Electronics Production Revenue, 1996 and 2001 .....	2
1-2 Worldwide Semiconductor Consumption in Consumer Products by Category, 1994 through 2000.....	2
3-1 Appliance Saturation Levels in the United States, Japan, and Europe, 1996 .....	6
3-2 Regional Share of Appliance Production Revenue.....	9

## List of Tables

Table	Page
3-1 Worldwide Appliance Production Revenue Forecast, 1994-2001 ....	7
3-2 Americas Appliance Production Revenue Forecast by Type of Product, 1994-2001 .....	7
3-3 Americas Appliance Market Forecast by Type of Product, 1994-2001 .....	7
3-4 U.S. Microwave Oven Brand Share Leaders, First Quarter 1996 through Fourth Quarter 1996 .....	9
3-5 U.S. Refrigerator Brand Share Leaders, First Quarter 1996 through Fourth Quarter 1996 .....	10
3-6 U.S. Dishwasher Brand Share Leaders, First Quarter 1996 through Fourth Quarter 1996 .....	10
3-7 U.S. Clothes Washer Brand Share Leaders, First Quarter 1996 through Fourth Quarter 1996 .....	11
3-8 U.S. Clothes Dryer Brand Share Leaders, First Quarter 1996 through Fourth Quarter 1996 .....	11
3-9 Worldwide Other Consumer Products Production Revenue Forecast, 1993-2000 .....	13
3-10 Americas Other Consumer Products Production Revenue Forecast by Type of Product, 1994-2001 .....	13
3-11 Worldwide Total Semiconductor Consumption Forecast for Appliances and Other Consumer Products, 1993-2000.....	14
3-12 Americas Total Semiconductor Consumption Forecast or Appliances and Other Consumer Products, 1993-2000 .....	14

## Chapter 1

# Executive Summary

---

Home appliances and other consumer products represented 35 percent and 9 percent, respectively, of 1996 total consumer electronic equipment worldwide revenue (see Figure 1-1). In terms of semiconductor consumption, appliances and other consumer products combined accounted for 21 percent of the 1996 total worldwide consumer semiconductor market. Figure 1-2 shows worldwide semiconductor consumption in consumer products by category.

This relatively untapped market is destined for increased utilization of semiconductor devices, especially with the advent of home automation, which fosters the need for more intelligent appliances and more intelligent homes. But the home market remains resistant to new technologies for two main reasons:

- Pricing remains a paramount consideration for most consumers.
- OEMs are still (for the most part) unfamiliar with semiconductors and the value they add to home appliances.

While TV, video, and audio system manufacturers have embraced semiconductor technologies, home appliance (white goods) OEMs have yet to make themselves knowledgeable about the technologies and about what to look for in electronic component suppliers. From ambient climate control to kitchen appliances to security systems and even plant-watering operations, home appliances are expanding the field of semiconductor applications.

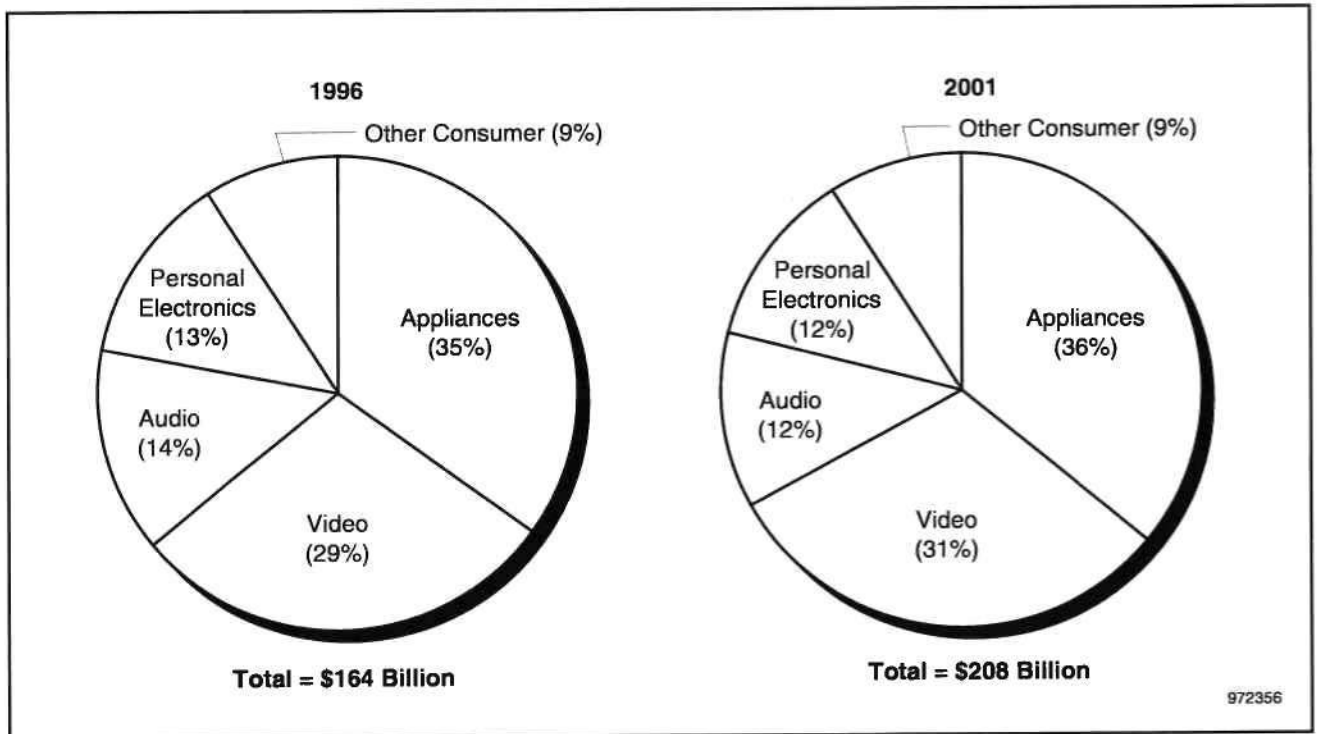
Semiconductors are offering appliance manufacturers unlimited possibilities to add features and value (that is, differentiation) to their products. Although it is still too cost prohibitive today for the majority of the OEMs to migrate toward using electronic controls, three key factors will foster this transition by the end of the century:

- Electronic controls can help OEMs position higher-end lines of appliances that will offset the low margins of current mainstream products.
- Electronic controls enable compliance to global energy efficiency regulations.
- Electronic controls bring forth solutions to meet increasing consumer demand for safety and convenience.

Major home appliance OEMs that are aggressively exploring the use of electronic controls include Maytag, KitchenAid, Hoover, Sharp, Emerson, and others.

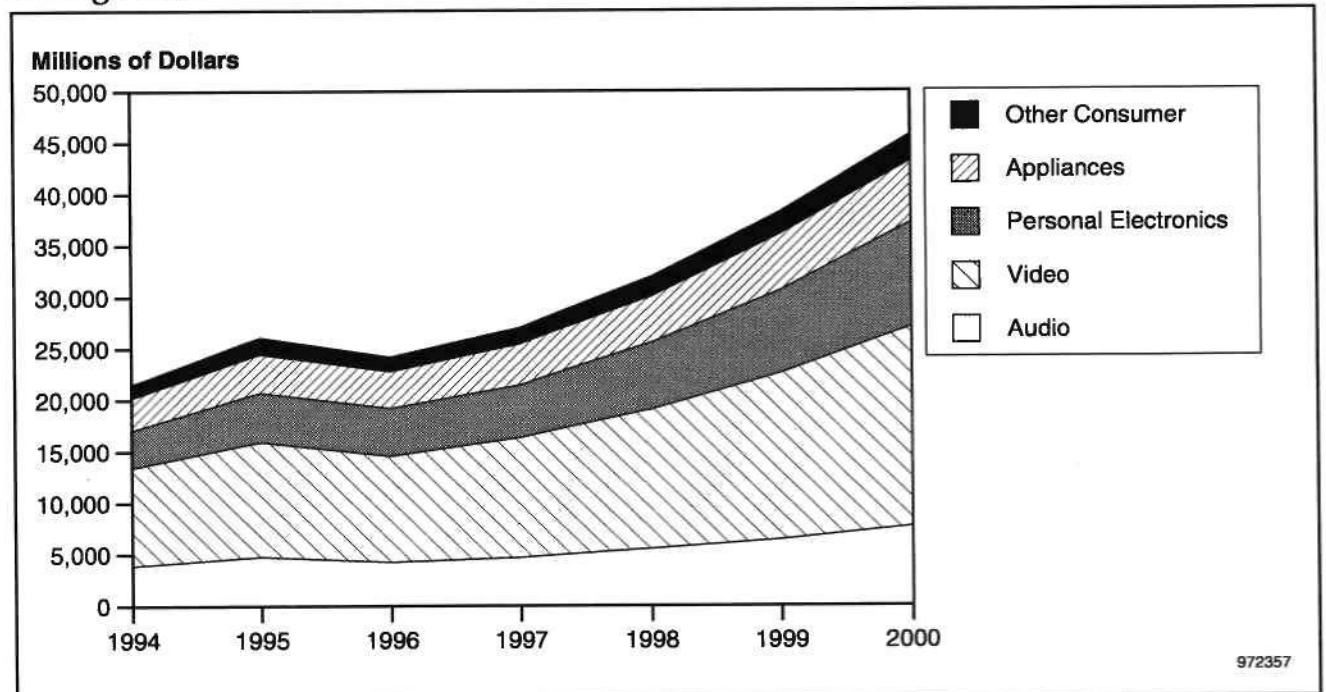
This report highlights opportunities and challenges that await semiconductor manufacturers in the next five years.

**Figure 1-1**  
**Worldwide Consumer Electronics Production Revenue, 1996 and 2001**



Source: Dataquest (March 1997)

**Figure 1-2**  
**Worldwide Semiconductor Consumption in Consumer Products by Category, 1994 through 2000**



Source: Dataquest (March 1997)

## Chapter 2 Introduction

---

The consumer electronics semiconductor application market will be examined in three separate Dataquest documents covering the following topics:

- Home appliance and automation application markets
- Audio applications market
- Video, interactive, and personal electronic application markets

This document provides reference information and analysis about the home appliance application markets for semiconductors. It brings forth basic information about the opportunity offered by particular systems:

- System market size (in production terms) in factory revenue, units, and average selling price (ASP)
- System, market, and technology trends
- Semiconductor device opportunities, content, and market forecast
- A listing of key OEMs

The information in this report is gathered from both primary and secondary sources. Primary sources include surveys and interviews of industry vendors and customers, as well as analyst knowledge and opinion. Some of the primary sources include Dataquest's own industry services. Secondary sources include various government and trade sources on sales, production, trade, and public spending. Semiconductor content assumptions are based both on surveys of producing OEMs and physical teardown evaluations of representative systems by Dataquest analysts.

The brand share information presented in this book comes from The Scout Report® of The Polk Company. The Scout Report® has been designed to accurately measure the retail purchase activity of U.S. households. Based on a widely accepted survey methodology, the sample is drawn quarterly from a nationally representative group of 50,000 respondents, and response rates average 70 percent. Brand shares reported in The Scout Report® are point estimates of the actual brand shares and have a small margin of error. Brand shares are based on a representation of retail sales to end-use consumers in the United States and may not correspond directly to other commonly reported measures of product movement such as production or wholesale shipments.

The forecast methodology is based on various methods and assumptions, depending upon the area. To form a solid basis for projecting system demand, capital, government, and consumer spending assumptions are made for various regions of the world. For specific markets, saturation and displacement dynamics are considered as well. Key exogenous factors such as new software introductions, exchange rate changes, and government policies also are considered. Semiconductor content forecasts are based on interviews of system marketers and designers (including makers of enabling semiconductor technology) along with an analysis of historical trends.

Project Analysts: Dale Ford and Xavier Pucel



## Chapter 3

# Appliances and Other Consumer Equipment

---

## Appliance Market Trends

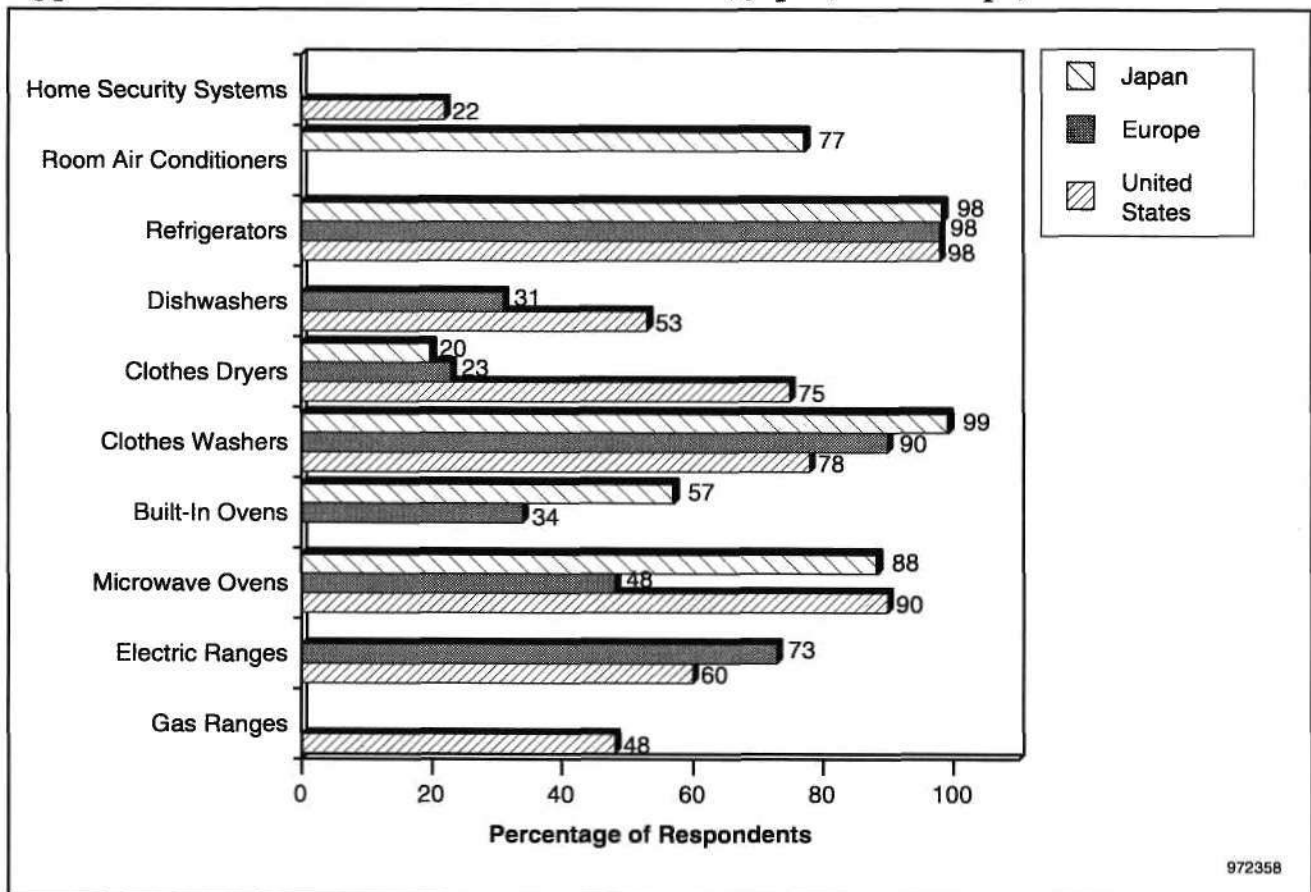
Tables 3-1 and 3-2 present the worldwide and Americas production revenue forecast for appliances. Americas unit production of major home appliances grew 2.6 percent in 1996. The forecast calls for a compound annual growth rate (CAGR) for 1996 through 2001 of 1.8 percent (see Table 3-3).

Highlights in the markets for appliances and other consumer equipment are as follows:

- Generally, appliances are following replacement market economics in the developed countries. Figure 3-1 shows the saturation levels for various appliances in the United States, Japan, and Europe, that is, a base of customers ready to step up to the higher-end products.
- Because of prohibitive transportation costs, most appliances are produced in the end-use market.
- In the United States, consumer spending is expected to remain strong this year because of continued high levels of consumer confidence resulting from growing incomes, low unemployment, and low inflation. One area of concern is the high level of consumer debt, but this should have a limited impact on appliances. Attitudes toward buying large home appliances remain at quite favorable levels.
- Recent consumer surveys indicated that home automation was on top of the wish list. LAN technology will enable all computerized appliances to be linked together, but lack of standardization in this area may temper consumer acceptance (see Chapter 4, "Home Automation").
- The "green" movement is forcing more appliance power conservation with solid-state controls as a way of accomplishing design objectives. The upcoming U.S. Department of Energy (DOE) standards for energy efficiency, potentially slated for 1999, may spur the use of electronic sensors in many appliance applications. The DOE has had a voluntary Climate Change Action Plan since 1993 that mostly focuses on the use of cleaner fuels by electric utilities but that had some emphasis on appliance energy efficiency.
- In Japan, nine items, including air conditioners, have had to meet energy-saving goals for many years. In July 1996, Japan's Ministry of International Trade and Industry (MITI) added refrigerators to the list and set energy-saving goals for them.
- The appliance industry is impacted by the housing industry. In the United States, although new houses increased in 1996 over 1995, industry forecasts indicate a slight decline in 1997 and 1998. The good news, though, is that over 40 percent of the new houses will be built in the south, which should fuel the demand for comfort cooling appliances such as air conditioners.
- Also, while housing starts should decline, remodeling activity is expected to rise. For appliance OEMs, this typically entails higher-end, higher-margin appliances and promises to offset the decline in housing starts.

- There is a growing trend toward outsourcing the electronic control functions in appliances to independent suppliers. Major electronic control suppliers include:
  - Siebe Appliance Control Group (includes companies such as Paragon, Robertshaw, Ranco, and Eliwell)
  - E.G.O. Elektro-Gerateau GmbH
  - Copreci
  - B.T.M. Corporation
  - Eaton
  - Emerson Electric Corporation
  - Johnson Controls Inc.
  - A.W. Weiss
  - Crouzet
  - Procond
  - Remco

**Figure 3-1**  
**Appliance Saturation Levels in the United States, Japan, and Europe, 1996**



Note: Information not available for all regions in some segments.  
 Source: Appliance Magazine, Dataquest (March 1997)

**Table 3-1**  
**Worldwide Appliance Production Revenue Forecast, 1994-2001 (Millions of Dollars)**

	1994	1995	1996	1997	1998	1999	2000	2001	CAGR (%) 1996-2001
Americas	16,211	16,759	17,470	17,568	18,260	18,931	19,674	20,370	3.1
Europe, Middle East, and Africa	12,492	12,782	13,089	13,342	13,787	14,189	14,608	15,236	3.1
Japan	15,863	18,670	16,156	16,117	16,463	17,350	18,307	19,387	3.7
Asia/Pacific	8,879	10,264	11,499	12,663	14,083	15,627	17,235	19,117	10.7
Total Appliances	53,445	58,475	58,214	59,690	62,592	66,097	69,824	74,111	11.4

Source: Dataquest (March 1997)

**Table 3-2**  
**Americas Appliance Production Revenue Forecast by Type of Product, 1994-2001 (Millions of Dollars)**

Segment	1994	1995	1996	1997	1998	1999	2000	2001	CAGR (%) 1996-2001
Range and Oven (Gas and Electric)	1,518	1,515	1,507	1,546	1,616	1,692	1,781	1,847	4.2
Microwave Oven	635	664	695	732	767	802	838	870	4.6
Clothes Washer and Dryer	4,005	4,062	4,143	4,269	4,431	4,588	4,785	4,957	3.7
Dishwasher	1,404	1,433	1,508	1,553	1,598	1,656	1,730	1,800	3.6
Refrigerator	5,729	5,960	6,214	6,342	6,515	6,712	6,936	7,172	2.9
Room Air Conditioner	2,920	3,126	3,403	3,127	3,332	3,481	3,603	3,725	1.8
Total	16,211	16,759	17,470	17,568	18,260	18,931	19,674	20,370	3.1

Source: Dataquest (March 1997)

**Table 3-3**  
**Americas Appliance Market Forecast by Type of Product, 1994-2001 (Thousands of Units)**

Segment	1994	1995	1996	1997	1998	1999	2000	2001	CAGR (%) 1996-2001
Range and Oven (Gas and Electric)	10,996	10,958	10,801	10,965	11,301	11,682	12,166	12,422	2.8
Microwave Oven	12,490	12,866	13,179	13,577	13,884	14,151	14,424	14,706	2.2
Clothes Washer	9,990	10,006	9,972	10,102	10,270	10,396	10,668	10,826	1.7
Clothes Dryer	7,376	7,438	7,648	7,806	7,984	8,181	8,395	8,565	2.3
Dishwasher	6,329	6,374	6,649	6,751	6,807	6,920	7,094	7,231	1.7
Refrigerator	15,098	15,517	16,013	16,130	16,313	16,570	16,887	17,157	1.4
Freezer	2,370	2,395	2,437	2,493	2,570	2,639	2,712	2,779	2.7
Air Conditioner	10,888	11,387	12,235	11,063	11,615	11,957	12,202	12,403	0.3
Total	75,537	76,942	78,932	78,885	80,744	82,496	84,548	86,091	1.8

Source: Dataquest (March 1997)

## New Influential Regions in the World

It is important to keep an eye on several developing regions around the world as household disposable income rises, creating a new generation of consumers. About two-thirds of the world's population uses relatively few consumer electronic items, and a huge market awaits patient consumer electronics and appliance companies (and their suppliers).

Expect basic goods such as refrigerators, cookware (rice cookers, among others), personal/portable stereos, and color TVs to be in demand first. Markets such as China, India, Indonesia, Malaysia, Brazil, and Mexico are indicating huge potential. In most cases, these markets are best served by joint ventures with local companies. Examples illustrating this trend include:

- Electrolux/Refripar has been authorized to build a refrigerator/freezer factory in Brazil.
- Siebe gained approval for the establishment of a wholly owned subsidiary in India. Plans include a plant for manufacturing refrigeration and air-conditioning controls for Indian and global appliance OEMs that are moving to India.
- Toshiba currently produces air conditioners and refrigerators in a plant in Thailand. Production of washing machines was added, with 580,000 units annual capacity expected in 1997.

Central and South American countries absorbed over 15 million home appliances in 1994. Expected to grow at a rate of 5 percent per year over the next several years, this market could reach over 20 million units by 2000. Brazil alone represents a 50 percent share of the total South America market.

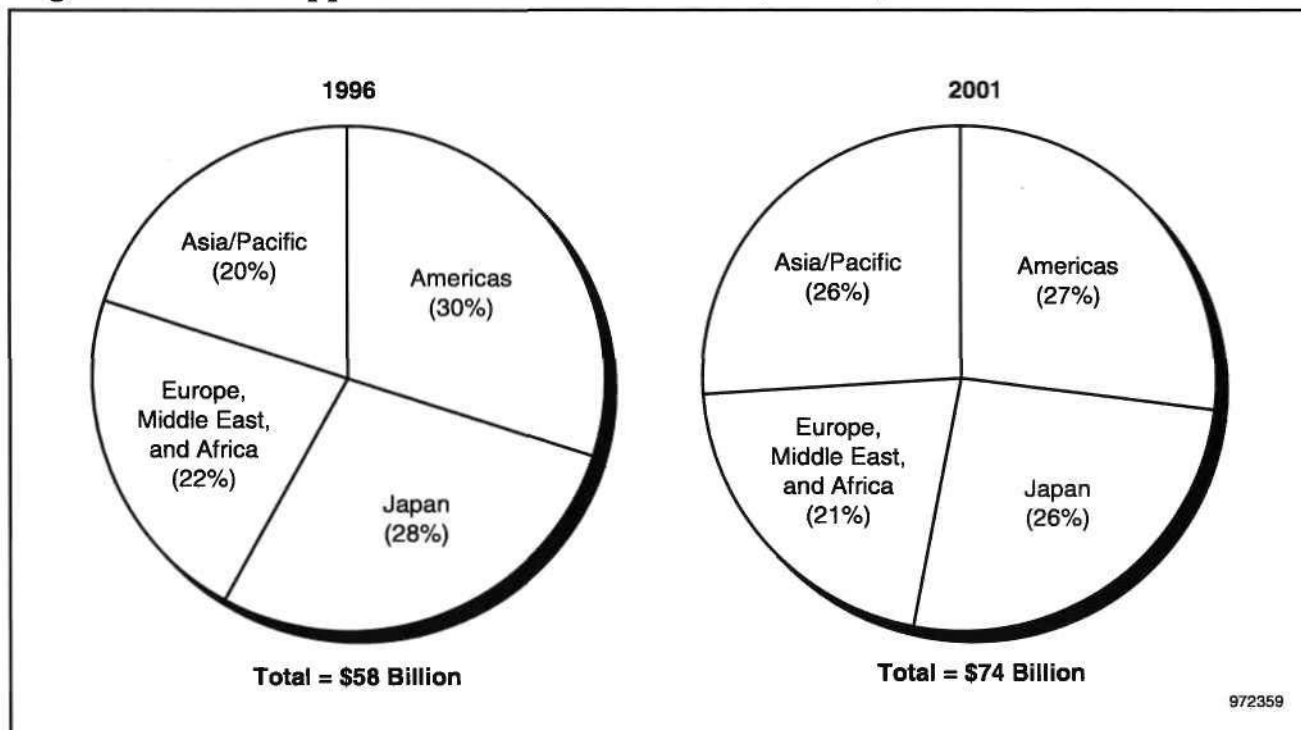
The Chinese consumer electronics market also evidences impending growth. Home appliances such as ovens, microwaves, washing machines, refrigerators, and air conditioners are highly demanded. For instance, 15 million washing machines were sold by the end of 1996, compared to 12.5 million units sold in 1995. Fully automatic machines account for over a third of the market. These are very popular among the urban population, while rural families prefer semiautomatic units. This market is expected to grow at a rate of 13 to 18 percent over the rest of the decade. In 1996, China's imports of household appliances fell sharply because of increased production at home.

In South Korea, appliance makers are increasingly moving their production of refrigerators to Vietnam. South Korean companies do not specialize in high-end products such as large clothes washers and dryers, which are targeted by American OEMs in particular.

India's clothes washer market is estimated at 600,000 units a year, with semiautomatic models accounting for 60 percent of that volume. The mix is expected to shift toward fully automated models as foreign brands join domestic brands. India's refrigerator market, with much of the technology being derived from Japan, is experiencing a 35 percent annual growth rate in the frost-free segment. Now only 15 percent of the total market, it should reach 60 percent of the market by 2005.

Figure 3-2 shows the regional share of appliance production revenue.

**Figure 3-2**  
**Regional Share of Appliance Production Revenue (Percent)**



Source: Dataquest (March 1997)

**Brand Share Leaders of U.S. Major Appliances**

Tables 3-4 to 3-8 provide information on brand share leaders of major home appliances in the United States.

**Table 3-4**  
**U.S. Microwave Oven Brand Share Leaders, First Quarter 1996 through Fourth Quarter 1996 (Percent)**

Brand	Unit Market Share (%)	Revenue Market Share (%)
Sharp	27.9	25.7
GE	14.0	18.9
Panasonic	10.9	9.5
Sears/Kenmore	9.8	10.3
Samsung	5.7	4.3
Magic Chef	4.9	3.4
Emerson	4.6	2.5
Goldstar	4.2	3.2
Whirlpool	4.0	6.0
Tappan	3.5	3.0
Others	10.5	13.2
Total	100.0	100.0

Source: Pathfinder

**Table 3-5**  
**U.S. Refrigerator Brand Share Leaders, First Quarter 1996 through**  
**Fourth Quarter 1996 (Percent)**

Brand	Unit Market Share (%)	Revenue Market Share (%)
Sears/Kenmore	22.5	24.1
GE	18.6	18.8
Whirlpool	12.4	12.7
Amana	11.4	12.1
Frigidaire	6.4	6.7
Hotpoint	5.6	4.4
Maytag	3.6	4.0
Magic Chef	3.0	2.6
KitchenAid	3.0	3.9
Admiral	2.8	2.3
Others	10.7	8.4
Total	100.0	100.0

Source: Pathfinder

**Table 3-6**  
**U.S. Dishwasher Brand Share Leaders, First Quarter 1996 through**  
**Fourth Quarter 1996 (Percent)**

Brand	Unit Market Share (%)	Revenue Market Share (%)
Sears/Kenmore	25.4	24.7
GE	18.8	17.9
Whirlpool	15.7	16.0
Maytag	15.2	16.3
KitchenAid	8.7	11.7
Hotpoint	4.5	3.2
Frigidaire	3.0	2.7
Magic Chef	1.2	0.9
White/Westinghouse	1.0	0.7
Tappan	1.0	0.8
Others	5.5	5.1
Total	100.0	100.0

Source: Pathfinder

**Table 3-7**  
**U.S. Clothes Washer Brand Share Leaders, First Quarter 1996**  
**through Fourth Quarter 1996 (Percent)**

Brand	Unit Market Share (%)	Revenue Market Share (%)
Sears/Kenmore	29.1	29.2
Whirlpool	21.7	20.9
Maytag	14.2	16.5
GE	13.2	12.4
Amana	4.2	4.2
Roper	3.2	2.5
Hotpoint	2.6	2.3
Frigidaire	2.2	2.5
Admiral	1.7	1.7
White/Westinghouse	1.2	1.0
Others	6.7	6.8
Total	100.0	100.0

Source: Pathfinder

**Table 3-8**  
**U.S. Clothes Dryer Brand Share Leaders, First Quarter 1996**  
**through Fourth Quarter 1996 (Percent)**

Brand	Unit Market Share (%)	Revenue Market Share (%)
Sears/Kenmore	28.9	29.4
Whirlpool	19.4	19.4
GE	15.3	14.5
Maytag	13.0	15.0
Amana	3.3	3.3
Hotpoint	3.3	3.0
Roper	2.4	1.9
Frigidaire	2.3	2.2
White/Westinghouse	2.0	1.7
KitchenAid	1.3	1.4
Others	8.8	8.2
Total	100.0	100.0

Source: Pathfinder

Top OEMs in air conditioners are as follows:

- Sears/Kenmore
- Fedders
- Whirlpool
- General Electric
- Carrier
- Amana
- Frigidaire
- White/Westinghouse
- Emerson
- Friedrich

Top OEMs in ranges are as follows:

- General Electric
- Electrolux (Frigidaire)
- Whirlpool
- Electrolux
- Maytag (Magic Chef, Hardwick, Jenn-Air)
- Raytheon (Caloric)
- Brown
- Peerless Premier

## **Other Consumer Products Markets**

### **Alarm Systems**

For security manufacturers, 1996 was a solid year. Retail became an increasing force in the sale of all types of security system, including monitored and custom-installed systems. Although crime rates in the United States appear to have leveled off, media attention to crimes and fires continues to heighten public fears, fostering demand for supplemental security measures.

Growth will be led by carbon monoxide detectors, with demand propelled by new product introductions, regulatory mandates, and the media attention to carbon monoxide-related incidents. In the case of burglar alarms, falling system costs will continue to limit value gains, while simultaneously opening new markets among middle-income homeowners. Although professionally installed systems have dominated the home security market, a new generation of do-it-yourself (DIY) security products has become common. Many of these systems involve radio frequency (RF) or infrared (IR) wireless links to sensors. Most of the sophisticated systems employ PCs or PC motherboards as central control and logging units.

Advances in related technologies (sensor, signal transmission, and computer controls), as well as the development of do-it-yourself distribution channels and the trend toward bundling security features with other home automation technology will also support rising demand.



Continuing solid growth for the entire industry past the year 2000 will depend in part on the commitment of manufacturers and service providers to increase product benefits beyond traditional "burglar alarms."

Top OEMs in home security systems are as follows:

- Honeywell
- Black & Decker
- Sony
- Audiovox
- Yale

Tables 3-9 and 3-10 detail the market for other consumer equipment.

**Table 3-9**  
**Worldwide Other Consumer Products Production Revenue Forecast, 1993-2000**  
**(Millions of Dollars)**

	1994	1995	1996	1997	1998	1999	2000	2001	CAGR (%) 1996-2001
Americas	1,527	1,595	1,663	1,738	1,819	1,904	1,991	2,084	4.6
Europe, Middle East and Africa	NA	NA	NA	NA	NA	NA	NA	NA	-
Japan	9,101	10,332	8,984	8,990	9,205	9,264	9,603	10,037	3.7
Asia/Pacific	2,470	3,016	3,415	3,883	4,322	4,766	5,236	5,847	2.2
Total Other Consumer	13,098	14,944	14,062	14,611	15,346	15,934	16,829	17,967	5.0

NA = Not available

Source: Dataquest (March 1997)

**Table 3-10**  
**Americas Other Consumer Products Production Revenue Forecast by Type of Product,**  
**1994-2001 (Millions of Dollars)**

Segment	1994	1995	1996	1997	1998	1999	2000	2001	CAGR (%) 1996-2001
Automatic Garage Door Opener	409	426	443	461	481	502	523	545	4.2
Alarm System	1,080	1,120	1,149	1,182	1,238	1,297	1,381	1,470	5.0
Others	38	49	71	95	100	105	87	69	-0.5
Total	1,527	1,595	1,663	1,738	1,819	1,904	1,991	2,084	4.6

Source: Dataquest (March 1997)

## Technology Trends and Semiconductor Opportunities

Consumer electronics of all types, in particular white appliances, are destined for increased utilization of semiconductor devices. Table 3-11 shows worldwide semiconductor consumption of appliances and other consumer products, and Table 3-12 shows the same data for the Americas region.

From home ambient climate control to kitchen appliances to security systems and even plant watering operations, home appliances are expanding the field of semiconductor applications. Semiconductors are offering appliance manufacturers unlimited possibilities to add features and value (that is, differentiation) to their products. Evolving appliance technologies make it easier to use appliances such as dishwashers, clothes washers, refrigerators, and microwaves, as well as to control the home environment (air-conditioning and sprinkler systems, among others). Driven by stricter environmental regulations and by consumer demand for convenience, electronic controls are becoming increasingly popular in home appliances. However, appliance OEMs are still uncertain of their return on investment in this arena, and while TV, video, or audio system manufacturers have strongly embraced semiconductor technologies, white goods OEMs have not yet become knowledgeable about the technologies and about what to look for in electronic component suppliers.

**Table 3-11**  
**Worldwide Total Semiconductor Consumption Forecast for Appliances and Other Consumer Products, 1993-2000 (Millions of Dollars)**

Segment	1993	1994	1995	1996	1997	1998	1999	2000	CAGR (%) 1995-2000
Appliances	2,588	3,132	3,750	3,597	3,980	4,472	5,424	5,991	9.8
Other Consumer Products	1,065	1,289	1,607	1,399	1,595	1,879	2,157	2,584	10.0

Source: Dataquest (March 1997)

**Table 3-12**  
**Americas Total Semiconductor Consumption Forecast for Appliances and Other Consumer Products, 1993-2000 (Millions of Dollars)**

Segment	1993	1994	1995	1996	1997	1998	1999	2000	CAGR (%) 1995-2000
Appliances	856	1,008	1,051	946	1,015	1,175	1,330	1,437	6.5
Other Consumer Products	188	248	385	366	428	538	691	874	17.8

Source: Dataquest (March 1997)

To enable market expansion, semiconductor makers may want to take it upon themselves to educate appliance OEMs about the roles and potential of semiconductors, where to locate them in the appliance to avoid malfunctions, and also how and when to specify components. For planning purposes, appliance OEMs have to be aware that manufacturing semiconductors takes longer than producing a sheet of metal.

What future appliances will deliver, and what role semiconductors will play, will depend on costs and the globalization of the market.

Because home appliances are produced in the hundreds of thousands or even millions, cost is critical. The smallest reduction of an item's manufacturing cost can save the OEM large amounts of money. Consequently, any design strategy that can address the following central needs deserves consideration:

- Increased functionality
- Low cost
- Convenience
- Reliability
- Highly flexible microprocessor architecture

Although an electronic control is likely to be more costly than an electro-mechanical one, this cost disadvantage can be mitigated by incorporating several functions. An example of this systems approach would be a refrigerator adaptive defrost with added evaporator fan speed control. The fan speed control adds little cost while providing an energy efficiency advantage. Highly flexible microprocessor architecture is a plus because it enables a very short new product development cycle at low cost. The architecture can be quickly and inexpensively altered to design a new control every six months, if needed.

Specific semiconductor trends include:

- There is an increasing trend away from electromechanical sensors toward silicon-based sensors, but their performance must justify their cost. Sensors are used to measure water level, pressure, air humidity, voltage, current, and many other parameters. Because of tighter governmental regulation around the world, electronic sensors are vying to replace their electromechanical counterparts. Demand for the latter will not die for some time because of the cost issue, but use of electronic controls provides appliance OEMs with two major advantages:
  - More accurate measurements and faster corrective action are enabled.
  - A wider range of parameters can be measured. Some parameters just cannot be electromechanically measured. This provides OEMs with the possibility of adding features and value and the opportunity to differentiate their products.

- Major appliances are growing ever more sophisticated. Following the path laid down by consumer electronics, they are acquiring micro-controller (MCU) control (4-bit, mostly) and are already moving toward 8-bit (and above) microcontrollers. Low-cost digital signal processors (DSPs) will be moving down to this market to compete with 8- and 16-bit microcontrollers. In particular, in motor control, DSPs allow the elimination of many sensors by using advanced algorithms.
- Application-specific ICs (ASICs) are used to cut component counts and costs.
- Motor-driven appliances such as refrigerators, washers, and dryers are gradually moving to solid-state controls for direct-drive motors because smarter controllers can make use of cheaper motors, running brushless DC/AC induction and switched-reluctance electric motors. A complete electronic motor control solution must allow the appliance OEMs to cut cost and add value simultaneously by:
  - Allowing use of low-cost and high-reliability AC induction motors, in which the only moving part is the squirrel cage rotor. There are no brushes to wear out (as in brush DC motors), and there are no permanent magnets to raise the cost (as in DC brushless motors).
  - Offering the variable speed control of a traditional DC motor
  - Eliminating gears, belts, and hydraulics through the support of variable-speed direct drive
  - Controlling acceleration/deceleration of AC induction motors or switched-reluctance motors for less maintenance, improved life cycle, and quieter operation
  - Providing robust speed and torque control for AC and DC brushless motors
  - Reducing power consumption (and meeting energy-efficiency guidelines)
  - Reducing chip count to a single-chip motor controller
- The use of pulse width modulation (PWM) is usually preferred as a means to control switching of power transistors such as MOS field-effect transistors (MOSFETs) or insulated gate bipolar transistors (IGBTs).
- Semiconductors represent about 60 percent of the total materials cost in a typical variable-speed motor command circuitry. Of that 60 percent, power switching and fast diodes account for 70 percent. Other components include ICs used in control and interfacing (15 percent each). By controlling instantaneously the amount of electrical power transferred to the motor, one can limit the current span and use a cheaper power stage. This is made possible by using a fast-embedded fuzzy logic coprocessor that optimizes the motor flux in real time and ultimately saves about one-third of the power stage.

- Fuzzy logic enables real-time and automatic monitoring of the appliance function. A software tool that mathematically computes the subjectivity of human perception into the strict binary language of computers, fuzzy logic is being integrated in vacuum cleaners, clothes washers and dryers, microwaves, and dishwashers, among others. In ovens, for example, fuzzy logic sensors can determine the doneness of food, as well as what is to be cooked, and check the food's consistency and texture, allowing the oven unit to adjust cooking conditions accordingly. In a washing machine, sensors measure level of soil in water, level of water, temperature, level of foam, detergent levels, arm rotation, and other parameters. The unit collects all the inputs, examines the data against a mathematical model, and decides what to do next. After a long struggle for acceptance, fuzzy logic is proving its advantages in energy savings, efficiency, and ease of design for a growing number of everyday devices. Achieving higher performance in variable-speed motors is a prime application for fuzzy logic. In Europe, the push to get fuzzy logic into consumer goods has been driven by European Community environmental laws (more efficient air conditioning and noise cancellation, for example). Fuzzy logic can be implemented around MCUs or DSPs. It has been demonstrated that fuzzy logic could do things with an 8-bit MCU that conventional methods could not do even with a RISC chip.
- Not only are appliances becoming smarter, but they are also providing better human interface, such as voice activation. After appliances are trained to recognize particular voices, they can execute verbal commands. Microwaves and ovens should be among the first appliances to display such features, but this technology is still in the prototype stage. Products could emerge at the end of 1997. Touch-screen technology is also viewed as something the consumer will truly find useful.

## Chapter 4

# Home Automation

---

In the home, there is a large number of new applications that hold enormous promise, but it is difficult to tell whether vendors can succeed in driving them into the mainstream. One concept, however, appears to be more than a simple promise because of the fact that consumers want it, and that is home automation.

Some refer to home automation as a networking opportunity, while others see opportunities for intelligent appliances. Home automation is really a concept that calls for networked smart appliances that are not only fun to consumers but, most important, add functionality and convenience, help with energy conservation, and have security features. Consumer adoption of home automation is similar to adoption of cellular phones in the sense that if you do not have one, you do not really need one, but when you have tried one, you cannot let it go.

### Driving Forces

Utilities across the United States are actively engaged in trials to determine how utility interface with intelligent networked homes can bring demand-side power management to the consumer. For example, as a result of deregulation, utilities are increasingly focusing on offering customers choice, flexibility, and enhanced satisfaction. To that end, for instance, CellNet Data Systems Inc. and Ameritech signed an agreement last year to develop two-way interactive energy information services linking utilities with their residential and small commercial and industrial customers. Services include ready access to customer usage data, real-time pricing, load control, and real-time outage notification. In December, CellNet announced that more than 100,000 homes and businesses in the St. Louis metropolitan area are equipped to take advantage of CellNet's technology to monitor and manage electrical usage, and the company is on schedule to install an additional 700,000 single-phase and polyphase radio-enabled electric meters for Union Electric by early 1999. CellNet is now providing online, real-time wireless meter reading and information services from more than 500,000 meters throughout the United States. Meters are "online" when they have been installed on the network and are providing meter reading data to the network database. Real-time access and analysis of energy usage information allows companies like UE to operate more efficiently while providing increased service to residential, commercial, and industrial customers throughout their service regions, including remote areas. CellNet is the leading provider of network information services to energy utilities, with over 1.2 million network automated meters under contract. CellNet's wireless data communications system can also be used to monitor the status of vending machines, home security systems, traffic lights, and office machines, among others.

Saving money on utility bills is only the beginning. With heating and cooling systems that have the ability to communicate with lighting, security, and overall home management systems, the intelligent networked home will add a new level of safety and convenience. There is no greater emerging application enabling fundamental changes in the ways consumers

organize, operate, and communicate with electronic products and appliances than the intelligent networked home. With network features, traditional household products such as TVs, VCRs, telephones, security systems, household appliances, and temperature control equipment can share information and work together. They can ask questions of each other and reply or give status reports concerning activity around the house.

In the future, there will be a multitude of computers at home. Some will perform traditional computing tasks, while others will be used mainly for games, communications, controlling other devices in the home, and other such purposes. It is quite likely that all these "computers" will be tied together somehow, perhaps using wireless technology. Converting standalone products to network products is an evolutionary trend that has begun. Numerous consumer electronics manufacturers are already involved in this new frontier, and most will eventually pursue this market. Network products in homes represent the growth market many have been seeking.

Home builders are now offering built-in office space in all house price ranges with cable or fiber-optic prewiring, LANs, and high-speed transmission lines. Plastic fiber optics promises data transmission at speeds nearing those of glass fiber for a fraction of the cost. In the United States, Boston Optical has started selling plastic fiber developed jointly with General Motors, Honeywell, and Boeing. In Japan, Sony, NEC, Toray, and Toshiba have started a similar consortium. High-end systems grew to 135,000 units in 1996, compared to 100,000 units in 1995, and there were about 500 million X-10 devices (one of the earliest protocols, discussed later in this document) sold in 1995 and 625 million in 1996. This growth rate is expected to increase continuously over the next five years.

Anticipating increased use of LANs, bus technology suppliers are developing protocols with the hope of capturing early market leadership. These house LANs create a communications pathway among the home's appliances, heating, ventilation, and air-conditioning systems, computing and cable equipment, and outside agencies such as the power company so that energy use can be optimized and outside communications can be automatic. These developments are also being driven by the increasing number of consumers looking for comfortable ways to work efficiently at home. If such bus technologies become successful, most of the next-generation appliances in the home will have a network adapter chip.

## Show Stoppers

The era of the home hub may be coming, but the market is a chicken-and-egg problem. Vendors like the idea of selling more chips for more appliances, but consumers will not start buying intelligent appliances until they are mainstream (widely available at the right price). Until consumer demand increases, chip availability will be limited and prices will be high.

Also, the consumer's ultimate wish is to have easy-to-use devices and compatible products—suppliers must remember that, to be successful, the technology has to be invisible to the users. Confronted with too many systems, consumers are reluctant to invest in any one system. An industry cluttered with incompatible systems is therefore ripe for fallout. Unlike DVD, which will come on like a lion because of its widely accepted format, Internet appliances and home automation may experience slower consumer acceptance. To be successful and accepted by consumers, the technology has to be far simpler, maintenance free, and nearly invisible to typical users.

## The Solution: Open Systems

In January 1997 at the Consumer Electronics Show (CES), an ad hoc industry group called the Home Plug-and-Play Task Force unveiled a new specification that makes it easier for PCs to control all kinds of household products. The ultimate goal is to promote interoperability among the various home automation and control networks. Although the intrasystem language (that is, the language used between sensors and the controller) could be proprietary, the intersystems communication (that is, the communication between the various controllers) would follow the Common Applications Language (CAL). The task force includes Intel, Honeywell, Microsoft, and Thomson and is working with the CEBus Industry Council to come up with a unified plan later this year.

Another effort is going on in Europe, where officials are working to develop a standard set of home automation software protocols that will allow appliances of all makes to communicate. The European Installation Bus (EIB), which is supposed to merge soon with other home automation products, such as the European Home System of Batibus, could represent that standard set of protocols. Bosch-Siemens is pushing strongly for an open system and will play a large part in the development of the EIB standard. Bosch-Siemens hopes to deliver a home electronic system that will control and monitor all the functions within the house. Through the PC, via a multimedia interface, the user could control motion detectors, window contacts, lights, comfort conditioning systems, and appliances. The software was introduced at the CeBIT Home Electronics Fair in Europe during the summer. The company is also planning to unveil the system, with actual home assistance applications on display, at the 1997 Domotechnica Exhibition.

It is unfortunate that global companies are not cooperating on a global basis in establishing industry standards that would promote a single, international open system. For example, in the semiconductor equipment industry, companies from around the world are cooperating within Semiconductor Equipment and Materials International's framework to develop international standards for sensor and actuator bus interoperability for semiconductor production equipment.

Whatever shape the solution may take, it is likely to be a decentralized system in which the intelligence will really be in the switches. The PC will control everything, but it will not be the central place where the intelligence will reside. It will just be a place in the house where modifications can be made to the control parameters. If the PC is off or breaks down, the



system does not break down because every device has the capability to run on its own. A decentralized system allows the user to gradually upgrade the system module by module, rather than purchasing a very expensive system that may be more elaborate than needed.

## Current Home Network Technologies

Leading bus contenders in the United States include:

- **X-10 protocol**—X-10 is probably still the most mature home automation scheme, licensed to hundreds of vendors, and is only now moving to mainstream. It consists of controllers sending commands to modules installed between the devices to be controlled and an electrical power source. X-10 has 256 possible address codes. In a PC-based home automation system, the PC becomes the only controller. Several companies offer products incorporating this protocol. For example, IBM's newly introduced Home Director Software allows users to turn on and off lights, consumer electronics, appliances, and sprinklers, for example, with no need for special wiring. Although X-10 is very appealing because of the availability of products, and the broad range of pricing, it is a one-way communications link (command) and lacks the intelligence that other technologies such as CEBus and LonWorks offer.
- **CEBus**—Consumer Electronics Bus is an Electronics Industries Association-supported protocol that is enjoying widespread acceptance in the industry. The capabilities planned for CEBus are similar to those X-10 provides, but CEBus offers an additional intelligence level because it is a two-way communications system. This feature allows for alert messages and lets the controller know if a command has been carried out or not. Another advantage is its versatility: it can be used with cable television, air-conditioning, phone wiring, or even RF. Also, CEBus outlines a low-cost keyboard, LCD, or PC interface that consolidates the control of several appliances. Intellon Corporation has a power line radio frequency modem IC using spread spectrum technology capable of 10-Kbps data rates. Intellon recently tested its technology on the Tele-Communications Inc. and Microsoft set-top box platform. AMP Inc.'s OnQ-mand system enables home automation operation via television sets, and Diablo Research proposes an energy monitoring system. Maytag's upcoming Jenn-Air dryer will be one of the first appliances to be equipped with CEBus technology, which will add \$50 to \$75 to its manufacturing cost. Costs are being reduced for implementing this technology in consumer products such as refrigerators, hot water heaters, and air conditioners.
- **LonWorks**—This is a proprietary approach advocated by Echelon Corporation. Echelon network controllers are made by Motorola and Toshiba. Motorola and Toshiba are now quoting prices between \$2 and \$3 for Neuron controller chips, compared to \$15 a few years ago. Fifty thousand homes were scheduled to have LonWorks devices installed in 1995. In terms of features and functionality, LonWorks is comparable to CEBus.
- **Totally Automated Building System**—TABS, from NetMedia, merges PC control, customizable software, and complete systems integration. TABS began shipping early in 1996 and requires at least Category 5 cables.

- **SmartHouse protocol**—Molex offers packages of components using this protocol. The wiring package, for example, provides high-speed Internet access and enables modem, fax, and phone lines, as well as video distribution throughout the home.
- **Serv-Touch**—Offered by P-Serv Technologies Pte., this system allows users to remotely activate up to 48 devices by using the phone. The system is awaiting U.S. Federal Communications Commission (FCC) approval and will be on the market soon.
- **IEEE 1394** is being targeted at the multimedia/entertainment segment and enables the consumer to plug or unplug, without rebooting, devices such as digital VCRs, digital camcorders, audio systems, and digital set-top boxes. Also, proponents say that it can be used for home network applications. NEC, in particular, wrote a case study report of a plastic optical fiber (POF) used as the backbone through which different rooms configured with IEEE 1394-based home networks can be interconnected. IEEE 1394 has attracted industrywide attention, but wide adoption and implementation are still a couple of years away. Although the chipsets (physical and link layers) are coming down in price rapidly, the technology is still viewed as too expensive, especially for home appliances.

## Semiconductor Trends

Key trends in home automation semiconductor applications are as follows:

- **Low-cost MCUs and evolving mixed-signal technology** make home automation applications interesting to industry insiders. The key requirements for low-cost networked control systems are simplicity and scalability, which are attributes of modern 8-bit MCUs. Low-cost, off-the-shelf silicon solutions are needed to make it easier and less costly for PC and consumer electronics OEMs to integrate the control network capability.
- **The main difference between data and control network** is the size of the information transferred. For home automation applications, the RAM buffer normally needed in each 8-bit MCUs is 100 bytes or less.
- **In a control network environment, where the same system has to support several different products and protocols, one-time programmable MCUs** play a key role in keeping costs down by allowing modification with only a change of program code. Flexible manufacturing is important in the consumer retail environment, because trends change quickly. One-time programmability can allow the manufacturer to capture increased market share, respond to changes quickly, and minimize obsolescence as older devices ramp down.
- **Additional difficulties revolve around the user-input interface.** To be successful, home automation applications require extremely simple interfaces and must be flexible enough to be moved around in home appliances.

---

**For More Information...**

Xavier Pucel, Industry Analyst ..... (408) 468-8467  
Internet address ..... [xavier.pucel@dataquest.com](mailto:xavier.pucel@dataquest.com)  
Via fax ..... (408) 954-1780  
Dataquest Interactive ..... <http://www.dataquest.com>

The content of this report represents our interpretation and analysis of information generally available to the public or released by responsible individuals in the subject companies, but is not guaranteed as to accuracy or completeness. It does not contain material provided to us in confidence by our clients. Reproduction or disclosure in whole or in part to other parties shall be made upon the written and express consent of Dataquest.

©1997 Dataquest—Reproduction Prohibited

Dataquest is a registered trademark of A.C. Nielsen Company

**Dataquest**  
A Gartner Group Company

## DATAQUEST WORLDWIDE OFFICES

### NORTH AMERICA

#### Worldwide Headquarters

251 River Oaks Parkway  
San Jose, California 95134-1913  
United States  
Phone: 1-408-468-8000  
Facsimile: 1-408-954-1780

#### East Coast Headquarters

Nine Technology Drive  
P.O. Box 5093  
Westborough, Massachusetts 01581-5093  
United States  
Phone: 1-508-871-5555  
Facsimile: 1-508-871-6262

#### Dataquest Global Events

3990 Westerly Place, Suite 100  
Newport Beach, California 92660  
United States  
Phone: 1-714-476-9117  
Facsimile: 1-714-476-9969

#### Sales Offices:

Washington, DC (Federal)  
New York, NY (Financial)  
Dallas, TX

### LATIN AMERICA

#### Research Affiliates and Sales Offices:

Buenos Aires, Argentina  
Sao Paulo, Brazil  
Santiago, Chile  
Mexico City, Mexico

### EUROPE

#### European Headquarters

Tamesis, The Glanty  
Egham, Surrey TW20 9AW  
United Kingdom  
Phone: +44 1784 431 611  
Facsimile: +44 1784 488 980

#### Dataquest France

Immeuble Défense Bergères  
345, avenue Georges Clémenceau  
TSA 40002  
92882 - Nanterre CTC Cedex 9  
France  
Phone: +33 1 41 35 13 00  
Facsimile: +33 1 41 35 13 13

#### Dataquest Germany

Kronstadter Strasse 9  
81677 München  
Germany  
Phone: +49 89 93 09 09 0  
Facsimile: +49 89 93 03 27 7

#### Sales Offices:

Brussels, Belgium  
Kfar Saba, Israel  
Milan, Italy  
Randburg, South Africa  
Madrid, Spain

### JAPAN

#### Japan Headquarters

Aobadai Hills 4-7-7  
Aobadai  
Meguro-ku, Tokyo 153  
Japan  
Phone: 81-3-3481-3670  
Facsimile: 81-3-3481-3644

### ASIA/PACIFIC

#### Asia/Pacific Headquarters

Suite 5904-7, Central Plaza  
18 Harbour Road, Wanchai  
Hong Kong  
Phone: 852-2824-6168  
Facsimile: 852-2824-6138

#### Dataquest Korea

Suite 2407, Trade Tower  
159 Samsung-dong, Kangnam-gu  
Seoul 135-729  
Korea  
Phone: 822-551-1331  
Facsimile: 822-551-1330

#### Dataquest Taiwan

11F-2, No. 188, Section 5  
Nan King East Road  
Taipei  
Taiwan, R.O.C.  
Phone: 8862-756-0389  
Facsimile: 8862-756-2663

#### Dataquest Singapore

105 Cecil Street  
#06-01/02 The Octagon  
Singapore 069534  
Phone: 65-227-1213  
Facsimile: 65-227-4607

#### Dataquest Thailand

12/F, Vanissa Building  
29 Soi Chidlom  
Ploenchit Road  
Patumwan, Bangkok 10330  
Thailand  
Phone: 662-655-0577  
Facsimile: 662-655-0576

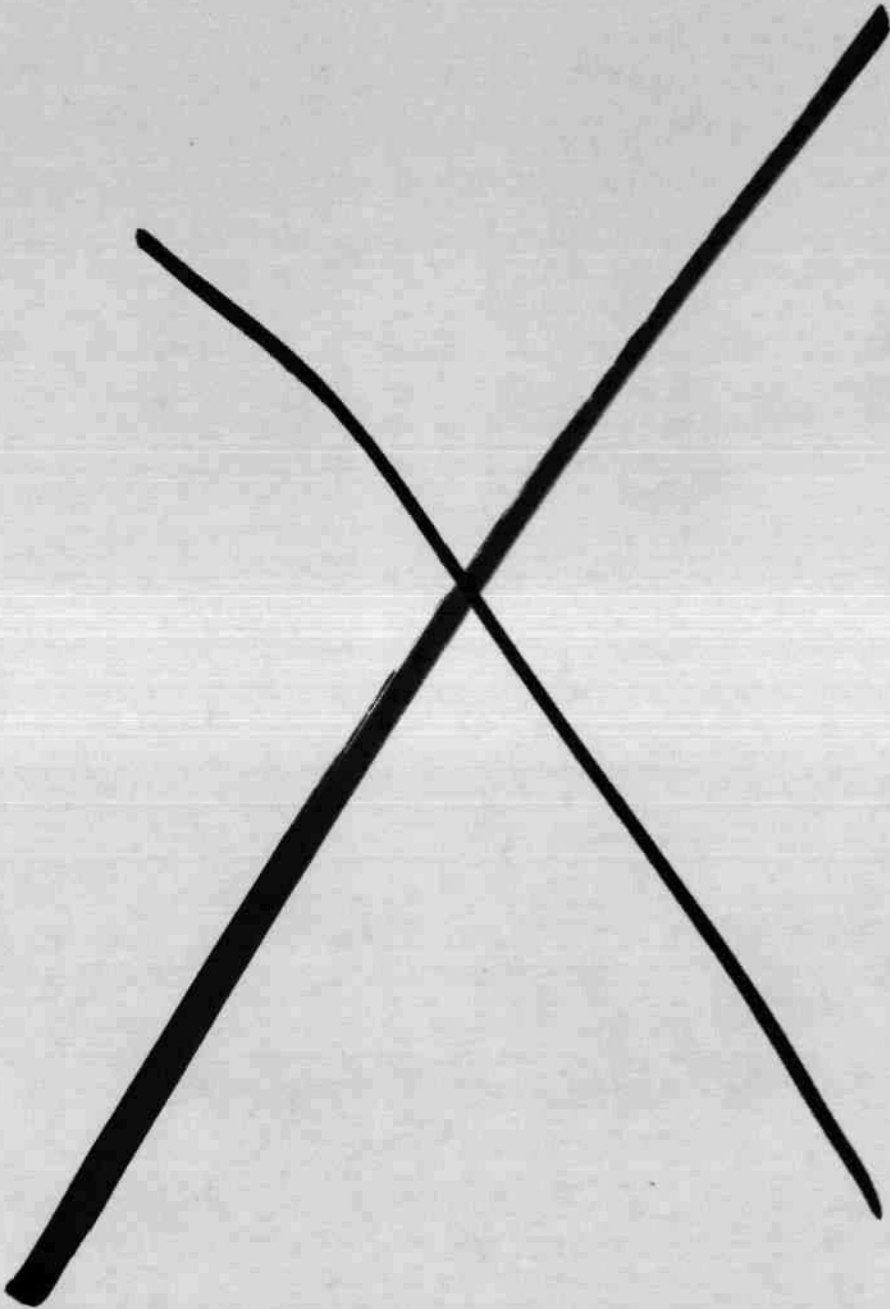
#### Research Affiliates and Sales Offices:

Melbourne, Australia  
Beijing, China

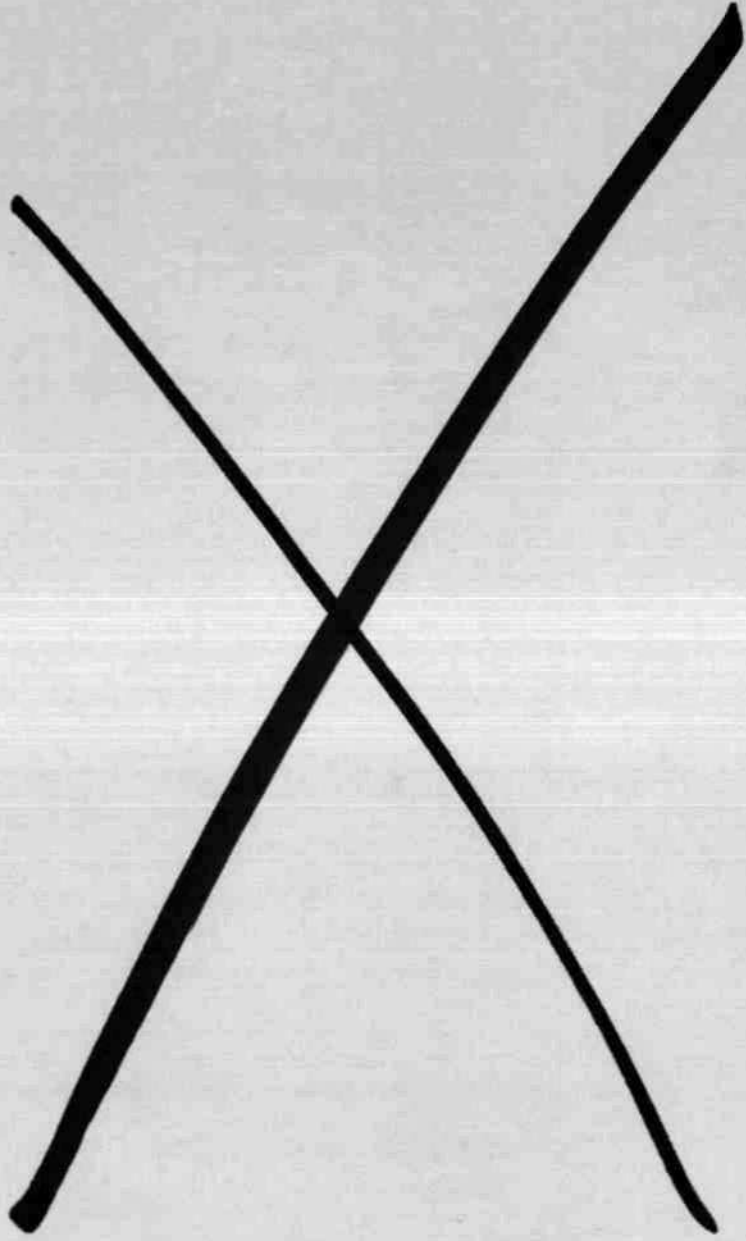
# Dataquest

A Gartner Group Company

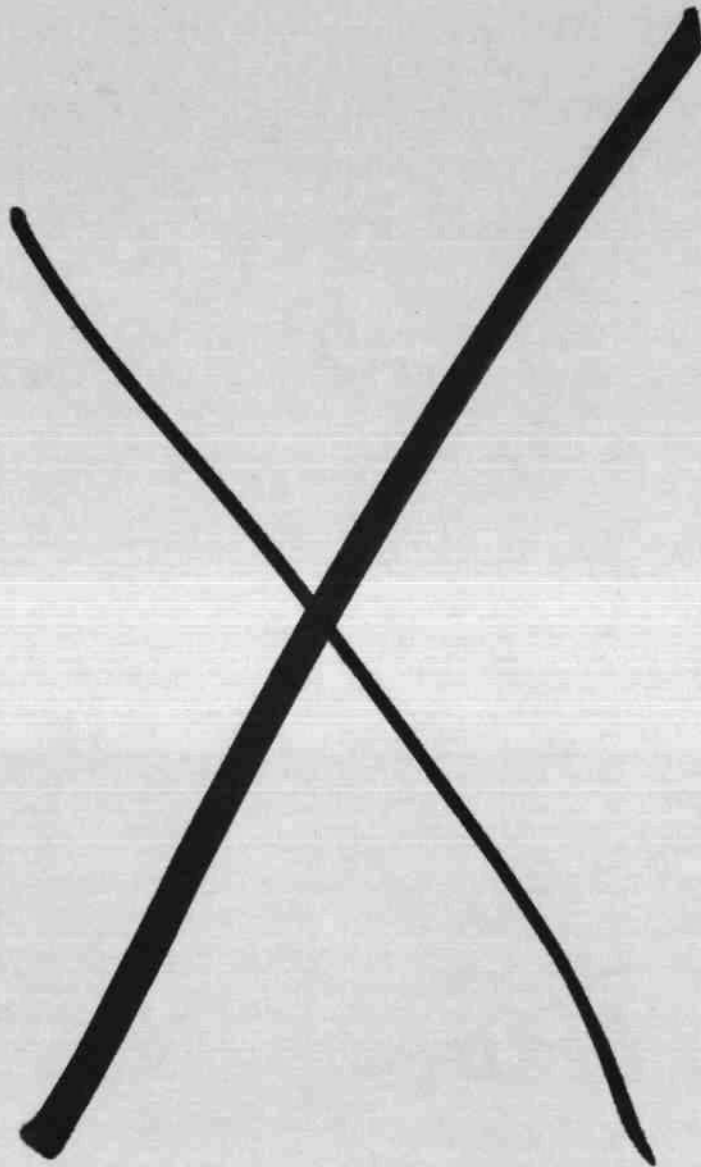
©1997 Dataquest



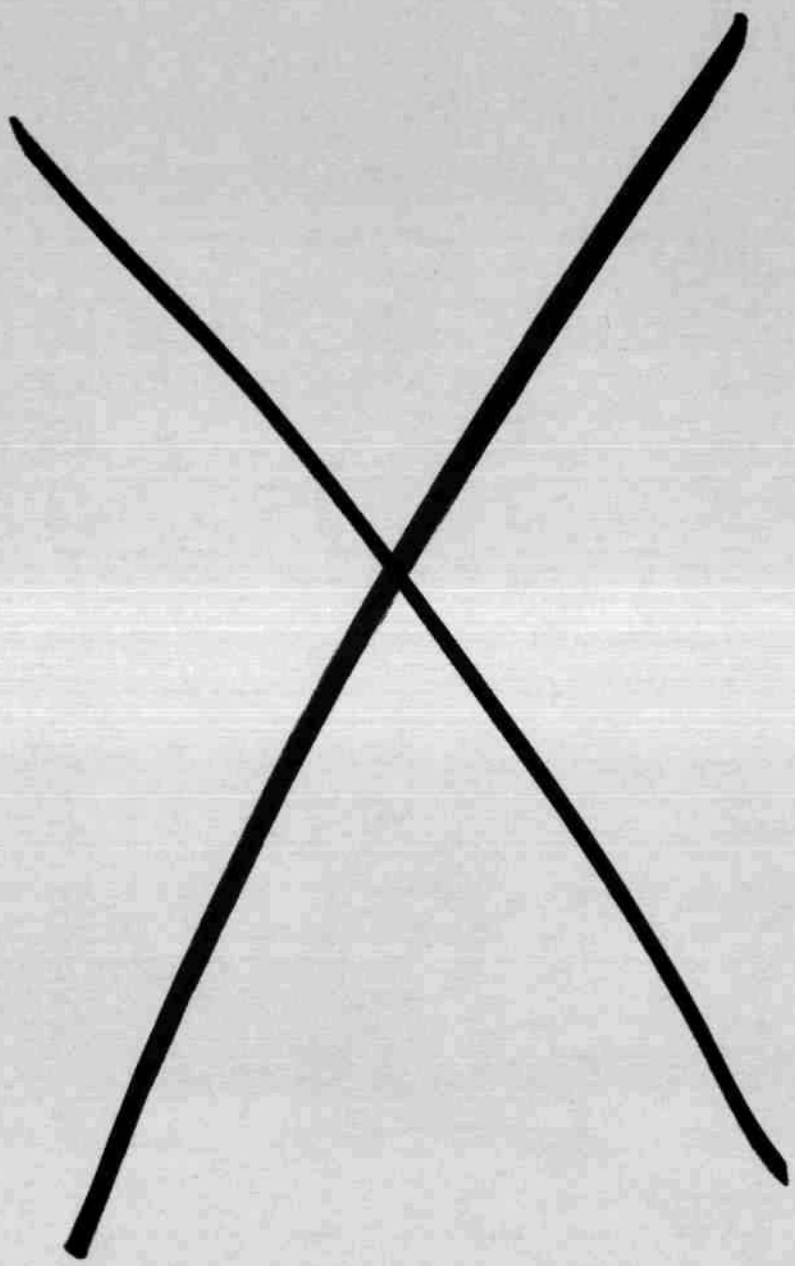
**Dataquest**



**Dataquest**



**Dataquest**



**Dataquest**



June 2, 1997

## Errata

In Dataquest's *MPUs and MCUs Battle for the Hearts of Next-Generation Consumer Products* (MSAM-WW-CT-9701, May 19, 1997), the title of Table 2-1 was incorrect. Please insert this corrected table and list of tables in the document you received and place this errata in the front pocket of the binder.

Dataquest regrets the error and apologizes for any inconvenience. For further information, contact Senior Industry Analyst Dale Ford at (408) 468-8311 or at [dale.ford@dataquest.com](mailto:dale.ford@dataquest.com).



FILE COPY:  
MARIA VALENZUELA

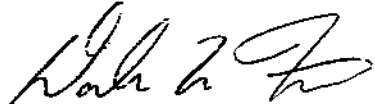
November 6, 1997

## Errata

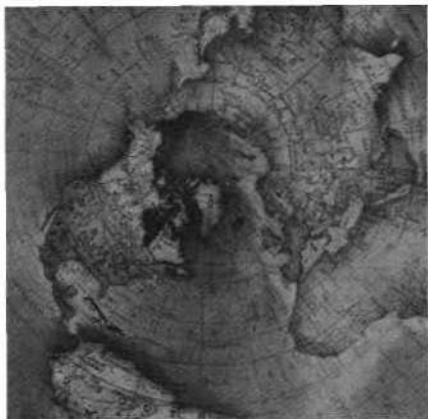
In Dataquest's *1996 Consumer Electronics Semiconductor Market Share* (MSAM-WW-CT-9702, August 25, 1997), the data in Table 6-2 was incorrect. Please remove the incorrect table from your binder, insert this corrected table, and place this errata in the front pocket of the binder.

Dataquest regrets the error and apologizes for any inconvenience. For further information, contact Senior Industry Analyst Dale Ford at (408) 468-8311 or at [dale.ford@dataquest.com](mailto:dale.ford@dataquest.com).

Sincerely,



Dale Ford  
Senior Industry Analyst



FILE COPY:  
MARIA VALENZUELA

**Dataquest**

# **1996 Consumer Electronics Semiconductor Market Share**



**Competitive Trends**

---

**Program:** Consumer Multimedia Semiconductors and Applications Worldwide  
**Product Code:** MSAM-WW-CT-9702  
**Publication Date:** August 25, 1997  
**Filing:** Reports



# 1996 Consumer Electronics Semiconductor Market Share



## Competitive Trends

---

**Program:** Consumer Multimedia Semiconductors and Applications Worldwide  
**Product Code:** MSAM-WW-CT-9702  
**Publication Date:** August 25, 1997  
**Filing:** Reports

## Table of Contents

	Page
1. Executive Summary .....	1
1996 Consumer Semiconductor Vendors Fight For a Piece of a Smaller Pie.....	1
MPEG and AC-3 Decompression ICs.....	1
Next-Generation Consumer Electronics Applications.....	2
2. Introduction and Definitions .....	3
Introduction .....	3
Methodology.....	4
Segmentation .....	4
Definitions.....	5
Product Definitions.....	5
3. 1996 Consumer Semiconductor Market Share: Vendors Fight For a Piece of a Smaller Pie.....	9
The Movers and the Losers.....	9
The Heavy Hitters .....	12
4. MPEG and AC-3 Decompression ICs .....	25
Market Scope .....	25
1996 Pricing and Technology Trends.....	25
Compression IC Market Rankings.....	25
C-Cube Charges into the Lead.....	28
SGS-Thomson Retains MPEG-2 Dominance.....	29
LSI Breaks into the Top Ranks.....	29
5. Next-Generation Consumer Electronics Applications.....	31
The Gold Rush Is On.....	31
DBS Set-Top Boxes .....	35
Digital Cable Set-Top Boxes .....	35
32/64-Bit Video Game Controllers.....	35
Video CD Players .....	35
Digital-Still Cameras .....	38
Digital Camcorders.....	38
DVD Video Players.....	38
6. Market Participation Tables .....	41

## List of Figures

---

Figure	Page
3-1 Top 10 Vendors of Semiconductors for Use in Consumer Electronics, Worldwide Revenue .....	10
4-1 Top Five Vendors of MPEG and AC-3 Decoder ICs, Worldwide Revenue .....	28
5-1 Top 10 Vendors of ICs for Use in Next-Generation Consumer Electronics, Worldwide Revenue .....	33

## List of Tables

Table	Page
3-1 Top 20 Vendors of Semiconductors for Use in Consumer Electronics, Worldwide Revenue .....	9
3-2 Top 10 Vendors of Semiconductors for Use in Consumer Electronics by Semiconductor Type, Worldwide Revenue .....	11
3-3 Top 20 Vendors of All ICs for Use in Consumer Electronics, Worldwide Revenue .....	13
3-4 Top Six Vendors of Bipolar Digital ICs for Use in Consumer Electronics, Worldwide Revenue .....	13
3-5 Top 20 Vendors of MOS Digital ICs for Use in Consumer Electronics, Worldwide Revenue .....	14
3-6 Top 11 Vendors of MOS Memory for Use in Consumer Electronics, Worldwide Revenue .....	14
3-7 Top 20 Vendors of MOS Microcomponents for Use in Consumer Electronics, Worldwide Revenue .....	15
3-8 Top Five Vendors of Microprocessors for Use in Consumer Electronics, Worldwide Revenue .....	15
3-9 Top 18 Vendors of Microcontrollers for Use in Consumer Electronics, Worldwide Revenue .....	16
3-10 Top 10 Vendors of Microperipherals for Use in Consumer Electronics, Worldwide Revenue .....	16
3-11 Top Nine Vendors of Digital Signal Processors for Use in Consumer Electronics, Worldwide Revenue .....	17
3-12 Top 20 Vendors of MOS Logic for Use in Consumer Electronics, Worldwide Revenue .....	17
3-13 Top 20 Vendors of MOS ASICs/ ASSPs for Use in Consumer Electronics, Worldwide Revenue .....	18
3-14 Top 20 Vendors of Analog ICs for Use in Consumer Electronics, Worldwide Revenue .....	19
3-15 Top 20 Vendors of Analog Audio ICs for Use in Consumer Electronics, Worldwide Revenue .....	20
3-16 Top 20 Vendors of Analog Video ICs for Use in Consumer Electronics, Worldwide Revenue .....	21
3-17 Top 15 Vendors of Other Analog ICs for Use in Consumer Electronics, Worldwide Revenue .....	22
3-18 Top 15 Vendors of Discrete Components for Use in Consumer Electronics, Worldwide Revenue .....	22
3-19 Top 15 Vendors of Optoelectronics for Use in Consumer Electronics, Worldwide Revenue .....	23
4-1 Top Five Vendors of MPEG and AC-3 Decoder ICs, Worldwide .....	26
4-2 Top Five Vendors of MPEG-1 Decoder ICs, Worldwide.....	26
4-3 Top Five Vendors of MPEG-2, AC-3 Decoder ICs, Worldwide.....	27
4-4 Top Six Vendors of Standalone MPEG Decoder ICs, Worldwide.....	27
4-5 Top Five Vendors of ICs with Embedded MPEG Decoder Functions, Worldwide .....	27

## List of Tables (Continued)

---

Table	Page
5-1 Top 20 Vendors of ICs for Use in Next-Generation Consumer Electronics, Worldwide Revenue .....	32
5-2 Top 10 Vendors of ICs for Use in Next-Generation Consumer Electronics by Application Market , Worldwide Revenue .....	34
5-3 Top Eight Vendors of Semiconductors for Use in DBS Set-Top Boxes .....	36
5-4 Top Four Vendors of Semiconductors for Digital Cable Set-Top Boxes .....	36
5-5 Top 10 Vendors of Semiconductors for 32-/64-Bit Video Game Controllers .....	37
5-6 Top Eight Vendors of Semiconductors for Video CD Players .....	37
5-7 Top Six Vendors of Semiconductors for Digital Still Cameras.....	38
5-8 Top 11 Vendors of Semiconductors for Digital Camcorders .....	39
5-9 Top 10 Vendors of Semiconductors for DVD Video Players .....	39
6-1 Matrix of Company Participation in Various MPEG Product Segments.....	41
6-2 Matrix of Company Participation in Various Consumer Electronics Semiconductor Product Segments .....	42



## Chapter 1

# Executive Summary

---

### 1996 Consumer Semiconductor Vendors Fight For a Piece of a Smaller Pie

The 1996 semiconductor market for consumer electronics reflected the woes of the overall semiconductor market, shrinking by more than 4 percent from 1995. Within this arena there was some significant shuffling among the ranks of the leaders as fortunes rose and fell among the major players.

Taken as groups, both the top five and the top 10 companies in the market accounted for about the same share of the market in 1996 as in 1995. In 1995, the top five companies represented 47.1 percent of the market, and this decreased slightly in 1996 to 46.8 percent. The top 10 companies garnered 73.0 percent of the 1996 revenue, down very slightly from 75.0 in 1995.

The major suppliers of memory to consumer electronics typically suffered the biggest losses because of the steep decline in memory prices and the relative nonelasticity of the memory market in consumer electronics. Overall it appears that the major suppliers of semiconductors to legacy consumer electronics products suffered the biggest setbacks in the consumer electronics segment.

### MPEG and AC-3 Decompression ICs

Decompression chips that comply with the major video and audio compression standards—MPEG-1, MPEG-2, and AC-3—collectively represented 81 percent of the digital video and digital audio decompression semiconductors produced in 1996. The primary market for MPEG-1 video decompression ICs was in video CD players, with the remainder used in personal computers. For MPEG-2 video decompression semiconductors, the highest volume market in 1996 was direct broadcast satellite (DBS) set-top boxes, with digital versatile disc (DVD) players and digital cable set-top boxes accounting for the remainder of sales. AC-3 decoders in 1996 were used mainly in home theater audio systems and DVD players.

In the MPEG-2 decompression IC market, two major trends occurred that had opposite effects on pricing. First, increased competition in the MPEG-2 decompression IC market reduced the price of video decoding functions. Second, the MPEG-2 ICs sold in 1996 were mainly of the embedded type, helping to support prices of MPEG-2 decoders. These two opposing factors resulted in only a slight decrease in the average selling price (ASP) of MPEG-2 decompression ICs.

In the MPEG-1 market, a similar move to integration took place in 1996, with video and audio being combined. Most of the MPEG-1 chips sold in 1996 also included combined video CD-specific features, such as on-screen display. However, because a single vendor—C-Cube Microsystems—so completely dominated the video CD MPEG-1 decoder market in 1996, ASPs for those devices remained high for most of the year, and the overall ASP of MPEG-1 decoders increased.

## **Next-Generation Consumer Electronics Applications**

Next-generation products represent the greatest growth opportunity for semiconductor suppliers in the consumer electronics industry today. Such products exhibit a combination of fast sales increases and high semiconductor content. In 1996, next-generation consumer products consisted of DBS set-top boxes, digital cable set-top boxes, 32-/64-bit video game controllers, video CD players, digital still cameras, digital camcorders, and DVD video players. Some additional revenue was also derived in this segment by WebTV set-top box shipments.

*Project Analysts: Dale Ford, Jonathan Cassell, Kun Soo Lee, Joan Brown, and Kevin McClure*

## Chapter 2

# Introduction and Definitions

---

### Introduction

This report summarizes Dataquest's second annual comprehensive study of the semiconductor companies supplying the market for consumer electronics products. Rankings, market share, revenue data, and some unit shipment data for semiconductor suppliers are presented for key areas in the consumer electronics semiconductors market.

Chapter 3 provides revenue data for 1995 and 1996 in areas including:

- Semiconductors for consumer applications
- Integrated circuits (ICs) for consumer applications
- MOS digital ICs for consumer applications
- Microcontrollers for consumer applications
- MOS ASICs/application-specific standard products (ASSPs) for consumer applications

Chapter 4 presents company rankings in the markets for semiconductors used in video and audio decompression and provides revenue and unit shipment data on areas including:

- MPEG decoder ICs
- MPEG-1 decoder ICs
- MPEG-2 decoder ICs

Chapter 5 ranks companies participating in the market for semiconductors (excluding memory, discrettes, and optoelectronics) used in next-generation consumer electronics products. Rankings are presented on a revenue basis. Areas ranked include:

- Overall ICs used in next-generation consumer electronics equipment
- ICs used in digital DBS set-top boxes
- ICs used in 32- and 64-bit video game consoles
- ICs used in digital-still cameras

Chapter 6 provides two matrix tables that delineate the participation of various companies in different segments of the consumer electronics market.

## Methodology

The information in this report was derived using two methods. The first method used a written company survey conducted in April and May 1997. The second method used estimates made by Dataquest's semiconductor product and regional analysts. A team of worldwide Dataquest analysts reviewed the preliminary results and made some modifications of the information based on their professional judgment and insight. Dataquest believes that the companies and products surveyed and analyzed in this report account for about 90 percent or more of worldwide shipments of semiconductors used in consumer electronics applications.

## Segmentation

This section outlines the market segments that are specific to this document. It also provides a list of definitions of the markets and products covered in this document.

Dataquest's objective is to provide data along lines of segmentation that are logical, appropriate to the industry in question, and immediately useful to clients. For market share purposes, Dataquest defines the semiconductor market according to the following functional segmentation scheme:

- Total semiconductors—Hybrids, total monolithic ICs, total discretes, and total optical semiconductors
  - Digital bipolar ICs—Bipolar digital memory ICs and bipolar digital logic ICs
  - MOS digital ICs—MOS digital memory ICs, MOS digital microcomponent ICs, and MOS digital logic ICs
    - MOS digital MPUs—8-bit and 16-bit CISC MPUs, 32-bit and greater CISC MPUs, and 32-bit and greater RISC MPUs
    - MOS digital microcontrollers (MCUs)—4-bit MCUs, 8-bit MCUs, and 16-bit and greater MCUs
    - MOS digital microperipherals (MPRs)—System core logic chipsets, graphics and imaging controllers, communications controllers, mass storage controllers, and audio/other controllers
    - Programmable digital signal processors (DSPs)
    - MOS digital logic ASICs/ASSP—Traditional digital gate arrays, embedded gate arrays, MOS digital programmable logic devices, MOS digital cell-based ICs, and MOS digital full-custom ICs
    - Other MOS digital logic ICs—Standard logic, LCD drivers, and other MOS digital logic ICs
  - Analog ICs—Video analog ICs, audio analog ICs, and other analog ICs
    - Video analog ICs
    - Audio analog ICs
    - Other analog ICs

- Total discrete semiconductors—Transistors, diodes, thyristors, and other discretes
- Total optical semiconductors—Total LED lamps/displays, optocouplers, charge-coupled devices (CCDs), laser diodes, photosensors, and other optical semiconductors

## Definitions

Chapter 3 of this report features a table describing total semiconductor shipments into consumer products and then continues through the subcategories that comprise the whole. The following list provides definitions used for the data presented throughout this report.

### Product Definitions

Total Semiconductor Consumer End Use includes the following categories: Hybrid IC, Total Monolithic IC, Total Discrete, and Total Optical Semiconductor. Total semiconductor is defined as any active semiconductor product that contains semiconducting material (such as silicon, germanium, or gallium arsenide, but excluding ceramics) and reacts dynamically to an input signal, either by modifying its shape or adding energy to it. This definition excludes standalone passive components such as capacitors, resistors, inductors, oscillators, crystals, transformers, and relays.

Consumer electronics end use is defined as all semiconductors used in consumer electronics applications. Consumer electronics applications consist of audio, video, personal electronics, appliances, and other consumer equipment. Audio equipment includes stereos and compact disc players. Video equipment encompasses devices such as VCRs, TVs, and camcorders. The personal electronics category is comprised of set-top boxes, electronic games and toys (with cartridges), cameras, and watches and clocks. Appliances include air conditioners, microwave ovens, and refrigerators. Other consumer electronics equipment consists of devices not classified elsewhere, such as garage door openers. Products not counted as consumer electronics equipment include home PCs, printers and fax equipment, corded and cordless telephones, answering machines, and cellular telephones. Dataquest categorizes this equipment in the data processing and communications segments.

Total IC Consumer End Use includes the following categories: Bipolar Digital IC, MOS Digital IC, and Analog IC. An IC is defined as a large number of passive and/or active discrete semiconductor circuits integrated into a single package.

Bipolar Digital IC includes the following categories: Bipolar Digital Memory IC and Bipolar Digital Logic IC. A bipolar digital IC is a monolithic semiconductor product in which 100 percent of the die area performs digital functions, and, concurrently, 100 percent of the die area is manufactured using bipolar semiconductor technology. A digital function is one in which data is carried as numerical values, usually in a binary code.

MOS Digital IC includes the following categories: MOS Digital Memory IC, MOS Digital Microcomponent IC, and MOS Digital Logic IC. MOS

Digital IC is defined as a monolithic semiconductor product in which 100 percent of the die area performs digital functions and, concurrently, any portion of the die area that is manufactured using MOS technology. A digital function is one in which data is carried as numerical values, usually in a binary code. This category includes mixed-technology manufacturing, such as BiMOS and BiCMOS, where there is some MOS technology employed.

MOS Memory IC includes the following categories: DRAM, SRAM, EPROM, EEPROM, Flash Memory, Mask ROM, and Other MOS Digital Memory. MOS Memory IC is defined as a MOS IC in which data is stored and electronically retrieved.

MOS Microcomponent IC includes the following categories: MOS Digital Microprocessor, MOS Digital Microcontroller, MOS Digital Microperipheral, and Programmable Digital Signal Processor. MOS Microcomponent IC is defined as a MOS IC that contains a data processing unit or serves as an interface to such a unit.

Microprocessor includes the following categories: 8-bit and 16-bit CISC MPU, 32-bit and greater CISC MPU, and 32-bit and greater RISC MPU. A microprocessor is an IC that includes an instruction decoder, an arithmetic logic unit (ALU), registers, and additional logic. It may contain an instruction cache and/or data cache. An MPU's functions are determined by fetching and executing instructions and manipulating data held in external memory or an internal cache. The MPU category includes MPUs incorporating or originating from an ASIC design.

Microcontroller includes the following categories: 4-bit MCU, 8-bit MCU, and 16-bit and greater MCU. A microcontroller is an IC that is similar to an MPU, with the primary exception being that it is designed to operate from on-chip program and data memory (not including cache memories). MCU devices must be available with on-chip program and/or data store. As an option, some MCU devices can be purchased without on-chip memory. The MCU category includes MCUs incorporating, or originating from, an ASIC design.

A digital signal processor (DSP) is an IC that includes a high-speed arithmetic unit (typically a multiply-accumulate unit) used for performing complex mathematical operations, such as Fourier transforms. Like an MPU or an MCU, a pDSP is programmable in that it fetches and executes preprogrammed instructions. These instructions are oriented toward signal-processing algorithms. Integrating a pDSP on the same chip as an MPU or MCU does not alter the MPU or MCU categorization of that device.

Microperipheral is defined as an IC that serves as a logical support function to an MPU in a system. This definition includes MPRs consisting of more than one device, such as PC or core logic chipsets. The MPR category includes MPRs incorporating or originating from an ASIC design.

MOS Logic IC includes the following categories: MOS Logic, MOS ASIC/ASSP, and Other MOS Logic. MOS Logic IC is defined as a MOS IC in which more than 50 percent of the die area performs logic functions; this excludes MOS microcomponent ICs.

MOS ASIC/ASSP includes the following categories: Traditional Digital Gate Array, Embedded Gate Array, MOS Digital Programmable Logic Device, MOS Digital Cell-Based IC, and MOS Digital Full-Custom IC. A MOS ASIC/ASSP is defined as a single-user logic IC (ASIC) or multiple-user logic IC (ASSP) that is manufactured using vendor-supplied tools and/or libraries. This does not include ASICs of ASSPs incorporating microprocessor cells or microcontroller cells, as these should be reported in the microprocessor IC or microcontroller IC categories, respectively.

Other MOS Logic IC: Defined as all other MOS logic ICs not accounted for in the preceding categories. This includes MOS commodity family logic with 150 or more gates and MOS general-purpose logic not belonging to any families.

Analog IC includes the following categories: Analog Video IC, Analog Audio IC, and Other Analog IC. Analog IC is defined as a semiconductor product that deals with electrical signal processing, power control, or electrical drive capability. It is one in which some of the inputs or outputs can be defined in terms of continuously or linearly variable voltages, currents, or frequencies. This includes only monolithic analog ICs manufactured using bipolar, MOS, or BiCMOS technologies. A monolithic IC is a single die contained in a single package.

Analog Audio IC is defined as an analog IC implemented for audio applications, including radio and speech synthesis and recognition.

Analog Video IC is defined as an analog IC implemented for video applications including video encoding and decoding.

Other Analog IC is defined as an analog IC used in consumer applications other than processing video or audio.

Total Discrete includes the following categories: Transistor, Diode, Thyristor, and Other Discrete. A discrete semiconductor is defined as a single semiconductor component, such as a transistor, diode, or thyristor. Although multiple devices may be present in a package, they are still considered discretely if they have no internal functional interconnection and are applied in the same manner as other discrete devices.

Total Optoelectronics includes the following categories: Total LED Lamp/Display, Optocoupler, Charge-Coupled Device, Laser Diode, Photosensor, and Other Optical Semiconductor. Total Optoelectronics is defined as a semiconductor product in which photons induce the flow of electrons or vice versa. Other functions may also be integrated onto the product. This category does not include LCD, incandescent displays, fluorescent displays, cathode ray tubes (CRTs), or plasma displays.

MPEG Decoder IC is an IC implemented for the purpose of decoding data conforming with the MPEG-1 or MPEG-2 specifications for digital video and audio compression.

MPEG-1 Decoder IC is an IC implemented for the purpose of decoding data conforming with the MPEG-1 specification for digital video and audio compression.

MPEG-2 Decoder IC is an IC implemented for the purpose of decoding data conforming with the MPEG-2 specification for digital video and audio compression.

AC-3 Decoder IC is an IC implemented for the purpose of decoding data conforming with the AC-3 specification for digital audio compression.

Standalone MPEG IC is an IC exclusively dedicated to performing MPEG encoding or decoding.

Embedded MPEG IC is an ASIC or ASSP that implements MPEG encoding or decoding as part of a larger audio or video processing function.



## Chapter 3

# 1996 Consumer Semiconductor Market Share: Vendors Fight For a Piece of a Smaller Pie

### The Movers and the Losers

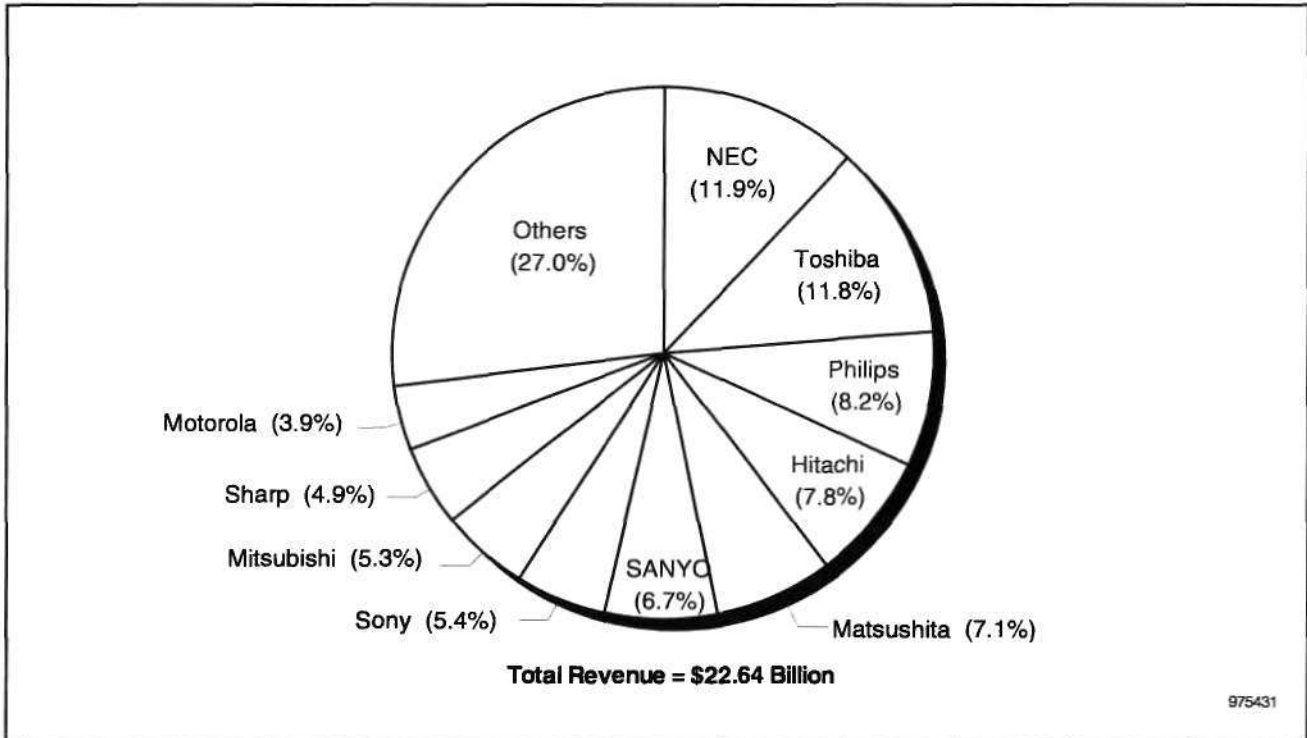
The 1996 semiconductor market for consumer electronics reflected the woes of the overall semiconductor market, shrinking by more than 4 percent from 1995. Within this arena there was some significant shuffling among the ranks of the leaders as fortunes rose and fell among the major players. A listing of the top 20 companies in this market is presented in Table 3-1 along with a comparison to their revenue in 1995. Figure 3-1 depicts the market share of the top 10 companies. Table 3-2 provides additional detail on the semiconductor revenue by type for the top ten suppliers.

**Table 3-1**  
**Top 20 Vendors of Semiconductors for Use in Consumer Electronics, Worldwide Revenue (Millions of U.S. Dollars)**

1996 Rank	1995 Rank	Company	1995 Revenue	1996 Revenue	1995-1996 Growth (%)	1996 Market Share (%)
1	2	NEC	2,710	2,685	-0.9	11.9
2	1	Toshiba	3,060	2,663	-13.0	11.8
3	4	Philips	1,846	1,865	1.0	8.2
4	6	Hitachi	1,604	1,762	9.9	7.8
5	3	Matsushita	1,905	1,619	-15.0	7.1
6	5	SANYO	1,613	1,520	-5.8	6.7
7	9	Sony	1,261	1,215	-3.7	5.4
8	7	Mitsubishi	1,431	1,211	-15.4	5.3
9	8	Sharp	1,343	1,103	-17.8	4.9
10	10	Motorola	964	886	-8.1	3.9
11	11	Samsung	748	712	-4.8	3.1
12	12	Texas Instruments	566	549	-3.1	2.4
13	16	LSI Logic	279	395	41.6	1.7
14	14	Siemens	353	356	0.8	1.6
15	13	Fujitsu	368	332	-9.8	1.5
16	17	SGS-Thomson	254	326	28.3	1.4
17	25	C-Cube	90	234	160.0	1.0
18	18	National Semiconductor	222	217	-2.3	1.0
19	21	Yamaha	171	212	24.0	0.9
20	15	Oki	280	203	-27.4	0.9
		All Others	2,570	2,574	0.2	11.4
		<b>Total Market</b>	<b>23,638</b>	<b>22,639</b>	<b>-4.2</b>	<b>100.0</b>

Source: Dataquest (July 1997)

**Figure 3-1**  
**Top 10 Vendors of Semiconductors for Use in Consumer Electronics, Worldwide**  
**Revenue (Millions of U.S. Dollars)**



Source: Dataquest (July 1997)

A review of the results for 1996 compared with 1995 statistics reveals some important dynamics that took place among the leaders in the market for chips in consumer electronics:

- NEC Corporation in 1996 skillfully contained the damage and managed to suffer a sales decline of less than 1 percent for the year. This allowed NEC to slip past Toshiba Corporation to capture the top position in the market. NEC occupies the No. 1 rank in microprocessors, microcontrollers, and ASICs/ASSPs.
- Toshiba Corporation stumbled during 1996, losing 13 percent of its chip revenue in consumer electronics, but it was still able to hang onto the No. 2 position. Toshiba's losses were experienced across the board, and the company was especially hit hard in the memory and MOS logic markets.
- Philips Semiconductors, Inc. and Hitachi Ltd. were the other winners among the top five, managing to grow their revenue by 1.0 and 9.9 percent and moving up to the No. 3 and No. 4 positions, respectively. Matsushita Electric Industrial Company Ltd. was the second member of the top five to stumble during 1996 as its revenue declined by 15 percent and it fell from No. 3 to No. 5.
- Taken as groups, the top five and top 10 companies in the market accounted for about the same share of the market in 1996 as in 1995. In 1995, the top five companies represented 47.1 percent of the market, and this decreased slightly in 1996 to 46.8 percent. The top 10 companies garnered 73.0 percent of the 1996 revenue, down very slightly from 75.0 in 1995.

**Table 3-2**  
**Top 10 Vendors of Semiconductors for Use in Consumer Electronics by Semiconductor Type, Worldwide Revenue**  
**(Millions of U.S. Dollars)**

Rank	Company	Semi-conductors	Consumer ICs	Bipolar Digital ICs	MOS Memory	Micro-processors	Micro-controllers	Micro-peripherals	Digital Signal Processors	MOS ASICs/ ASSPs	Total Other MOS Logic	Total Analog ICs	Discrete Components	Opto-electronics
1	NEC	2685	2246	20	315	185	758	65	18	456	105	324	352	87
2	Toshiba	2663	2071	20	360	26	470	91	14	360	165	565	431	161
3	Philips	1865	1475	-	-	-	105	-	-	5	390	975	390	-
4	Hitachi	1762	1580	54	184	153	518	32	17	118	138	366	156	26
5	Matsushita	1619	997	7	39	0	229	7	0	335	12	368	424	198
6	SANYO	1520	1134	0	9	0	126	0	9	36	213	741	287	99
7	Sony	1215	925	0	36	0	112	12	0	238	101	425	36	254
8	Mitsubishi	1211	956	16	91	0	494	18	0	66	25	246	193	62
9	Sharp	1103	822	0	330	2	128	3	0	160	139	60	0	281
10	Motorola	886	727	32	119	51	210	48	16	133	1	117	154	5

Source: Dataquest (July 1997)

- The big gainers among the top 20, C-Cube, LSI Logic Corporation, and SGS Thomson Microelectronics B.V., benefited from the success of their products in next-generation consumer electronics, discussed as follows:
  - C-Cube broke into the top 20 for the first time by growing its revenue by 160 percent and jumping from No. 25 to No. 17. It also moved up to No. 10 in MOS logic from No. 18.
  - LSI Logic increased its revenue by 41.6 percent and leaped from No. 16 to No. 13. Its strong performance in ASIC/ASSP products pushed it into a tie for MOS logic with Philips at No. 3.
  - SGS-Thomson moved up to No. 16 on the strength of its revenue growth in MOS logic. Its overall semiconductor revenue in the consumer electronics market grew by 28.3 percent.
  - Sony Corporation of America was able to move up to No. 7 simply by limiting its losses to only 3.7 percent. It was able to offset the reduction in revenue from analog components with solid gains in MOS logic revenue.
  - The major suppliers of memory to consumer electronics typically suffered the biggest losses because of the steep decline in memory prices and the relative nonelasticity of the memory market in consumer electronics.
  - NEC and Hitachi occupy the top two positions in the microcomponent market. Hitachi jumped into second place with 32.1 percent growth fueled by the success of its SH processor family.

Overall it appears that the major suppliers of semiconductors to legacy consumer electronics products suffered the biggest setbacks in the consumer electronics segment. The core legacy consumer electronics market experienced its first contraction in over 10 years in 1996. The companies that were most successful in either growing their markets or avoiding losses were typically the companies that have experienced the most success in the emerging next-generation consumer electronics market, discussed later in this document.

## The Heavy Hitters

The following describes the top 10 companies in the consumer electronics semiconductor market. The companies listed are leaders in the segments constituting the consumer semiconductor market. As noted previously, these companies account for almost 75 percent of all semiconductor revenue in the area of consumer electronics. Although it is not one of the top 10 consumer semiconductor suppliers, Texas Instruments Inc. is the leading seller of DSPs for consumer applications. Tables 3-3 through 3-19 present the top semiconductor vendors for various categories of semiconductors used in consumer electronics.

**Table 3-3****Top 20 Vendors of All ICs for Use in Consumer Electronics, Worldwide Revenue (Millions of U.S. Dollars)**

1996 Rank	1995 Rank	Company	1995 Revenue	1996 Revenue	1995-1996 Growth (%)	1996 Market Share (%)
1	2	NEC	2,246	2,246	0.0	12.5
2	1	Toshiba	2,392	2,071	-13.4	11.5
3	3	Hitachi	1,412	1,580	11.9	8.8
4	4	Philips	1,372	1,475	7.5	8.2
5	6	SANYO	1,196	1,134	-5.2	6.3
6	5	Matsushita	1,202	997	-17.1	5.6
7	7	Mitsubishi	1,130	956	-15.4	5.3
8	9	Sony	969	925	-4.6	5.2
9	8	Sharp	1,081	822	-23.9	4.6
10	10	Motorola	770	727	-5.6	4.1
11	11	Samsung	632	577	-8.7	3.2
12	12	Texas Instruments	552	536	-3.0	3.0
13	14	LSI Logic	279	395	41.6	2.2
14	13	Fujitsu	327	297	-9.2	1.7
15	19	SGS-Thomson	181	261	44.2	1.5
16	25	C-Cube	90	234	160.0	1.3
17	21	Yamaha	171	212	24.0	1.2
18	16	National Semiconductor	200	208	4.0	1.2
19	17	United Microelectronics	188	198	5.3	1.1
20	18	Siemens	187	194	3.7	1.1
		All Others	1,878	1,904	1.4	10.6
		<b>Total Market</b>	<b>18,455</b>	<b>17,948</b>	<b>-2.7</b>	<b>100.0</b>

Source: Dataquest (July 1997)

**Table 3-4****Top Six Vendors of Bipolar Digital ICs for Use in Consumer Electronics, Worldwide Revenue (Millions of U.S. Dollars)**

1996 Rank	1995 Rank	Company	1995 Revenue	1996 Revenue	1995-1996 Growth (%)	1996 Market Share (%)
1	1	Hitachi	68	54	-20.0	29.4
2	2	Motorola	37	32	-13.5	17.3
3	3	Toshiba	32	20	-37.5	10.8
4	4	NEC	24	20	-16.7	10.8
5	5	Texas Instruments	13	17	30.8	9.2
6	8	Mitsubishi	9	16	77.8	8.7
		All Others	42	25	-39.5	13.7
		<b>Total Market</b>	<b>225</b>	<b>185</b>	<b>-17.9</b>	<b>100.0</b>

Source: Dataquest (July 1997)

**Table 3-5**  
**Top 20 Vendors of MOS Digital ICs for Use in Consumer Electronics, Worldwide**  
**Revenue (Millions of U.S. Dollars)**

1996 Rank	1995 Rank	Company	1995 Revenue	1996 Revenue	1995-1996 Growth (%)	1996 Market Share (%)
1	1	NEC	1,875	1,902	1.4	15.3
2	2	Toshiba	1,791	1,486	-17.0	12.0
3	3	Hitachi	1,024	1,160	13.3	9.4
4	4	Sharp	1,011	762	-24.6	6.1
5	5	Mitsubishi	819	694	-15.3	5.6
6	6	Matsushita	742	622	-16.2	5.0
7	7	Motorola	598	578	-3.3	4.7
8*	9	Philips	472	500	5.9	4.0
8*	11	Sony	443	500	12.8	4.0
10	8	Samsung	555	487	-12.3	3.9
11	13	LSI Logic	279	395	41.6	3.2
12	10	SANYO	451	393	-12.9	3.2
13	13	Texas Instruments	374	349	-6.8	2.8
14	23	C-Cube	90	234	160.0	1.9
15	20	SGS-Thomson	161	233	44.7	1.9
16	15	Fujitsu	233	225	-3.4	1.8
17	18	Yamaha	171	212	24.0	1.7
18	16	United Microelectronics	188	198	5.3	1.6
19	14	Oki	244	179	-26.6	1.4
20	19	LG Semicon	167	155	-7.2	1.2
		All Others	1,151	1,138	-1.1	9.2
		<b>Total Market</b>	<b>12,839</b>	<b>12,401</b>	<b>-3.4</b>	<b>100.0</b>

\*Sony and Philips tied for 1996 rank.

Source: Dataquest (July 1997)

**Table 3-6**  
**Top 11 Vendors of MOS Memory for Use in Consumer Electronics, Worldwide Revenue**  
**(Millions of U.S. Dollars)**

1996 Rank	1995 Rank	Company	1995 Revenue	1996 Revenue	1995-1996 Growth (%)	1996 Market Share (%)
1	2	Samsung	511	441	-13.7	15.7
2	1	Toshiba	515	360	-30.1	12.8
3	3	Sharp	468	330	-29.5	11.8
4	4	NEC	431	315	-26.9	11.2
5	5	Hitachi	268	184	-31.3	6.6
6	8	United Microelectronics	148	145	-2.0	5.2
7	6	Hyundai	170	130	-23.5	4.6
8	9	LG Semicon	145	125	-13.8	4.5
9	11	Motorola	138	119	-13.8	4.2
10	7	Texas Instruments	153	117	-23.5	4.2
11	10	Mitsubishi	144	91	-36.8	3.2
		All Others	525	450	-14.3	16.0
		<b>Total Market</b>	<b>3,616</b>	<b>2,807</b>	<b>-22.4</b>	<b>100.0</b>

Source: Dataquest (July 1997)

**Table 3-7****Top 20 Vendors of MOS Microcomponents for Use in Consumer Electronics, Worldwide Revenue (Millions of U.S. Dollars)**

1996 Rank	1995 Rank	Company	1995 Revenue	1996 Revenue	1995-1996 Growth (%)	1996 Market Share (%)
1	1	NEC	921	1,026	11.4	22.5
2	4	Hitachi	545	720	32.1	15.8
3	2	Toshiba	678	601	-11.4	13.2
4	3	Mitsubishi	564	512	-9.2	11.2
5	5	Motorola	360	325	-9.7	7.1
6	6	Matsushita	293	236	-19.5	5.2
7	8	SANYO	151	135	-10.3	3.0
8	7	Sharp	172	133	-22.7	2.9
9	9	Sony	139	124	-10.8	2.7
10	12	Philips	95	105	10.5	2.3
11	11	Texas Instruments	100	92	-8.5	2.0
12	13	Fujitsu	82	90	10.0	2.0
13	14	Microchip Technology	64	77	20.3	1.7
14	10	Oki	103	73	-29.1	1.6
15	15	Zilog	53	62	17.0	1.4
16	16	United Microelectronics	40	53	32.5	1.2
17	19	Siemens	23	25	8.7	0.5
18	17	Intel	37	24	-35.1	0.5
19	18	SGS-Thomson	25	24	-4.0	0.5
20	20	Samsung	14	15	7.1	0.3
		All Others	122	115	-6.0	2.5
		<b>Total Market</b>	<b>4,581</b>	<b>4,567</b>	<b>-0.3</b>	<b>100.0</b>

Source: Dataquest (July 1997)

**Table 3-8****Top Five Vendors of Microprocessors for Use in Consumer Electronics, Worldwide Revenue (Millions of U.S. Dollars)**

1996 Rank	1995 Rank	Company	1995 Revenue	1996 Revenue	1995-1996 Growth (%)	1996 Market Share (%)
1	3	NEC	38	185	386.8	40.0
2	1	Hitachi	85	153	80.0	33.0
3	2	Motorola	54	51	-5.6	11.0
4	4	Toshiba	32	26	-18.0	5.7
5	5	Intel	29	18	-37.9	3.9
		All Others	49	30	-39.3	6.4
		<b>Total Market</b>	<b>287</b>	<b>463</b>	<b>61.3</b>	<b>100.0</b>

Source: Dataquest (July 1997)

**Table 3-9**  
**Top 18 Vendors of Microcontrollers for Use in Consumer Electronics, Worldwide**  
**Revenue (Millions of U.S. Dollars)**

1996 Rank	1995 Rank	Company	1995 Revenue	1996 Revenue	1995-1996 Growth (%)	1996 Market Share (%)
1	1	NEC	799	758	-5.1	21.3
2	4	Hitachi	409	518	26.7	14.6
3	2	Mitsubishi	548	494	-9.9	13.9
4	3	Toshiba	525	470	-10.5	13.2
5	5	Matsushita	285	229	-19.6	6.4
6	6	Motorola	232	210	-9.5	5.9
7	7	Sharp	157	128	-18.5	3.6
8	8	SANYO	142	126	-11.0	3.6
9	9	Sony	128	112	-12.5	3.1
10	10	Philips	95	105	10.5	3.0
11	12	Fujitsu	76	85	11.8	2.4
12	13	Microchip Technology	62	74	19.4	2.1
13	11	Oki	85	58	-31.8	1.6
14	14	Texas Instruments	40	35	-12.5	1.0
15*	15	Siemens	23	25	8.7	0.7
15*	16	Zilog	14	25	78.6	0.7
17	18	Samsung	10	14	40.0	0.4
18	17	SGS-Thomson	12	13	8.3	0.4
		All Others	89	79	-11.6	2.2
		<b>Total Market</b>	<b>3,731</b>	<b>3,558</b>	<b>-4.6</b>	<b>100.0</b>

\*Siemens and Zilog tied for 1996 rank.

Source: Dataquest (July 1997)

**Table 3-10**  
**Top 10 Vendors of Microperipherals for Use in Consumer Electronics, Worldwide**  
**Revenue (Millions of U.S. Dollars)**

1996 Rank	1995 Rank	Company	1995 Revenue	1996 Revenue	1995-1996 Growth (%)	1996 Market Share (%)
1	1	Toshiba	114	91	-20.2	21.9
2	2	NEC	74	65	-12.2	15.7
3	4	United Microelectronics	40	53	32.5	12.8
4	3	Motorola	55	48	-12.7	11.6
5	5	Hitachi	39	32	-17.9	7.7
6	6	Texas Instruments	32	25	-21.9	6.0
7	7	Zilog	19	19	0.0	4.6
8	9	Mitsubishi	12	18	50.0	4.3
9	8	Oki	17	14	-17.6	3.4
10	10	Sony	11	12	9.1	2.9
		All Others	45	38	-15.6	9.2
		<b>Total Market</b>	<b>458</b>	<b>415</b>	<b>-9.4</b>	<b>100.0</b>

Source: Dataquest (July 1997)



**Table 3-11**  
**Top Nine Vendors of Digital Signal Processors for Use in Consumer Electronics,**  
**Worldwide Revenue (Millions of U.S. Dollars)**

1996 Rank	1995 Rank	Company	1995 Revenue	1996 Revenue	1995-1996 Growth (%)	1996 Market Share (%)
1	1	Texas Instruments	26	30	15.4	23.0
2	5	NEC	10	18	80.0	13.8
3	4	Hitachi	12	17	41.7	13.0
4	2	Motorola	19	16	-15.8	12.3
5	3	Zilog	12	15	25.0	11.5
6	7	Toshiba	7	14	94.3	10.4
7	6	SANYO	9	9	0.0	6.9
8	8	Analog Devices	3	7	133.3	5.4
9	9	GEC Plessey	3	2	-33.3	1.5
		All Others	4	3	-25.0	2.3
		<b>Total Market</b>	<b>105</b>	<b>131</b>	<b>24.4</b>	<b>100.0</b>

Source: Dataquest (July 1997)

**Table 3-12**  
**Top 20 Vendors of MOS Logic for Use in Consumer Electronics, Worldwide Revenue**  
**(Millions of U.S. Dollars)**

1996 Rank	1995 Rank	Company	1995 Revenue	1996 Revenue	1995-1996 Growth (%)	1996 Market Share (%)
1	2	NEC	523	561	7.3	11.2
2	1	Toshiba	598	525	-12.2	10.4
3*	4	Philips	377	395	4.8	7.9
3*	7	LSI Logic	279	395	41.6	7.9
5	3	Matsushita	384	347	-9.6	6.9
6	8	Sony	253	339	34.1	6.8
7	5	Sharp	371	299	-19.4	5.9
8	9	Hitachi	211	256	21.3	5.1
9	6	SANYO	288	249	-13.5	5.0
10	18	C-Cube	90	234	160.0	4.7
11	10	Yamaha	170	211	24.1	4.2
12	11	SGS-Thomson	124	195	57.3	3.9
13	12	Texas Instruments	121	140	15.7	2.8
14	14	Motorola	100	134	34.0	2.7
15	13	Mitsubishi	111	91	-18.0	1.8
16	16	Fujitsu	95	90	-5.3	1.8
17	17	Oki	93	85	-8.6	1.7
18	15	Seiko Epson	97	80	-17.5	1.6
19	21	VLSI Technology	31	68	119.4	1.4
20	19	SYMBIOS	58	65	12.1	1.3
		All Others	268	268	-0.1	5.3
		<b>Total Market</b>	<b>4,642</b>	<b>5,027</b>	<b>8.3</b>	<b>100.0</b>

\*Philips and LSI Logic tied for 1996 rank.

Source: Dataquest (July 1997)

**Table 3-13**  
**Top 20 Vendors of MOS ASICs/ASSPs for Use in Consumer Electronics, Worldwide**  
**Revenue (Millions of U.S. Dollars)**

1996 Rank	1995 Rank	Company	1995 Revenue	1996 Revenue	1995-1996 Growth (%)	1996 Market Share (%)
1	2	NEC	399	456	14.3	12.9
2	4	LSI Logic	279	395	41.6	11.1
3	1	Toshiba	409	360	-12.0	10.2
4	3	Matsushita	369	335	-9.2	9.5
5	6	Sony	125	238	90.4	6.7
6	13	C-Cube	90	234	160.0	6.6
7	7	SGS-Thomson	124	195	57.3	5.5
8	5	Sharp	200	160	-20.0	4.5
9	8	Yamaha	101	140	38.6	3.9
10	9	Motorola	99	133	34.3	3.8
11	10	Hitachi	98	118	20.4	3.3
12	11	Fujitsu	95	90	-5.3	2.5
13	12	Oki	93	85	-8.6	2.4
14	19	Texas Instruments	30	75	150.0	2.1
15	18	VLSI Technology	31	68	119.4	1.9
16	14	Mitsubishi	82	66	-19.5	1.9
17	16	SYMBIOS	58	65	12.1	1.8
18	15	Seiko Epson	62	51	-17.7	1.4
19	24	Zoran	19	38	100.0	1.1
20	17	SANYO	41	36	-12.2	1.0
		All Others	219	207	-5.6	5.8
		<b>Total Market</b>	<b>3,023</b>	<b>3,545</b>	<b>17.3</b>	<b>100.0</b>

Source: Dataquest (July 1997)

**Table 3-14****Top 20 Vendors of Analog ICs for Use in Consumer Electronics, Worldwide Revenue  
(Millions of U.S. Dollars)**

1996 Rank	1995 Rank	Company	1995 Revenue	1996 Revenue	1995-1996 Growth (%)	1996 Market Share (%)
1	1	Philips	900	975	8.3	18.2
2	2	SANYO	745	741	-0.5	13.8
3	3	Toshiba	569	565	-0.7	10.5
4	4	Sony	526	425	-19.2	7.9
5	5	Matsushita	449	368	-18.0	6.9
6	7	Hitachi	320	366	14.4	6.8
7	6	NEC	347	324	-6.6	6.0
8	8	Mitsubishi	302	246	-18.5	4.6
9	9	National Semiconductor	171	178	4.1	3.3
10	10	Texas Instruments	165	170	3.0	3.2
11	12	Siemens	123	140	13.8	2.6
12	11	Motorola	135	117	-13.3	2.2
13	14	Samsung	77	90	16.9	1.7
14	13	Fujitsu	82	67	-18.3	1.2
15	15	Sharp	70	60	-13.7	1.1
16	17	Analog Devices	32	54	68.8	1.0
17	19	AKM Semiconductor	29	48	65.5	0.9
18	18	Rohm	30	46	53.3	0.9
19	16	GEC Plessey	33	30	-9.1	0.6
20	20	SGS-Thomson	20	28	40.0	0.5
		All Others	266	324	21.8	6.0
		<b>Total Market</b>	<b>5,391</b>	<b>5,362</b>	<b>-0.5</b>	<b>100.0</b>

Source: Dataquest (July 1997)

**Table 3-15**  
**Top 20 Vendors of Analog Audio ICs for Use in Consumer Electronics, Worldwide**  
**Revenue (Millions of U.S. Dollars)**

1996 Rank	1995 Rank	Company	1995 Revenue	1996 Revenue	1995-1996 Growth (%)	1996 Market Share (%)
1	1	SANYO	324	295	-9.0	17.5
2	3	Toshiba	199	190	-4.5	11.2
3	2	Sony	211	174	-17.5	10.3
4	4	Matsushita	191	162	-15.2	9.6
5	5	Hitachi	136	154	13.2	9.1
6	7	Philips	101	110	8.9	6.5
7	8	NEC	74	79	6.8	4.7
8	6	Mitsubishi	115	74	-35.7	4.4
9	9	National Semiconductor	62	66	6.5	3.9
10	10	Samsung	55	65	18.2	3.8
11	13	AKM Semiconductor	29	48	65.5	2.8
12	11	Motorola	52	45	-13.5	2.7
13	12	Siemens	35	37	5.7	2.2
14	15	Analog Devices	15	37	146.7	2.2
15	14	Sharp	27	27	0.0	1.6
16	16	Fujitsu	13	12	-7.7	0.7
17	17	Texas Instruments	10	10	0.0	0.6
18	18	Linear Technology	7	8	14.3	0.5
19	19	Daewoo	7	8	14.3	0.5
20	21	SGS-Thomson	5	7	40.0	0.4
		All Others	71	81	14.1	4.8
		<b>Total Market</b>	<b>1,739</b>	<b>1,689</b>	<b>-2.9</b>	<b>100.0</b>

Source: Dataquest (July 1997)

**Table 3-16**  
**Top 20 Vendors of Analog Video ICs for Use in Consumer Electronics, Worldwide**  
**Revenue (Millions of U.S. Dollars)**

1996 Rank	1995 Rank	Company	1995 Revenue	1996 Revenue	1995-1996 Growth (%)	1996 Market Share (%)
1	1	SANYO	309	369	19.4	19.3
2	2	Philips	300	325	8.3	17.0
3	3	Toshiba	228	232	1.8	12.1
4	4	Sony	222	174	-21.6	9.1
5	5	Matsushita	170	138	-18.8	7.2
6	7	Siemens	88	103	17.0	5.4
7	8	Hitachi	86	99	15.1	5.2
8	6	NEC	99	92	-7.1	4.8
9	9	Mitsubishi	72	74	2.8	3.9
10	10	Motorola	47	41	-12.8	2.1
11	11	National Semiconductor	39	40	2.6	2.1
12	12	GEC Plessey	33	30	-9.1	1.6
13	13	Samsung	21	25	19.0	1.3
14	16	Rockwell/Brooktree	12	16	33.3	0.8
15	14	Sharp	19	13	-29.6	0.7
16	19	SGS-Thomson	8	12	50.0	0.6
17	15	Fujitsu	13	11	-15.4	0.6
18	17	Analog Devices	10	10	0.0	0.5
19	18	Texas Instruments	10	10	0.0	0.5
20	22	Daewoo	4	6	50.0	0.3
		All Others	83	92	10.8	4.8
		<b>Total Market</b>	<b>1,873</b>	<b>1,912</b>	<b>2.1</b>	<b>100.0</b>

Source: Dataquest (July 1997)

**Table 3-17**  
**Top 15 Vendors of Other Analog ICs for Use in Consumer Electronics, Worldwide**  
**Revenue (Millions of U.S. Dollars)**

1996 Rank	1995 Rank	Company	1995 Revenue	1996 Revenue	1995-1996 Growth (%)	1996 Market Share (%)
1	1	Philips	499	540	8.2	30.7
2	2	NEC	174	153	-12.1	8.7
3	3	Texas Instruments	145	150	3.4	8.5
4	4	Toshiba	142	143	0.7	8.1
5	7	Hitachi	98	113	15.3	6.4
6	5	Mitsubishi	115	98	-14.8	5.6
7	6	SANYO	112	77	-31.3	4.4
8	8	Sony	93	77	-17.2	4.4
9	10	National Semiconductor	70	72	2.9	4.1
10	9	Matsushita	88	68	-22.7	3.9
11	13	Rohm	30	46	53.3	2.6
12	11	Fujitsu	56	44	-21.4	2.5
13	12	Motorola	36	31	-13.9	1.8
14	14	Sharp	24	20	-16.7	1.1
15	15	New JRC	12	18	50.0	1.0
		All Others	85	111	30.6	6.3
		<b>Total Market</b>	<b>1,779</b>	<b>1,761</b>	<b>-1.0</b>	<b>100.0</b>

Source: Dataquest (July 1997)

**Table 3-18**  
**Top 15 Vendors of Discrete Components for Use in Consumer Electronics, Worldwide**  
**Revenue (Millions of U.S. Dollars)**

1996 Rank	1995 Rank	Company	1995 Revenue	1996 Revenue	1995-1996 Growth (%)	1996 Market Share (%)
1	2	Toshiba	479	431	-10.0	13.2
2	1	Matsushita	485	424	-12.6	13.0
3	3	Philips	474	390	-17.7	11.9
4	4	NEC	384	352	-8.3	10.8
5	5	SANYO	315	287	-8.9	8.8
6	6	Mitsubishi	224	193	-13.8	5.9
7	8	Hitachi	162	156	-3.7	4.8
8	7	Motorola	188	154	-18.1	4.7
9	9	Samsung	111	130	17.1	4.0
10	10	Siemens	110	104	-5.5	3.2
11	11	SGS-Thomson	73	65	-11.0	2.0
12	12	General Instrument	56	49	-12.5	1.5
13	13	Sony	42	36	-14.3	1.1
14	14	Fujitsu	30	26	-13.3	0.8
15	15	National Semiconductor	22	9	-59.1	0.3
		All Others	528	462	-12.5	14.1
		<b>Total Market</b>	<b>3,683</b>	<b>3,268</b>	<b>-11.3</b>	<b>100.0</b>

Source: Dataquest (July 1997)

**Table 3-19**  
**Top 15 Vendors of Optoelectronics for Use in Consumer Electronics, Worldwide**  
**Revenue (Millions of U.S. Dollars)**

1996 Rank	1995 Rank	Company	1995 Revenue	1996 Revenue	1995-1996 Growth (%)	1996 Market Share (%)
1	1	Sharp	262	281	7.3	19.7
2	2	Sony	250	254	1.6	17.9
3	3	Matsushita	218	198	-9.2	13.9
4	4	Toshiba	189	161	-14.8	11.3
5	5	SANYO	102	99	-2.9	7.0
6	6	NEC	80	87	8.7	6.1
7	7	Mitsubishi	77	62	-19.5	4.4
8	8	Siemens	56	58	3.6	4.1
9	9	Temec	39	35	-10.3	2.5
10	11	Hitachi	30	26	-13.3	1.8
11	10	Hewlett-Packard	31	21	-32.3	1.5
12	12	Texas Instruments	13	12	-7.7	0.8
13	13	Fujitsu	11	9	-18.2	0.6
14	14	Motorola	6	5	-16.7	0.4
15	16	Samsung	5	5	0.0	0.4
		All Others	131	110	-16.2	7.7
		<b>Total Market</b>	<b>1,500</b>	<b>1,423</b>	<b>-5.1</b>	<b>100.0</b>

Source: Dataquest (July 1997)

Specific observations about the aforementioned top 10 companies are as follows:

- As a company, NEC has strengths in the areas of design and manufacturing digital ICs and memory. NEC is the No. 1 vendor of all consumer ICs, microcomponents and MOS Logic.
- A long-time player in the consumer electronics market, Toshiba offers an extensive line of ICs targeted at applications including audio, video, and personal electronics. Toshiba is a major vendor of memory and microcontrollers for consumer electronics applications.
- Like many of its Japanese competitors, Netherlands-based Philips is a major seller of consumer electronics equipment in addition to its semiconductor business. Philips is strongest in consumer analog semiconductors, where it holds the world's No. 1 position. The company also is one of the world's top suppliers of MOS logic ICs and discrete components to the consumer electronics industry.
- Continued strong sales of its SH line of microprocessors and microcontrollers helped Hitachi to achieve a high ranking in the consumer electronics semiconductor market. Hitachi in 1996 also was the No. 1 vendor of bipolar digital ICs for consumer electronics products.

- Of the top 10 consumer electronics semiconductor manufacturers, Matsushita is one of the most purely focused on the consumer market. In addition to its semiconductor business, Matsushita is one of world's pre-eminent consumer electronics equipment vendors, selling video and audio products under brand names including Panasonic, National, and Technics. Strong product areas for Matsushita include microcontrollers, MOS ASICs and ASSPs, analog ICs, and optoelectronics.
- SANYO was the first of the major Japanese consumer electronics firms to focus on semiconductor technology. SANYO is particularly good at selling semiconductors to niche markets. SANYO holds second place in the analog ICs for consumer electronics market.
- Sony is one of the world's top manufacturers of consumer electronics equipment. Sony is a leader in nearly every segment of the consumer audio market and is a major player in video and other products. In semiconductors, Sony is strong in optoelectronics and analog audio, reflecting its leadership in compact disc players and stereo equipment. Sony also is a major supplier of analog video ICs.
- Mitsubishi Corporation is one of the world's largest manufacturing companies and is a major supplier of consumer products ranging from big-screen televisions to air conditioners. In the consumer electronics market, Mitsubishi is a major seller of microcontrollers for consumer products.
- Sharp Electronic Corporation is one of world's top producers of MOS memory for use in consumer electronics products in large part because of its leading position in the market for mask ROM, which is used extensively in cartridges for home video game consoles. Another area where Sharp leads in is optoelectronics because of its strong sales of CCDs.
- For the second year in a row, Motorola Incorporated is the only American supplier among the top 10 consumer semiconductor sellers. Motorola is one of the leading suppliers of microcomponents for consumer applications and maintains a strong position in sales of microcontrollers, particularly 8-bit devices to that market.
- TI is the top seller of DSPs for consumer applications. The world's top producer of DSPs, TI has a broad line of devices for applications ranging from wireless communications to hard disk drives. In the consumer market, TI produces DSPs for products such as sophisticated stereos, compact disc players, and digital set-top boxes.



## Chapter 4

# MPEG and AC-3 Decompression ICs

---

### Market Scope

This chapter presents rankings for companies selling chips that decode or decompress digital audio and video. Companies ranked in this section sell decompression chips that comply with the major video and audio compression standards: MPEG-1, MPEG-2, and AC-3. Chips complying with the three standards represented 81 percent of the digital video and digital audio decompression semiconductors produced in 1996. Most of the shipment and revenue figures provided in the following tables are for sales into consumer electronics products. However, a small portion of the decompression chips were used in personal computers. In 1996, the primary market for MPEG-1 video decompression ICs was in video CD players, with the remainder used in personal computers. For MPEG-2 video decompression semiconductors, the highest volume market in 1996 was DBS set-top boxes, with DVD players and digital cable set-top boxes accounting for the remainder of sales. AC-3 decoders in 1996 were used mainly in home theater audio systems and in DVD players.

### 1996 Pricing and Technology Trends

In the MPEG-2 decompression IC market, two major trends occurred that had opposite effects on pricing. First, increased competition in the MPEG-2 decompression IC market reduced the price of video decoding functions. Second, the MPEG-2 ICs sold in 1996 were mainly of the embedded type, helping to support prices of MPEG-2 decoders. Most MPEG-2 decoders sold in 1996 integrated together video and audio decompression. This is in contrast to 1995, when MPEG-2 audio and video parts were sold as separate, standalone devices for the most part. The aggregate effect of the two opposing pricing trends has been a slight decrease in the ASP of MPEG-2 decompression ICs of just \$1.02, or 3.5 percent.

In the MPEG-1 market, a similar move to integration took place in 1996, with video and audio being combined. Because video CD was the primary driver of MPEG-1 decompression IC sales, most of the those chips sold in 1996 also included video CD-specific features, such as on-screen display. However, because a single vendor—C-Cube Microsystems—so completely dominated the video CD MPEG-1 decoder market in 1996, ASPs for those devices remained high for most of the year. The ASP of MPEG-1 decoders actually increased by \$4.08 in 1996 to \$31.62, up nearly 15 percent from \$27.54 in 1995.

### Compression IC Market Rankings

Tables 4-1 through 4-5 and Figure 4-1 rank the top sellers of both audio and video MPEG and AC-3 decompression ICs (also known as decoder ICs).

**Table 4-1**

**Top Five Vendors of MPEG and AC-3 Decoder ICs, Worldwide (Revenue in Millions of U.S. Dollars and Shipments in Thousands of Units)**

1996 Rank	1995 Rank	Company	1995 Revenue	1995 Units	1996 Revenue	1996 Units	1995-1996 Growth (%)	1996 Market Share (%)
1	2	C-Cube	80	2,600	255	7,780	218.8	48.5
2	1	SGS-Thomson	120	4,200	134	5,100	11.6	25.5
3	6	LSI Logic	4	182	60	2,100	1,400.0	11.4
4	4	Motorola	19	600	46	1,100	142.1	8.7
5	NA	ESS Technology	NA	0	17	872	NA	3.2
		All Others	48	2,035	14	675	-70.9	2.7
		<b>Total Market</b>	<b>271</b>	<b>9,617</b>	<b>526</b>	<b>17,627</b>	<b>94.1</b>	<b>100.0</b>

NA = Not available

Source: Dataquest (July 1997)

**Table 4-2**

**Top Five Vendors of MPEG-1 Decoder ICs, Worldwide (Revenue in Millions of U.S. Dollars and Shipments in Thousands of Units)**

1996 Rank	1995 Rank	Company	1995 Revenue	1995 Units	1996 Revenue	1996 Units	1995-1996 Growth (%)	1996 Market Share (%)
1	1	C-Cube	74	2,400	230	6,800	211.5	85.6
2	NA	ESS Technology	-	-	17	872	-	6.3
3	2	SGS-Thomson	35	1,400	13	600	-63.3	4.7
4	3	Motorola	19	600	7	85	-63.2	2.6
5	NA	Oak Technology	-	-	2	100	-	0.7
		Others	21	1,010	2	120	-92.3	0.7
		<b>Total Market</b>	<b>149</b>	<b>5,410</b>	<b>271</b>	<b>8,577</b>	<b>78.4</b>	<b>100.0</b>

NA = Not available

Source: Dataquest (July 1997)

**Table 4-3**

**Top Five Vendors of MPEG-2, AC-3 Decoder ICs, Worldwide (Revenue in Millions of U.S. Dollars and Shipments in Thousands of Units)**

1996 Rank	1995 Rank	Company	1995 Revenue	1995 Units	1996 Revenue	1996 Units	1995-1996 Growth (%)	1996 Market Share (%)
1	1	SGS-Thomson	85	2,800	121	4,500	42.5	47.5
2	4	LSI Logic	4	182	60	2,100	1,400.0	23.6
3	NA	Motorola	0	0	39	1,015	NA	15.3
4	3	C-Cube	6	200	25	980	308.3	9.6
5	2	Texas Instruments	13	455	6	261	-53.8	2.4
		Others	11	450	4	195	-62.5	1.6
		<b>Total Market</b>	<b>119</b>	<b>4,087</b>	<b>255</b>	<b>9,051</b>	<b>114.1</b>	<b>100.0</b>

NA = Not available

Source: Dataquest (July 1997)

**Table 4-4**

**Top Six Vendors of Standalone MPEG Decoder ICs, Worldwide (Revenue in Millions of U.S. Dollars and Shipments in Thousands of Units)**

1996 Rank	1995 Rank	Company	1995 Revenue	1995 Units	1996 Revenue	1996 Units	1995-1996 Growth (%)	1996 Market Share (%)
1	NA	C-Cube	NA	NA	24	980	NA	46.7
2	1	SGS-Thomson	103	3,360	18	750	-82.0	35.3
3	3	Texas Instruments	13	669	6	261	-53.8	11.4
4	6	Zoran	1	50	2	99	58.0	3.0
5	10	Philips	1	20	1	57	0	1.9
		Others	37	1,365	1	60	-16.2	1.6
		<b>Total Market</b>	<b>155</b>	<b>5,464</b>	<b>52</b>	<b>2,207</b>	<b>-66.2</b>	<b>100.0</b>

NA = Not available

Source: Dataquest (July 1997)

**Table 4-5**

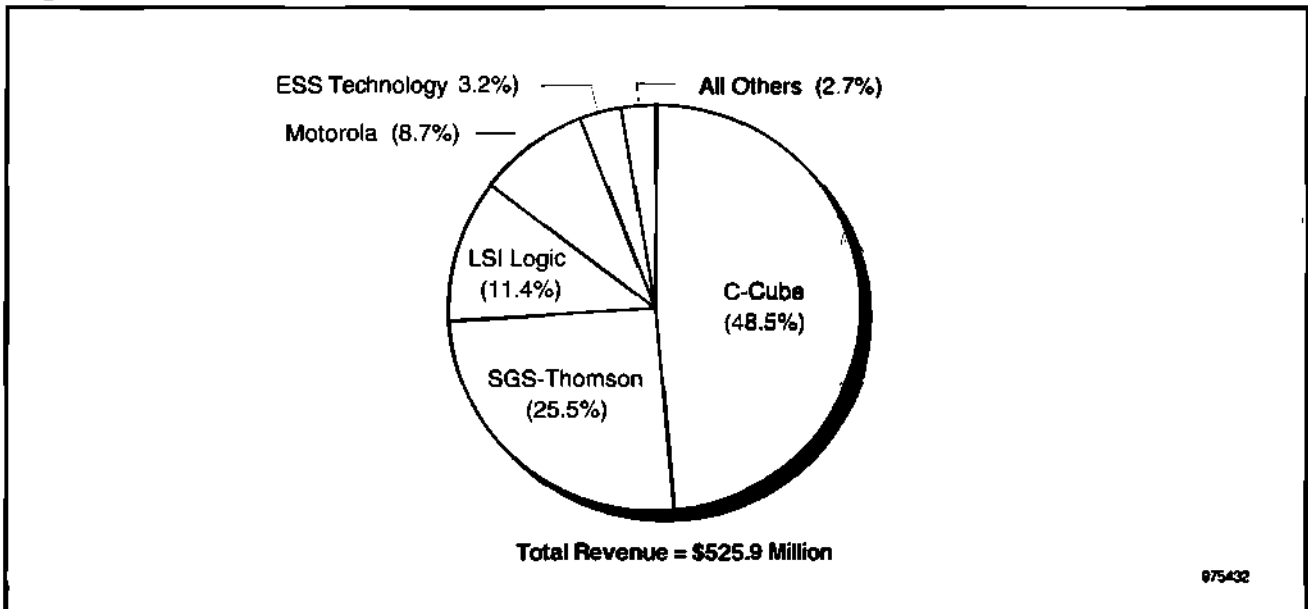
**Top Five Vendors of ICs with Embedded MPEG Decoder Functions, Worldwide (Revenue in Millions of U.S. Dollars and Shipments in Thousands of Units)**

1996 Rank	1995 Rank	Company	1995 Revenue	1995 Units	1996 Revenue	1996 Units	1995-1996 Growth (%)	1996 Market Share (%)
1	1	C-Cube	80	2,600	230	6,800	188.1	48.7
2	2	SGS-Thomson	17	840	115	4,350	578.9	24.4
3	4	LSI Logic	4	182	60	2,100	1,400.0	12.7
4	NA	Motorola	0	0	46	1,100	NA	9.7
5	NA	ESS Technology	0	0	17	872	NA	3.6
		Others	15	531	5	198	-69.7	1.0
		<b>Total Market</b>	<b>116</b>	<b>4,153</b>	<b>473</b>	<b>15,420</b>	<b>308.2</b>	<b>100.0</b>

NA = Not available

Source: Dataquest (July 1997)

**Figure 4-1**  
**Top Five Vendors of MPEG and AC-3 Decoder ICs, Worldwide Revenue**



Source: Dataquest (July 1997)

### **C-Cube Charges into the Lead**

In 1996, C-Cube came from second place to take the lead in sales of MPEG-1, MPEG-2, and AC-3 decompression chips with \$255 million in revenue and 48.8 percent market share, as presented in Table 4-1 and Figure 4-1. C-Cube's sales in this area grew by a whopping 218.8 percent in 1996. The company surpassed 1995's No. 1 vendor—SGS-Thomson—primarily on the strength of its sales of MPEG-1 decompression chips into the video CD market. C-Cube pioneered the video CD decompression chip market and throughout 1996 was the dominant supplier of MPEG-1 devices for it. Although MPEG-1 decompression IC ASPs historically have been below those of MPEG-2 decoders, C-Cube's dominant position in the market in 1996 allowed it to maintain high pricing for its video CD specific MPEG-1 decompression ICs.

As a result, the ASP of an MPEG-1 decompression chip rose to \$31.62 in 1996, up from \$27.54 in 1995. The combination of high volume and high prices allowed C-Cube to grow its MPEG-1 decompression chip revenue by 211.5 percent to reach \$231 million in 1996. On a unit basis, C-Cube sold 6.8 million MPEG-1 decompression ICs in 1996, with 5.9 million going into the video CD market and 900,000 used in personal computers.

C-Cube's dominance in video CD-oriented MPEG-1 decompression chips also resulted in the company taking the No. 1 position in embedded MPEG ICs, as shown in Table 4-5. The company sold \$230 million worth of embedded MPEG decompression ICs in 1996, up 188 percent from \$80 million in 1995. Altogether, the company controlled nearly 50 percent of the embedded MPEG decompression market in 1996.

Outside of its business in MPEG-1 decompression chips, C-Cube in 1996 expanded its presence in MPEG-2 decoders for digital DBS systems. As shown in Table 4-3, C-Cube's sales of MPEG-2 decompression ICs grew to \$25 million in 1996, up 308.3 percent from \$6 million in 1995.

### **SGS-Thomson Retains MPEG-2 Dominance**

SGS-Thomson in 1996 was the second-largest MPEG decompression chip supplier worldwide. The company maintained its leading position in MPEG-2 decoders as it continued to sell large numbers of chips into the DBS market. As shown in Table 4-3, SGS-Thomson in 1996 sold \$121 million worth of MPEG-2 decoders, giving it 47.5 percent of the market. The company experienced a 42.5 percent rise in MPEG-2 decoder IC revenue as sales of DBS set-top box continued their rapid growth during the year. It is noteworthy that SGS-Thomson, which was the first major supplier of MPEG-2 decoders to the DBS market, maintained its market dominance in 1996 despite increased competition from companies such as LSI and C-Cube. During 1996, most of SGS Thomson's customers moved from buying its standalone MPEG-2 video decoders to purchasing its embedded video/audio decoders, helping the company to maintain its ASPs.

### **LSI Breaks into the Top Ranks**

For LSI, 1996 was a breakthrough year in video decompression as it reached the No. 3 position in MPEG-1, MPEG-2, and AC-3 decoders. Starting from MPEG sales of only \$4 million in 1995, LSI in 1996 experienced explosive growth of 1,400 percent to reach \$60 million in revenue for the year, as presented in Table 4-1. The vast majority of that growth came from sales of MPEG-2 decoders used in digital DBS set-top boxes. LSI scored design wins for its MPEG-2 audio/video decoder with several DBS manufacturers, including with the EchoStar DBS service and with Hughes Network Systems for its Digital Satellite System DBS set-top box. Because LSI's MPEG-2 decoders combined audio and video functionality, the company in 1996 achieved the No. 3 position in sales of embedded MPEG-2 decoders, as shown in Table 4-5.

## Chapter 5

# Next-Generation Consumer Electronics Applications

This section presents rankings for semiconductor suppliers in next-generation consumer electronics applications. Next-generation products represent the greatest growth opportunity for semiconductor suppliers in the consumer electronics industry today. Such products exhibit a combination of fast sales increases and high semiconductor content. In 1996, next-generation consumer products consisted of DBS set-top boxes, digital cable set-top boxes, 32-/64-bit video game controllers, video CD players, digital still cameras, digital camcorders, and DVD video players. Some additional revenue was also derived in this segment by shipments into a category called "Other Next-Generation." Most of this revenue in 1996 came from chips supplied for the WebTV set-top box.

Table 5-1 presents the top 20 suppliers of chips for use in next-generation consumer electronics and Figure 5-1 illustrates the top 10 vendors of ICs in this segment. Table 5-2 shows the top 10 companies along with a summary of their revenue by specific application markets. These tables and the figure include all types of semiconductors with the exception of memory, discrete components, and optoelectronics. The revenue from shipments of chips measured in these tables total more than \$2.8 billion, which represents well more than half of the total semiconductor revenue in these markets when memory, discrete components, and optoelectronics are included.

## The Gold Rush Is On

Because of the tremendous high-growth opportunity this market represents, semiconductor companies are aggressively entering and competing in the next-generation consumer electronics market. The 32/64-bit video game controller is a major driver of the early market share success for chips. However, most of the companies in the top 10 are competing in multiple market segments. The companies that are most successful in leveraging their products into multiple segments will be in the best position for the future. Some of the notable dynamics in this market during 1996 were as follows:

- Sony was the market share leader in the market with its success driven principally by the Sony Playstation. However, Sony was an important player in six of the seven major market segments and has established a strong competitive position as the other market segments expand in the future.
- LSI Logic has pursued the consumer electronics semiconductor market very aggressively, and its efforts have allowed it to capture nearly 13 percent of this market segment and add more than \$350 million to its revenue in 1996. LSI has also established itself as a strong competitor with solid product offerings in many market segments.
- Hitachi leveraged the SH processor family into the video game controller and digital still camera market segments and captured the No. 3 position in this segment. Hitachi has invested heavily in its SH products

**Table 5-1**  
**Top 20 Vendors of ICs for Use in Next-Generation Consumer Electronics, Worldwide Revenue (Millions of U.S. Dollars)**

1996 Rank	Company	1996 Revenue	1996 Market Share (%)
1	Sony	420	14.9
2	LSI Logic	354	12.6
3	Hitachi	333	11.8
4	NEC	270	9.6
5	C-Cube	246	8.7
6	SGS-Thomson	189	6.7
7	Motorola	155	5.5
8	Toshiba	90	3.2
9	Philips	89	3.2
10	VLSI Technology	60	2.1
11*	Matsushita	47	1.7
11*	GEC Plessey	47	1.7
13**	AKM Semiconductor	42	1.5
13**	Rohm	42	1.5
15	Texas Instruments	28	1.0
16	Fujitsu	26	0.9
17	Mitsubishi	24	0.9
18	Sharp	19	0.7
19	ESS Technology	17	0.6
20	Oak Technology	16	0.6
	All Others	303	10.7
	<b>Total Market</b>	<b>2,817</b>	<b>100.0</b>

NA = Not available

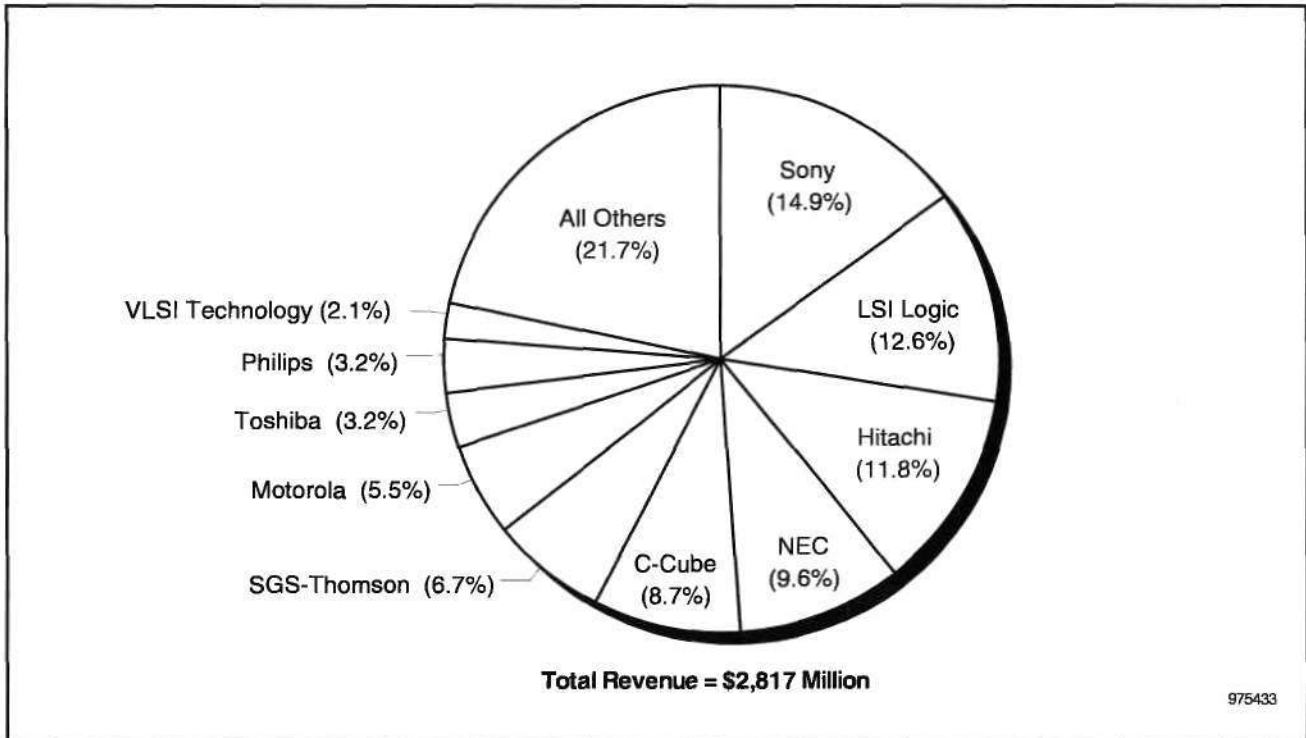
\*Matsushita and GEC Plessey tied for 1996 rank.

\*\*AKM Semiconductor and Rohm tied for 1996 rank.

Note: This revenue excludes memory, discrete components, and optoelectronics. Rank and revenue for 1995 are not available.

Source: Dataquest (July 1997)

**Figure 5-1**  
**Top 10 Vendors of ICs for Use in Next-Generation Consumer Electronics,**  
**Worldwide Revenue**



Note: This revenue excludes memory, discrete components, and optoelectronics  
 Source: Dataquest (July 1997)

and will be working to earn design wins in additional products that will help it stay on a strong growth path.

- NEC received a major boost from shipments of the Nintendo 64 at the end of 1996. It supplied both the processors and the memory for this system. (The revenue from its shipments of Rambus memory is not counted in this ranking.)
- C-Cube dominated the shipments of MPEG-1 chips for video CD players in 1996, and this propelled them into the top five in this segment. It has also been pursuing the development of chips for MPEG-2 based products. Although Dataquest predicts that the video CD market will continue to represent a strong future market opportunity, C-Cube can add to its success if it can earn important design wins in segments such as DVD video players.
- While eight of the top 10 semiconductor companies for the overall consumer electronics market are Japanese companies, the list of top players in the next-generation markets has stronger representation by companies in other regions. Four of the top 10 are Japanese companies, with four U.S. and two European companies rounding out the top 10 in next-generation consumer electronics chips. One of the key questions facing semiconductor suppliers is whether this new opportunity to compete in the next-generation markets will continue or whether the major consumer electronics manufacturers will turn back to relying on a captive, in-house chip supply.



**Table 5-2**  
**Top 10 Vendors of ICs for Use in Next-Generation Consumer Electronics by Application Market , Worldwide Revenue**  
**(Millions of U.S. Dollars)**

	Next-Generation Consumer Electronics	Digital Cable Set Top Boxes	Direct Broadcast Satellite Set Top Boxes	32/64-Bit Video Game Controllers	Video CD Players	DVD Video Players	Digital Still Cameras	Digital Camcorders (DVC)	Other Next- Generation
Sony	420.2	-	21.8	343.0	6.1	0.5	16.3	32.5	-
LSI Logic	353.8	10.0	148.0	164.0	-	0.8	-	31.0	-
Hitachi	332.7	-	-	308.5	-	-	24.2	-	-
NEC	270.0	-	-	259.4	-	0.8	-	8.2	1.6
C-Cube	246.4	0.1	15.2	-	231.0	0	-	-	-
SGS-Thomson	189.1	2.0	180.3	-	6.4	0.5	-	-	-
Motorola	155.2	26.0	71.1	32.5	4.5	0.5	5.0	14.4	1.2
Toshiba	90.0	-	-	86.1	-	1.9	-	2.0	-
Philips	88.8	2.3	51.9	7.9	24.0	-	1.0	1.1	0.6
VLSI Technology	60.3	13.3	47.0	-	-	-	-	-	-

Note: This revenue excludes memory, discrete components, and optoelectronics  
Source: Dataquest (July 1997)

The following sections present detailed market shares for semiconductor suppliers to each of the major segments in next-generation consumer electronics.

### **DBS Set-Top Boxes**

Table 5-3 presents a ranking of the top eight vendors of IC for DBS set-top boxes. SGS-Thomson in 1996 was the No. 1 player in the market, with \$180 million in revenue and 32 percent market share. SGS-Thomson's leadership in DBS chips is built on its long-standing top position in MPEG-2 decoders. However, the company also is major vendor of other DBS devices, including transport chips and microcontrollers. LSI in 1996 experienced rapid growth to emerge as the second-place vendor of DBS chips, with \$148 million in revenue and 26.3 percent market share. Like SGS-Thomson, LSI is a major vendor of MPEG-2 chips as well as other devices including demodulation semiconductors.

### **Digital Cable Set-Top Boxes**

The digital cable set-top box market is still in its infancy, with a select group of firms supplying ASICs to a small number of equipment manufacturers. Most of the ICs used in digital cable set-top boxes today are ASICs. The leading supplier in 1996 was Motorola with \$26 million in revenue and 34 percent market share. GEC Plessey Semiconductors was second with \$18 million in revenue and 23.7 percent market share (see Table 5-4).

### **32/64-Bit Video Game Controllers**

The 32/64-bit video game controller market accounted for more than 50 percent of the semiconductor revenue derived by semiconductor companies in the next-generation market segment. Sony holds the No. 1 position in this market based on the chips it supplies to the Sony Playstation. The success of the Playstation in 1996 also drove the success of LSI Logic, which is ranked No. 4 based on its shipments of its MIPS processor into this system. Hitachi supplies two SH-2 processors and one SH-1 processor for the Sega Saturn. Shipments of the Saturn in 1996 provided a major boost for Hitachi's revenue for its SH family. With the introduction of the Nintendo 64 at the end of 1996, NEC was rewarded not only for its MIPS processor shipments and graphics coprocessor, but for its Rambus memory in this system, as well. The revenue for the memory chips is not captured in these rankings. The overall market shares are shown in Table 5-5.

### **Video CD Players**

C-Cube was the dominant presence in the video CD market in 1996 with its MPEG-1 chip. A combination of strong shipments and an actual increase in the average selling price for its chipset over 1995 enabled C-Cube to capture nearly two-thirds of the semiconductor revenue in this segment (see Table 5-6). Philips was another important player in this market with its strong portfolio of chips for optical storage. ESS Technology Inc. moved into the market aggressively during 1996 and had strong momentum moving into 1997.

**Table 5-3**  
**Top Eight Vendors of Semiconductors for Use in DBS Set-Top Boxes**  
**(Millions of U.S. Dollars)**

1996 Rank	Company	1996 Revenue	1996 Market Share (%)
1	SGS-Thomson	180	29.9
2	LSI Logic	148	24.5
3	Motorola	71	11.8
4	Philips	52	8.6
5	VLSI Technology	47	7.8
6	GEC Plessey	27	4.5
7	Sony	22	3.6
8	C-Cube	15	2.5
	All Others	41	6.8
	<b>Total Market</b>	<b>604</b>	<b>100.0</b>

NA = Not available

Note: This revenue excludes memory, discrete components, and optoelectronics. Rank and revenue for 1995 are not available.

Source: Dataquest (July 1997)

**Table 5-4**  
**Top Four Vendors of Semiconductors for Digital Cable Set-Top Boxes**  
**(Millions of U.S. Dollars)**

1996 Rank	Company	1996 Revenue	1996 Market Share (%)
1	Motorola	26	34.1
2	GEC Plessey	18	23.6
3	VLSI Technology	13	17.5
4	LSI Logic	10	13.1
	All Others	9	11.7
	<b>Total Market</b>	<b>76</b>	<b>100.0</b>

NA = Not available

Note: This revenue excludes memory, discrete components, and optoelectronics. Rank and revenue for 1995 are not available.

Source: Dataquest (July 1997)

**Table 5-5**  
**Top 10 Vendors of Semiconductors for 32-/64-Bit Video Game Controllers**  
**(Millions of U.S. Dollars)**

1996 Rank	Company	1996 Revenue	1996 Market Share (%)
1	Sony	343	24.0
2	Hitachi	309	21.6
3	NEC	259	18.2
4	LSI Logic	164	11.5
5	Toshiba	86	6.0
6	Rohm	42	2.9
7	AKM Semiconductor	40	2.8
8	Motorola	33	2.3
9	New JRC	15	1.1
10	Yamaha	11	0.7
	All Others	128	9.0
	<b>Total Market</b>	<b>1,429</b>	<b>100.0</b>

NA = Not available

Note: This revenue excludes memory, discrete components, and optoelectronics. Rank and revenue for 1995 are not available.

Source: Dataquest (July 1997)

**Table 5-6**  
**Top Eight Vendors of Semiconductors for Video CD Players (Millions of U.S. Dollars)**

1996 Rank	Company	1996 Revenue	1996 Market Share (%)
1	C-Cube	231	62.1
2	Philips	24	6.5
3	ESS Technology	17	4.6
4	Oak Technology	16	4.3
5	SGS-Thomson	6	1.7
6	Sony	6	1.6
7	Motorola	5	1.2
8	Texas Instruments	3	0.8
	All Others	64	17.2
	<b>Total Market</b>	<b>372</b>	<b>100.0</b>

NA = Not available

Note: This revenue excludes memory, discrete components, and optoelectronics. Rank and revenue for 1995 are not available.

Source: Dataquest (July 1997)

### Digital-Still Cameras

The heavy processing requirements in digital-still cameras require powerful microcontrollers that are among the most expensive components in a digital-still camera. Thus, the leading chip suppliers to the digital still camera market in 1996 were vendors of fast, 32-bit RISC microcontrollers. Hitachi took the No. 1 position with \$24 million in revenue and 26 percent market share, mainly because of sales of its SH microcontroller and secondarily because of sales of image processing ASICs. Fujitsu came in a close second with \$21 million in revenue and 22 percent market share because of sales of its SPARC Lite microcontroller and associated ASICs (see Table 5-7).

### Digital Camcorders

As a major supplier of chips to both its own Panasonic products and to the JVC digital camcorder, Matsushita garnered the top position in this market with a 20.4 percent share. The combined shipments of the JVC and Panasonic digital camcorders represented more than 50 percent of the market in 1996. Sony was another supplier that benefited from supplying key chips for digital camcorders apart from its own product (see Table 5-8).

### DVD Video Players

The first DVD video players were introduced to the market in Japan at the end of 1996. Production of these products only reached 65,000 during the year. However, there were some limited chip shipments in anticipation of the emerging 1997 market. The Pioneer player with its combination DVD/laser disc (LD) capability captured more than half of the market in its early stages and drove the chip shipments of Pioneer Communications of America Inc., NEC, Motorola, Zoran Corporation, and Sony. The only other players on the market were supplied by Toshiba and Matsushita. These players employed in-house chipset solutions and accounted for the semiconductor revenue of Toshiba and Matsushita in this segment. The semiconductor market shares in this nascent market are shown in Table 5-9.

**Table 5-7**  
**Top Six Vendors of Semiconductors for Digital Still Cameras (Millions of U.S. Dollars)**

1996 Rank	Company	1996 Revenue	1996 Market Share (%)
1	Hitachi	24	26.1
2	Fujitsu	21	22.2
3	Sony	16	17.7
4	Mitsubishi	6	6.9
5	Motorola	5	5.4
6	Texas Instruments	5	5.4
	All Others	15	16.2
	<b>Total Market</b>	<b>92</b>	<b>100.0</b>

NA = Not available

Note: This revenue excludes memory, discrete components, and optoelectronics. Rank and revenue for 1995 are not available.

Source: Dataquest (July 1997)

**Table 5-8**  
**Top 11 Vendors of Semiconductors for Digital Camcorders (Millions of U.S. Dollars)**

1996 Rank	Company	1996 Revenue	1996 Market Share (%)
1	Matsushita	46	20.4
2	Sony	33	14.5
3	LSI Logic	31	13.8
4	Mitsubishi	18	7.8
5	Motorola	14	6.4
6	Texas Instruments	12	5.3
7	Sharp	11	4.7
8	NEC	8	3.6
9	Fujitsu	6	2.6
10	SANYO	2	0.9
11	Toshiba	2	0.9
	All Others	43	19.1
	<b>Total Market</b>	<b>225</b>	<b>100.0</b>

NA = Not available

Note: This revenue excludes memory, discrete components, and optoelectronics. Rank and revenue for 1995 are not available.

Source: Dataquest (July 1997)

**Table 5-9**  
**Top 10 Vendors of Semiconductors for DVD Video Players (Millions of U.S. Dollars)**

1996 Rank	Company	1996 Revenue	1996 Market Share (%)
1	Pioneer	2.6	23.0
2	Toshiba	1.9	16.3
3	Matsushita	1.5	12.7
4	LSI Logic	0.8	7.0
5	NEC	0.8	6.7
6	Zoran	0.7	6.3
7*	Motorola	0.5	4.3
7*	Sony	0.5	4.3
9	SGS-Thomson	0.4	3.9
10	SANYO	0.2	1.7
	All Others	1.6	13.8
	<b>Total Market</b>	<b>11.5</b>	<b>100.0</b>

NA = Not available

\*Motorola and Sony tied for 1996 rank.

Note: This revenue excludes memory, discrete components, and optoelectronics. Rank and revenue for 1995 are not available.

Source: Dataquest (July 1997)

## Chapter 6

# Market Participation Tables

Table 6-1 is a matrix illustrating which companies offer various types of MPEG semiconductors. In both tables, each x signifies that a company garnered revenue from a particular product type in 1995. Table 6-2 is a matrix illustrating which companies are involved in the various product segments constituting the consumer electronics semiconductor market.

**Table 6-1**  
**Matrix of Company Participation in Various MPEG Product Segments**

	MPEG-1 Decoder ICs	MPEG-2, AC-3 Decoder ICs	Standalone MPEG Decoder ICs	ICs with Embedded MPEG Decoder Functions
C-Cube	X	X	X	X
ESS Technology	X	-		X
LSI Logic	-	X	-	X
Motorola	X	X	-	X
Oak Technology	X	-		X
Texas Instruments	-	X	X	
Zoran	-	X	X	
Sony	X	X	X	X
Philips	X	X	X	X
SGS-Thomson	X	X	X	X
Hyundai	-	X	-	X

Source: Dataquest (July 1997)

**Table 6-2**  
**Matrix of Company Participation in Various Consumer Electronics Semiconductor Product Segments**

	Bipolar Digital ICs	MOS Memory	Micro- processors	Micro- controllers	Micro- peripherals	Digital Signal Processors	MOS ASICs/ ASSPs	Analog Audio ICs	Analog Video ICs	Other Analog ICs	Discrete Components	Opto- electronics
<b>Americas Companies</b>												
Advanced Micro Devices	-	X	-	-	-	-	-	-	-	-	-	-
Analog Devices	-	-	-	-	-	X	-	X	X	X	-	-
Rockwell/Brooktree	-	-	-	-	-	-	-	-	X	-	-	-
C-Cube	-	-	-	-	-	-	X	-	-	-	-	-
Dallas Semiconductor	-	-	-	X	-	-	-	-	-	-	-	-
Ess Technology	-	-	-	-	-	-	X	-	-	-	-	-
General Instrument	-	-	-	-	-	-	-	-	-	-	X	-
Hewlett Packard	-	-	-	-	-	-	X	-	-	-	X	X
IBM	-	X	X	-	-	-	X	-	-	-	-	-
Integrated Device Technology	-	-	-	X	-	-	-	-	-	-	-	-
Intel	-	X	X	X	-	-	-	-	-	-	-	-
Linear Technology	-	-	-	-	-	-	-	X	X	-	-	-
LSI Logic	-	-	-	-	-	-	X	-	-	-	-	-
Microchip Technology	-	X	-	X	X	-	-	-	-	-	-	-
Motorola	X	X	X	X	X	X	X	X	X	X	X	X
Symbios	-	-	-	-	-	-	X	-	-	-	-	-
National Semiconductor	X	X	X	X	X	-	-	X	X	X	X	-
Oak Technology	-	-	-	-	-	-	X	-	-	-	-	-
Texas Instruments	X	X	X	X	X	X	X	X	X	X	X	X
TDK	-	-	-	-	-	-	X	-	-	-	-	-
VLSI Technology	-	-	-	-	-	-	X	-	-	-	-	-
Zapex Technologies	-	-	-	-	-	-	-	-	-	-	-	-
ZILOG	-	-	X	X	X	X	-	-	-	-	-	-
Zoran	-	-	-	-	-	-	X	-	-	-	-	-
<b>Japanese Companies</b>												
AKM Semiconductor	-	-	-	-	-	-	-	-	-	X	-	-
Fujitsu	X	X	X	X	X	-	X	X	X	X	X	X
Hitachi	X	X	X	X	X	X	X	X	X	X	X	X
Matsushita	X	X	-	X	X	-	X	X	X	X	X	X
Mitsubishi	X	X	-	X	X	-	X	X	X	X	X	X



**Table 6-2 (Continued)**  
**Matrix of Company Participation in Various Consumer Electronics Semiconductor Product Segments**

	Bipolar Digital ICs	MOS Memory	Micro- processors	Micro- controllers	Micro- peripherals	Digital Signal Processors	MOS ASICs/ ASSPs	Analog Audio ICs	Analog Video ICs	Other Analog ICs	Discrete Components	Opto- electronics
NEC	X	X	X	X	X	X	X	X	X	X	X	X
New JRC	-	-	-	-	-	-	-	-	-	-	-	-
Oki	X	X	X	X	X	-	X	X	X	X	X	X
Pioneer	-	-	-	-	-	-	X	-	-	-	-	-
Ricoh	-	-	-	-	-	-	X	-	-	-	-	-
Rohm	-	-	-	-	-	-	-	-	-	-	X	-
SANYO	-	X	-	X	-	X	X	X	X	X	X	X
Seiko Epson	-	X	-	X	-	-	X	-	-	X	-	-
Sharp	-	X	X	X	X	-	X	X	X	X	-	X
Sony	-	X	-	X	X	-	X	X	X	X	X	X
Toshiba	X	X	X	X	X	X	X	X	X	X	X	X
Yamaha	-	X	-	-	-	-	X	-	-	-	-	-
<b>European Companies</b>												
GEC Plessey	-	-	-	-	-	X	X	-	X	-	-	-
Philips	-	-	-	X	-	-	X	X	X	X	X	-
SGS-Thomson	-	X	X	X	X	-	X	X	X	X	X	-
Siemens	X	X	-	X	-	-	-	X	X	-	X	X
Temic	-	-	-	X	-	-	X	-	X	-	-	X
<b>Asia/Pacific Companies</b>												
Daewoo	-	-	-	X	-	-	X	X	X	-	-	-
LG Semicon	X	X	-	X	X	-	X	-	-	-	-	-
Hyundai	-	X	-	-	-	-	X	-	-	-	-	-
Samsung	-	X	-	X	X	-	X	X	X	-	X	X
United Microelectronics	-	X	-	-	X	-	-	-	-	-	-	-

Source: Dataquest (July 1997)

---

**For More Information...**

Dale Ford, Senior Industry Analyst..... (408) 468-8311  
Internet address ..... dale.ford@dataquest.com  
Via fax ..... (408) 954-1780  
Dataquest Interactive..... <http://www.dataquest.com>

The content of this report represents our interpretation and analysis of information generally available to the public or released by responsible individuals in the subject companies, but is not guaranteed as to accuracy or completeness. It does not contain material provided to us in confidence by our clients. Reproduction or disclosure in whole or in part to other parties shall be made upon the written and express consent of Dataquest.

©1997 Dataquest—Reproduction Prohibited

Dataquest is a registered trademark of A.C. Nielsen Company

**Dataquest**  
A Gartner Group Company

## DATAQUEST WORLDWIDE OFFICES

### NORTH AMERICA

#### Worldwide Headquarters

251 River Oaks Parkway  
San Jose, California 95134-1913  
United States  
Phone: 1-408-468-8000  
Facsimile: 1-408-954-1780

#### East Coast Research Center

Nine Technology Drive  
P.O. Box 5093  
Westborough, Massachusetts 01581-5093  
United States  
Phone: 1-508-871-5555  
Facsimile: 1-508-871-6262

#### Dataquest Global Events

3990 Westerly Place, Suite 100  
Newport Beach, California 92660  
United States  
Phone: 1-714-476-9117  
Facsimile: 1-714-476-9969

### EUROPE

#### European Headquarters

Tamesis, The Glanty  
Egham, Surrey TW20 9AW  
United Kingdom  
Phone: +44 1784 431 611  
Facsimile: +44 1784 488 980

#### Dataquest France

Immeuble Défense Bergères  
345, avenue Georges Clémenceau  
TSA 40002  
92882 - Nanterre CTC Cedex 9  
France  
Phone: +33 1 41 35 13 00  
Facsimile: +33 1 41 35 13 13

#### Dataquest Germany

Martin-Kollar-Strasse 15  
D-81829 München  
Germany  
Phone: +49 89 42 70 4-0  
Facsimile: +49 89 42 70 4-270

### JAPAN

#### Japan Headquarters

Aobadai Hills 4-7-7  
Aobadai  
Meguro-ku, Tokyo 153  
Japan  
Phone: 81-3-3481-3670  
Facsimile: 81-3-3481-3644

### ASIA/PACIFIC

#### Asia/Pacific Headquarters

Suite 5904-7, Central Plaza  
18 Harbour Road, Wanchai  
Hong Kong  
Phone: 852-2824-6168  
Facsimile: 852-2824-6138

#### Dataquest Korea

Suite 2407, Trade Tower  
159 Samsung-dong, Kangnam-gu  
Seoul 135-729  
Korea  
Phone: 822-551-1331  
Facsimile: 822-551-1330

#### Dataquest Taiwan

11F-2, No. 188, Section 5  
Nan King East Road  
Taipei  
Taiwan, R.O.C.  
Phone: 8862-756-0389  
Facsimile: 8862-756-2663

#### Dataquest Singapore

105 Cecil Street  
#06-01/02 The Octagon  
Singapore 069534  
Phone: 65-227-1213  
Facsimile: 65-227-4607

#### Dataquest Thailand

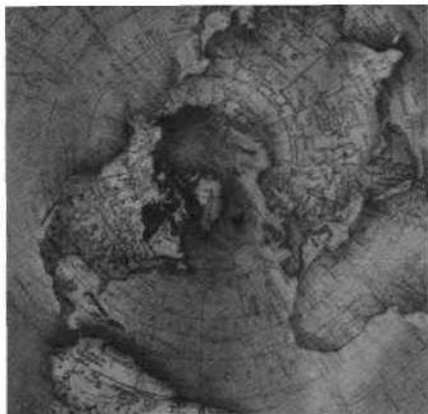
12/F, Vanessa Building  
29 Soi Chidlom  
Ploenchit Road  
Patumwan, Bangkok 10330  
Thailand  
Phone: 662-655-0577  
Facsimile: 662-655-0576

#### Dataquest Australia

80 Alfred Street  
Milsons Point NSW 2061  
Australia  
Phone: 61-2-9941-4860  
Facsimile: 61-2-9941-4868

# Dataquest

A Gartner Group Company



FILE COPY:  
MARIA VALENZUELA

**Dataquest**

# **MPUs and MCUs Battle for the Hearts of Next-Generation Consumer Products**



**Competitive Trends**

---

**Program:** Consumer Multimedia Semiconductors and Applications Worldwide  
**Product Code:** MSAM-WW-CT-9701  
**Publication Date:** May 19, 1997  
**Filing:** Reports

# **MPUs and MCUs Battle for the Hearts of Next-Generation Consumer Products**



## **Competitive Trends**

---

**Program:** Consumer Multimedia Semiconductors and Applications Worldwide  
**Product Code:** MSAM-WW-CT-9701  
**Publication Date:** May 19, 1997  
**Filing:** Reports

## Table of Contents

---

	Page
1. Executive Summary .....	1
Advanced MPUs and MCUs Find Life beyond the PC .....	1
2. Potential Market Growth Puts Stars in Chipmakers' Eyes.....	3
3. MIPS Surges into Market Share Lead Past SH .....	9
MPU/MCU Market Shares by System.....	12
Digital Cable Set-Top Boxes .....	12
Digital Satellite Set-Top Boxes.....	12
32-/64-Bit Video Game Controllers.....	13
Video CD Players .....	15
Digital Still Cameras.....	15
Digital Camcorders.....	15
DVD Video Players.....	15
Other Next-Generation Products.....	15
4. Microprocessor Architectures in Next-Generation Products .....	17
MIPS .....	17
Super-H.....	19
68000 Family .....	19
microSPARC and Java .....	21
ARM/StrongARM .....	22
PowerPC .....	22
Pentium II.....	22
16-Bit MPU/MCUs .....	23
5. Dataquest Predicts.....	25

## List of Figures

Figure	Page
2-1 Forecast of 16-/32-/64-Bit MPU/MCU Chip Shipments and System Shipments in Next-Generation Consumer Electronics	6
2-2 Forecast of 16-Bit and 32-/64-Bit MPU/MCU Chip Shipments in Next-Generation Consumer Electronics .....	7
3-1 1996 MPU/MCU Chip Unit Market Share in Next-Generation Consumer Electronics .....	10
3-2 1996 MPU/MCU System Unit Market Share in Next-Generation Consumer Electronics .....	10
3-3 1995 and 1996 MPU/MCU Chip Unit Shipments in Next-Generation Consumer Electronics .....	11
3-4 1995 and 1996 MPU/MCU System Unit Shipments by MPU/MCU Type in Next-Generation Consumer Electronics .....	11
3-5 1996 MPU/MCU Chip Unit Market Share in Digital Cable Set-Top Boxes .....	12
3-6 1996 MPU/MCU Chip Unit Market Share in Direct Broadcast Satellite Set-Top Boxes .....	13
3-7 1996 MPU/MCU System Unit Market Share in 32/64-Bit Video Game Controllers .....	14
3-8 1996 MPU/MCU Chip Unit Market Share in 32-/64-Bit Video Game Controllers .....	14
3-9 1996 MPU/MCU Chip Unit Market Share in Video CD Players ....	16
3-10 1996 MPU/MCU Chip Unit Market Share in Digital Cameras .....	16
4-1 1996 MIPS MPU/MCU Chip Unit Shipments by System Type .....	18
4-2 MIPS MPU/MCU Chip Unit Shipments .....	18
4-3 1996 SH MPU/MCU Chip Unit Shipments by System Type .....	20
4-4 1996 32-bit 68K MPU/MCU Chip Unit Shipments by System Type .....	20
4-5 1996 16-Bit MPU/MCU Chip Unit Shipments by System Type .....	23

## List of Tables

---

Table	Page
2-1 Next-Generation Consumer Electronics System Unit Shipment Forecast (Thousands of Units) .....	4
2-2 Forecast of 16-/32-/64-Bit MPU/MCU Chip Shipments in Next-Generation Consumer Electronics.....	5
2-3 Forecast of 16-Bit and 32-/64-bit MPU/MCU Chip Shipments in Next-Generation Consumer Electronics.....	5
3-1 1995 and 1996 MPU/MCU Market Share Comparison in Next-Generation Consumer Electronics.....	9



## List of Tables

---

Table	Page
2-1 Next-Generation Consumer Electronics System Chip Shipment Forecast (Thousands of Units) .....	4
2-2 Forecast of 16-/32-/64-Bit MPU/MCU Chip Shipments in Next-Generation Consumer Electronics.....	5
2-3 Forecast of 16-Bit and 32-/64-bit MPU/MCU Chip Shipments in Next-Generation Consumer Electronics.....	5
3-1 1995 and 1996 MPU/MCU Market Share Comparison in Next-Generation Consumer Electronics.....	9

## Chapter 1

# Executive Summary

---

### Advanced MPUs and MCUs Find Life beyond the PC

For semiconductor manufacturers, the most exciting portion of the consumer electronics market today is a set of digital platforms that Dataquest has defined as "next-generation" consumer electronics. Next-generation consumer products include digital cable set-top boxes, direct broadcast satellite (DBS) set-top boxes, digital still cameras, digital camcorders, digital TV (DTV) receivers, video CD players, DVD players, and 32- and 64-bit video game consoles. These products have a much more valuable semiconductor content than traditional consumer devices, making use of powerful signal processing elements and advanced microcomponents such as 16-, 32-, and 64-bit microcontrollers (MCUs) and microprocessors (MPUs). In many cases, next-generation consumer products use microcomponents that until recently could only be found in high-performance workstations and supercomputers.

Because of the high value of the semiconductors inside these chips, the chip market in next-generation consumer electronics is forecast to experience much higher growth. The compound annual growth rate (CAGR) between 1995 and 2000 for semiconductors in next-generation products is projected to be more than 55 percent. Consequently, the next-generation consumer market is one of the most coveted and fought-over portions of the semiconductor industry today. A single microcomponent design-win in a next-generation consumer product can generate huge volumes and revenue for a semiconductor company. Hitachi, for example, has two SH-2 MPUs and one SH-1 MCU designed into each Sega Saturn game console. That single design-win takes most of the credit for making the Super-H (SH) series one of the most popular RISC architecture in the world during 1995 and 1996. Shipments of MPU/MCU products into next-generation consumer electronics account for more than 75 percent of all SH processors and almost 90 percent of all MIPS processor shipments during 1996.

Next-generation design-wins have become such a point of pride for semiconductor companies that they make major announcements surrounding them with a degree of vigor formerly reserved only for the PC industry. Recent examples of this include:

- NEC's design-win for its two MIPS-based ASICs in the Nintendo 64
- LSI's Logic design-win for its MIPS-based chip in the Sony Playstation
- SPARC's design-win in the Scientific-Atlanta digital cable set-top box
- The design-win competition in Video CD players between C-Cube Microsystems and ESS Technology

This report focuses on 16-, 32-, and 64-bit MPUs and MCUs in next-generation consumer electronics. A forecast of the future market growth is presented along with market shares for shipments of MPU/MCU products based on major architectures. An evaluation of the shipments of these MPU/MCU chips and ASIC/ASSP cores in specific systems is also

provided. Applications covered include digital cable set-top boxes, direct broadcast satellite (DBS) set-top boxes, digital still cameras, digital camcorders, digital TV (DTV) receivers, video CD players, DVD players, and 32- and 64-bit video game consoles.

Shipments of 16-, 32-, and 64-bit MPU and MCU chips into next-generation consumer electronics grew by over 300 percent in 1996. Shipments of MPUs and MCUs into this market benefited from the growth of the 32- and 64-bit video game controller market during 1996, with over 56 percent of MPUs and MCUs in next-generation products going into the video game controller segment. Total 16-, 32-, and 64-bit MPU/MCU shipments into next-generation consumer electronics are forecast to reach almost 150 million units by 2001. Riding the success of the Nintendo 64 and Sony Playstation systems, the MIPS architecture captured 32 percent of the 1996 MPU/MCU chip unit market share in next-generation consumer systems, with almost 17 million chip unit shipments. Shipments of SH processors came in second with 26 percent market share and 13.7 million chip unit shipments.

## Chapter 2

# Potential Market Growth Puts Stars in Chipmakers' Eyes

With the increasing levels of systems integration in next-generation products, the discrete MPU or MCU is becoming an endangered species. The latest chip designs targeted at this market incorporate various system elements, including MCUs, MPUs, signal processing elements, interface logic, and embedded memory, among others. With 32-bit and 64-bit processors integrated into reduced chip-set solutions, even the functions of 4- and 8-bit MPUs and MCUs are being swallowed up. Acknowledging this system level integration trend, the chip shipment forecasts in this report include both discrete chips as well as MPU and MCU cores in larger ASIC/ASSP designs.

Also, it is increasingly difficult to label a processor as an MCU or MPU. Depending on the presence of ROM memory for code storage or the particular function being performed, a processor could easily be categorized as an MPU or MCU. Therefore, this report will analyze MPUs and MCUs collectively.

To provide a frame of reference, the current system shipment forecast for next-generation consumer electronics is presented in Table 2-1. The total number of next-generation system shipments tripled from 1995 to 1996 and is forecast to grow by more than 33 percent CAGR through 2001. As many of these systems include two or three MCUs and/or MPUs, an effective multiplier is applied to the system shipments and results in even higher growth of MPU/MCU shipments between 1995 and 1996. Shipments of these chips grew by over 300 percent in 1996, as seen in Table 2-2 and Figure 2-1. With increasing integration and more powerful processors, this multiplier effect will decrease over the forecast period. Total 16-, 32-, and 64-bit MPU/MCU shipments into next-generation consumer electronics are forecast to reach almost 150 million units by 2001.

Shipments of 16-, 32-, and 64-bit MPUs and MCUs benefited from the growth of the 32- and 64-bit video game controller market during 1996, with over 56 percent of MPUs and MCUs in next-generation products going into the video game controller segment. While the video game segment continues to experience strong growth, the market opportunity for MPUs and MCUs over the next five years will become less dependent on the video game market and more diversified as shipments of other systems continue to grow. By 2001, less than 24 percent of MPUs and MCUs shipped in next-generation products will be consumed by video games.

Table 2-3 and Figure 2-2 show the increasing shift to more powerful 32- and 64-bit processors at the expense of 16-bit processors in next-generation products. The unit shipments of advanced processors in next-generation consumer electronics will surpass microprocessor shipments in PCs during this forecast period. However, the much higher average prices of the MPUs in PCs will continue to give dominance in semiconductor revenue to the PC segment.

**Table 2-1**  
**Next-Generation Consumer Electronics System Chip Shipment Forecast (Thousands of Units)**

Electronics System	1993	1994	1995	1996	1997	1998	1999	2000	2001	CAGR (%) 1996-2001
Digital Cable Set-Top Box	8	20	63	437	1,500	3,199	6,447	10,405	15,711	104.7
Digital Satellite Set-Top Box	0	873	2,840	6,579	9,655	12,903	15,295	20,255	26,872	32.5
32-/64-Bit Video Game Controller*	100	1,570	5,123	16,000	24,000	28,000	26,000	26,000	27,000	11.0
DVD Video Player	0	0	0	65	1,720	4,469	10,322	15,424	21,000	217.6
Video CD Player	38	685	1,950	7,000	12,000	15,200	17,500	18,000	18,300	21.2
Digital Still Camera	0	30	254	1,100	1,914	4,153	4,984	5,981	7,100	45.2
Digital Camcorder	0	59	208	966	1,711	3,123	4,808	6,061	7,672	51.4
Digital TV	0	0	0	0	0	11	104	626	3,699	NA
Analog (Muse) HDTV	12	23	88	210	100	50	25	0	0	-100.0
Other Next-Generation Systems*	0	0	0	58	400	1,000	2,500	5,000	8,000	167.9
<b>Total Next-Generation Systems</b>	<b>158</b>	<b>3,260</b>	<b>10,527</b>	<b>32,415</b>	<b>53,000</b>	<b>72,109</b>	<b>87,985</b>	<b>107,753</b>	<b>135,354</b>	<b>33.1</b>

\* Preliminary forecast update  
 NA = Not applicable  
 Source: Dataquest (May 1997)

*"chip" should  
 not be in title  
 error*

## Chapter 2

# Potential Market Growth Puts Stars in Chipmakers' Eyes

With the increasing levels of systems integration in next-generation products, the discrete MPU or MCU is becoming an endangered species. The latest chip designs targeted at this market incorporate various system elements, including MCUs, MPUs, signal processing elements, interface logic, and embedded memory, among others. With 32-bit and 64-bit processors integrated into reduced chip-set solutions, even the functions of 4- and 8-bit MPUs and MCUs are being swallowed up. Acknowledging this system level integration trend, the chip shipment forecasts in this report include both discrete chips as well as MPU and MCU cores in larger ASIC/ASSP designs.

Also, it is increasingly difficult to label a processor as an MCU or MPU. Depending on the presence of ROM memory for code storage or the particular function being performed, a processor could easily be categorized as an MPU or MCU. Therefore, this report will analyze MPUs and MCUs collectively.

To provide a frame of reference, the current system shipment forecast for next-generation consumer electronics is presented in Table 2-1. The total number of next-generation system shipments tripled from 1995 to 1996 and is forecast to grow by more than 33 percent CAGR through 2001. As many of these systems include two or three MCUs and/or MPUs, an effective multiplier is applied to the system shipments and results in even higher growth of MPU/MCU shipments between 1995 and 1996. Shipments of these chips grew by over 300 percent in 1996, as seen in Table 2-2 and Figure 2-1. With increasing integration and more powerful processors, this multiplier effect will decrease over the forecast period. Total 16-, 32-, and 64-bit MPU/MCU shipments into next-generation consumer electronics are forecast to reach almost 150 million units by 2001.

Shipments of 16-, 32-, and 64-bit MPUs and MCUs benefited from the growth of the 32- and 64-bit video game controller market during 1996, with over 56 percent of MPUs and MCUs in next-generation products going into the video game controller segment. While the video game segment continues to experience strong growth, the market opportunity for MPUs and MCUs over the next five years will become less dependent on the video game market and more diversified as shipments of other systems continue to grow. By 2001, less than 24 percent of MPUs and MCUs shipped in next-generation products will be consumed by video games.

Table 2-3 and Figure 2-2 show the increasing shift to more powerful 32- and 64-bit processors at the expense of 16-bit processors in next-generation products. The unit shipments of advanced processors in next-generation consumer electronics will surpass microprocessor shipments in PCs during this forecast period. However, the much higher average prices of the MPUs in PCs will continue to give dominance in semiconductor revenue to the PC segment.

**Table 2-1**  
**Next-Generation Consumer Electronics System Unit Shipment Forecast (Thousands of Units)**

Electronics System	1993	1994	1995	1996	1997	1998	1999	2000	2001	CAGR (%) 1996-2001
Digital Cable Set-Top Box	8	20	63	437	1,500	3,199	6,447	10,405	15,711	104.7
Digital Satellite Set-Top Box	0	873	2,840	6,579	9,655	12,903	15,295	20,255	26,872	32.5
32-/64-Bit Video Game Controller*	100	1,570	5,123	16,000	24,000	28,000	26,000	26,000	27,000	11.0
DVD Video Player	0	0	0	65	1,720	4,469	10,322	15,424	21,000	217.6
Video CD Player	38	685	1,950	7,000	12,000	15,200	17,500	18,000	18,300	21.2
Digital Still Camera	0	30	254	1,100	1,914	4,153	4,984	5,981	7,100	45.2
Digital Camcorder	0	59	208	966	1,711	3,123	4,808	6,061	7,672	51.4
Digital TV	0	0	0	0	0	11	104	626	3,699	NA
Analog (Muse) HDTV	12	23	88	210	100	50	25	0	0	-100.0
Other Next-Generation Systems*	0	0	0	58	400	1,000	2,500	5,000	8,000	167.9
<b>Total Next-Generation Systems</b>	<b>158</b>	<b>3,260</b>	<b>10,527</b>	<b>32,415</b>	<b>53,000</b>	<b>72,109</b>	<b>87,985</b>	<b>107,753</b>	<b>135,354</b>	<b>33.1</b>

\* Preliminary forecast update

NA = Not applicable

Source: Dataquest (May 1997)

**Table 2-2****Forecast of 16-/32-/64-Bit MPU/MCU Chip Shipments in Next-Generation Consumer Electronics (Thousands of Units)**

Electronics System	1993	1994	1995	1996	1997	1998	1999	2000	2001	CAGR (%) 1996-2001
Digital Cable Set-Top Box	8	20	63	437	1,500	3,199	6,447	10,405	15,711	104.7
Digital Satellite Set-Top Box	0	873	2,840	6,579	9,655	12,903	15,295	20,255	26,872	32.5
32-/64-Bit Video Game Controller	200	3,399	10,500	33,200	43,500	44,800	39,000	36,400	35,100	1.1
DVD Video Player	0	0	0	130	3,440	8,714	16,515	20,052	23,100	181.8
Video CD Player	38	685	1,950	7,000	12,000	15,200	17,500	18,000	18,300	21.2
Digital Still Camera	0	30	254	1,100	1,914	4,153	4,984	5,981	7,100	45.2
Digital Camcorder	0	236	790	2,859	4,622	7,184	9,616	9,698	9,974	28.4
Digital TV	0	0	0	0	0	11	104	626	3,699	NA
Analog (Muse) HDTV	12	23	88	210	100	50	25	0	0	-100.0
Other Next-Generation Systems	0	0	0	58	400	1,000	2,500	5,000	8,000	167.9
<b>Total Next-Generation Systems</b>	<b>258</b>	<b>5,267</b>	<b>16,486</b>	<b>51,573</b>	<b>77,131</b>	<b>97,215</b>	<b>111,987</b>	<b>126,417</b>	<b>147,856</b>	<b>23.4</b>

NA = Not applicable

Source: Dataquest (May 1997)

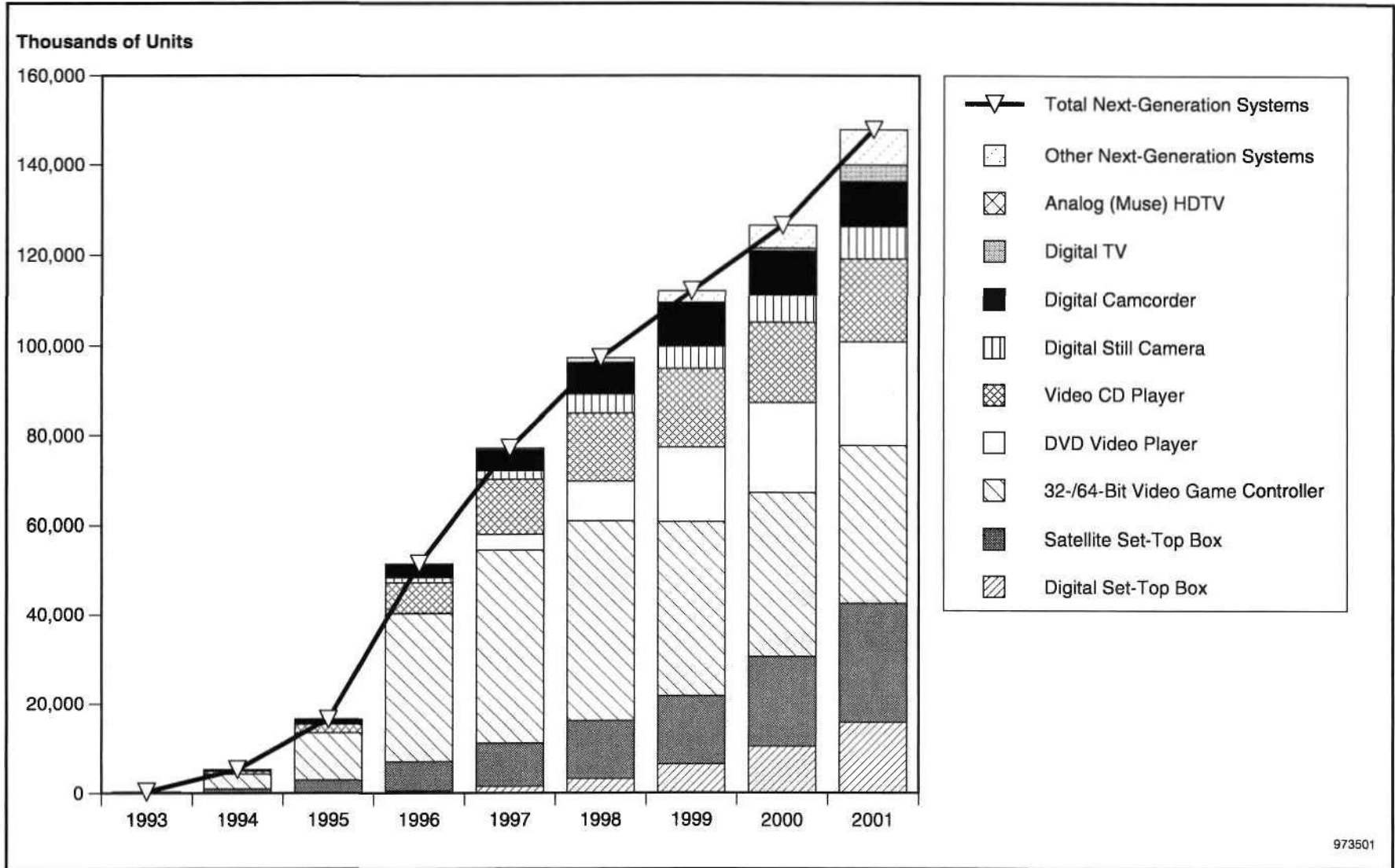
**Table 2-3****Forecast of 16-Bit and 32-/64-bit MPU/MCU Chip Shipments in Next-Generation Consumer Electronics (Thousands of Units)**

Chip	1993	1994	1995	1996	1997	1998	1999	2000	2001	CAGR (%) 1996-2001
32-Bit (and Higher) MPU/MCU	146	3,526	11,186	39,812	63,922	86,128	105,138	121,666	145,683	29.6
16-bit MPU/ MCU	112	1,741	5,300	11,764	13,208	11,087	6,848	4,751	2,173	-28.7
<b>Total MPU / MCU Shipments</b>	<b>258</b>	<b>5,267</b>	<b>16,486</b>	<b>51,573</b>	<b>77,131</b>	<b>97,215</b>	<b>111,987</b>	<b>126,417</b>	<b>147,856</b>	<b>23.4</b>

Source: Dataquest (May 1997)

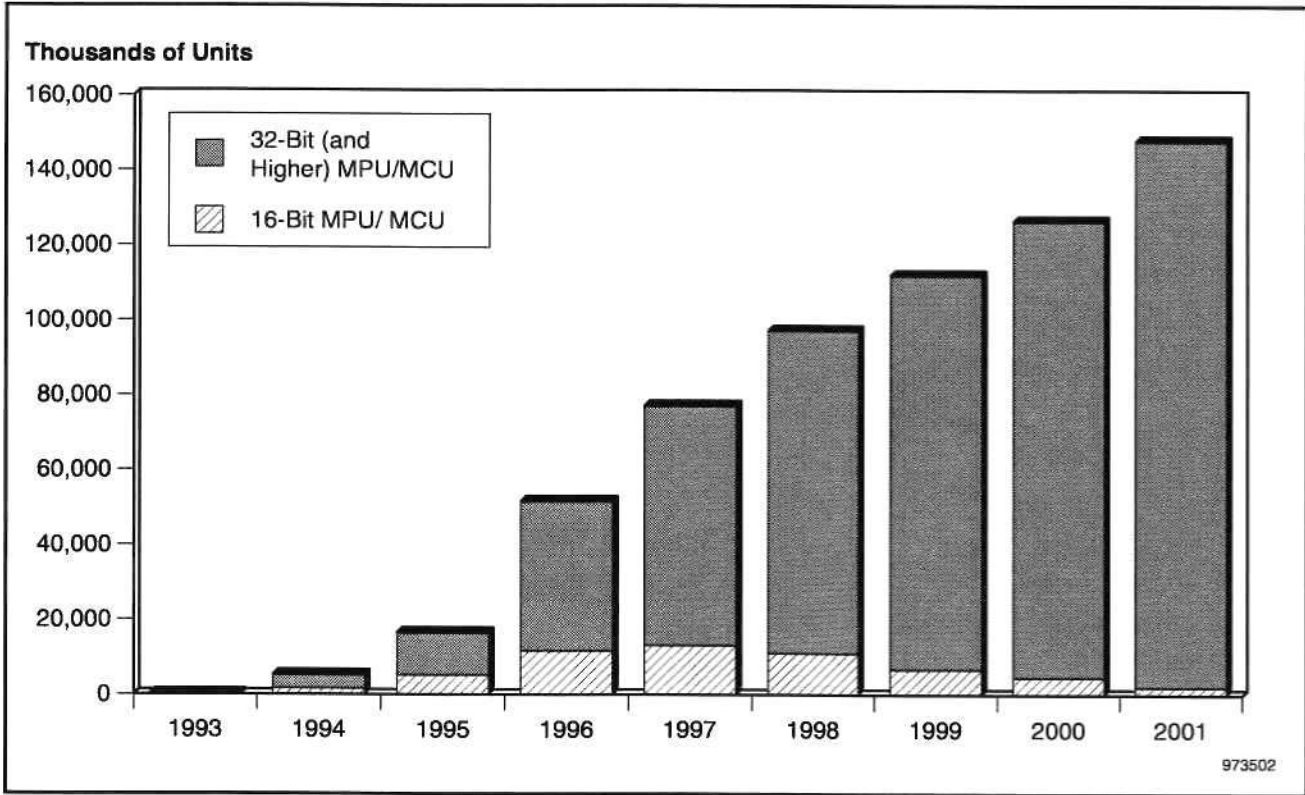


**Figure 2-1**  
**Forecast of 16-/32-/64-Bit MPU/MCU Chip Shipments and System Shipments in Next-Generation Consumer Electronics**  
**(Thousands of Units)**



Source: Dataquest (May 1997)

**Figure 2-2**  
**Forecast of 16-Bit and 32-/64-Bit MPU/MCU Chip Shipments in Next-Generation Consumer Electronics (Thousands of Units)**



Source: Dataquest (May 1997)

973502

## Chapter 3

# MIPS Surges into Market Share Lead Past SH

Riding the success of the Nintendo 64 and Sony Playstation systems, the MIPS architecture captured 32 percent of the 1996 MPU/MCU chip unit market share in next-generation consumer systems, with almost 17 million chip unit shipments (see Table 3-1 and Figure 3-1). Shipments of SH processors came in second with 26 percent market share and 13.7 million chip unit shipments. However, these market share numbers are impacted significantly by the fact that there are three SH processors in each Sega Saturn and two MIPS processors in each Nintendo 64. Based on system unit shipment numbers counted by processor architecture, the SH processor market share drops to 13 percent with shipments in 4.9 million systems, while the MIPS architecture improves slightly to a 36 percent share with shipments in almost 13 million systems (see Figure 3-2).

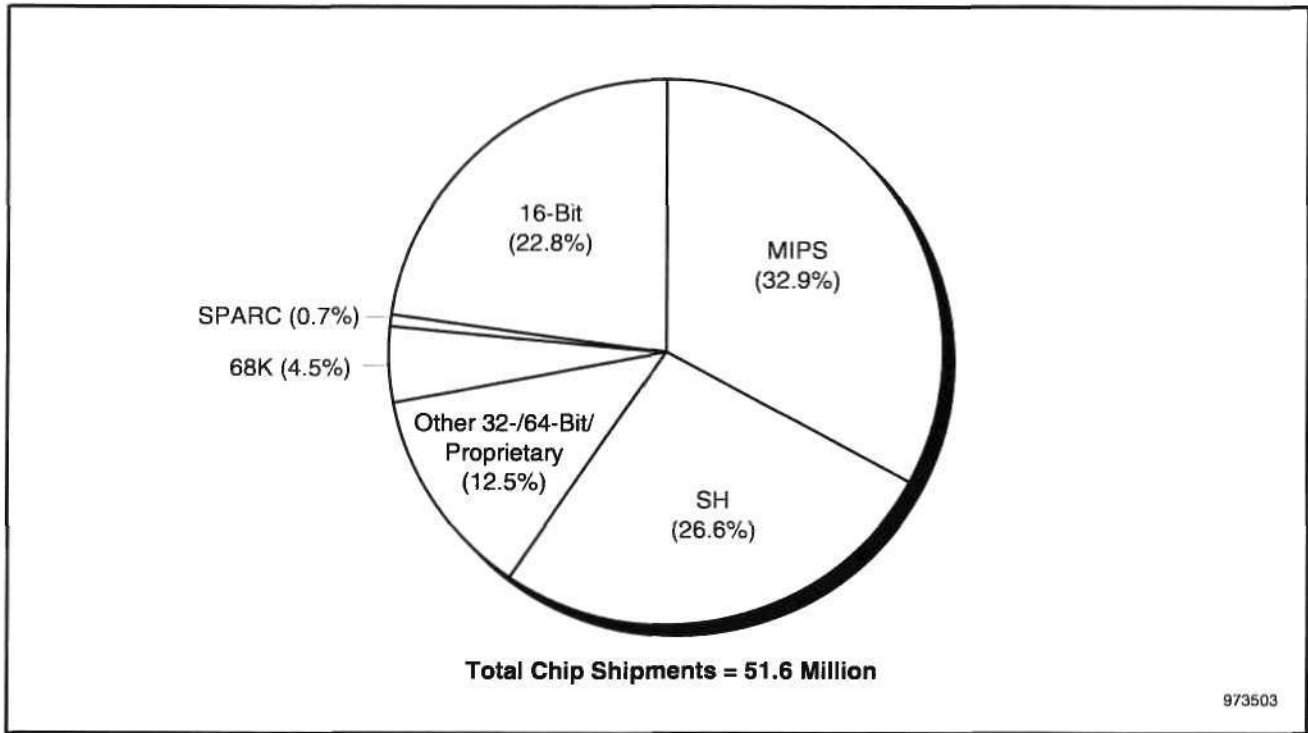
While the MIPS architecture jumped into the lead by increasing shipments into next-generation products by over 14 million units, all MCU/MPU architectures experienced strong growth during 1996, as shown in both Figures 3-3 and 3-4. Shipments of SH processors into this segment grew by 8.2 million units in 1996. SPARC-based processor shipments grew the most on a percentage basis with an increase of over 950 percent in 1996 to pass the MIPS growth of 600 percent. The growth in "Other 32-/64-Bit/Proprietary" processors comes almost entirely from the success of the proprietary C-Cube architecture in video CD systems.

**Table 3-1**  
**1995 and 1996 MPU/MCU Market Share Comparison in Next-Generation Consumer Electronics**

Architecture	1995 System Shipments (K)	1996 System Shipments (K)	1996 System Market Share (%)	1995 Chip Shipments (K)	1996 Chip Shipments (K)	1996 Chip Market Share (%)
MIPS	2,828	12,950	35.1	2,828	16,950	32.9
SH	1,935	4,906	13.3	5,500	13,706	26.6
68K	244	2,349	6.4	244	2,349	4.5
SPARC	50	341	0.0	50	341	0.7
16-bit	4,718	9,873	26.8	5,301	11,766	22.8
PowerPC	0	9	0	0	9	0
ARM / Strong ARM	261	0	0	261	0	0
x86	61	0	0	61	0	0
Others*	2,237	6,451	17.5	2,237	6,451	12.5
Total	12,338	36,880	100.0	16,486	51,573	100.0

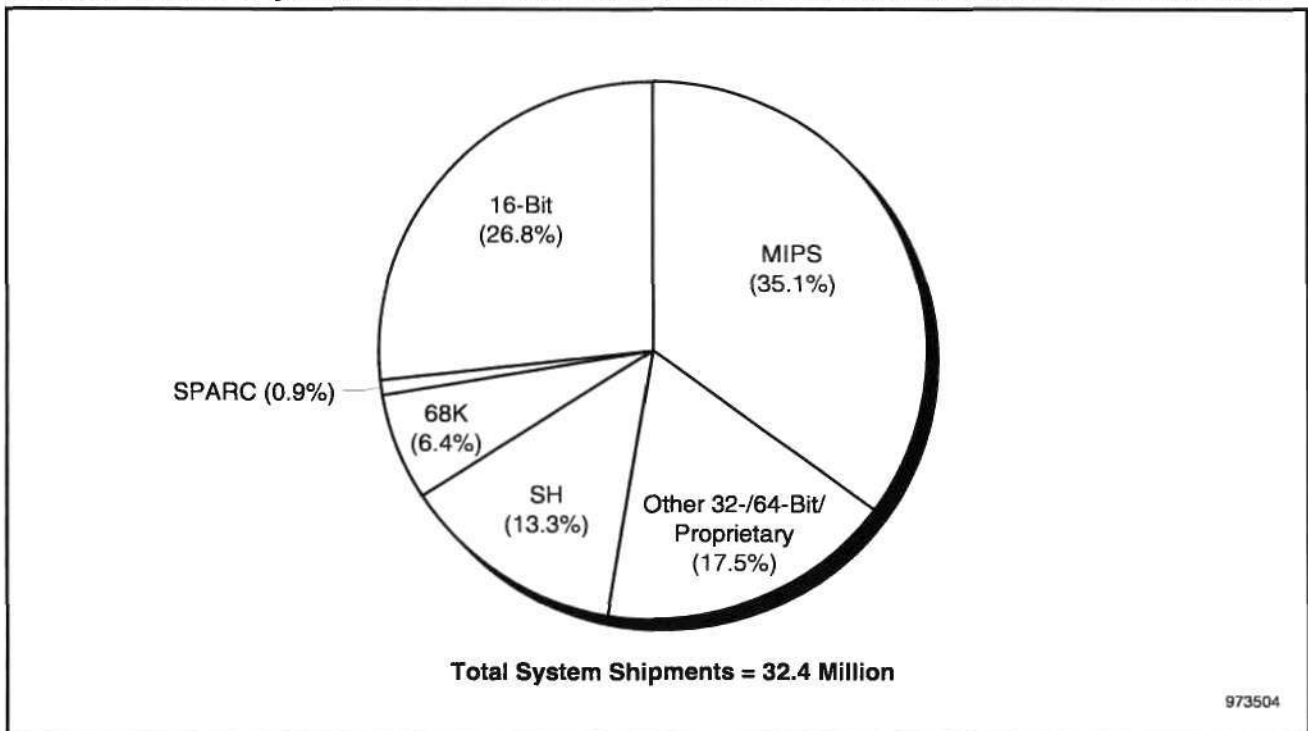
\* 32-/64-bit and proprietary architectures  
 Source: Dataquest (May 1997)

**Figure 3-1**  
**1996 MPU/MCU Chip Unit Market Share in Next-Generation Consumer Electronics**



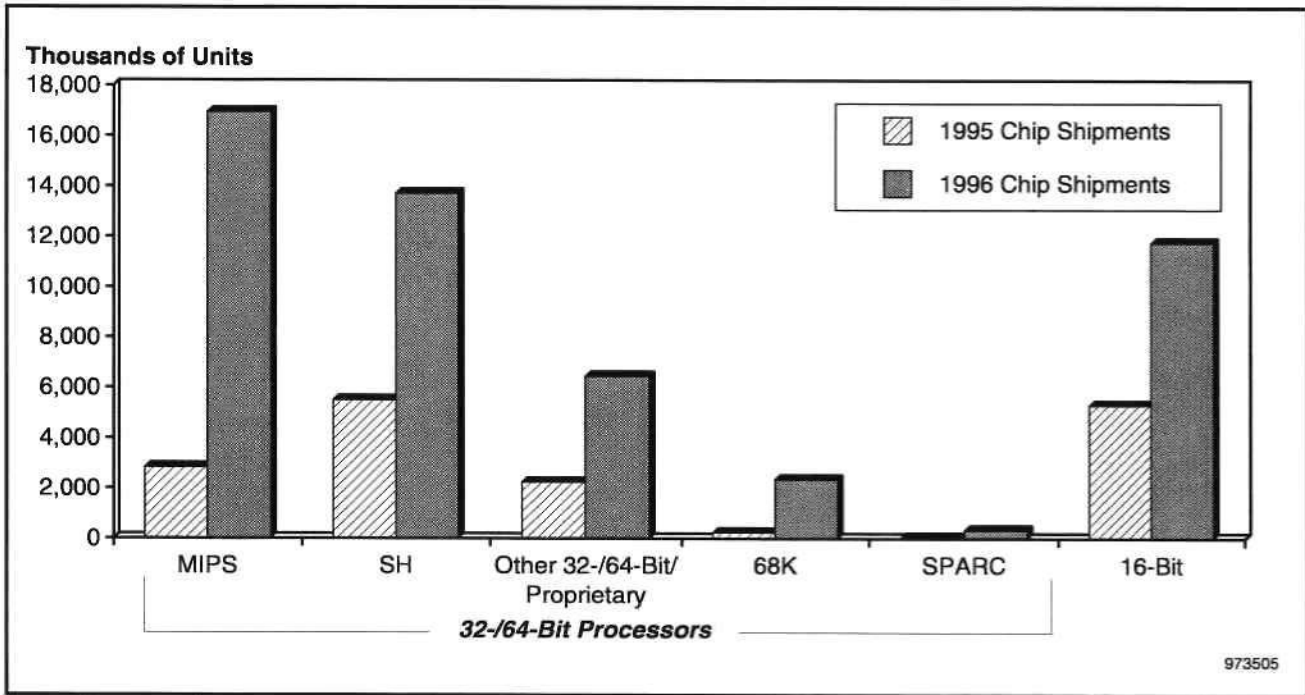
Source: Dataquest (May 1997)

**Figure 3-2**  
**1996 MPU/MCU System Unit Market Share in Next-Generation Consumer Electronics**



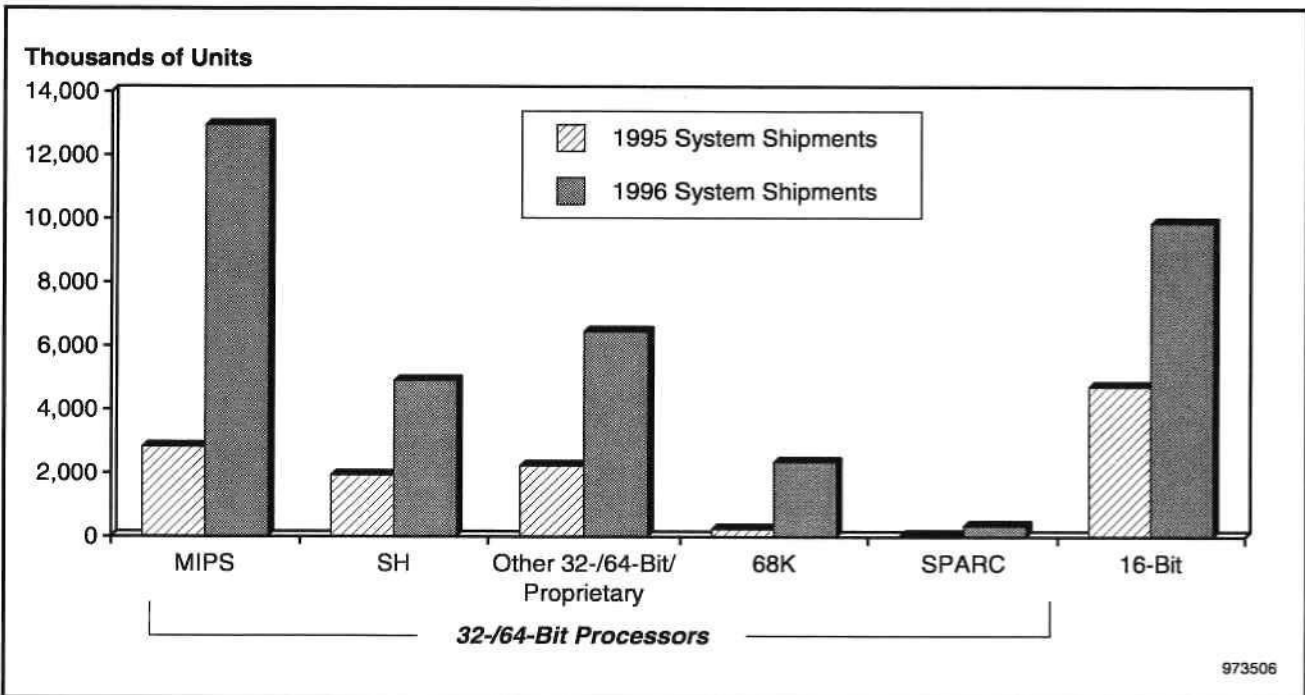
Source: Dataquest (May 1997)

**Figure 3-3**  
**1995 and 1996 MPU/MCU Chip Unit Shipments in Next-Generation Consumer Electronics**



Source: Dataquest (May 1997)

**Figure 3-4**  
**1995 and 1996 MPU/MCU System Unit Shipments by MPU/MCU Type in Next-Generation Consumer Electronics**



Source: Dataquest (May 1997)

## MPU/MCU Market Shares by System

Shipments of MPUs and MCUs into video game controllers heavily influence the overall market share numbers because of the relative size of the different next-generation consumer electronics system categories. The relative strength of the processor architectures on a system-by-system basis is shown in the following sections.

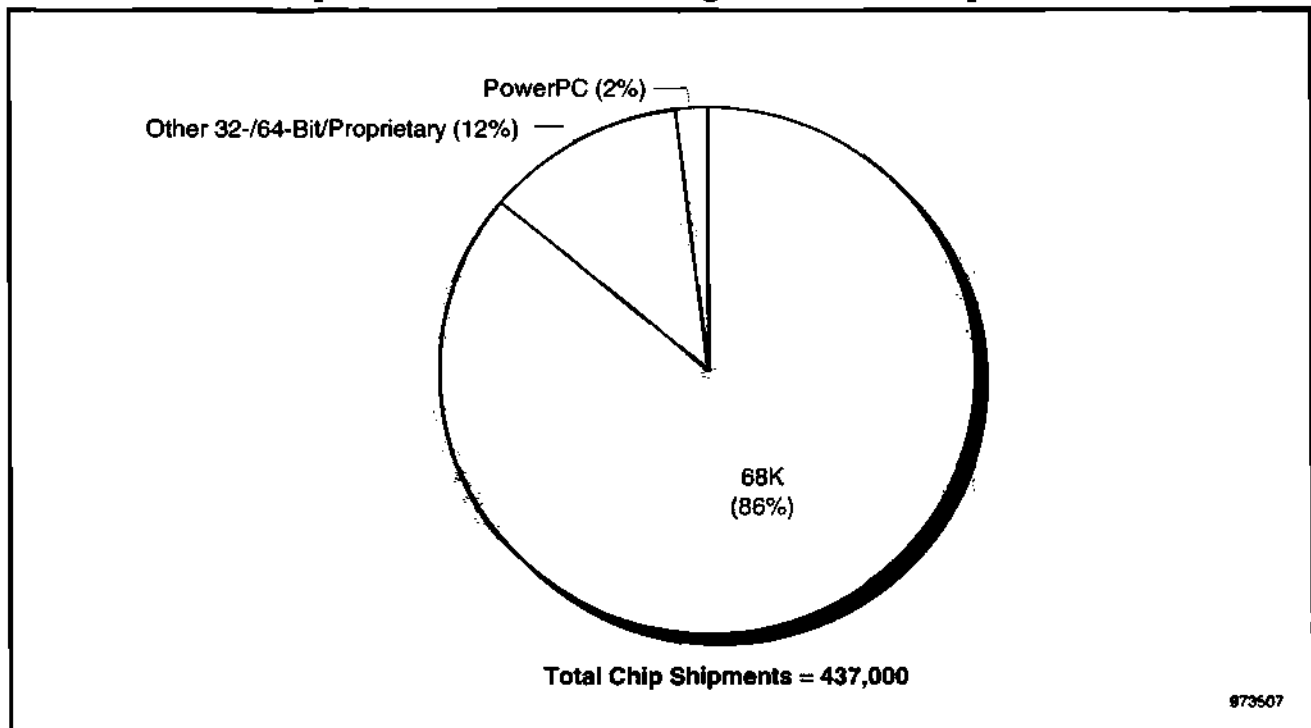
### Digital Cable Set-Top Boxes

With the digital cable set-top box market still in its early stages in 1996, manufacturers in Europe and in the United States opted to use the familiar 32-bit 68000 series from Motorola for system control, on-screen display, and data services. As seen in Figure 3-5, the 68000 architecture captured 86 percent of the 16-/32-/64-bit MPU/MCU market share in this segment. A few PowerPC-based boxes were produced for digital cable trials.

### Digital Satellite Set-Top Boxes

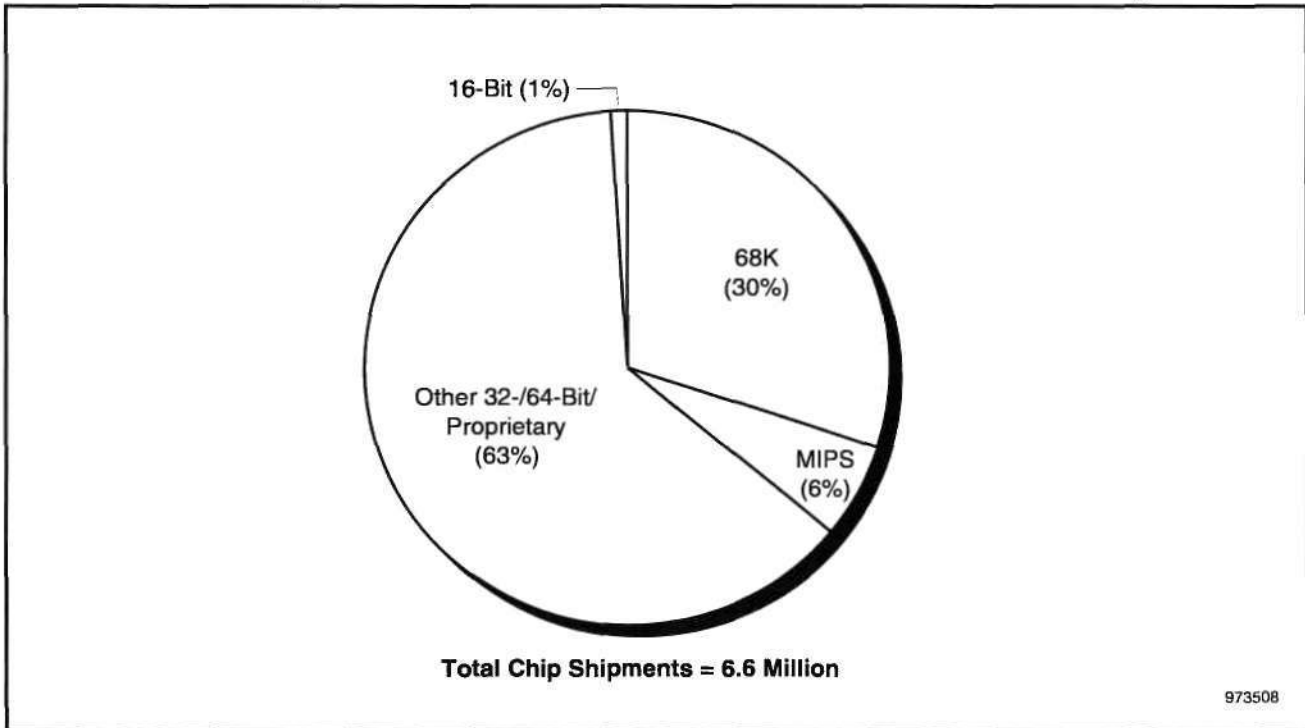
Because of the stringent cost requirements in the digital satellite set-top box market, the majority of systems that shipped in 1996 used 16-bit microcontrollers for system control and on-screen display, primarily those chips manufactured by SGS-Thomson and Motorola. In the 32-bit realm, microprocessors derived from Motorola's 68000 series dominated, while the MIPS R3041 made a strong debut in EchoStar's DISH line of satellite set-top boxes. The MPU/MCU market shares are shown in Figure 3-6.

**Figure 3-5**  
1996 MPU/MCU Chip Unit Market Share in Digital Cable Set-Top Boxes



Source: Dataquest (May 1997)

**Figure 3-6**  
**1996 MPU/MCU Chip Unit Market Share in Direct Broadcast Satellite Set-Top Boxes**



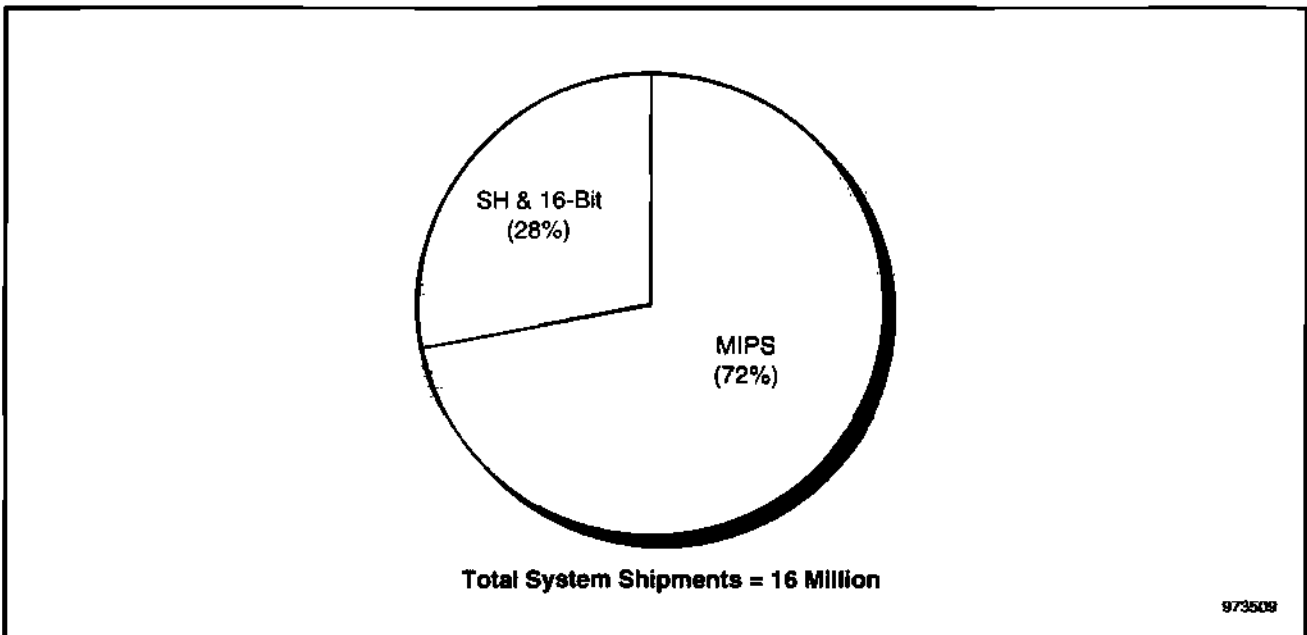
Source: Dataquest (May 1997)

### 32-/64-Bit Video Game Controllers

Both the Nintendo 64 and Sony Playstation employ MIPS processors in their systems while the Sega Saturn employs the SH architecture. The strong shipments of the Nintendo and Sony systems are shown in Figure 3-7, which measures market share based on system shipments. Based on processor shipments, the MIPS architecture still captures 47 percent of this segment as seen in Figure 3-8. The Nintendo Virtual Boy is also based on a MIPS processor, but the shipments of this system are not included in the next-generation category. The Virtual Boy has not had a strong market presence to date. With its roots in the Silicon Graphics workstation, the MIPS architecture is an extremely strong solution for products that demand strong graphics and 3-D processing.

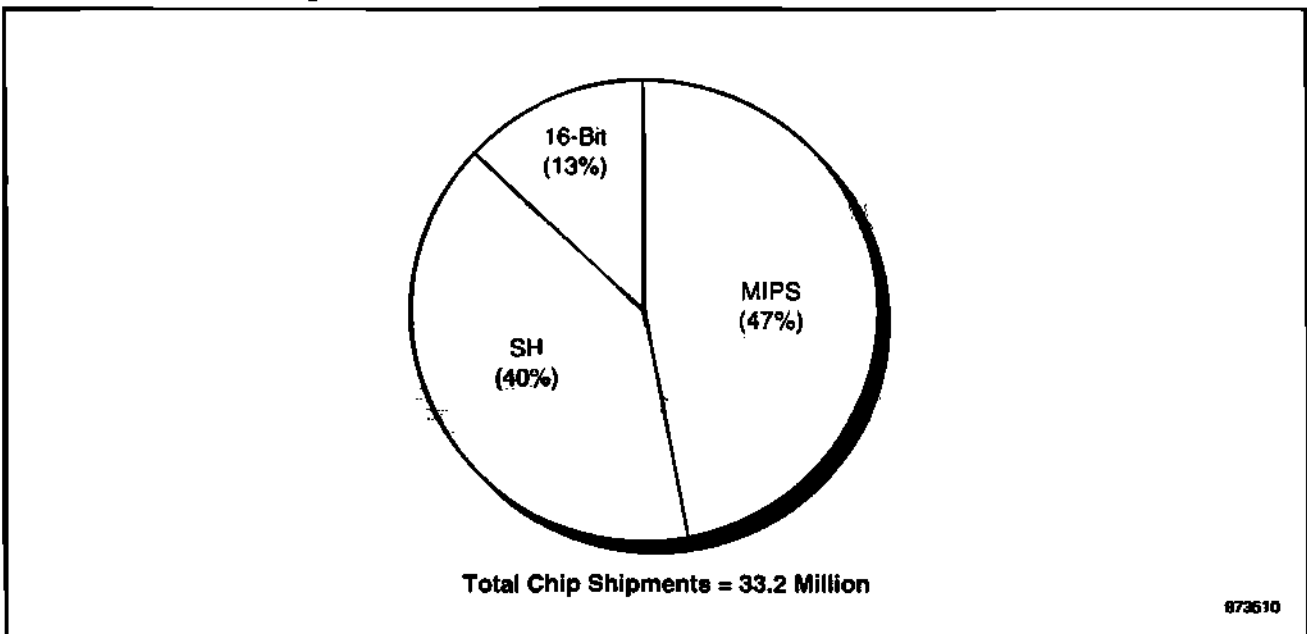
The position of the SH processor in this segment could be in jeopardy. Shipments of the Sega Saturn have lagged behind the other systems, and the overall cost structure of the Sega system has left it unable to compete on system price in the video game segment. Rumors have swirled for over a year that the PowerPC would displace the SH processor in the Sega system. However, the latest threat to the SH position in Sega comes from the development of a 3-D media processor chipset to be developed by 3Dfx Interactive. Filings with the Securities and Exchange Commission (SEC) indicate that this processor could be used in the next Sega platform.

**Figure 3-7**  
**1996 MPU/MCU System Unit Market Share in 32/64-Bit Video Game Controllers**



Source: Dataquest (May 1997)

**Figure 3-8**  
**1996 MPU/MCU Chip Unit Market Share in 32-/64-Bit Video Game Controllers**



Note: Both MIPS and SH represent 32-/64-bit chips.

Source: Dataquest (May 1997)



### **Video CD Players**

During most of 1996, C-Cube Microsystems enjoyed the dominant presence in the video CD segment. Chipset solutions that incorporate its proprietary architecture shipped in over 85 percent of the systems. This is reflected in Figure 3-9. Toward the end of 1996, strong competition sprang up from ESS Technology. The ESS Technology video CD chip incorporates a MIPS-based processor. Entering 1997, both companies were battling for design-wins among the major system manufacturers in China, Japan, and other Asia/Pacific countries.

### **Digital Still Cameras**

Many digital still cameras make use of 32-bit RISC microprocessors to assist with image compression and processing. Key design-wins have helped Hitachi's SH and Fujitsu's SPARClike to emerge as the two main microprocessors in the digital still camera market in 1996, as shown in Figure 3-10.

### **Digital Camcorders**

The digital camcorders shipping to the market in 1996 were from Sony, Sharp, JVC, and Matsushita. All of these systems were based on two to four 16-bit processors and were fairly low integration solutions. With the need to reduce the cost of these products, Dataquest expects future solutions to employ higher levels of integration and fewer and more powerful MCUs and MPUs. Some of the major players in this segment have been Mitsubishi and LSI Logic.

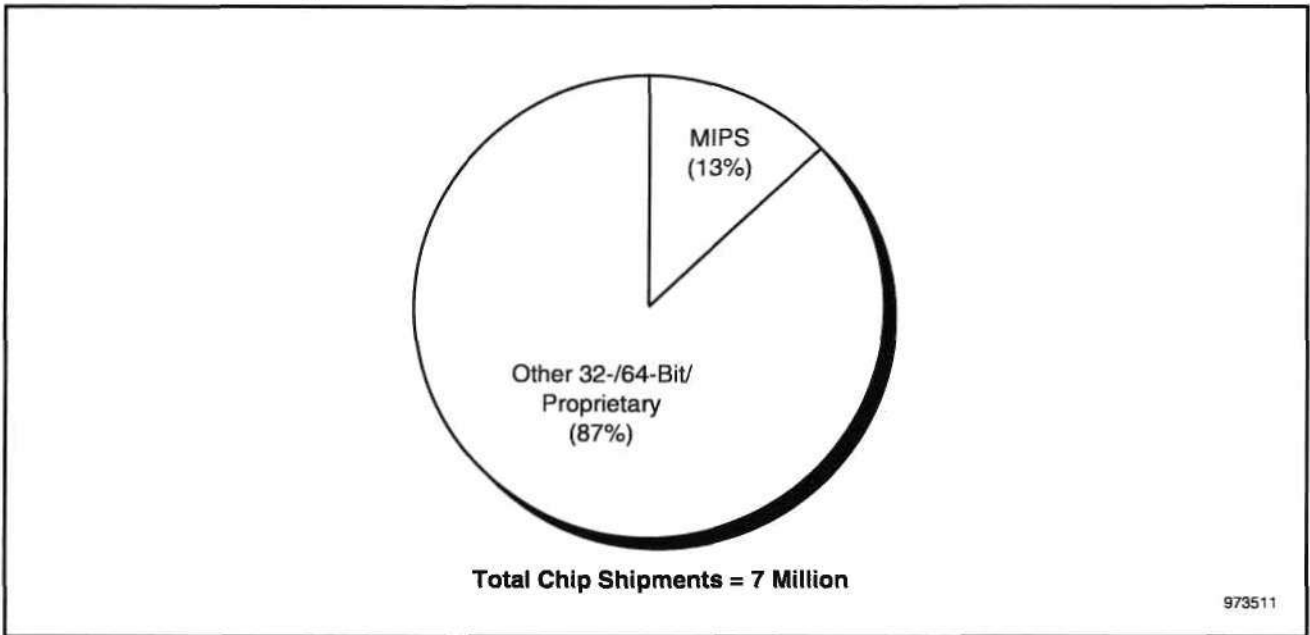
### **DVD Video Players**

Only 60,000 DVD video players were produced during 1996 by Toshiba, Matsushita, and Pioneer. Partly because of its ability to also play laser disc titles, Pioneer systems captured the majority of the early market shipments. This market is expected to experience strong growth, and the main chipset solutions will incorporate 32-bit processors.

### **Other Next-Generation Products**

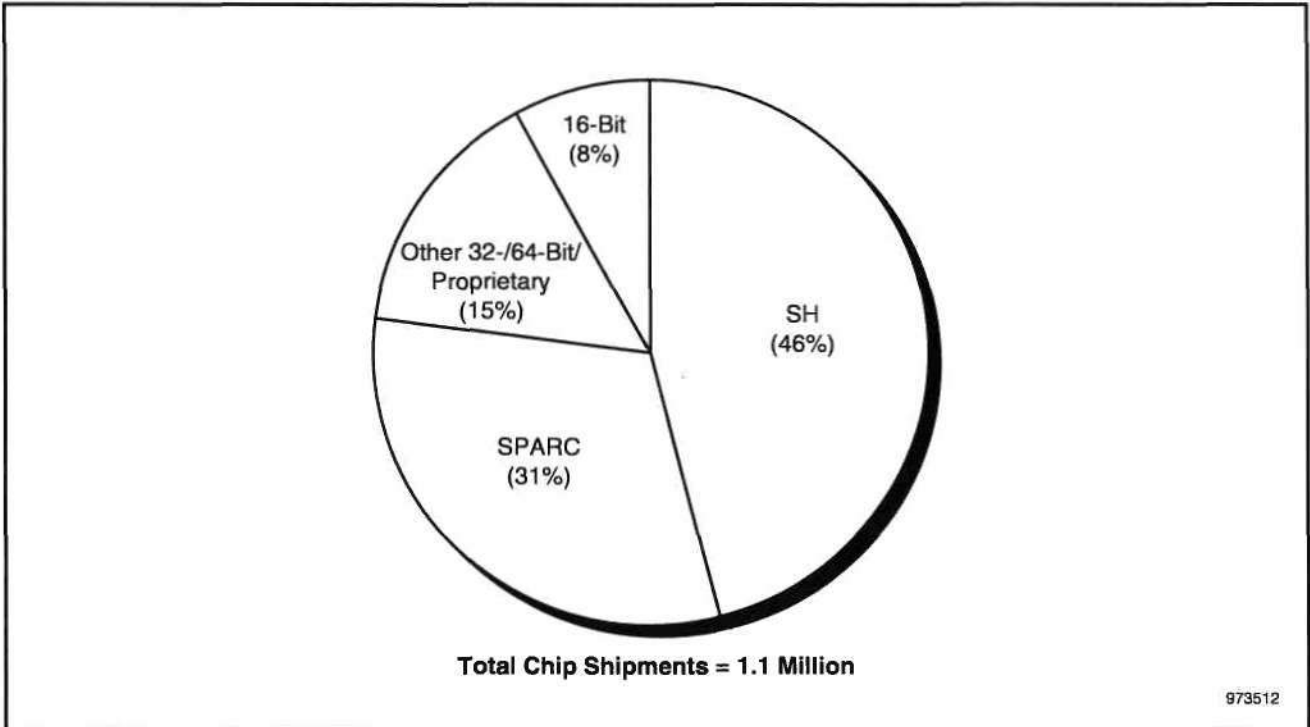
WebTV, which incorporates a MIPS processor, accounted for almost all of the shipments in this category during 1996. This category currently includes products such as Internet appliances and digital VCRs and will include future products such as DVD audio players.

**Figure 3-9**  
**1996 MPU/MCU Chip Unit Market Share in Video CD Players**



Source: Dataquest (May 1997)

**Figure 3-10**  
**1996 MPU/MCU Chip Unit Market Share in Digital Cameras**



Source: Dataquest (May 1997)

## Chapter 4

# Microprocessor Architectures in Next-Generation Products

---

## MIPS

Growing from its origins as a high-end workstation chip, the MIPS RISC microprocessor has emerged as one of the leading devices for next-generation digital consumer products. The line of 32- and 64-bit microprocessors has proven particularly suited for 3-D rendering. MIPS, which was developed and is now licensed by MIPS Technology Inc., now sports what is perhaps the most impressive list of design-wins in the consumer electronics market today.

MIPS' design-wins in next-generation consumer electronics include the Sony Playstation video game console (which uses a chip from LSI Logic), the Nintendo 64 game console (based on two chips from NEC), the Philips/Sony Web TV Internet access terminal, and EchoStar's DISH line of digital satellite set-top boxes.

Other platforms where the MIPS processor has design-wins are:

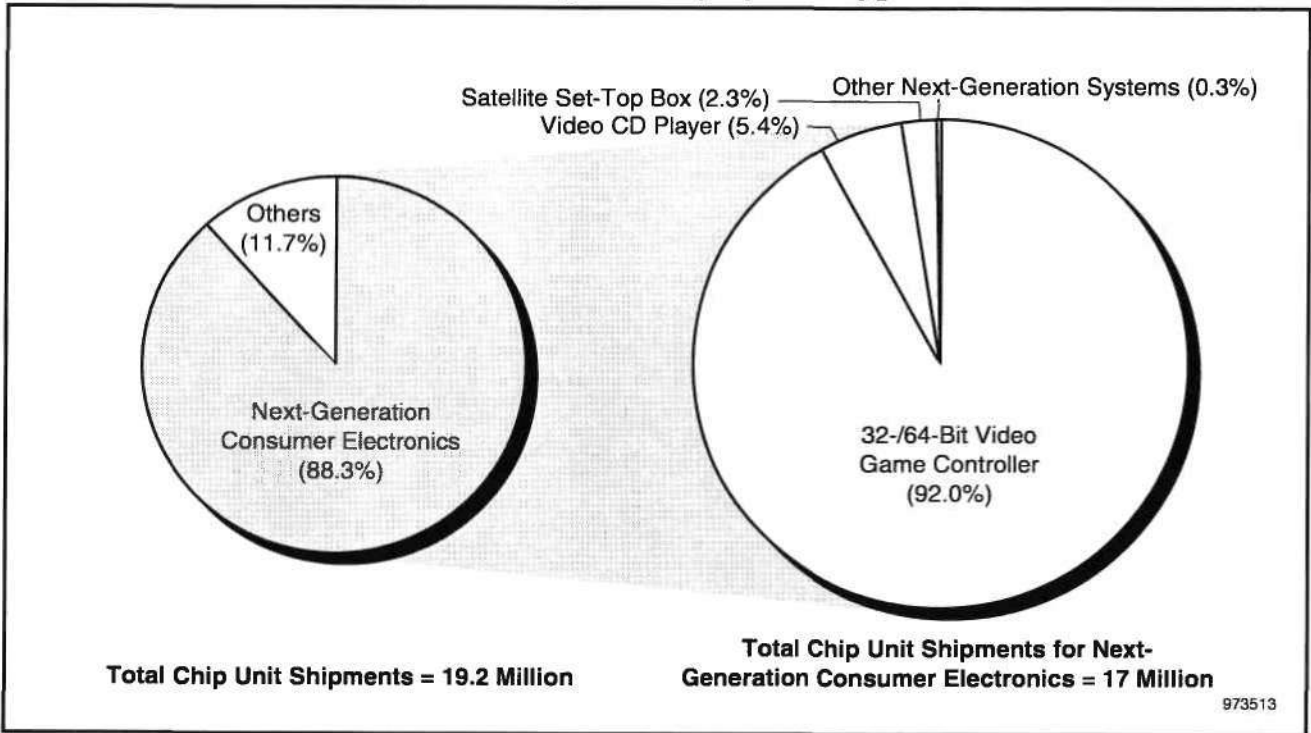
- Computer systems from Silicon Graphics and its Cray subsidiary, Tandem, and Siemens Nixdorf
- Windows CE-based handheld PCs including the Philips' Velo and NEC MobilePro
- Printers, copiers, routers, and communications applications

MIPS microprocessors are manufactured by Integrated Device Technology Inc., LSI Logic Corporation, NEC Corporation, NKK Corporation, Philips Semiconductor, Toshiba Corporation, and Quantum Effect Design (QED).

In late 1996, MIPS introduced a set of enhancements to its architecture, many of which were targeted squarely at the market for digital consumer products, including set-top boxes and Internet appliances. These enhancements included a new extended accumulator that accelerates signal processing and an extension that allows the processor to work with 16-bit code, thereby reducing memory requirements.

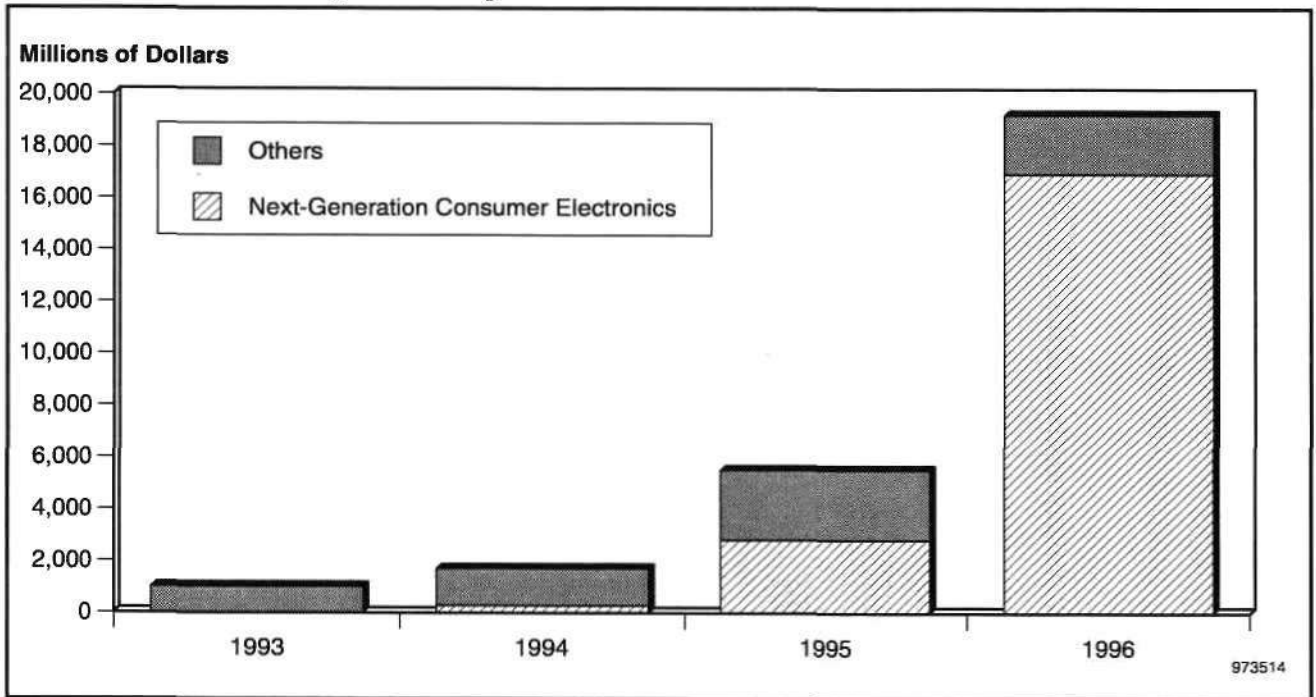
While the MIPS processor has important design-wins in many platforms, the driving force behind its shipment growth to date has been the next-generation consumer electronics products as shown in Figures 4-1 and 4-2. Next-generation consumer electronics consumed 88 percent of all MIPS processors shipped during 1996.

**Figure 4-1**  
**1996 MIPS MPU/MCU Chip Unit Shipments by System Type**



Source: Dataquest (May 1997)

**Figure 4-2**  
**MIPS MPU/MCU Chip Unit Shipments**



Source: Dataquest (May 1997)

## Super-H

The SH family comprises a range of RISC MCUs and MPUs targeted for applications in multimedia, consumer, and other high-end applications. The first SH processor, the SH-1, was released in November 1992. This was followed by the debut of the SH-2 in the Sega Saturn in 1994 and the release of the SH-3 in 1995, which started shipping in handheld PCs in 1996. There are now 13 chip models based on these three cores. In 1996, Hitachi claimed it had shipped 18 million SH chips and that the SH had racked up over 1,000 design-wins. As shown in Figure 4-3, more than 75 percent of these chip shipments went into next-generation consumer electronics applications with the Sega Saturn alone consuming 13.2 million SH chips.

Hitachi has announced plans to introduce both the SH-DSP, which merges a DSP and an SH CPU core, and the SH-4, which features a superscalar structure, in 1997. Other plans for the SH family include development of an SH-Flash memory chip and development of SH cores for designs in cell-based ASIC products. In July 1996, VLSI Technology became an SH core licensee. Under terms of the license agreement VLSI Technology can use the SH-3 and SH-4 as a CPU core for ASIC products.

The development of the SH family of processors is guided by Hitachi's strategy to create products targeted at what it defines as the "personal access" market. This includes applications in consumer products, mobile and wireless products, and automotive navigation, among others.

In next-generation consumer electronics, the SH is used in the Sega Saturn and digital still cameras from companies such as Casio, Canon, and Chicon. Hitachi also uses the SH processor in the set-top box it has developed for PerfectTV and its MPEG prototype video camera.

Five of the original seven handheld PCs based on the Windows-CE operating system use the SH processor, including products from Casio Computer, Hewlett-Packard, LG Electronics, Compaq Computer, and Hitachi.

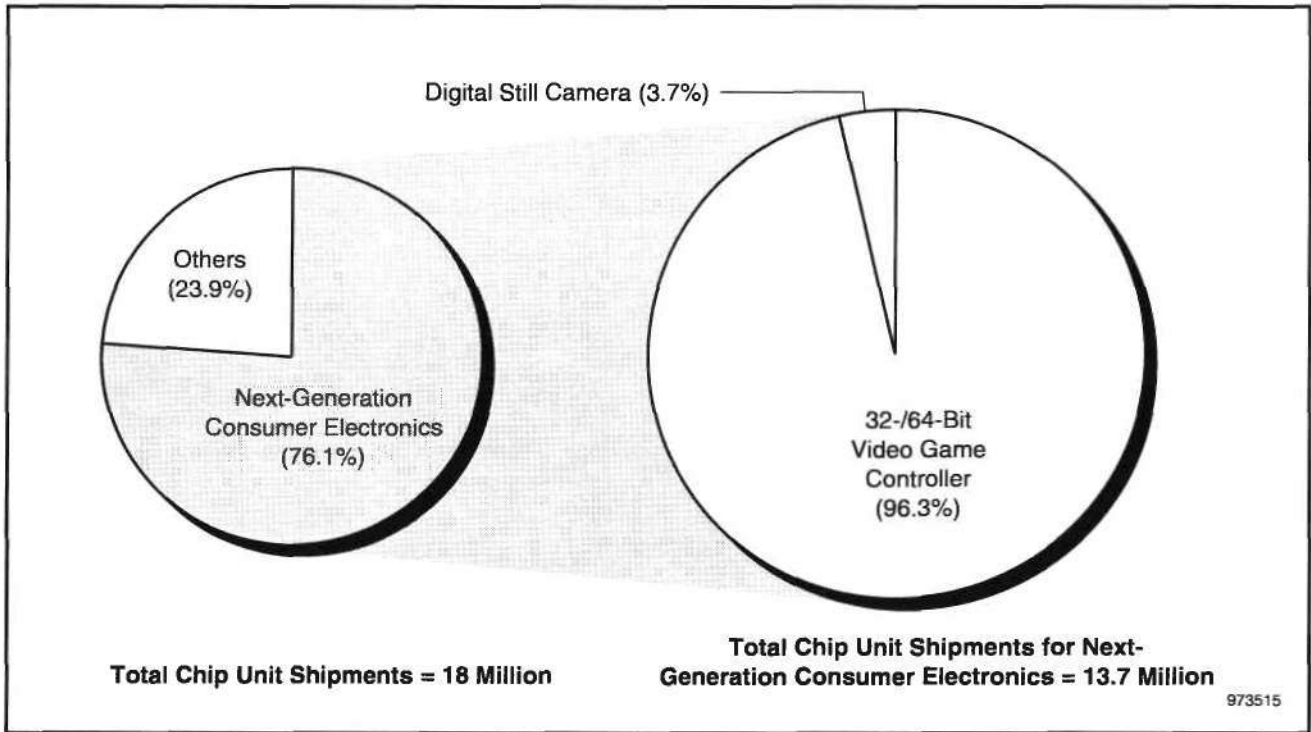
Car navigation systems from Tottori Sanyo Electric, Aisin AW Company, and Xanavi Informatics Corporation use SH processors. Yamaha and Roland also use the processor in their music products. There are also opportunities in engine controllers, printers, and Internet appliances.

## 68000 Family

Motorola's 68000 is a CISC microprocessor that historically has held the leading position in the market for 32-bit embedded applications. Because of its familiarity to software developers and system designers, the 68000 has maintained a strong position in the embedded market in recent years despite the onslaught of powerful RISC microprocessors and microcontrollers.

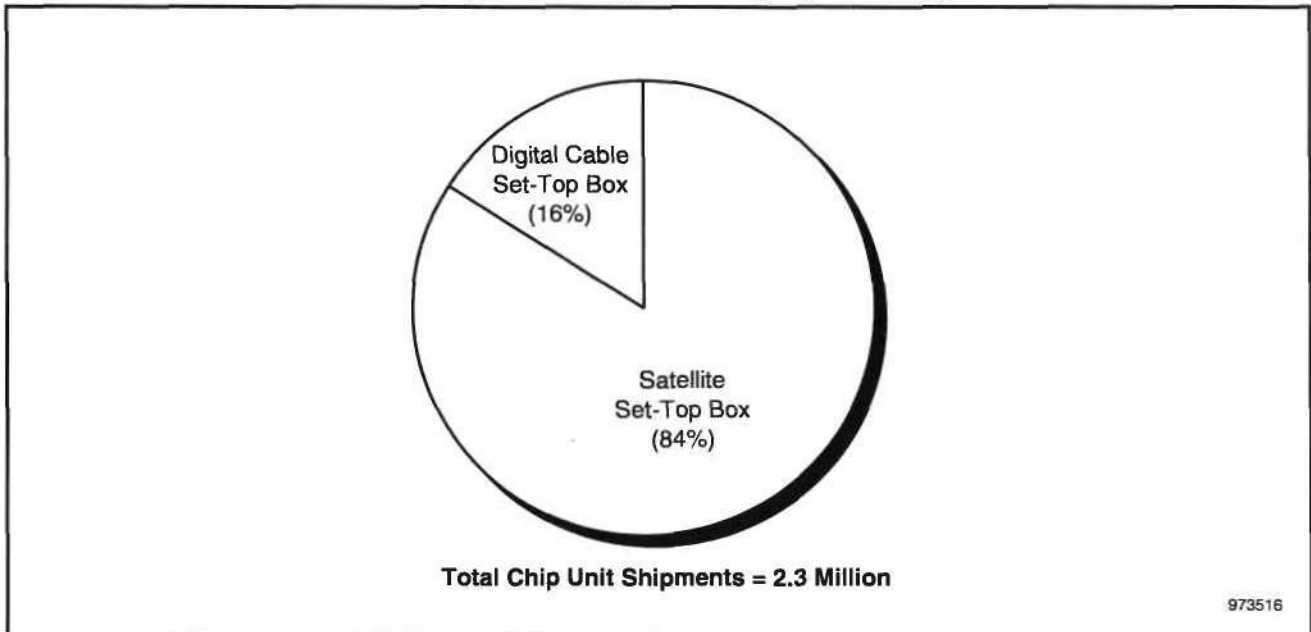
Motorola currently is the only manufacturer developing or selling 68000 microprocessors. The 68000 has been designed into many DBS set-top boxes produced by European vendors. These design-wins have allowed the 68000 to become the industry-leading 32-bit processor in the DBS market. The shipments of 68000 processors during 1996 is shown in Figure 4-4.

**Figure 4-3**  
**1996 SH MPU/MCU Chip Unit Shipments by System Type**



Source: Hitachi, Dataquest (May 1997)

**Figure 4-4**  
**1996 32-bit 68K MPU/MCU Chip Unit Shipments by System Type**



Source: Dataquest (May 1997)

## microSPARC and Java

The Scalable Processor ARChitecture (SPARC) was originally defined at Sun Microsystems between 1984 and 1987. The first SPARC-based workstations and servers were announced concurrently with the architecture in July 1987. There are now more than 250 members of SPARC International including software, hardware, and microprocessor vendors such as Sun Microsystems, Fujitsu, and Texas Instruments. The SPARC microprocessor product line includes four families: microSPARC II, SuperSPARC II, UltraSPARC II, and Java Processors. During 1996, the main successes for the SPARC architecture in next-generation consumer electronics came with the use of the Fujitsu SPARC*lite* product in digital still cameras and a design-win in the Scientific-Atlanta set-top box.

In February 1996, Sun Microelectronics unveiled plans for the industry's first microprocessor family optimized for Sun's Java language. The Java processors' *raison d'être* is to execute Java byte code. Thus, they provide a way to rapidly process Java code at a very low cost and in an extremely small form factor. Therefore, Java processors are likely to appear in consumer products in both standalone and embedded forms.

The Java Chips family consists of the microJava processors, UltraJava processors, and the picoJava core licensing program. The picoJava core is a configurable CPU core that provides direct Java byte-code execution. It is currently being licensed by Sun and is targeted at network computers, handheld PCs, smart phones, and low-cost/low-power consumer appliances. The microJava core is based on the picoJava core with application-specific I/O, memory, communications, and control functions. This processor is being marketed for use in the same target segments as the picoJava core, as well as in low-end games and telecommunications equipment. UltraJava is a high-performance processor designed for use in entertainment and 3D graphics and imaging applications.

At the JavaOne conference in May 1996, Sun announced that LG Semicon, Mitsubishi Electric, and Samsung had signed letters of intent for licensing the Java chips technology. Each of these companies will develop products targeted at consumer applications and Internet appliances. Nortel and Xerox have also committed to developing products based on the Java chips. At the JavaOne conference in April 1997, new agreements and letters of intent were announced:

- Toshiba has signed a letter of intent with Sun to codevelop a low-power version of the Java processor targeted at mobile computing.
- Sun and LG Semicon announced a memorandum of understanding to codevelop the picoJava core for use in network computers, Internet TVs, set-top boxes, and consumer kiosks. Target availability for the chip is the second half of 1997.
- Rockwell Collins will work to develop the processor for applications in cellular phones, global positioning systems (GPS), and aircraft avionics.
- Thomson Sun Interactive will port its OpenTV operating system used in interactive TV and set-top boxes to the microJava processor.

## ARM/StrongARM

Advanced RISC Machines' ARM RISC microprocessor is the most widely licensed of the products listed here, with 17 announced companies in its camp. The ARM RISC is most famous for its use in Apple's Newton personal digital assistant, but can be found in countless embedded applications and mobile communications products.

ARM design-wins include 3DO Interactive's Multiplayer, Curtis Mathes' Uniview Interactive Televisions, and one of the reference designs for Oracle's Network Computer.

ARM licensees include Alcatel, Atmel, Digital, LG Semicon, Oki, Rohm, Sharp, Texas Instruments, Yamaha, AKM, Cirrus Logic, GEC Plessey, NEC, Rockwell, Samsung, Symbios Logic, VLSI Technology, and Lucent Technologies.

At the top of the ARM line is StrongARM, a powerful implementation of the ARM architecture developed by Advanced RISC Machines and Digital Equipment Corporation. The StrongARM offers performance of as high as 270 MIPS, but maintains the low-power operation that has been the hallmark of the ARM line. The microprocessor is being targeted at applications ranging from Internet televisions and appliances to video phones and digital set-top boxes.

## PowerPC

Developed through a joint agreement between Apple Computer, Motorola, and IBM, the PowerPC has found most of its shipments in the Apple-based PC market. However, both IBM Microelectronics and Motorola have developed versions of the PowerPC targeted at next-generation consumer applications.

- Motorola is marketing the PowerPC 602 and MPC823 in consumer applications. The PowerPC 602 is a low-power implementation of the architecture and is designed for use in advanced home entertainment devices with audio/video, multimedia, and complex graphics requirements. The MPC823 is an embedded PowerPC core that is optimized for low-power, imaging, and communications products such as digital cameras and other mobile computing devices.
- IBM Microelectronics has announced a set-top box reference design kit with the PowerPC 403GC embedded controller as one of the major components. This is the same controller found in the IBM Network Station announced in 1996. IBM is also marketing the PowerPC 401GF core for applications in portable communications and consumer products.

## Pentium II

The X86 processor families have not sustained a significant presence in next-generation consumer products. However, the possibility of a major push into this segment of consumer electronics is never far from the thoughts of the current MPU and MCU leaders in this market. In April 1997, Intel announced plans to release a hardware specification based on its Pentium II chip that would create a common platform for video game

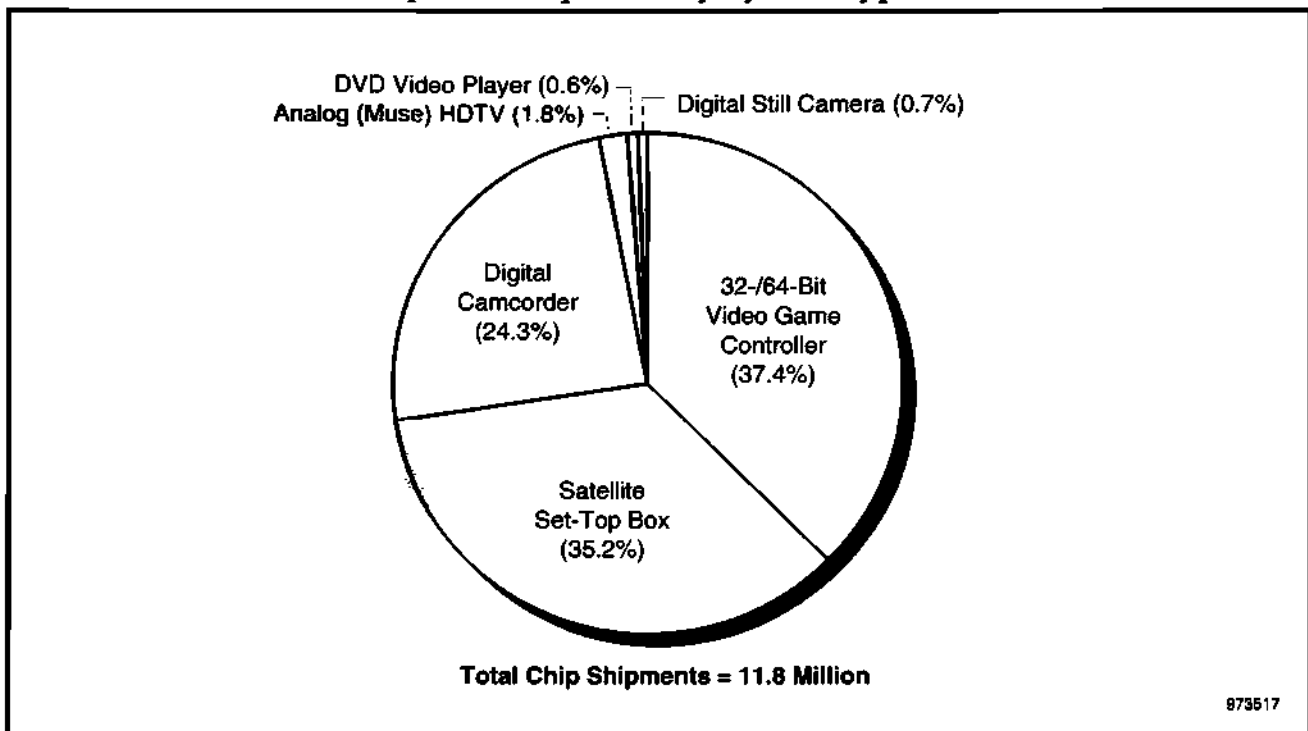


title development ranging from arcade games to high-end multimedia PCs. While the PC has already established a presence in the video game world, it has suffered from the lack of a common development environment. The specifications for the Intel platform were introduced at the Computer Game Developers Conference and look very similar to PC designs, which are expected to cost around \$2,000 in mid-1998. This puts the cost of these Pentium II-based systems far above the current \$150 price of video game consoles. But the appeal of a common PC platform for video game designs will place added pressure on the Nintendo, Sony, and Sega platforms.

## 16-Bit MPU/MCUs

The 16-bit MPU and MCU found use in a wide range of next-generation consumer applications as seen in Figure 4-5. In fact, it was the only type of CPU used in digital camcorders that shipped in 1996. A large number of these chips also shipped in set-top boxes. Sega Saturn also employs a 16-bit processor in addition to the SH chipset. Dataquest predicts that 16-bit MPU/MCU shipments in next-generation consumer electronics will begin to decline after 1997 as they are displaced by more powerful 32-bit processors in more highly integrated solutions.

**Figure 4-5**  
**1996 16-Bit MPU/MCU Chip Unit Shipments by System Type**



Source: Dataquest (May 1997)

## Chapter 5

# Dataquest Predicts

---

Increased use of sophisticated graphics, data processing, and digital video and image compression in next-generation consumer products will require more powerful and cost-effective microprocessors and microcontrollers in future consumer products. Semiconductor manufacturers are developing devices for next-generation digital consumer products, such as digital set-top boxes, that make use of 32- and 64-bit RISC microprocessors. Such microprocessors have become remarkably inexpensive for the level of performance they deliver, with prices in the range of \$10. Future RISC MPUs and MCUs for consumer applications will continue to grow at a strong pace, while adding features and being utilized in integrated designs with signal processing cores and embedded memory that will enable increased multimedia performance without exceeding consumer price targets.

Makers of media processors also have designs on the next-generation digital consumer market. Because media processors are designed from the ground up for the simultaneous processing of numerous multimedia data types, they are well-suited for applications that incorporate graphics, audio, and video. The programmable nature of media processors also makes them a good choice for multipurpose platforms—such as combination DVD players and digital set-top boxes—and emerging types of products that must be able to accommodate changing software and evolving standards. However, in applications where functionality and standards have been settled, media processors may face a cost disadvantage against less-expensive hard-wired solutions.

---

**For More Information...**

Dale Ford, Senior Industry Analyst..... (408) 468-8311  
Internet address ..... dale.ford@dataquest.com  
Via fax ..... (408) 954-1780  
Dataquest Interactive ..... <http://www.dataquest.com>

The content of this report represents our interpretation and analysis of information generally available to the public or released by responsible individuals in the subject companies, but is not guaranteed as to accuracy or completeness. It does not contain material provided to us in confidence by our clients. Reproduction or disclosure in whole or in part to other parties shall be made upon the written and express consent of Dataquest.

©1997 Dataquest—Reproduction Prohibited

Dataquest is a registered trademark of A.C. Nielsen Company

## **DATAQUEST WORLDWIDE OFFICES**

### **NORTH AMERICA**

#### **Worldwide Headquarters**

251 River Oaks Parkway  
San Jose, California 95134-1913  
United States  
Phone: 1-408-468-8000  
Facsimile: 1-408-954-1780

#### **East Coast Headquarters**

Nine Technology Drive  
P.O. Box 5093  
Westborough, Massachusetts 01581-5093  
United States  
Phone: 1-508-871-5555  
Facsimile: 1-508-871-6262

#### **Dataquest Global Events**

3990 Westerly Place, Suite 100  
Newport Beach, California 92660  
United States  
Phone: 1-714-476-9117  
Facsimile: 1-714-476-9969

#### **Sales Offices:**

Washington, DC (Federal)  
New York, NY (Financial)  
Dallas, TX

### **LATIN AMERICA**

Research Affiliates and Sales Offices:  
Buenos Aires, Argentina  
Sao Paulo, Brazil  
Santiago, Chile  
Mexico City, Mexico

### **EUROPE**

#### **European Headquarters**

Tamesis, The Glanty  
Egham, Surrey TW20 9AW  
United Kingdom  
Phone: +44 1784 431 611  
Facsimile: +44 1784 488 980

#### **Dataquest France**

Immeuble Défense Bergères  
345, avenue Georges Clémenceau  
TSA 40002  
92882 - Nanterre CTC Cedex 9  
France  
Phone: +33 1 41 35 13 00  
Facsimile: +33 1 41 35 13 13

#### **Dataquest Germany**

Kronstadter Strasse 9  
81677 München  
Germany  
Phone: +49 89 93 09 09 0  
Facsimile: +49 89 93 03 27 7

#### **Sales Offices:**

Brussels, Belgium  
Kfar Saba, Israel  
Milan, Italy  
Randburg, South Africa  
Madrid, Spain

### **JAPAN**

#### **Japan Headquarters**

Aobadai Hills 4-7-7  
Aobadai  
Meguro-ku, Tokyo 153  
Japan  
Phone: 81-3-3481-3670  
Facsimile: 81-3-3481-3644

### **ASIA/PACIFIC**

#### **Asia/Pacific Headquarters**

Suite 5904-7, Central Plaza  
18 Harbour Road, Wanchai  
Hong Kong  
Phone: 852-2824-6168  
Facsimile: 852-2824-6138

#### **Dataquest Korea**

Suite 2407, Trade Tower  
159 Samsung-dong, Kangnam-gu  
Seoul 135-729  
Korea  
Phone: 822-551-1331  
Facsimile: 822-551-1330

#### **Dataquest Taiwan**

11F-2, No. 188, Section 5  
Nan King East Road  
Taipei  
Taiwan, R.O.C.  
Phone: 8862-756-0389  
Facsimile: 8862-756-2663

#### **Dataquest Singapore**

105 Cecil Street  
#06-01/02 The Octagon  
Singapore 069534  
Phone: 65-227-1213  
Facsimile: 65-227-4607

#### **Dataquest Thailand**

12/F, Vanissa Building  
29 Soi Chidlom  
Ploenchit Road  
Patumwan, Bangkok 10330  
Thailand  
Phone: 662-655-0577  
Facsimile: 662-655-0576

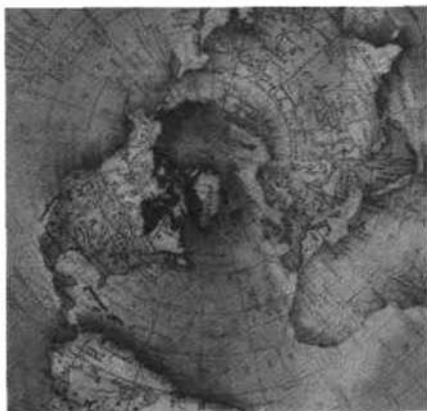
#### **Research Affiliates and Sales Offices:**

Melbourne, Australia  
Beijing, China

# **Dataquest**

A Gartner Group Company

©1997 Dataquest



**FILE COPY:  
MARIA VALENZUELA**

**Dataquest**

## **Digital Television Semiconductors: Finding the Opportunity**



**Focus Report**

---

**Program:** Consumer Multimedia Semiconductors and Applications Worldwide  
**Product Code:** MSAM-WW-FR-9702  
**Publication Date:** April 21, 1997  
**Filing:** Reports



# Digital Television Semiconductors: Finding the Opportunity



## Focus Report

---

**Program:** Consumer Multimedia Semiconductors and Applications Worldwide  
**Product Code:** MSAM-WW-FR-9702  
**Publication Date:** April 21, 1997  
**Filing:** Reports

## Table of Contents

---

	Page
1. Executive Summary .....	1
2. DTV: The Blind Men and the Elephant .....	3
What Is Digital Television? .....	4
DTV Definitions.....	5
Why DTV?.....	6
DTV Challenges .....	7
The Road to DTV.....	7
The United States: The Long and Winding Road.....	7
Europe: Fast Action .....	8
Japan: Back to the Drawing Board .....	8
3. DTV Products and Production .....	9
Forecast Assumptions.....	9
The United States .....	10
Japan.....	12
A Word about PCs.....	12
The Semiconductor Market .....	13
The Opportunity .....	13
The Chips .....	14
The Front End.....	15
The Back End.....	16
Semiconductor Costs .....	18
4. Conclusion.....	19

## List of Figures

---

Figure	Page
3-1 Worldwide DTV Production Forecast .....	10
3-2 Americas DTV Production Forecast by Platform Type .....	12
3-3 Worldwide DTV Semiconductor Sales Forecast.....	13
3-4 Functional Block Diagram of a DTV Receiver.....	15



## List of Tables

---

Table	Page
2-1 Differentiating DTV .....	5
3-1 Worldwide DTV Forecast by Units, Average Selling Price, and Factory Revenue .....	9
3-2 Americas DTV Production Forecast by Platform Type.....	11
3-3 Worldwide DTV Semiconductor Sales Forecast by Units, Content, and Cost .....	14
3-4 HDTV Semiconductor Bill of Materials Forecast.....	18

## Chapter 1

# Executive Summary

---

This report from Dataquest's Semiconductor Application Markets Worldwide program analyzes the emerging consumer electronics market for digital television. The report focuses on how semiconductor companies can participate in this market. Insights into the nature of digital television technology, where the biggest opportunities are, and what types of semiconductors to develop are provided. Also included are forecasts of production of digital television receivers and of related semiconductors on a worldwide basis and in the Americas.

Among the conclusions of the report are:

- The largest-volume types of digital television receivers will not be high-definition television sets, but rather will be standard-definition television sets and set-top boxes.
- With the advent of digital television, consumer electronics makers for the first time will face serious competition from PC makers.
- Semiconductor makers focusing on the digital television market can utilize many technologies and products originally developed for digital set-top box applications. However, key new products and technologies are required, most importantly, high-level MPEG-2 decoders that can accommodate high-resolution HDTV signals.
- Because of the high sales potential and powerful capabilities of digital television silicon, chips developed for this application will be the volume and technology driver for other digital video platforms.

## Chapter 2

# DTV: The Blind Men and the Elephant

---

In the last few years of the 20th century, broadcast television will take the first few tentative steps in its historic transition from analog to digital technology. With digital terrestrial broadcasts expected to begin in 1998 in the United States and Europe, the way television is sent, received, and used by consumers will change forever. But how will digital television (DTV) change television, and how will those changes affect semiconductor companies in this market?

For chip companies, DTV represents a huge opportunity. However, the nature of DTV is still undefined, adding a great deal of risk to the market. The technology of DTV is multifaceted, combining audio, data, and several quality levels of video. A tangle of political, legal, logistical, and competitive issues have conspired to further cloud the picture of what DTV will be.

When looking at the coming market for DTV, one is reminded of the ancient parable of the blind men and the elephant. As the story goes, several blind men touched an elephant and each came away with a different impression of the animal, one man declaring it to be like a tree, another comparing it to a moving mountain, and still another perceiving it as a snake. With DTV still in the future, everyone in the industry is like the proverbial blind men, groping to understand DTV. To some, DTV is high-definition TV (HDTV), to others it is many channels of standard-definition TV (SDTV), and to still others, DTV is a new, high-bandwidth medium for data communications.

The truth of DTV is that it is all these things and more. DTV will change the nature of television broadcasting. Historically, television broadcasting has meant one thing: the transmission of NTSC and PAL video to television sets. In the new age of DTV, television broadcast will encompass standard-definition television (SDTV), high-definition television (HDTV), digital surround sound, and high-rate data transfer. Depending on factors including demand, competition, and regulatory constraints, broadcasters will decide which of these services to deliver and in what combination.

DTV will change the nature of television viewing. Historically, watching television has meant just that: the passive viewing of NTSC or PAL video on a television set. With DTV, consumers can choose whether to watch television in HDTV or SDTV resolutions. Consumers can eschew the whole idea of television as a passive form of entertainment and use the data transmission component of DTV as an interactive medium. They can even decide that the best way to enjoy DTV is not to use a television at all and to tune into broadcasts using their PCs.

Equipment makers in the consumer realm will face changes as well. With numerous different platforms possible, makers of consumer electronic products will have to offer many different types of products, where there was only one before. They also will have to face a new competitive environment and a new set of competitors.

For chipmakers, DTV changes the nature of selling into the television market. Because DTV receivers will have a much higher semiconductor content than conventional televisions, the market offers enormous opportunities for chip companies. However, the emergence of new platform types and the changed competitive environment will make it more difficult to define and develop products that will be successful in the market. As chip companies try to find the opportunities in DTV, they could easily miss the real chances to cash in. Like the proverbial blind men, semiconductor makers could mistake DTV for a snake, when it is really an elephant. In this report, Dataquest will help define DTV and will offer strategies for semiconductor companies that want to ride the elephant, rather than be flattened by it.

## What Is Digital Television?

In short, digital television is the broadcast and reception of terrestrial digital video, audio, and data. In the United States and Europe, the phrase digital television has been applied to industry and government standards for the terrestrial broadcast of digital video, audio, and data. In these standards, compressed video and audio are broadcast in a modulated form to a receiver, which internally performs demodulation, decompression, and other processing of the signals. To a degree, the term digital television is a misnomer, given that DTV receivers perform digital-to-analog conversion and vice versa on the incoming signals. In addition, the definition given above for digital television could just as well be applied to digital cable and satellite systems, which also broadcast and receive digital video, audio, and data. However, for the purposes of this report, the term digital television (or DTV) will be applied to systems and receivers that are involved in the broadcast and reception of terrestrial digital video. It also will be applied to televisions that have integrated tuners, video decompression, and processing logic that are capable of receiving digital broadcasts, regardless of the delivery medium. Table 2-1 presents various definitions that differentiate DTV from analog television and digital set-top boxes.

On a worldwide basis, systems complying with this definition are the United States' ATSC Digital Television (DTV) specification, Europe's Digital Video Broadcasting Terrestrial (DVB-T) standard, and Japan's recently announced digital HDTV. Technology developed as part of these efforts can be applied to other delivery media, such as satellite and cable; however, Dataquest will not cover those delivery methods or platforms in detail in this document. Because of its digital nature and its capability to deliver high-speed data in addition to audio and video over the airwaves, the technology of DTV is equally applicable to computers and to consumer electronic equipment. This Perspective will cover only the consumer aspect of DTV in detail.

**Table 2-1**  
**Differentiating DTV**

Television Type	Description	Examples
Analog Television	Televisions with analog input. Can receive analog signals from sources including an analog antenna, an analog set top box, a digital cable set top box or a digital satellite box. Can display video in a standard or in a high definition resolution.	NTSC PAL MUSE HDTV (analog)
Digital Television (DTV)	Televisions that have digital input (that is, that have integrated tuners, video decompression, and processing logic) that are capable of receiving digital broadcasts and can display video in a standard or high-definition resolution.	U.S. ATSC DTV-specification television (HDTV and SDTV)  European DVB-T-specification television
Digital Television Set-Top Box (DTV STB)	Set-top boxes with integrated digital terrestrial receivers and digital processing logic	U.S. ATSC DTV specification STB (HDTV and SDTV)  European DVB-T specification television

Source: Dataquest (March 1997)

## DTV Definitions

Following is a list of definitions for DTV terms used in this report.

- **AC-3**—Also known as Dolby Digital or Surround AC-3. AC-3 is a digital audio technology devised by Dolby Laboratories Inc. that delivers compressed audio with six separate channels of sound. AC-3, which is widely licensed by semiconductor and manufacturers, is the audio standard for the ATSC HDTV specification as well as for DVD players.
- **ATSC**—Advanced Television Systems Committee. A group formed to establish standards for advanced television, including the American DTV specification. The specification for DTV recently passed by the U.S. Federal Communications Commission (FCC) is now known as the ATSC Digital Television (DTV) Standard, formerly known as the Grand Alliance System.
- **DTV**—Digital television. A generic term used to describe digital television broadcasting as well as digital television receivers. In this document, the phrase digital television will be applied to receivers (both televisions and set-top boxes) that are involved in the broadcast and reception of terrestrial digital video. It also will be applied to televisions that have integrated tuners, video decompression, and processing logic that are capable of receiving digital broadcasts, regardless of the delivery medium.

- **DVB—Digital Video Broadcasting**, a European-based group of international companies formed to set standards for digital video broadcasting. DVB standards cover satellite, cable, terrestrial, and other delivery technologies.
- **FCC—U.S. Federal Communications Commission**. The body that regulates and mandates standards for broadcast and other forms of communications in the United States.
- **Grand Alliance**—An alliance of seven organizations that proposed all-digital HDTV systems for FCC approval. The Grand Alliance specification for digital television broadcast was adopted by the FCC in December 1996. The seven member organizations of the Grand Alliance are AT&T Microelectronics (now part of Lucent Technologies), Zenith Electronics Corporation, General Instrument Corporation, Massachusetts Institute of Technology, Philips Consumer Electronics, Thomson Consumer Electronics, and David Sarnoff Research Center.
- **HDTV—High-definition television**. A form of television that can display video at much higher resolutions than conventional television technologies. HDTV resolutions vary from 1,125 horizontal scanning lines for Japanese MUSE analog HDTV to 1920 x 1080 for the high-end format for the ATSC ATV specification.
- **MPEG-2**—A standard from the Motion Picture Experts Group for video compression. MPEG-2 is the video compression standard used for all DTV specifications worldwide.
- **NTSC**—The analog color television specification devised by the National Television Standards Committee (NTSC) and used predominantly in North America and Japan.
- **PAL—Phase Alternate Lines**. The predominant analog color television specification in Europe.
- **SDTV—Standard-definition (digital) television**. SDTV is an FCC-approved standard for digital TV using standard-resolution (NTSC-equivalent) displays within a DTV broadcast system. Available resolutions are 640 x 480 and 704 x 480.
- **STB, or set-top box**—Although often used to describe receivers used in pay television systems, such as cable and satellite, STBs also can be provided as converter for DTV systems, including those that use free terrestrial broadcast.
- **VSB—Vestigial Side Band**. The modulation technology used in terrestrial and cable deployments of the ATSC DTV specification. The technology was first devised by Zenith as part of the Grand Alliance HDTV specification.

## Why DTV?

Dataquest expects that DTV will be widely adopted for several reasons. Among them are the following:

- **DTV will be widely available**. Because DTV is broadcast over the terrestrial airwaves, it can reach an unlimited number of viewers.

- DTV will be free. Though pay versions of DTV are possible, much of the content will be available to viewers at no cost.
- DTV will be high quality. DTV offers much better reception, sharper picture, and superior sound compared to analog NTSC. HDTV will be far better than NTSC, but even SDTV will offer a significantly improved viewing and listening experience.
- DTV can have many more channels than analog broadcast. With digital compression, more channels can be broadcast within the same bandwidth. For example, in the U.S. ATSC system, about four SDTV channels currently can be broadcast within the same amount of bandwidth that it takes to transmit one NTSC channel.
- DTV will offer much higher rates of data transmission than analog broadcast. For example, in the U.S. ATSC system, in the same amount of frequency that it takes to broadcast a single NTSC channel, data can be broadcast at rates of up to 19 Mbps. Data can be simulcast with video at slower rates. This will make possible a multitude of new services that will address both the consumer and computer markets.
- DTV is the law. In the United States, the federal government will mandate that broadcaster switch from analog to digital transmission probably in 2006. This will force consumers to obtain new, DTV receivers.

### **DTV Challenges**

While DTV has advantages that will help it become a major product, it also faces some challenges that could limit the success of consumer electronics companies. These challenges include the following:

- Price—DTV receivers, particularly HDTV resolution television sets, are much more expensive than conventional analog receivers. While prices will decline, the high tags will deter many consumers from buying DTV receivers.
- Television competition—DTV will face stiff competition from other types of television transmission, including digital and analog cable and satellite.
- Computer competition—Because DTV is digital and has the capability to broadcast data at high rates, it is equally applicable to consumer and computer applications. The computer industry has already moved to take control of DTV technology, and in the future will battle with the consumer electronics manufacturers for customers.

## **The Road to DTV**

Over the last year, significant progress has been made toward DTV in every region of the world. Just in the last few weeks and months before this report was written, several important developments have taken place in DTV that are key to the deployment of the technology in different regions around the world.

### **The United States: The Long and Winding Road**

After an nine-year long political struggle, the United States' FCC in December 1996 approved a standard for digital terrestrial television broadcast. The standard is based on broadcast technology originally

developed by the Grand Alliance, a consortium of consumer electronics firms and others. The broadcast specification supports a range of video options, ranging from SDTV to HDTV, as well as audio and data broadcast. Responding to pressure from the personal computer and software industries, the FCC chose not to adopt the Grand Alliance's display format proposals and instead decided to leave the display decisions up the industry. Despite that, consumer electronics companies are rallying behind the Grand Alliance display specifications (now known as the ATSC standard), which encompass a range of resolutions, frames rates, aspect ratios, and scanning technologies. As this was written, the FCC was scheduled shortly to announce rules and frequency allocations for DTV broadcast. Those decisions will have an enormous impact on the timing and characteristics of the DTV deployment in the United States as they will establish how frequencies will be allocated, what kind of mandates for broadcast type may be established, and how quickly conventional NTSC broadcasting will be phased out. Broadcasters believe initial DTV broadcasts will begin in late 1998. Consumer electronics equipment manufacturers will introduce their first DTV receivers in January 1998 and go into initial production by the middle of the year.

### **Europe: Fast Action**

Europe has had a relatively easy time of establishing a DTV standard compared to the United States. The DVB-T standard that is being used for digital terrestrial television in Europe is a version of the DAVIC committee's overall DVB specification that has been developed in versions for satellite, cable, and MMDS. DVB systems are already in wide use in digital satellite systems in the United States, Japan, and Europe. DVB-T broadcasts are expected to begin in the United Kingdom and DVB-T receivers will appear on the market in 1998.

### **Japan: Back to the Drawing Board**

Japan since the late 1960s has believed that the next generation of television technology would be analog HDTV, specifically the country's MUSE (also known as Hi-Vision) HDTV standard. However, the Japanese Post and Telecommunications Ministry recently recommended that one of the country's HDTV satellite set to be launched in 2000 use digital broadcast for HDTV, rather than analog as originally planned. Japan now promises it will develop its own digital HDTV standard that will be superior to other regional specifications.



## Chapter 3

# DTV Products and Production

In this section, we will examine the growth of worldwide DTV production. As shown in Table 3-1 and Figure 3-1, from its start in 1998, worldwide production of DTV receivers is expected to grow from \$6 million in 1998 to \$4.4 billion in 2002, a compound annual growth rate (CAGR) of 430 percent. Production will be negligible in 1998, but will increase rapidly over the following years.

### Forecast Assumptions

The forecast encompasses the following three basic types of DTV receivers:

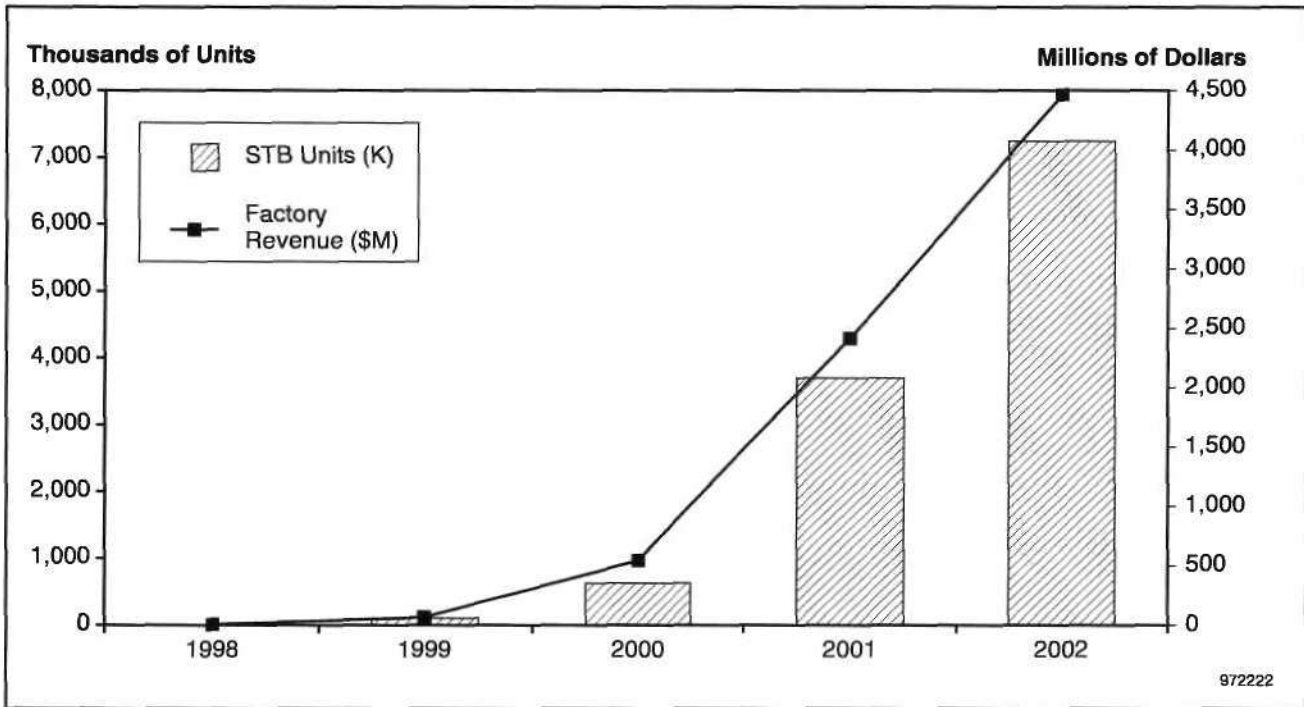
- **The HDTV television set**—The HDTV television set is the most expensive and fully featured type of DTV receiver. The product can receive both DTV and NTSC signals, perform processing and decompression of digital signals and display them on its screen, which has a resolution of up to 1920 x 1080. HDTVs come with high price tags for two reasons. First, HDTV television sets have the most expensive digital semiconductor content of all the DTV receivers, requiring new, high-level MPEG-2 decoders and much more memory. Second, the HDTV television sets will use new high-definition displays or projectors, which will represent the most expensive portion of the products.
- **The SDTV television set**—The SDTV television set resides in the midrange of features and prices for DTV receivers. An SDTV television set can receive both NTSC and DTV signals, regardless of resolution, perform processing and decompression, and display them on its screen in SDTV resolutions, which are 640 x 480 and 704 x 480. SDTV displays can either be conventional NTSC displays or they can use other display technology. One of the prime advantages of the SDTV television sets will be their capability to display video in the 16:9 format, a feature not generally available in the United States now. SDTV television sets will be less expensive than HDTV television sets because of their use of MPEG-2 decoders that are less expensive and require less memory. Because of their lower resolutions, the SDTV displays will be cheaper as well.

**Table 3-1**  
**Worldwide DTV Forecast by Units, Average Selling Price, and Factory Revenue**

	1998	1999	2000	2001	2002	CAGR (%) 198-2002
Units (K)	11	104	626	3,699	7,246	407
Average Selling Price (\$)	516	654	870	653	616	5
Factory Revenue (\$M)	6	68	544	2,415	4,465	430

Source: Dataquest (March 1997)

**Figure 3-1**  
**Worldwide DTV Production Forecast**



Source: Dataquest (March 1997)

- The DTV set-top box (STB)—The DTV STB is the low-end version of the DTV receiver. A DTV STB can receive DTV signals, regardless of their resolution, perform processing, and decompression on them, and encode them for output to an NTSC television. The primary purpose of DTV STBs is to give owners of NTSC televisions access to HDTV and SDTV programming and services. DTV STBs will resemble SDTV television sets in their semiconductor content, but will not have a display, significantly reducing their cost.

Each region of the world will experience radically different growth of the DTV market. The following section will examine market conditions for each major region where DTV production takes place.

## The United States

Dataquest believes the United States will be the main DTV production region during the forecast period. A combination of factors will fuel growth faster in the United States than in other regions. First, the United States likely will be the only region in the world to have digital terrestrial HDTV broadcasts in the period from 1998 to 2000. This will attract early adopters who are interested in receiving the highest-quality video. Second, the availability of free television and data broadcasts in high-quality digital HDTV and SDTV formats will attract buyers to SDTV TVs and DTV set-top boxes. Third, the FCC is expected to mandate that all broadcasters end their analog NTSC transmissions, (probably in 2002) and switch to digital. This will force owners of NTSC televisions to obtain either a DTV STB or an SDTV television set.

Figure 3-2 and Table 3-2 present a forecast of Americas production of DTV receivers by type. The forecast anticipates that all initial production of DTV receivers in the United States in 1998 will consist of full HDTV receivers. Production of HDTV television sets will grow to 5.3 million units in 2002, up from just about 1,000 in 1998. Manufacturers have indicated that they will enter the DTV market with products targeted at early adopters who are willing to spend more for a high-quality picture. Initial factory pricing of HDTV television sets in 1998 will be \$2,876.25 and will fall slowly over the forecast period to reach \$2640.25 in 2002. As prices fall, HDTV television set sales and production will grow, but will remain small relative to overall DTV manufacturing.

In 1999, large-scale production of SDTV television sets will begin. Dataquest predicts these will be the largest selling and most manufactured type of DTV receiver during the forecast period. Starting from production of 4,000 units in 1999, manufacturing will boom to more than 5 million units in 2002. Several factors will account for the popularity of the SDTV television sets. First, SDTV television sets are reasonably priced, giving customers a way to upgrade to a digital-quality picture without paying the hefty digital HDTV price tag. Second, the quality of image and sound on SDTVs will be far superior to NTSC television sets, attracting more purchasers. Third, new programs and data services will be available for free that will attract viewers. Fourth, beginning in 2001 and 2002, consumers will move to replace their NTSC sets with SDTV television sets before the end of analog broadcasting.

Manufacturing of DTV set-top boxes also will begin in 1999. Initial production levels will be negligible. However, manufacturing will grow strongly in 2000 as more companies introduce products. By the year 2002, 116,000 DTV set-top boxes will be produced. Consumers will be attracted to the high picture and sound quality brought by the DTV set-top boxes (though not as high as the SDTV television sets). Late in the forecast period, production of DTV STBs will increase rapidly as consumers move to upgrade before the digital conversion. Dataquest believes that the DTV STBs are likely to become the most popular type of DTV receiver after the end of the forecast period as the digital transition approaches.

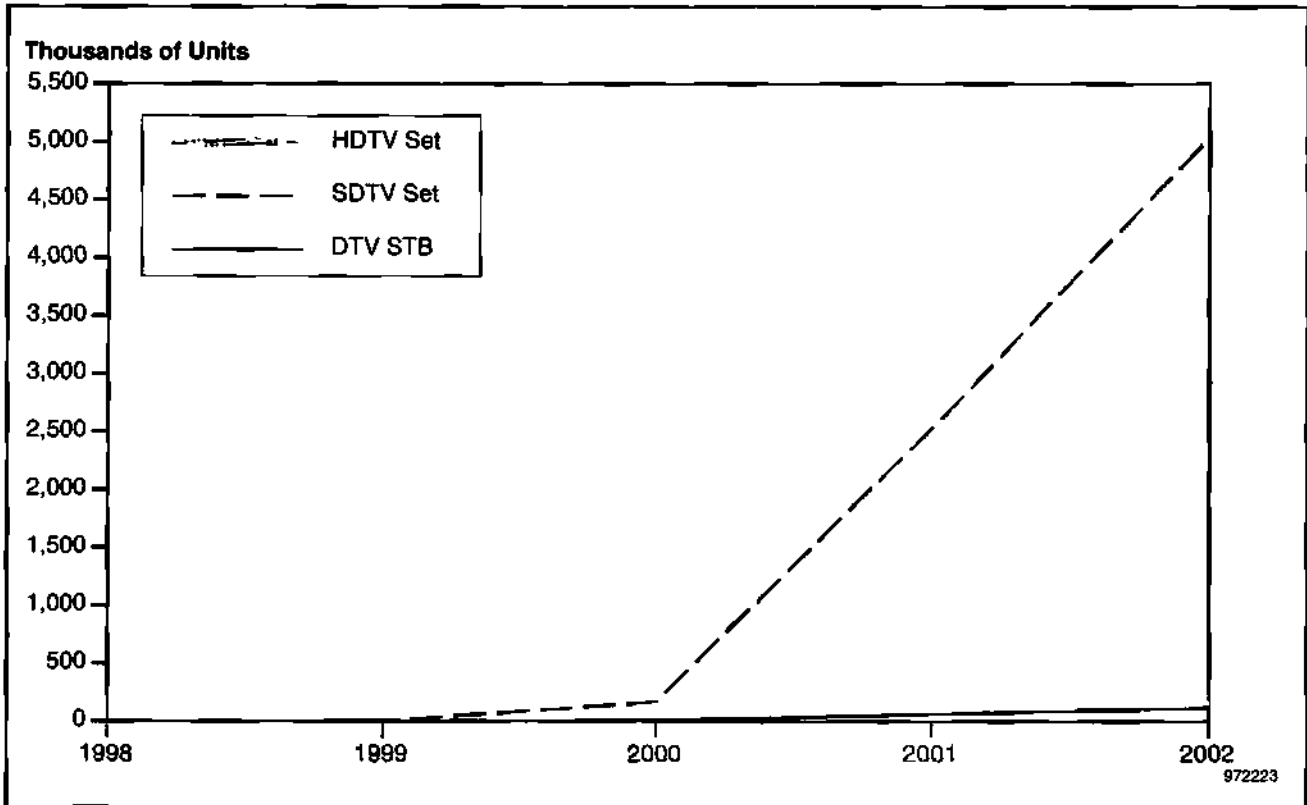
In Europe, not much interest has been generated in terrestrial DVB broadcast outside of the United Kingdom. Initial production of DTV receivers will begin in 1998, when digital terrestrial broadcasts begin in the United Kingdom. The first DTV receiver to be manufactured in Europe will be the DTV STB. In 2000, production of SDTV television sets will begin. However, neither of these products are expected to reach major volumes before the end of the forecast period.

**Table 3-2**  
**Americas DTV Production Forecast by Platform Type**  
**(Thousands of Units)**

	1998	1999	2000	2001	2002
HDTV Television Set	1	16	34	74	155
SDTV Television Set	0	4	169	2,527	5,038
DTVSTB	0	2	10	63	116

Source: Dataquest (March 1997)

**Figure 3-2**  
**Americas DTV Production Forecast by Platform Type**



Source: Dataquest (March 1997)

## Japan

As this is written, Japan's plans for DTV center on digital HDTV. Though satellite broadcast of digital HDTV is expected to begin in 2000, it is unclear when terrestrial HDTV transmission will start. Recent reports have indicated that Japan will begin terrestrial digital HDTV broadcasts before 2000, but it is unclear if this deadline is firm or not. Dataquest predicts rapid consumer acceptance of the new televisions. By the year 2002, production of HDTV television sets in Japan should reach 1 million units.

## A Word about PCs

Although this report will not cover the market for DTV-enabled PCs, a few words on the topic are appropriate. The U.S. PC industry views DTV as a key strategic technology, as evidenced by the influence it has exerted on the U.S. DTV standardization process. For many years, Microsoft, Intel, Compaq, and other companies have been attempting to make the PC more of a consumer-friendly, consumer entertainment platform. Because of its digital nature, DTV allows the easy integration of video and broadcast data services into the PC realm. By the time digital broadcasts have begun, the computer industry will have introduced DTV-enabled PCs at a variety of price points and with a range of features. Products will range from inexpensive add-in cards with DTV tuner/demodulators, to big-screen, HDTV PCs. FCC chairman Reed Hundt has stated that he believes

sales of DTV-enabled PCs will dwarf those of DTV television sets over the next few years. Television makers should expect competition from the PC makers, particularly at the high end. They also should expect the PC industry to exert influence over DTV technology. Because the FCC did not establish display standards for DTV, the PC industry will establish its own technology for digital display that will be favorable for computer display formats. As this was being written, Microsoft, Intel, and others were expected shortly to announce a specification for DTV-enabled PCs.

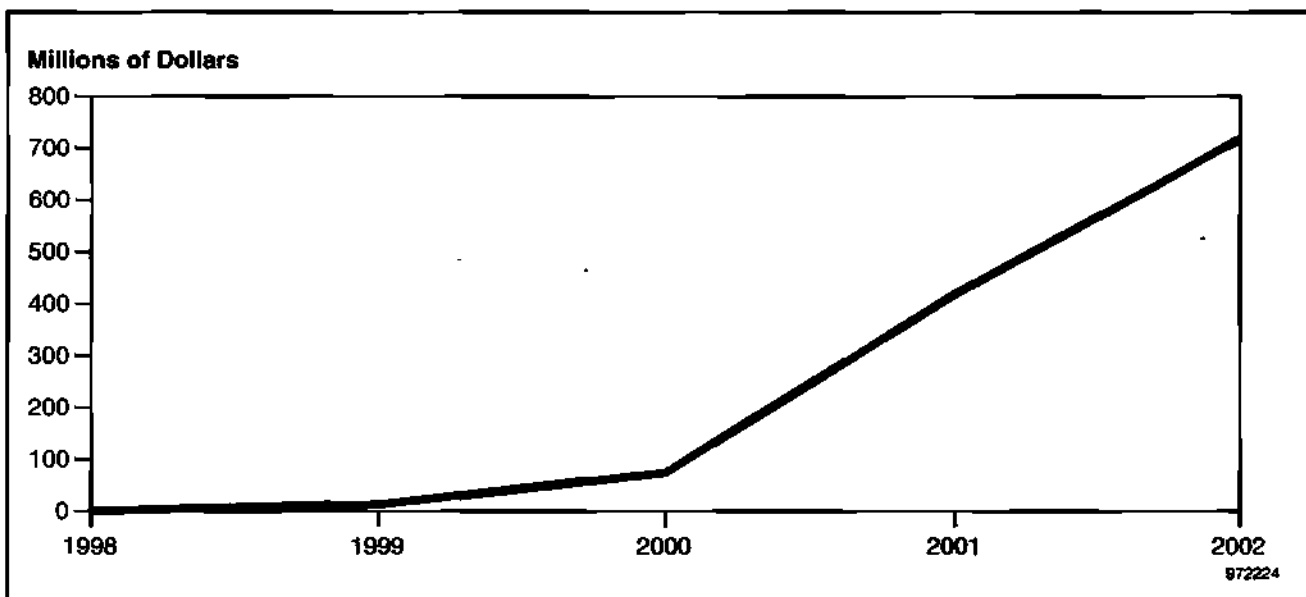
## The Semiconductor Market

### The Opportunity

DTV offers tremendous opportunity to semiconductor makers. Figure 3-3 and Table 3-3 forecast the worldwide semiconductor market for DTV. Revenue is expected to grow from about \$1 million in 1998 to \$718 million in 2002. In the Americas, initial opportunities will be in high-end HDTV television sets. The first chipsets used in these products will not be highly integrated and will be relatively expensive. Dataquest expects the semiconductor content of these sets to be \$210.47. Many of the components are new and will be supplied by captive semiconductor suppliers to their parent consumer electronic companies. Thus, many of the initial components will be ASICs and general-purpose standard products. Initial manufacturing geometries will range from 0.5 micron to 0.35-micron.

In Europe, initial production in 1998 will comprise DTV STBs. Because of their similarity to existing DVB satellite television receivers, semiconductor content of European DTV set-top boxes will be very similar. Dataquest is predicting the semiconductor content of those products will average about \$113.

**Figure 3-3**  
**Worldwide DTV Semiconductor Sales Forecast**



Source: Dataquest (March 1997)

**Table 3-3**  
**Worldwide DTV Semiconductor Sales Forecast by Units, Content, and Cost**

	1998	1999	2000	2001	2002	CAGR (%) 1998-2002
STB Units (K)	11	104	626	3,699	7,246	407
Semiconductor Content (\$)	122	123	118	113	99	-5
Semiconductor TAM (\$M)	1	13	74	419	718	381

Source: Dataquest (March 1997)

As lower-cost DTV platforms begin production and the HDTV television set market matures, semiconductor companies will be able to gain competitive advantage by offering lower cost, more highly integrated chipsets. Because of the similarity of DTV receivers to digital set-top boxes, manufacturers will be able to leverage some—but not all—of their previously developed chips and cores into the new market. Thus, starting in 1999, and accelerating in 2000, more highly integrated and cost-effective application-specific standard product (ASSP) solutions will enter the market. Because of the advent of lower-cost platforms, semiconductor content of DTV receivers worldwide will fall to \$131 in the Americas and \$118 worldwide. Though captive semiconductor producers will hold sway over many television manufacturers, the emergence of the DTV STB market will open up opportunities for chip manufacturers at smaller consumer electronics companies. Eventually, opportunities will emerge for third-party semiconductor sales even at the large television manufacturing companies. In the 1999-to-2000 period, semiconductor manufacturers will employ 0.35- and 0.25-micron geometry parts.

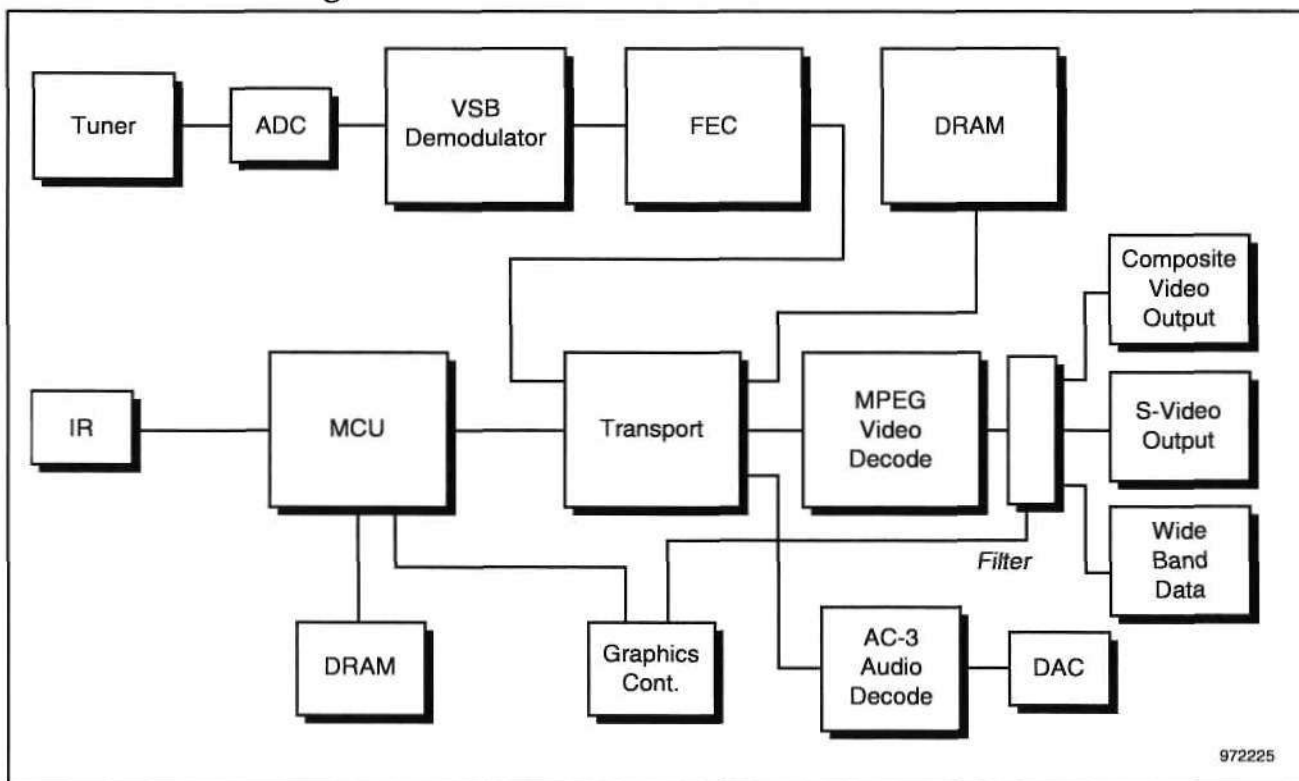
By 2001 and 2002, high-volume production of SDTV television sets will generate extremely large semiconductor sales. In this time frame, the Japanese digital HDTV market will begin, requiring higher-end chipsets similar to those used in U.S. digital HDTV television sets. ASSPs will continue to gain ground and geometries will fall to 0.25 and 0.18 micron.

### The Chips

As stated earlier, DTV designs resemble set-top box designs to a great degree, as shown in Figure 3-4, a block diagram of a U.S. DTV system. Figure 3-4 is meant to convey the functions within a DTV in a simple manner and does not reflect the actual design of any DTV chipset. Manufacturers' chipsets will vary in integration level and partitioning of functions.

Both digital set-top box receivers and DTV receivers require a front end with a tuner, analog to digital converter, demodulation, and error correction. On the digital side, both types of platforms use MPEG-2 transport and decoding, which is linked to DRAM. Other common digital features include an audio decoder, a microcontroller with memory, and logic for interfacing to devices like remote controls. To interface with the display and speakers, both types of system require video and audio encoding features with digital to analog conversion and digital signal processing.

**Figure 3-4**  
**Functional Block Diagram of a DTV Receiver**



Source: Dataquest (March 1997)

However, the resemblance between the two platforms can be deceptive. For example, the tuner must be able to accept both analog NTSC and DTV signals for it to be useful. In addition, MPEG-2 decoding for a full HDTV television set must be much faster than for a conventional digital set-top box and may require a much larger amount of memory. Thus, it is not a matter of semiconductor companies simply retargeting their existing set-top box solutions at the DTV market.

In this section we will look at key functional blocks on the diagram in detail.

### The Front End

The front end of a DTV system is very similar to that of a digital set-top box. Like a digital set-top box, the tuner must be able to receive modulated digital signals from a tuner, convert them to a digital format, demodulate them, and then perform error correction.

#### Tuner

The tuner in DTV receiver will be based on a different design than conventional tuners in digital set-top boxes. The performance must be higher than standard tuners in digital set-top boxes. For full HDTV and SDTV television sets, the tuner must be capable of receiving both DTV and NTSC signals. For DTV set-top boxes, the tuner need only receive DTV signals.

### **Demodulation**

In the FCC-approved U.S. DTV system, the format for demodulation is Vestigial Side Band (VSB). For terrestrial broadcast, the format used is eight-level VSB (8-VSB). In design, the VSB demodulation is very similar to existing QAM and QPSK demodulators used in cable and satellite digital set-top boxes. However, there are key differences between VSB and the other types of demodulation chips. VSB demodulators must support trellis demodulation. For the European DVB-T DTV system, COFDM demodulation is required.

### **The Back End**

Like the front end, the back end of a DTV receiver bears a great deal of similarity to that of a digital set-top box, but with some key differences. This section will examine some of those differences and similarities.

### **Transport**

The transport demultiplexing portion of a DTV set-top box will be required to operate at much higher rates than equivalent devices in digital set-top boxes. Because HDTV signals use the high-level MPEG-2 resolutions, they must be processed at a much higher rate than conventional main level MPEG-2 signals used in digital set-top boxes. The transport chip must accommodate data at rates of 80 Mbps, compared to 15 Mbps maximum for main level MPEG-2 decoding. Some semiconductor companies believe they can adapt their present, main-level MPEG-2 transport demultiplexing chips to high-level data rates by increasing clock speeds, or by changing the interface from serial to parallel.

### **MPEG Video Decoding**

The segment of the DTV receiver that is most different from a conventional digital set-top box is the MPEG-2 decoder. Conventional digital set-top boxes and DVD players use MPEG-2 decoders that comply with the main level of the specification, which has a maximum resolution of 720 x 480 and operates at a data rate of 15-megabits per second. In contrast, DTV receivers of all stripes must be able to decode MPEG-2 video that complies with the high-level resolutions of the specification and must accommodate data at a rate of 80-megabits per second. Thus, no current MPEG-2 decoders on the market will be capable of operating in a DTV receiver.

Semiconductor companies currently are developing high-level MPEG-2 decoders that use a variety of approaches to support the faster data rates and sharper resolutions of the high level. With data rates about five times higher, semiconductor companies believe that some portions of their chips will have to be many times as complex as before.

A prime consideration for MPEG-2 decoders used in DTV receivers is the requirement to support all types of DTV transmissions. All kinds of DTV receivers, ranging from \$2,876 HDTV television sets to \$270 DTV STBs, must be able to decode high-level MPEG-2 video. However, HDTV television sets must be capable of displaying the video in high resolution, while the SDTV television sets and DTV STBs need only to support display in standard resolutions. The HDTV television sets can use more expensive electronics to perform decoding, while the SDTV television sets and DTV STBs need to use the cheapest possible silicon to cut costs.



For many semiconductor companies, the approach to dealing with these two markets will be to offer two different types of MPEG-2 decoders. The first type of MPEG-2 decoder would be targeted at the full HDTV television set and would be required to decompress and output high-level, HDTV-resolution video. Such a device would be far more complex than a conventional main level MPEG-2 decoder and would require a large amount of memory to perform decompression.

The second type of MPEG-2 DTV receiver decoder would be able to receive and decode high-level MPEG-2 video, but would output only main-level resolution images. Such a device would bear a close resemblance to a conventional main-level MPEG-2 decoders, but would require more processing power, increasing the gate count of such a device by as much as 20 percent, according to some estimates. Such a device could use the same amount of video decoding memory as a main-level MPEG-2 decoder (about 2MB minimum), significantly reducing system costs compared to a full HDTV decoder.

While some semiconductor companies are planning to develop two distinct chips to address these two levels of performance, others are looking at different approaches. For example, one approach involves the use of two identical MPEG-2 decoders. In an HDTV design, each of the two decoders performs half of the decompression task. In an SDTV design, only one of the decoders is used, cutting video decompression and memory logic usage in half.

#### **Video Memory**

As stated before, because of the larger number of pixels per frame, high-level MPEG-2 decoding requires a larger amount of DRAM to support video decompression than conventional main-level decoding. Estimates of how much memory is required vary radically. Compression ratio has an enormous impact on the amount of memory required and companies are developing techniques to decrease memory usage by increasing compression ratio. Dataquest is estimating that initial requirements for HDTV receivers will be about 64Mb, compared to just 16Mb for conventional set-top boxes. For SDTV television sets and DTV STBs, memory usage is expected to be similar to that of a digital set-top box.

#### **Audio Decoding**

The ATSC DTV standard specifies the use of AC-3 digital audio compression. AC-3 will be used in all types of DTV receivers as well as in DVD players and in some digital set-top boxes. Because of the newness of AC-3, it is a somewhat more expensive function than the MPEG-2 audio used in most digital set-top boxes today.

#### **Microcontroller**

The microcontroller used in a DTV receiver is likely to require a higher level of processing power than that found in a digital set-top box because of the larger amount of data in a DTV system. In addition, DTV receivers will be capable of taking high-rate data input from over the airwaves, allowing them to double as data access terminals. This will require graphics and processing capabilities beyond what a conventional set-top box offers. The base level processor will likely be a 32-bit chip.

### Graphics and Video Filtering

Some baseline graphics control and acceleration will be required in all kinds of DTV receivers. Requirements will increase with more expensive, full-featured boxes. A key portion of the ATSC-compatible DTV receiver will be the video scaling and interpolation portion of the system. The ATSC specification comprises 18 different display formats. To ensure that a DTV receiver's screen won't go black when it encounters an unknown type of broadcast signal, many believe a receiver must be able to convert signals in all those formats to fit its display type. However, it is likely that the broadcast community will gravitate to a few key resolutions and scanning types. Key formats may be the 1920 x 1080 interlaced at 60 frames per second with a 16 x 9 aspect ratio; the 1280 x 720 resolution progressive at 30 frames per second and a 16:9 aspect ratio; and the 640 x 480 with 60 and 30 frames per second with both interlaced and progressive scanning. It is vital that filtering and scaling logic be able to support conversion of these broadcast formats to a form suitable for display.

## Semiconductor Costs

Table 3-4 presents a bill of materials estimate for an HDTV television set complying to the U.S. ATSC DTV standard. Semiconductor content will start at \$210.47 and will fall to \$109.63 by 2002. The bill of materials will average about \$40 cheaper for SDTV television sets and DTV STBs because of the use of a cheaper MPEG-2 decoder and less memory.

**Table 3-4**  
**HDTV Semiconductor Bill of Materials Forecast (Dollars)**

	1998	2000	2002
MPEG-2 Decoder High Level	43.00	31.39	22.91
AC-3 Decoder	13.31	9.72	7.09
Audio DAC	3.70	2.80	2.13
Transport	18.05	13.18	9.62
Microcontroller	8.00	8.00	8.00
Demodulator	11.50	7.81	5.30
Error Correction	12.00	8.15	5.53
Tuner	30.00	20.37	13.83
ADC	2.70	1.83	1.24
Video Compression DRAM (64Mb)	35.00	20.88	12.45
MCU DRAM (16Mb)	8.71	6.95	6.95
MCU ROM	2.50	2.50	2.50
Graphics and Video Scaling and Filtering	10.00	7.30	5.33
DAC	5.00	3.75	2.81
Analog Processing	7.00	5.25	3.94
<b>Total</b>	<b>210.47</b>	<b>149.86</b>	<b>109.63</b>

Source: Dataquest (March 1997)

## Chapter 4 Conclusion

---

The bottom line in the DTV market is that it cannot be ignored. Within five years, worldwide production of DTV receivers will be about equivalent to the number of digital satellite set-top boxes manufactured in 1996, a business that already has attracted enthusiastic participation and intense competition by chip companies. In the United States, DTV in the next century will grow to be as big or bigger than the color television market as the government-imposed expiration of analog broadcast looms.

Each DTV receiver will have a much higher semiconductor content than a conventional analog television, further increasing the semiconductor opportunity. DTV receivers also will have higher performance demands, requiring more sophisticated silicon than their close cousins, the digital set-top boxes.

Because of its enormous growth potential and the performance demands of its platforms, DTV will emerge as both the volume and technology driver for the entire digital video market. Semiconductor suppliers that are successful in the DTV market will be able to leverage their technology into other digital video products, including DVD players, digital VCRs, digital satellite and cable set-top boxes, and even DTV-enabled PCs. Thus, for any semiconductor maker hoping to be a long-term supplier to consumer video equipment makers, participation in the DTV market is a must.

However, it is important that semiconductor companies be aware of the real volume opportunities in the DTV market. Although HDTV has grabbed the headlines, the big money in DTV is in the SDTV television sets and DTV STBs. These platforms will have some of the performance-demanding features of the HDTV television sets but will put a premium on affordability, requiring semiconductor solutions that reduce cost at the system level.

So, as semiconductor companies try to discern the true nature of DTV, they should keep these points in mind:

- Be sure to have all the key digital television technologies in-house. As integration increases in DTV designs, it will be vital to be able to offer a complete set of functions to customers. Companies hoping to play in the digital portion of the DTV market must be able to offer everything, from a main-level MPEG-2 decoder to a microcontroller and graphics and video scaling logic.
- Hit the important points in the design cycle. DTV receiver production will begin in 1998, but the real volume opportunities will begin later. It is key to have parts designed into SDTV television sets and DTV STBs that will enter production in mid-1999 and 2000.
- Don't miss the biggest part of the market. Although the HDTV television sets will represent the earliest opportunity in the DTV market in the Americas and will use some of the highest-end, highest-margin

chips in the market, the real opportunity in the market over the next five years will be in the SDTV television sets. Make sure to develop the right kind of devices and system-level solutions to serve this market.

- Be prepared for the market to take unexpected turns. Changes in the regulatory environment in the United States and around the world could radically change the way the DTV market develops. This and other factors could throw a monkey wrench into the most carefully laid plans.
- Watch the computer industry. Although this report has concentrated on the consumer side of DTV, the real show in digital television could well turn out to be in sales of DTV-enabled PCs. Microsoft and Intel have ambitious plans on this front, and the two companies have been very active in lining up support from government, from broadcasters, and in standards organizations for their PC-centric view of DTV. As chips are specified and integration road maps are prepared, keep an eye on the needs of the PC market.

---

**For More Information...**

Jonathan Cassell, Industry Analyst ..... (408) 468-8195  
Internet address ..... jonathan.cassell @dataquest.com  
Via fax ..... (408) 954-1780  
Dataquest Interactive ..... <http://www.dataquest.com>

The content of this report represents our interpretation and analysis of information generally available to the public or released by responsible individuals in the subject companies, but is not guaranteed as to accuracy or completeness. It does not contain material provided to us in confidence by our clients. Reproduction or disclosure in whole or in part to other parties shall be made upon the written and express consent of Dataquest.

©1997 Dataquest—Reproduction Prohibited

Dataquest is a registered trademark of A.C. Nielsen Company

**Dataquest**  
A Gartner Group Company

## DATAQUEST WORLDWIDE OFFICES

### NORTH AMERICA

#### Worldwide Headquarters

251 River Oaks Parkway  
San Jose, California 95134-1913  
United States  
Phone: 1-408-468-8000  
Facsimile: 1-408-954-1780

#### East Coast Headquarters

Nine Technology Drive  
P.O. Box 5093  
Westborough, Massachusetts 01581-5093  
United States  
Phone: 1-508-871-5555  
Facsimile: 1-508-871-6262

#### Dataquest Global Events

3990 Westerly Place, Suite 100  
Newport Beach, California 92660  
United States  
Phone: 1-714-476-9117  
Facsimile: 1-714-476-9969

#### Sales Offices:

Washington, DC (Federal)  
New York, NY (Financial)  
Dallas, TX

### LATIN AMERICA

#### Research Affiliates and Sales Offices:

Buenos Aires, Argentina  
Sao Paulo, Brazil  
Santiago, Chile  
Mexico City, Mexico

### EUROPE

#### European Headquarters

Tamesis, The Glanty  
Egham, Surrey TW20 9AW  
United Kingdom  
Phone: +44 1784 431 611  
Facsimile: +44 1784 488 980

#### Dataquest France

Immeuble Défense Bergères  
345, avenue Georges Clémenceau  
TSA 40002  
92882 - Nanterre CTC Cedex 9  
France  
Phone: +33 1 41 35 13 00  
Facsimile: +33 1 41 35 13 13

#### Dataquest Germany

Kronstadter Strasse 9  
81677 München  
Germany  
Phone: +49 89 93 09 09 0  
Facsimile: +49 89 93 03 27 7

#### Sales Offices:

Brussels, Belgium  
Kfar Saba, Israel  
Milan, Italy  
Randburg, South Africa  
Madrid, Spain

### JAPAN

#### Japan Headquarters

Aobadai Hills 4-7-7  
Aobadai  
Meguro-ku, Tokyo 153  
Japan  
Phone: 81-3-3481-3670  
Facsimile: 81-3-3481-3644

### ASIA/PACIFIC

#### Asia/Pacific Headquarters

Suite 5904-7, Central Plaza  
18 Harbour Road, Wanchai  
Hong Kong  
Phone: 852-2824-6168  
Facsimile: 852-2824-6138

#### Dataquest Korea

Suite 2407, Trade Tower  
159 Samsung-dong, Kangnam-gu  
Seoul 135-729  
Korea  
Phone: 822-551-1331  
Facsimile: 822-551-1330

#### Dataquest Taiwan

11F-2, No. 188, Section 5  
Nan King East Road  
Taipei  
Taiwan, R.O.C.  
Phone: 8862-756-0389  
Facsimile: 8862-756-2663

#### Dataquest Singapore

105 Cecil Street  
#06-01/02 The Octagon  
Singapore 069534  
Phone: 65-227-1213  
Facsimile: 65-227-4607

#### Dataquest Thailand

12/F, Vanissa Building  
29 Soi Chidlom  
Ploenchit Road  
Patumwan, Bangkok 10330  
Thailand  
Phone: 662-655-0577  
Facsimile: 662-655-0576

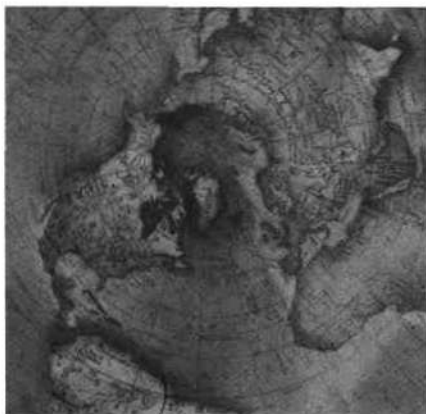
#### Research Affiliates and Sales Offices:

Melbourne, Australia  
Beijing, China

# Dataquest

A Gartner Group Company

©1997 Dataquest



FILE COPY:  
MARIA VALENZUELA

**Dataquest**

## **Digital Still Cameras Develop into a New Semiconductor Market**



**Focus Report**

---

**Program:** Consumer Multimedia Semiconductors and Applications Worldwide  
**Product Code:** MSAM-WW-FR-9701  
**Publication Date:** February 10, 1997  
**Filing:** Reports

# Digital Still Cameras Develop into a New Semiconductor Market



## Focus Report

---

**Program:** Consumer Multimedia Semiconductors and Applications Worldwide  
**Product Code:** MSAM-WW-FR-9701  
**Publication Date:** February 10, 1997  
**Filing:** Reports



# Table of Contents

	Page
1. Executive Summary .....	1
2. Getting Digital Still Cameras in Focus .....	3
What Are Digital Still Cameras? .....	3
Market Opportunity and Challenges .....	4
3. A Snapshot of the Digital Still Camera Market.....	7
Similar Markets .....	7
A Tale of Two Growth Scenarios.....	7
Scenario A: The Digital Still Camera as a PC Peripheral (Most Likely Scenario).....	7
Scenario B: The Digital Still Camera as a Consumer Product.....	9
Dataquest Perspective.....	11
4. Digital Still Camera Trends: Pricing, Features, and Technology .....	13
Price Trends .....	13
Future Price Trends.....	13
Digital Still Camera Feature Trends .....	15
Storage Capacity .....	15
Resolution .....	15
"Finished Film" Capability.....	15
Removable Storage .....	15
LCD Viewfinders and Viewers.....	16
Film Camera Features .....	16
PC Output .....	16
Unique Digital Still Camera Features .....	16
Digital Still Camera Semiconductor Market .....	17
Semiconductor Opportunity in Digital Still Camera Flash Memory Expansion Cards.....	18
Dataquest Perspective.....	19
5. Digital Still Camera Semiconductor Components.....	21
The Major Components.....	21
CCDs.....	21
CCD Support Chips.....	22
Digital Processing ASICs .....	22
Microcontrollers .....	22
Memory .....	23
Other Components .....	23
Directions for Digital Still Camera Semiconductor Integration .....	23
Analysis .....	24
Inside Digital Still Cameras .....	25
Casio QV-10A Plus .....	25
Kodak DC20.....	25
Digital Still Camera Makers.....	27
Dataquest Perspective .....	27

## List of Figures

---

Figure	Page
3-1 Worldwide Digital Still Camera Shipment and Revenue Forecast, Scenario A (Most Likely Scenario) .....	8
3-2 Worldwide Digital Still Camera Shipment and Revenue Forecast, Scenario B.....	10
3-3 Worldwide Digital Still Camera Shipment and Revenue Forecast Range .....	11
4-1 Digital Still Camera Price Declines .....	13
4-2 Digital Still Camera Price Trends.....	14
4-3 Worldwide Digital Still Camera Semiconductor Market Forecast (Based on Scenario A) .....	17
5-1 Generic Block Diagram of a Digital Still Camera.....	21
5-2 Integrated Digital Still Camera Block Diagram .....	23
5-3 Block Diagram of Casio QV-10A Plus .....	26
5-4 Block Diagram of Kodak DC20 .....	26

## List of Tables

---

Table	Page
3-1 Worldwide Digital Still Camera Shipment and Revenue Forecast, Scenario A (Most Likely Scenario).....	9
3-2 Worldwide Digital Still Camera Shipment and Revenue Forecast, Scenario B.....	10
4-1 Worldwide Digital Still Camera Semiconductor Market Forecast (Based on Scenario A).....	17
5-1 Major Digital Still Camera Suppliers and Products.....	28

## Chapter 1

# Executive Summary

---

Digital still cameras represent one of the most exciting new opportunities today, both for sellers of consumer electronic products and for the makers of the semiconductors used in them. These new products take photography and move it into the realm of computers, allowing users to point, click, and create digital images that are ready to be imported into PCs. This report studies digital still cameras and evaluates the opportunities for semiconductor makers that supply this market.

Data and forecasts on numerous aspects of the business are presented in the report, including:

- A forecast of digital still camera shipments through the year 2000
- A forecast of the digital still camera semiconductor market through the year 2000
- An estimate of digital still camera pricing and feature trends
- A listing of digital still cameras, their makers, and their features
- Block diagrams of the internals of some of the most popular digital still cameras on the market today

Key findings of the report include:

- Because of cost and resolution limitations, digital still cameras will not be an adequate replacement for conventional film cameras for several years to come. Although prices will decline, digital still camera average selling prices (ASPs) will remain far above those for film cameras. Also, image resolutions for digital still cameras are far below those offered by much cheaper film cameras. These factors will dissuade consumers from buying digital still cameras for general photography uses.
- Digital still cameras are likely to be used primarily as PC peripherals over the next few years. Although digital still camera resolutions are too low for general photography, they are a perfect fit for personal computer displays. Thus digital still cameras for the next three years will be used as a relatively straightforward and easy way to bring photographs into computers. They will be a useful device for those who have a need or desire to place photographs on the Internet, into desktop publishing, or in other PC applications.
- Although digital still camera ASPs will remain higher than those for film cameras, prices are expected to drop dramatically over the next few years. Digital still camera prices will gravitate to a few key, affordable price points. As with PCs, digital still camera prices will remain fixed at defined points, but products will attain steadily increasing capabilities because of advances in semiconductor technology.
- Fed by rapidly rising sales, the digital still camera semiconductor market will grow rapidly in 1997 and 1998. However, growth will level off in 1999 as digital still camera sales increases level off.

- Digital still camera designs use a combination of off-the-shelf standard products and ASICs. Cameras typically use about 12 major chips. Future digital still camera designs will employ more highly integrated application-specific standard products that will reduce chip count and system cost.
- Charge-coupled devices (CCDs) used in digital still cameras for sensing light are a major cost factor, as they frequently are the most expensive component in these products. Technology developments in CCDs and other light-sensing technologies will help reduce digital still camera prices.

## Chapter 2

# Getting Digital Still Cameras in Focus

---

The digital still camera is one of the most exciting new applications for semiconductor technologies in the consumer electronics world today. Exciting because it opens up new opportunities for semiconductor sales in a market where there is an existing, proven demand for a product. Exciting because it uses semiconductors to transform the camera—a device based on 158-year-old chemical processing techniques—into a state-of-the-art consumer electronic product that outputs clean, computer-friendly digital images. Exciting because it brings photography into the digital realm, allowing the camera to play a key role in the Internet revolution. Exciting because it turns the camera from a product whose features and functions are largely fixed into a device where new frontiers of innovation are within reach.

### What Are Digital Still Cameras?

Digital still cameras are the electronic equivalents of film cameras. They are intended to record and store still images. However, instead of using light-sensitive film that must be chemically treated before images are viewed, digital still cameras utilize semiconductor technology to record, process, and store still images.

The digital still camera offers several advantages compared with the conventional film camera. First, it eliminates film, saving natural resources, such as the silver used in development of photos. Also, an effluent discharged from chemical treatment of conventional films is eliminated to help reduce environmental pollution. In general, it is easier and simpler to develop digital photos compared with film development. Together, these factors save consumers the costs they incur from owning a camera.

Another key advantage of digital still cameras is that they allow users to immediately view images of pictures that have been taken (if the camera has an LCD viewer) so they can appreciate the image or choose whether or not to keep the shot or discard it. Because of the high semiconductor content of digital still cameras, features can be added and enhanced with no additional cost to the platform, allowing users to receive steadily increasing value for their digital still camera buying dollar.

Because they record images in a digital format, digital still cameras are ideal for use with computers, providing a relatively straightforward way to import images into PCs. This allows anyone who owns a computer and a color printer to view, edit, and print his or her own photos. Digital still camera images can be edited and manipulated using a computer or easily stored and compressed on a hard drive, making digital still cameras excellent devices for creating image archives. With the widespread use of desktop publishing and the rapid growth of the Internet as a communications and information dissemination medium, digital still cameras are an extremely useful computer peripheral.

## Market Opportunity and Challenges

While digital still cameras represent an exciting market, they are not a very well-understood market. This is because it is unclear—even to the most experienced players—what the true nature of digital still cameras is, what their price points are, and what their true potential for growth is. Semiconductor and consumer electronic companies view the vast potential of the digital still camera market covetously. Nearly everyone in the developed world owns a film camera. They are used in a vast number of ways, from creating personal mementos, to identification, to advertising, to fine art. The potential now exists for each of the millions of film cameras sold every year to be transformed into a digital still camera, loaded with semiconductor content. Some companies selling digital still cameras and related components anticipate that these quickly will become a top-selling consumer product, with sales soon rivaling those of film cameras.

However, serious obstacles remain in the path of the widespread acceptance of digital still cameras as a consumer product. Price, image quality, and infrastructure are conspiring to keep digital still cameras a niche product through the remainder of the decade. The niche that digital still cameras will fill is that of a computer peripheral. Because of that, Dataquest believes digital still camera sales will not reach the volumes enjoyed by film cameras for several years to come.

Whether PC peripheral or consumer phenomenon, the digital still camera market offers a significant new opportunity for semiconductor and consumer electronic makers. Digital still cameras require a variety of types of semiconductor technologies, including optoelectronics, analog, and mixed signal devices, powerful microprocessors, application-specific ICs (ASICs), and nonvolatile memory. With cost a paramount issue in the digital still camera market, companies that can provide the least-expensive implementation of these building blocks will be successful.

The following is a list of definitions for words and phrases used in this report.

- **Digital still camera:** A camera that records images or video using digital technology and stores images or video in a digital format. Includes both digital still and digital camcorders.
- **Digital still camera:** A camera that records still images using a charge-coupled device or CMOS sensor and stores images in a digital format, typically in nonvolatile memory. Does not include scanners, digital video camcorders or videoconferencing cameras.
- **Digital video camcorder:** Records and stores video in a digital format. Records images using a CCD or CMOS sensor and then stores them on digital magnetic tape. Uses a discrete cosign transfer algorithm to compress video. Digital video camcorders use the digital videocassette (DVC) standard from Sony.
- **Film camera:** A conventional still camera that records and stores still images using film that is developed with a chemical process. Includes 35mm, single-lens reflex (SLR), and instant types of cameras.

- **Charge-coupled device:** An optoelectronic device that can convert photons into electrons. The electrical signals can then be converted into digital signals and processed.
- **CMOS sensor:** A semiconductor device fabricated using conventional CMOS processing that can convert photons into electrons.
- **Joint Photographic Experts Group (JPEG):** A standard compression algorithm for high-quality still images that is used in some digital still cameras.
- **Miniature Card:** A removable flash memory storage card that can serve as "film" for digital still cameras. At 38mm x 33mm x 3.5mm in size, the Miniature Card uses Intel- or Advanced Micro Devices-type NOR flash and can work with other types of volatile and nonvolatile memory. Miniature Card can interface to a PCMCIA slot using a PC Card adapter. The cards can communicate with systems that have host-based filing software, such as Flash Translation Layer (FTL). A Miniature Card can plug into a PCMCIA slot using a PCMCIA Type II adapter card.
- **CompactFlash:** A removable memory storage card that can serve as "film" for digital still cameras. At 36.4mm x 42.8mm x 3.3mm, the CompactFlash card is based on SanDisk Corporation's flash memory technology. CompactFlash is compatible with the PCMCIA ATA standard and can plug into a PCMCIA slot using a Type II PC Card adapter card.
- **Solid-State Floppy Disk Card (SSFDC):** A removable memory storage card that can serve as "film" for digital still cameras. At 45mm x 35mm x 0.76mm in size, SSFDC cards use the NAND type of flash manufactured by Toshiba and Samsung. An SSFDC card can plug into a PCMCIA slot using a Type II PC Card adapter card.



## Chapter 3

# A Snapshot of the Digital Still Camera Market

---

### Similar Markets

Because of digital still cameras' functional resemblance to film cameras, it is useful to look at the film camera market to understand their growth potential. Worldwide film camera sales stood at 50 million units in 1995, according to the Photo Marketing Association International (PMAI). In the United States, film cameras in 1995 had an ASP of about \$91. Film camera sales actually have declined in the United States in recent years, dropping to 14.7 million units in 1995, down from 15.4 million units in 1990, according to the PMAI.

Digital still cameras also can be compared with other types of equipment that they resemble, namely handheld and flatbed scanners. Like those scanners, digital still cameras are designed to produce images that are in a digital format. Also like scanners, digital still cameras can be viewed as PC peripherals. Unit sales of such scanners are expected to grow at a compound annual growth rate (CAGR) of 26.1 percent between 1994 and 1999, reaching total sales of 7.4 million units in 1999.

For those playing in the digital still camera market, a major question is, will the digital still camera follow the lead of the film camera, becoming a high-volume, must-have consumer product? Or will it follow the lead of the scanner, becoming a much lower-volume computer peripheral used for niche applications?

### A Tale of Two Growth Scenarios

The growth of the digital still camera market can be viewed in two ways: a conservative growth path (Scenario A) and a highly aggressive growth path (Scenario B). Both scenarios could account for digital still camera shipments eventually surpassing those of conventional film cameras. However, the timing of that event varies radically, depending on the scenario.

#### **Scenario A: The Digital Still Camera as a PC Peripheral (Most Likely Scenario)**

Scenario A envisions digital still cameras remaining a computer peripheral through the end of the century. In this scenario, digital still cameras are used primarily as an easy and straightforward way to bring images into computers. As such, the total available market will be limited to computer users and further narrowed to hobbyists and those who have some professional need to have photographic images in a digital format. Most users of digital still cameras will be hobbyists and those who need to place photographs on the Internet or in desktop publishing applications. Other users include photographers for real estate companies, insurance companies, and newspapers and other time-sensitive publications.

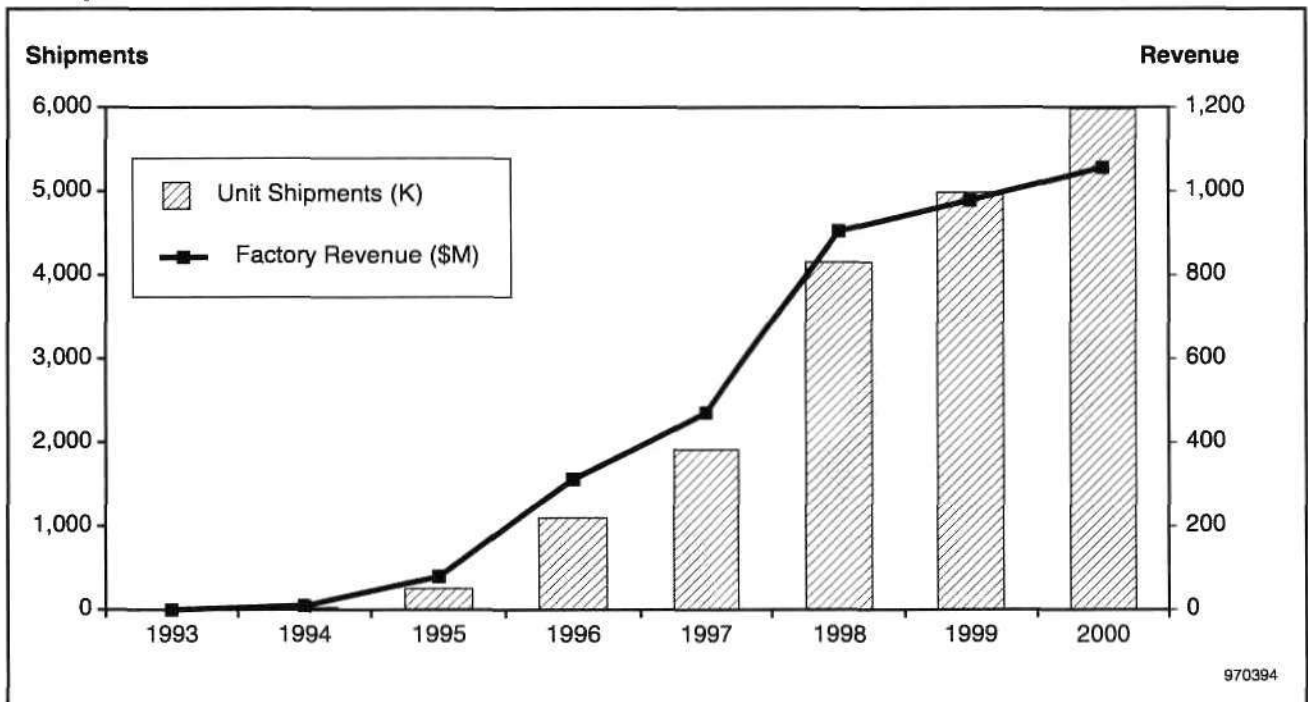
This scenario envisions that digital still cameras will not replace conventional film cameras to a significant degree over the next three years for several reasons. First, digital still cameras at consumer price points offer image resolutions that are far below those offered by conventional film

cameras. Although digital still camera features and quality will improve markedly, digital still cameras will not meet the standards of average consumers who want to view sharp photographic prints. Second, although digital still camera prices will fall over the next few years, their cost will remain much higher than the lowest-cost film cameras through the end of the century, making customers stick to their cheaper, more familiar film cameras. Third, with acceptance among consumers low, existing development facilities will have no incentive to obtain digital development systems. Fourth, with no printing capabilities available at development facilities, most consumers will have no readily available way to obtain on paper images made with digital still cameras, besides printing from computers. Fifth, new types of film cameras will bring some of the benefits of digital photography to more conventional and affordable film cameras, reducing the desire of consumers to make a wholesale move to digital technology.

After the year 2000, digital still camera technology, pricing, and supporting infrastructure may have evolved to the point at which they offer a superior alternative to film cameras. In the following five years, the door could be open for significant growth, with digital still camera sales equaling or even surpassing those of their film predecessors.

Figure 3-1 and Table 3-1 show digital still camera sales growth according to Scenario A. Digital still camera sales are expected to boom in late 1997 and in 1998 as prices for good quality, full-featured products fall into the range of \$200 or less for the first time. However, sales growth after this point will slow somewhat as the available market among computer users reaches the point of saturation, similar to sales of handheld and flatbed scanners.

**Figure 3-1**  
**Worldwide Digital Still Camera Shipment and Revenue Forecast, Scenario A (Most Likely Scenario)**



Source: Dataquest (January 1997)

**Table 3-1**  
**Worldwide Digital Still Camera Shipment and Revenue Forecast, Scenario A**  
**(Most Likely Scenario)**

	1993	1994	1995	1996	1997	1998	1999	2000	CAGR (%) 1995-2000
Unit Shipments (K)	0	30	254	1,100	1,914	4,154	4,984	5,981	88.1
Manufacturers' ASP (\$)	0	330	315	283	246	218	196	177	-10.9
Factory Revenue (\$M)	0	10	80	311	471	906	977	1,059	67.6

Source: Dataquest (January 1997)

### **Scenario B: The Digital Still Camera as a Consumer Product**

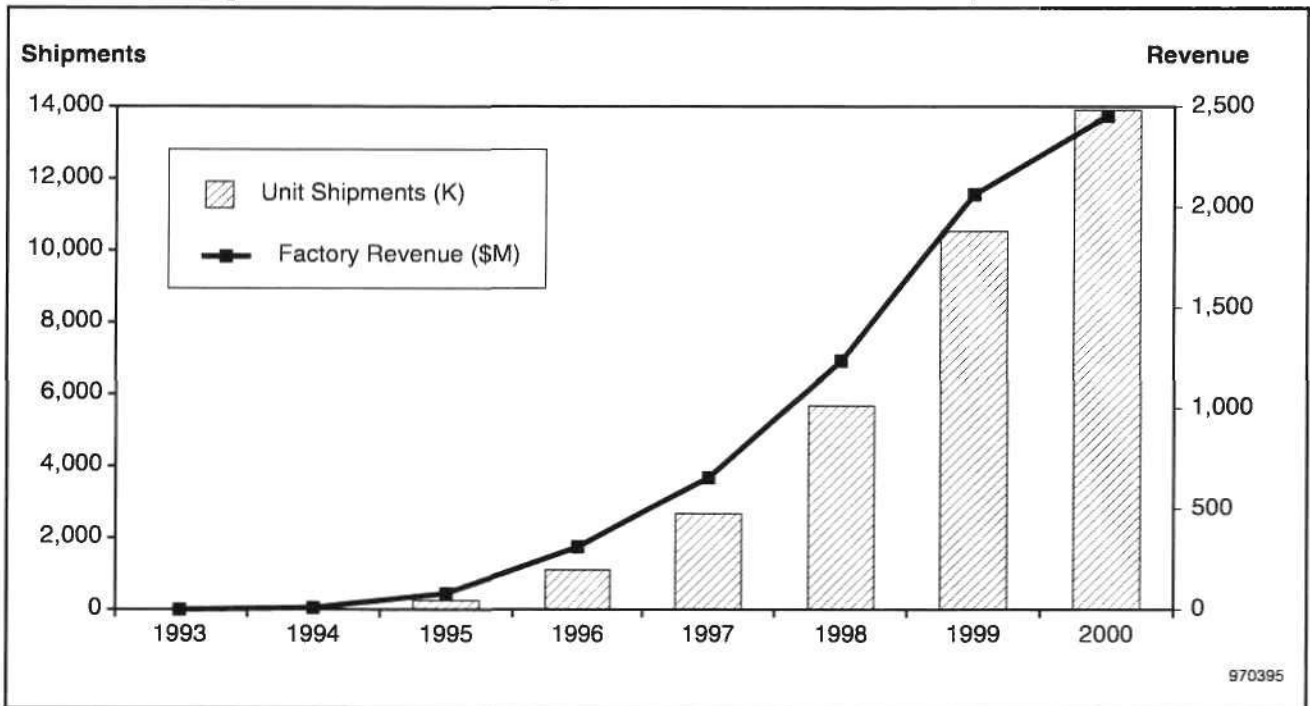
The second way the digital still camera can be viewed is as a device that serves as a replacement for the conventional film camera but eventually evolves into a new type of consumer electronic product. First, in this scenario, the digital still camera uses its PC base as a springboard into the consumer market. Enamored with the advantages of digital still cameras compared with their film predecessors, consumers will flock to the new product in droves. Second, prices will fall and key parameters of digital still camera desirability, such as storage capacity and resolution, will improve markedly. Thus, the potential market for digital still cameras becomes the approximately 50 million consumers who buy film cameras in a year.

Third, an infrastructure for developing digital images will emerge, with photographic development facilities obtaining the capability to print, enhance, and edit pictures taken with digital still cameras. Those shops will use high-performance printers and computers to produce quality images. Fourth, standards will be defined and widely accepted for development of digital film, as well as for removable nonvolatile memory cards and for moving data to the Internet. Fifth, digital still cameras will no longer be an image input device for PCs and instead will evolve into a handy digitized recorder for general consumers, in much the same way that the diary, the tape recorder, and other gadgets have been used to record daily life. With this role, digital still cameras in the next century will have the potential to outgrow the film camera market.

Figure 3-2 and Table 3-2 forecast growth for digital still cameras, based on the assumptions in Scenario B. From 1996 through 1999, digital still camera shipments will grow smoothly, with unit shipments about doubling every year as more and more consumers jump on the digital still camera bandwagon. In the year 2000, unit shipment growth will level off somewhat as the consumer buying wave subsides. In the next century, digital still camera shipments could grow to exceed those of film cameras.

Figure 3-3 shows both forecasts as a range on a single chart. Clearly, the two forecasts offer starkly different visions of the future of the digital still camera market for the remainder of the decade.

**Figure 3-2**  
**Worldwide Digital Still Camera Shipment and Revenue Forecast, Scenario B**



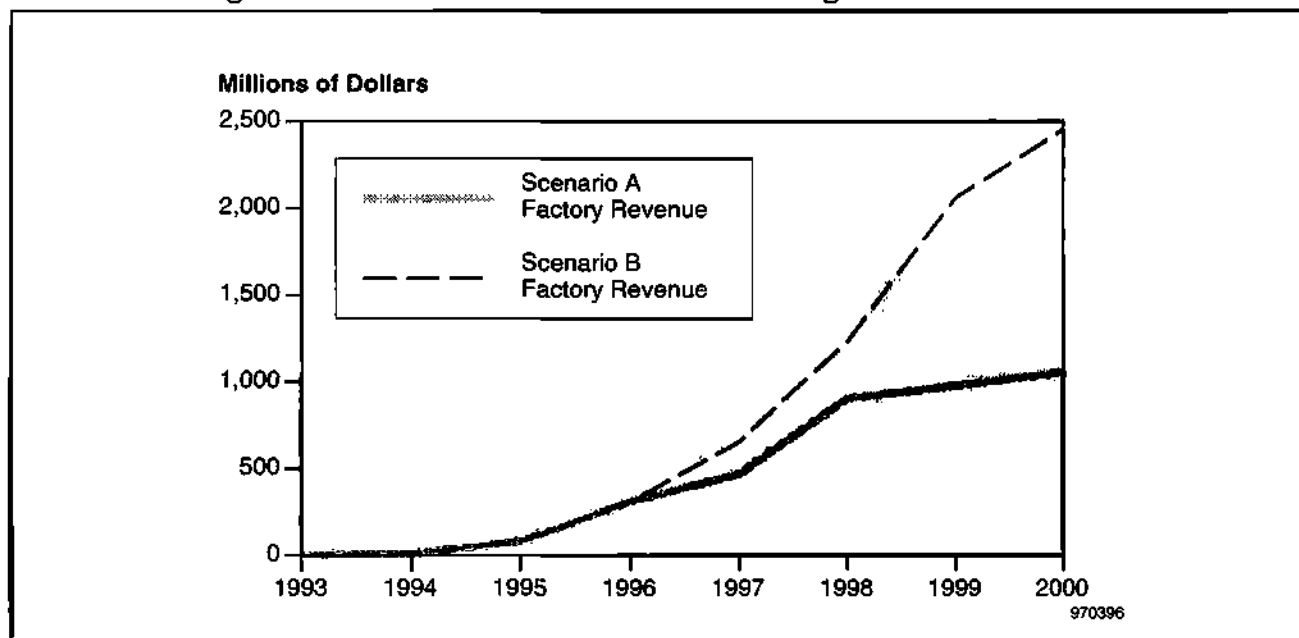
Source: Dataquest (January 1997)

**Table 3-2**  
**Worldwide Digital Still Camera Shipment and Revenue Forecast, Scenario B**

	1993	1994	1995	1996	1997	1998	1999	2000	CAGR (%) 1995-2000
Unit Shipments (K)	0	30	254	1,100	2,667	5,670	10,524	13,902	122.7
Manufacturers' ASP (\$)	0	330	315	283	246	218	196	177	-10.9
Factory Revenue (\$M)	0	10	80	311	656	1,236	2,062	2,461	98.4

Source: Dataquest (January 1997)

**Figure 3-3**  
**Worldwide Digital Still Camera Revenue Forecast Range**



Source: Dataquest (January 1997)

### Dataquest Perspective

Based on prevailing trends in the digital still camera market today, Dataquest believes Scenario A is the most likely path for the future of the market.

The primary issue is bang for the buck. Digital still camera ASPs will remain far above those for film cameras for the remainder of the century, even for the lowest-cost products. The ASP of film cameras was \$91 in 1995. Fine film cameras are available at prices of \$50 or less. By the end of the century, digital still camera ASPs will remain well above that level. That price differential will force consumers to consider the reasons why they should buy a digital still camera rather than purchase a familiar film camera that costs far less.

One of the first things consumers will consider is image quality. The 35mm type film camera has a resolution of 10 million pixels. That's 400 times greater than some of the most affordable digital still cameras, which have resolutions as low as 250,000 pixels. Film cameras enjoy this resolution advantage even when they cost \$50 or less. For more than \$1,000, digital still cameras are available that offer resolutions comparable to film cameras; however, those prices are completely out of reach of the average consumer. Those types of digital still cameras will remain too costly for several years to come. Consumers who are used to viewing fine-quality prints on paper will not be disposed to buying higher-priced cameras that offer lower-resolution prints. The primary cost advantage of digital still cameras to the consumer—which is the elimination of film—will be overshadowed by the higher price of the camera and the lower quality of the prints on paper.

With consumer acceptance of digital still cameras low, film development facilities will not be willing to invest in technology required to print digital photographs. This will happen despite the efforts of Kodak and others to make development equipment easy to use and widely available to photographic shops.

Meanwhile, new types of film cameras will enter the market that offer some of the advantages of digital still cameras. For example, the Advanced Photo System (APS) from Kodak and Fuji uses some digital technology to improve the functions of film cameras. APS cameras offer more flexibility than film cameras, allowing photographs to be developed in three picture sizes and correcting exposure and artificial lighting to improve the quality of photographs.

These factors will constrain digital still camera shipment growth and keep it from becoming a high-volume consumer product before the end of the century.

However, it is not Dataquest's opinion that digital still cameras can never become a high-volume consumer product. On the contrary, Moore's law makes it virtually inevitable that digital still cameras eventually will be able to achieve such vast superiority in quality and in features over their film predecessors that the price differential no longer will be an obstacle to consumers. When that occurs, digital still cameras may achieve the role of handy digitized recorders as forecast in Scenario B but not until sometime after the year 2000.

Further, other factors may arise that could push digital still camera shipments closer the levels predicted in Scenario B. For example, faster-than-expected advances in resolution and cost reduction of CCDs could make digital still cameras a more reasonable alternative to film cameras in the near future. In addition, new technologies such as CMOS sensors could provide a quantum leap in resolution and cost compared to CCDs, making digital still cameras more attractive than film cameras very quickly. Furthermore, with the growth of the Internet as a communications medium among individuals, it may emerge as a preferred way for many average people to exchange or distribute photographs. Lower-resolution digital photographs are smaller in size and are easier to transfer over networks such as the Internet. Thus, the lower resolutions and higher prices of digital still cameras may become more acceptable to average consumers.

# Chapter 4

## Digital Still Camera Trends: Pricing, Features, and Technology

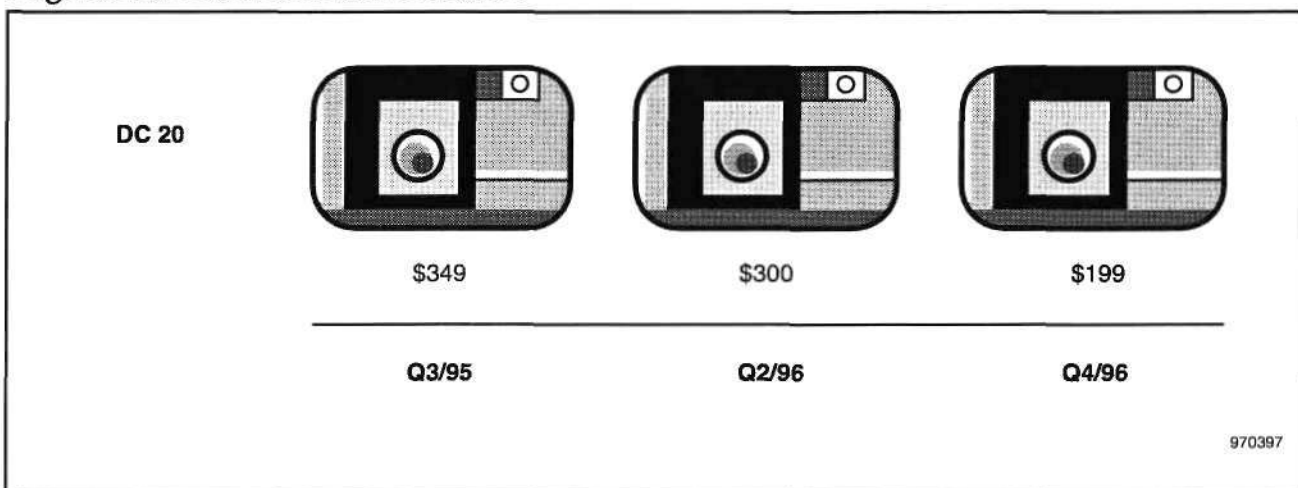
### Price Trends

Pricing for digital still cameras is rapidly falling as the products ride down the semiconductor learning curve. Prices for some simple types of digital still cameras have dropped from as high as \$300 in early 1996 to as low as \$200 by the end of the year (see Figure 4-1). Camera makers are realizing reduced prices because of declining component costs, particularly for flash memory. Also, second- and third-generation cameras that use more cost-effective, easier-to-assemble designs are entering the market. The manufacturer's ASP for a digital still camera has dropped to \$156 in 1996, down from \$173 in 1995.

### Future Price Trends

With the cost digital still cameras in flux, price points for the products have not yet been set. A look at the range of digital still camera prices and features reveals a market in a state of pricing chaos, with manufacturers groping to discover ASPs that consumers will deem good values. However, that chaos will settle into order over the next three years as digital still cameras will fall into price points where the features and capabilities of the products constantly improve but the ASPs remain fixed. This is a price dynamic similar to that found in the PC market. Like PCs, digital still cameras will continually benefit from the semiconductor learning curve, which allows steady improvements in resolution, storage capacity, and features while prices remain about the same.

Figure 4-1  
Digital Still Camera Price Declines

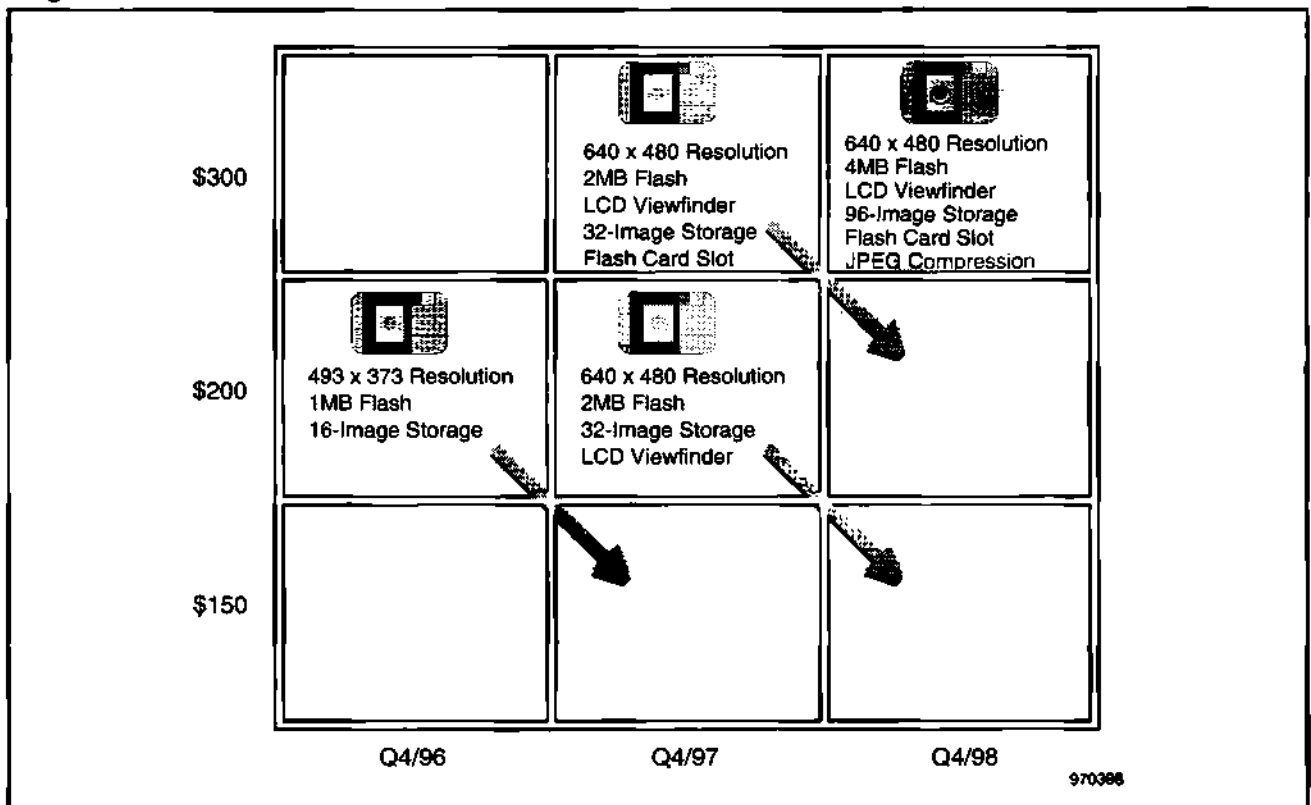


Source: Dataquest (January 1997)

Figure 4-2 forecasts how this pricing trend may develop over the next few years. Digital still camera makers are unsure what price points may emerge in the market. However, for the sake of this analysis, Dataquest is setting three key digital still camera price points at \$300, \$200, and \$150, which represent affordable price levels. Actual prices, dates, and feature sets may vary. The figure is intended to demonstrate how, at each price point, digital still cameras steadily will gain more and more features.

Although camera prices will fall into fixed price points that have yet to be determined, manufacturers' ASPs will drop through the year 2000. This is accounted for by products gravitating toward a few key price points that are affordable to most users. Sales of cameras costing in the \$1,000 range and higher and targeted at professional applications will decline as a percentage of overall digital still camera sales, also contributing to the reduction in manufacturers' ASPs. Despite this, the overall ASP for all digital still cameras will remain well above the \$91 price for comparable film cameras for the remainder of the decade and will not fall into the under-\$100 range for quality cameras.

**Figure 4-2**  
**Digital Still Camera Price Trends**



Source: Dataquest (January 1997)



## Digital Still Camera Feature Trends

The value of a digital still camera can be classified most simply by measuring resolution and storage capacity. However, purchasers frequently prefer one digital still camera over another based on other parameters, including design, presence of an LCD screen, and availability of a flash bulb. This section looks at the various features that can influence a digital still camera buyer.

### Storage Capacity

Current cameras at the lowest price points have the capability to store from 16 to 32 images, while higher-priced cameras can store 200 images or more. Higher-resolution images require a larger amount of storage space. As flash memory prices decrease and densities increase, the number of pictures stored in digital still cameras is expected to grow. Removable storage technology also can increase picture capacity (see below). Some higher-priced digital still cameras use rigid disk drives (usually removable) for storage and are capable of holding quantities of extremely high-resolution photographs. These cameras include the Polaroid PDC-2000/40, which uses a 40MB hard drive to hold 40 images with resolutions of 1600 x 1200.

### Resolution

Some of the least-expensive cameras offer resolutions that are very low, such as the Casio QV-10A Plus, which has a resolution of 320 x 240. Midrange-price digital still cameras frequently have resolutions in the range of 640 x 480. Higher resolutions, such as 1280 x 1000 and 3060 x 2,036, are available mostly in high-end, high-priced digital still cameras. Over time, higher resolutions will be available in the digital still cameras that have lower price points.

### "Finished Film" Capability

Many lower-priced digital still cameras use nonstandard compression algorithms, while many higher-priced digital still cameras make use of the JPEG file format used in PC applications. The nonstandard compression algorithms typically are more efficient than JPEG, allowing them to be implemented with less expensive silicon. However, by compressing images in the industry-standard JPEG file format, digital still cameras produce what is known as "finished film," which makes it easier for consumers to move the photographs into their PCs. Some cameras use a combination of nonstandard compression for internal storage and JPEG compression for PC output, while others employ one or the other. Finished film capability will trickle down into lower-priced digital still cameras over the next several years.

### Removable Storage

Removable nonvolatile memory cards expand the photo capacity of digital still cameras. They also can allow easier exporting of digital images to computers and to development systems. Future PCs are expected to have removable storage slots that allow images to be loaded as if they were on a floppy disk. Since the first affordable digital still cameras with removable storage have only just recently entered the market, the jury is still out on the consumer acceptance of such devices. Those cameras tend to be priced

at \$500 or more. However, at least some low-priced cameras in the future will adopt removable card technology.

### **LCD Viewfinders and Viewers**

LCD viewfinders and viewers are one of the key features of digital still cameras that differentiate them from their film camera predecessors. LCD viewfinders allow photographers to view their subjects on a bright color screen that helps them to find out how the image will look when it is on a computer screen or when it is printed on paper. LCD viewers, which frequently serve as viewfinders as well, enable photographers to instantly view an image created and give them the option of deleting or keeping it. Small color LCDs have proved to be a popular feature on some cameras.

### **Film Camera Features**

Digital still cameras can enhance their value by adding features commonly found on film cameras. These features include flash bulbs and the capability to accept interchangeable lenses used with film cameras, such as zoom lenses. Some high-end digital still cameras have these capabilities at present, with lower-cost versions soon to follow.

### **PC Output**

Today's digital still cameras typically use serial cables to output images to personal computers. For small amounts of data—1 or 2MB—the 115-Kbps transfer rate of the serial port is adequate. However, as digital still camera memory increases in size, the transfer rate of the serial port will prove to be an inconvenience. Newer interface technologies—such as the Universal Serial Bus (USB)—offer faster transfer rates that cut download times. With USB becoming ubiquitous on PCs, future digital still cameras will adopt the interface technology to exploit its performance. Another technology used to speed image transfer is infrared, which sends data to the PC at relatively fast speeds without being physically interfaced to it. Removable storage schemes (see above) can further reduce the time it takes to export images.

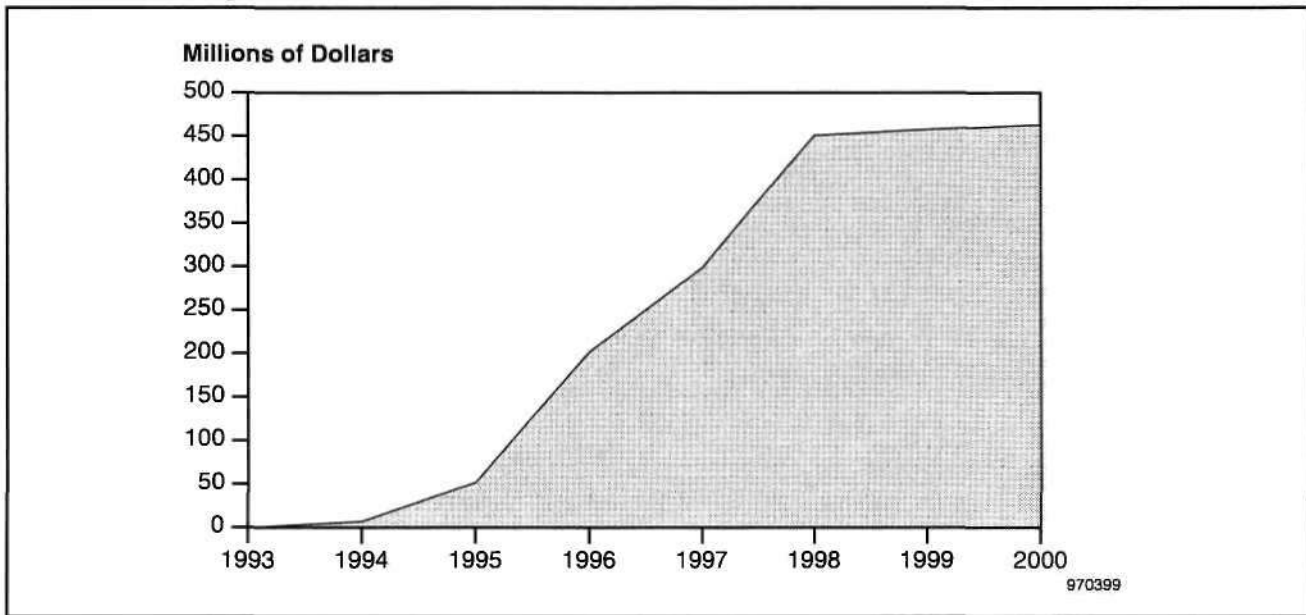
### **Unique Digital Still Camera Features**

Digital still cameras can enhance their value by adding features that take advantage of the unique characteristics of the platform. Sony, for example, is offering the DCS-F1, a digital still camera that can divide a single picture into separate sections, each recorded at 1/30-second intervals. This allows users to create a single picture consisting of numerous separate shots, allowing them to display motion far better than they could with a single shot. Such a function would be difficult or impossible with a conventional film camera. Other cameras, including the RDC-2, use compression and storage silicon to record sounds and even short moving sequences. These types of features can significantly enhance the value of digital still cameras in consumers' eyes.

## Digital Still Camera Semiconductor Market

Figure 4-3 and Table 4-1 show the growth of semiconductor shipments in the digital still camera market, based on Scenario A presented earlier in this report. The market offers tremendous opportunities for growth in chip sales. Semiconductor shipments will grow rapidly as sales of cameras ramp up from 1995 through 1997. However, in 1998, growth in digital still camera semiconductor revenue will flatten out as the value of the semiconductor content decreases dramatically.

**Figure 4-3**  
**Worldwide Digital Still Camera Semiconductor Market Forecast (Based on Scenario A)**



Source: Dataquest (January 1997)

**Table 4-1**  
**Worldwide Digital Still Camera Semiconductor Market Forecast (Based on Scenario A)**

	1993	1994	1995	1996	1997	1998	1999	2000	CAGR (%) 1995-2000
Unit Shipments (K)	-	30	254	1,100	1,914	4,154	4,984	5,981	88.1
Semiconductor Content (\$)	-	220	205	183	156	109	92	77	-17.7
Semiconductor Market (\$M)	-	7	52	202	299	451	458	463	54.8

Source: Dataquest (January 1997)

## **Semiconductor Opportunity in Digital Still Camera Flash Memory Expansion Cards**

A separate semiconductor market related to the digital still camera business will emerge around removable storage cards. Currently, three major standards have emerged for removable storage card technology: CompactFlash, Miniature Card, and Solid-State Floppy Disk Card. All three storage schemes are designed to provide a format for digital film using flash memory technology (as well as other types of memory, in some cases). Although the connectors used by the three flash cards vary, they all can interface with a PCMCIA slot by using a PC Card adapter.

- **CompactFlash:** CompactFlash employs a controller in each card that allows it to work with systems that have PCMCIA ATA-compatible slots. CompactFlash comes in a cartridge with a 50-pin connector, somewhat similar to a PCMCIA card. Cartridges are available from CompactFlash originator SanDisk Corporation in densities of 20MB, 15MB, 10MB, 4MB, and 2MB. The cartridges can interface to a PC Card slot using a PCMCIA Type II adapter card. CompactFlash was pioneered by SanDisk and is now supported by the CompactFlash Association, which has 61 member companies, including 3M Corporation, AMP Inc., Apple Computer Inc., Cirrus Logic Inc., Epson, LG Semicon, Motorola, NEC, Sanyo, and Sony. At the time this was written, three manufacturers had officially introduced cameras with CompactFlash technology since the second half of 1996: Kodak, with its DC25; Canon, with its PowerShot; and Samsung, with its SSC-401N. SanDisk says it now has as many as 12 other digital still camera design wins. Companies including Casio and Vivitar have indicated that they will use CompactFlash in future products.
- **Miniature Card:** Miniature Card, a removable card format originally devised by Intel Corporation, can communicate with systems that have host-based filing software, such as Flash Translation Layer (FTL). Miniature Card uses an elastomeric connector that Intel says is more rugged than other types of connectors. Among the advantages of Miniature Card is its use of NOR-type flash, which is the most readily available type of flash on the market today. The Miniature Card specification is managed by the Miniature Card Implementers Forum (MCIF), an industry association. MCIF members include Advanced Micro Devices Inc., Compaq Computer Corporation, Eastman Kodak, Fujitsu Ltd., Hewlett-Packard Company, Konica Corporation, Microsoft Corporation, Nokia Corporation, Olympus Optical Company Ltd., Philips Electronics, and Sony Corporation. At the time this was written, not one company had announced a Miniature Card digital still camera. However, Konica is expected to introduce an SSFDC digital still camera shortly.
- **The Solid-State Floppy Disk Card:** SSFDC employs a controller in each card that allows it to work with systems that have PCMCIA ATA-compatible slots. At less than 1mm in thickness, SSFDC is the thinnest of the three major card types. The packaging of SSFDC is similar to a chip card (also known as a smart card). Data is transferred on and off the card through contacts that are on the module on the surface of the card. SSFDC uses NAND-type flash, a type of flash memory made by Toshiba, Samsung, and National Semiconductor that can easily and

cost-effectively scale up to very high densities. To promote SSFDC as a worldwide standard, the SSFDC Forum has been founded, with membership consisting of 53 companies, including Eastman Kodak, Toshiba Corporation, Fuji Photo Film Co. Ltd., Lucent Technologies Inc., Olympus Optical Co. Ltd., Sanyo Electric Co. Ltd., Sega Enterprises Ltd., Sony Corporation, Olympus Optical Co. Ltd., and Tokyo Electron Ltd. At the time this was written, four companies had announced cameras that support SSFDC: Toshiba, with its PDR-2A; Fuji, with its DS-7; Minolta, with its Dimage V (in Japan) ; and Sega, with its Digio (in Japan). Minolta and Olympus are planning to release SSFDC digital still cameras in the United States, according to the SSFDC forum.

### **Dataquest Perspective**

Use of removable storage is increasing in the digital still camera market. Many new digital still camera models are making use of removable storage as their primary storage mechanism, eschewing built-in flash memory entirely. Removable storage allows the memory capacity of a digital still camera to be easily expanded to unlimited sizes. It also creates a form of digital "film" that can be dropped off at a development facility.

Each format has its advantages. With CompactFlash, the first of the formats to be readily available, SanDisk has managed to score many early design-wins. With an ATA controller built into each card, CompactFlash offers guaranteed compatibility with computers and makes it easier to use in designs. Miniature Card is backed by Intel and Advanced Micro Devices, which together with their partners, Sharp and Fujitsu, controlled 71 percent of the revenue in the flash market in 1996. The power these companies wield over flash pricing and technology development is a major consideration when companies decide which card format to use. SSFDC uses NAND flash, which is a more suitable technology for data storage than the NOR-type parts offered by other manufacturers. In addition, SSFDC-type cards are expected to be very inexpensive to produce.

Dataquest believes it is likely that one of the three formats described above will emerge as the dominant approach for digital still camera removable storage. Which format will prevail is a matter of much debate in the industry. It is far too early to pick a winner. Thus, many companies are hedging their bets by participating in more than one card effort. Olympus participates in both the SSFDC Forum and the MCIF. Sanyo belongs to both the SSFDC Forum and the CompactFlash Association. By late 1997 or early 1998, a clearer picture should emerge of who is the winner in the flash card battle.

## Chapter 5

# Digital Still Camera Semiconductor Components

## The Major Components

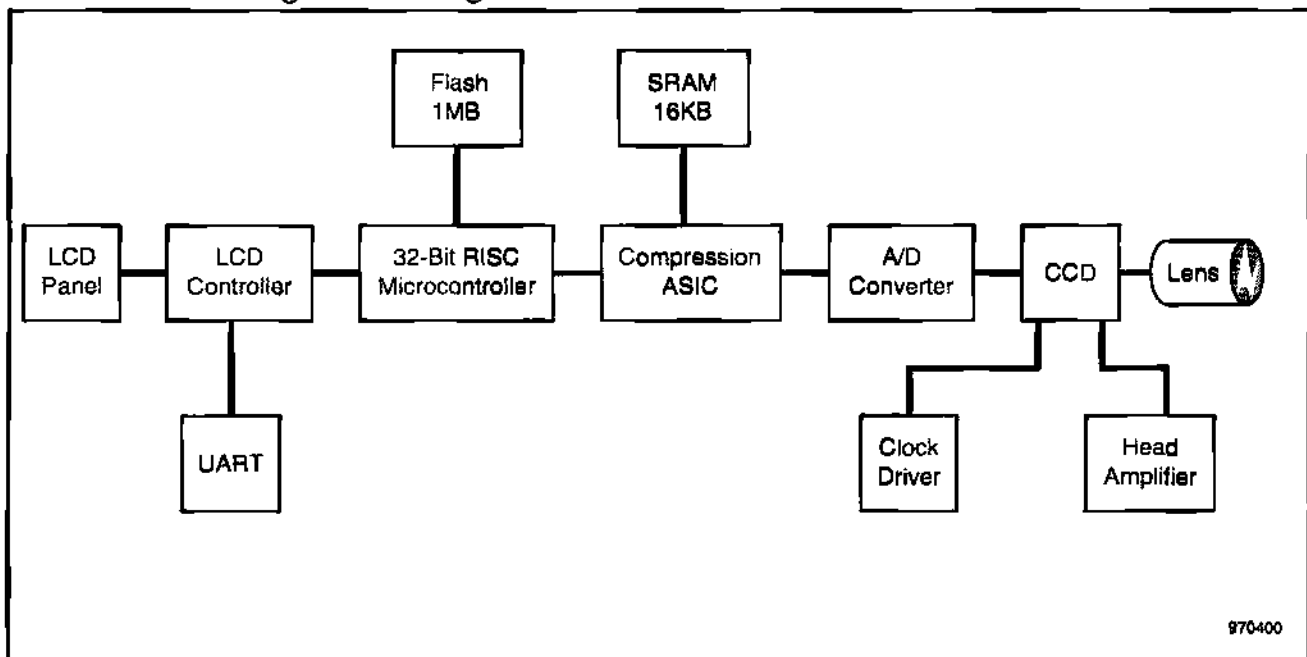
This section describes the major semiconductor components of a digital still camera. Figure 5-1 is a block diagram of a generic digital still camera.

### CCDs

The heart of digital still camera products and technology is the charge-coupled device. The CCD frequently is the most expensive single component in a digital still camera, with costs ranging from \$14 to \$45 in large volumes for parts used in consumer-priced products. CCDs used in consumer-class digital still cameras have resolutions ranging from 320 x 240 to 756 x 504. Professional-class digital still cameras use more expensive CCDs with resolutions as high as 3,060 x 2,036. For instance, the Kodak DCS460 is a professional-class camera costing nearly \$30,000 that uses an advanced CCD to achieve a resolution of 3,060 x 2,036, or 6.2 million pixels, which is equivalent to 35mm film quality.

Because they are intended to be used with PCs, digital still cameras frequently employ CCDs that support standard computer resolutions, such as 640 x 480. Some CCD makers see their product road map moving from VGA to SVGA to XGA resolutions over time.

Figure 5-1  
Generic Block Diagram of a Digital Still Camera



Source: Dataquest (January 1997)

Some cameras can use the same type of CCDs that are found in camcorders. However, camcorders typically use CCDs that perform interlaced scanning, which is the scanning technology used with television sets. In contrast, computers use progressive scanning. Thus, many newer digital still cameras make use of progressive scanning CCDs.

The resolution of CCDs is determined by the number of pixels they contain. The larger the CCD, the more pixels it has and the higher its resolution. For example, one 1/5-inch CCD has a 320 x 240 resolution, while a 1/3-inch CCD has a 640 x 480 resolution. Because of their larger size, higher-resolution CCDs yield at much lower rates than lower-resolution CCDs, causing their price to be considerably higher.

A large number of vendors produce CCDs for various applications, including National Semiconductor, Panasonic, Toshiba, and NEC. Dataquest teardowns of digital still camera products reveal the use of Sony, Sharp, Sanyo, and Kodak CCDs in several popular digital still camera models.

### **CCD Support Chips**

Around the CCD, several chips now are required for signal processing. Vendors of CCDs offer these functions in chipsets that consist of varying numbers of devices. Functions required around the CCD include a timing generator, a color separator, a synchronous signal generator and an analog-to-digital (A/D) converter. Frequently these functions are implemented in two or more chips, sometimes in standard products and other times in ASICs. Some makers of such devices believe most or all of those functions will be combined into a single device eventually, perhaps within the next few years.

The supplier of the CCD typically also offers the required support chips. Prices for the support chips vary, depending on the vendor and quantity. However, the total cost typically is less than \$10 in large volumes.

### **Digital Processing ASICs**

The digital processing portion of digital still cameras frequently is performed by an ASIC. Functions such as image compression take place here (usually with the assistance of the system's microcontroller), as well as other image processing functions and interface control.

In teardowns of digital still cameras conducted by Dataquest, ASICs with the company markings of Chinon, Hitachi, and Sanyo appeared. These ASICs had pin counts ranging from 100 to 160 pins. Dataquest estimates the cost of these ASICs to range from \$6.50 to \$15.25.

### **Microcontrollers**

Because they are called on to assist in image compression and processing, powerful 32-bit microcontrollers often are used in digital still camera designs. Microcontrollers used in these systems include the SPARClite from Fujitsu and the SH-1 from Hitachi. In addition to compression, these microprocessors perform system control, memory control, power management, and some display control. For the types of 32-bit microcontrollers used in digital still cameras, prices can be as high as \$31 in high volume.

## Memory

The digital processing ASIC usually is associated with some RAM, which it uses for buffering during the image-compression process. Densities for this memory can range from 64Kb to 4Mb. Many different types of memory are used, mainly varieties that can achieve a high read and write speed. Examples of this type of memory include static RAM (SRAM), pseudo-SRAM (PSRAM), and even video RAM (VRAM). More RAM is associated with the microcontroller, frequently SRAM used to cache data.

To store compressed images, the microprocessor uses flash memory. Densities in digital still cameras range from 1MB for the lowest-cost cameras to 4MB or more for higher-end cameras. Both Intel/Advanced Micro Devices NOR-type flash and Toshiba/Samsung NAND-type flash are used in these systems.

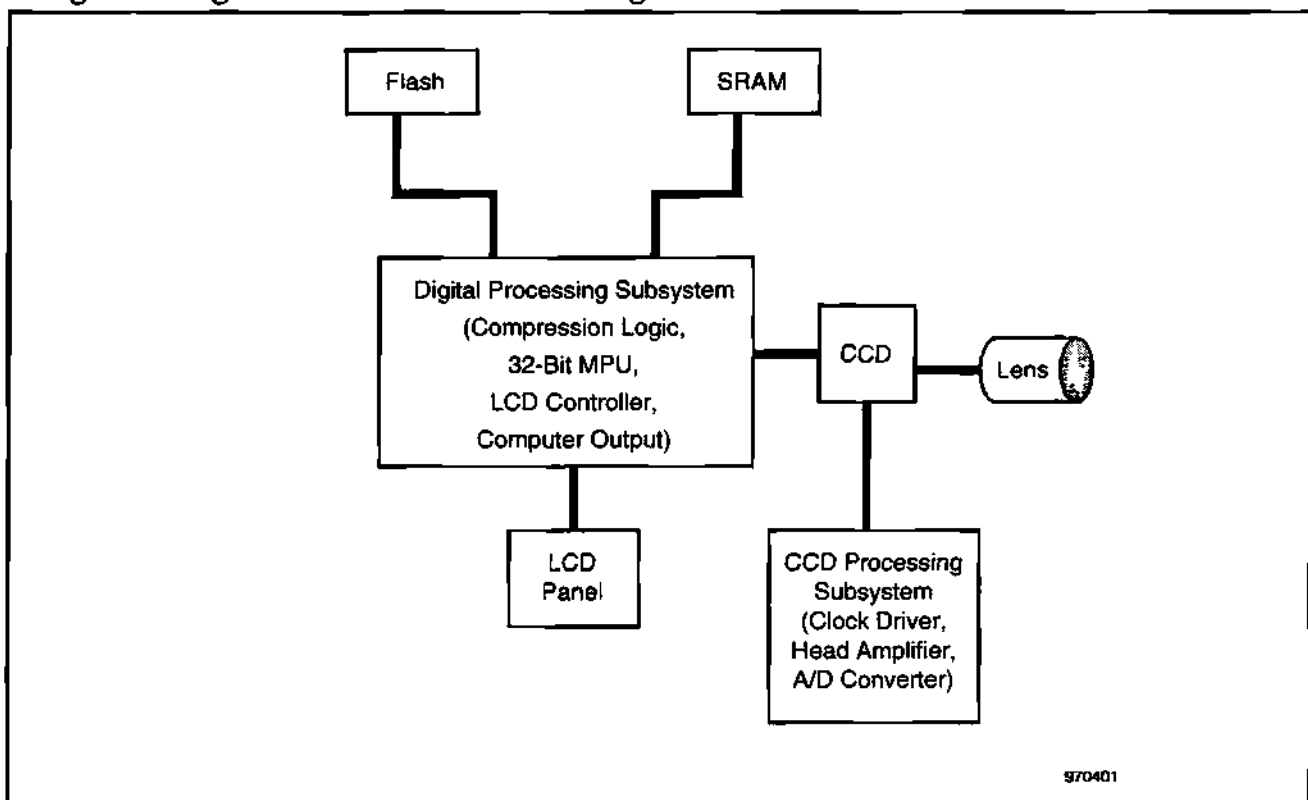
## Other Components

Other subsystems found in digital still cameras include display control, usually using a 4-bit LCD controller and computer output, using a universal asynchronous receiver/transmitter (UART).

## Directions for Digital Still Camera Semiconductor Integration

Figure 5-2 shows an advanced, more integrated design for a digital still camera. In this design, the CCD remains a standalone part, reflecting difficulty in integrating CCDs with other functions. The CCD processing subsystem has been integrated into a single device, simplifying digital still

**Figure 5-2**  
**Integrated Digital Still Camera Block Diagram**



Source: Dataquest (January 1997)



camera design and manufacturing. The system's microcontroller has been combined with the LCD controller, the computer output subsystem, the decompression ASIC, and the other digital processing logic to form a single chip. The whole system would use as few as five major chips, compared to 12 or more for some of today's digital still cameras.

## Analysis

Today's digital still cameras make use of a mixture of ASICs and standard parts. Although application-specific standard products (ASSPs) are expected to emerge for digital still cameras, many manufacturers are likely to continue to use ASICs to provide differentiation. Also, because the basic functions and algorithms of most digital still cameras are not standard, there is not a requirement for parts that comply with specifications that can be used by all manufacturers. Thus, digital still camera makers are likely to continue to use primarily ASICs and standard parts for the next several years.

A major challenge for the digital still camera market will be the cost and integration of CCDs. Prices for digital still camera CCDs are expected to remain high over the next few years for several reasons. First, there are few CCD makers that focus on digital still cameras, making it something of a seller's market. Second, CCDs use a manufacturing process that is somewhat more complicated than standard CMOS. Third, CCDs are still a small-volume market, ruling out price decreases because of economy of scale. Fourth, it is difficult to integrate CCDs with other logic, preventing cost reduction through integration.

As volumes increase for digital still cameras, the number of suppliers focusing on this area should grow, increasing competitive pressure. Furthermore, as other markets requiring similar CCDs grow—such as videoconferencing cameras—economies of scale should help reduce CCD pricing. Finally, new technologies may emerge that allow the light-sensing capabilities of CCDs to be integrated with other functions. Mountain View, California-based start-up Suni Imaging Microsystems recently announced a new CCD manufacturing process that will allow the integration of CCDs with required support chips. All these trends will allow the emergence of high-resolution CCDs with lower costs over the next few years.

CMOS sensors offer an alternative method of image capture to CCDs. These devices are built using standard CMOS processes, allowing them to be produced at a much lower cost than CCDs. Because of this, affordable CMOS sensors can be produced that have higher resolution than CCDs. CMOS sensors also can be more easily integrated with other circuits and require fewer support functions than CCDs. Thus, CMOS sensors will allow the construction of single-chip cameras that will reduce the cost of digital still cameras. Because of these factors, proponents of CMOS sensors believe they will make CCD technology obsolete within a few years. Cameras with CMOS sensor technology have only just begun to enter the market. Among them are SoundVision Inc.'s digital still camera, a product priced at about \$300 with a 800 x 1000 resolution. Toshiba is offering the PDR-2A camera, with a price tag of less than \$500 and a resolution of 640 x 480. Producers of CMOS sensors include Toshiba, which is supplying the

part for its PDR-2A, and VLSI Vision Ltd., which provides the part for the Sound Vision camera.

Over time, the microcontroller in the digital still camera should play an increasingly important role. As more and more affordable digital still cameras adopt the JPEG compression algorithm, more processing power will be required. Thus, many digital still camera makers will seek powerful 32- and 64-bit microcontrollers (and microprocessors) that are capable of handling the demands of JPEG. In addition to raw MIPS, digital still camera makers will be seeking microcontrollers that are capable of performing the digital signal processing functions required in image compression.

The result of this trend could be the integration of the microcontroller and the digital processing ASIC in digital still camera designs. As the microcontroller takes over more functions in the digital still camera, more peripherals will be required, including UARTs and LCD controllers.

An opportunity exists in digital still cameras for the use of embedded memory. Image compression requires frequent and speedy memory accesses. To address this requirement, digital still camera makers have employed some fairly exotic memory types, including PSRAM and VRAM. However, with embedded memory, a wide on-chip memory bus could be employed that allows DRAM to be accessed at extremely high speeds. The use of embedded DRAM could not only reduce costs but also save space and cut power usage in digital still camera designs.

## Inside Digital Still Cameras

This section gives descriptions of digital still cameras that have been disassembled and studied by Dataquest. Figures 5-3 and 5-4 show block diagrams.

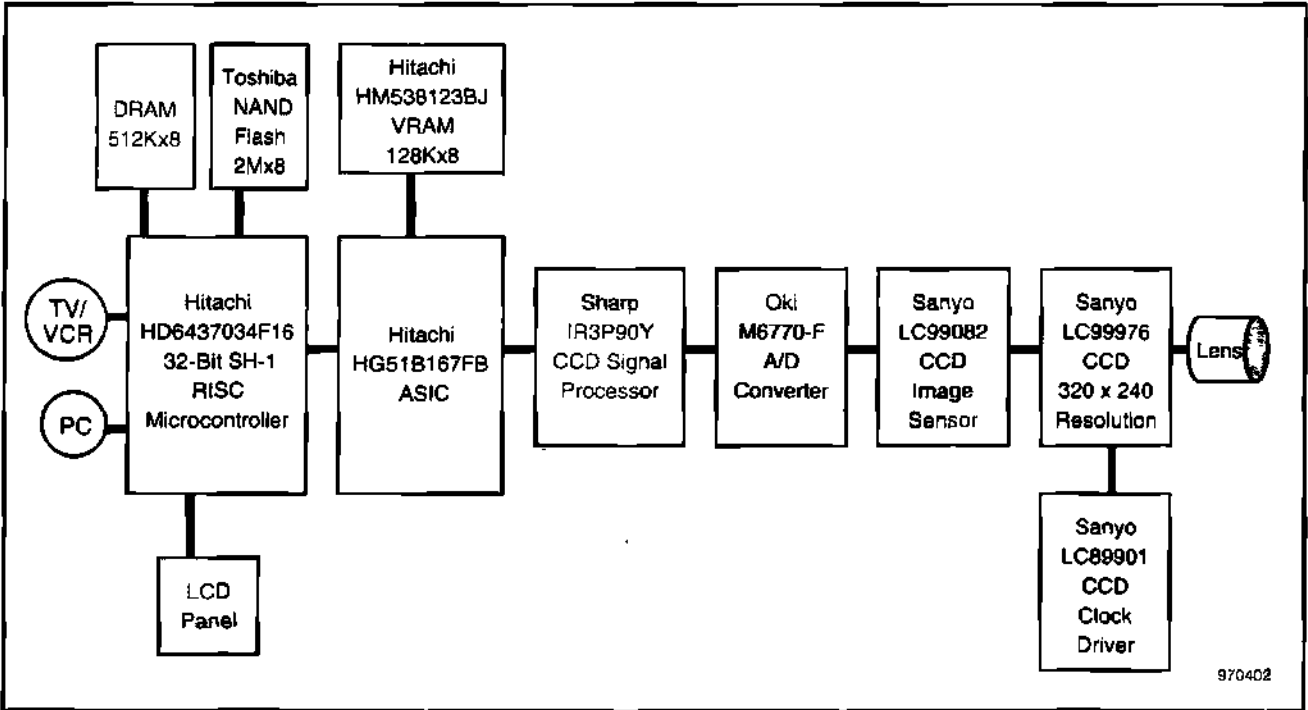
### Casio QV-10A Plus

The Casio QV-10A Plus is part of the Casio QV-10 product family, which is considered the most popular line of digital still cameras on the market today. The QV-10A Plus is one of the lowest-resolution digital still cameras available. However, it is popular because of its LCD viewfinder and picture viewer and its clever, compact design. The CCD is mounted on a swiveling portion of the camera, allowing users to change the camera angle without moving the main body of the product. This allows easier viewing of the LCD panel while pictures are taken. The QV-10A Plus also allows users to view pictures after they are taken and to choose whether to keep or to delete them. The camera supports picture export to computers as well as to television sets and other pieces of consumer video equipment. The camera spreads its electronics over four small boards that conserve space. As shown in Figure 5-3, the camera uses a Sony CCD with a Hitachi-manufactured ASIC and a Hitachi 32-bit SH-1 RISC microcontroller.

### Kodak DC20

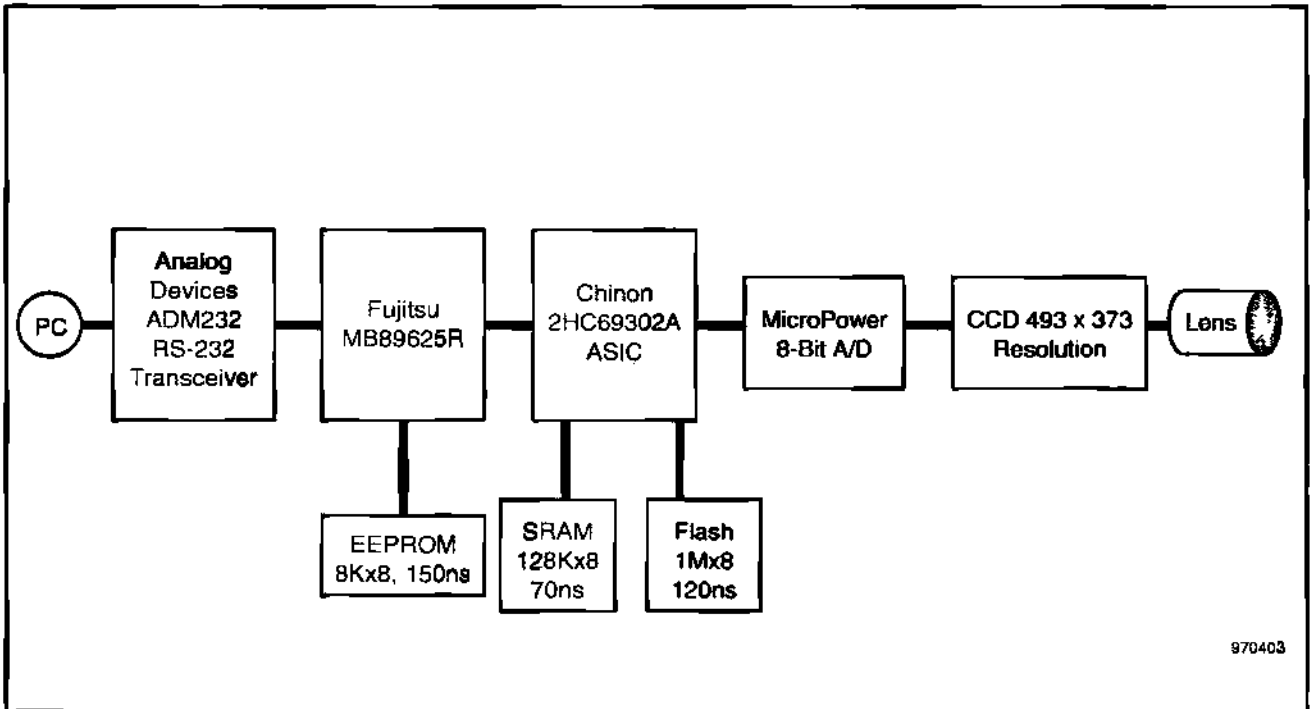
At about \$199 retail, the Kodak DC20 is among the lowest-priced digital still cameras on the market today. With dimensions of 2.5 inches tall by 4 inches wide and 1.2 inches deep, it also is one of the smallest. Kodak has attained such a low price point largely by omitting features found on some

**Figure 5-3**  
**Block Diagram of Casio QV-10A Plus**



Source: Dataquest (January 1997)

**Figure 5-4**  
**Block Diagram of Kodak DC20**



Source: Dataquest (January 1997)

more expensive digital still cameras, such as a removable flash memory storage module and an LCD screen. Instead of using removable storage, the DC20 is designed to output photographs to personal computers via bundled cabling, restricting the camera's target market to current PC owners. Unlike some other digital still cameras that can connect to only one type of personal computer, the DC20 comes with cabling that allows it to interface to both Macintosh and Windows-type PCs. Kodak provides free access to host system software on its World Wide Web site. Rather than using an LCD screen that allows users to review their pictures after they are taken, the DC20 has a simple visual viewfinder. As shown in Figure 5-4, the DC20 makes use of a Chinon ASIC for compression.

## Digital Still Camera Makers

A large number of companies have entered the digital still camera market in the past two years, which have vastly varying levels of experience in the market for photography products. Players range from film veterans like Kodak and Fuji, to camera powerhouses like Ricoh and Canon, to consumer electronics firms with no film camera background like Casio, to PC and PC peripherals makers like Apple and Epson.

Table 5-1 is a listing of some major digital still camera suppliers and their products. Because of the large number of entrants—a number that grows nearly every week—this table could not possibly list all companies and all cameras. Prices are based on data collected from the companies as well as press reports and advertisements.

Digital still cameras frequently support multiple resolutions. Memory capacity varies with resolution. Resolution and memory capacities listed in the table are the maximum possible with each camera. At the maximum resolution, a given camera may not be capable of storing the maximum number of images.

## Dataquest Perspective

The digital still camera market is not likely to become the consumer bonanza that many manufacturers anticipate before the end of the century. Primary usage of digital still cameras will be as a computer peripheral for the next three years at least. Despite that, Dataquest believes that the digital still camera market does offer significant opportunity for semiconductor makers. Digital still cameras expand the semiconductor market by inserting chip technology into a place where it has never been before. Furthermore, digital still cameras still may grow to become a high-volume consumer market in the twenty-first century, after advances in CCD and CMOS sensor technology bring high-quality products into an affordable price range. Semiconductor manufacturers can help to grow the digital still camera market by offering lower-cost components and cheaper CCDs and CMOS sensors that have higher resolutions.

Because of their digital nature and large semiconductor content, digital still cameras will settle into a price dynamic similar to that found in the PC market, with features steadily improving at fixed price points. This will result in declines in digital still camera ASPs and eventually a flattening of growth in the digital still camera semiconductor market.

**Table 5-1**  
**Major Digital Still Camera Suppliers and Products**

Manufacturer	Product	Type	Price (\$)	Resolution	Memory (MB)	Memory Capacity (Number of Photos)	Memory Expansion Format
Apple	QuickTake 150	CCD	749.00	640 x 480	-	32	-
Canon	PowerShot 600	CCD	949.00	832 x 608	1	18	CompactFlash
Casio	QV-30	CCD	699.00	320 x 240	2	96	-
Casio	QV-10	CCD	499.00	320 x 240	2	96	-
Casio	QV-10A Plus	CCD	699.00	320 x 240	2	96	-
Casio	QV-100	CCD	650.00	640 x 480	4	100	PCMCIA
Casio	QV-300	CCD	700.00	640 x 480	NA	192	-
Chinon	ES-3000	NA	999.00	640 x 480	NA	48	PCMCIA
Chinon	ES-1000	NA	499.00	NA	NA	NA	-
Dycam	10-C	CCD	995.00	640 x 480	1	40	PCMCIA
Dycam	Model 3	CCD	695.00	496 x 365	1	56	-
Dycam	Model 4	CCD	795.00	496 x 365	1	24	-
Epson	PhotoPC	CCD	500.00	640 x 480	1	32	Epson SIMM Module
Epson	PhotoPC 500	CCD	499.00	640 x 480	NA	60	Epson SIMM Module
Fuji	DS-505	CCD	12,780.00	1280 x 1000	NA	-	PCMCIA
Fuji	DS-515	CCD	16,020.00	1280 x 1000	NA	-	PCMCIA
Fuji	DS-220	CCD	1,200.00	640 x 480	NA	48	PCMCIA
Fuji	DS-7	CCD	NA	640 x 480	NA	-	SSFDC
Kodak	DC50	CCD	979.00	756 x 504	1	48	-
Kodak	DC40	CCD	767.00	756 x 504	4	48	-
Kodak	DC20	CCD	199.00	493 x 373	1	16	-
Kodak	DC25	CCD	499.00	493 x 373	2	29	CompactFlash
Kodak	DCS410	CCD	7,000.00	1012 x 1524	NA	-	PCMCIA

**Table 5-1 (Continued)**  
**Major Digital Still Camera Suppliers and Products**

Manufacturer	Product	Type	Price (\$)	Resolution	Memory (MB)	Memory Capacity (Number of Photos)	Memory Expansion Format
Kodak	DCS420	CCD	10,995.00	1524 x 1024	NA	-	PCMCIA
Kodak	DCS460	CCD	27,995.00	3060 x 2036	NA	NA	-
Kodak	EOS DCS1	CCD	NA	3060 x 2036	NA	-	PCMCIA
Kodak	EOS DCS460	CCD	NA	3060 x 2036	NA	-	PCMCIA
Kodak	EOS DCS3	CCD	NA	1268 x 1012	NA	-	PCMCIA
Kodak	EOS DCS5	CCD	11,995.00	1524 x 1012	NA	-	PCMCIA
Konica	Q-EZ	CCD	NA	640 x 480	NA	-	Miniature Card
Minolta	Dimage V	CCD	NA	640 x 480	NA	NA	SSFDC
Nikon	E2	CCD	12,780.00	1280 x 1,000	NA	-	PCMCIA
Nikon	E2s	CCD	16,020.00	1280 x 1000	NA	-	PCMCIA
Nikon	COOLPIX 100	CCD	NA	512 x 480	NA	42	PCMCIA
Nikon	COOLPIX 300	CCD	NA	640 x 480	NA	141	PCMCIA
Obsidian Imaging Inc.	EPixPro	CCD	1,950.00	768 x 494	-	-	PCMCIA
Olympus	Camedia	CCD	NA	1024 x 768	1	120	-
Olympus	D-200L	CCD	600.00	640 x 480	2	80	-
Olympus	D-300L	CCD	899.00	1024 x 768	6	120	-
Polaroid Corp.	PDC-2000/T	CCD	2,995.00	1600 x 1200	NA	NA	-
Polaroid Corp.	PDC-2000/40	CCD	3,695.00	1600 x 1200	40 hard drive	40	-
Polaroid Corp.	PDC-2000/60	CCD	4,995.00	1600 x 1200	60	60	-
Ricoh	RDC-2	CCD	Under 1,000.00	768 x 576	2	38	PCMCIA

**Table 5-1 (Continued)**  
**Major Digital Still Camera Suppliers and Products**

Manufacturer	Product	Type	Price (\$)	Resolution	Memory (MB)	Memory Capacity (Number of Photos)	Memory Expansion Format
Ricoh	RDC-1	CCD	1,800.00	768 x 576	NA	492	PCMCIA
Samsung	SSC-401N	CCD	NA	768 x 494	4	120	CompactFlash
Sega	Digio	CCD	NA	NA	NA	NA	SSFDC
Sharp	VE-LS5	CCD	1,100.00	720 x 480	4	120	-
Sony	Cyber-Shot	CCD	800.00	NA	4	NA	-
Sony	DKC-ID1	CCD	1,795.00	768 x 576	NA	-	PCMCIA
Sony	DSC-F1	CCD	849.99	640 x 480	4	108	-
Sound Vision	Sound Vision Digital Still Camera	CMOS Sensor	300.00	800 x 1000	0.5	-	PCMCIA
Toshiba	PDR-2A	CMOS Sensor	499.00	640 x 480	NA	-	SSFDC with built-in PCMCIA Card
Vivitar	ViviCam 2000	CCD	299.95	640 x 480 (with interpolation)	NA	21	NA

NA = Not available

Source: Dataquest (January 1997)

---

**For More Information...**

Jonathan Cassell, Industry Analyst ..... (408) 468-8195  
Internet address ..... [jcassell@dataquest.com](mailto:jcassell@dataquest.com)  
Via fax ..... (408) 954-1780

---

The content of this report represents our interpretation and analysis of information generally available to the public or released by responsible individuals in the subject companies, but is not guaranteed as to accuracy or completeness.

It does not contain material provided to us in confidence by our clients. Reproduction or disclosure in whole or in part to other parties shall be made upon the written and express consent of Dataquest.

©1997 Dataquest—Reproduction Prohibited

Dataquest is a registered trademark of A.C. Nielsen Company



## **DATAQUEST WORLDWIDE OFFICES**

### **NORTH AMERICA**

#### **Worldwide Headquarters**

251 River Oaks Parkway  
San Jose, California 95134-1913  
United States  
Phone: 1-408-468-8000  
Facsimile: 1-408-954-1780

#### **East Coast Headquarters**

Nine Technology Drive  
P.O. Box 5093  
Westborough, Massachusetts 01581-5093  
United States  
Phone: 1-508-871-5555  
Facsimile: 1-508-871-6262

#### **Dataquest Global Events**

3990 Westerly Place, Suite 100  
Newport Beach, California 92660  
United States  
Phone: 1-714-476-9117  
Facsimile: 1-714-476-9969

#### **Sales Offices:**

Washington, DC (Federal)  
New York, NY (Financial)  
Dallas, TX

### **LATIN AMERICA**

Research Affiliates and Sales Offices:  
Buenos Aires, Argentina  
Sao Paulo, Brazil  
Santiago, Chile  
Mexico City, Mexico

### **EUROPE**

#### **European Headquarters**

Tamesis, The Glanty  
Egham, Surrey TW20 9AW  
United Kingdom  
Phone: +44 1784 431 611  
Facsimile: +44 1784 488 980

#### **Dataquest France**

Immeuble Défense Bergères  
345, avenue Georges Clémenceau  
TSA 40002  
92882 - Nanterre CTC Cedex 9  
France  
Phone: +33 1 41 35 13 00  
Facsimile: +33 1 41 35 13 13

#### **Dataquest Germany**

Kronstadter Strasse 9  
81677 München  
Germany  
Phone: +49 89 93 09 09 0  
Facsimile: +49 89 93 03 27 7

#### **Sales Offices:**

Brussels, Belgium  
Kfar Saba, Israel  
Milan, Italy  
Randburg, South Africa  
Madrid, Spain

### **JAPAN**

#### **Japan Headquarters**

Aobadai Hills 4-7-7  
Aobadai  
Meguro-ku, Tokyo 153  
Japan  
Phone: 81-3-3481-3670  
Facsimile: 81-3-3481-3644

### **ASIA/PACIFIC**

#### **Asia/Pacific Headquarters**

Suite 5904-7, Central Plaza  
18 Harbour Road, Wanchai  
Hong Kong  
Phone: 852-2824-6168  
Facsimile: 852-2824-6138

#### **Dataquest Korea**

Suite 2407, Trade Tower  
159 Samsung-dong, Kangnam-gu  
Seoul 135-729  
Korea  
Phone: 822-551-1331  
Facsimile: 822-551-1330

#### **Dataquest Taiwan**

11F-2, No. 188, Section 5  
Nan King East Road  
Taipei  
Taiwan, R.O.C.  
Phone: 8862-756-0389  
Facsimile: 8862-756-2663

#### **Dataquest Singapore**

105 Cecil Street  
#06-01/02 The Octagon  
Singapore 069534  
Phone: 65-227-1213  
Facsimile: 65-227-4607

#### **Dataquest Thailand**

12/F, Vanissa Building  
29 Soi Chidlom  
Ploenchit Road  
Patumwan, Bangkok 10330  
Thailand  
Phone: 662-655-0577  
Facsimile: 662-655-0576

#### **Research Affiliates and Sales Offices:**

Melbourne, Australia  
Beijing, China

# **Dataquest**

A Gartner Group Company

©1997 Dataquest